

SPARK

User Manual V1.0

2017.05

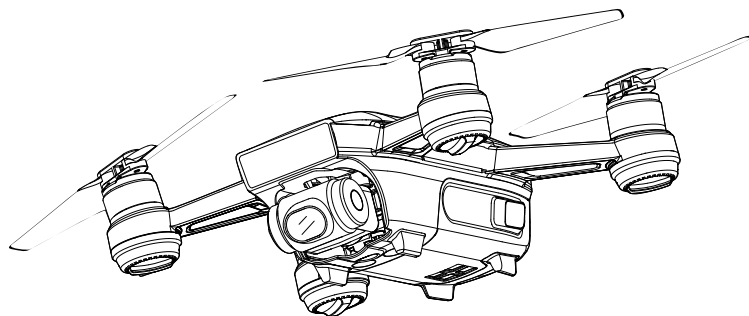

Searching for Keywords

Search for keywords such as "battery" and "install" to find a topic. If you are using Adobe Acrobat Reader to read this document, press Ctrl+F on Windows or Command+F on Mac to begin a search.

Navigating to a Topic

View a complete list of topics in the table of contents. Click on a topic to navigate to that section.

Printing this Document

This document supports high resolution printing.

Using this Manual

Legends

 Warning

 Important

 Hints and Tips

 Reference

Read Before the First Flight

Read the following documents before using the SPARK™:

1. *Spark in the Box*
2. *Spark User Manual*
3. *Spark Quick Start Guide*
4. *Spark Disclaimer and Safety Guidelines*
5. *Spark Intelligent Flight Battery Safety Guidelines*

We recommend that you watch all tutorial videos on the official DJI™ website and read the Disclaimer before you fly. Prepare for your first flight by reviewing the Spark Quick Start Guide and refer to the User Manual for more details.

Video Tutorials

Go to the address below or scan the QR code on the right to watch the Spark tutorial videos, which demonstrate how to use Spark safely:

<http://www.dji.com/spark/info#video>



Download the DJI GO 4 App

Be sure to use the DJI GO™ 4 app during flight. Scan the QR code on the right to download the latest version.

The Android version of the DJI GO 4 is compatible with Android v4.4 or later.

The iOS version of the DJI GO 4 is compatible with iOS v9.0 or later.



Download DJI Assistant 2

Download DJI Assistant 2 at <http://www.dji.com/spark/download>

Contents

Using this Manual	2
Legends	2
Read Before the First Flight	2
Video Tutorials	2
Download the DJI GO 4 App	2
Download DJI Assistant 2	2
Product Profile	6
Introduction	6
Features Highlights	6
Aircraft Diagram	7
Activation	7
Aircraft	9
Flight Modes	9
Aircraft Status Indicators	10
3D Sensing and Vision System	11
Return-to-Home (RTH)	13
Intelligent Flight Modes	16
Gesture Mode	23
Flight Recorder	26
Attaching and Detaching the Propellers	26
Intelligent Flight Battery	27
Gimbal and Camera	30
Controlling the Aircraft with a Mobile Device	31
Remote Controller (Optional)	36
Remote Controller Profile	36
Using the Remote Controller	37
Linking the Remote Controller	38
DJI GO 4 App	41
Equipment	41
Editor	44
SkyPixel	44
Me	44

Flight	46
Flight Environment Requirements	46
Flight Limits and No-Fly Zones	46
Preflight Checklist	47
Auto Takeoff and Auto Landing	48
Starting/Stopping the Motors (When Using Remote Controller)	48
Flight Test	49
Calibrating the Compass	49
Firmware Updates	50
Appendix	53
Specifications	53
After-Sales Information	55

Product Profile

This section introduces the DJI Spark and lists the components of the aircraft and remote controller.

Product Profile

Introduction

The DJI Spark is DJI's smallest flying camera featuring a stabilized camera, Intelligent Flight Modes, and Obstacle Avoidance inside a light, portable body. Equipped with a Vision System and 3D Sensing System, Spark can film 1080p videos, capture 12-megapixel photos, QuickShot Mode and Gesture Control. With a maximum flight speed* of 31 mph (50 kph), and a maximum flight time of 16 minutes**, Spark is quick and fun, making drone photography exciting and simple.

Features Highlights

Spark supports mobile device control and gesture control, making flying easier than ever. For users looking for more control options, an optional remote controller delivers maximum flight capabilities.

Camera and Gimbal: With the Spark, you are able to shoot 1080p video at 30 frames per second and capturing 12 megapixel photos that look crisper and cleaner, all stabilized by the compact onboard gimbal.

Flight Controller: The next-generation flight controller has been updated to provide a safer, more reliable flight experience. The aircraft is able to automatically return to its home point when transmission signal is lost or battery level is low. Apart from being able to hover indoors at low altitudes, the aircraft is also able to sense and avoid obstacles on its route, enhancing safety.

* Maximum flight speed requires operating Spark with a Spark remote controller.

** Maximum flight time was tested in windless conditions flying at a consistent 12.4 mph (20 kph). This value should be taken for reference only.

Aircraft Diagram

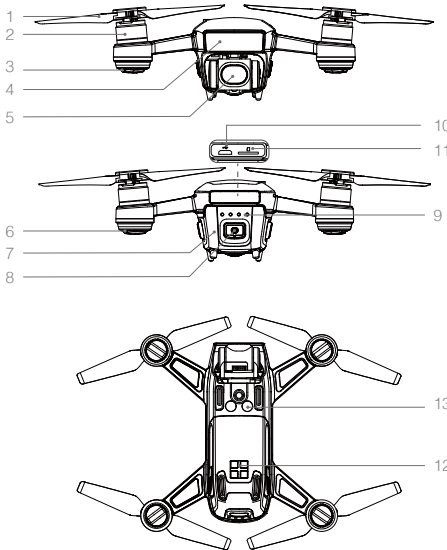

1. Propellers
2. Motors
3. Front LEDs
4. 3D Sensing System
5. Gimbal and Camera
6. Aircraft Status Indicators
7. Intelligent Flight Battery
8. Power Button
9. Battery Level Indicators
10. Micro USB Port
11. Micro SD Card Slot
12. External Charging Contact
13. Vision System

Activation

Activation is required before using the Intelligent Flight Battery and aircraft for the first time.

Activate the Intelligent Flight Battery

All batteries are in Hibernation Mode before shipment to ensure safety. Use the provided USB charger to charge and activate the battery for the first time. It is recommended to fully charge the battery before each flight.

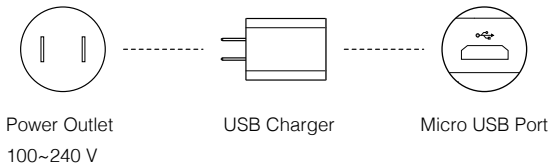

Activate the Aircraft

Launch DJI GO 4, tap the icon in the upper right corner, scan the QR Code on the storage box or in the battery compartment, and follow the prompt for activation.



Internet

Use your DJI account to activate the aircraft. Activation requires an internet connection.

Aircraft

This section introduces the Flight Controller, 3D Sensing System, Vision System, and the Intelligent Flight Battery.

Aircraft

Spark contains a flight controller, video downlink system, 3D Sensing System, Gimbal and Camera, propulsion system, and an Intelligent Flight Battery. This section introduces the features of the flight controller, video downlink system, and other aircraft components.

Flight Modes

The following flight modes are available for Spark:

P Mode (Positioning): P Mode works best when the GPS signal is strong. The aircraft utilizes the GPS and Vision System to locate itself, automatically stabilize, and navigate between obstacles. Intelligent Flight Modes such as QuickShot, TapFly and ActiveTrack are enabled in this mode.

When forward obstacle sensing is enabled and lighting conditions are sufficient, the maximum flight attitude angle is 15° with a maximum flight speed of 6.7 mph (10.8 kph). When forward obstacle sensing is disabled, the maximum flight attitude angle is 15° and the maximum flight speed is 13.4 mph (21.6 kph).

The aircraft will automatically switch to ATTI mode when the GPS signal is weak and lighting conditions are too dark for the Vision System, it will not be able to automatically avoid obstacles and only use its barometer for positioning to control altitude. Intelligent Flight Modes are not available in ATTI mode.

Note: P Mode requires larger stick movements to achieve high speeds.

S Mode (Sport): The aircraft uses GPS for positioning. As forward obstacle sensing is disabled, the aircraft will not be able to sense and avoid obstacles when in Sport Mode. Intelligent Flight Modes, Pano Mode and ShallowFocus are not available in Sport Mode.

Note: Aircraft responses are optimized for agility and speed making it more responsive to stick movements.



- The 3D Sensing System is disabled in S Mode (Sport), which means the aircraft will not be able to automatically avoid obstacles on its route.
- The aircraft's maximum speed and braking distance are significantly increased in S Mode (Sport). A minimum braking distance of 30 meters is required in windless conditions.
- Descending speed is significantly increased in S Mode.
- The aircraft's responsiveness is significantly increased in S Mode (Sport), which means small stick movements on the remote controller will translate into a large travel distance of the aircraft. Be vigilant and maintain adequate maneuvering space during flight.



- S Mode is only available with a Spark remote controller. S Mode is disabled when flying with a mobile device.
 - Use the Flight Mode switch on the remote controller to select aircraft flight modes.
-

Aircraft Status Indicators

Spark has Front LEDs and Aircraft Status Indicators. The positions of these LEDs are shown in the figure below:

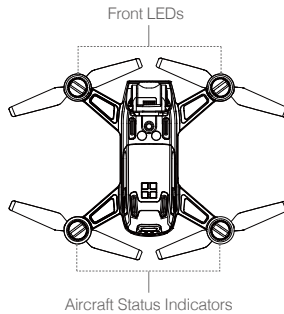

The Front LEDs show the orientation of the aircraft and the status of some functions (please refer to the Gesture Mode "Feature Descriptions" section for more details). The Front LEDs glow solid red when the aircraft is turned on to indicate the front or nose of the aircraft. The Aircraft Status Indicators communicate the system status of the flight controller. Refer to the table below for more information about the Aircraft Status Indicators.

Aircraft Status Indicator Description

Normal	
.....	Alternating red, green and yellow flashes Turning On and Self Diagnostic Testing
.....	Alternate yellow and green flashing Warming Up
.....	Slow green flashing P Mode with GPS
.....	Two green flashes P Mode with Vision System
.....	Slow yellow flashing No GPS and Vision System
.....	Fast green flashing Braking
Warning	
.....	Fast yellow flashing Remote Controller Signal Lost
.....	Slow red flashing Low Battery Warning
.....	Fast red flashing Critical Low Battery Warning
.....	Red flashing IMU Error
.....	Solid Red Critical Error
.....	Fast alternating red and yellow flashing Compass Calibration Required

3D Sensing and Vision System

Spark is equipped with a 3D Sensing System 1, consisting of a 3D infrared module at the front of the aircraft, which scan for obstacles during flight.

The main components of the Vision System are located on the underside of the aircraft body. This includes a camera 2 and a 3D infrared module 3. The Vision System uses 3D infrared module and image data to help the aircraft maintain its current position, enabling precision hovering indoors or in environments where GPS signal is not available.

The 3D Sensing System constantly scan for obstacles, allowing Spark to avoid obstacles when lighting is sufficient.

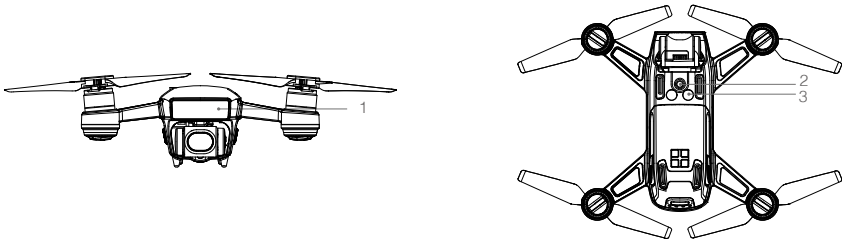

Detection Range

The detection range of the 3D Sensing System is depicted below. Note that the aircraft cannot sense or avoid obstacles that are not within the detection range.

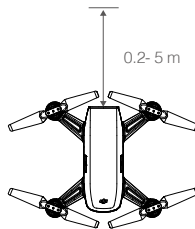

Using the Vision System

The Vision System is activated automatically when the aircraft is turned on. No further action is required. The Vision System can be used in indoor environments where GPS is unavailable. Using the Vision System, the aircraft can hover precisely, even without GPS.

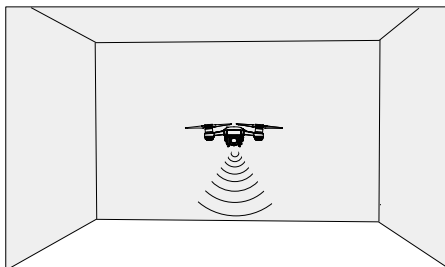

Follow the steps below to use the Vision System:

1. Ensure the aircraft is in P Mode and place the aircraft on a flat surface. Note that the Vision System cannot work properly on surfaces without clear pattern variations.
2. Turn on the aircraft. The aircraft will hover in place after takeoff. The aircraft status indicators will flash green twice, which indicates the Vision System is working.

Powered by the 3D Sensing System, the aircraft is able to actively brake when obstacles are detected in front. The 3D Sensing System works best when lighting is adequate and the obstacle is clearly marked or textured. The aircraft must fly at no more than 6.7 mph (10.8 kph) to allow for sufficient braking distance.

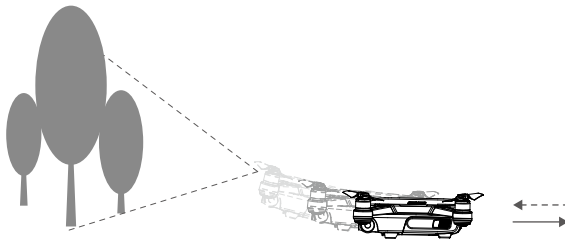



⚠ 3D Sensing and Vision System performance are affected by the type of surface being flown over. The aircraft will switch from P Mode to ATTI Mode automatically if neither GPS or Vision System are available. Please be vigilant when operating Spark in the following situations:

- Flying at high speeds below 0.5 meters.
- Flying over monochrome surfaces (e.g., solid black, solid white, solid red, or solid green).
- Flying over highly reflective surfaces.
- Flying over water or transparent surfaces.
- Flying over moving surfaces or objects.
- Flying in an area where the lighting changes frequently or drastically.
- Flying over extremely dark (lux < 10) or bright (lux > 100,000) surfaces.
- Flying over surfaces without clear patterns or texture.
- Flying over surfaces with identical repeating patterns or textures (e.g., tiling).
- Flying over small and fine objects (e.g. tree branches and power lines).
- Flying at speeds of over 6.7 mph (10.8 kph) at 2 meters above the ground.

☀ • Keep sensors clean at all times. Dirt or other debris may adversely affect their effectiveness.

Return-to-Home (RTH)

The Return to Home (RTH) function brings the aircraft back to the last recorded Home Point. There are three types of RTH: Smart RTH, Low-Battery RTH, and Failsafe RTH. This following section describes the three RTH scenarios in detail.

☰	GPS	Description
Home Point		If a strong GPS signal was acquired before takeoff, the Home Point is the location from which the aircraft launched. The GPS signal strength is indicated by the GPS icon (). The aircraft status indicator will blink rapidly when the home point is recorded.

Smart RTH

Initiate Smart RTH when GPS is available. Tap the RTH button in DJI GO 4 and follow the onscreen instructions. The user can also immediately exit Smart RTH by pressing the Stop icon  in DJI GO 4. Pressing and holding the RTH button on the remote controller can also initiate Smart RTH. Press it again to exit.

Low-Battery RTH

Low-Battery RTH is triggered when the DJI Intelligent Flight Battery is depleted to a point that may affect the safe return of the aircraft. Users are advised to return home or land the aircraft immediately when prompted. DJI GO 4 will display a notice when a low-battery warning is triggered. If no action is taken after the 10-second warning, the aircraft will automatically return to the Home Point. The user can cancel the RTH procedure by pressing the RTH button or Flight Pause button on the remote controller. The thresholds for these warnings are automatically determined based on the aircraft's current altitude and distance from the Home Point. Low-Battery RTH will only appear one time during flight.

The aircraft will land automatically if the current battery level can only support the aircraft long enough to descend from its current altitude.

The Battery Level Indicator is displayed in DJI GO 4, and is described below:

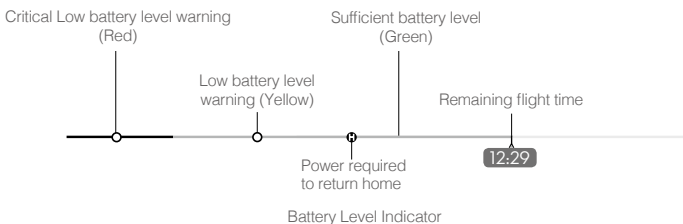

Battery Level Warning	Remark	Aircraft Status Indicator	DJI GO 4 App	Flight Instructions
Low battery level warning	Battery power is low. Land the aircraft.	Aircraft status indicators blink RED slowly.	Tap "Go-home" to have the aircraft return to the Home point automatically, or "Cancel" to resume normal flight. If no action is taken, the aircraft will automatically go home after 10 seconds. Remote controller will sound an alarm.	Fly the aircraft back and land it as soon as possible, then stop the motors and replace the battery.
Critical Low battery level warning	The aircraft must land immediately.	Aircraft status indicators blink RED quickly.	The DJI GO 4 app display will flash red and the aircraft will start to descend. The remote controller will sound an alarm.	Allow the aircraft to descend and land automatically.
Estimated remaining flight time	Estimated remaining flight based on current battery level.	N/A	N/A	N/A



- When the Critical Low Battery level warning is triggered and the aircraft begins to land automatically, throttle up using the virtual joysticks or control sticks to keep the aircraft at its current altitude. This gives you an opportunity to navigate to a more appropriate landing location.
- The colored zones and markers on the battery level indicator bar reflect the estimated remaining flight time. They are automatically adjusted according to the aircraft's current location and status.

Failsafe RTH

If the Home Point was successfully recorded, GPS signal is strong and the compass is functioning normally, Failsafe RTH will be automatically activated if the wireless signal is lost for a specified amount of time (three seconds when using the remote controller and 20 seconds when using Wi-Fi). The user may cancel Failsafe RTH to regain control when the wireless signal connection is reestablished.

RTH Procedure

1. Home Point is recorded automatically.
2. RTH procedure is triggered i.e., Smart RTH, Low-Battery RTH and Failsafe RTH.
3. Home Point is confirmed and the aircraft adjusts its orientation.
4. a. The aircraft will ascend to the pre-set RTH attitude and then fly to the Home Point when the aircraft is further than 20 m from the home point.
 - b. When the aircraft is between 3 m and 20 m from the Home Point, it will return to the Home Point at the current altitude with the RTH at Current Altitude option enabled (the default setting in DJI GO 4) if flying at or above 2.5 m. It will ascend to 2.5 m then return to home if flying lower than 2.5 m.

Note: If RTH at Current Altitude is disabled in DJI GO 4, the aircraft will land automatically when the aircraft is between 3 m and 20 m from the Home Point.

- c. The aircraft will land automatically if RTH is triggered and the aircraft is less than 3 m from the home point.
5. The aircraft will hover 0.3 m above ground and wait for confirmation from the user. The aircraft will land and stop its motors after user confirmation.

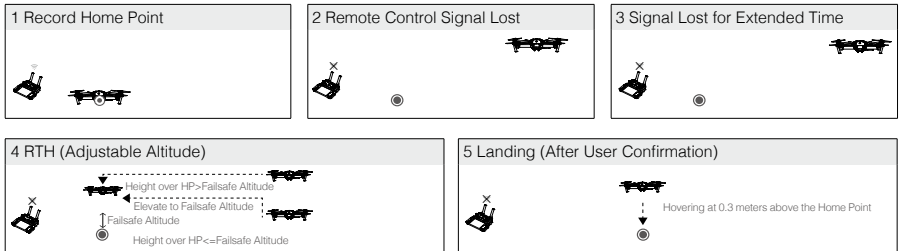

- The aircraft cannot return to the Home Point when GPS signal is weak or unavailable.
- It is important to set a suitable Failsafe altitude before each flight. Launch the DJI GO 4 app, tap “GO FLY” and tap  to set the Failsafe Altitude.
- The aircraft will stop ascending and immediately return to the Home Point if you move the throttle stick in the aircraft reaches 65 feet (20 meters) altitudes or beyond during Failsafe.

Obstacle Avoidance during RTH

Spark will Return to Home at a flight speed of 10 m/s and cannot avoid obstacles when RTH is triggered and the aircraft is further than 100 m from the home point.

Spark can sense and actively attempt to avoid obstacles during RTH, provided that lighting conditions are adequate enough for the 3D Sensing System and RTH is triggered when the aircraft is less than 100 m from the Home Point. Upon detecting an obstacle, the aircraft will act as follows:

1. The aircraft decelerates when an obstacle is sensed at 16 ft (5 m).
2. The aircraft stops and hovers then starts flying backward until the 3D Sensing System cannot sense any obstacles.
3. The aircraft ascends vertically for about five seconds.
4. RTH procedure resumes. The aircraft will continue flying to the Home Point at the current altitude.

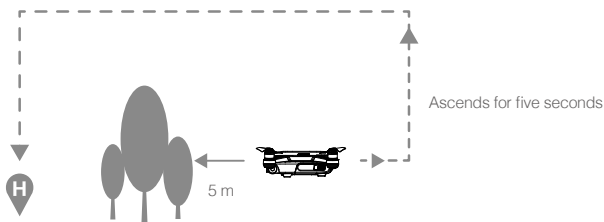

- ⚠ • Obstacle sensing will turn off and the aircraft will ascend to the Failsafe altitude automatically and will fly to the Home Point at a flight speed of 10 m/s if the obstacle can still be sensed after the aircraft has flown backward for 10 m.
 - The aircraft will repeat steps 1-3 if the obstacle is sensed again during ascent.
 - The aircraft cannot avoid obstacles above, beside, or behind the aircraft.
-

Precision Landing

Spark automatically scans and attempts to match the terrain features underneath it during Return-to-Home. When the current terrain matches Home Point terrain, Spark will begin landing immediately to achieve precision landing. DJI GO 4 will show a terrain feature mismatch prompt if matching fails.

- ⚠ • Precision Landing performance is subject to the following conditions:
 - Home Point is recorded upon take off, and cannot not be refreshed during flight.
 - The aircraft must take off vertically. Takeoff altitude must be greater than seven meters.
 - Home Point terrain features remain largely unchanged.
 - Home Point terrain with no distinctive features will affect performance.
 - Lighting conditions cannot be too light or too dark.
 - The following actions are available during landing:
 - Throttle down to accelerate landing.
 - Moving the control sticks in any other direction will stop Precision Landing. Spark will descend vertically after the control sticks are released.
-

Intelligent Flight Modes

Spark supports Intelligent Flight Modes, including QuickShot, ActiveTrack, TapFly, Gesture, and Tripod Mode. Tap  in DJI GO 4 or press the Function button on the remote controller to enable an Intelligent Flight Mode.

QuickShot

QuickShot shooting modes include Rocket, Dronie, Circle, and Helix. Spark will record a video according to the selected shooting mode and then automatically generate a 10-second short video. The video can then be viewed, edited, or shared to social media from the Playback menu.

 Dronie : Fly backward and upward, with the camera locked on your subject.

 Circle: Circle around your subject.

 Helix: Fly upward, spiraling around your subject.

 Rocket: Ascend with the camera pointing downward.

Using QuickShot

Ensure that the aircraft is in P Mode and that the Intelligent Flight Battery is charged sufficiently. Follow the steps below to use QuickShot:

1. Take off and ensure the aircraft is flying at least 4.5 ft (1.5 m) above the ground.

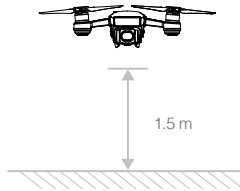

2. Launch DJI GO 4, tap , then select QuickShot, and follow the prompts.

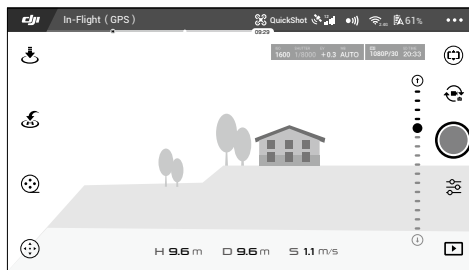

3. Select your target subject in the camera view and choose a shooting mode. Tap "GO" to begin recording. The aircraft will fly back to its original position after shooting is finished.

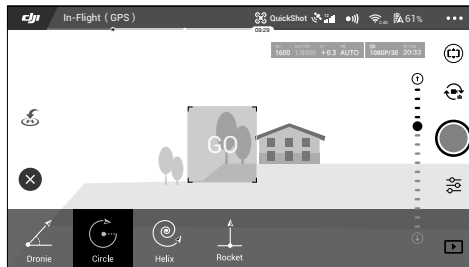

4. View and edit the generated or original video using Playback.



- QuickShot is only available when GPS signal is strong.
- Tap  in DJI GO 4 to exit QuickShot anytime during shooting.
- In QuickShot, the aircraft cannot avoid obstacles automatically. Please make sure to only use QuickShot in wide open areas.

ActiveTrack

ActiveTrack allows you to mark and track a moving object on your mobile device's screen. No external tracking device is required.

Spark can automatically identify and trace bikes and other vehicles, people and animals, and use different tracking strategies for each.

Using ActiveTrack

Ensure the Intelligent Flight Battery is fully charged and the aircraft is in P Mode. Follow the steps below to use ActiveTrack:

1. Take off and hover at least 4.5 ft (1.5 m) above ground.

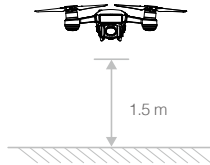

2. In DJI GO 4, tap  to bring up the flight modes and select ActiveTrack.

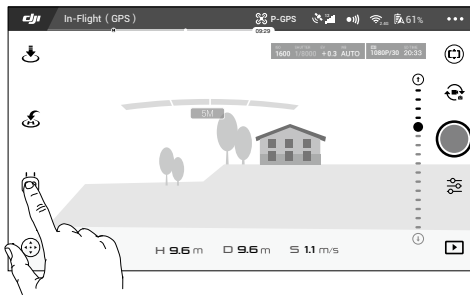

3. Tap on the subject you want to track then tap to confirm your selection. If the subject is not automatically recognized, drag a box around it. The box will turn green when tracking is in progress. If the box turns red, the object could not be identified and you should try again.

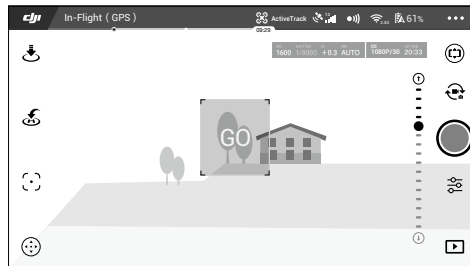

4. The aircraft will automatically avoid obstacles in its flight path. If the aircraft loses track of the subject, because it is moving too fast or is obscured, re-select the subject to resume tracking.

ActiveTrack includes the following functions:

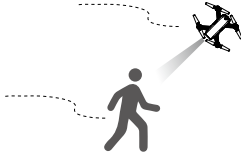
Trace	Profile
	
<p>The aircraft tracks the subject at a constant distance. Use the roll stick on the remote controller or the slider in DJI GO 4 to circle the subject.</p>	<p>The aircraft tracks the subject at constant angle and distance from the side. Use the roll stick on the remote control to circle the subject. The aircraft will not be able to avoid obstacles while in Profile Mode. Use this mode in open areas.</p>



- DO NOT select an area with people, animals, small or fine objects (e.g. tree branches and power lines), or transparent objects (e.g. glass or water).
- Stay clear of obstacles near the flight path, particularly when the aircraft is flying backward.
- Operate the aircraft manually or tap  icon in DJI GO 4 in an emergency.
- Be extra vigilant when using ActiveTrack in any of the following situations:
 - a) The tracked subject is not moving on a level plane.
 - b) The tracked subject changes shape drastically while moving.
 - c) The tracked subject could be blocked or out of sight for a long time.
 - d) The tracked subject is moving on a snowy surface.
 - e) The tracked subject has a similar color or pattern to its surrounding environment.
 - f) Available light is too low (< 300 lux) or too high (> 10,000 lux).
- You must follow local privacy laws and regulations when using ActiveTrack.

Exiting ActiveTrack

Use the following methods to exit ActiveTrack:

1. Press the Flight Pause button on the remote controller.
2. Tap the  icon on the screen.



After exiting ActiveTrack, the aircraft will hover in place, at which point you may choose to fly manually, track another subject, or return to home.

TapFly

TapFly features two entirely new sub modes, Coordinate Mode and Direction Mode. Coordinate Mode is the default. The aircraft will automatically avoid obstacles it sees or brake and hover in front of them, provided that there is sufficient light between (< 300 lux) and (> 10,000 lux).

Coordinate Mode

Tap a specific location on screen. The aircraft will travel to that point at your current altitude, then hover in place.

Using Coordinate Mode

Ensure that the Intelligent Flight Battery is fully charged and the aircraft is in P Mode. Follow the steps below to use Coordinate Mode:

1. Take off and ensure the aircraft is hovering at least 3 ft (1 m) above ground.

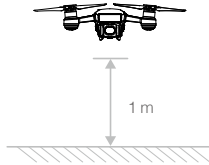

2. Launch DJI GO 4 and tap . Select TapFly, Coordinate Mode, then follow the prompts.

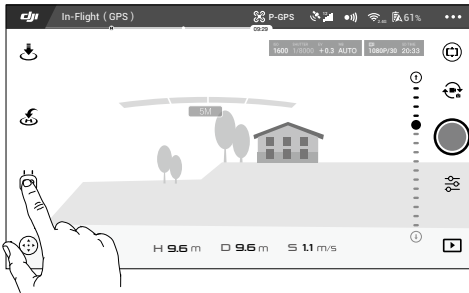

3. Tap once on the target and wait for the "GO" icon to appear. Tap the "GO" icon to confirm the selection and the aircraft will fly to the target automatically. There will be a prompt if the target cannot be reached. If this is the case, select another target and try again.

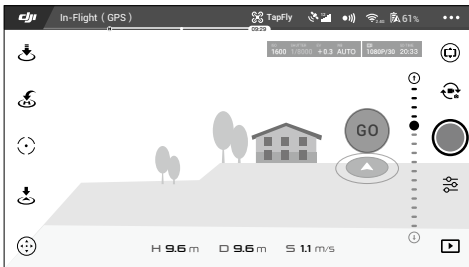

4. A target can be changed mid flight by tapping the screen.
5. Press and hold on the screen for about two seconds until a blue circle appears. Drag the circle up and down to adjust gimbal tilt angle.

• Ensure the target is on a flat plane when using Coordinate Mode. The aircraft may not accurately reach the target otherwise.

Exiting Coordinate Mode

Use the following methods to exit Coordinate Mode:

1. Tap the ✕ icon on the screen.
2. Pull back the pitch stick on the remote controller for three seconds or more.
3. Press the Flight Pause button on the remote controller.
4. Drag the blue circle left and right.

Direction Mode

Keep flying in the direction you tap on the screen.

Using Direction Mode

Ensure the Intelligent Flight Battery is fully charged and the aircraft is in P Mode. Follow the steps below to use Direction Mode:

1. Take off and ensure the aircraft is flying at least 3 ft (1 m) above the ground.

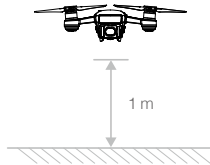

2. Launch DJI GO 4 and tap . Select TapFly, switch to Direction Mode, then follow the prompts.

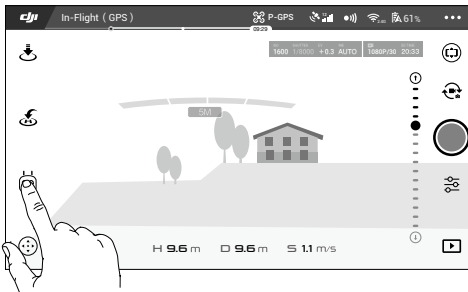

3. Tap once on the target and wait for the "GO" icon to appear. Tap the "GO" icon to confirm the selection and the aircraft will fly in that direction automatically.

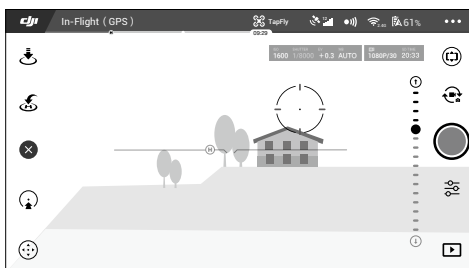

After confirming the selection, the aircraft will fly in the direction marked by the "GO" icon. The aircraft will automatically adjust its speed when it senses an obstacle out in front or if it is flying too close to the ground. However, this feature should not be relied upon for navigation between obstacles.

Failsafe procedures will override all TapFly functions. If GPS signal is weak, the aircraft will exit autonomous flight and return to home.

Exiting Direction Mode

Use the following methods to exit Direction Mode:

1. Tap the  icon on the screen.
2. Pull back the pitch stick on the remote controller for three seconds or more.
3. Press the Flight Pause button on the remote controller.

The aircraft will stop and hover after exiting Direction Mode. Tap a new target direction to continue flying or begin manual flight.

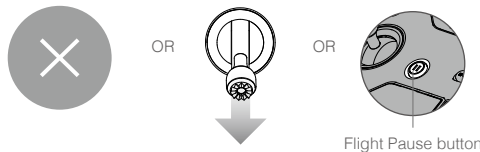

-
-  • DO NOT fly the aircraft over people, animals, small or fine objects (e.g. tree branches and power lines) or transparent objects (e.g. glass or water). TapFly Mode may not work properly when the aircraft is flying over water or snow covered areas.
- Watch for obstacles in the flight path and steer clear of them.
 - There may be deviations between expected and actual flight paths selected in TapFly.
 - The selectable range for the target direction is limited. You cannot make a Direction Mode selection close to the upper or lower edge of the screen.
 - Be extra cautious when flying in too dark (< 300 lux) or too bright (>10,000 lux) environments.
-







Tripod Mode



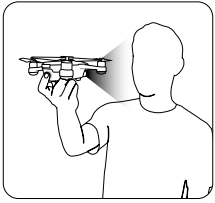

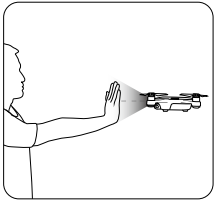
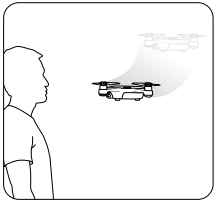

Tap the icon in DJI GO 4 to enable Tripod Mode. In Tripod Mode, the maximum flight speed is limited to 2.2 mph (3.6 kph). Responsiveness to stick movements is also reduced for smoother more controlled movements.

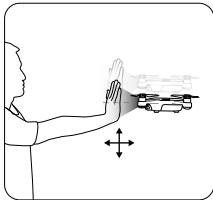

-
-  • Only use Tripod Mode when the GPS signal is strong or in light conditions ideal for the Vision System. If GPS signal is lost and the Vision System does not function, it will automatically switch to ATTI mode. In this case, flight speed will increase and the aircraft will not hover in place. Use Tripod Mode carefully.
-

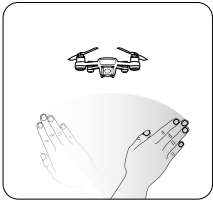
Gesture Mode

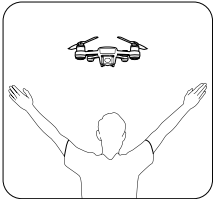
Deep learning gesture recognition allows you to take selfies with simple hand motions. Spark features brand new gesture controls like PalmLaunch, PalmControl, PalmLand, Beckon, and Selfie.

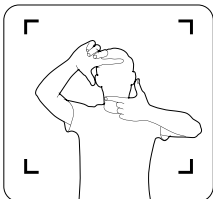
Feature Descriptions	Front LEDs	Figure
PalmLaunch		
1. Power on the aircraft while holding it. Wait for the aircraft status indicators to blink green. Make sure your fingers are well below the aircraft arms.	 — Solid red	
2. Next, tap the Intelligent Flight Battery power button twice. The front LEDs should blink yellow slowly.	 Blinks yellow	
3. FaceAware will start to work automatically. When FaceAware activates successfully, the aircraft beeps twice and the front LEDs become solid green for six seconds. If the front LEDs blink red twice, then FaceAware has failed. Please repeat step 2.	 — Solid green	
4. The front LEDs will glow solid red after the motors start spinning. Release the aircraft and it will hover in place.	 — Solid red	
Start/Stop PalmControl		
1. Stand in front of the aircraft, then raise and extend one of your arms in the direction of the aircraft. Extend your fingers and keep them close together. Position your palm about 0.7 m in front of the aircraft's nose for about two seconds.	 — Solid green	
2. The front LEDs will glow solid green if the PalmControl activation is successful. Adjust your distance from the aircraft if the front LEDs start to blink yellow fast. This means you are too close or too far away from the aircraft.		
3. Dropping your hand quickly will exit PalmControl, and the front LEDs should glow solid red.	 — Solid red	

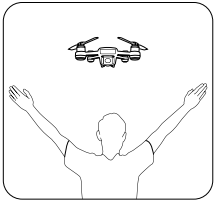
Adjusting Position		
<p>1. Move your palm up or down slowly to control the aircraft's altitude while maintaining a constant distance between your palm and the aircraft.</p>		
<p>2. Keep your palm at a constant distance from your body (as shown), then move your arm left or right to control the aircraft's orientation.</p>	 — Solid green	
<p>3. Keep your palm at a constant distance from your body, move forward or backward to fly forward or backward.</p>		
Follow		
<p>1. Stand in front of the aircraft then raise one of your arms and quickly wave your hand at the camera. Position your palm about 0.7 m in front of the aircraft's nose for about two seconds.</p>	 x2 Blinks green twice	
<p>2. The front LEDs will blink green twice if the gesture is recognized successfully. The aircraft will ascend and fly backward, then hover in place 3 m from where you're standing, 2.3 m above ground.</p>		
<p>3. The front LEDs will glow solid green and the aircraft will start tracking automatically.</p>	 — Solid green	
<p>4. If the wave gesture fails, you can activate Follow by raising both arms above your head in a Y shape, then holding for two seconds.</p>		
Taking Selfies		
<p>1. While the aircraft is following you, make a frame with your hands and it will begin taking a selfie.</p>		
<p>2. Selfie gesture has been recognized successfully if the Front LEDs blink red slowly. Wait for the selfie count down for three seconds. The Front LEDs will blink red quickly, indicating the camera is about to take a selfie.</p>	 Blinks red slowly	

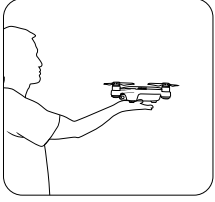
Beckon		
1. Raise your arms above your head in a Y shape for two seconds after the aircraft starts tracking.	 — Solid red	
2. When Beckon is successfully activated, the aircraft will fly toward you and hover in place 1.5 m above ground and 1.2 m away from you.		
3. The front LEDs will turn solid red.		
PalmLand		
Place your palm approximately 0.5 m underneath the aircraft at a distance of no further than 1.5 m away from you. The aircraft will slowly descend and land on your palm.	 — Solid red	





- It is highly recommended to install the Spark Propeller Guards before using Gesture Mode to ensure safety.
- Gesture Control needs to be enabled in DJI GO 4 by tapping .
- In PalmLaunch, the Aircraft Status Indicators will blink normally and will not display remote signal loss, even without a mobile device or remote controller connected.
- Gesture Mode can only be used to take photos.
- Enabling GPS on your mobile device will allow the aircraft to follow more accurately in Gesture Mode.

Flight Recorder

Flight data is automatically recorded to the internal storage of the aircraft. This includes flight telemetry, aircraft status information, and other parameters. To access this data, connect the aircraft to the PC through the Micro USB port.

Attaching and Detaching the Propellers

Only use DJI approved propellers with your Spark. White ringed and unmarked propellers indicate where they should be attached and in which direction they should spin.

Propellers	White Ring	Unmarked
Figure		
Attach On	Motors with white marks	Motors without white marks
Legends	 Lock : Turn the propellers in the indicated direction to mount and tighten.	

Attaching the Propellers

Attach the propellers with the white rings to the mounting base with white marks. Press each propeller down onto the mounting plate and rotate in the lock direction until it is secured. Attach unmarked propellers to the mounting bases without marks. Unfold all the propeller blades.

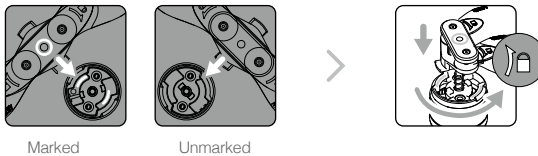

Detaching the Propellers

Press the propellers down into the motor mount and rotate them in the unlock direction.

-  Propeller blades are sharp; please handle with care.
- Only use DJI approved propellers. Do not mix propeller types.
- Stay clear of spinning motors. Do not touch the propellers when they are spinning.
- Ensure to check that the propellers and motors are installed firmly and correctly before each flight.
- Ensure that all propellers are in good condition before each flight. Do not use aged, chipped, or broken propellers.
- To avoid injury, stand clear of and do not touch propellers or motors when they are spinning.
- Please use original DJI propellers for a better and safer flight experience.

Intelligent Flight Battery

Introduction

The DJI Intelligent Flight Battery has a capacity of 1480 mAh, a voltage of 11.4 V, and a smart charge/discharge functionality. It should only be charged using an appropriate DJI approved charger.

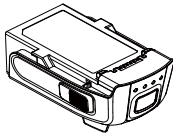

Intelligent Flight Battery



Charger

 The Intelligent Flight Battery must be fully charged before using it for the first time.

DJI Intelligent Flight Battery Functions

1. **Battery Level Display:** The LED indicators display the current battery level.
2. **Auto-Discharging:** To prevent swelling, the battery automatically discharges to below 70% of the total power when it is idle for more than 10 days. It takes around two days to discharge the battery to 65%. It is normal to feel moderate heat being emitted from the battery during the discharge process. Discharge thresholds can be set in the DJI GO 4 app.
3. **Balanced Charging:** Automatically balances the voltage of each battery cell when charging.
4. **Overcharge Protection:** Charging automatically stops when the battery is fully charged.
5. **Temperature Detection:** The battery will only charge when the temperature is between 5° C (41° F) and 40° C (104° F).
6. **Over Current Protection:** The battery stops charging when a high amperage (more than 3 A) is detected.
7. **Over Discharge Protection:** To prevent over-discharge damage, discharging automatically stops.
8. **Short Circuit Protection:** Automatically cuts the power supply when a short circuit is detected.
9. **Hibernation Mode:** The battery will cut off the power supply and switch off after 20 minutes of inactivity to save power. The battery will enter Hibernation Mode after six hours of inactivity when the battery level is less than 10% to prevent over discharging. The battery level indicators will not light up. Charging the battery will wake it from hibernation.
10. **Communication:** Information pertaining to the battery's voltage, capacity, current, etc. is transmitted to the aircraft's main controller.

 • Refer to the Spark Intelligent Flight Battery Safety Guidelines before use. Users take full responsibility for all operations and usage.

Using the Battery

Turning ON/OFF

Turning On: Press the Power button once, then press again and hold for two seconds to power on. The remote controller system status screen will display the current battery level.

Turning Off: Press the Power button once, then press again and hold for two seconds to power off.

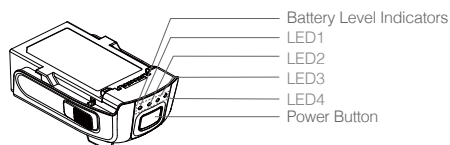

Low Temperature Notice:

1. Battery capacity is significantly reduced when flying in low temperature (0°C and 5°C) environments.
2. Batteries cannot be used in extremely low temperature (< 0°C) environments.
3. End the flight as soon as the DJI GO 4 app displays the “Low Battery Level Warning” in low temperature environments.
4. To ensure optimal performance of the battery, keep the battery temperature above 20°C.

































 • In cold environments, insert the battery into the battery compartment and turn on the aircraft for approximately 1-2 minutes to warm up before taking off.

Checking Battery Level

The Battery Level Indicators display how much power remains. When the battery is turned off, press the Power button once, the Battery Level Indicators will light up to display the current battery level. See below for details.

 The Battery Level Indicators will also show the current battery level during charging and discharging. The indicators are defined below.

-  : LED is on.
-  : LED is flashing.
-  : LED is off.

LED1	LED2	LED3	LED4	Battery Level
				88%~100%
				75%~88%
				63%~75%
				50%~63%
				38%~50%
				25%~38%
				13%~25%
				0%~13%

Charging the Intelligent Flight Battery

1. Connect the Battery Charger to a power source (100-240 V, 50/60 Hz).
2. Connect the Micro USB port on Spark to the charger to start charging.
3. The Battery Level Indicator will display the current battery level as it is charging.
4. The Intelligent Flight Battery is fully charged when the Battery Level Indicators are all off. It will take approximately 1 hour and 20 minutes to fully charge the battery. Detach the charger when the battery is fully charged.

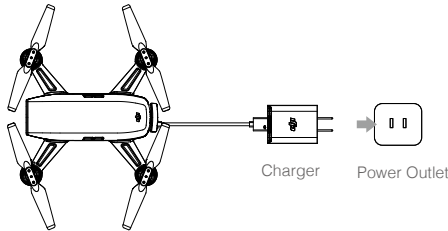

- ⚠
- Never insert or remove a battery when it is turned on.
 - Allow battery temperature to drop to room temperature before storing for an extended period.
 - The charger will stop charging the battery if battery cell temperature is not within the operating range (5°C to 40°C).

LED1	LED2	LED3	LED4	Battery Level
☀	☀	○	○	0%~50%
☀	☀	☀	○	50%~75%
☀	☀	☀	☀	75%~100%
○	○	○	○	Fully Charged

Battery Protection LED Display

The table below shows battery protection mechanisms and corresponding LED patterns.

LED1	LED2	LED3	LED4	Blinking Pattern	Battery Protection Item
○	☀	○	○	LED2 blinks twice per second	Over current detected
○	☀	○	○	LED2 blinks three times per second	Short circuit detected
○	○	☀	○	LED3 blinks twice per second	Over charge detected
○	○	☀	○	LED3 blinks three times per second	Over-voltage charger detected
○	○	○	☀	LED4 blinks twice per second	Charging temperature is too low
○	○	○	☀	LED4 blinks three times per second	Charging temperature is too high

After these issues are resolved, press the Power button to turn off the Battery Level Indicators. Unplug the Intelligent Flight Battery from the charger and plug it back in to resume charging. You do not need to unplug and plug in the charger in the event of a room temperature error; the charger will resume charging when the temperature is within the allowable range.

 DJI does not take any responsibility for damage caused by third-party chargers.

 **Discharging Intelligent Flight Batteries before long trips:**
Fly Spark outdoors until there is less than 30% power left or until the battery no longer turns on.

Gimbal and Camera

Gimbal

Profile

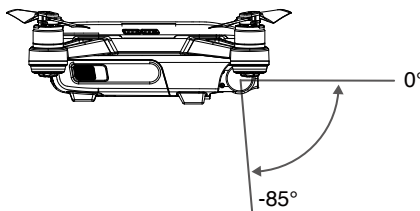

Spark's 2-axis mechanical gimbal provides stabilization for the attached camera, allowing you to capture clear, stable images and video. The gimbal has an 85° tilt range.

In the camera view, press and hold on the screen until a blue circle appears. Dragging the circle left and right will control the aircraft's orientation, and dragging the circle up and down will control the camera's tilt.



Gimbal Operation Modes

Two gimbal operation modes are available. Switch between the different operations modes on the camera settings page of the DJI GO 4 app.

	Follow Mode	The roll axis will stay level at all times.
	FPV Mode	The gimbal will synchronize with the movement of the aircraft to provide a first-person perspective flying experience.
	<ul style="list-style-type: none"> • Take off from flat, open ground and protect the gimbal at all times. • A gimbal motor error may occur in these situations: <ol style="list-style-type: none"> (1) The aircraft is placed on uneven ground or the gimbal's motion is obstructed. (2) The gimbal has been subjected to excessive external force, such as a collision. • Flying in heavy fog or clouds may make the gimbal wet, leading to temporary failure. The gimbal will recover full functionality after it dries. • The gimbal will enter FPV mode automatically when the aircraft is in Sport Mode. 	

Camera

Profile

The onboard camera uses its 1/2.3 inch CMOS sensor to capture video up to 1080p at 30 fps and 12 megapixel stills. You can record video in either MOV or MP4 formats. Available picture shooting modes include Single Shot, Burst, Interval, Panorama, and ShallowFocus. A live preview of what the camera sees can be monitored on a connected mobile device via the DJI GO 4 app.

Camera Micro SD Card Slot

To store your photos and videos, insert the Micro SD card into the slot, as shown below, before turning on the aircraft. Spark supports Micro SD cards up to 64 GB. A UHS-1 Micro SD card is recommended due to their fast read and write speeds for high-resolution video recording.

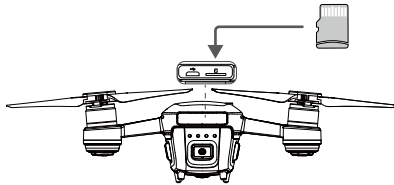

- Do not remove the Micro SD card from the aircraft when it is powered on.



- To ensure the stability of the camera system, single video recordings are capped at 30 minutes.
 - Only Micro SD cards less than or equal to 32 GB can be used on Mac computers due to system limitations.
 - Capture footage can be saved to the mobile device if there is no SD card or SD card storage is full. Note that the resolution of photos is 1024x768 and videos 1280x720.
-

Camera Data Port

Turn on Spark and connect a USB cable to the Micro USB Port to download photos and videos to your computer.



- The aircraft must be turned on before attempting to access files on the Micro SD card.
-

Controlling the Aircraft with a Mobile Device

You can connect a mobile device via Wi-Fi to control the aircraft with DJI GO 4. Follow the instructions below to learn how.

1. Power on the aircraft.
2. Turn on your mobile device's Wi-Fi, select Spark's network, and enter the Wi-Fi password.
3. Launch DJI GO 4. Tap "GO FLY" to enter camera view.
4. Tap the  icon to take off automatically. Put both your thumbs on screen and use virtual joysticks to maneuver the aircraft.

- ⚠ The Wi-Fi frequency of your mobile device can be set to 2.4 GHz (default) or 5.8 GHz. On supported devices, set Wi-Fi to 5.8 GHz for less interference.
 - Press and hold the power button for nine seconds or more until you hear three beeps to reset the Wi-Fi name and password, and reset the Wi-Fi frequency to 2.4 GHz. Or tap "Help" in the DJI GO 4 app, then follow the instructions.
 - Only fly with a Wi-Fi connection in wide open areas with relatively little electromagnetic interference. If your connection is adversely affected by interference, it is recommend to fly with the remote controller instead, or move to an area with less interference.
-

Using Virtual Joysticks

Ensure the mobile device has been connected to the aircraft before using the virtual joysticks. The illustrations below are based on Mode 2 (left stick as throttle).

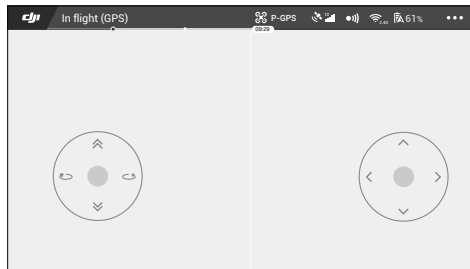

Virtual Joysticks GUI

Move the aircraft upwards, downwards, left, or right by pressing on the left half of the screen. Move the aircraft forwards, backwards, or laterally by pressing on the right half of the screen. Tap on the "⋮" button to enable or disable the virtual joysticks..

- ⚠ The area beyond the white cycles is also responsive to control commands.
-

Controlling the Aircraft

This section explains how to control the aircraft. The control stick mode can be set to Mode 1, Mode 2, Mode 3, or a custom mode.

Mode 1

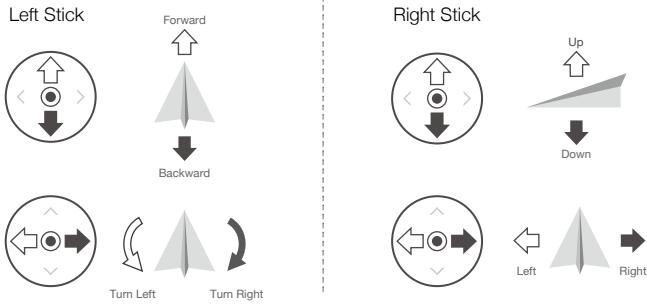

Mode 2

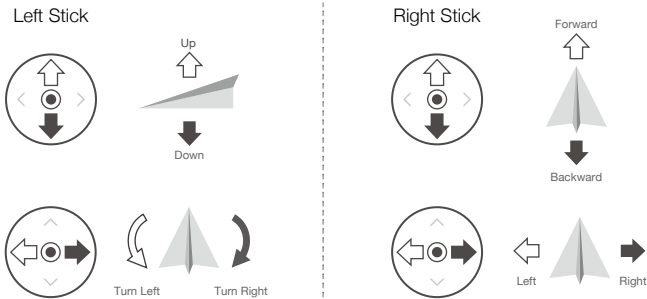

Mode 3

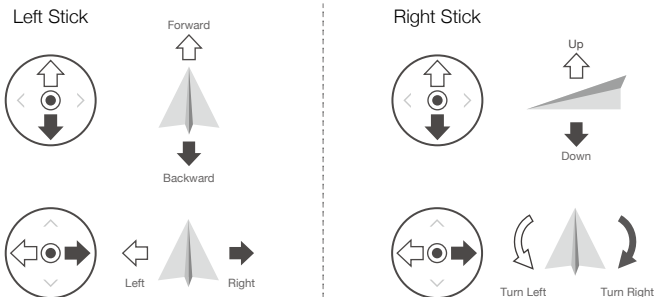







The Stick Mode is set to Mode 2 by default.

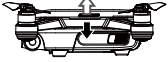

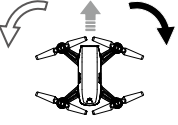
Stick Neutral/Mid-Point: Control sticks are centered.

Moving the Control Stick: Control sticks are pushed away from the center.

Virtual Joysticks / Remote Controller (Mode 2)	Aircraft (← Indicates Nose Direction)	Remarks
<p>Left Stick</p> 		<p>Moving the left stick up and down changes the aircraft's elevation.</p> <p>Push the stick up to ascend and down to descend.</p> <p>When both sticks are centered, the Spark will hover in place.</p> <p>The more the stick is pushed away from the center position, the faster the Spark will change elevation. Always push the stick gently to prevent sudden and unexpected elevation changes.</p>
<p>Left Stick</p> 		<p>Moving the left stick to the left or right controls the rudder and rotation of the aircraft.</p> <p>Push the stick left to rotate the aircraft counter-clockwise, push the stick right to rotate the aircraft clockwise. If the stick is centered, the Spark will maintain its current orientation.</p> <p>The more the stick is pushed away from the center position, the faster the Spark will rotate.</p>
<p>Right Stick</p> 		<p>Moving the right stick up and down changes the aircraft's forward and backward pitch.</p> <p>Push the stick up to fly forward and down to fly backward. Spark will hover in place if the stick is centered.</p> <p>Push the stick further away from the center position for a larger pitch angle (maximum 30°) and faster flight.</p>
<p>Right Stick</p> 		<p>Moving the right stick control left and right changes the aircraft's left and right pitch.</p> <p>Push left to fly left and right to fly right. The Spark will hover in place if the stick is centered.</p>

Remote Controller (Optional)

This section describes the features of the remote controller and includes instructions for controlling the aircraft and the camera.

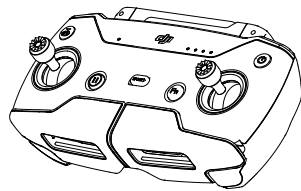

Remote Controller (Optional)

Remote Controller Profile

Spark's remote controller features a brand new, amplified Wi-Fi signal transmission system, capable of controlling the aircraft and the gimbal camera at a maximum transmission range of 1.2 mi (2 km)*. The remote controller can connect to a mobile device wirelessly and display a live video feed via the DJI GO 4 app. The folding clamps allow you to secure your mobile device. Maximum remote controller battery life is approximately 2.5 hours*.

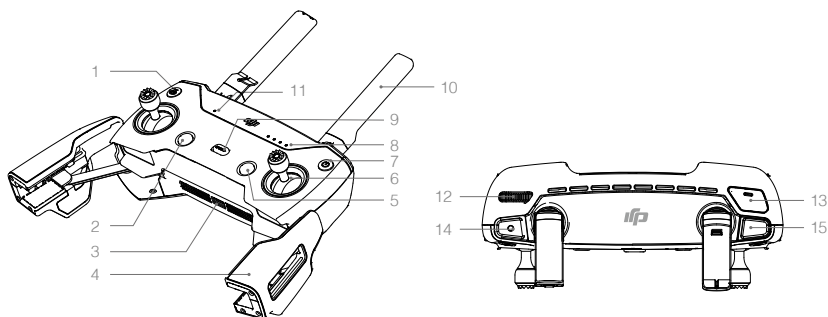

- 1. Return to Home (RTH) Button**
Press and hold the button to initiate RTH. Press again to cancel RTH.
- 2. Flight Pause Button**
Press once for emergency braking.
- 3. Power Port (Micro USB)**
Connect to the charger to charge the remote controller battery.
- 4. Mobile Device Clamps**
Securely mount your mobile device to the remote controller.
- 5. Function Button**
Bring up the DJI GO 4 Intelligent Flight Modes menu.
- 6. Control Sticks**
Control the orientation and movement of the aircraft.
- 7. Power Button**
Press the Power button once to check the current battery level. Press once, then again and hold to turn on/off the remote controller.
- 8. Battery Level LEDs**
Display the battery level of the remote controller.
- 9. Flight Mode Switch**
Switch between P Mode and S Mode.
- 10. Antennas**
Relay aircraft control and video signal.
- 11. Status LED**
Displays the remote controller's system status.
- 12. Gimbal Dial**
Controls the camera's tilt.
- 13. Customizable Button**
Performs various functions based on settings in the DJI GO 4 app.
- 14. Record Button**
Press to start recording video. Press again to stop recording.
- 15. Shutter Button**
Press to take a photo.

* The remote controller can reach its maximum transmission distance (FCC) in a wide open area with no electro-magnetic interference and at an altitude of about 120 meters. Maximum operation time was tested in windless conditions flying at a constant speed of 12.4 mph (20 kph). This value should be taken for reference only.



- **Compliance Standards:** The remote controller is compliant with local compliance and regulations.
- **Stick Mode:** Controls can be set to Mode 1, Mode 2, or to a custom mode.

Using the Remote Controller

The remote controller is powered by a rechargeable battery that has a capacity of 2970 mAh.

Turning the Remote Controller On and Off

Press the Power button once to check the current battery level. Press once, then again and hold to turn on/off the remote controller.

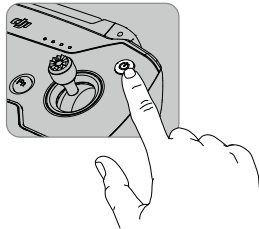

Charging the Battery

Connect the power port on the remote controller to the USB charger to charge the battery. It takes approximately two hours to fully charge the remote controller.

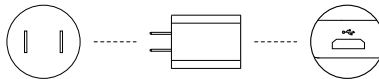

Controlling the Camera

Shoot videos/photos and adjust the camera's tilt via the Shutter Button, Record Button, and Gimbal Dial on the remote controller.

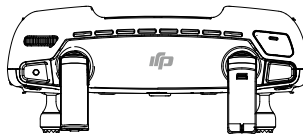



Controlling the Aircraft

The Stick Mode will be the same as what is set for virtual joysticks.

Flight Mode Switch

Toggle the switch to select the desired flight mode. Choose between P Mode and S Mode.

Position	Flight Mode
	P Mode
	S Mode

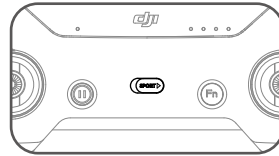

RTH Button

Press and hold the RTH button to start the Return to Home (RTH) procedure. The aircraft will then return to the last recorded Home Point. Press this button again to cancel the RTH procedure and regain control of the aircraft.

Optimal Transmission Range

The transmission signal between the aircraft and the remote controller is most reliable when the antennas are positioned in relation to the aircraft as depicted below:

Optimal Transmission Range

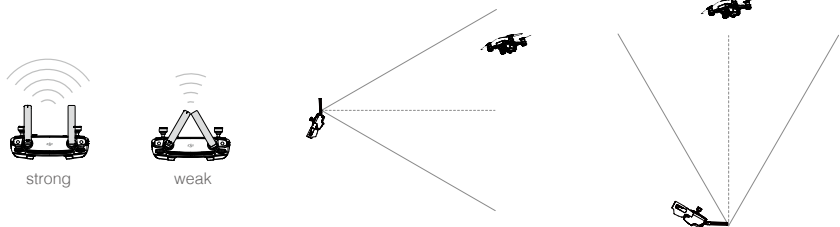

Ensure the aircraft is flying within the optimal transmission zone. To maintain optimal transmission performance, adjust the remote controller and antennas according to the above diagram.

Linking the Remote Controller

The aircraft and the remote controller are linked before shipment if you purchase the Spark Combo (with the remote controller included). To link a remote controller to Spark, follow the instructions below:

1. Power on the aircraft and the remote controller. Wait until the aircraft status indicators blink yellow.
2. Press and hold the power button of the Intelligent Flight Battery for three second. Release the button after hearing a single beep. The front LEDs will blink red.
3. Press and hold the Flight Pause button, the Function button, and the Customizable button simultaneously. Linking begins when the alarm becomes a quick single beep after an alternating single/double beep.

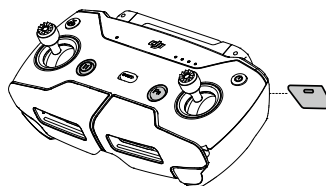

4. Then the front LEDs turn solid red after blinking green. When the status LED on the remote controller turns solid green, linking is complete.



Ensure the remote controller is within 0.66 ft (20 cm) of the aircraft during linking.

Disconnect the Remote Controller

Apart from using the remote controller, you can control the aircraft using virtual joysticks in DJI GO 4. However, when the remote controller is linked to the aircraft, virtual joystick control is disabled. You need to disconnect the remote controller and aircraft to enable virtual joysticks.

1. Power on the aircraft.
2. Press and hold the power button of the Intelligent Flight Battery for six seconds until hearing a double beep, which will disconnect the remote controller and aircraft.

Connect the aircraft's Wi-Fi network after disconnecting the remote controller to use virtual joysticks.

DJI GO 4 App

This section introduces the main functions of the DJI GO 4 app.

DJI GO 4 App

Use this app to control the gimbal, camera, and other aircraft functions. The app features Equipment, Editor, SkyPixel and Me sections, which are used for configuring your aircraft, editing and sharing your photos and videos with others.

Equipment

Enter Camera View by tapping the "GO FLY" icon on the Equipment page when your mobile device is connected to the aircraft.

Camera View

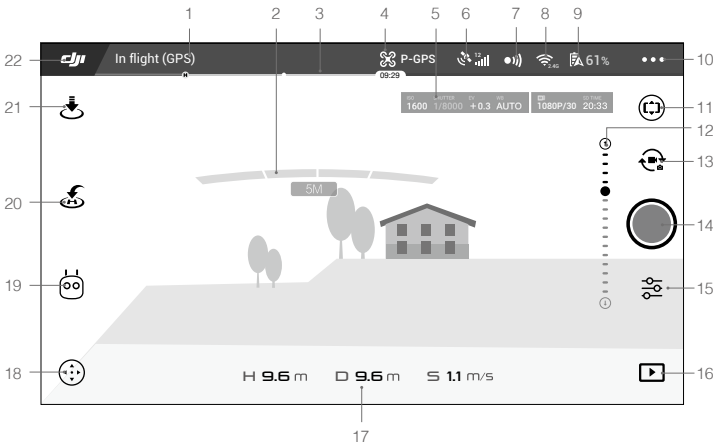

1. System Status

 : This icon indicates aircraft flight status and displays various warning messages.

2. Obstacles Detection Status

 : Red bars are displayed when obstacles are close to the aircraft. Orange bars are displayed when obstacles are in detection range.

3. Battery Level Indicator

 : The battery level indicator provides a dynamic display of the battery level. The colored zones on the battery level indicator represent the power levels needed to carry out different functions.

4. Flight Mode

 : The text next to this icon indicates the current flight mode.

Tap to configure the MC (Main Controller) Settings. These settings allow you to modify flight limits and set gain values.

5. Camera Parameters



Displays camera settings parameters and capacity of the Micro SD card.

6. GPS Signal Strength

: Shows the current GPS signal strength. White bars indicate adequate GPS strength.

7. 3D Sensing System Status

: Tap this icon to enable or disable features provided by the 3D Sensing System.

8. Wi-Fi Settings

: Tap to enter the Wi-Fi settings menu.

9. Battery Level

61%: This icon shows the current battery level. Tap to view the battery information menu, set the various battery warning thresholds, and view the battery warning history.

10. General Settings

: Tap to enter the general settings menu for setting metrics, enabling live streaming, displaying flight routes and so on.

11. Gimbal Pitch Tracking

: Adjust the gimbal's tilt by rotating your mobile device after tapping this icon.

12. Gimbal Slider

: Displays the pitch of the gimbal.

13. Photo/Video Toggle

: Tap to switch between photo and video recording modes.

14. Shoot / Record Button

: Tap to start shooting photos or recording video.

15. Camera Settings

: Tap to enter the camera settings menu.

Tap to set ISO, shutter, and auto exposure values of the camera.

Tap to select photo modes. Spark supports Single Shot, Burst Shot, Interval Shot, Pano, and ShallowFocus.

Tap to enter the general camera setting menu.

-
-  When shooting ShallowFocus photos, please note:
- It is suitable for shooting still scenes. When shooting people, do not move during the process, otherwise it may fail to take a ShallowFocus photo.
 - The aircraft will ascend about 20 cm before shooting. Ensure there is no obstacle above the aircraft.
 - The suitable range of shooting is within 30 m.
-

16. Playback

-  : Tap to enter the Playback page and preview photos and videos as soon as they are captured.

17. Flight Telemetry

- H 9.6M**: Height from the ground.
D 9.6M: Distance between the aircraft and the Home Point.
S 1.1M/S: Aircraft speed.

18. Virtual Joystick Switch

-  : Tap to enable/disable virtual joysticks. Put your fingers on the screen to use virtual joysticks to control the aircraft after enabling this switch. You can touch the screen for other operations by disabling this switch.

19. Intelligent Flight Mode

-  : Tap to select Intelligent Flight Modes.

20. Smart RTH

-  : Initiate RTH procedure. Tap to have the aircraft return to the last recorded home point.

21. Auto Takeoff/Landing

-  : Tap to initiate auto takeoff or landing.

22. Back

-  : Tap this icon to return to the main menu.

-
-  : In the camera view, press and hold on the screen until a blue circle appears. Dragging the circle left and right will control the aircraft's orientation, and dragging the circle up and down will control the camera's tilt.
-

Editor

An intelligent video editor is built into the DJI GO 4 app. After recording several video clips and downloading them to your mobile device, go to Editor on the home screen. You can then select a template and a specified number of clips which are automatically combined to create a short film that can be shared immediately.

SkyPixel

View and share the photos and videos in the SkyPixel page.

Me

If you already have a DJI account, you will be able to participate in forum discussions, and share your creations with the community.

Flight

This section describes safe flight practices and flight restrictions.

Flight

Once pre-flight preparation is complete, it is recommended that you use the flight simulator in the DJI GO 4 app to hone your flight skills and practice flying safely. Ensure that all flights are carried out in an open area.

Flight Environment Requirements

1. Do not use the aircraft in severe weather conditions. These include wind speeds exceeding 10 m/s, snow, rain and fog.
2. Fly in open areas. Tall structures and large metal structures may affect the accuracy of the onboard compass and GPS system.
3. Avoid obstacles, crowds, high voltage power lines, trees, and bodies of water.
4. Minimize interference by avoiding areas with high levels of electromagnetism, including base stations and radio transmission towers.
5. Aircraft and battery performance is subject to environmental factors such as air density and temperature. Be very careful when flying at altitudes of 13123 feet (4000 meters) above sea level, as battery and aircraft performance may be affected.
6. The Spark cannot use P Mode within the polar areas.

Flight Limits and No-Fly Zones

All unmanned aerial vehicle (UAV) operators should abide by all regulations set forth by government and regulatory agencies including the ICAO and the FAA. For safety reasons, flights are limited by default, which helps users operate this product safely and legally. Flight limitations include height limits, distance limits, and No-Fly Zones.

When operating in P Mode, height limits, distance limits, and No-Fly Zones function concurrently to manage flight safety.

Maximum flight altitude and Radius Limits

Maximum flight altitude and radius limits may be changed in the DJI GO 4 app. Be aware that the maximum flight altitude cannot exceed 1640 ft (500 m). In accordance with these settings, your Spark will fly in a restricted cylinder, as shown below:

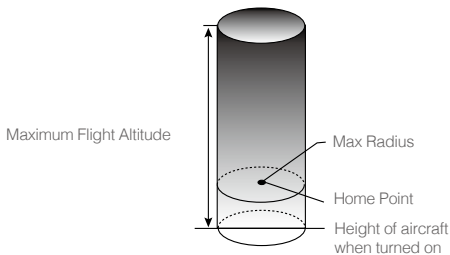

GPS Signal Strong  Blinking Green

	Flight Limits	DJI GO 4 App	Aircraft Status Indicator
Maximum Flight Altitude	Aircraft's altitude cannot exceed the specified value.	Warning: Height limit reached.	None.
Max Radius	Flight distance must be within the max radius.	Warning: Distance limit reached.	

GPS Signal Weak  Blinking Yellow

	Flight Limits	DJI GO 4 App	Aircraft Status Indicator
Maximum Flight Altitude	Height is restricted to 16 feet (5 meters) when the GPS signal is weak and Vision System is activated. Height is restricted to 98 feet (30 meters) when the GPS signal is weak and Vision System is inactivated.	Warning: Height limit reached.	None.
Max Radius	No limits		



- If the aircraft flies out of the limit, you can still control the aircraft, but you cannot fly it any farther.
- For safety reasons, please do not fly close to airports, highways, railway stations, railway lines, city centers, or other sensitive areas. Fly the aircraft only within your line of sight.

No Fly Zones

All No Fly Zones are listed on the DJI official website at <http://www.dji.com/flysafe/no-fly>. No Fly Zones are divided into Airports and Restricted Areas. Airports include major airports and flying fields where manned aircraft operate at low altitudes. Restricted Areas include country borders or locations where flights may cause security concerns.

Preflight Checklist

1. Remote controller, Intelligent Flight Battery, and mobile device are fully charged.
2. Propellers are mounted correctly and firmly.
3. Micro SD card has been inserted, if necessary.
4. Gimbal is functioning normally.
5. Motors can start and are functioning normally.
6. The DJI GO 4 app is successfully connected to the aircraft.
7. Ensure that the sensors for the 3D Sensing System and Vision System are clean.

Auto Takeoff and Auto Landing

Auto Takeoff

Use auto takeoff only if the Aircraft Status Indicators are blinking green. Follow the steps below to use the auto takeoff feature:

1. Launch the DJI GO 4 app, and tap "GO FLY" to enter camera page.
2. Complete all steps on the pre-flight checklist.
3. Tap "⬆️", and confirm that conditions are safe for flight. Slide the icon to confirm and takeoff.
4. Aircraft takes off and hovers at 1.2 meters above ground.

⚠️ Aircraft Status Indicator blinks rapidly when it is using the Vision System for stabilization. The aircraft will automatically hover below 30 meters. It is recommended to wait until there is sufficient GPS before using the Auto Takeoff feature.

Auto-Landing

Use auto-landing only if the Aircraft Status Indicators are blinking green. Follow the steps below to use the auto-landing feature:

1. Tap on "⬇️", to ensure the landing condition is ideal. Slide to confirm.
2. Abort landing process immediately by using the "⊗" button on the screen.
3. Aircraft will land and turn off automatically.

Starting/Stopping the Motors (When Using Remote Controller)

Starting the Motors

The Combination Stick Command (CSC) is used to start the motors. Push both sticks to the bottom inner or outer corners to start the motors. Once the motors have started spinning, release both sticks simultaneously.

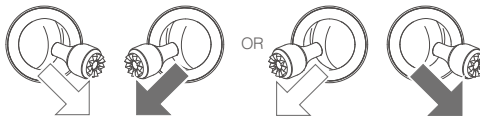



Stopping the Motors

There are two methods to stop the motors.

Method 1: When the aircraft has landed, push and hold the left stick down. The motors will stop after three seconds.

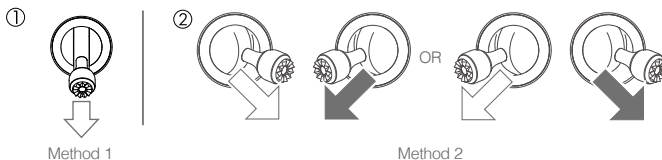
Method 2: When aircraft has landed, push the left stick down, then conduct the same CSC that was used to start the motors, as described above. Motors will stop immediately. Release both sticks once motors stop.



-
-  • To perform the CSC midair in case of an emergency, hold for 1.5 seconds to stop the motors mid-flight. Stopping the motors mid-flight will cause the aircraft to crash.
-

Flight Test

Takeoff/Landing Procedures

1. Place the aircraft in an open, flat area with the battery level indicators facing towards you.
2. Turn on the Intelligent Flight Battery.
3. Launch the DJI GO 4 app and enter the camera page.
4. Wait until the Aircraft Indicators blink green. This means the Home Point is recorded and it is now safe to fly. Use Auto Takeoff.
5. Use Auto Landing to land the aircraft.
6. Turn off the Intelligent Flight Battery.

-
-  • When the Aircraft Status Indicators blink yellow rapidly during flight, the aircraft has entered Failsafe mode.
- A low battery level warning is indicated by the Aircraft Status Indicators blinking red slowly or rapidly during flight.
 - Watch our video tutorials for more flight information.
-

Video Suggestions and Tips

1. Go through the full pre-flight checklist before each flight.
2. Select the desired gimbal operation mode in the DJI GO 4 app.
3. Only shoot video when flying in P Mode.
4. Always fly in good weather and avoid flying in rain or heavy wind.
5. Choose the camera settings that suit your needs. Settings include photo format and exposure compensation.
6. Perform flight tests to establish flight routes and preview scenes.
7. Push the control sticks gently to keep the aircraft's movement smooth and stable.

Calibrating the Compass

Only calibrate the compass when the DJI GO 4 app or the status indicator prompt you to do so. Observe the following rules when calibrating your compass:

-
-  • DO NOT calibrate your compass where there is a chance of strong magnetic interference, such as near magnetite, parking structures, or steel reinforcements underground.
- DO NOT carry ferromagnetic materials with you during calibration such as cellular phones.
 - The DJI GO 4 app will notify you if the compass is affected by strong interference after calibration is complete. Follow the prompts to resolve the compass issue.
-

Calibration Procedures

Choose an open area to carry out the following procedures.

1. Tap the Aircraft Status Bar in the app and select "Calibrate", then follow the on-screen instructions.
2. Hold the aircraft horizontally and rotate 360 degrees. The Aircraft Status Indicators will go solid green.

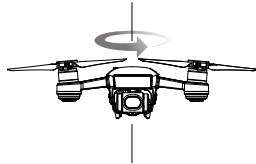

3. Hold the aircraft vertically, with the nose pointing downward, and rotate it 360 degrees around the center axis.

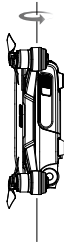

4. Re-calibrate the aircraft if the aircraft status indicators blink red.



• If the Aircraft Status Indicators blink red and yellow after the calibration procedure, move your aircraft to a different location and try again.



• DO NOT calibrate the compass near metal objects such as a metal bridge, cars, scaffolding.
• If the aircraft status indicator is blinking red and yellow alternately after placing the aircraft on the ground, the compass has detected magnetic interference. Change your location.

Firmware Updates

Use DJI GO 4 or DJI Assistant 2 to update aircraft firmware. Only DJI GO 4 can be used to update remote controller firmware.

Using the DJI GO 4 App

Connect the aircraft and remote controller and the DJI GO 4 app. You will be reminded if a new firmware upgrade is available. To start upgrading, connect your mobile device to the Internet and follow the on-screen instructions.

Using DJI Assistant 2

Internet and follow the instructions below to update the firmware through DJI Assistant 2:

1. With the aircraft powered off, connect the aircraft to a computer via the Micro USB port using a Micro USB cable.
 2. Power on the aircraft.
 3. Launch DJI Assistant 2 and login with your DJI account.
 4. Select Spark and click on Firmware Updates on the left panel.
 5. Select the firmware version that you wish to update.
 6. Wait for the firmware to be downloaded and the firmware update will start automatically.
 7. Reboot the aircraft after the firmware update is complete.
-

-  • Ensure the aircraft is connected to your computer before powering on.
- The firmware update will take around 15 minutes. It is normal that the gimbal goes limp, aircraft status indicators blink abnormally, and the aircraft reboots. Please wait patiently until the update is complete.
 - Ensure the computer has access to the Internet.
 - Ensure the Intelligent Flight Battery has at least 50% power and the remote controller has at least 30% power.
 - Do not disconnect the aircraft from the computer during an update.
-

Appendix

Appendix

Specifications

Aircraft	
Weight	300 g
Dimensions	143×143×55 mm
Diagonal Length (propellers excluded)	170 mm
Max Ascent Speed	9.8 ft/s (3 m/s) in Sport Mode
Max Descent Speed	9.8 ft/s (3 m/s) when using auto landing
Max Speed	31 mph (50 kph) in Sport Mode without wind
Max Service Ceiling Above Sea Level	13123 feet (4000 m)
Max Flight Time	16 minutes (0 wind at a consistent 15.5 mph (25 kph))
Max Hovering Time	15 minutes (0 wind)
Operating Temperature	32° to 104° F (0° to 40° C)
GNSS	GPS/GLONASS
GPS Hover Accuracy Range	Vertical: ±0.1 m (With Vision Positioning); ±0.5 m (With GPS Positioning) Horizontal: ±0.3 m (With Vision Positioning); ±1.5 m (With GPS Positioning)
Transmitter Power (EIRP)	2.4G FCC: 25dBm; CE: 18dBm; SRRC: 18dBm 5.8G FCC: 27dBm; CE: 14dBm; SRRC: 27dBm
Operation Frequency	2.400-2.4835GHz; 5.725-5.825GHz
Gimbal	
Controllable Range	Pitch: -85°to 0°
Stabilization	2-axis (pitch, roll)
3D Sensing System	
Sensing Range	0.6 - 16 ft (0.2 - 5 m)
Operating Environment	Surface with diffuse reflection material, size > 20×20 mm and reflectivity > 20% (such as wall, trees, humans, etc.)
Vision System	
Velocity Range	≤ 22.4 mph (36 kph) at 6.6 ft (2 m) above ground
Altitude Range	0 - 26 feet (0 - 8 m)
Operating Range	0 - 98 feet (0 - 30 m)
Operating Environment	Surfaces with a clear patterns and diffuse reflection material, reflectivity > 20%, adequate lighting (lux > 15)
Camera	
Sensor	1/2.3" CMOS; Effective pixels: 12 Megapixels
Lens	81.9° FOV, 25 mm (35 mm format equivalent), f/2.6 Shooting Range: 2 m to ∞

ISO Range	100-3200 (video), 100-1600 (photo)
Electronic Shutter Speed	2 - 1/8000 s
Max Image Size	3968 × 2976
Still Photography Modes	Single shot Burst shooting: 3 frames Auto Exposure Bracketing (AEB): 3 bracketed frames at 0.7EV Bias Interval (2/3/5/7/10/15/20/30/60 s)
Video Recording Modes	FHD: 1920×1080 30p
Video Storage Bitrate	24 Mbps
Supported File System	FAT32
Photo	JPEG
Video	MP4 (MPEG-4 AVC/H.264)
Supported SD Cards	Recommended Model: Sandisk 16/32 GB UHS-1 Micro SDHC Kingston 16/32 GB UHS-1 Micro SDHC Samsung 16/32 GB UHS-I Micro SDHC Sandisk 64 GB UHS-1 Micro SDXC Kingston 64 GB UHS-1 Micro SDXC Samsung 64 GB UHS-I Micro SDXC
Wi-Fi	
Operating Frequency	2.4G / 5.8G
Max Transmission Distance (Unobstructed, free of interference)	100 m (Distance), 50 m (Height)
Remote Controller	
Operating Frequencies	2.412-2.462 GHz, 5.745-5.825 GHz
Max Transmission Distance (Unobstructed, free of interference)	2.4 GHz FCC: 1.2 mi (2 km), CE: 0.31 mi (0.5 km), SRRC: 0.31 mi (0.5 km) 5.8 GHz FCC: 1.2 mi (2 km), CE: 0.19 mi (0.3 km), SRRC: 0.75 mi (1.2 km)
Operating Temperature Range	32° - 104° F (0° - 40° C)
Built-in Battery	2970 mAh
Transmitter Power (EIRP)	2.4 GHz FCC: ≤26 dbm, CE: ≤18 dBm, SRRC: ≤18 dBm 5.8 GHz FCC: ≤28 dbm , CE:≤14 dBm, SRRC: ≤26 dBm
Operating Voltage	950 mA @3.7 V
Supported Mobile Device Size	Thickness supported: 6.5 mm - 8.5 mm Max length: 160 mm
Charger	
Input	100-240V, 50/60Hz, 0.5A
Output	5V/3A, 9V/2A, 12V/1.5A

Intelligent Flight Battery

Capacity	1480 mAh
Voltage	11.4V
Max Charging Voltage	13.05 V
Battery Type	LiPo 3S
Energy	16.87 Wh
Net Weight	Approx. 95 g
Operating Temperature	41° to 104° F (5° to 40° C)

After-Sales Information

Visit the following pages to learn more about After-sales policy and warranty information:

1. After-sales Policy: <http://www.dji.com/service>
2. Refund Policy: <http://www.dji.com/service/refund-return>
3. Paid Repair Service: <http://www.dji.com/service/repair-service>
4. Warranty Service: <http://www.dji.com/service/warranty-service>

DJI Support
<http://www.dji.com/support>

This content is subject to change.

Download the latest version from
<http://www.dji.com/spark>



If you have any questions about this document, please contact DJI
by sending a message to **DocSupport@dji.com**.

SPARK is a trademark of DJI.
Copyright © 2017 DJI All Rights Reserved.