



by Schneider Electric

Smart-UPS™ Installation Guide

750/1000/1500/2200/3000 VA 120/230 Vac

500 VA 100 Vac Tower

Important Safety Messages

Read the instructions carefully to become familiar with the equipment before trying to install, operate, service or maintain it. The following special messages may appear throughout this manual or on the equipment to warn of potential hazards or to call attention to information that clarifies or simplifies a procedure.



The addition of this symbol to a Caution product safety label indicates that an electrical hazard exists which will result in personal injury if the instructions are not followed.

The following safety messages may appear throughout this manual to warn of potential hazards.

CAUTION

CAUTION indicates a potentially hazardous situation which, if not avoided, **can result in** equipment damage and minor or moderate injury.

CAUTION

CAUTION indicates a potentially hazardous situation which, if not avoided, **can result in** equipment damage.

Safety and General Information

Inspect the package contents upon receipt. Notify the carrier and dealer if there is any damage.

Read the Safety Guide supplied with this unit before installing the UPS.

- Adhere to all national and local electrical codes.
- This UPS is intended for indoor use only.
- Do not operate this UPS in direct sunlight, in contact with fluids, or where there is excessive dust or humidity.
- Be sure the air vents on the UPS are not blocked. Allow adequate space for proper ventilation.
- The battery typically lasts for two to five years. Environmental factors impact battery life. Elevated ambient temperatures, poor quality utility power, and frequent short duration discharges will shorten battery life.
- Connect the UPS power cable directly to a wall outlet. Do not use surge protectors or extension cords.
- The equipment is heavy. Always practice safe lifting techniques adequate for the weight of the equipment.
- The model and serial numbers are located on a small, rear panel label. For some models, an additional label is located on the chassis under the front bezel.
- Always recycle used batteries.
- Recycle the package materials or save them for reuse.

Inventory

All models



(1) Documentation CD

120/230 Vac models

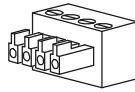

(1)

120/230 Vac models



(1) PowerChute software CD

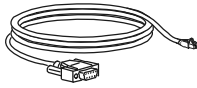

(1)

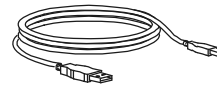

(1)

230 Vac models

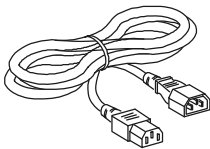

(2)

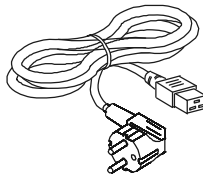

2200/3000 VA models
(1)

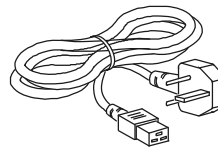

2200/3000 VA models
(1)

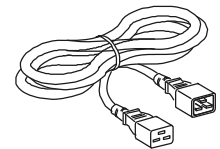

2200/3000 VA models
(1)

Rear panel features 500 VA to 1500 VA models

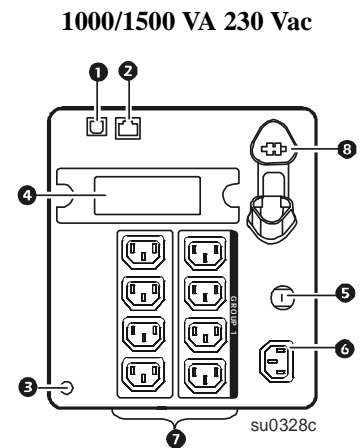
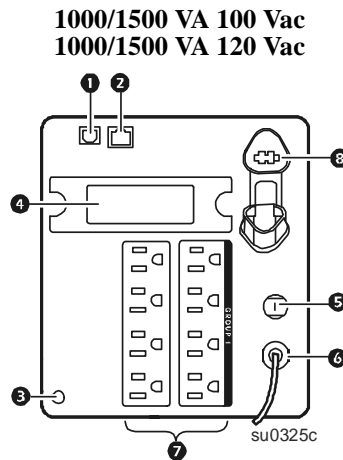
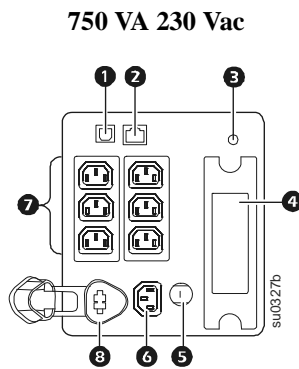
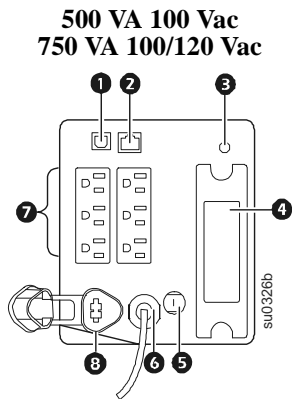

- ❶ USB port
- ❷ RJ45 connector - serial UPS monitoring port
- ❸ Chassis ground screw
- ❹ SmartSlot for optional NMC accessory card
- ❺ Circuit breaker/Overload protection
- ❻ UPS input
- ❼ Outlets
- ❽ Internal or external battery connector

Rear panel features 2200 VA / 3000 VA models

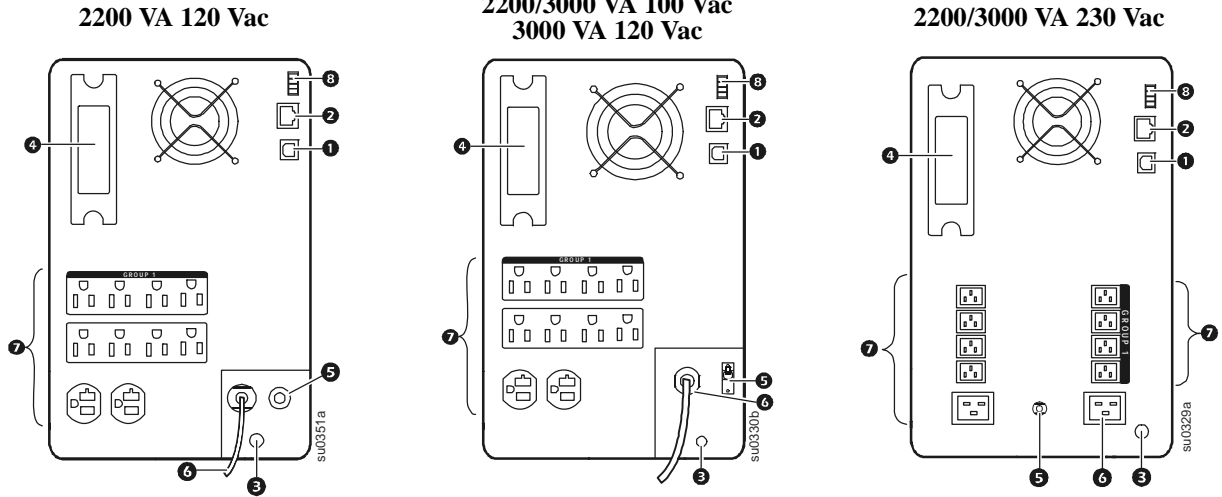

- ❶ USB port
- ❷ RJ45 connector - serial UPS monitoring port
- ❸ Chassis ground screw
- ❹ SmartSlot for optional NMC accessory card
- ❺ Circuit breaker/Overload protection
- ❻ UPS input
- ❼ Outlets
- ❽ EPO connector

Installation

500/750/1000/1500 VA models
Connect the battery

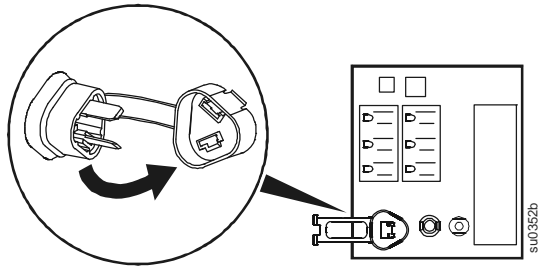

2200/3000 VA models
Remove the bezel

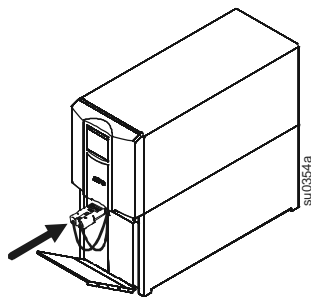
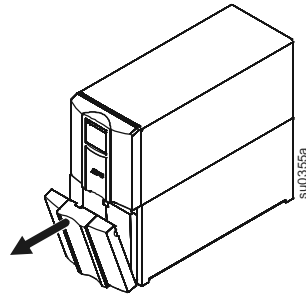

Insert the battery connector into the battery jack and push firmly. A snap will be felt as the connector partially engages the jack. A second snap will be felt as the connector securely seats in the battery jack.

Electrical connections

CAUTION

RISK OF EQUIPMENT DAMAGE

- Adhere to all national and local electrical codes.
- Wiring should be performed by qualified electrician.
- Always connect the UPS to a grounded outlet.

Failure to follow these instructions can result in equipment damage

Plug type and connector locations may vary.

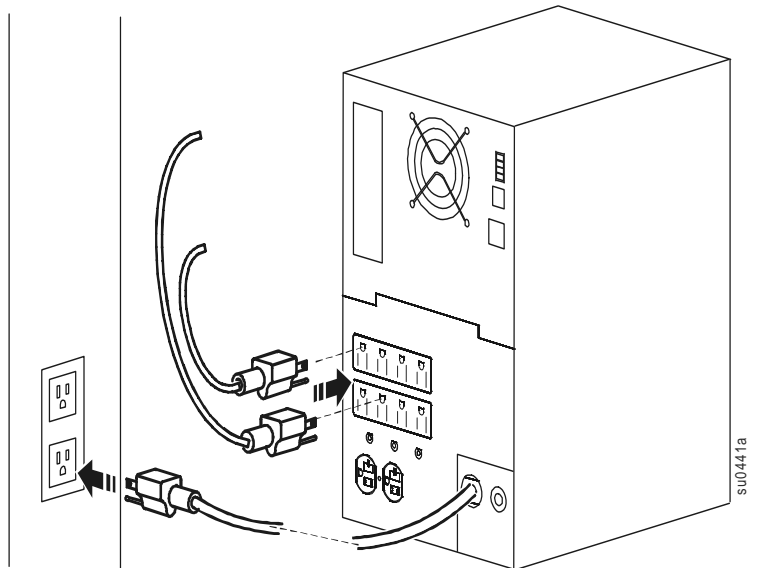

Display panel features

- 1 Online LED
- 2 UPS ON/OFF key
- 3 On Battery LED
- 4 Fault LED
- 5 Replace Battery LED
- 6 Display interface
- 7 UP/DOWN arrow keys
- 8 ENTER key
- 9 ESC key

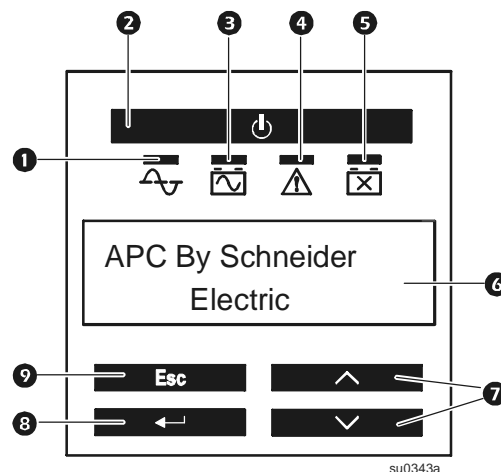

Controlled outlet groups

Some UPS models have one bank of outlets that can function as a controlled group. Use the display interface to configure the controlled outlet features, navigate to:

Main Menu > Control > Outlet1 Control.

Refer to **Rear panel features** on pages 2 and 3 for model specific outlet groups.



Select models are ENERGY STAR[®] qualified.

For more information go to www.apc.com/site/recycle/index.cfm/energy-efficiency/energy-star/