



# MacBook Air (M1, 2020)

## Repair Manual

# Contents

3 [Introduction](#)

## Basics

6 [Exploded View and Orderable Parts](#)

10 [Screws](#)

12 [Tools](#)

## Safety

16 [Battery Safety](#)

## Procedures

19 [First Steps](#)

21 [Keys](#)

47 [Bottom Case](#)

55 [Input/Output Board](#)

61 [Logic Board](#)

70 [Speakers](#)

79 [Trackpad and Input Device Flex Cable](#)

92 [Audio Board](#)

98 [Audio Board Flex Cable](#)

101 [Embedded DisplayPort Flex Cable with Connector Cowling](#)

104 [Antenna Module](#)

112 [Display](#)

118 [Battery](#)

134 [Touch ID Board](#)

144 [Top Case with Keyboard](#)



# Introduction

This manual includes technical instructions for replacing genuine Apple parts in Mac and is intended for individual technicians with the knowledge, experience, and tools required to repair electronic devices.

## Important

- Read the entire manual first. If you're not comfortable performing the repairs as instructed in this manual, don't proceed.
- Always use the latest version of this document available at [support.apple.com/en\\_US/manuals/mac+repair+manual](https://support.apple.com/en_US/manuals/mac+repair+manual).



## Warning

Failure to follow the repair instructions or to use genuine Apple parts or proper tools may cause fire or other safety issues and lead to personal injury or death.



## Caution

Failure to follow the repair instructions or to use genuine Apple parts or proper tools may damage the Mac, parts, or other property, or compromise the device's functionality.

## Warranty information

Damage caused by repairs performed outside of Apple or the Apple Authorized Service Provider network is not covered by Apple's warranty or AppleCare plans. Such damage may cause future repairs to be subject to out-of-warranty costs or render the device ineligible for future repairs by Apple or Apple Authorized Service Providers.

## Tools and parts

### Hardware tools

Apple tools are designed to apply the appropriate force and torque during repairs, and to withstand high-volume professional use.

The iPhone display press applies the appropriate amount of pressure to secure new adhesive during battery installation. The iPhone display press is used with a battery support frame and press plate designed for the device's specific dimensions.

### Ordering tools and parts

You can learn how to order genuine Apple parts and tools at [support.apple.com/self-service-repair](https://support.apple.com/self-service-repair). During the purchase process, enter the manual ID **JFDNFL** to indicate that you've read this manual in its entirety and agree that you have the knowledge and experience to perform your intended repair.

### Software tools

[Apple Diagnostics](#) can check your Mac for hardware issues.

A System Configuration step may be required at the end of your repair. System Configuration is a postrepair software tool that completes the repair for genuine Apple parts. Running System Configuration has a number of purposes that vary based on the part replaced.

What System Configuration does	Why it's important
<b>Updates replacement logic board with device serial number</b>	Replacement logic boards must be updated with your device's serial number to ensure that Apple Pay, FaceTime, iMessage, and iCloud services, such as Find My, can communicate safely and securely with your device.
<b>Transfers factory calibration values</b>	Certain parts like displays, cameras, and ambient light sensors have calibration values that are customized to each individual part during manufacturing. Transferring these values ensures maximum performance and quality after a repair.
<b>Links Secure Enclave and biometric authentication parts</b>	After repair of a logic board or a biometric authentication part (Touch ID), linking the biometric sensors to the Secure Enclave on the logic board is required to ensure device security.
<b>Ensures repair integrity</b>	After a hardware repair, software checks are performed to ensure repair integrity. Repair integrity means that a genuine Apple part has been correctly installed.
<b>Assigns wireless region</b>	To comply with regional communications regulations, a wireless region must be assigned to your logic board.
<b>Updates firmware</b>	Keeping firmware up to date ensures that the device has all the latest security and performance features.

System Configuration requires a strong Wi-Fi network capable of 1.0 Mbps download and upload speeds, with less than 400 ms latency and less than 2% packet loss. Estimated data usage to run System Configuration is 6–22 MB.

The device must be running the latest version of macOS and not a beta version.

Learn how to initiate the System Configuration process at [support.apple.com/self-service-repair](https://support.apple.com/self-service-repair).

## Alerts

Failure to follow alerts could result in fire, injury, data loss, or damage to the device, parts, or other property.



### **Danger**

Instructions for reducing risk of electric shock and electrocution



### **Warning**

Instructions for reducing risk of personal injury



### **Caution**

Instructions for reducing risk of data loss or device hardware damage

### **Important**

Supplemental information for successfully completing procedures; neither a Warning nor a Caution

# Exploded View and Orderable Parts

This section shows parts, part names, and part numbers for MacBook Air (M1, 2020).

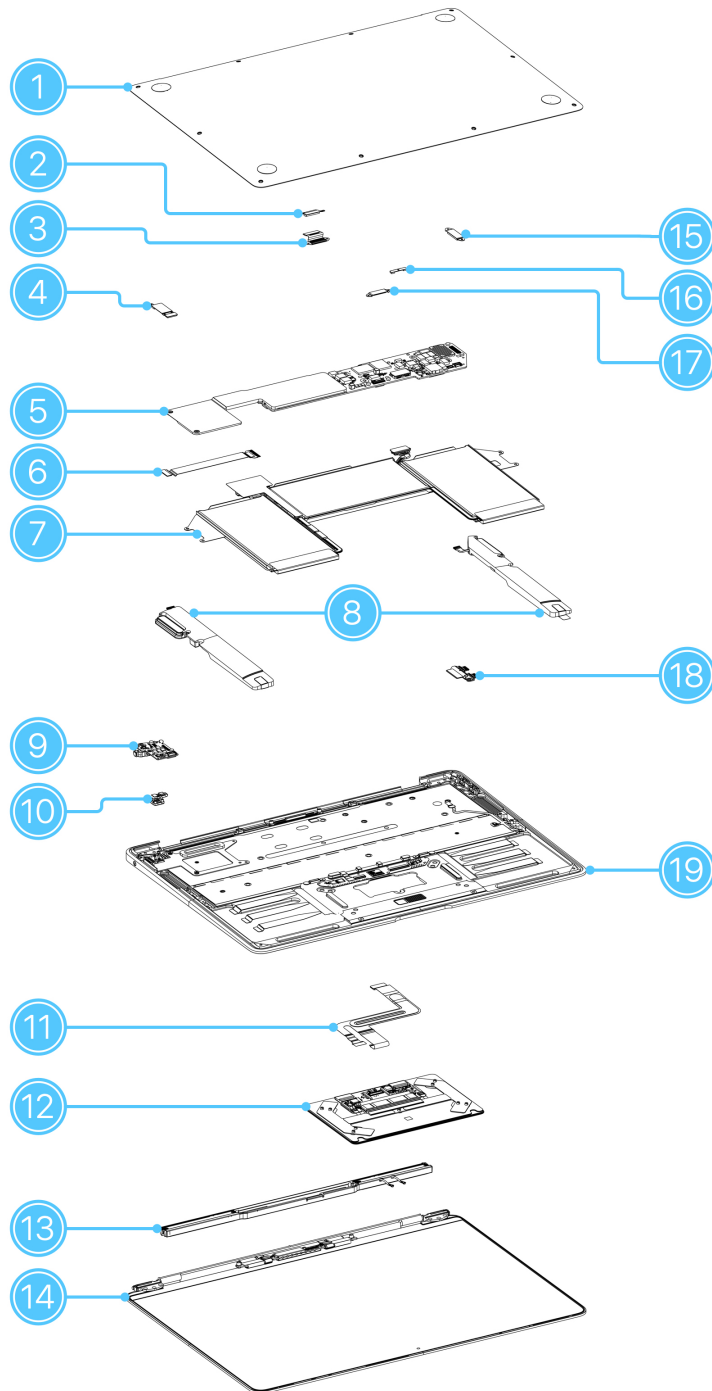

Part Name	Number
<b>1. Bottom case</b>	923-04300, 7-core GPU, space gray 923-04301, 8-core GPU, space gray 923-04302, 7-core GPU, silver 923-04303, 8-core GPU, silver 923-04304, 7-core GPU, gold 923-04305, 8-core GPU, gold
<b>2. Embedded DisplayPort connector cowling</b>	923-04010
<b>3. Embedded DisplayPort flex cable with connector cowling</b>	923-04718
<b>4. Audio board/speaker/Touch ID board connector cowling</b>	923-00604
<b>5. Logic board</b>	661-16809 or 661-27558, M1, 8-core CPU, 7-core GPU, 8 GB, 128 GB 661-16810 or 661-27559, M1, 8-core CPU, 7-core GPU, 8 GB, 256 GB 661-16811 or 661-27560, M1, 8-core CPU, 7-core GPU, 8 GB, 512 GB 661-16812 or 661-27561, M1, 8-core CPU, 7-core GPU, 8 GB, 1 TB 661-16813 or 661-27562, M1, 8-core CPU, 7-core GPU, 8 GB, 2 TB 661-16814 or 661-27563, M1, 8-core CPU, 7-core GPU, 16 GB, 128 GB 661-16815 or 661-27564, M1, 8-core CPU, 7-core GPU, 16 GB, 256 GB 661-16816 or 661-27565, M1, 8-core CPU, 7-core GPU, 16 GB, 512 GB 661-16817 or 661-27566, M1, 8-core CPU, 7-core GPU, 16 GB, 1 TB 661-16818 or 661-27567, M1, 8-core CPU, 7-core GPU, 16 GB, 2 TB 661-16819 or 661-27570, M1, 8-core CPU, 8-core GPU, 8 GB, 512 GB 661-16820 or 661-27571, M1, 8-core CPU, 8-core GPU, 8 GB, 1 TB 661-16821 or 661-27572, M1, 8-core CPU, 8-core GPU, 8 GB, 2 TB 661-16822 or 661-27575, M1, 8-core CPU, 8-core GPU, 16 GB, 512 GB 661-16823 or 661-27576, M1, 8-core CPU, 8-core GPU, 16 GB, 1 TB 661-16824 or 661-27577, M1, 8-core CPU, 8-core GPU, 16 GB, 2 TB
<b>6. Audio board flex cable</b>	923-03663

Part Name	Number
<b>7. Battery</b>	661-16086
<b>8. Speakers</b>	923-03678
<b>9. Audio board</b>	923-03672, space gray or gold 923-03673, silver
<b>10. Touch ID board</b>	661-15412
<b>11. Input device flex cable</b>	923-04008
<b>12. Trackpad</b>	661-16825, space gray 661-16826, silver 661-16827, gold
<b>13. Antenna module</b>	923-04327
<b>14. Display</b>	661-16806, space gray 661-16807, silver 661-16808, gold
<b>15. Input/output board connector cowling</b>	923-04034
<b>16. Antenna connector cowling</b>	923-03994
<b>17. Input device connector cowling</b>	923-03995
<b>18. Input/output board</b>	923-03553
<b>19. Top case with keyboard</b> Read the Important alert on the next page to ensure that you order the correct top case.	661-16831, space gray 661-16833, silver 661-16835, gold
Part Name (Not Shown)	Number
<b>Battery and speaker adhesive</b>	076-00467
<b>Antenna gasket and tape</b>	076-00497

## Important









The English (US) top case part number begins with 661. Other regional top case part numbers also begin with 661, but they include a language prefix. For example, the Italian top case part number begins with T661. To determine the correct language prefix, [identify your keyboard language by country or region](#). Then identify the correct country code from the language prefix list below:

AB	Arabic	GR	Greek	RS	Russian
B	British	H	Norwegian Bokmal	S	Swedish
BG	Bulgarian	HB	Israeli	SF	Swiss French
C	Canadian French	IS	Icelandic	SL	Slovak
CH	Chinese (Pinyin)	J	Japanese	T	Italian
CR	Croatian	KH	Korean	TA	Chinese (Zhuyin)
CZ	Czech	LA	Latin America	TH	Thai
D	German	MG	Hungarian	TQ	Turkish-Q
DK	Danish	N	Dutch	TU	Turkish-F
E	Western Spanish	PO	Portuguese	Z	English International
F	French	RO	Romanian		

# Screws

## Caution

- Save undamaged screws and cowlings for reassembly.
- Note the location of screws and cowlings during removal. Then organize them to ensure that you reinstall them in the correct location.
- Both overtightened screws and loose screws can damage parts.

<p><b>923-02880</b> Torx® T5</p> <p>Trackpad, inner corners (4) Trackpad, outer corners (4)</p> 	<p><b>923-02884</b> Torx T3</p> <p>Audio board (1)</p> 	<p><b>923-02888</b> Torx T3</p> <p>Touch ID board flexible cowling (6)</p> 	<p><b>923-02890</b> Torx T3</p> <p>eDP flex cable with connector cowling (2)</p> 
<p><b>923-03002</b> Torx T5</p> <p>Trackpad, middle (1)</p> 	<p><b>923-03679</b> Torx T5</p> <p>TCON board (2)</p> 	<p><b>923-03680</b> Torx T3</p> <p>Battery tray (2)</p> 	<p><b>923-03850</b> Torx T3</p> <p>Speakers (2)</p> 
<p><b>923-03975</b> Torx T5</p> <p>I/O board (2)</p> 	<p><b>923-03997</b> Torx T8</p> <p>Display hinges (6)</p> 	<p><b>923-03999</b> Torx T5</p> <p>Logic board (3)</p> 	<p><b>923-04003</b> Torx T3</p> <p>Antenna connector cowling (1) Audio board connector cowling (3) I/O board connector cowling (2) IPD connector cowling (2)</p> 



**923-04004**

Torx T3

eDP connector cowling (2)

**923-04005**

Torx T5

Audio board (2)

**923-04007**

Torx T5

Logic board (1)

**923-04700**

Torx T5

Antenna module (4)

**923-05164, space gray****923-05167, silver****923-05170, gold**

Pentalobe

Bottom case, rear corners (2)

**923-05165, space gray****923-05168, silver****923-05171, gold**

Pentalobe

Bottom case, front corners, middle front and sides (6)

**923-05166, space gray****923-05169, silver****923-05172, gold**

Pentalobe

Bottom case, middle rear (2)

**923-05305**

Torx T5

Logic board (2)



## Tools

Tools with part numbers are available for purchase from the Self Service Repair Store. Tools without part numbers can be purchased from electronics supply retailers.

**923-02995**

Adjustable torque driver  
(10–34 Ncm)



**923-0735**

Adjustable torque driver  
(0.3–1.2 Nm)



**923-01322**

Antenna tool



**076-00467**

Battery and speaker  
adhesive

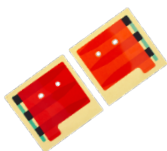

**923-03021**

Battery cover



**923-03007**

Battery support frame and  
press plate

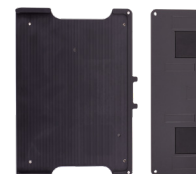

Compressed air



EarPods with 3.5 mm  
headphone plug



ESD mat



ESD-safe cleaning solution



ESD-safe tweezers



ESD wrist strap with clip  
or plug



Ethanol wipes<sup>1</sup>



Fireproof enclosure



923-02998  
Gap offset kit



Heat-resistant gloves



IPA wipes



661-08916  
iPhone display press



922-1731  
Kapton tape



923-01803  
Keycap lever



Magnetizer



Microterry polishing cloth



Needle-nose pliers



922-5065  
Nylon probe (black stick)



**923-0731**  
Pentalobe screwdriver



Permanent marker



**923-01800**  
Precut adhesive strips  
(1x0.5)

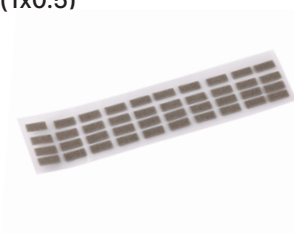

**923-01801**  
Precut adhesive strips (1x1)

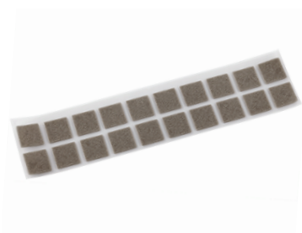

Safety glasses with side shields



Sand<sup>2</sup>



Sand container<sup>3</sup>



Sticky notes (3 by 3 inches)



**922-8252**  
Suction cups



Torx T3 screwdriver



**923-02996**  
Torx T5 bit



Torx T5 screwdriver



Torx T8 screwdriver



923-03032  
Touch ID alignment kit

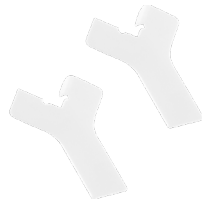

661-06670  
USB-C charge cable



<sup>1</sup> Ethanol wipes must contain at least 90% ethanol and no additives except isopropyl alcohol.

<sup>2</sup> Clean, dry, untreated sand (8–10 cups)

<sup>3</sup> Sand container (wide-mouthed, quick pour, nonbreakable plastic container with a flip-top lid)

# Battery Safety

## **Warning**

- This device contains a built-in lithium-ion rechargeable battery with soft battery cells. Battery safety is the number one concern when repairing a device with a built-in lithium-ion battery.
- Only technicians with the knowledge, experience, and tools required to repair electronic devices should replace a battery.
- Improper battery replacement, improper handling of parts, failure to discharge the battery before repair, or failure to follow the provided instructions could cause battery overheating, swelling, venting, leaking, or a battery thermal event. These events could result in fire, injury, death, data loss, or damage to the device, parts, or other property.
- To avoid these potentially harmful events, follow the battery safety guidelines and work in a safety-focused workspace with the tools listed below. It's important to be prepared for all possible outcomes.

## How to set up a workspace for battery safety

### Tools

- Clean, dry, untreated sand (8–10 cups)
- Sand container (wide-mouthed, quick pour, nonbreakable plastic container with a flip-top lid)
- Heat-resistant gloves
- Safety glasses with side shields
- ESD-safe cleaning solution
- Fireproof enclosure

Workspaces used to repair Apple devices should meet the following criteria:

- Nonflammable and electrostatic discharge (ESD)-safe work bench
- At least 2 feet away from paper and other combustible materials
- Sand container within reach (2 feet) on one side of the workspace, not above the workspace
- Adequate ventilation
- Within 20 feet of a fireproof enclosure. Don't store combustible or flammable materials in the enclosure. Ensure that the enclosure remains empty.



## How to handle a battery thermal event

A battery thermal event is a rapid chemical chain reaction that occurs inside a battery cell. The energy stored in the battery is released suddenly, which can cause outgassing and fire. A battery thermal event can be triggered by physical damage to the battery, improper replacement or repair, or temperatures outside the battery's operating range.

Act immediately if you notice any of the following signs of a battery thermal event:

- The lithium-ion battery or a device that contains one begins to smoke or emit sparks or soot.
- The battery pouch suddenly and quickly puffs out.
- The lithium-ion battery or a device that contains one begins to emit hissing or popping sounds.

Do smother the battery or device immediately with plenty of clean, dry sand. Dump the sand all at once. Timing is critical — the faster you pour all the sand, the sooner the reaction will be contained.

Do contact local fire authorities if further assistance is needed.

Do leave the room for 30 minutes after the reaction is contained. Ventilate the area. Don't return until the area is clear of smoke.

Do wait 30 minutes before touching the device. Wear the heat-resistant gloves and safety glasses with side shields to remove the device from the sand. Then place the device into the fireproof enclosure. Leave it in the enclosure for at least 2 hours.

Do wipe the affected area with water first. Then wipe the area with an ESD-safe cleaning solution.

Do dispose of the damaged battery or device (including any debris removed from the sand) according to local environmental laws and guidelines.

## How to handle batteries

### Discharge the battery



Fully discharge the battery before you begin a repair. A discharged battery is less susceptible to a battery thermal event. If you can't determine the battery level, don't repair the device.

The following actions will help to discharge the battery:

- Disconnect the power cable.
- Increase display brightness to the highest setting.
- Turn on Wi-Fi and Bluetooth.
- Open the FaceTime app or Photo Booth app to turn on the camera.
- Play a video from the local drive or a streaming service.

### Use a battery cover

Avoid damaging the battery by performing the following actions:

- Immediately after removing the bottom case, follow the instructions to attach the battery cover and disconnect the battery from the logic board.
- Always keep the battery cover on the battery when it's exposed.
- Only remove the battery cover immediately before you install the bottom case, unless otherwise instructed.

### Best practices

- To avoid noxious fumes or a battery thermal event, don't puncture, strike, or crush a lithium-ion battery or a device that contains one.
- Keep your workspace clear of foreign objects and sharp materials.
- Be careful when using sharp tools near the battery.
- Don't leave loose screws, extra screws, or small parts inside the device.
- Don't use tools that conduct electricity.
- Don't throw or drop the battery.
- Don't expose the battery to excessive heat or sunlight, or temperatures outside the battery's operating range.
- Handle and dispose of waste batteries in accordance with local laws and regulations.



# First Steps

## Always perform the following steps before starting a repair:

- [Back up the Mac.](#)
- If replacing the logic board or Touch ID board, turn off Find My Mac. Choose Apple Menu > System Preferences > Apple ID. Select iCloud in the sidebar. Then deselect the Find My Mac checkbox. If you're unable to access the Apple menu, continue performing the following steps.
- [Discharge the battery fully.](#)
- [Turn off the Mac.](#)
- If you were unable to turn off Find My Mac from the Apple menu, go to [iCloud.com/find](https://www.icloud.com/find) on a different device. Select All Devices. Select the device you want to remove. Then select Remove from Account.
- Unplug the power cable from the electrical outlet. Keep the power cable unplugged while the device is being repaired.
- Disconnect all cables.
- Remove all cases and covers.
- Clear and clean your workspace.
- Put on an ESD wrist strap and attach it to a properly grounded ESD mat.



### Caution

ESD (electrostatic discharge, or the release of static electricity) can damage electronic components.

## Be aware of the following while performing a repair:

- The manual for this model may show images of other models, but the procedures are the same. Ensure that you use the correct tools for the model you're repairing.
- Take your time. Thoroughly read all instructions and alerts.
- Magnetizing the screwdrivers will make it easier to work with small screws.
- Use only Kapton tape to secure cables and keep them out of the way when removing and reinstalling parts.
- The end of each flex cable must align with its connector. Press the end of each flex cable to its connector until it clicks to ensure that it's secure.

 **Warning**

Avoid damaging the battery by performing the following actions:

- Immediately after removing the bottom case, follow the instructions to attach the battery cover and disconnect the battery from the logic board.
- Always keep the battery cover on the battery when it's exposed.
- Set aside all parts and screws removed during the repair and account for them at the end of the repair.
- Only remove the battery cover immediately before you install the bottom case, unless otherwise instructed.

# Keys

## Before You Begin

Before you repair or replace a key, you need to:

- Know the different key parts — review the exploded view on this page.
- [Identify your keyboard design.](#)
- [Identify which type of key you're replacing.](#)
- Determine during the keycap removal procedure whether you need to also [replace the key's scissor mechanism.](#)

### Key exploded view

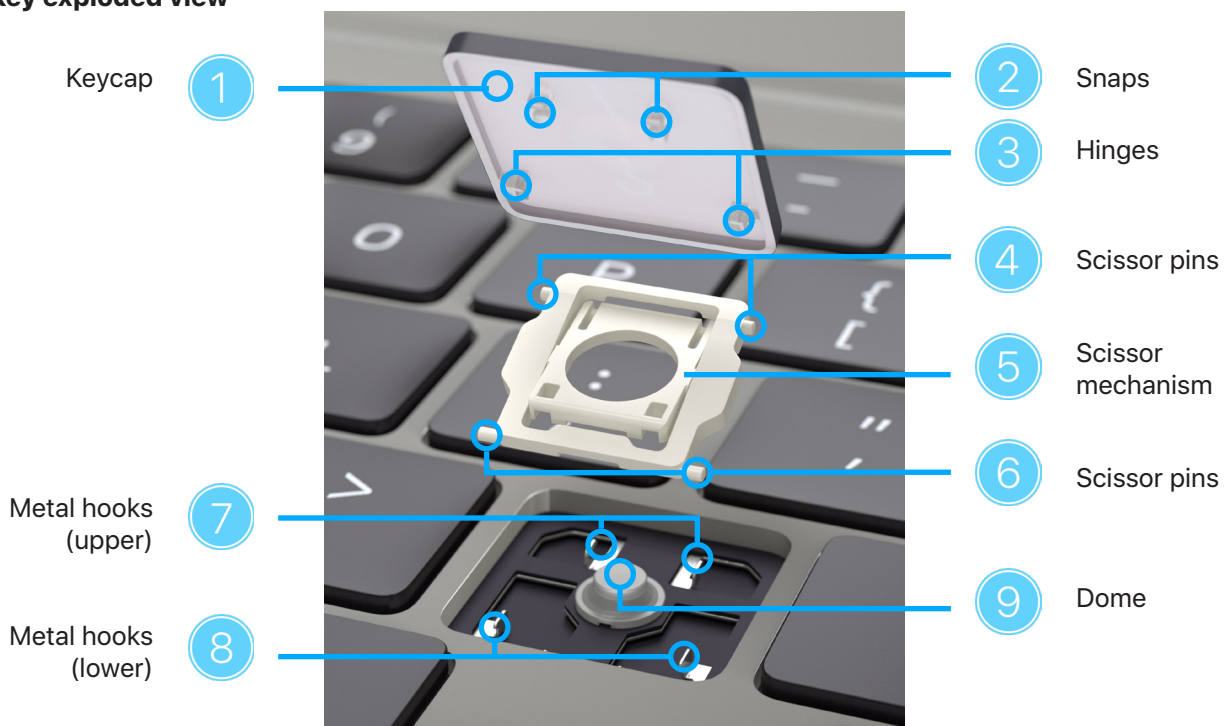

### Tools

- Compressed air
- ESD-safe tweezers
- Keycap levers (Some link bar keycaps require 2 keycap levers for removal)
- Microterry polishing cloth
- Needle-nose pliers
- Nylon probe (black stick)
- Precut adhesive strips (1x0.5)
- Precut adhesive strips (1x1)

Clean the keyboard thoroughly with compressed air before you replace a missing keycap or a keycap on an unresponsive key.

### Caution

- The adhesive on the precut adhesive strips that you'll use to remove keycaps is very strong. If you accidentally place the keycap lever on the wrong keycap, you must remove and replace that keycap.
- An adhesive strip can be used only once. You must replace the adhesive strip for every keycap removal.
- Always replace a keycap that you removed with a new one. Don't reuse keycaps.
- Use gentle pressure on the keycap to activate the adhesive. Do not bend the top case when you press the keycap lever onto the keycap.
- If a keycap replacement doesn't resolve the issue, replace the top case.

### Important

Before you replace a keycap, inspect the scissor mechanism, the dome, and the metal hooks inside the well of the keycap:

- Ensure that the scissor mechanism is installed in the well of the keycap. If not, [install a new scissor mechanism](#).
- Use the black stick to gently move the scissor mechanism up and down (1). Verify that the scissor mechanism moves easily and lies flat when released. If it does not, [replace the scissor mechanism](#).
- Press and release the dome (2) — it should spring back upright. If the dome is damaged or not centered, replace the top case.
- If a lower hook is bent (3), try to bend it back to a 90-degree angle.
- If an upper hook is bent (4), use needle-nose pliers to straighten it.
- If any lower hook or upper hook is broken or bent beyond repair, replace the top case.

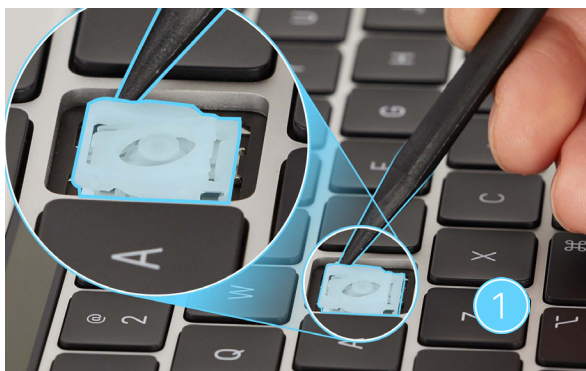

### Keyboard Identification

Determine your keyboard design by comparing your Return key to the images:

ANSI

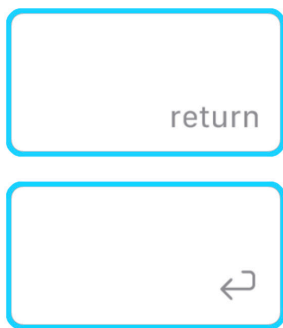

ISO

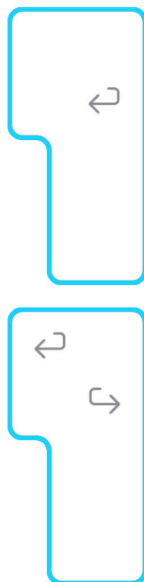

JIS

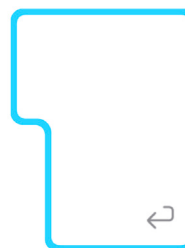

## Key Identification

### [1x1 Keys](#)



### [1x0.5 Keys](#)

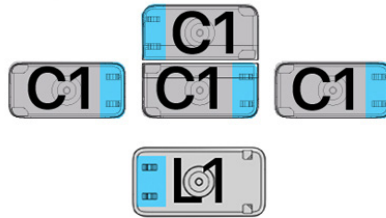

### [Link Bar Keys](#)

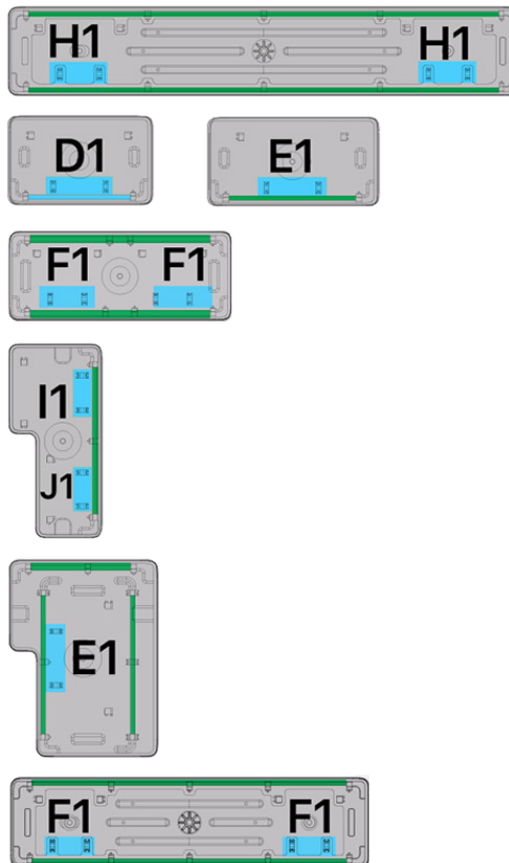

## 1x1 Keys

### Maps

The 1x1 keys are highlighted, and the dark blue bars show the location of snaps.

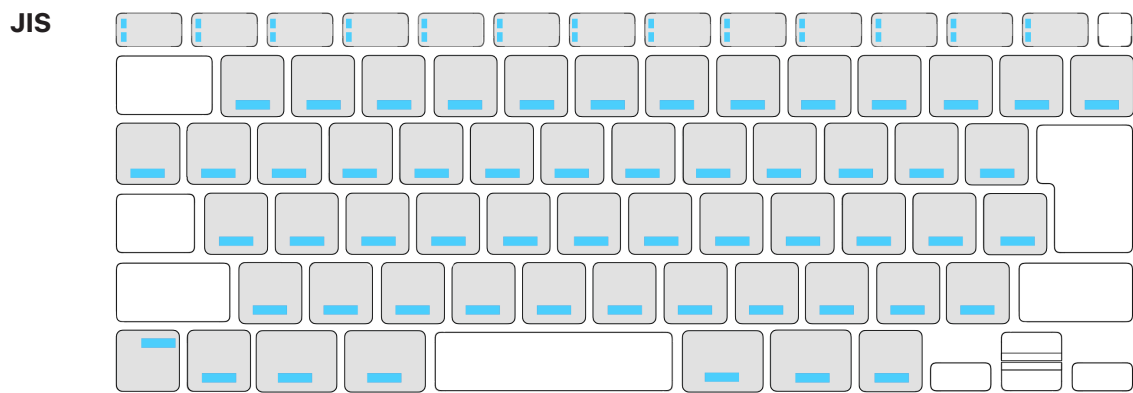
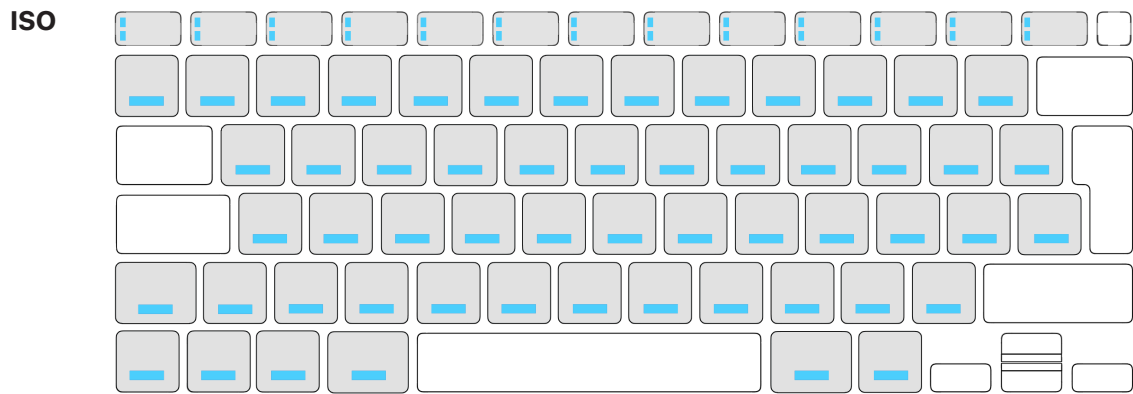
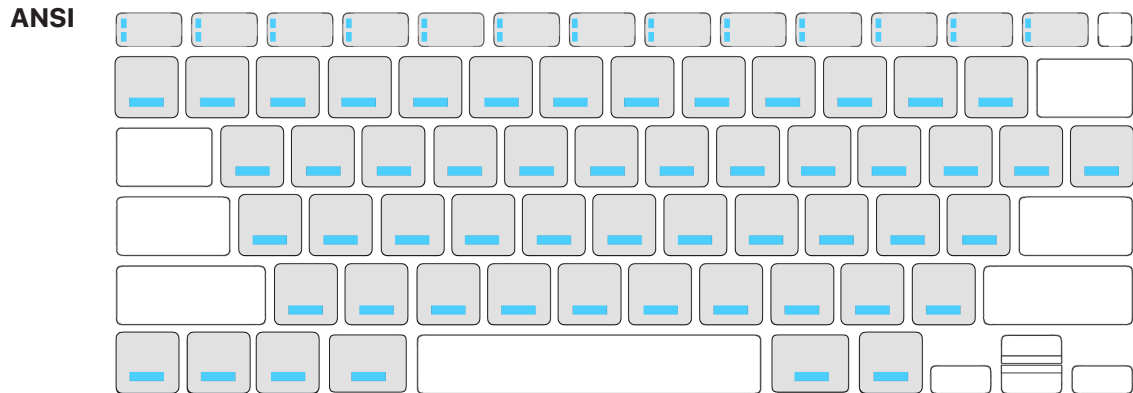

## Removal

1. Peel the frosted liner from one side of the 1x1 precut adhesive strips. Press and hold the large end of the keycap lever on the adhesive for 10 seconds.

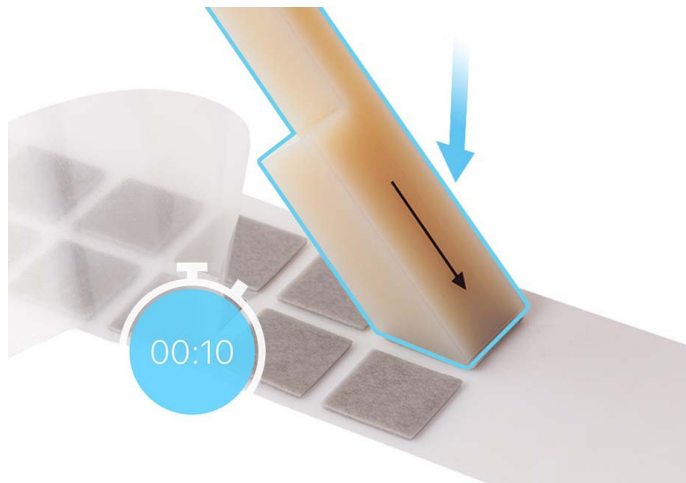

2. Lift the keycap lever and the adhesive to separate them from the white liner.
3. Lightly press the large end of the keycap lever and the adhesive onto the key.

### Important

- The arrow on the lever must point to the hinged side of the keycap, which is opposite of the side that snaps onto the keyboard.
- Use the map for the 1x1 keys to identify the location of each snap.
- On the JIS keyboard, the snaps for the 1x1 Caps Lock key are on the display side of the keycap.



4. Hold the keycap lever on the key for 10 seconds to activate the adhesive.



5. Tilt up the keycap lever in the direction of the arrow until you feel the snaps release.

 **Caution**

To avoid damaging the scissor mechanism, don't tilt up the keycap more than 20 degrees.



6. Lift the keycap off the keyboard.

7. Use the black stick to gently move the scissor mechanism up and down. Ensure that the scissor mechanism moves easily and lies flat when released. If it does not, [replace the scissor mechanism](#).



8. Inspect the well of the keycap:
  - Use the black stick to press and release the dome through the top of the scissor mechanism — the dome should spring back upright. If the dome is damaged or not centered, replace the top case.
  - If a lower hook is bent, try to bend it back to a 90-degree angle.
  - If an upper hook is bent, use needle-nose pliers to straighten it.
  - If any lower hook or upper hook is broken or bent beyond repair, replace the top case.
9. Use compressed air to clean the well of the keycap.

**Note:** If compressed air doesn't dislodge visible debris, use the black stick to gently dislodge it.
10. Remove the keycap and adhesive from the keycap lever. Discard the keycap and adhesive.

## Reassembly

1. Gently push the hinged side of the replacement keycap into the hinged side of the well at a 15-degree angle until the hinges engage.



2. Gently press the top of the keycap to engage the snaps.

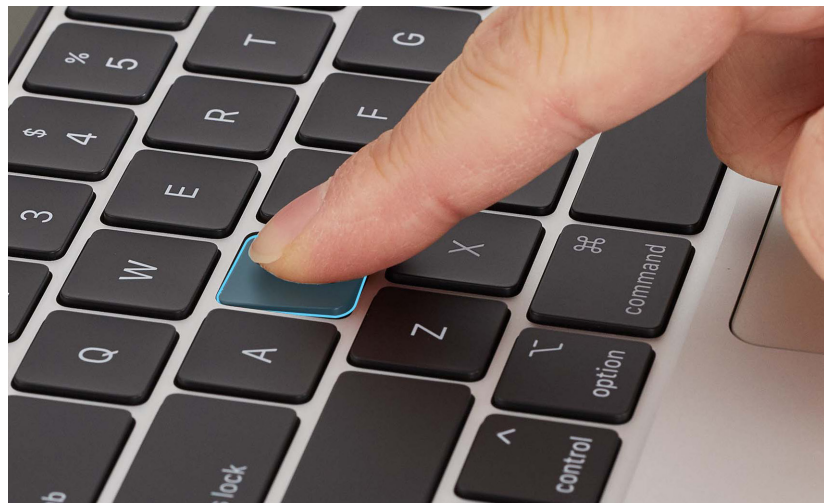

3. Tap the key repeatedly to check that it springs back each time. Compare the response of the new keycap with the response of the keycaps around it.
4. If the keycap doesn't appear to be correctly installed, repeat all removal and reassembly steps with a new keycap.

## 1x0.5 Keys

### Maps

The Escape key, Fn (Function) keys, and Arrow keys are highlighted, and the blue bars show the location of snaps.

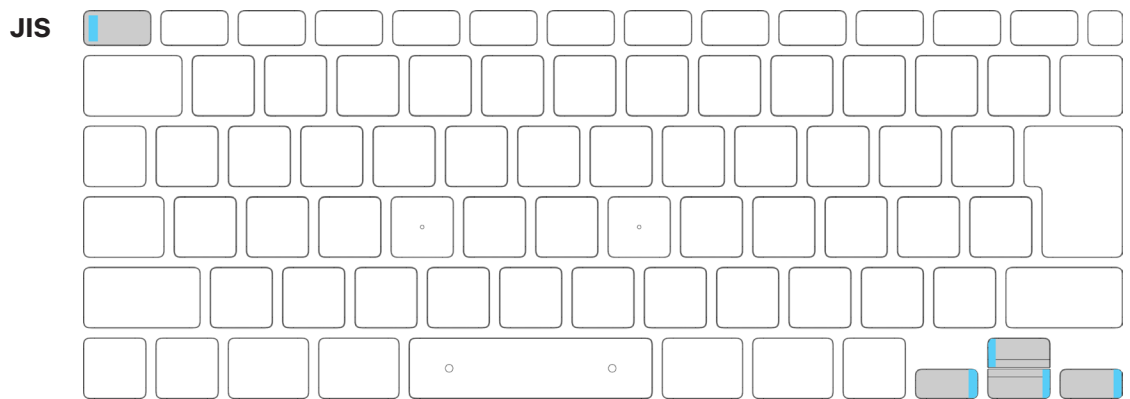
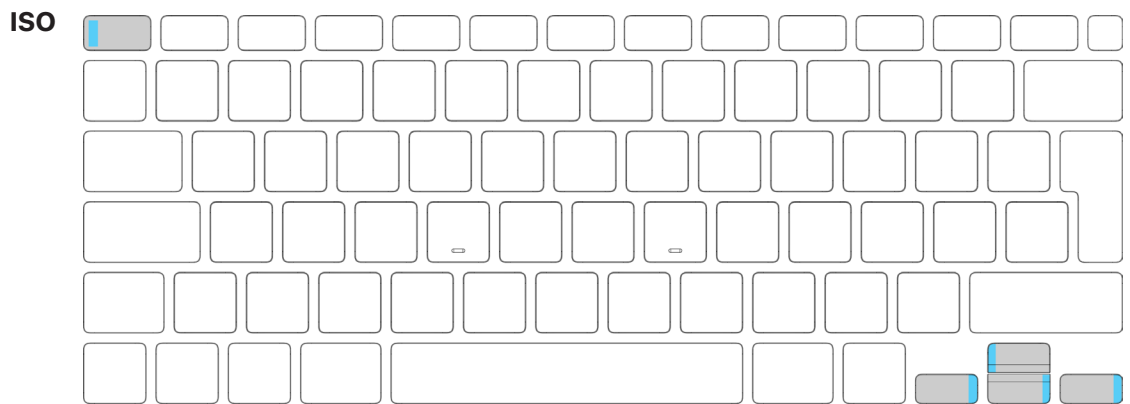
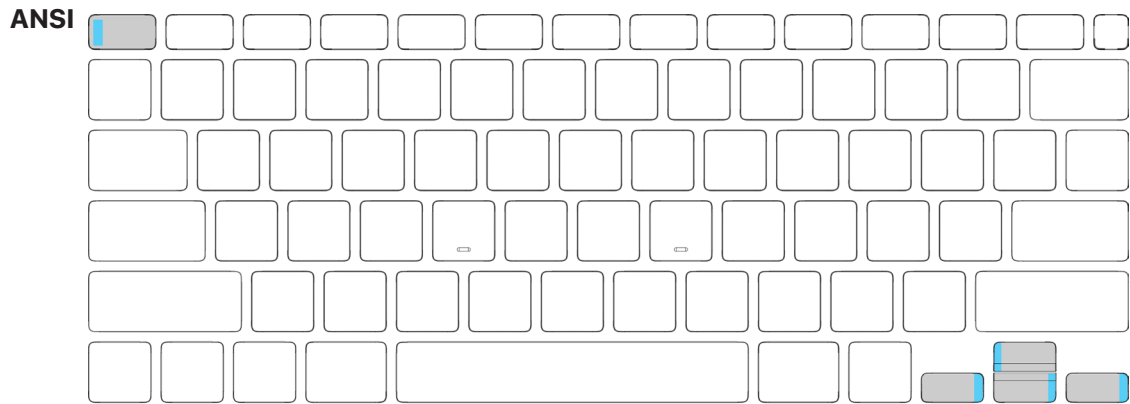

## Removal

### Important

- The hinges of the bottom-row arrow keys are on the left. Point the arrow on the keycap lever toward the left.
- The hinges of the Up Arrow key and Escape key are on the right. Point the keycap lever arrow toward the right.

1. Peel the frosted liner from one side of the 1x0.5 precut adhesive strips. Press and hold the small end of the keycap lever on the adhesive for 10 seconds.

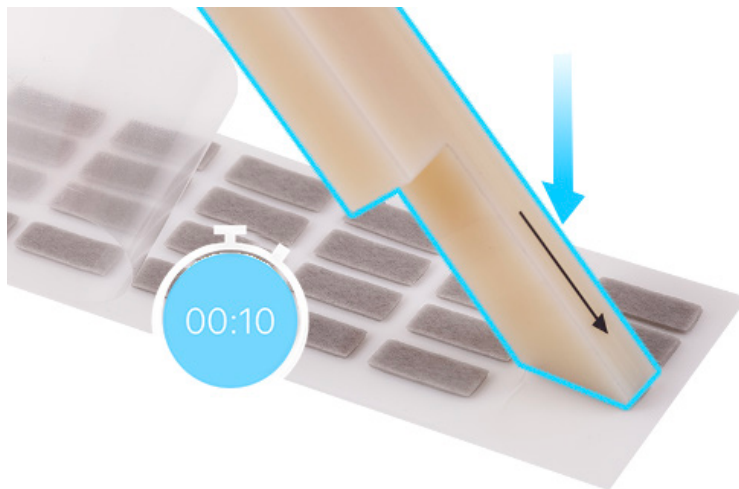

2. Lift the keycap lever and the adhesive to separate them from the white liner.



3. Lightly press the small end of the keycap lever and the adhesive onto the key.

### Important

Point the arrow on the lever toward the hinged side of the keycap, which is opposite of the side that snaps onto the keyboard. You can find the location of the snaps at the [1x0.5 Key Maps](#).

4. Hold the keycap lever on the key for 10 seconds to activate the adhesive.

5. Push the keycap lever toward the arrow and tilt up the lever until you feel the snaps release.

### ⚠ Caution

To avoid damaging the scissor mechanism, don't tilt up the keycap more than 20 degrees.



6. Push the keycap lever toward the hinge to release the keycap (1). Lift the keycap lever to release the keycap from the snaps (2).



7. Inspect the scissor mechanism and well of the keycap:
  - Use the black stick to gently move the scissor mechanism up and down (1). Verify that the scissor mechanism moves easily and lies flat when released. If it does not, [replace the scissor mechanism](#).
  - Use the black stick to press and release the dome through the top of the scissor mechanism — the dome should spring back upright. If the dome is damaged or not centered, replace the top case.
  - If a lower hook is bent, try to bend it back to a 90-degree angle.
  - If an upper hook is bent, use needle-nose pliers to straighten it.
  - If any lower hook or upper hook is broken or bent beyond repair, replace the top case.
8. Use compressed air to clean the well of the keycap.

**Note:** If compressed air doesn't dislodge visible debris, use the black stick to gently dislodge it.
9. Remove the keycap and adhesive from the keycap lever. Discard the keycap and adhesive.

## Reassembly

1. Use the black stick to lift the scissor slightly (1). Insert the hinged side of the replacement keycap into the well at a 15-degree angle as shown (2). Slide the keycap back toward the snap to engage the hinge (3).

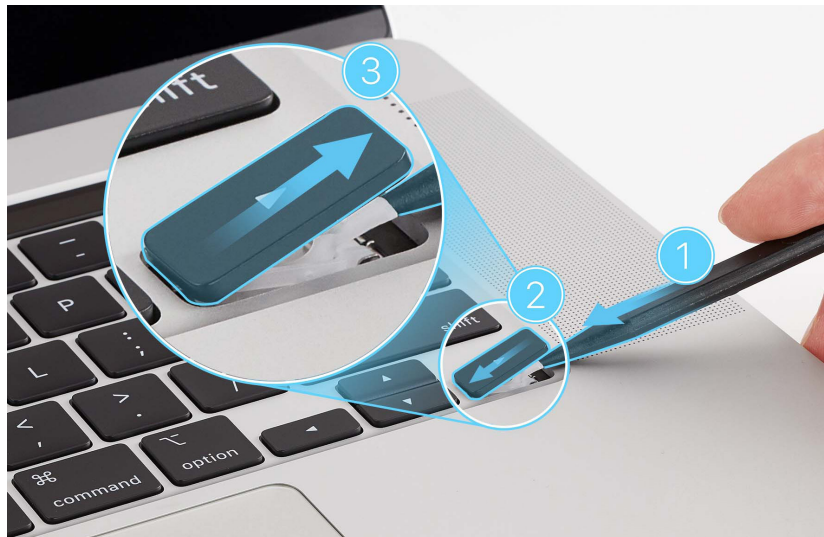

2. Remove the black stick and gently press the top of the keycap to engage the snaps.
3. Tap the key repeatedly to check that it springs back each time. Compare the response of the new keycap with the response of the keycaps around it.
4. If the keycap doesn't appear to be correctly installed, repeat all removal and reassembly steps with a new keycap.



## Link Bar Keys

### Maps

Link Bar keys are highlighted and include the following:

- Space Bar
- Shift
- Tab
- Delete
- Cap Lock
- Return

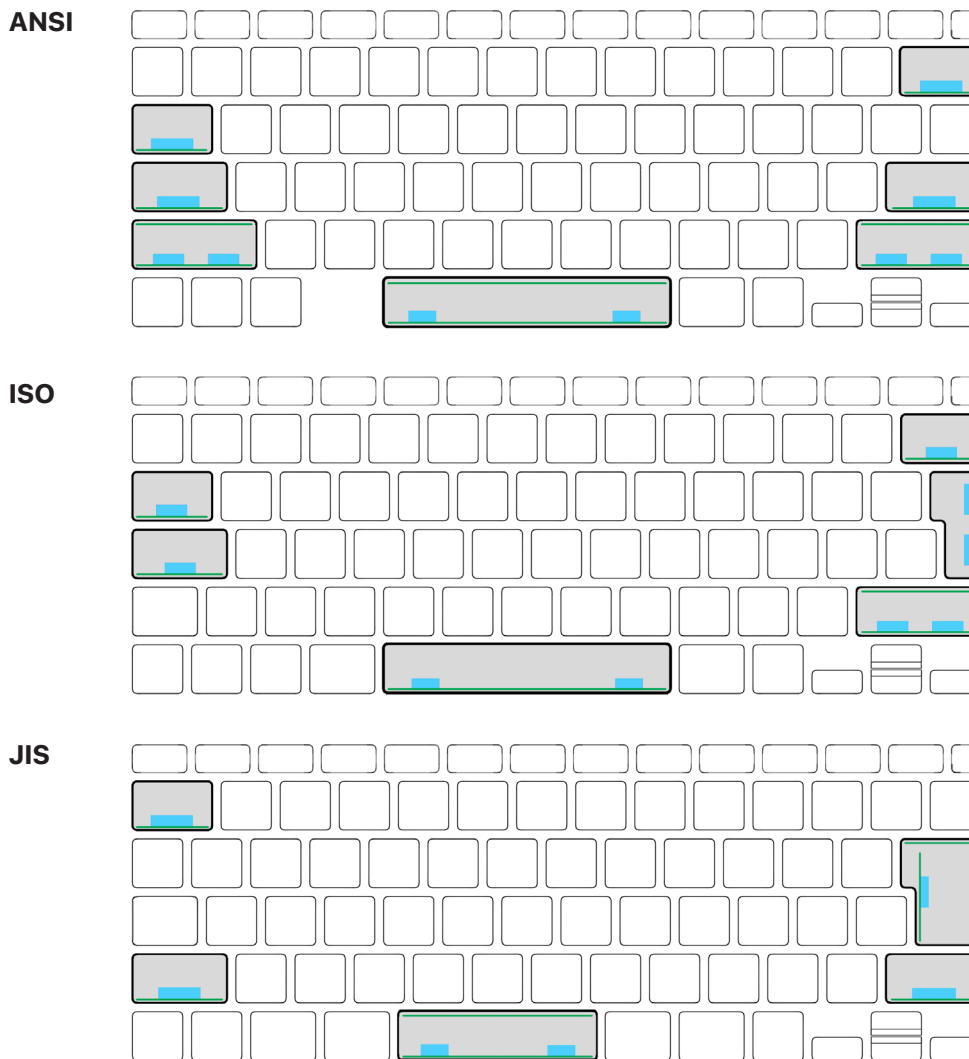

### Note:

- Blue bars show the location of snaps.
- Green lines show the location of link bars.

## Removal

### Important

Use two keycap levers for keys with two snaps. You can see these key types in the [Link Bar Key Maps](#).

**Note:** This procedure shows the removal and reassembly of the Space bar, but the steps are the same whether a link bar key requires using one or two keycap levers. Notes and alerts describe how the procedures vary for the other types of link bar keys.

1. Identify the location of the snaps under the key that you need to replace using the [Link Bar Key Maps](#).
2. Peel the frosted liner from one side of the 1x1 precut adhesive strips. Press and hold the large end of the keycap lever on the adhesive for 10 seconds. Lift the keycap lever and the adhesive to separate them from the white liner.

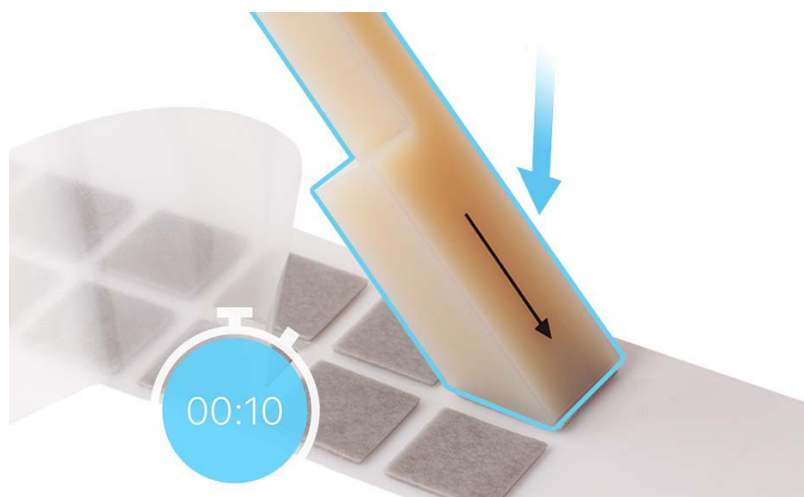

3. Place the keycap lever on its side. Repeat step 2 with the second keycap lever, then continue to step 4.
4. Align the keycap levers over the snaps.

5. Lightly press the adhesive ends of the keycap levers onto the key.

**Important**

Point the arrow on a lever to the hinged side of the keycap, which is opposite of the side that snaps onto the keyboard. You can find the location of the snaps in the [Link Bar Key Maps](#).

**Note:** The JIS Return key has three link bars and one side snap. Position the keycap lever so that the arrow points toward the link bar on the right side of the keyboard.

6. Hold the keycap levers and adhesive on the key for 10 seconds to activate the adhesive.



7. Tilt up the keycap levers in the direction of the arrows until you feel the snaps release.

 **Caution**

For a key with one link bar, don't tilt up the keycap more than 20 degrees.



### Important

The bottom link bar on larger keys might stick to the keycap during removal. If this happens, hold the two keycap levers and insert the black stick between the keycap and the bottom link bar. Use the black stick to release the link bar into the keycap well.



8. Remove the keycap.
9. Inspect the scissor mechanisms and keycap wells.
  - Use the black stick to gently move each scissor mechanism up and down. Verify that each scissor mechanism moves easily and lies flat when released. If it does not, [replace the scissor mechanism](#).
  - Use the black stick to press and release each dome through the top of the scissor mechanism — a dome should spring back upright. If a dome is damaged or not centered, replace the top case.
  - If a lower hook is bent, try to bend it back to a 90-degree angle.
  - If an upper hook is bent, use needle-nose pliers to straighten it.
  - If any lower hook or upper hook is broken or bent beyond repair, replace the top case.
10. Use compressed air to clean the well of the keycap.

**Note:** If compressed air doesn't dislodge visible debris, use a microterry polishing cloth to gently dislodge the debris.
11. Remove the keycap and adhesives from the keycap lever. Discard the keycap and adhesives.

## Reassembly

### Important

For the keycaps that have more than one link bar, check that the top link bar is preinstalled on the replacement keycap.

**Note:** On the JIS Return key, the link bar that fits into the right side of the keycap well is preinstalled.



1. Position the keycap in the well and insert the top link bar into the metal hooks that are on each side of the well.

### Important

To reinstall the JIS Return key, insert the keycap into the right side of the well.

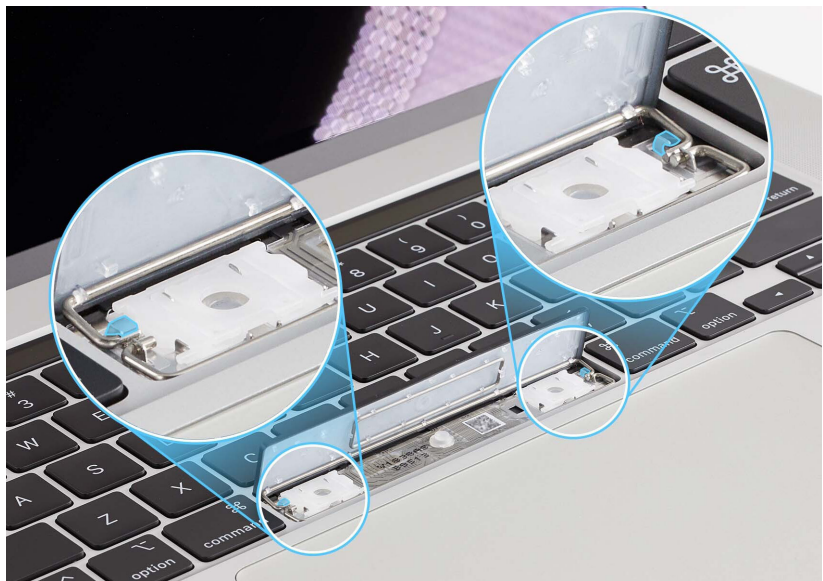



2. Push the keycap forward to set the top link bar in place.
3. Gently press the snaps and scissor mechanisms as shown to engage the keycap. You can find the snap locations in the [Link Bar Key Maps](#).

**Note:** For keys with one link bar, gently push the hinged side of the replacement keycap into the hinged side of the well at a 15-degree angle until the hinges engage. Then gently press the snap or snaps.



4. Tap the key repeatedly to verify that it springs back each time. If the keycap doesn't appear to be correctly installed, repeat all removal and reassembly steps with a new keycap.

## Scissor Mechanisms Removal

### Important

- Do not remove a scissor mechanism unless it is damaged. You can find the correct replacement in [the scissor mechanism identification chart](#).
- Note the orientation of the scissor mechanism before you remove it.

1. Use the black stick to disengage the scissor pins from the lower hooks.



2. Use tweezers to lift the scissor mechanism out of the well.





### 3. Inspect the well of the keycap:

- When you press and release the dome, it should spring back upright. If the dome is damaged or not centered, replace the top case.
- If a lower hook is bent, try to bend it back to a 90-degree angle.
- If an upper hook is bent, use needle-nose pliers to straighten it.
- If any lower hook or upper hook is broken or bent beyond repair, replace the top case.

## Reassembly

1. Use compressed air to clean the well of the keycap.

**Note:** If compressed air doesn't dislodge visible debris, use the black stick to gently dislodge it.

2. Use ESD-safe tweezers to position the scissor in the well and engage the upper hooks.



3. Use the black stick to engage the scissor pins with the lower hooks. The pin is engaged as shown (1). The pin is not engaged as shown (2).



4. Use the black stick to gently move the scissor mechanism up and down. Ensure that the scissor mechanism moves easily and lies flat when released.

## Keyboard Maps

Each symbol on the maps below corresponds to a symbol on the [scissor mechanism identification](#) chart and the scissor bag. Blue indicates where the snaps are located, and green indicates link bars.

### ANSI

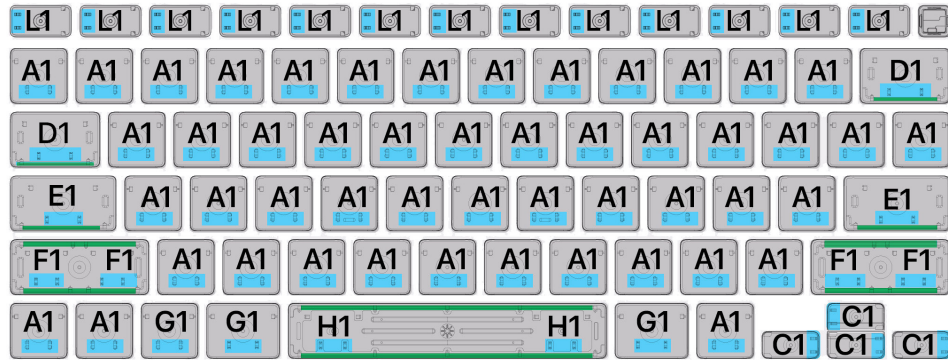

### ISO

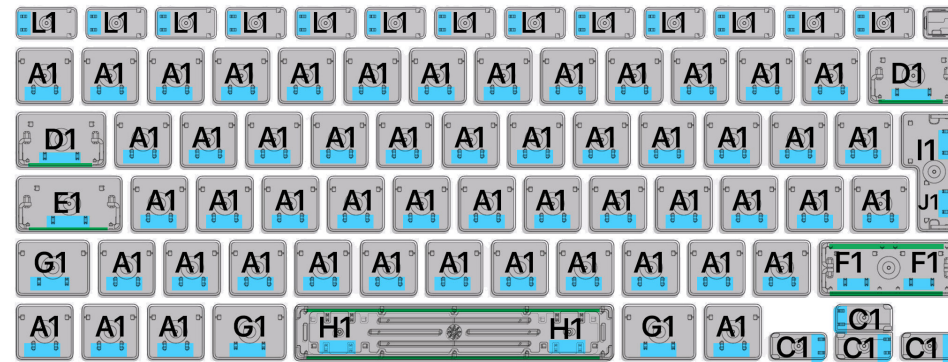

### JIS

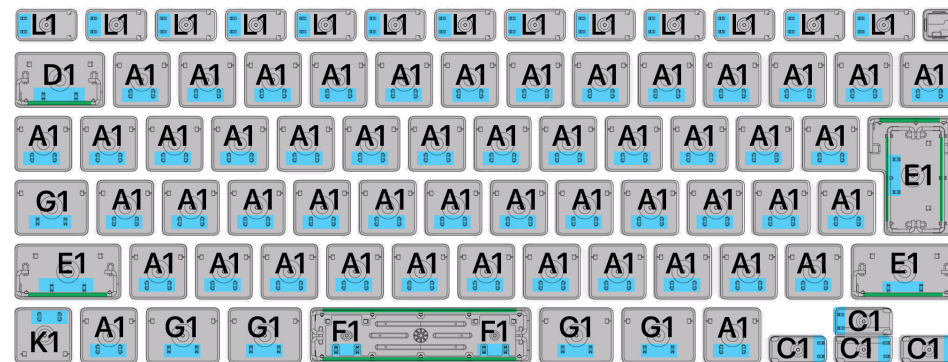

### Scissor Mechanism Identification

Match the scissor mechanism to the label to identify the correct replacement. Don't replace a scissor mechanism unless it is broken.

**A1**

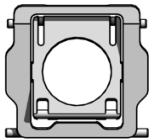

**B1**

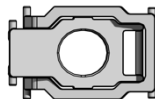

**C1**

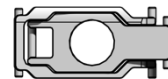

**D1**

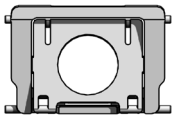

**E1**

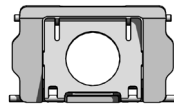

**F1**

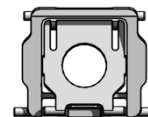

**G1**

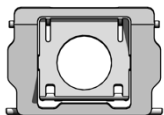

**H1**

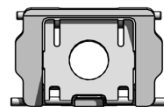

**I1**

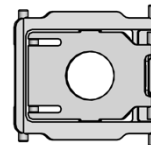

**J1**

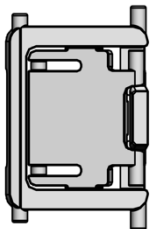

**K1**

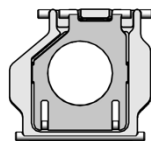

**L1**

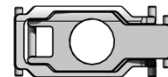

# Bottom Case

## Before You Begin

 **Warning**

Read [Battery Safety](#) and follow workspace and battery handling guidelines before you begin.

### Tools

- Battery cover
- Microterry polishing cloth
- Nylon probe (black stick)
- Pentalobe screwdriver
- Permanent marker
- Suction cup



## Removal

1. Place the computer on a clean, flat surface with the bottom face up.

2. Use the pentalobe screwdriver to remove the 10 pentalobe screws as shown.

**Note:** The screw color is specific to your model.

Front corners, middle front, and middle sides (1):

- Gold (923-05171)
- Silver (923-05168)
- Space gray (923-05165)

Middle rear (2):

- Gold (923-05172)
- Silver (923-05169)
- Space gray (923-05166)

Rear corners (3):

- Gold (923-05170)
- Silver (923-05167)
- Space gray (923-05164)

**Note:** Two clips inside the bottom case are attached to the top case.

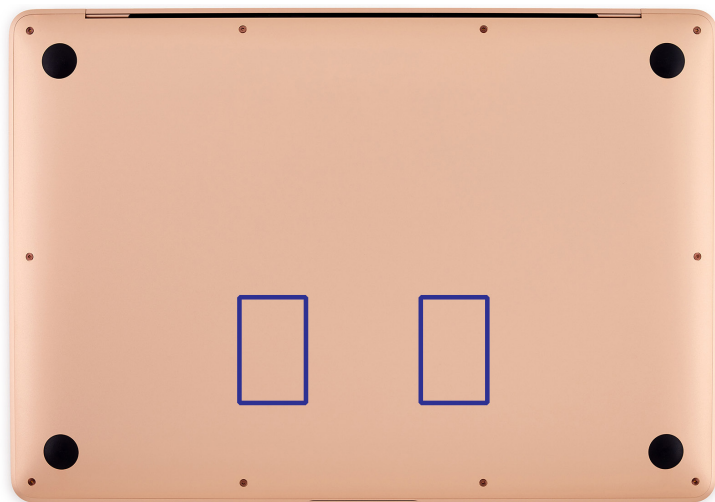

3. Press the suction cup to attach it to the lower left corner of the bottom case. Pull up the handle of the suction cup until you feel that the internal clip on the left releases.
4. Lift the edge of the suction cup to release it.

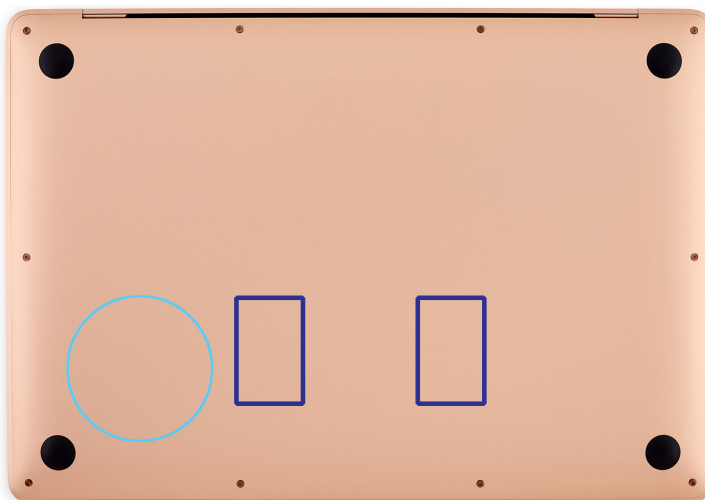

5. Move the suction cup to the lower right corner and press the top to attach it to the bottom case.
6. Pull up the handle of the suction cup until you feel that the internal clip on the right releases.
7. Lift the edge of the suction cup to release it.

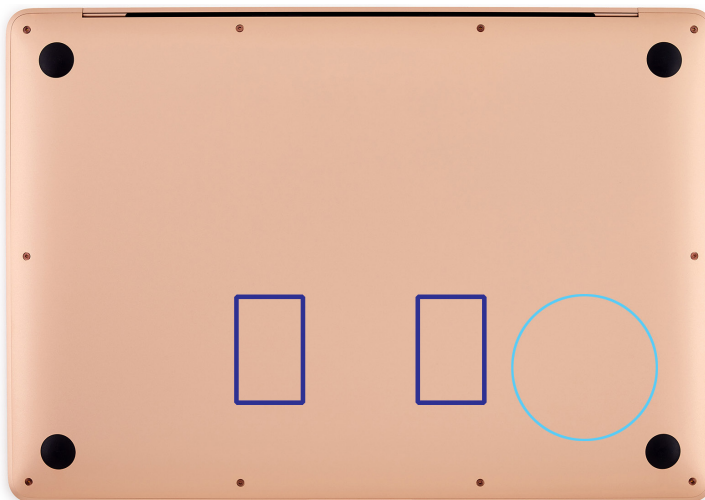

8. Lift the bottom case off the top case. Set the bottom case faceup on a clean, flat surface.



- Place the battery cover on the battery. Then press the black tabs into the clips on the top case until you feel a click.

 **Warning**

Ensure that the battery cover is aligned. Don't press the battery.

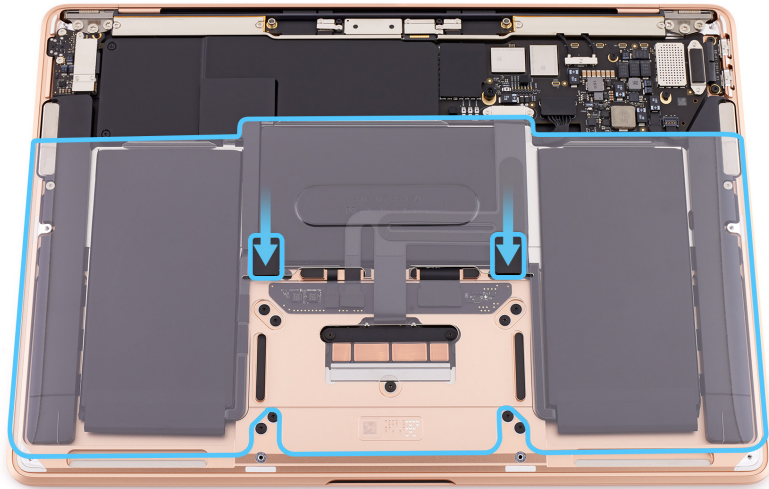

- Flip up the locking bar on the end of the battery flex cable.

 **Caution**

Don't use the locking bar to lift the end of the battery flex cable.

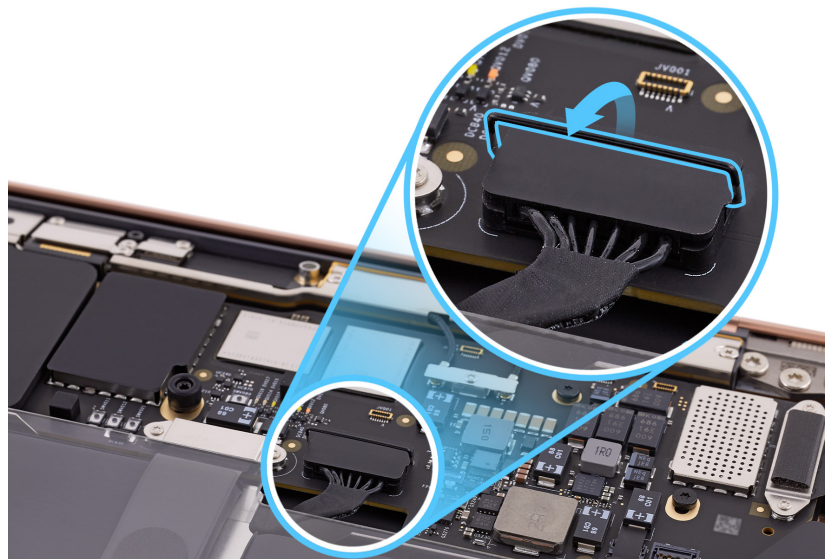



11. Use the flat end of the black stick to lift the end of the battery flex cable off the connector.

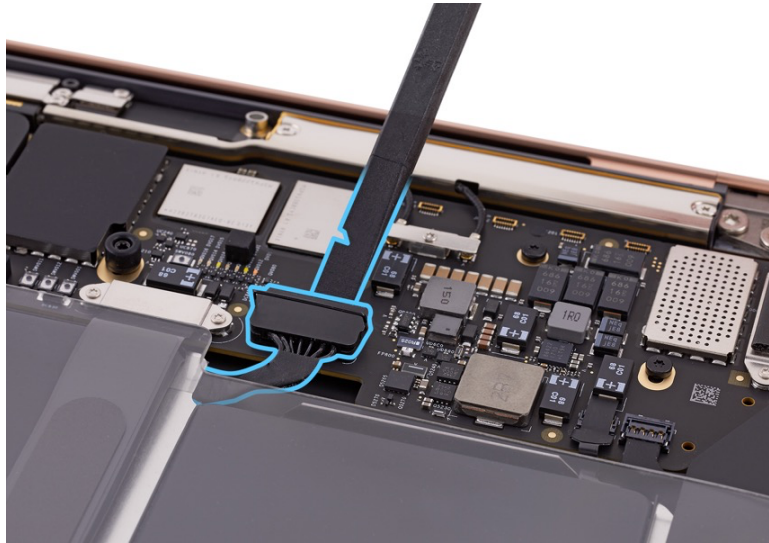

## Reassembly

**Note:** If you're replacing the bottom case, keep the case until the repair is complete. Locate the serial number on the outside of the existing bottom case. Use a permanent marker to write the system serial number on the inside of the replacement bottom case.

1. Position the end of the battery flex cable over the connector.

### **Caution**

Ensure that the locking bar is above the end of the battery flex cable, not under it.

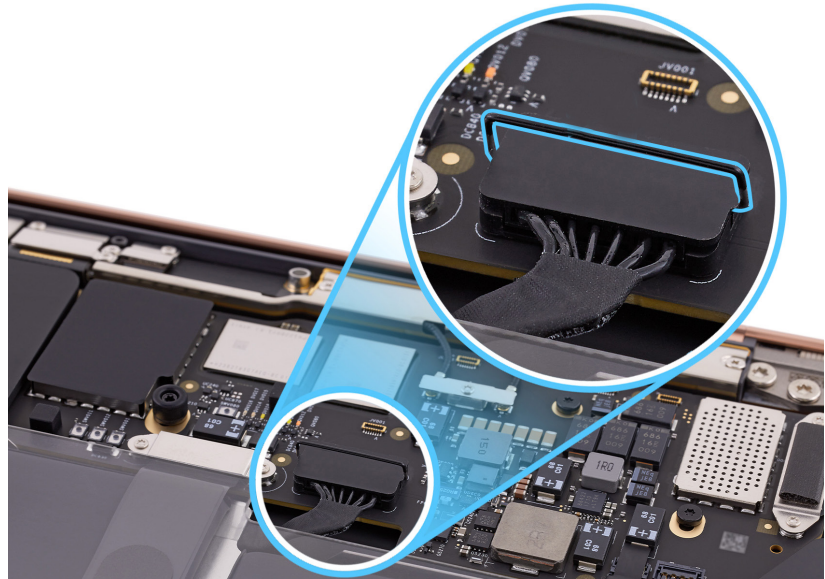

2. Press the end of the battery flex cable to the connector (1). Then flip the locking bar all the way down (2).

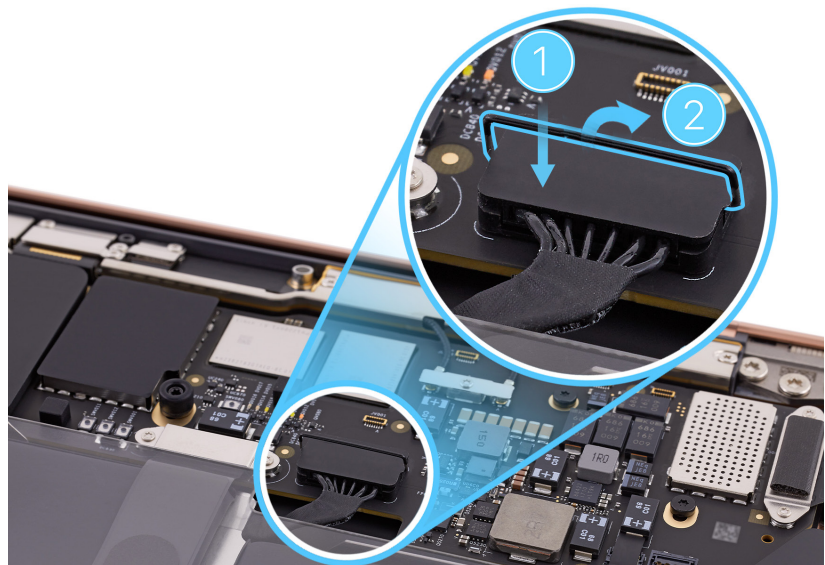

3. Hold the battery cover by the edges and lift it off the top case.
4. Use the microterry polishing cloth to ensure that the bottom case interior is clean and free of debris.

5. Position the bottom case on the top case with the notch at the top. Then lightly press the middle of the bottom case into the clips on the top case until you feel a click.

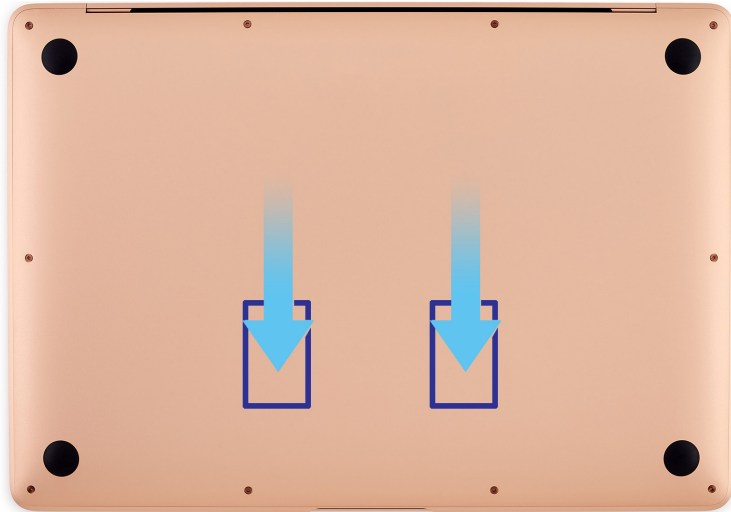

6. Ensure that the screw holes in the bottom case align with the screw holes in the top case.

- Use the pentalobe screwdriver to reinstall the 10 pentalobe screws into the bottom case in the order shown.

**Note:** Use the correct screw color for your model.

Middle rear (1):

- Gold (923-05172)
- Silver (923-05169)
- Space gray (923-05166)

Middle front and middle sides (2 and 3):

- Gold (923-05171)
- Silver (923-05168)
- Space gray (923-05165)

Rear corners (4):

- Gold (923-05170)
- Silver (923-05167)
- Space gray (923-05164)

Front corners (5):

- Gold (923-05171)
- Silver (923-05168)
- Space gray (923-05165)

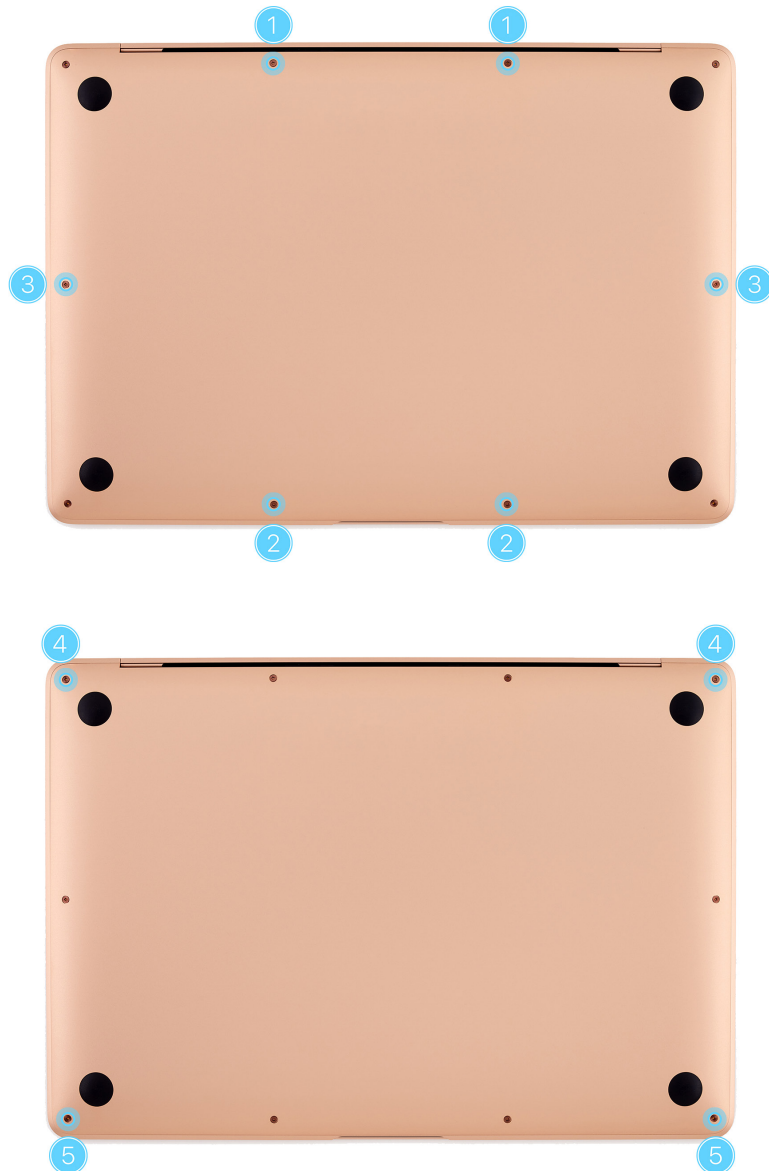

### Important

- System Configuration is required if you've installed a replacement display, logic board, or Touch ID board.
- If you replaced the logic board, the computer will start up in Diagnostics mode until you complete System Configuration.
- If you replaced the Touch ID board, it will function only as a power button until you complete System Configuration.
- After you've completed all removal and reassembly steps, learn how to initiate the System Configuration process at [support.apple.com/self-service-repair](https://support.apple.com/self-service-repair).

# Input/Output Board

## Before You Begin

Remove the following part before you begin:

- [Bottom case](#)

### Tools

- Nylon probe (black stick)
- Torx T3 screwdriver
- Torx T5 screwdriver
- USB-C charge cable

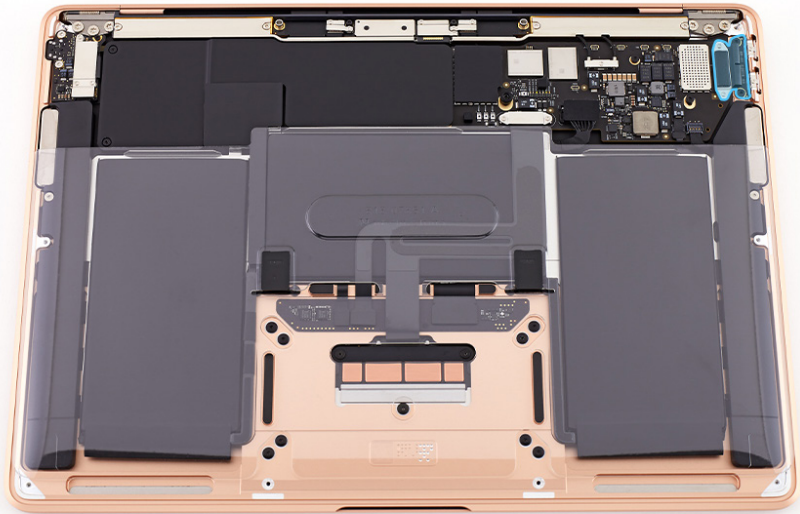



## Removal

1. Use the T3 screwdriver to remove the two T3 screws (923-04003) from the input/output (I/O) board connector cowling.
2. Remove the I/O board connector cowling and save it for reassembly.

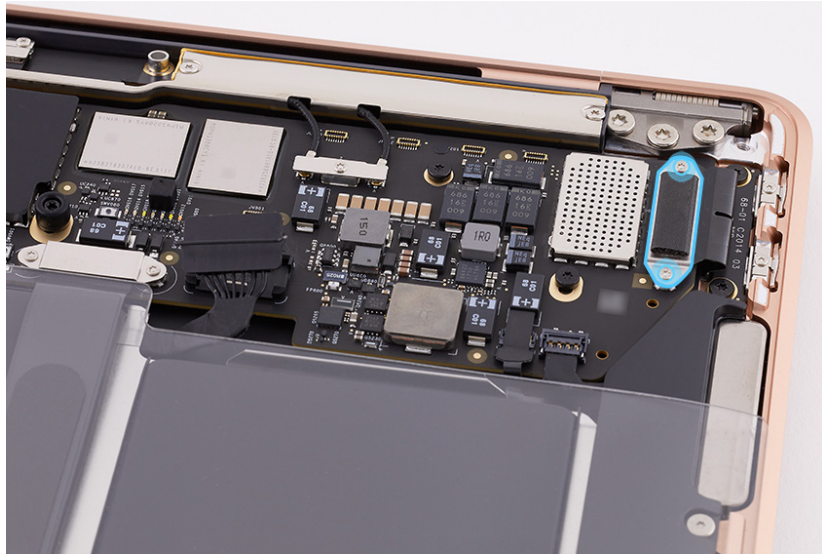

3. Lift the end of the I/O board flex cable off the connector.

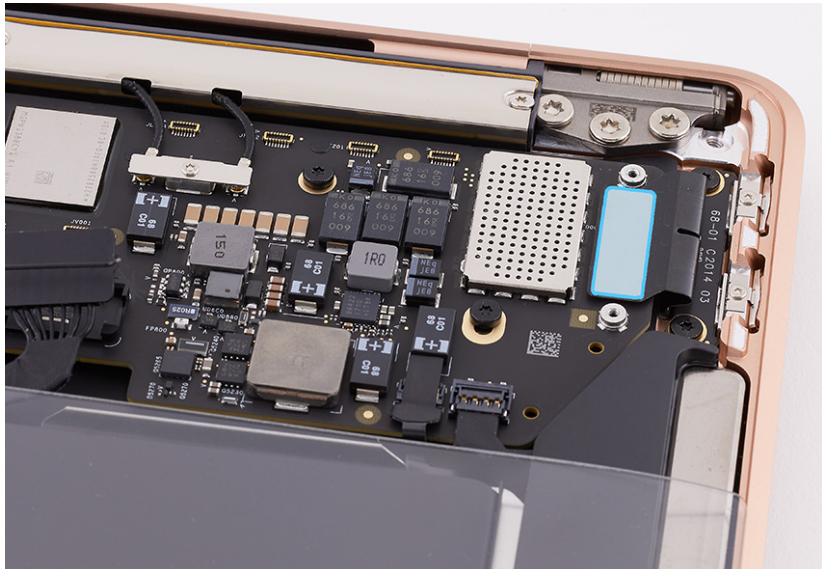

4. Use the T5 screwdriver to remove the two T5 screws (923-03975) from the I/O board.

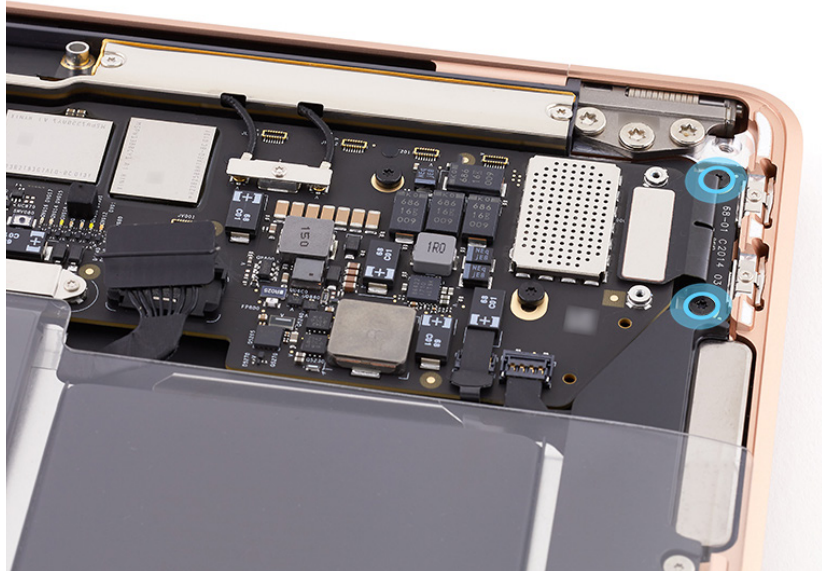

5. Hold the edges of the I/O board and gently slide it out of the ports.

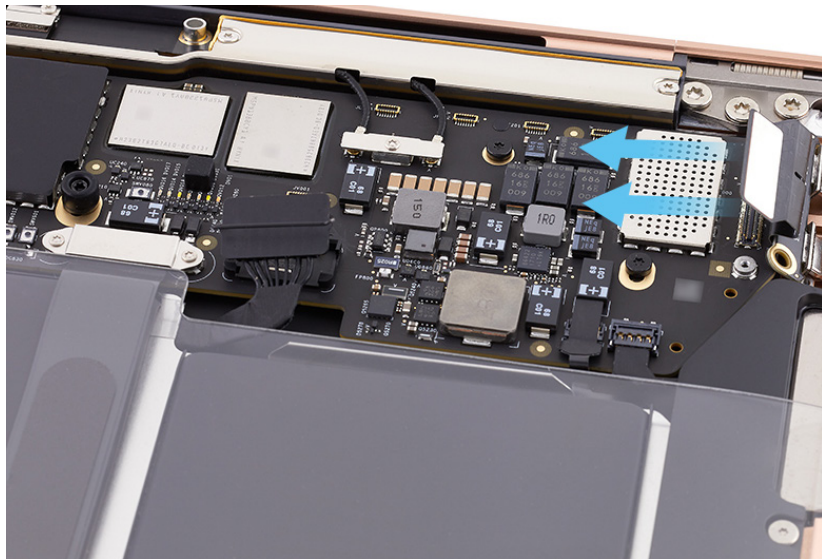

## Reassembly

1. Slide the I/O board into the top case.

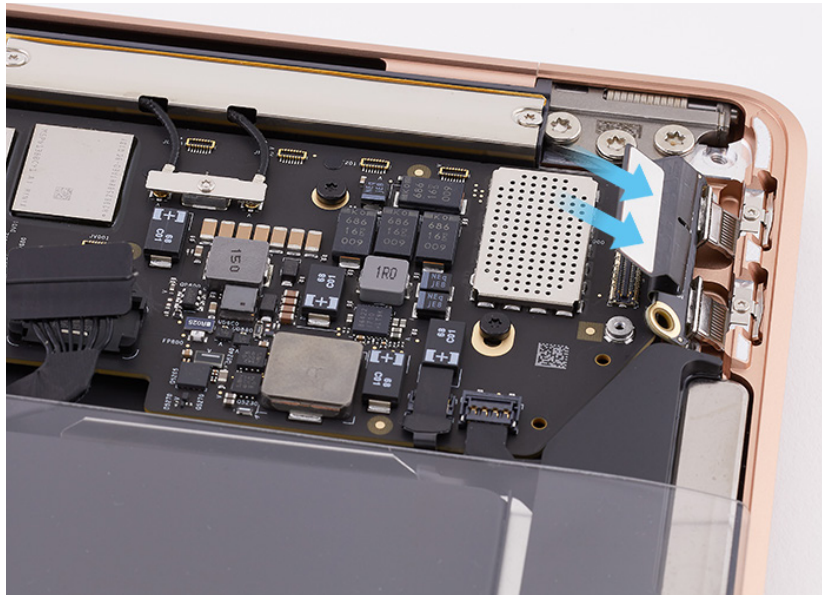

2. Use the T5 screwdriver to partially reinstall the two T5 screws (923-03975) into the I/O board.

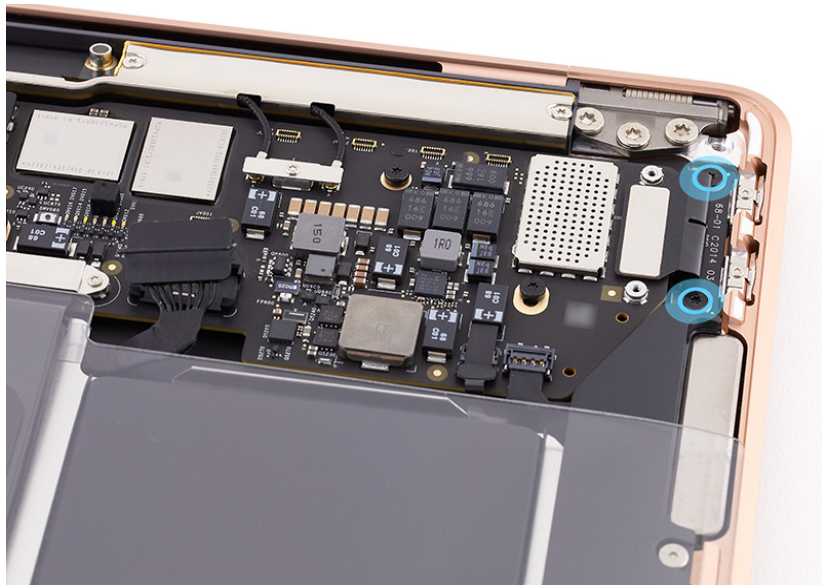



3. Plug both ends of the USB-C charge cable into the ports to ensure I/O board alignment. Adjust the alignment of the I/O board until the ends of the cable are easy to insert and remove.

**Danger**

Ensure that the USB-C charge cable isn't plugged into an electrical outlet.

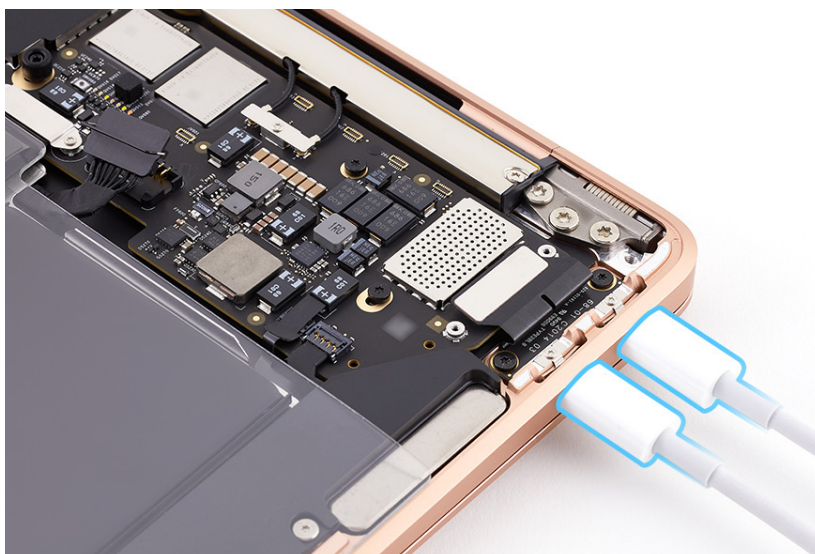

4. Keep the USB-C charge cable plugged into the ports. Then use the T5 screwdriver to fully reinstall the two T5 screws.
5. Unplug the USB-C charge cable from both ports.

6. Press the end of the I/O board flex cable to the connector.

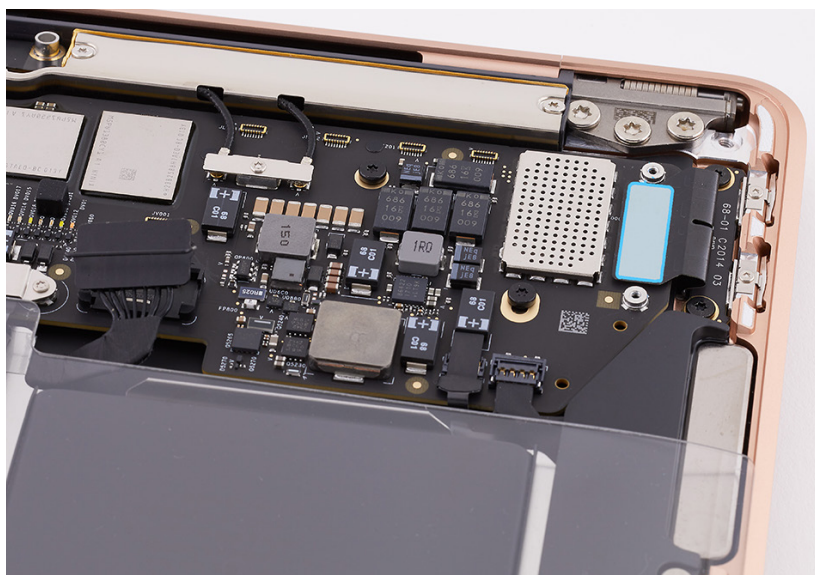

7. Position the I/O board connector cowling over the end of the flex cable.
8. Use the T3 screwdriver to reinstall the two T3 screws (923-04003) into the I/O board connector cowling.

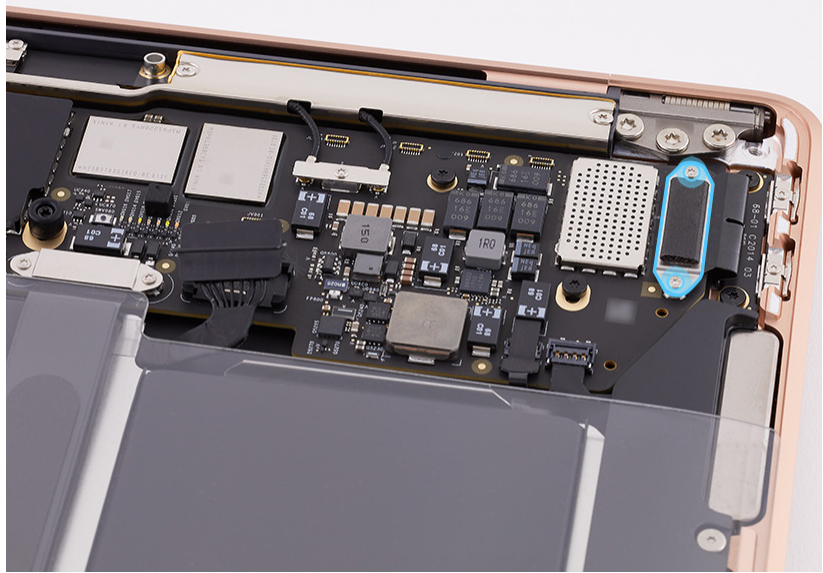

**Reinstall the following part to complete reassembly:**

- [Bottom case](#)

# Logic Board

## Before You Begin

Remove the following part before you begin:

- [Bottom case](#)

### Tools

- Antenna tool
- Nylon probe (black stick)
- Torx T3 screwdriver
- Torx T5 screwdriver

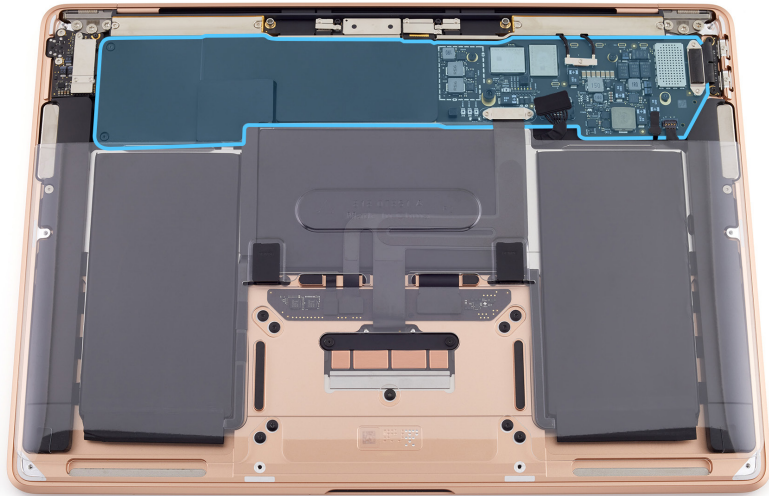

### Important

- This procedure requires [System Configuration](#). After you've completed all removal and reassembly steps, learn how to initiate the System Configuration process at [support.apple.com/self-service-repair](https://support.apple.com/self-service-repair).
- If you're installing a replacement logic board, you must also install a replacement Touch ID board.

## Removal

1. Use the T3 screwdriver to remove the 10 T3 screws from the following five cowlings (1–5):
  - I/O board connector cawling screws (923-04003) (1)
  - Input device (IPD) connector cawling screws (923-04003) (2)
  - Audio board connector cawling screws (923-04003) (3)
  - Embedded DisplayPort (eDP) connector cawling screws (923-04004) (4)
  - Antenna connector cawling screw (923-04003) (5)

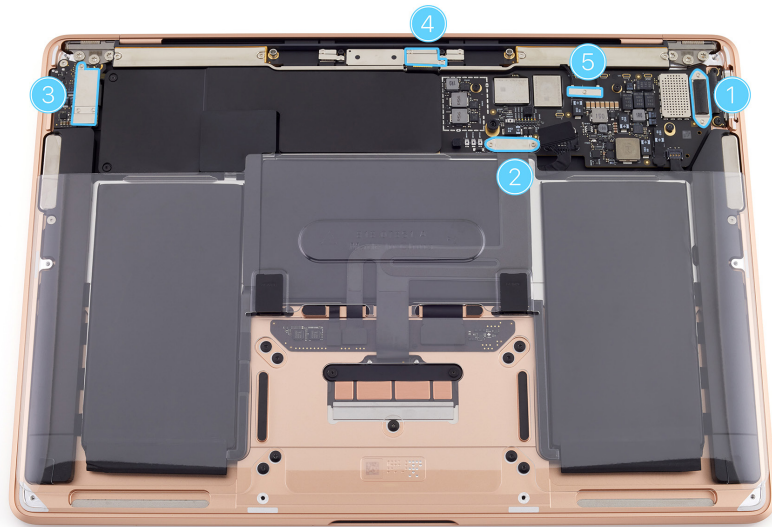

2. Remove the five cowlings and save them for reassembly.

### Important

Note the orientation of the antenna connector cawling (5) for reassembly.

3. Lift the ends of the following four flex cables (1, 2, 3, 4) from the connectors:

- I/O board flex cable (1)
- IPD flex cable (2)
- Audio board flex cable (3)
- eDP flex cable (4)

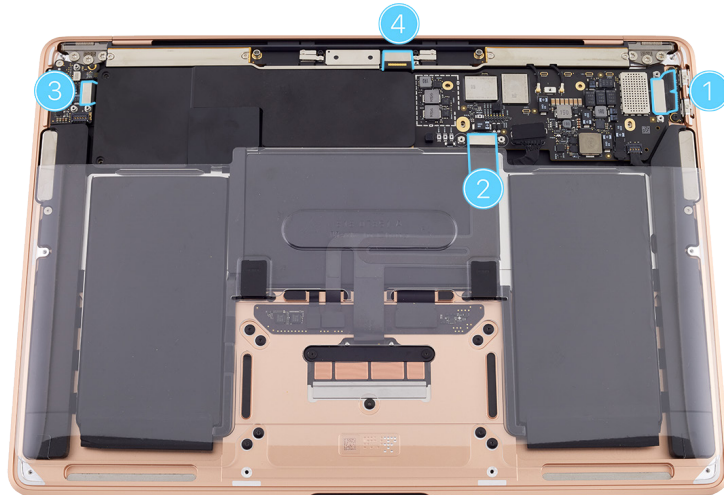

4. Peel the polyester film tab from the microphone flex cable (1). Use the black stick to flip up the locking lever. Then slide the end of the flex cable off the connector.

5. Place the flat end of the black stick under the left speaker flex cable (2) to loosen the adhesive and peel the flex cable from the logic board. Then use the black stick to lift the end of the flex cable from the connector.

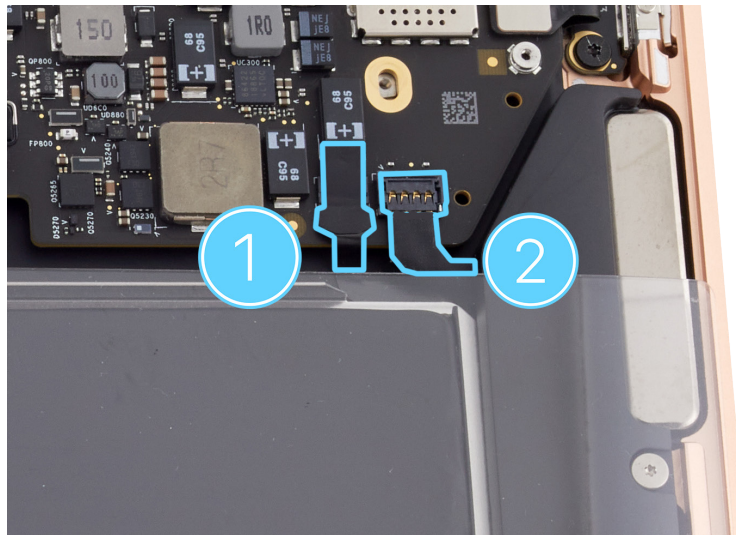



- Use the antenna tool to lift the ends of the two antenna coaxial cables from the connectors.

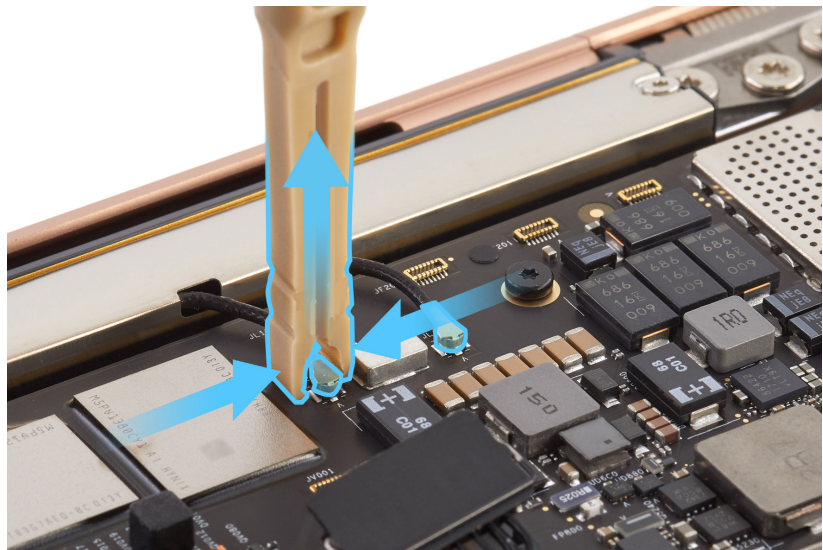

- Use the T5 screwdriver to remove the six T5 screws from the logic board:

- Long screws (923-05305) (1)
- Bumper screw (923-04007) (2)
- Short screws (923-03999) (3)

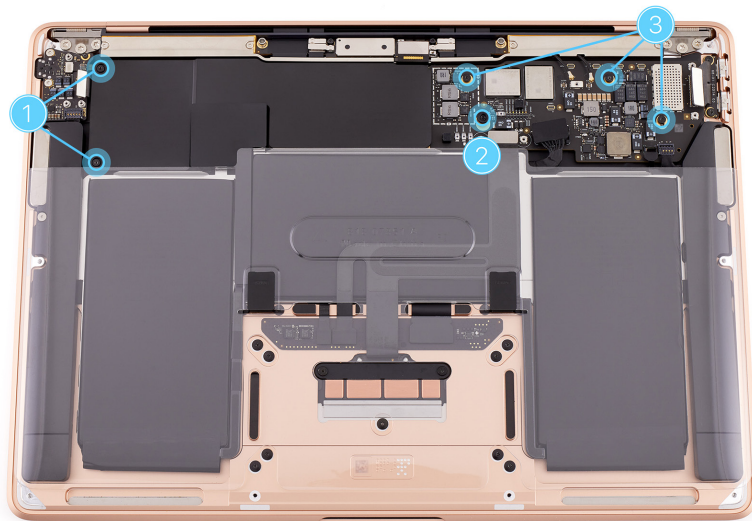

8. Hold the logic board by the edges. Then tilt up the logic board and slide it out of the top case.

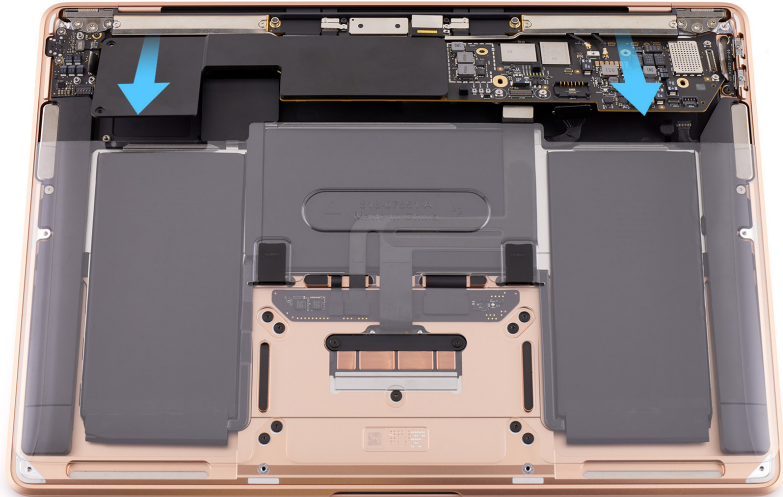

## Reassembly

### Important

If you're installing a replacement logic board, follow step 1. If you're reinstalling the existing logic board, skip to step 2.

1. Remove the existing [Touch ID board](#) and install a replacement Touch ID board.

2. Hold the logic board by the edges. Rest the edge of the logic board against the antenna module. Then tilt the logic board down into the top case.

### ⚠ Caution

Ensure that no cables are caught under the logic board when you place it in the top case. Bending the cables under the board can damage the cables.

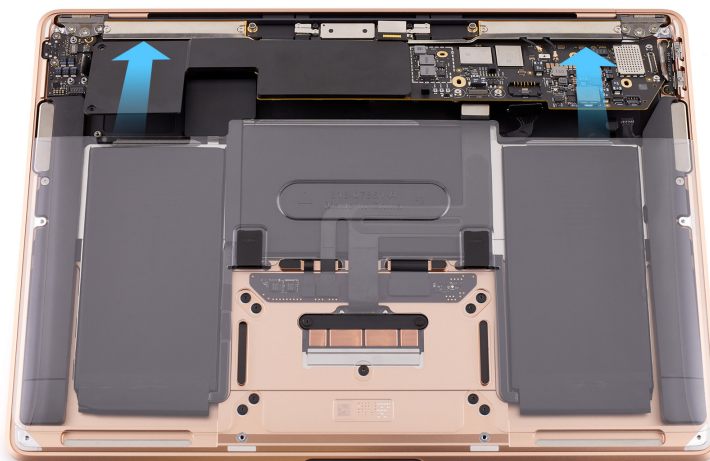

3. Press the ends of the following four flex cables to the connectors:

- I/O board flex cable (1)
- IPD flex cable (2)
- Audio board flex cable (3)
- eDP flex cable (4)

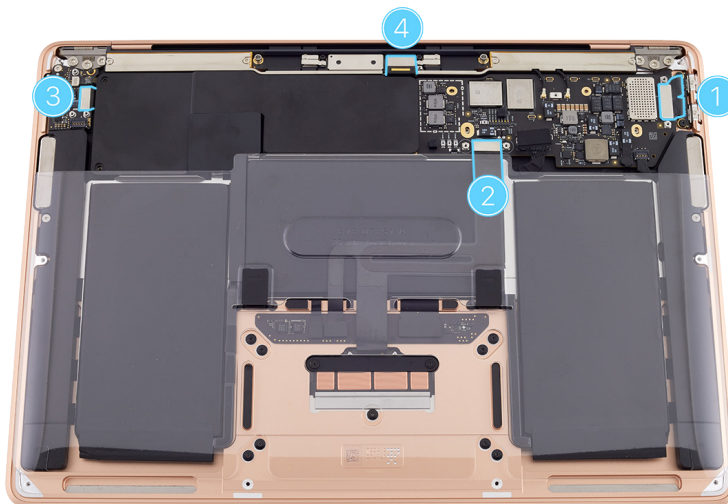



4. Slide the end of the microphone flex cable (1) into the connector. Flip down the locking lever. Press the polyester film tab to the locking lever.

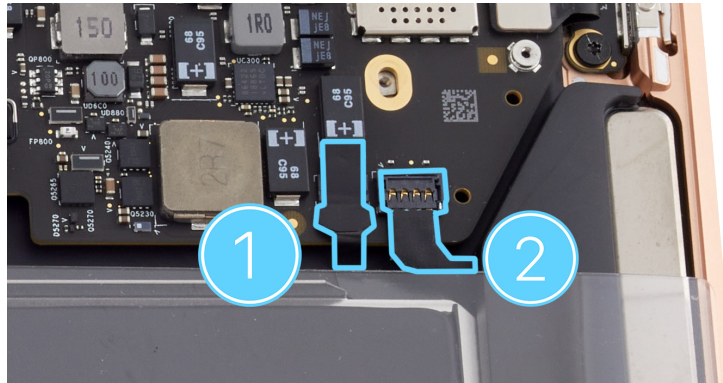

5. Press the end of the left speaker flex cable (2) to the connector. Use the black stick to gently press the flex cable and adhere it to the logic board.

6. Position the ends of the antenna coaxial cables over the connectors. Use the blunt end of the antenna tool to press the ends of the antenna coaxial cables to the connectors.

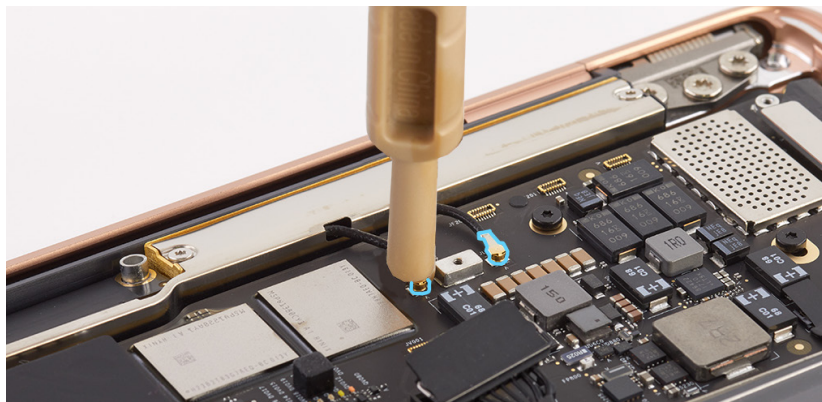

7. Use the T5 screwdriver to reinstall the six T5 screws into the logic board:

- Long screws (923-05305) (1)
- Short screws (923-03999) (2)
- Bumper screw (923-04007) (3)

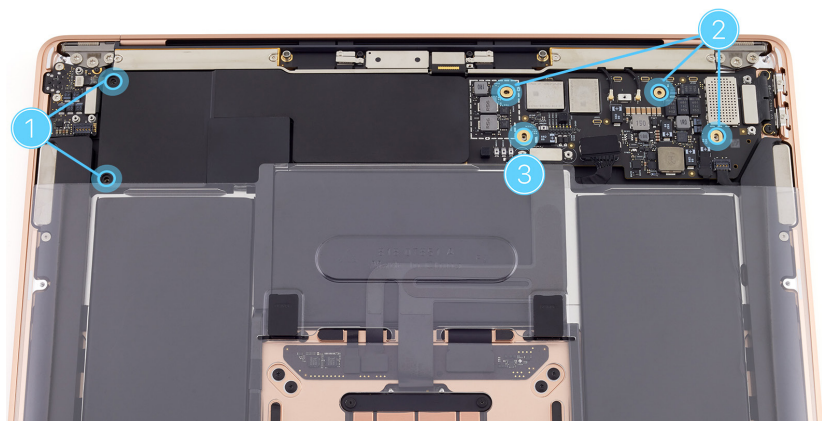

8. Position the following five cowlings (1–5) on the logic board:

- I/O board connector cowling (1)
- IPD connector cowling (2)
- Audio board connector cowling (3)
- eDP connector cowling (4)
- Antenna connector cowling (5)

### Important

Ensure the antenna connector cowling (5) is positioned with the tab facing the battery.

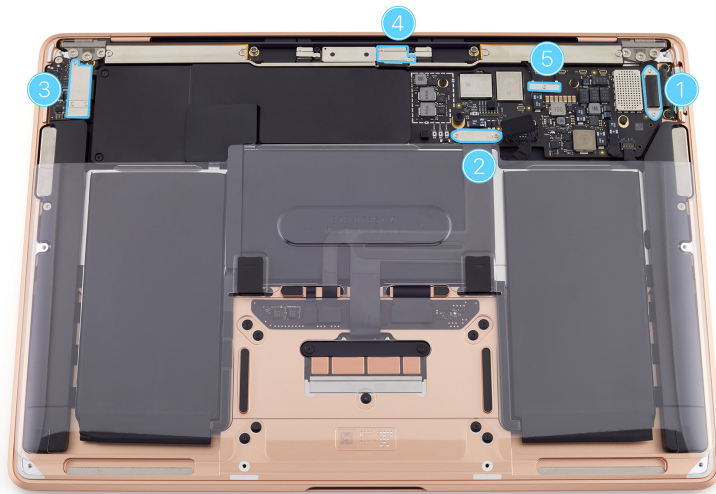

9. Use the T3 screwdriver to reinstall the 10 T3 screws into the five connector cowlings (1–5):

- I/O board connector cowling screws (923-04003) (1)
- IPD connector cowling screws (923-04003) (2)
- Audio board connector cowling screws (923-04003) (3)
- eDP connector cowling screws (923-04004) (4)
- Antenna connector cowling screw (923-04003) (5)

**Reinstall the following part to complete reassembly:**

- [Bottom case](#)

**Important**

After you've completed all removal and reassembly steps, learn how to initiate the System Configuration process at [support.apple.com/self-service-repair](https://support.apple.com/self-service-repair).

# Speakers

## Before You Begin

### **Warning**

Read [Battery Safety](#) and follow workspace and battery handling guidelines before you begin.

### Remove the following part before you begin:

- [Bottom case](#)

### Tools

- ESD-safe tweezers
- Ethanol wipes or isopropyl alcohol (IPA) wipes
- Nylon probe (black stick)
- Torx T3 screwdriver

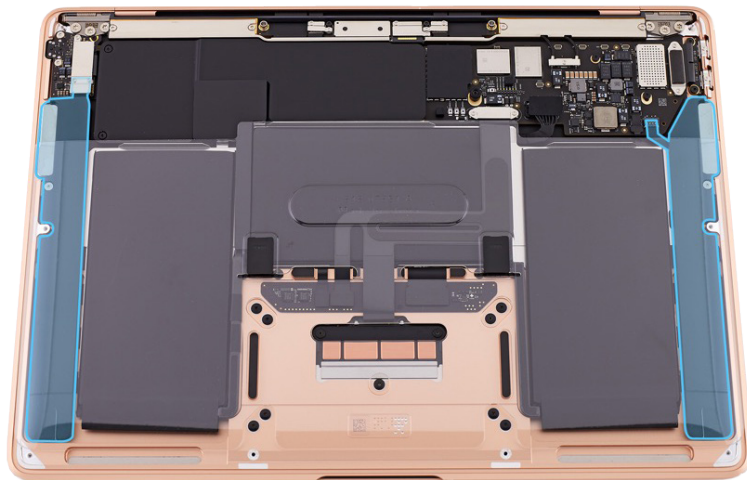

### **Important**

This procedure requires battery and speaker adhesive.

## Removal

1. Use the T3 screwdriver to remove the three T3 screws (923-04003) from the audio board connector cowling.
2. Remove the audio board connector cowling and save it for reassembly.



3. Place the pointed end of the black stick under the right speaker flex cable. Then use the black stick to lift the end of the flex cable off the connector.

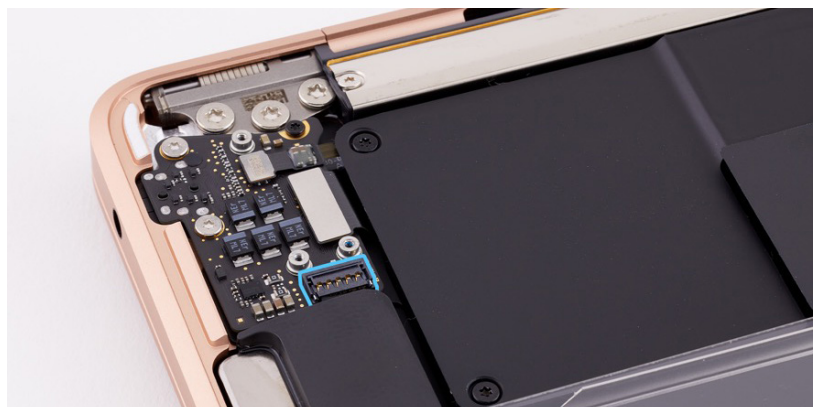

4. Place the flat end of the black stick under the left speaker flex cable to loosen the adhesive and peel the flex cable from the logic board. Then use the black stick to lift the end of the flex cable off the connector.

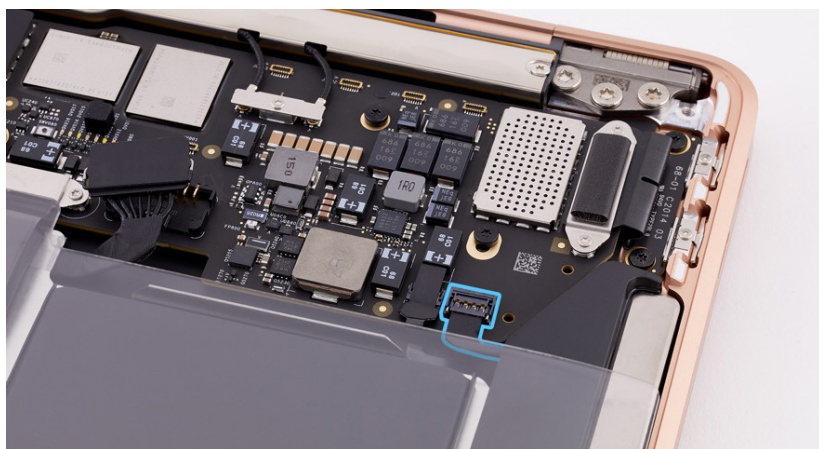



5. Tilt up the top corner of the battery cover to access the T3 screw (923-03850). Press and hold the battery cover tab to ensure that it remains clipped into the top case.
6. Use the T3 screwdriver to remove the T3 screw.



7. Tilt up the bottom corner of the battery cover to access the speaker adhesive tab. Press and hold the battery cover tab to ensure that it remains clipped into the top case.
8. Use ESD-safe tweezers to grasp the speaker adhesive tab. Then peel the adhesive tab off the top of the speaker.



9. Slowly pull the speaker adhesive tab past the battery cover. As the speaker adhesive strip stretches, twist the tweezers to wrap the strip around them. Continue to slowly pull and twist the tweezers until you've removed the entire strip.

### Important

Avoid pulling the adhesive strip against the edge of the top case or the strip may break.



### ⚠ Caution

If the adhesive strip breaks, attempt to retrieve the rest of the strip with ESD-safe tweezers. If you can't retrieve the rest of the strip, replace the top case.

10. Tilt up the side of the battery cover. Press and hold the battery cover tab to ensure that it remains clipped into the top case. Then tilt up the side of the speaker that is next to the battery (1) and roll it out of the top case (2).

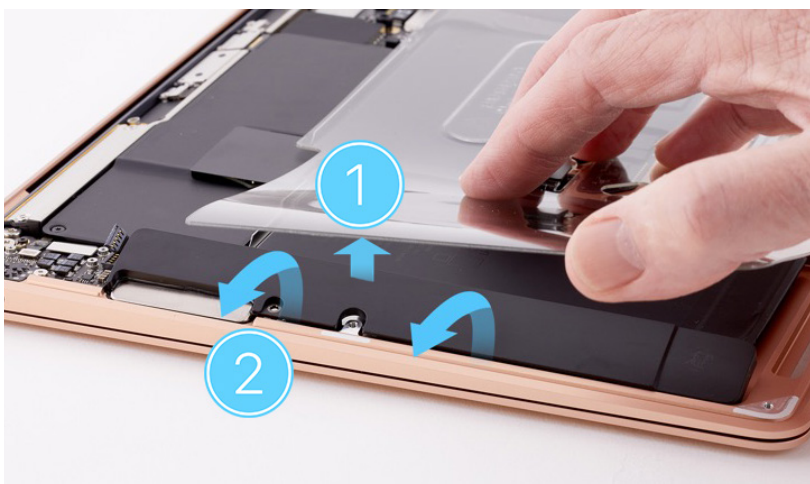

11. Repeat steps 5 through 10 to remove the other speaker.

## Reassembly

### Important

- Replacement speakers must be installed as a pair. Each replacement speaker includes preinstalled speaker adhesive.
- Use ethanol wipes or IPA wipes to clean any adhesive residue from the top case.

**Note:** If you're replacing the speakers, peel the release liner off the adhesive strip on the back of each replacement speaker. Then skip to step 3.



1. If you're reinstalling the existing speakers, peel the adhesive backing off the speaker adhesive strips.

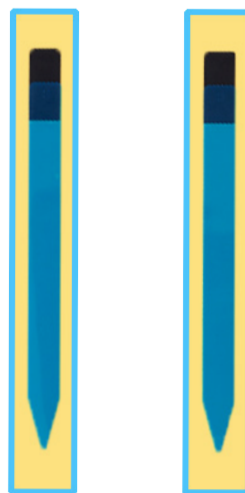



2. Press one speaker adhesive strip onto the back of the speaker. Then peel the release liner off the adhesive strip as shown.



3. Tilt up the side of the battery cover and keep it tilted up for steps 4 through 6. Press and hold the battery cover tab to ensure that it remains clipped into the top case. Then rotate the speaker slightly and tuck it into position in the top case.



4. Gently press both ends of the speaker for a few seconds to adhere the speaker to the top case.
5. Adhere the speaker adhesive tab to the top of the speaker.



6. Use the T3 screwdriver to reinstall the T3 screw (923-03850). Then lower the corner of the battery cover.



7. To reinstall the other speaker, repeat steps 1 through 6. If you're installing replacement speakers, repeat steps 3 through 6 with the other speaker. Then continue to step 8.
8. Press the ends of both speaker flex cables to the connectors. Use the black stick to gently press the left speaker flex cable and adhere it to the logic board.

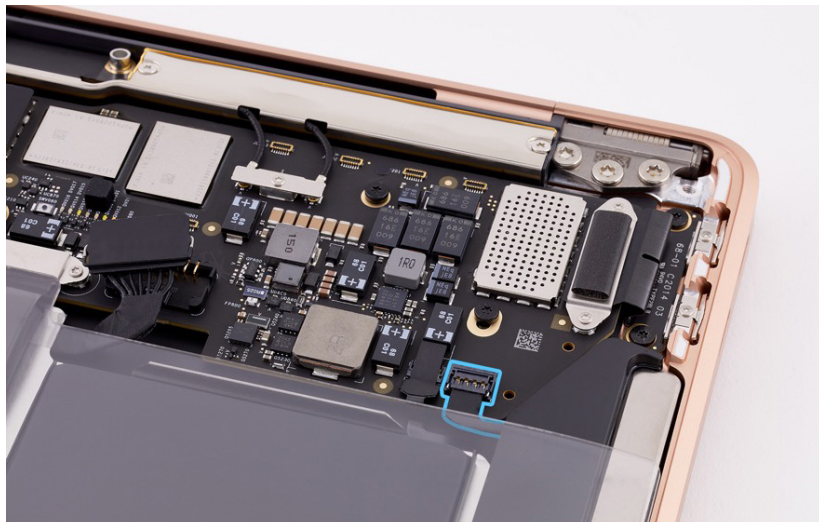

9. Position the audio board connector cowling over the ends of the flex cables.
10. Use the T3 screwdriver to reinstall the three T3 screws (923-04003) into the audio board connector cowling.



**Reinstall the following part to complete reassembly:**

- [Bottom case](#)

# Trackpad and Input Device Flex Cable

## Before You Begin

### **Warning**

Read [Battery Safety](#) and follow workspace and battery handling guidelines before you begin.

### Remove the following part before you begin:

- [Bottom case](#)

### Tools

- Adjustable torque driver (10–34 Ncm)
- Adjustable torque driver (0.3–1.2 Nm)
- ESD-safe tweezers
- Gap offset kit
- Kapton tape
- Nylon probe (black stick)
- Sticky notes (3 by 3 inches)
- Torx T3 screwdriver
- Torx T5 bit
- Torx T5 screwdriver

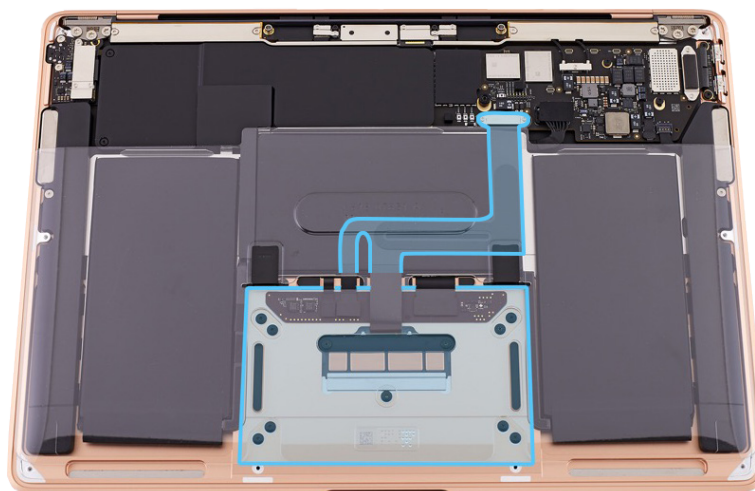

### **Important**

This procedure may require a trackpad shim kit, which is available only with a replacement trackpad. It's not a separate orderable part.



## Removal

1. Open the display to a 90-degree angle. Then place the computer on the edge of the table with the display hanging down.

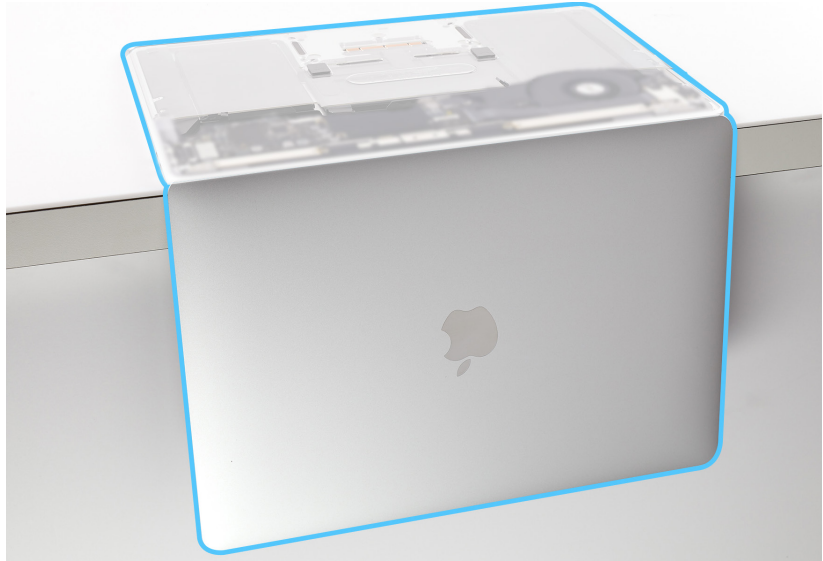

2. Use the T3 screwdriver to remove the two T3 screws (923-04003) from the IPD connector cowling.
3. Remove the IPD connector cowling and save it for reassembly.

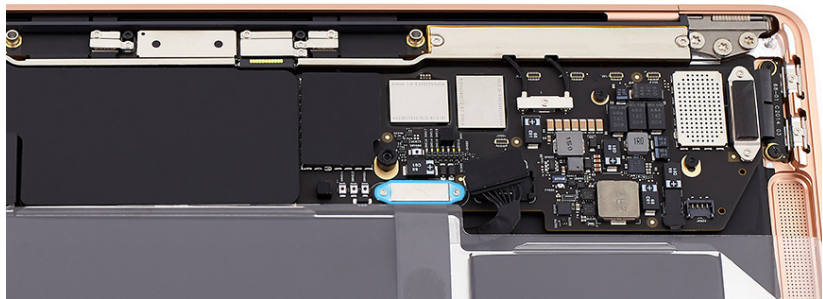

4. Use the black stick to lift the end of the IPD flex cable off the connector.

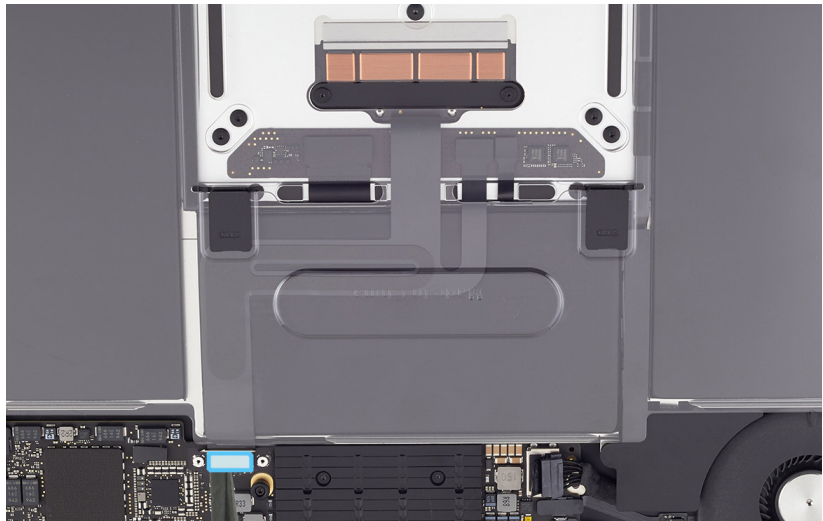

5. Use the T5 screwdriver to remove the middle T5 screw (923-03002) and the eight corner T5 screws (923-02880).



6. Hold the battery cover by the edges and lift it off the top case.

7. Use the flat end of the black stick to flip up the locking lever on the other end of the IPD flex cable. Slide the end of the flex cable out of the connector.

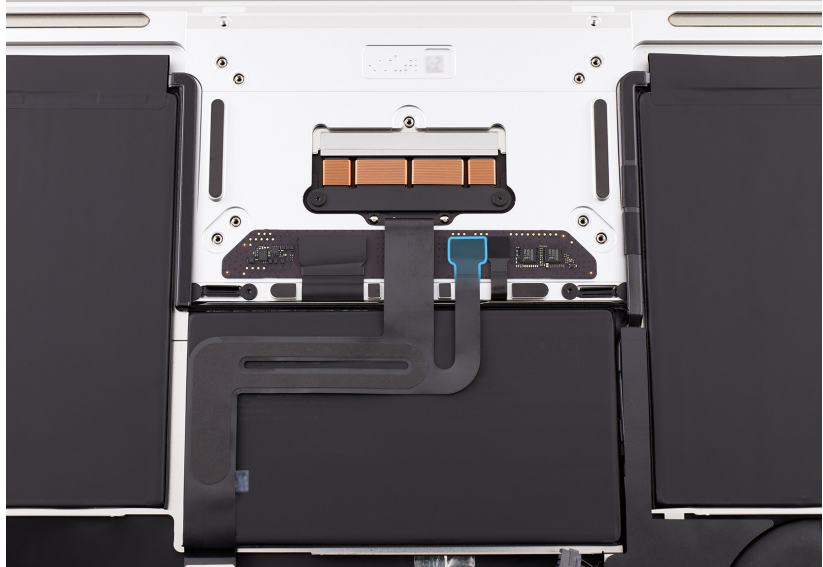

8. Gently peel the IPD flex cable off the battery.

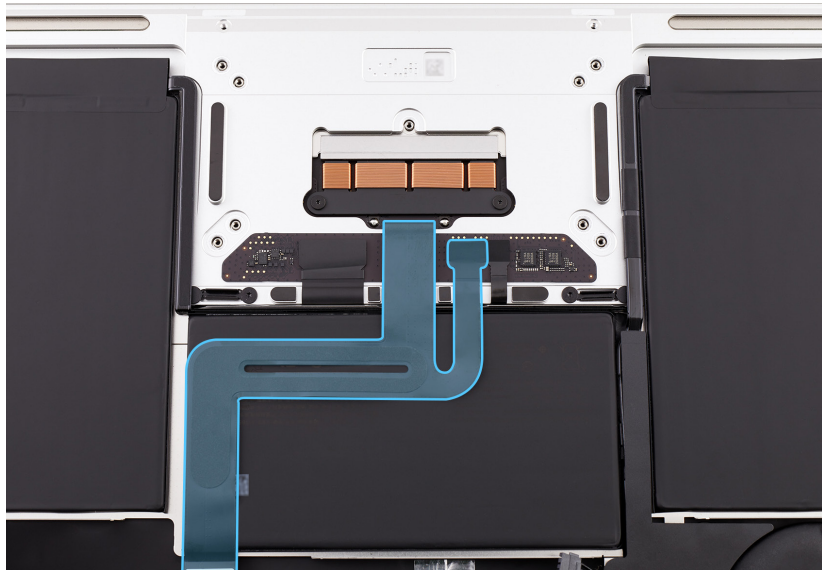



- Lift the computer off the table and allow the IPD flex cable to pass through the opening in the top case. Leave the trackpad flat on the table to keep the shims in place.

### Important

If shims fall out, they must be reinstalled in their original locations. If you can't determine the shims' original locations, replace them. A replacement shim kit is available only with a replacement trackpad.

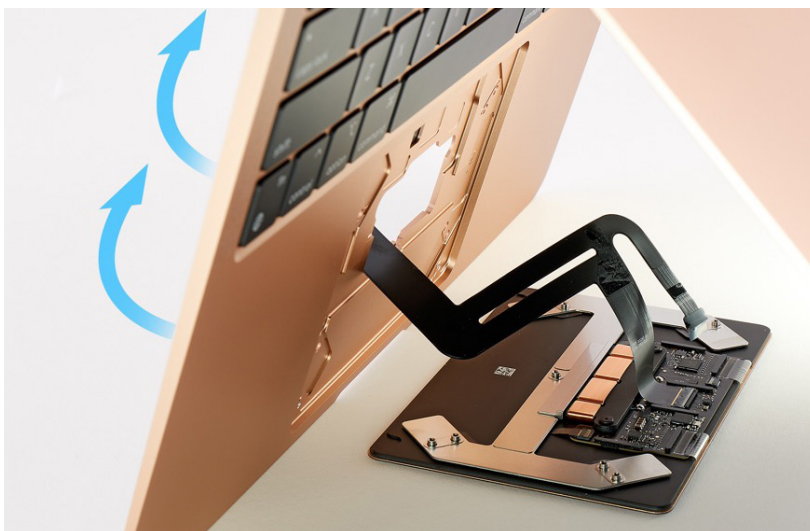

- Set the computer on the edge of the table with the display hanging down.
- Place the battery cover on the battery. Then press the black tabs into the clips on the top case until you feel a click.

### Important

If you're reinstalling the existing trackpad but the IPD flex cable is damaged, continue to step 12. If you're reinstalling the existing trackpad and IPD flex cable or you're installing a replacement trackpad, skip to reassembly.

- Use the flat end of the black stick to flip up the locking lever on the trackpad. Then slide the end of the IPD flex cable out of the connector.

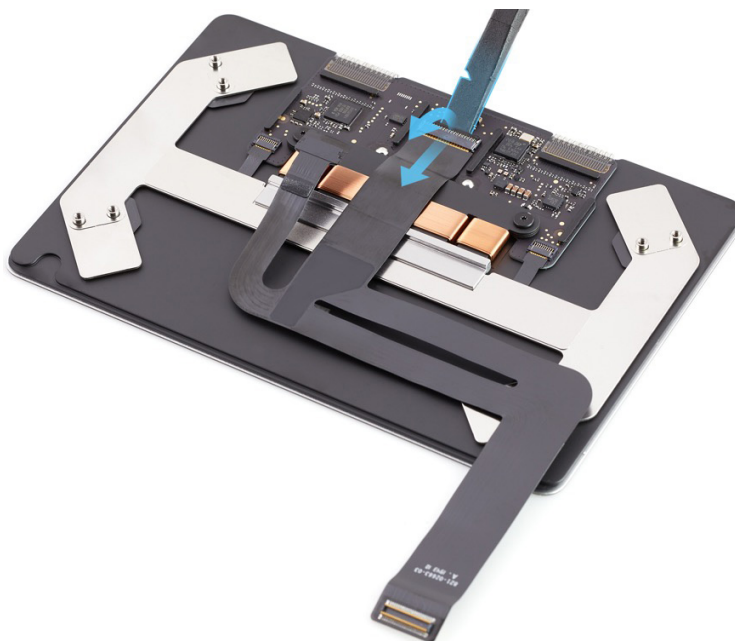

## Reassembly

### Important

- If you need to install a replacement IPD flex cable, slide the end of the replacement flex cable into the connector on the trackpad. Then flip down the locking lever.
- If you're replacing the trackpad, follow step 1. If you're using the existing trackpad, skip to step 2.

1. Use ESD-safe tweezers to install replacement trackpad shims. Position four rectangular shims on the outer screw holes. Then position one circular shim on the middle screw hole.

### Important

A replacement trackpad comes with three sizes of shims (0.100 mm, 0.150 mm, and 0.175 mm). Start with the 0.150 mm shims. Use thinner or thicker shims to adjust alignment in step 16.

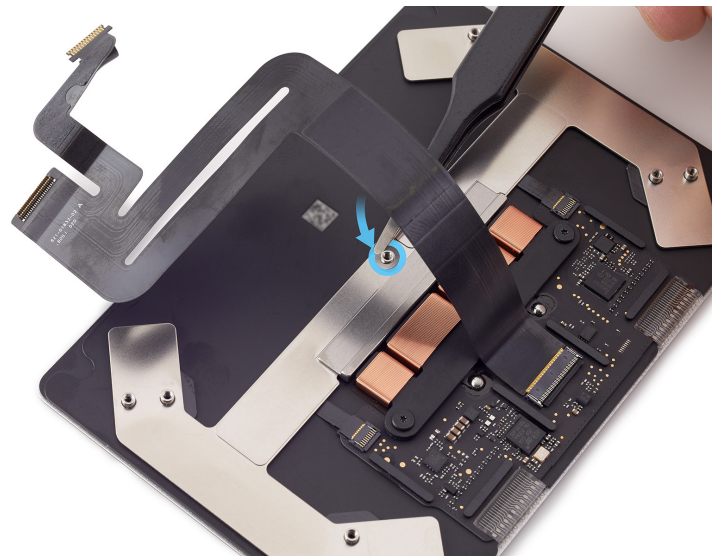
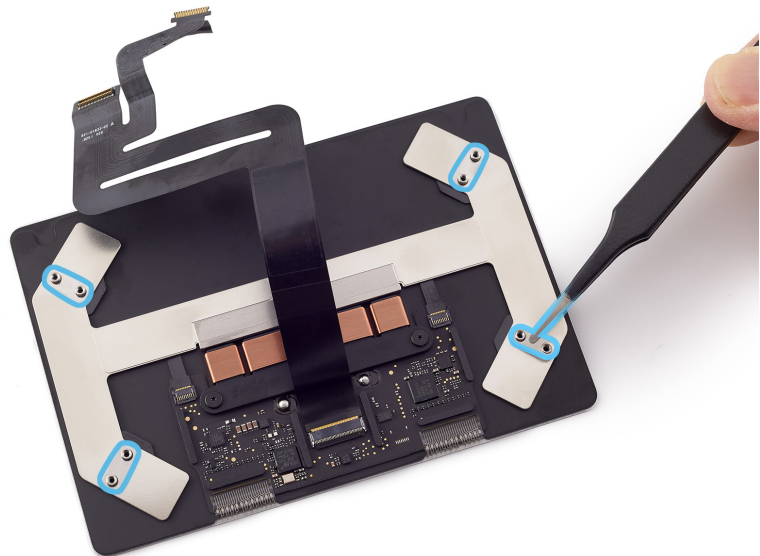

2. Hold the battery cover by the edges and lift it off the top case.

3. Ensure that the trackpad lies flat on the table with the IPD flex cable extended away from you.

4. Route the IPD flex cable back through the opening in the top case.

5. Slowly lower the computer over the trackpad and align the screw holes in the top case with the screw holes in the trackpad. Let the display hang over the table edge.



6. Slide the end of the IPD flex cable into the connector. Then flip down the locking lever.

### Important

Don't adhere the IPD flex cable to the battery yet.

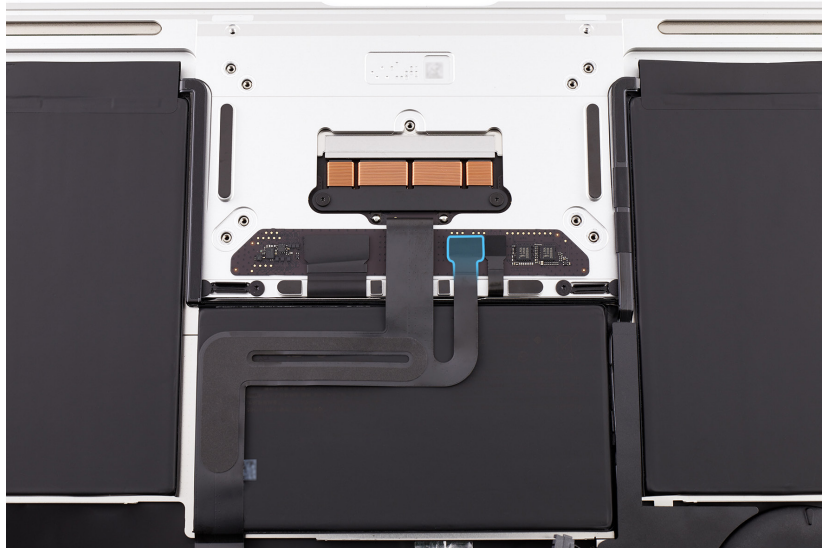

7. Place the battery cover on the battery and press the black tabs into the clips on the top case until you feel a click.

8. Insert the Torx T5 bit into the 10-34 Ncm adjustable torque driver. Set the torque value to 16 Ncm.
9. Use the adjustable torque driver and Torx T5 bit to partially reinstall the four outer corner T5 screws (923-02880) into the trackpad to allow for trackpad alignment.

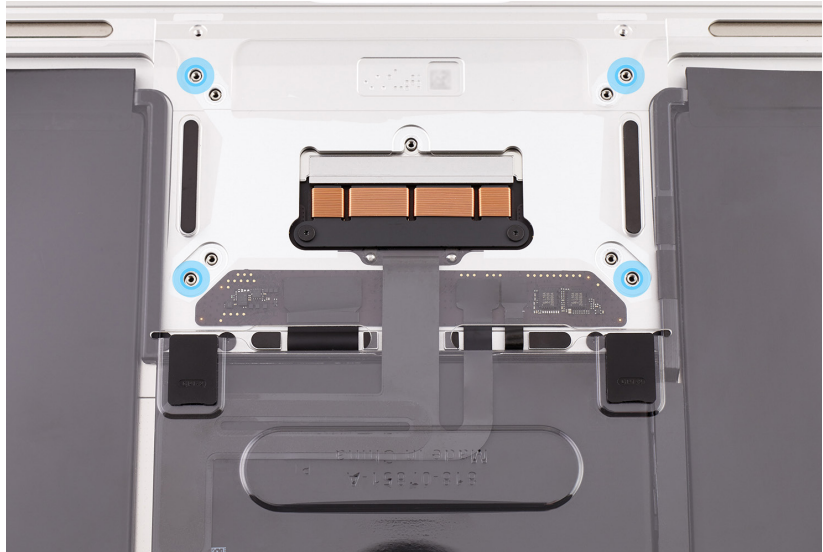

10. Turn over the computer. Insert one gap offset in each of the four corners of the trackpad. Then secure each gap offset with a piece of Kapton tape.



11. Stand the computer on its side with the display still open.



12. Keep the Torx T5 bit in the 10-34 Ncm adjustable torque driver. Ensure that the torque value is still set to 16 Ncm.

13. Use the adjustable torque driver and Torx T5 bit to fully reinstall the four outer corner T5 screws.



14. Place the computer right side up. To verify the top of the trackpad is at the correct height, align one sticky note on the trackpad's top edge. Ensure that the sticky note is flush with the top case.



15. To verify the bottom of the trackpad is at the correct height, align a stack of two sticky notes on the trackpad's bottom edge. Ensure that the two sticky notes are flush with the top case.



16. If the trackpad is at the correct height, continue to step 17. If the trackpad edges are higher or lower than the top case, remove the sticky notes, gap offsets, and Kapton tape. Place the computer on the edge of the table with the display hanging down. Use the T5 screwdriver to remove the four outer corner T5 screws (923-02880), and repeat removal steps 6 through 12. Then follow reassembly steps 1 through 15.

### Important

- If the trackpad is higher than the top case, install the thinner 0.100 mm shims.
- If the trackpad is lower than the top case, install the thicker 0.175 mm shims.

17. Place the computer on the edge of the table with the display hanging down.

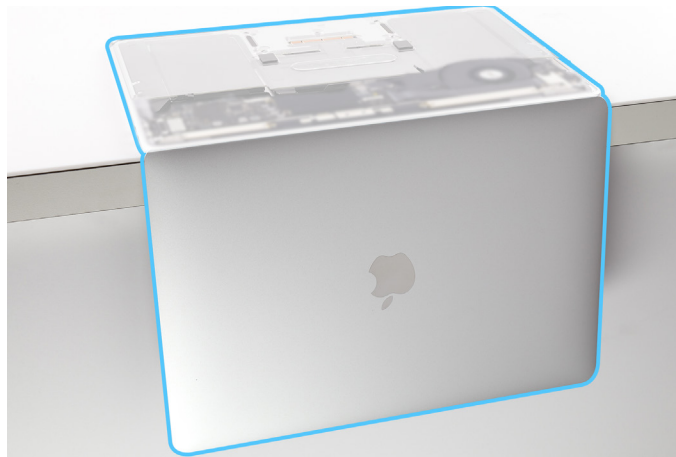

18. Insert the Torx T5 bit into the 0.3-1.2 Nm adjustable torque driver. Set the torque value to 0.35 Nm.

19. Use the adjustable torque driver and Torx T5 bit to reinstall the middle T5 screw (923-03002).

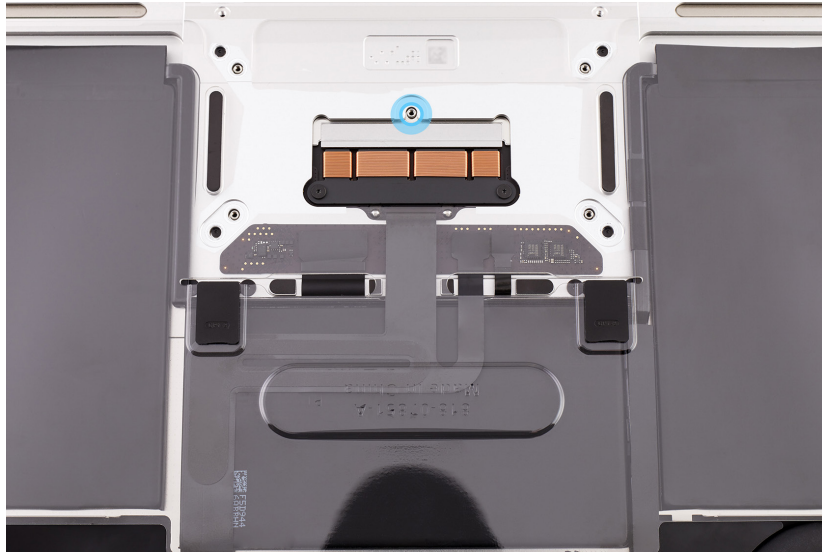

20. Insert the Torx T5 bit into the 10-34 Ncm adjustable torque driver. Set the torque value to 16 Ncm.

21. Use the adjustable torque driver and Torx T5 bit to reinstall the remaining four inner corner T5 screws (923-02880).

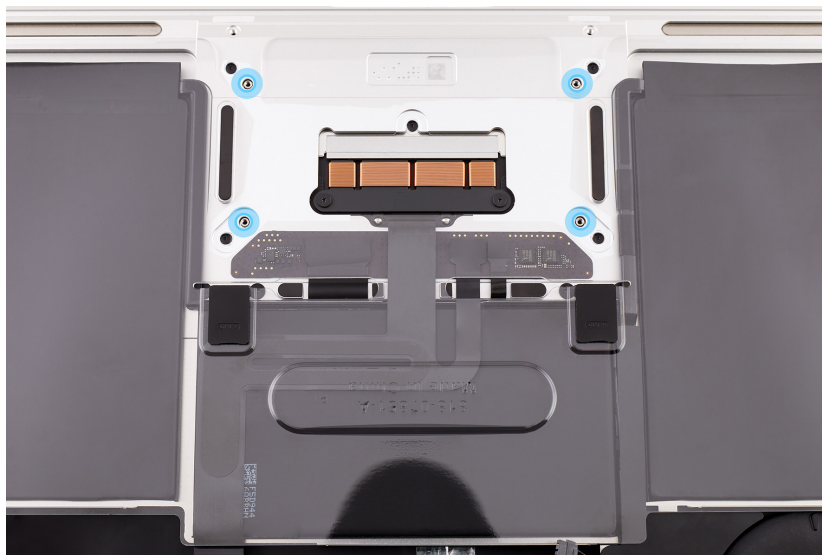

22. Hold the battery cover by the edges and lift it off the top case.



23. Press the end of the IPD flex cable to the connector. Then gently press the flex cable to adhere it to the battery.

**Important**

If you're installing a replacement IPD flex cable, remove the adhesive backing before adhering the flex cable to the battery.

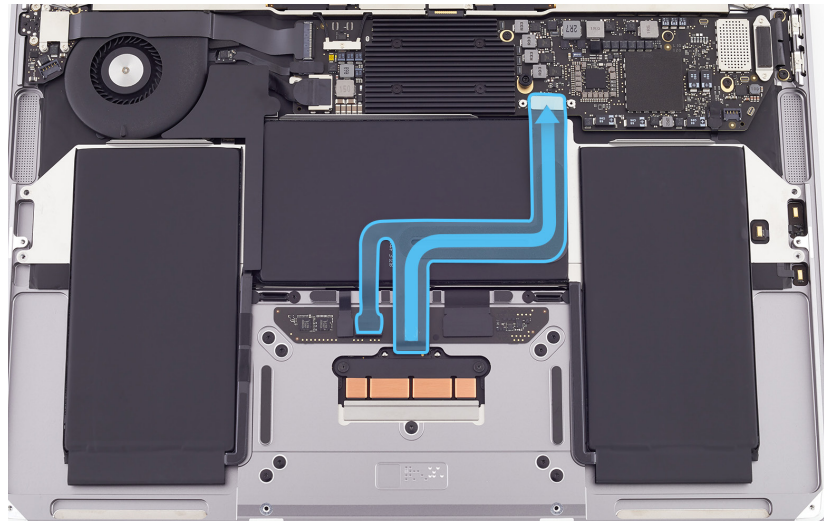

24. Place the battery cover on the battery and press the black tabs into the clips on the top case until you feel a click.

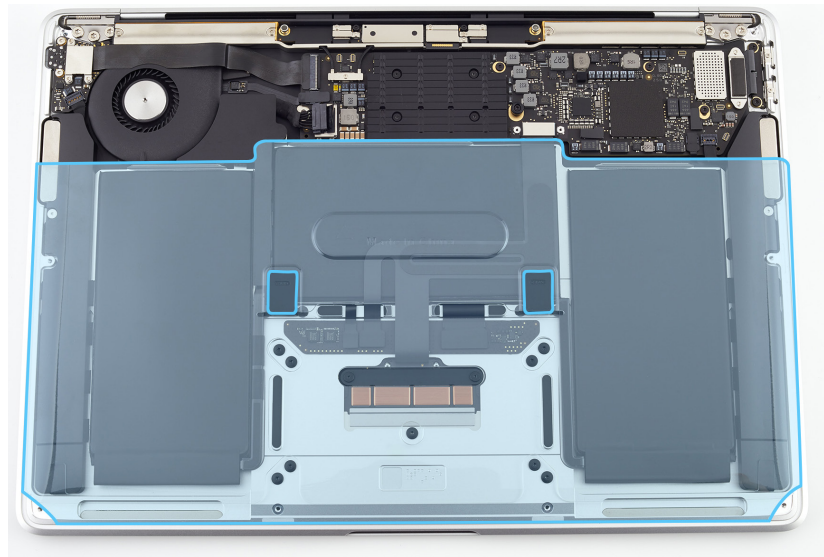

25. Position the IPD connector cowling over the end of the IPD flex cable.
26. Use the T3 screwdriver to reinstall the two T3 screws (923-04003) into the IPD connector cowling.

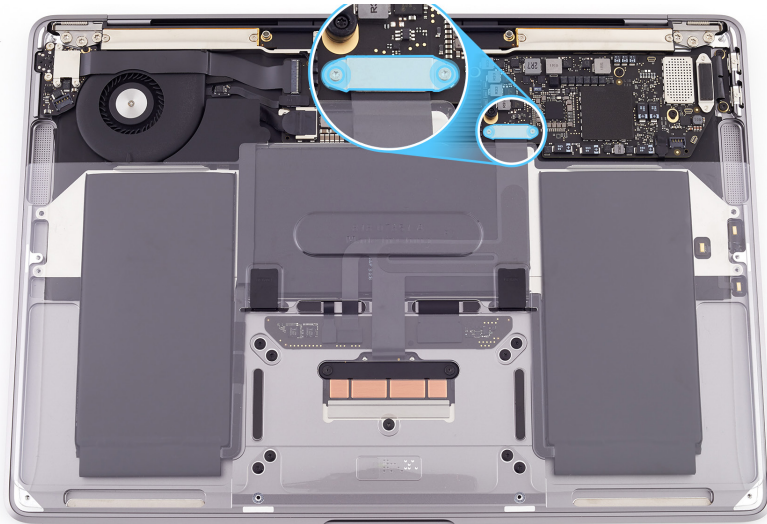

27. Turn over the computer. Use the flat end of the black stick to lift off the gap offsets and Kapton tape.

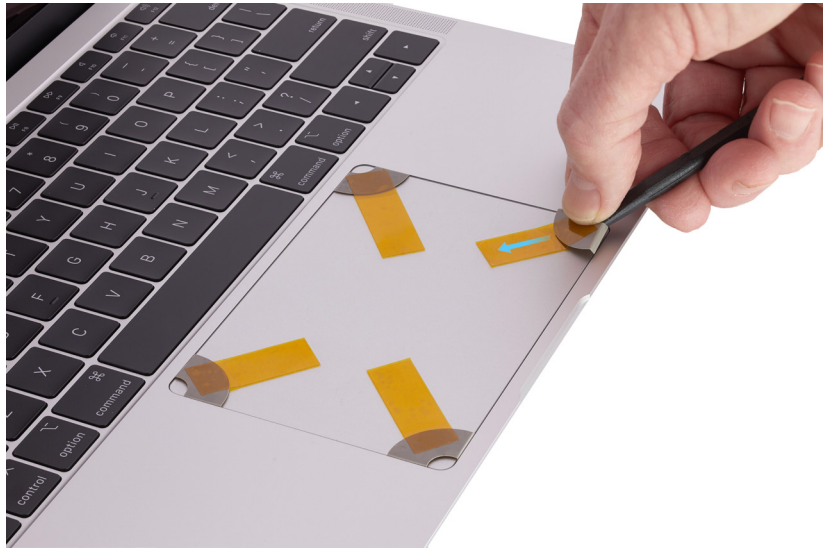

**Reinstall the following part to complete reassembly:**

- [Bottom case](#)

# Audio Board

## Before You Begin

Remove the following part before you begin:

- [Bottom case](#)

### Tools

- EarPods with 3.5 mm headphone plug
- Kapton tape
- Torx T3 screwdriver
- Torx T5 screwdriver

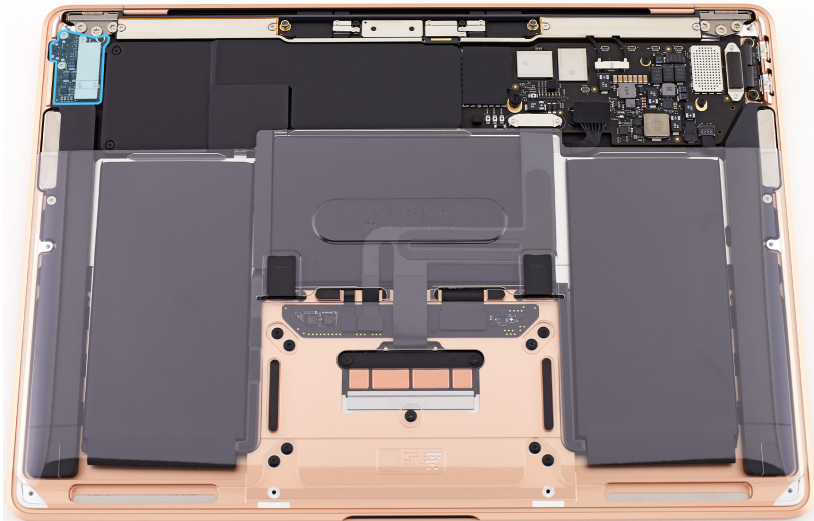

## Removal

1. Use the T3 screwdriver to remove the three T3 screws (923-04003) from the audio board connector cowling.
2. Remove the audio board connector cowling and save it for reassembly.

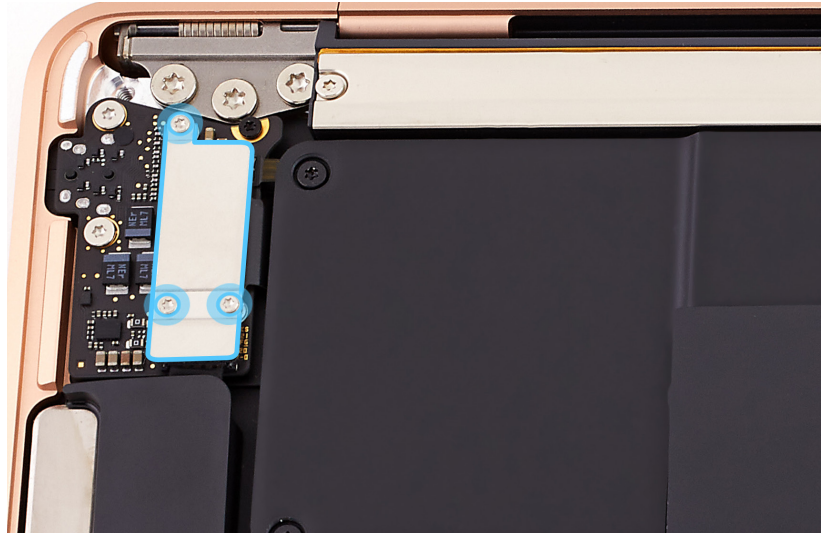

3. Lift the ends of the following three flex cables (1–3) from the connectors:
  - Touch ID board flex cable (1)
  - Audio board flex cable (2)
  - Speaker flex cable (3)

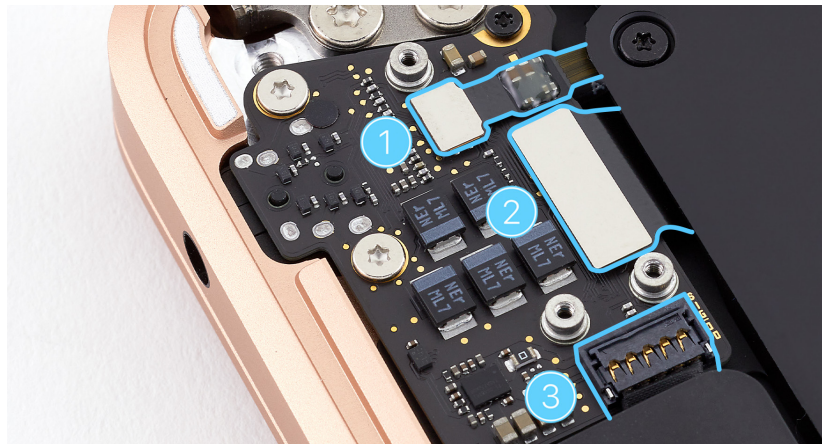



4. Use the T3 screwdriver to remove the T3 screw (923-02884) (1) from the audio board.
5. Use the T5 screwdriver to remove the two T5 screws (923-04005) (2) from the audio board.

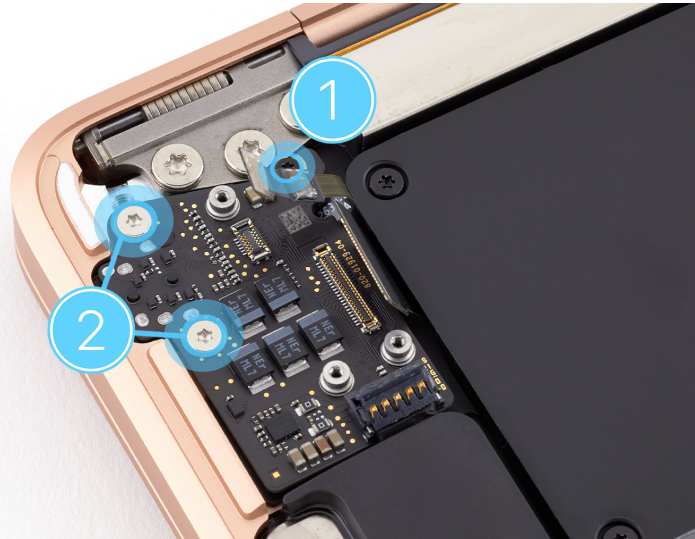

6. Lightly tape the flex cables out of the way with Kapton tape.
7. Hold the audio board by the edges. Tilt up the right side of the audio board. Then lift it away from the bottom case.



## Reassembly

1. With the flex cables still taped out of the way, hold the audio board by the edges and tilt it into the top case.

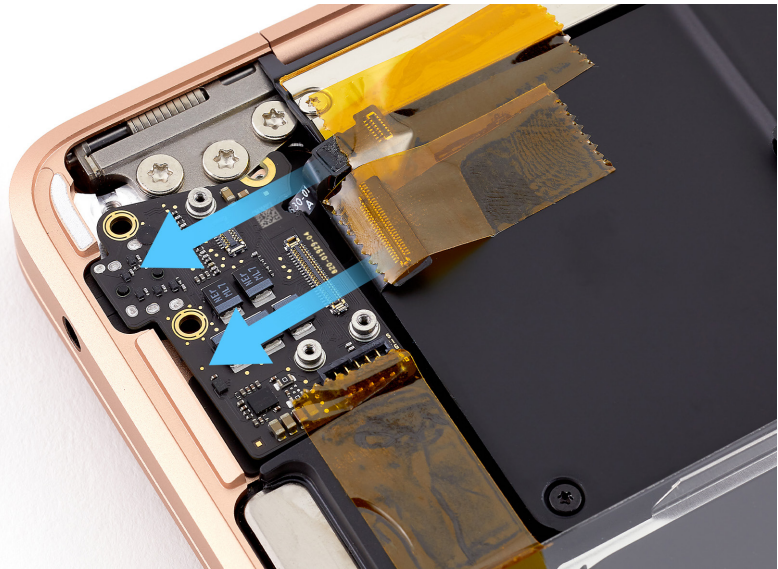

2. Remove and discard the Kapton tape.

3. Use the T3 screwdriver to partially reinstall one T3 screw (923-02884) (1) into the audio board.

4. Use the T5 screwdriver to partially reinstall the two T5 screws (923-04005) (2) into the audio board.

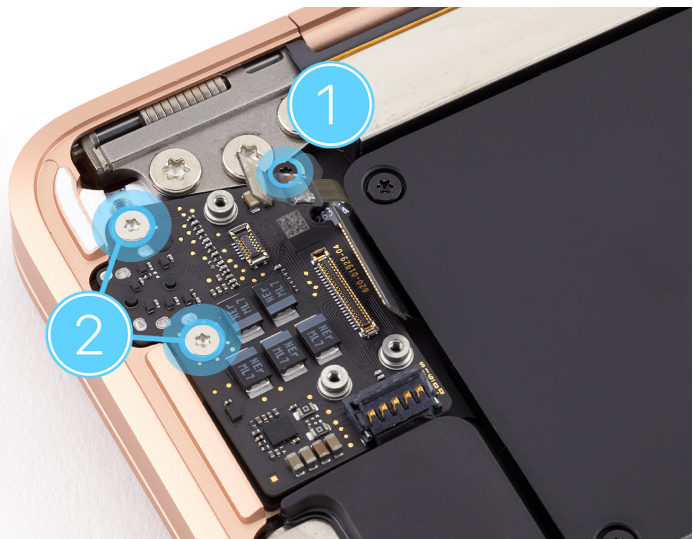

5. Press the ends of the following three flex cables (1–3) to the connectors:
  - Touch ID board flex cable (1)
  - Audio board flex cable (2)
  - Speaker flex cable (3)

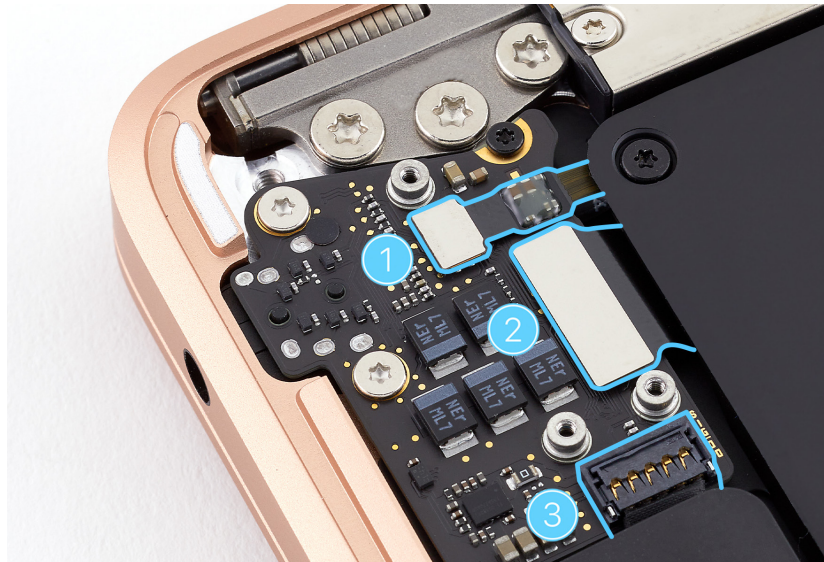

6. Plug the EarPods into the 3.5 mm headphone jack to ensure audio board alignment. Adjust the alignment of the audio board until the plug is easy to insert and remove.

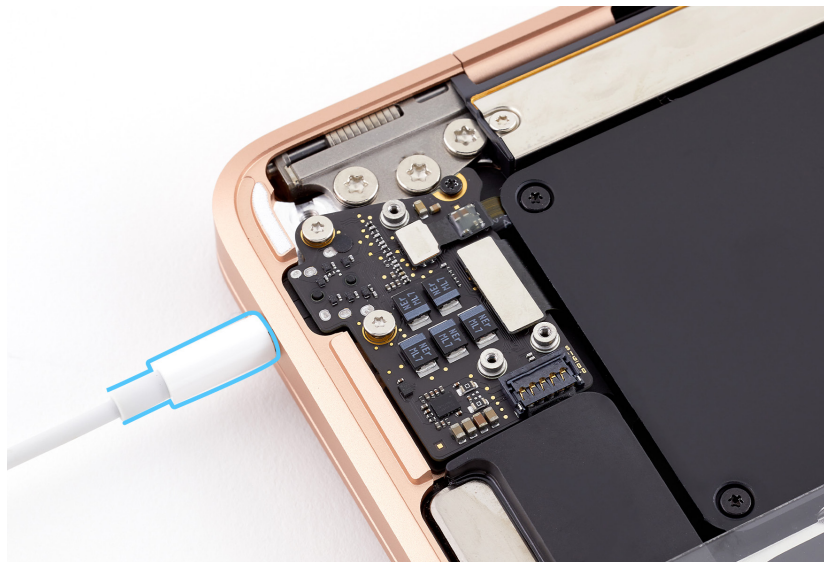



7. Use the T3 screwdriver to fully reinstall the T3 screw (1).
8. Use the T5 screwdriver to fully reinstall the T5 screws (2).

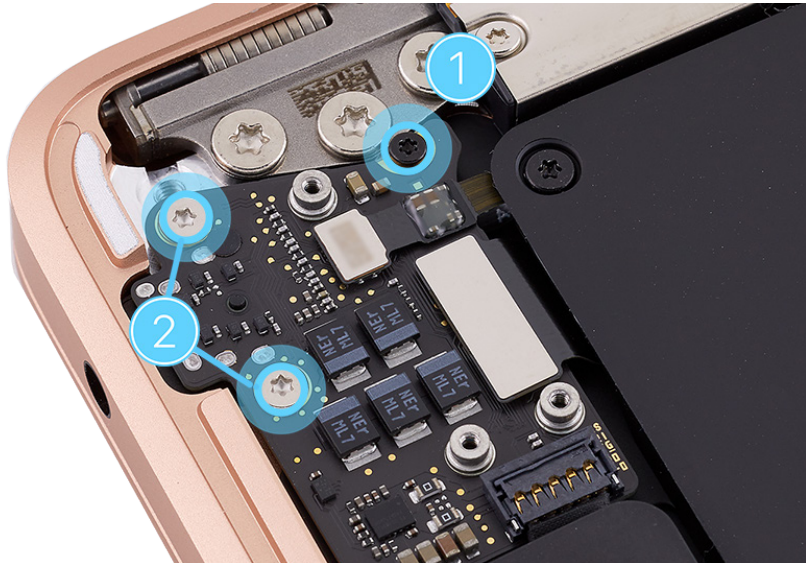

9. Position the audio board connector cowling over the ends of the audio board, Touch ID board, and speaker flex cables.
10. Use the T3 screwdriver to reinstall the three T3 screws (923-04003) into the cowling.

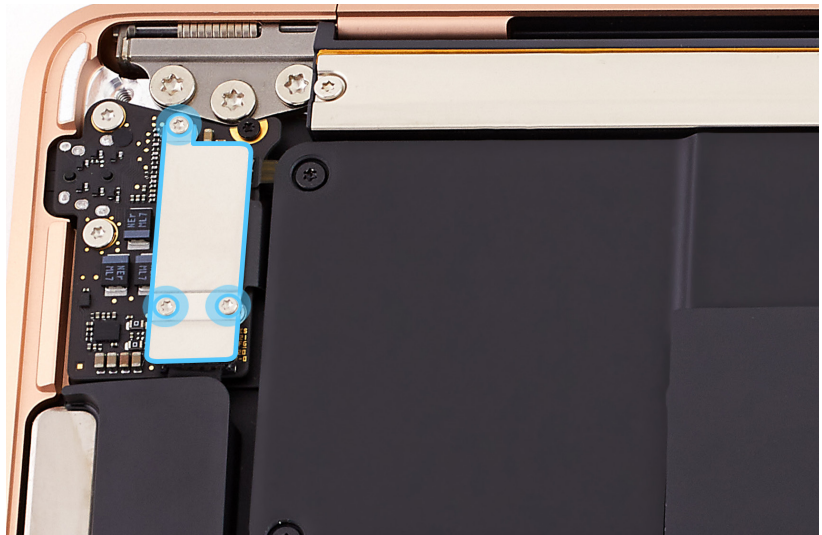

**Reinstall the following part to complete reassembly:**

- [Bottom case](#)

# Audio Board Flex Cable

## Before You Begin

Remove the following parts before you begin:

- [Bottom case](#)
- [Logic board](#)

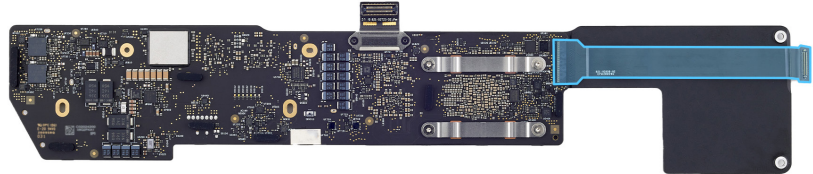

## Tools

- Nylon probe (black stick)

## Removal

1. Turn over the logic board.
2. Use the black stick to flip up the locking lever at the end of the audio board flex cable (1).
3. Slide the end of the audio board flex cable out of the connector (2).

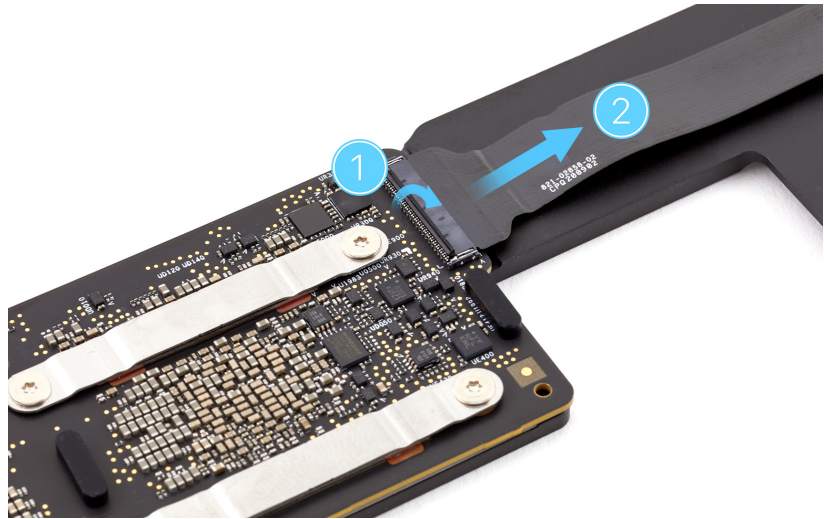

## Reassembly

1. Slide the end of the audio board flex cable into the connector on the logic board (1).
2. Flip down the locking lever (2).

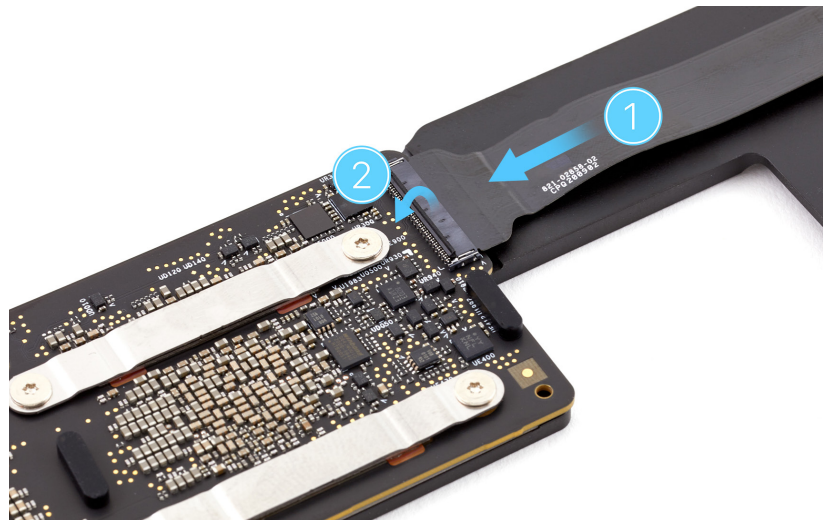

3. Turn over the logic board.

### Reinstall the following parts to complete reassembly:

- [Logic board](#)
- [Bottom case](#)

# Embedded DisplayPort Flex Cable with Connector Cowling

## Before You Begin

Remove the following parts before you begin:

- [Bottom case](#)
- [Logic board](#)

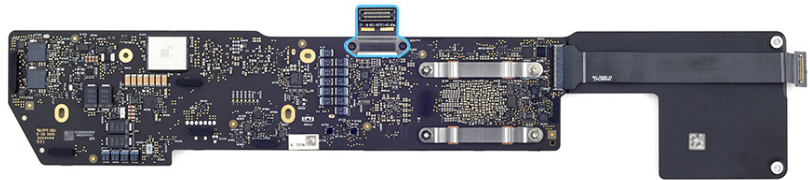

## Tools

- Nylon probe (black stick)
- Torx T3 screwdriver

## Removal

1. Turn over the logic board.
2. Use the T3 screwdriver to remove the two T3 screws (923-02890) from the eDP flex cable with connector cowling.

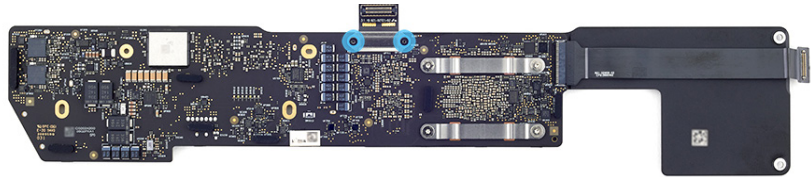

3. Use the flat end of the black stick to lift the end of the eDP flex cable with connector cowling off the connector.

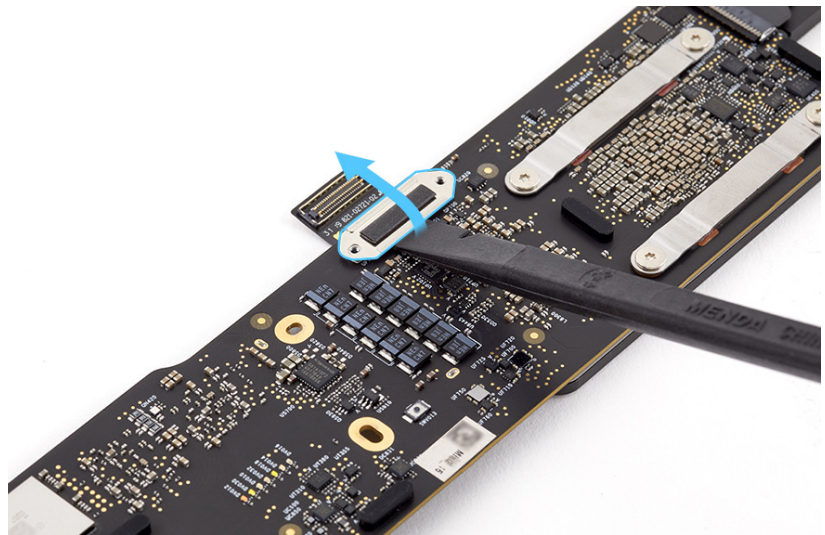



## Reassembly

1. Use the flat end of the black stick to press the end of the eDP flex cable with connector cowling to the connector.

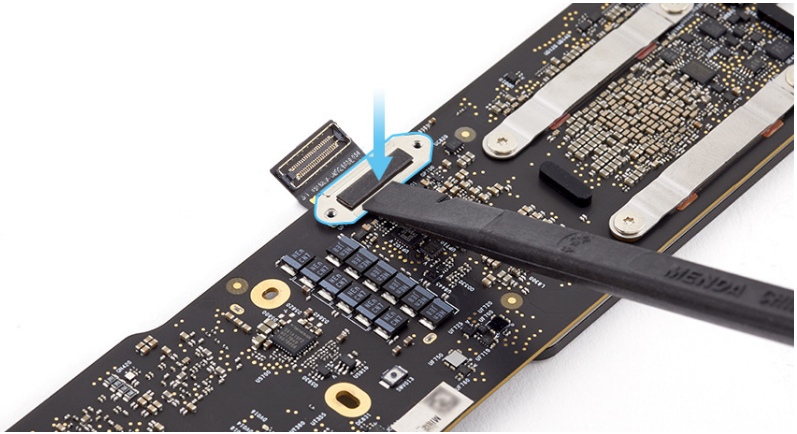

2. Use the T3 screwdriver to reinstall the two T3 screws (923-02890) into the eDP flex cable with connector cowling.

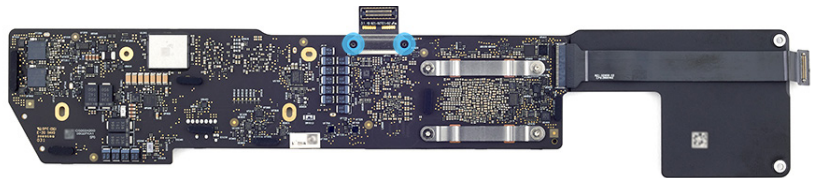

3. Turn over the logic board.

### Reinstall the following parts to complete reassembly:

- [Logic board](#)
- [Bottom case](#)

# Antenna Module

## Before You Begin

Remove the following parts before you begin:

- [Bottom case](#)
- [Logic board](#)

### Tools

- Antenna tool
- ESD-safe tweezers
- Ethanol wipes or isopropyl alcohol (IPA) wipes
- Nylon probe (black stick)
- Torx T5 screwdriver

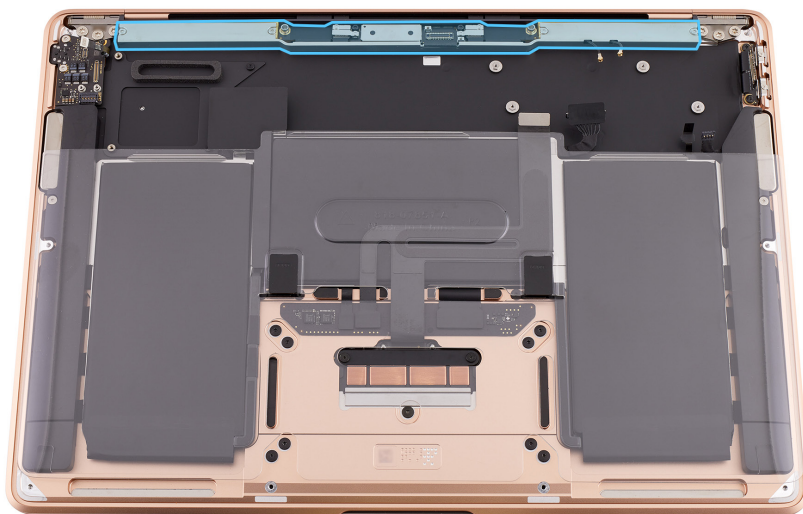

### Important

This procedure may require replacement antenna gasket and tape.

## Removal

### **Caution**

The antenna module is fragile. Don't bend it.

1. Use the T5 screwdriver to remove the four T5 screws (923-04700) from the antenna module (1).
2. Use the T5 screwdriver to remove the two T5 screws (923-03679) from the timing controller (TCON) board (2).
3. Gently slide the flat end of the black stick below one of the four screw holes (1) to loosen the antenna module from the tape on the top case. Then rotate the black stick until you feel a click (2).

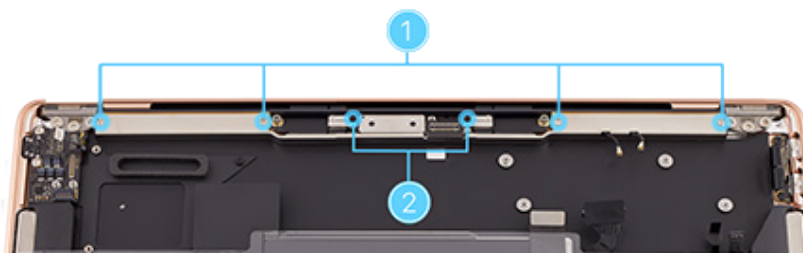

4. Repeat this motion below the other three screw holes to release the antenna module from the tape.



5. If the antenna module doesn't release from the tape, slowly and gently slide the black stick under the module to loosen it.



6. Lift the antenna module out of the top case.



## Reassembly

### **Caution**

If the liner inside the top case looks wrinkled or misaligned, replace the top case before proceeding.

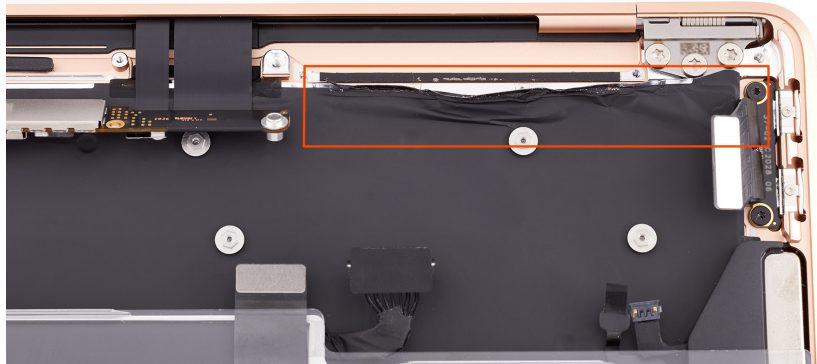

1. Inspect both sides of the top case for damage to the tape. If the tape looks like these examples, skip to step 7.





2. If the tape is wrinkled or misaligned but not torn (1), use the pointed end of the black stick to smooth it (2). Then skip to step 7. If the tape is torn away from the top case (3), use ESD-safe tweezers to remove the tape.

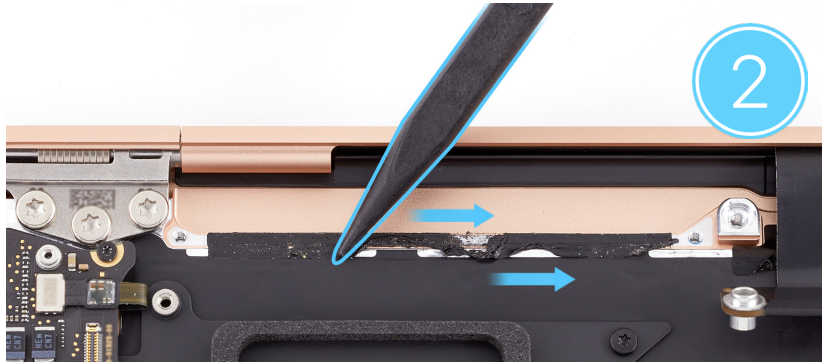

3. Use an ethanol wipe or IPA wipe to clean any adhesive residue from the top case.
4. Peel the adhesive backing from the replacement tape.
5. Use ESD-safe tweezers to position the tape in the top case.
6. Use the flat end of the black stick to smooth the tape into place.

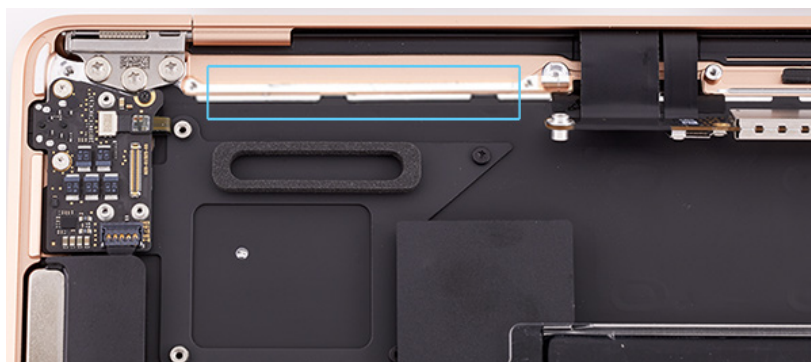



7. Inspect the gaskets for damage on the right and left sides of the antenna module. If the gaskets look like these examples, skip to step 13.

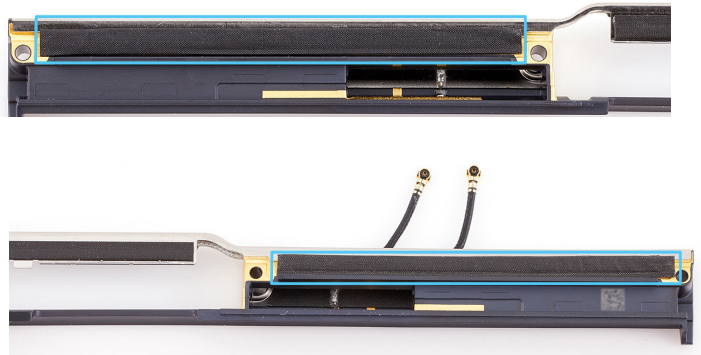

8. If one or both of the gaskets are wrinkled (1), use the flat end of the black stick to smooth them (2). Then skip to step 13. If one or both of the gaskets are torn (3), use ESD-safe tweezers to remove the gaskets.

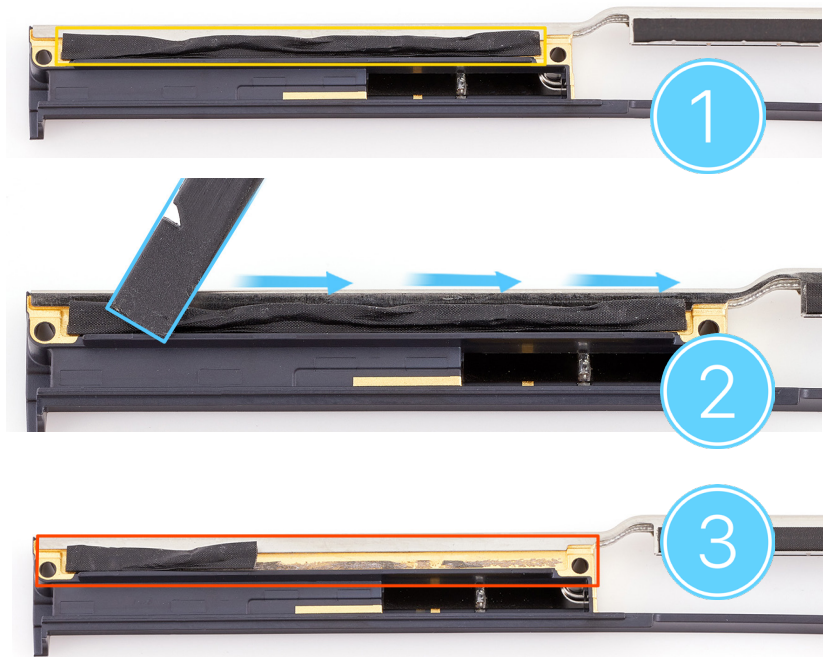

9. Use an IPA wipe to clean any adhesive residue from the antenna module.

10. Peel the adhesive backing from the replacement gasket.

11. Use ESD-safe tweezers to position the gasket on the antenna module (1).



12. Use the flat end of the black stick to smooth the gasket into place (2).

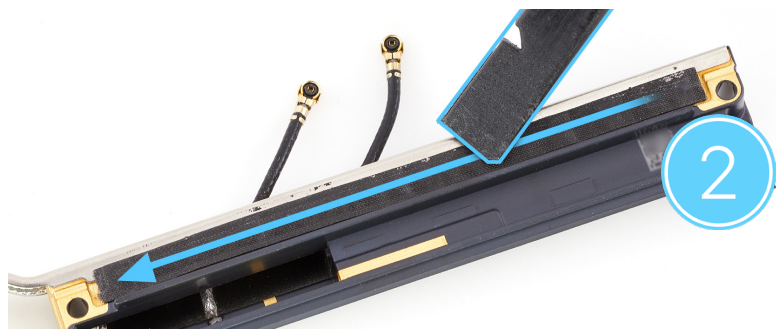

**!** **Caution**

If part of one or both of the gaskets remains adhered to the tape on either side of the top case, replace the affected gasket and tape.

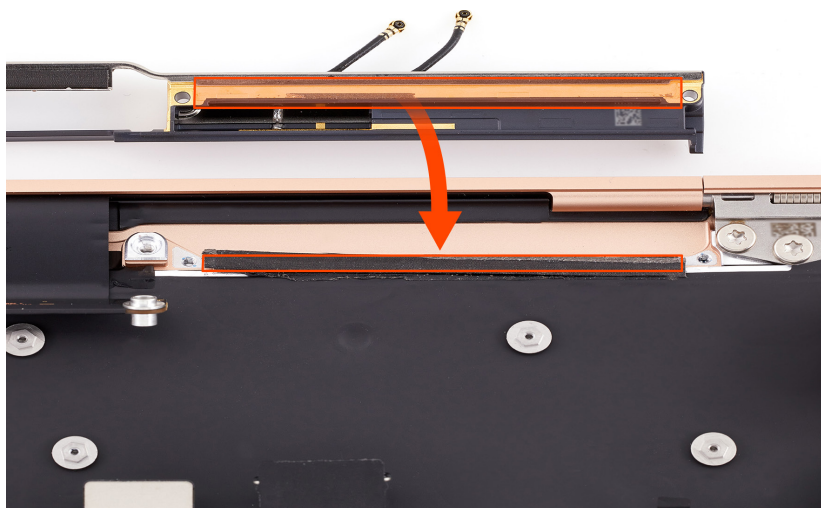

13. Lower the antenna module into the top case with the gasket side down. Route the TCON board through the opening of the antenna module.

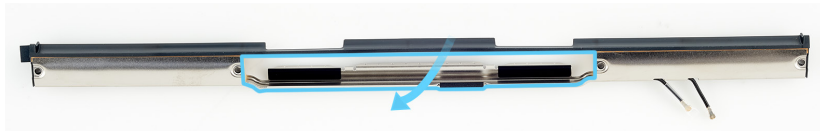

14. Use the blunt end of the antenna tool to press the middle of the antenna module until you feel it lock into place.

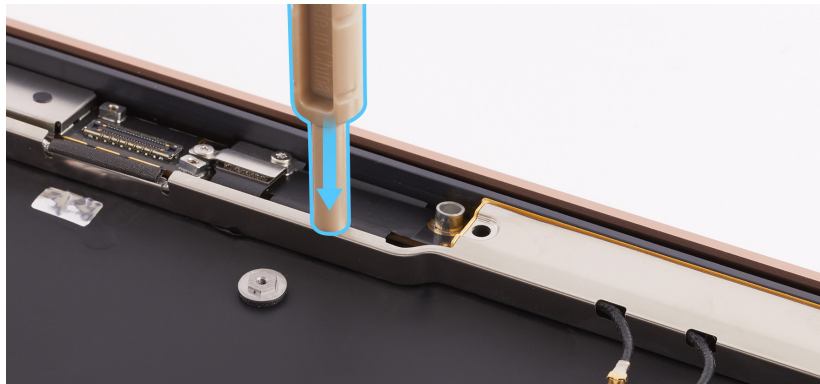

15. Gently wiggle the antenna module to ensure that it's securely attached.

16. Use the T5 screwdriver to reinstall the four T5 screws (923-04700) into the antenna module (1).

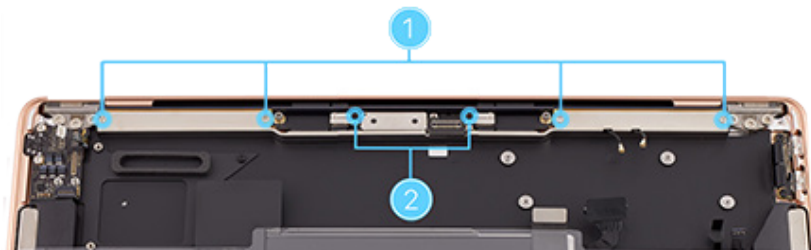

17. Position the TCON board so it lays flat in the opening of the antenna module.

18. Use the T5 screwdriver to reinstall the two T5 screws (923-03679) into the TCON board (2).

**Reinstall the following parts to complete reassembly:**

- [Logic board](#)
- [Bottom case](#)

# Display

## Before You Begin

Remove the following parts before you begin:

- [Bottom case](#)
- [Logic board](#)
- [Antenna module](#)

### Tools

- Torx T8 screwdriver



### Important

This procedure requires [System Configuration](#). After you've completed all removal and reassembly steps, learn how to initiate the System Configuration process at [support.apple.com/self-service-repair](https://support.apple.com/self-service-repair)

## Removal

1. Open the display to a 90-degree angle. Then place the computer on the edge of the table with the display hanging down.



2. Use the T8 screwdriver to remove the six T8 screws (923-03997) from the display hinges.





3. Pull the display toward you about 15 degrees (1). Move the display away from you to allow the hinges to clear the edge of the top case. Then lift the display up and out of the top case (2).

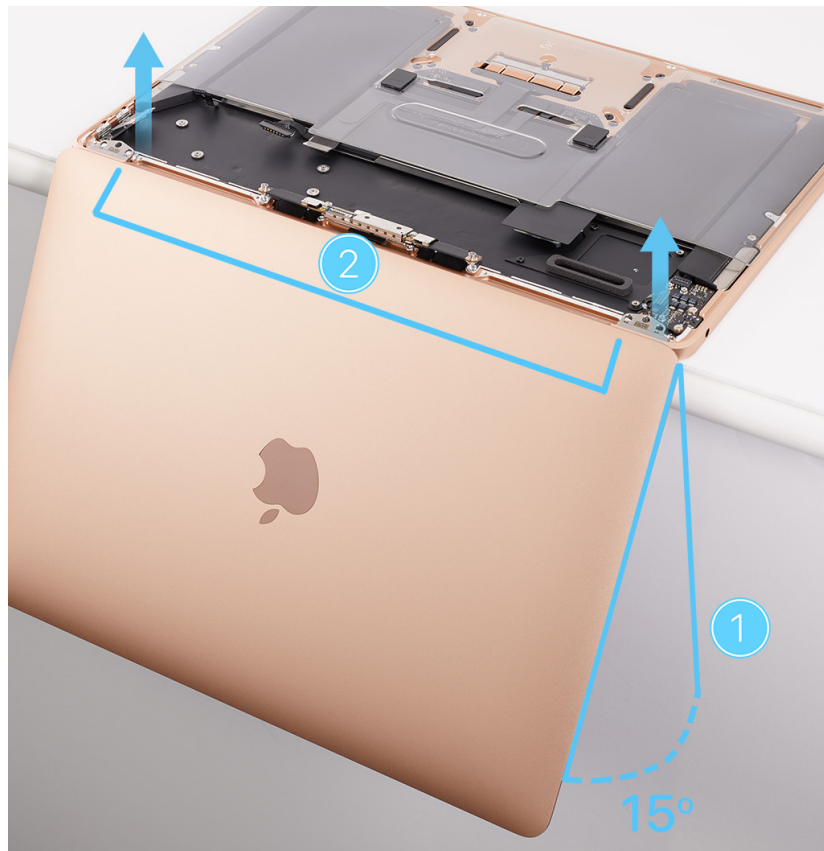



## Reassembly

### Important

Ensure that you remove all protective liners and tape from a replacement display.

1. Place the display on the top case.

**Note:** The display includes the TCON board.



2. Ensure that the TCON board is inside the top case.



- Use the T8 screwdriver to partially reinstall the six T8 screws (923-03997) into the display hinges in the order shown.



- Close the display and adjust it until it's flush with the top case.



- Use the T8 screwdriver to fully reinstall the six T8 screws into the display hinges.

**Reinstall the following parts to complete reassembly:**

- [Antenna module](#)
- [Logic board](#)
- [Bottom case](#)

**Important**

After you've completed all removal and reassembly steps, learn how to initiate the System Configuration process at [support.apple.com/self-service-repair](https://support.apple.com/self-service-repair).

# Battery

## Before You Begin

### **Warning**

Read [Battery Safety](#) and follow workspace and battery handling guidelines before you begin.

### Remove the following parts before you begin:

- [Bottom case](#)
- [Speakers](#)

### Tools

- Battery support frame and press plate
- ESD-safe tweezers
- Ethanol wipes or isopropyl alcohol (IPA) wipes
- iPhone display press
- Nylon probe (black stick)
- Torx T3 screwdriver

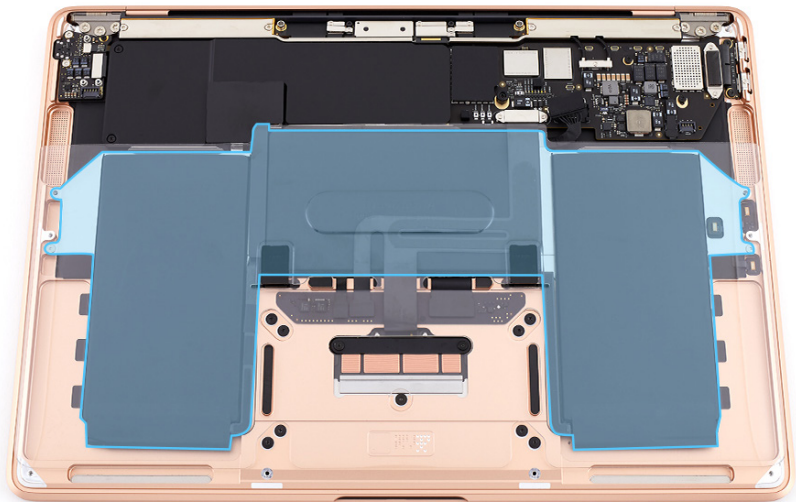

### **Important**

This procedure requires battery adhesive and alignment pins. Alignment pins are available only with a replacement battery or top case. They are not separately orderable parts.

## Removal

1. Use the T3 screwdriver to remove the two T3 screws (923-04003) from the IPD connector cowling.
2. Remove the IPD connector cowling and save it for reassembly.

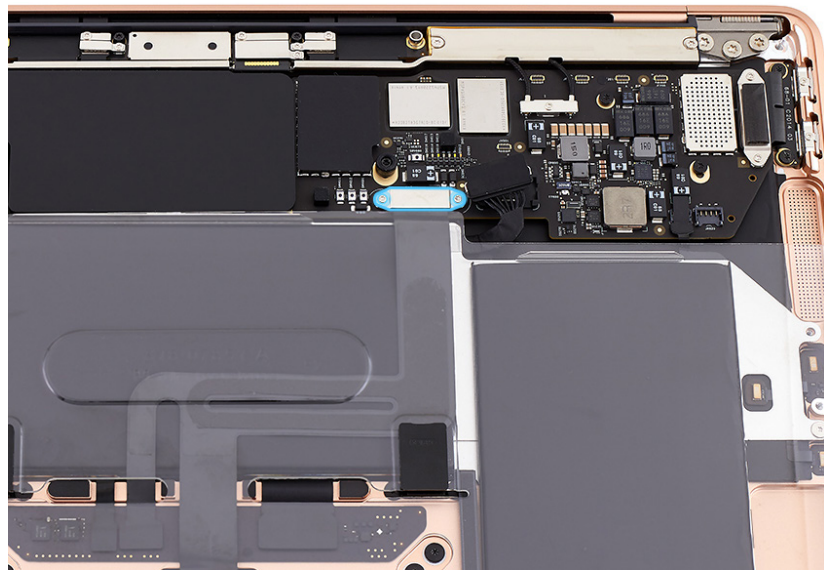

3. Hold the battery cover by the edges and lift it off the top case.

4. Lift the end of the IPD flex cable off the connector (1). Then gently peel the flex cable off the battery (2).

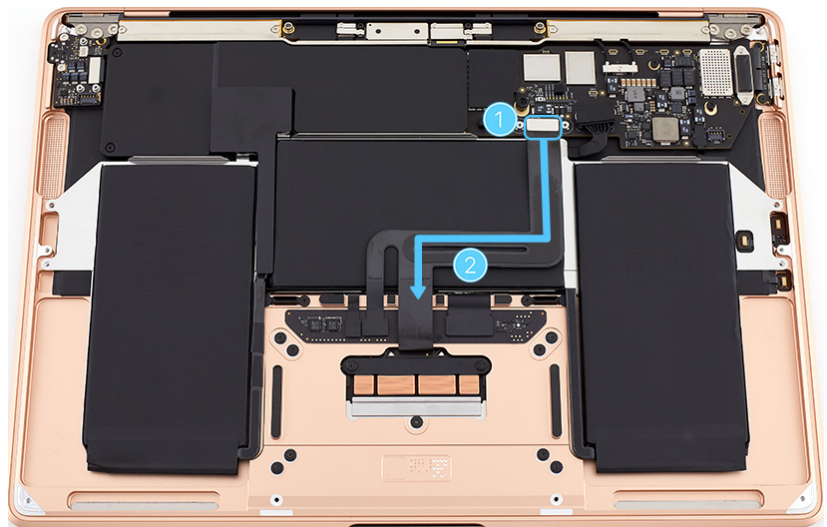



5. Place the battery cover on the battery. Then press the black tabs into the clips on the top case until you feel a click.

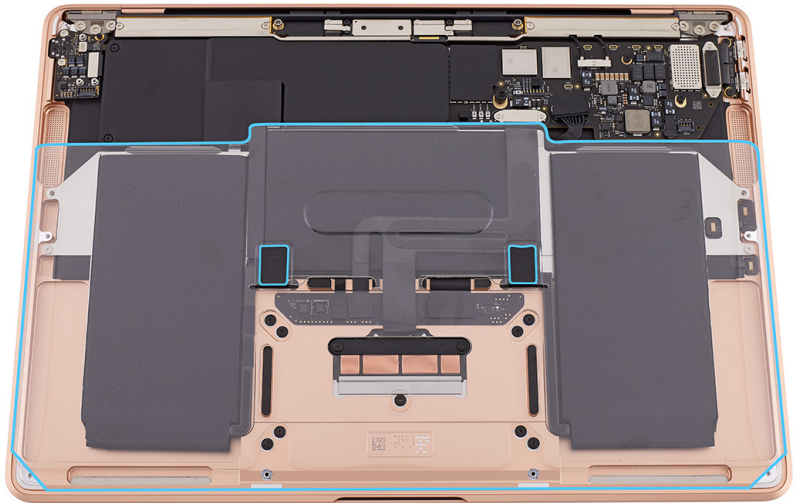

6. Tilt up the side of the battery cover to access the battery adhesive tabs. Press and hold the battery cover tab to ensure that it remains clipped into the top case.





7. Use ESD-safe tweezers to grasp the battery adhesive tab.



8. Gently peel the battery adhesive tab off the top case. Slowly pull the adhesive tab past the battery cover. As the adhesive strip stretches, twist the tweezers to wrap the strip around them. Continue to slowly pull and twist the tweezers until you've removed the entire strip. Then lower the corner of the battery cover.

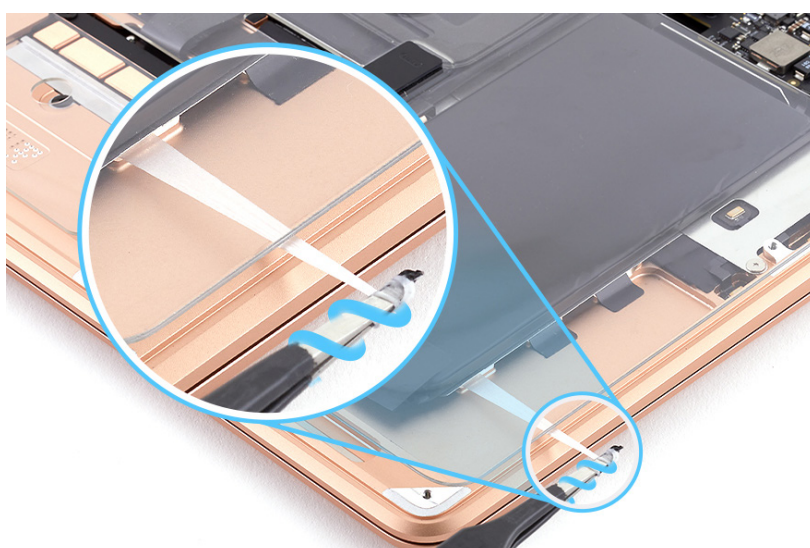

 **Warning**

If an adhesive tab or strip breaks off and can't be retrieved, don't forcibly pry the battery. Stop the repair, refer to [Battery Safety](#), and reassemble the notebook. For service, visit [support.apple.com/repair](https://support.apple.com/repair).

9. Repeat steps 6 through 8 to remove the two remaining battery adhesive strips from this side and the three adhesive strips from the other side. Then continue to step 10.

10. Tilt up one side of the battery cover. Press and hold the battery cover tab to ensure that it remains clipped into the top case. Then use the T3 screwdriver to remove the T3 screw (923-03680) from the battery tray.



11. Repeat step 10 to remove the T3 screw from the battery tray on the other side. Then continue to step 12.

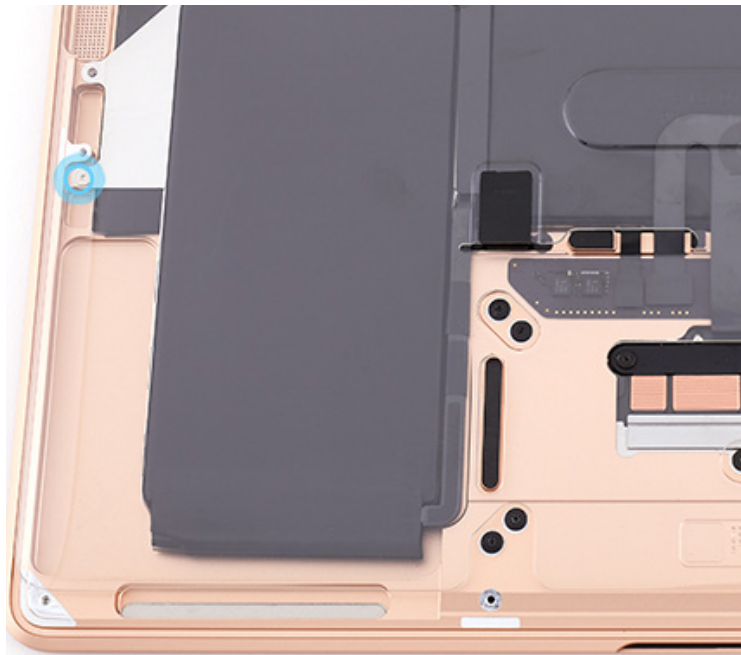

12. Hold the battery cover by the edges and lift it off the top case.

13. Hold each corner of the battery tray and lift the battery out of the top case.

 **Warning**

Don't remove the battery from the battery tray.

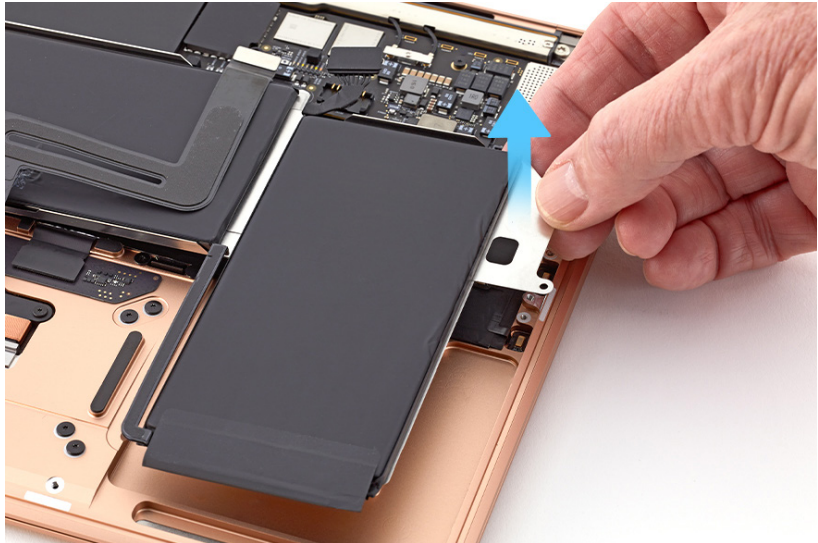

## Reassembly

1. Use ethanol wipes or IPA wipes to clean any battery adhesive residue from the top case.
2. Remove the adhesive backing from the battery adhesive.

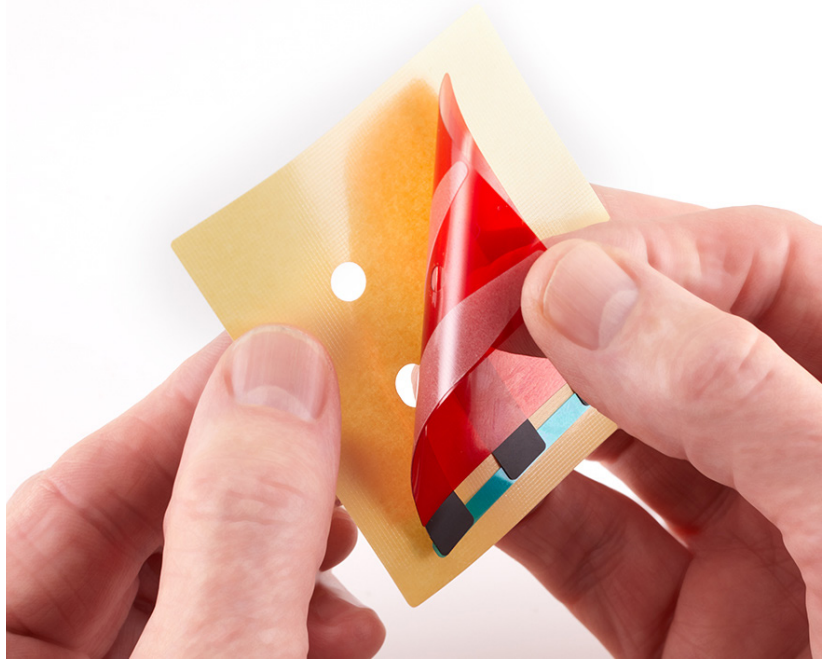

3. Align the battery adhesive over the corner of the top case as shown.





4. Remove the tab release liner strip out from under the three adhesive tabs.



5. Use the flat end of the black stick to press the tabs onto the top case.

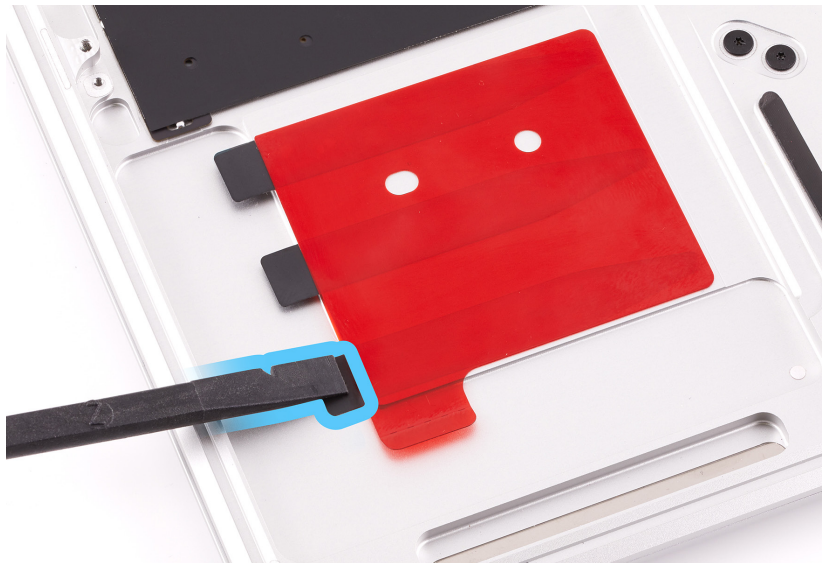

6. Press the top release liner to remove any air bubbles and adhere the battery adhesive strips onto the top case.

7. Peel the top release liner off the battery adhesive strips.



8. Repeat steps 2 through 7 to adhere the second battery adhesive onto the other corner of the top case. Then continue to step 9.

9. Use ESD-safe tweezers to insert the threaded end of an alignment pin into the top screw hole on each side of the top case.

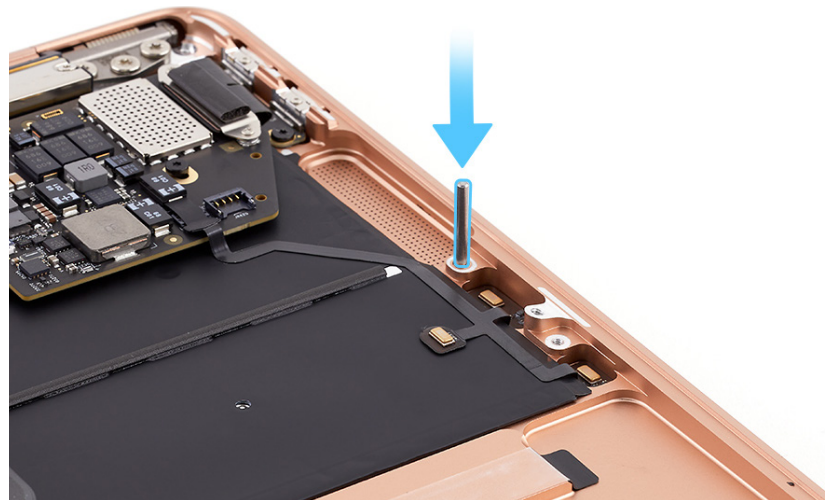



10. Turn the two alignment pins clockwise to screw them into the screw holes.

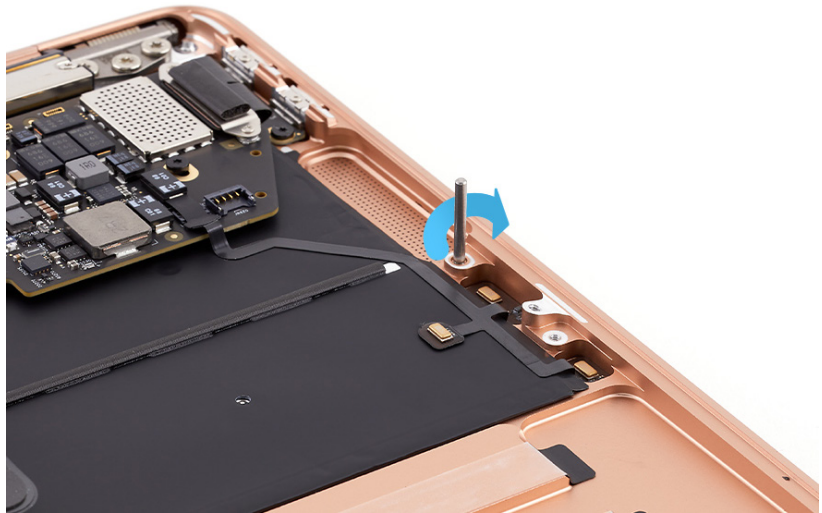

11. Align the screw holes on the battery tray over the alignment pins and lower the battery onto the top case.

### Important

Ensure that the IPD flex cable isn't trapped under the battery.

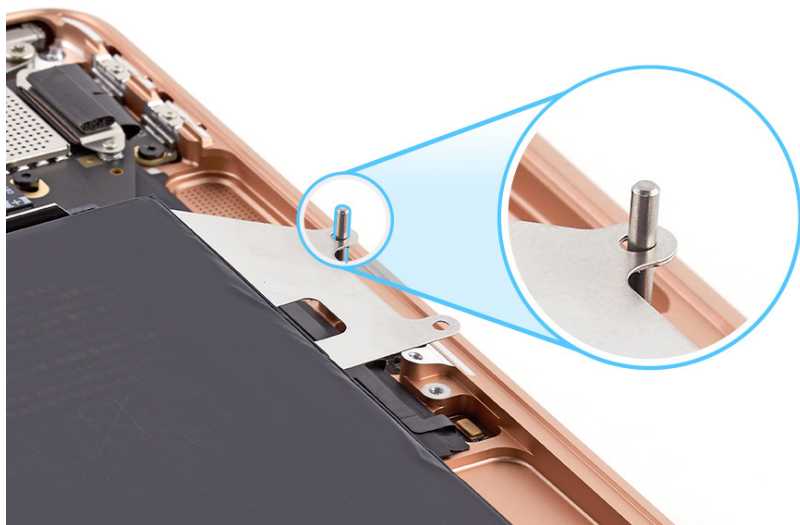

12. Turn the two alignment pins counterclockwise to remove them.
13. Use the T3 screwdriver to reinstall one T3 screw (923-03680) into each side of the battery tray.

14. Place the computer in the support frame with the display hanging over the edge of the table.

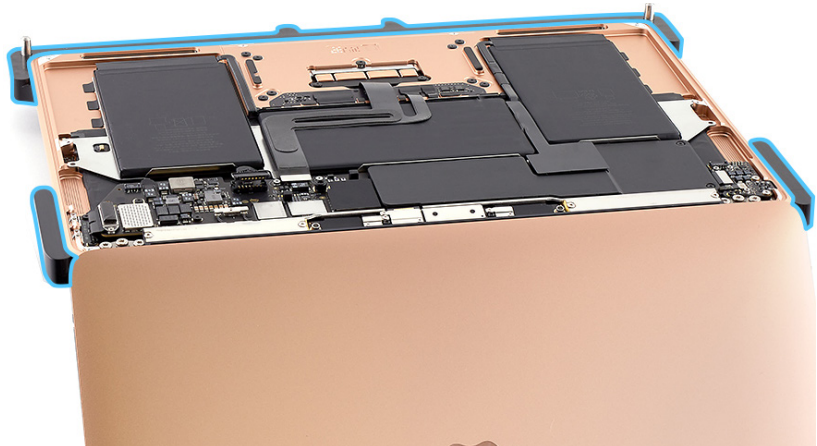

15. Align the holes on the press plate over the pins on the support frame. Lower the press plate onto the battery.

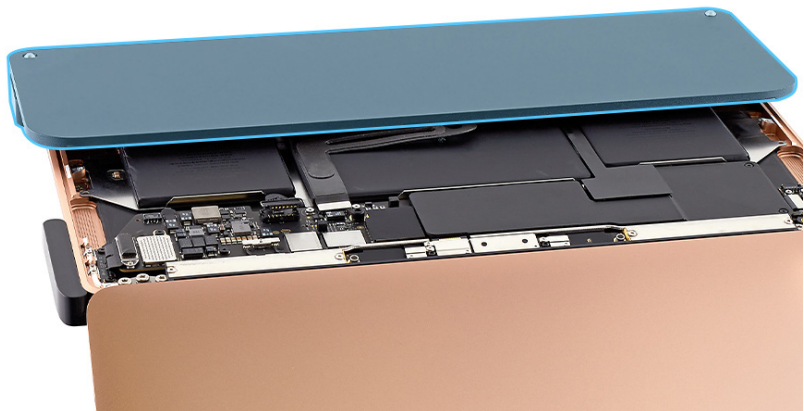

16. Place the support frame in the iPhone display press.

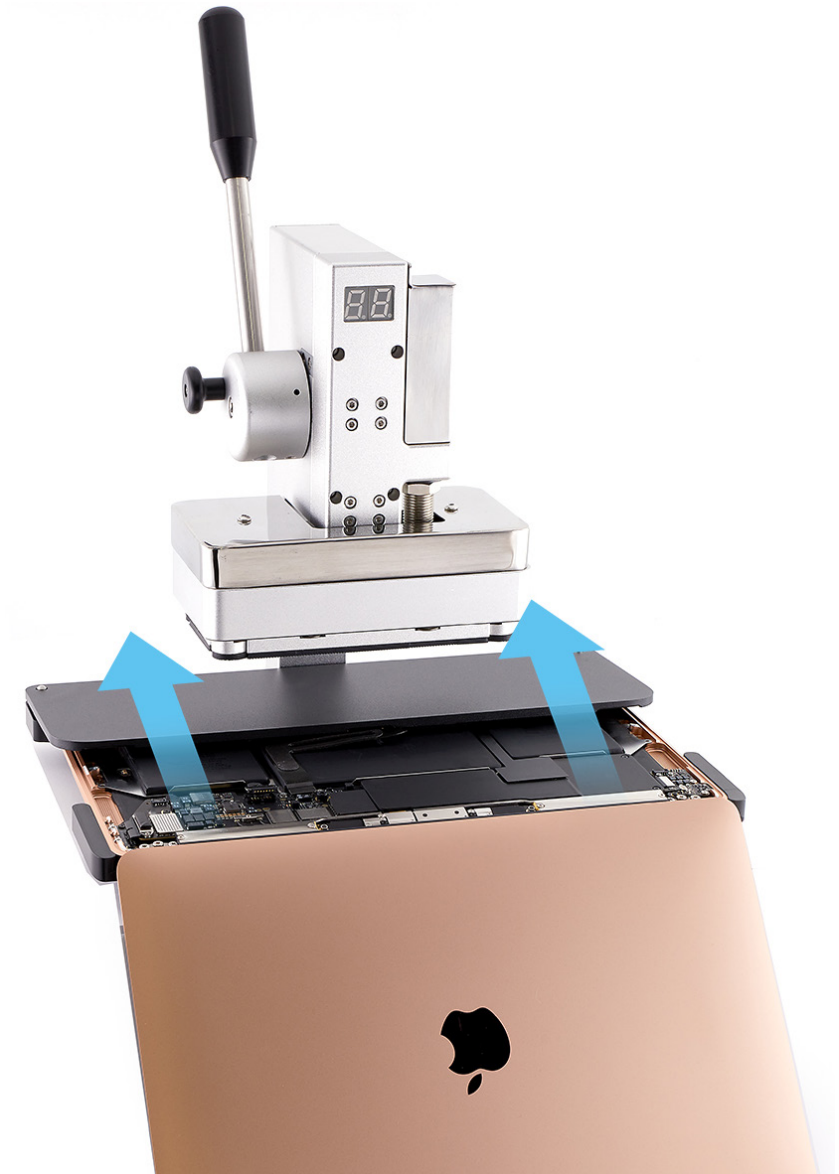

- 17. Ensure that the support frame is aligned with the back of the iPhone display press as shown.

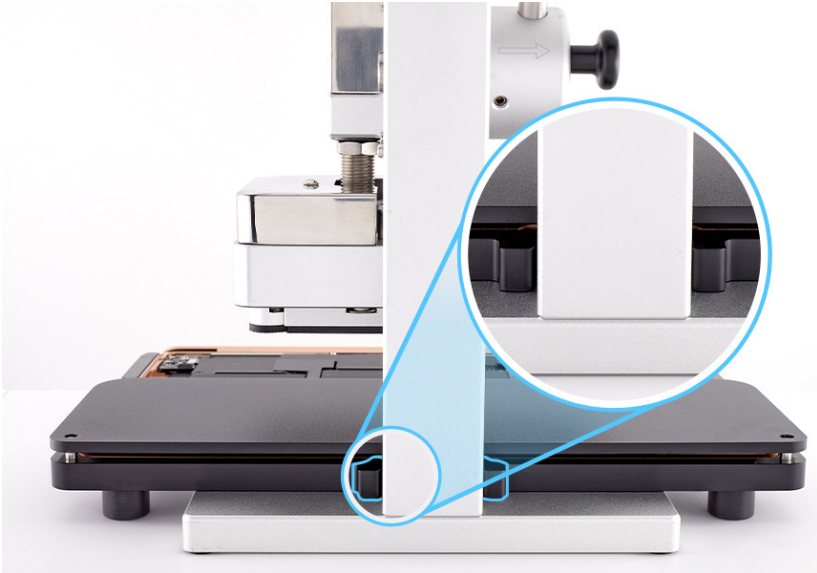

- 18. Pull down the lever until it locks.

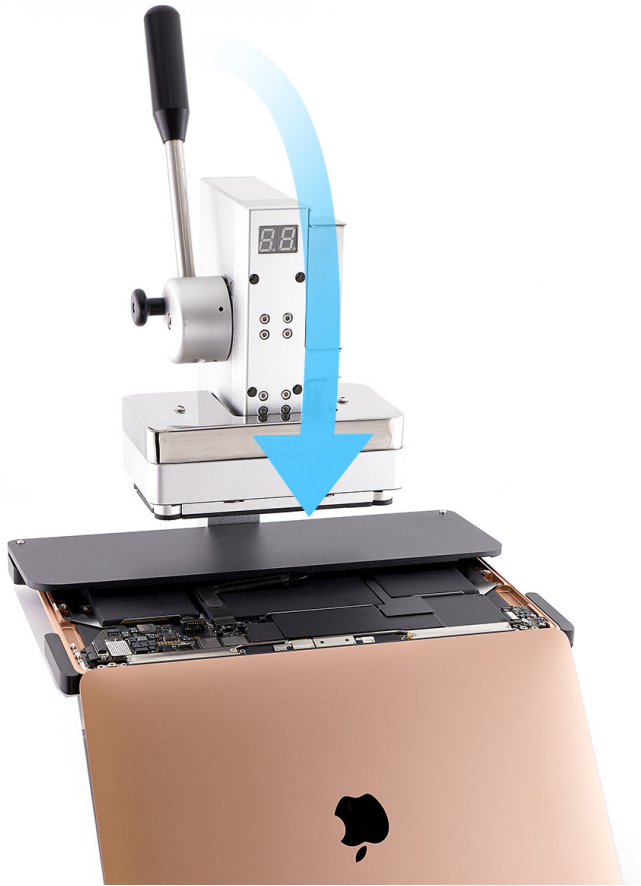

19. Wait until the timer on the iPhone display press beeps (1). Pull down the lever slightly and pull out the release knob (2). Then lift the lever (3).

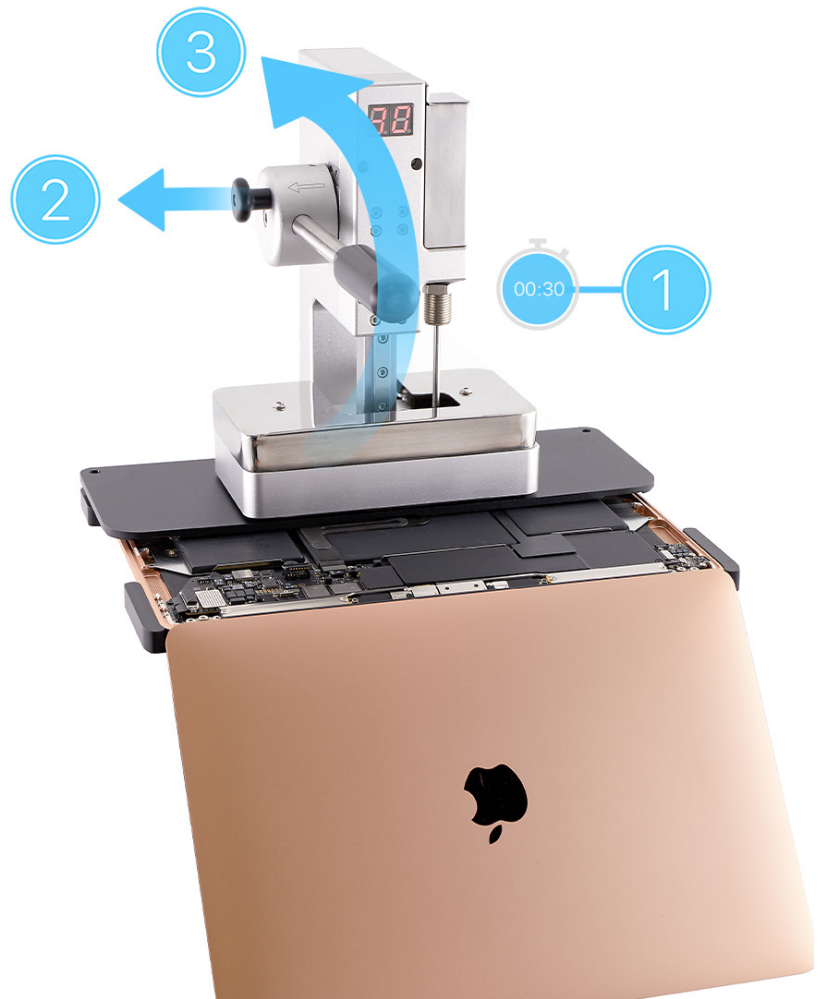



20. Remove the support frame from the iPhone display press. Then lift off the press plate.

21. Remove the computer from the support frame. Close the display and place the computer display-side down.

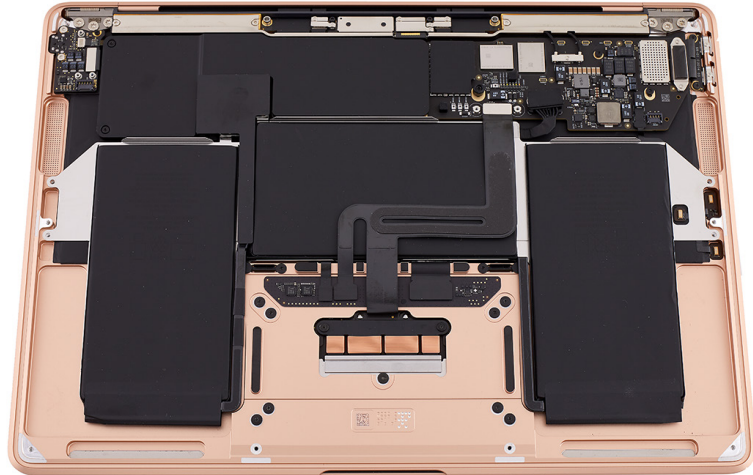

22. Press the end of the IPD flex cable to the connector (1). Then gently adhere the flex cable to the battery (2).

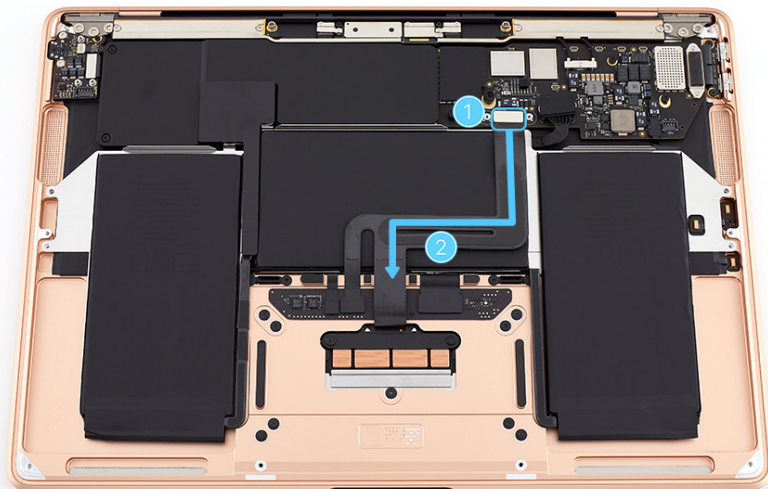

23. Place the battery cover on the battery. Then press the black tabs into the clips on the top case until you feel a click.

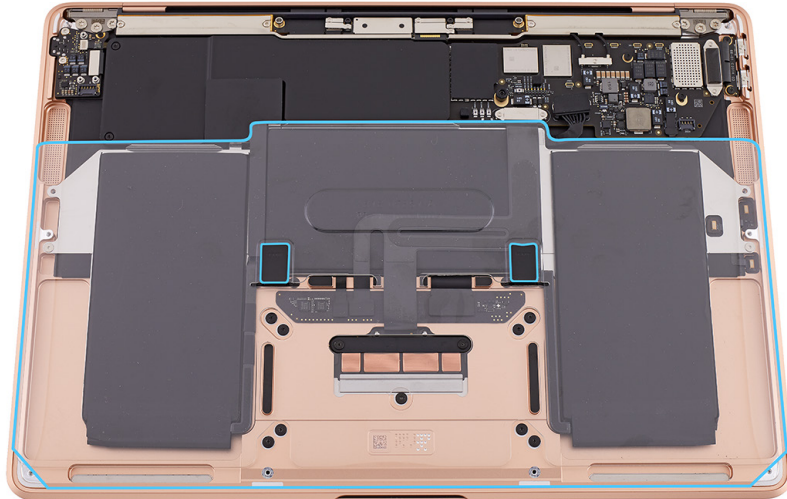

24. Position the IPD connector cowling over the end of the IPD flex cable.

25. Use the T3 screwdriver to reinstall the two T3 screws (923-04003) into the IPD connector cowling.

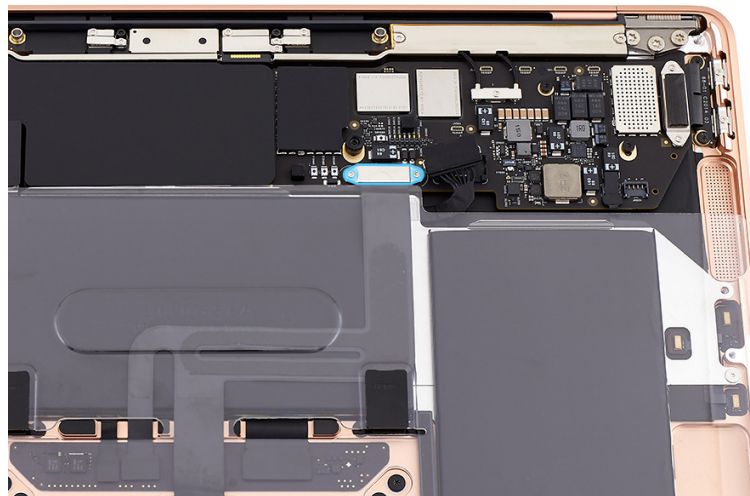

**Reinstall the following parts to complete reassembly:**

- [Speakers](#)
- [Bottom case](#)

# Touch ID Board

## Before You Begin

Remove the following parts before you begin:

- [Bottom case](#)
- [Audio board](#)

### Tools

- ESD-safe tweezers
- Kapton tape
- Torx T3 screwdriver
- Touch ID alignment kit

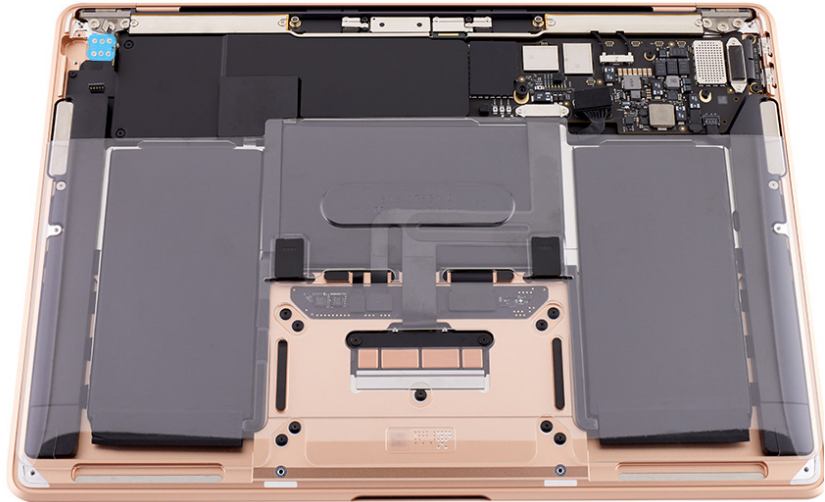

### Important

- This procedure requires [System Configuration](#). After you've completed all removal and reassembly steps, learn how to initiate the System Configuration process at [support.apple.com/self-service-repair](https://support.apple.com/self-service-repair).
- This procedure may require a Touch ID board shim kit, which only comes with a replacement Touch ID board. It's not a separate orderable part.

## Removal

1. Use the T3 screwdriver to remove the six T3 screws (923-02888) from the Touch ID board flexible cowling.



2. Use ESD-safe tweezers to remove the Touch ID board flexible cowling. Save the flexible cowling for reassembly.

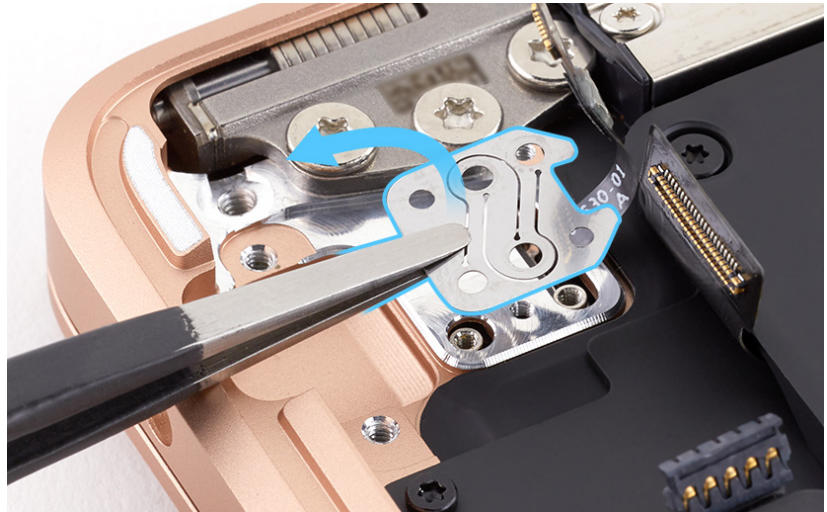

3. Open the display and stand the computer on its side.
4. Support the Touch ID board as you route the Touch ID board flex cable through the slot as shown. Remove the Touch ID board from the keyboard side of the top case.



### Important

- If the Touch ID board wasn't clicking properly before removal or the Touch ID shim falls out when you remove the Touch ID board, continue to step 5 to replace the Touch ID shim.
- Ensure that your work surface is clean. Under the Touch ID board is the Touch ID shim, which is a small circular part. If it falls out, you can more easily find it on a clean surface.
- If you're using the existing Touch ID shim, skip to reassembly step 1.



5. Place the computer right side up. Spread the tips of the ESD-safe tweezers and use one tip to remove the Touch ID shim.

**Note:** The shim has a small amount of adhesive and may stick to the top case.



## Reassembly

1. Place the computer right side up with the display still open.

### **Caution**

Ensure that you place the computer on a clean surface to avoid damaging internal parts.

### **Important**

If you're replacing the Touch ID shim, follow steps 2 through 4. If you're using the existing shim, skip to step 5.

2. Use ESD-safe tweezers to pick up the medium Touch ID shim from the shim kit.

**Note:** The shim is black on the adhesive side and silver on the opposite side.

3. Align the Touch ID shim in the recessed circle in the top case with the adhesive side down.



4. Gently press the Touch ID shim to adhere it to the top case.



5. Set two Y-shaped alignment tools in the Touch ID board opening in the top case as shown. Secure the Y-shaped tools in the corner edges with Kapton tape.



- Stand the computer on its side. Route the Touch ID board flex cable through the slot in the top case. Then position the Touch ID board in the opening in the top case.

**Note:** If you're installing a replacement Touch ID board, remove the protective film from the glass surface.

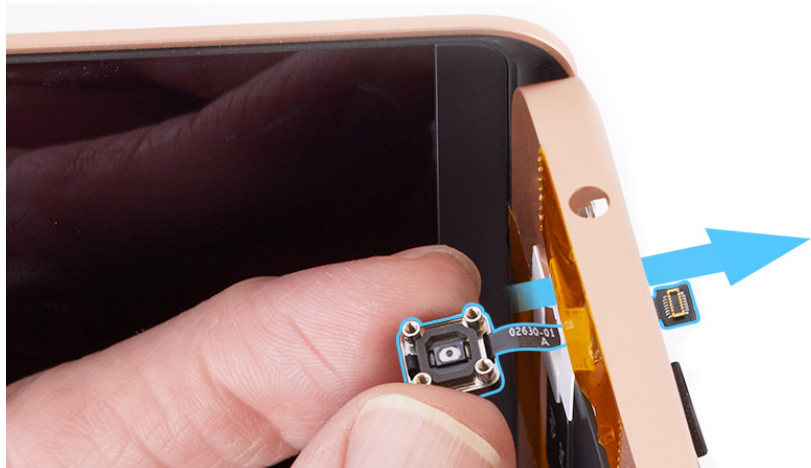

- Place the computer on the edge of the table with the display hanging down.

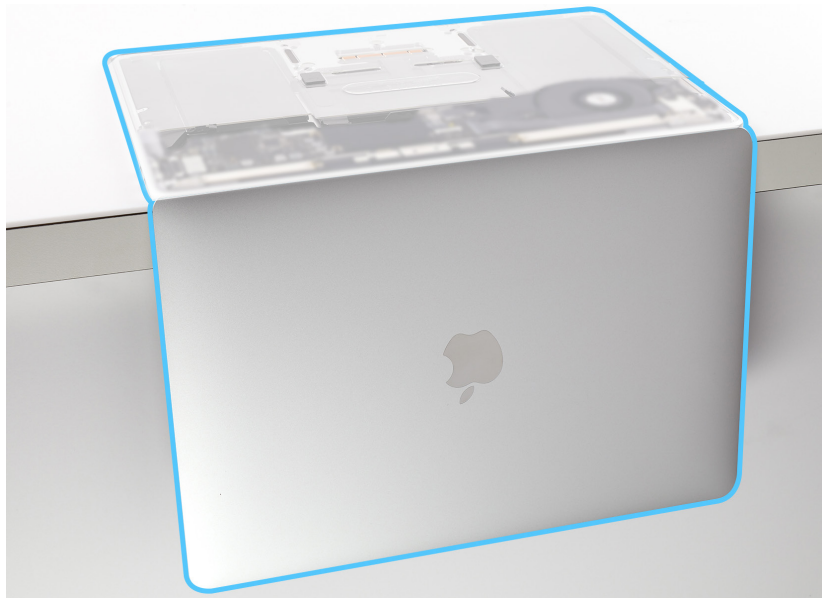

8. Use ESD-safe tweezers to position the Touch ID board flexible cowling as shown.

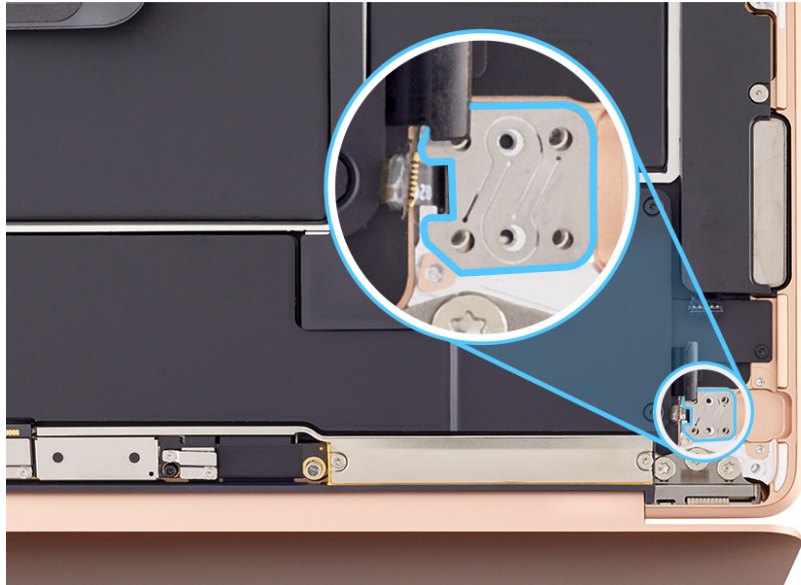

9. Use the T3 screwdriver to partially reinstall the four corner T3 screws (923-02888) into the Touch ID board flexible cowling.

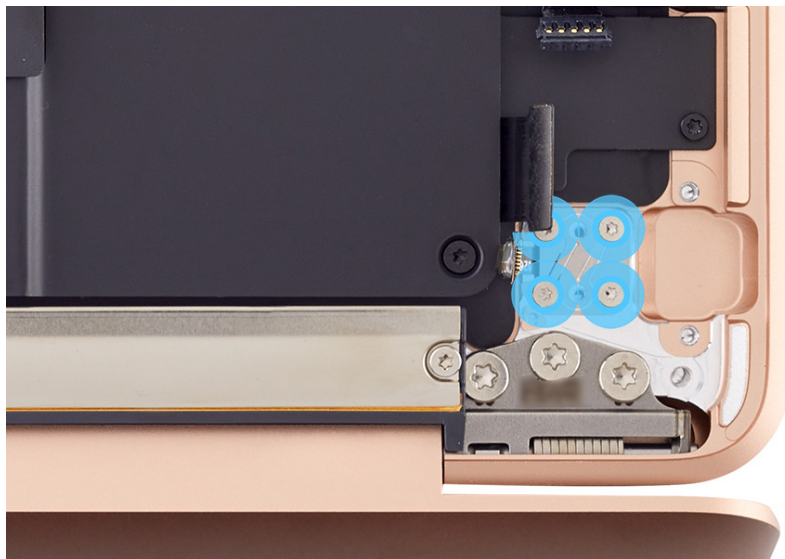



10. Use the T3 screwdriver to partially reinstall the two middle T3 screws (923-02888) into the flexible cowling.

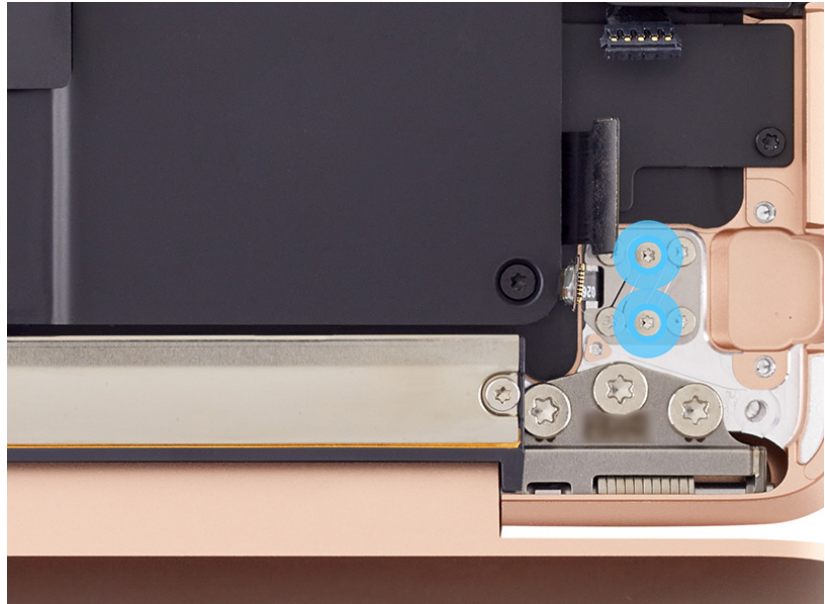

11. Use the T3 screwdriver to fully reinstall the four corner T3 screws. Then use the same screwdriver to fully reinstall the two middle T3 screws.

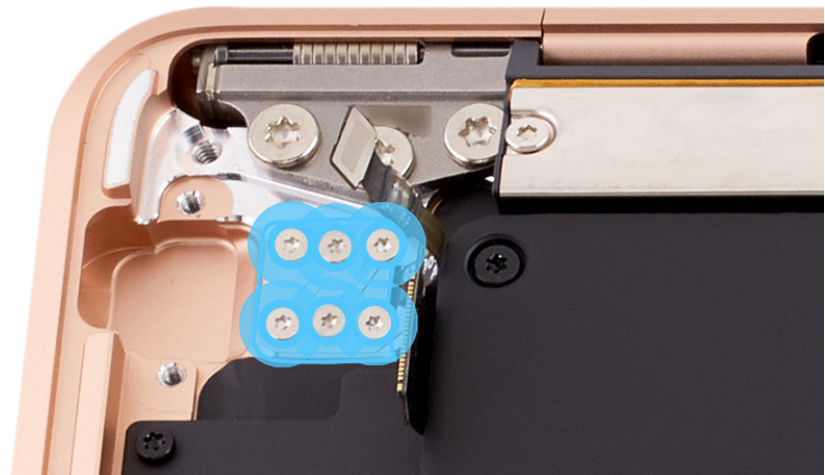

12. Place the computer right side up with the display open.

 **Caution**

Don't bend the Touch ID board flex cable.

13. Remove the two Y-shaped alignment tools. Look directly over the Touch ID button. The spaces on each side should appear equal, and the Touch ID button should align with the function keys. If the gaps around the sides are unequal, repeat reassembly steps 5 through 12.



14. Press the Touch ID button to ensure that it clicks. If the button doesn't click, determine the required shim size. Then repeat the Touch ID board removal procedure to install the shim.

### Important

- If the Touch ID button feels too loose or doesn't click, install a larger shim.
- If the Touch ID button feels too stiff or doesn't move, install a smaller shim.

### Reinstall the following parts to complete reassembly:

- [Audio board](#)
- [Bottom case](#)

### Important

After you've completed all removal and reassembly steps, learn how to initiate the System Configuration process at [support.apple.com/self-service-repair](https://support.apple.com/self-service-repair).

# Top Case with Keyboard

## Before You Begin

Remove the following parts before you begin:

- [Bottom case](#)
- [Input/output board](#)
- [Logic board](#)
- [Speakers](#)
- [Trackpad and input device flex cable](#)
- [Audio board](#)
- [Audio board flex cable](#)
- [Embedded DisplayPort flex cable with connector cowling](#)
- [Antenna module](#)
- [Display](#)
- [Battery](#)
- [Touch ID board](#)

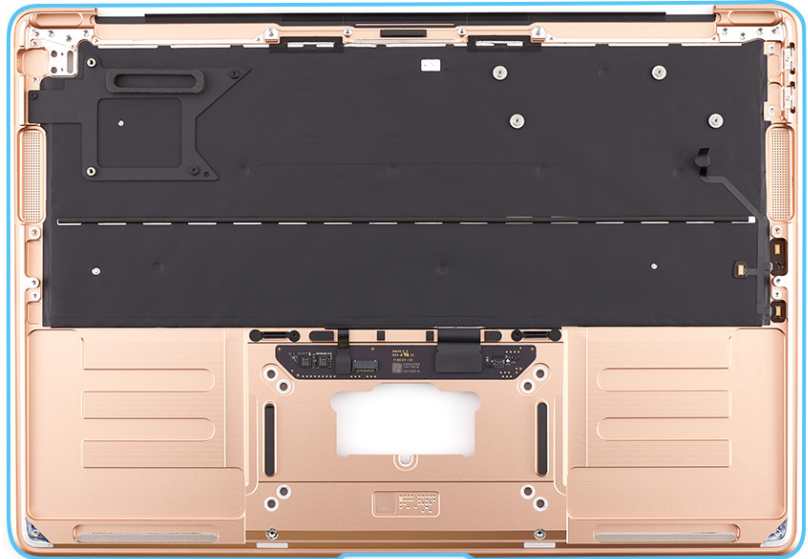

## Tools

No tools are required for this procedure.

### Important

If you install a replacement top case, you must replace the trackpad shims. The replacement shim kit is available only with a replacement trackpad.

## Removal

There are no additional removal steps.

The top case includes the following nonremovable parts:

- Keyboard
- Microphone

## Reassembly

**Reinstall the following parts to complete reassembly:**

- [Touch ID board](#)
- [Battery](#)
- [Display](#)
- [Antenna module](#)
- [Embedded DisplayPort flex cable with connector cowling](#)
- [Audio board flex cable](#)
- [Audio board](#)
- [Trackpad and input device flex cable](#)
- [Speakers](#)
- [Logic board](#)
- [Input/output board](#)
- [Bottom case](#)

Torx® is a registered trademark of Acument Intellectual Properties, LLC.