











Architecture

Flatiron Building

New York City, NY, USA



-  Booklet available in English on
-  Heft in deutscher Sprache erhältlich auf
-  Livret disponible en français sur
-  Folleto disponible en español en
-  Folheto disponível em português em
-  A fűzet magyarul ezen a honlapon olvasható
-  Libretto disponibile in italiano su
-  如需中文版手册，请访问



[LEGO.com/architecture](https://www.lego.com/architecture)

Flatiron Building

Sitting on the intersection where Fifth Avenue and Broadway cross, the Flatiron Building (originally named the Fuller Building) remains one of New York City's most popular and memorable structures. Today it is difficult to imagine the controversy this architectural landmark created on its completion in 1902.

[I found myself agape, admiring a sky-scraper...
ploughing up through the traffic of Broadway
and Fifth Avenue in the afternoon light.]

H. G. Wells, 1906



© Per Tropp-Christiansen

The Architect

Born in New York and raised in Chicago, Daniel H. Burnham would become one of the founding fathers of the first Chicago School of architects. Together with his then-partner John W. Root, Burnham built one of the first American skyscrapers, the 21-story Masonic Temple Building in Chicago in 1892, and planned the architectural layout of the largest World Fair ever held at that time in 1893.

Burnham's architecture mixed elements of Modernism with a more neoclassical style. Many of his buildings, including the Flatiron Building, followed the convention of the classical column: three distinct parts made up of a base, a middle section, and an ornate cornice at the top.

Burnham's early sketches for the Flatiron Building included a clock face and a far more elaborate crown at the top of the building, but he was persuaded to remove both by his former partner John W. Root. Although Burnham retained overall control of the project, he engaged the architect F. P. Dinkelberg (1859–1935) to carry out most of the supervising work during the actual construction.

After the Flatiron Building, Burnham would continue to work on a series of impressive architectural projects, including a number of major planning tasks for the cities of San Francisco, Washington, D.C., and Manila in the Philippines. At the time of his death in 1912, his D. H. Burnham & Co. architectural firm was the largest in the world.



Daniel Hudson Burnham (1846 – 1912)

© Wikipedia

History

As the city of New York expanded northward during the second half of the 19th century, small plots of land in between or on the edge of new buildings remained undeveloped. One of the most well known of these was the narrow triangular site at 23rd Street, between Fifth Avenue and Broadway. The “Flat Iron,” as it quickly became known, changed owners many times, but wouldn’t be developed until the Chicago-based Fuller Company bought the site in 1901.

The Fuller Company, a major Chicago-based contracting firm specializing in the construction of skyscrapers, planned to build a new showcase headquarter on the site. The founder of the company, George A. Fuller, had died the year before, and the new building would be named the Fuller Building in his honor.

The Fuller Company engaged Chicago architect Daniel H. Burnham to design the building and, utilizing the Fuller Company’s expertise with steel frame construction, he proposed a 20-story structure that would reach a height of 285 ft. (86.9 m). A penthouse would be added in 1905, increasing the building’s height to 307 ft. (93 m). The building’s Broadway front would be 190 ft. (60 m) wide, the Fifth Avenue front 173 ft. (52.7 m) wide, and the 22nd Street side just short of 87 ft. (26.5 m) wide. At the “point” of the triangle the building would only be 6.5 ft. (2 m) wide and would form a 25-degree acute angle.

Burnham saw the building as a vertical Renaissance palazzo with Beaux-Arts, or neoclassical, styling. Visually the building would be divided into three distinct sections. It would consist of a richly decorated, three-story limestone façade at the bottom and a broad, repetitive midsection in a light tan monochrome terra-cotta. The structure would then be topped off with a crowning cornice that would run the entire length of the building.



© Getty Images



© Gerty Images

With its steel skeleton structure, the construction of the building was carried out rapidly and without major incident. While other New York skyscrapers at the time were often thin towers rising from pedestal-like blocks, the Flatiron was a single massive structure. This radical design, combined with its great height and unusual shape, created a great deal of debate as the building neared completion in 1902.

Many New Yorkers believed the structure would be unstable and would fall over at the first gust of wind. The building had even been nicknamed “Burnham’s Folly” and bets were placed on how far the debris would reach when it blew over. Strong winds came and went, and the Flatiron Building withstood them—as it continues to do today, over a century later. It is proof that the structure was not only a strong architectural idea, but a groundbreaking engineering marvel as well.



The Building Today

Although never the tallest building in New York, or even the first building in the country with a triangular ground plan, the Flatiron Building remains an iconic symbol of the city of New York. Its enduring popularity with tourists, artists, and photographers also makes it one of the most photographed buildings in the world.

The famous building has appeared in countless movies, TV series, and comics. It was home to Peter Parker's *Daily Bugle* in the *Spiderman* movies, and was even accidentally destroyed by the U.S. Army in the 1998 film *Godzilla*.

The building was designated a New York City Landmark in 1966, added to the National Register of Historic Places in 1979, and became a National Historic Landmark in 1989. Valued today at \$190 million, the Flatiron Building continues to function as a popular retail and office space, and is home to a large number of U.S. and international companies. In 2009, Sorgente Group of America acquired the majority stake of the Flatiron Building. Sorgente Group of America is the American Holding of Sorgente Group, an Italian real estate investment company.

[... appeared to be moving toward me like the bow of a monster ocean steamer—a picture of a new America still in the making.]

Photographer Alfred Stieglitz

Facts about Flatiron Building

Location: New York City, USA
Architect: D. H. Burnham & Co: Daniel H. Burnham
Style: Renaissance Revival with Beaux-Arts styling
Materials: Steel frame structure, façade of limestone and terra-cotta
Height: 1902: 285 ft. (86.9 m). Today: 307 ft. (93 m).
Weight: 3,680 tons (3,338.5 metric tons)
Opened: 1902



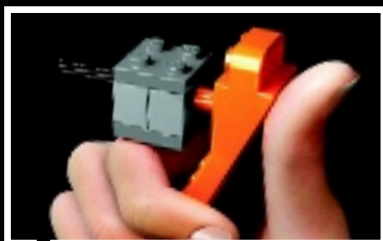

LEGO.com/brickseparator



1

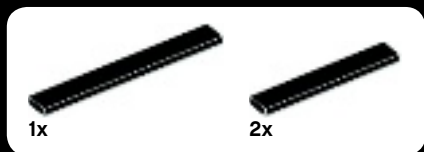
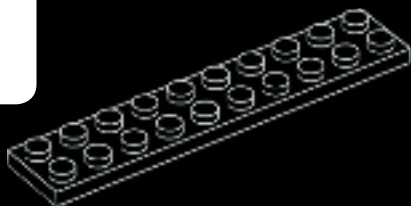

2

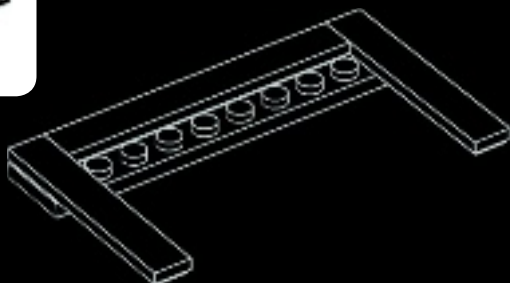

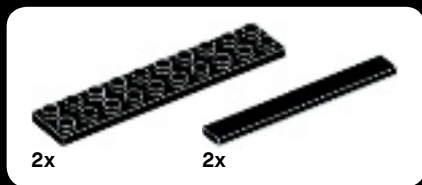

3

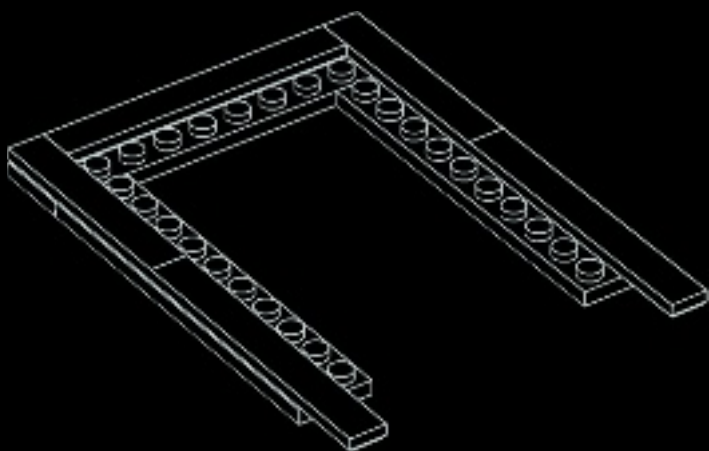

4

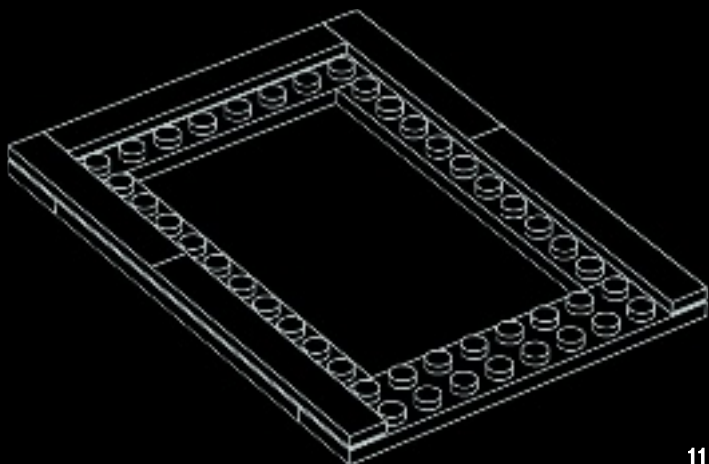

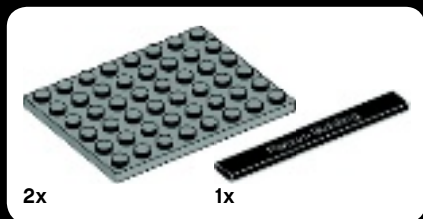

5

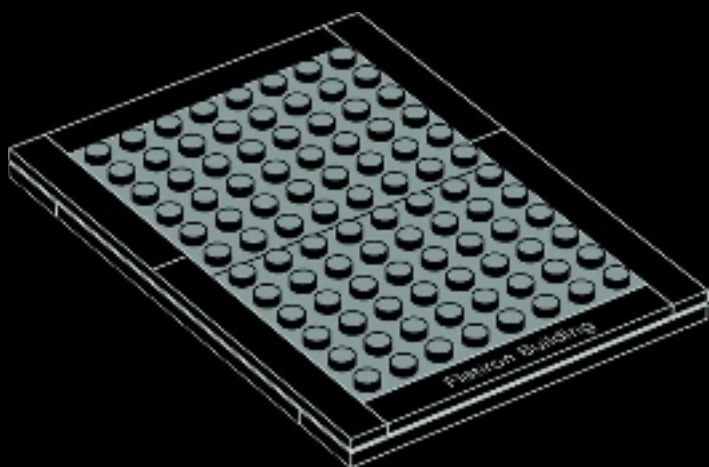

6

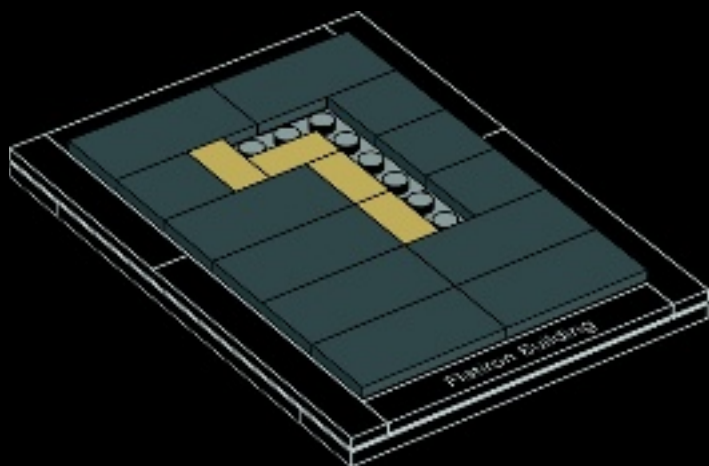



7

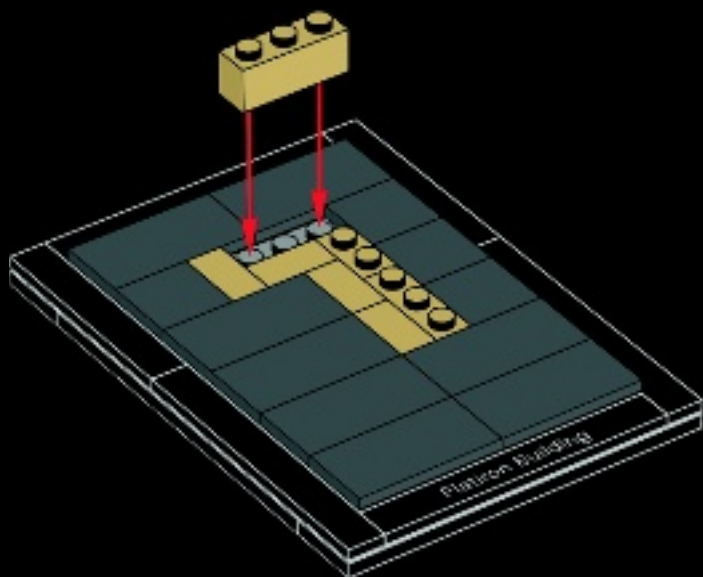

8

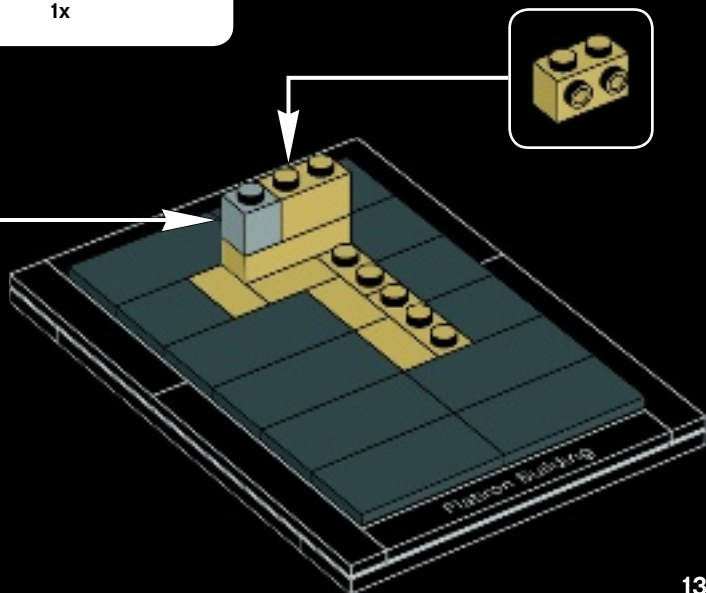



1x



1x

9

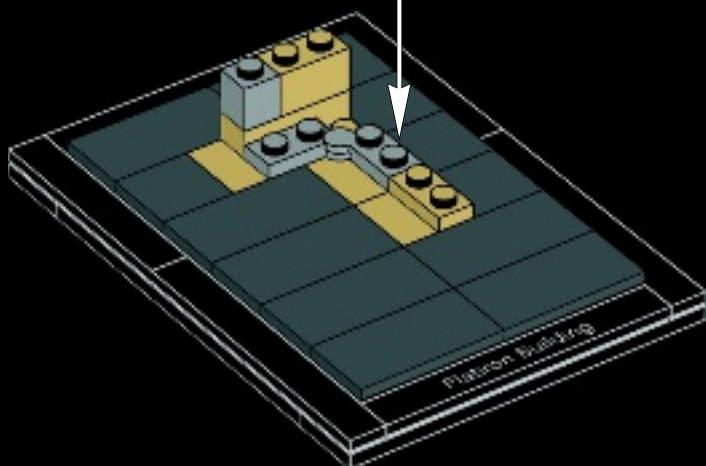

1x



1x



1x



1x



1x

10

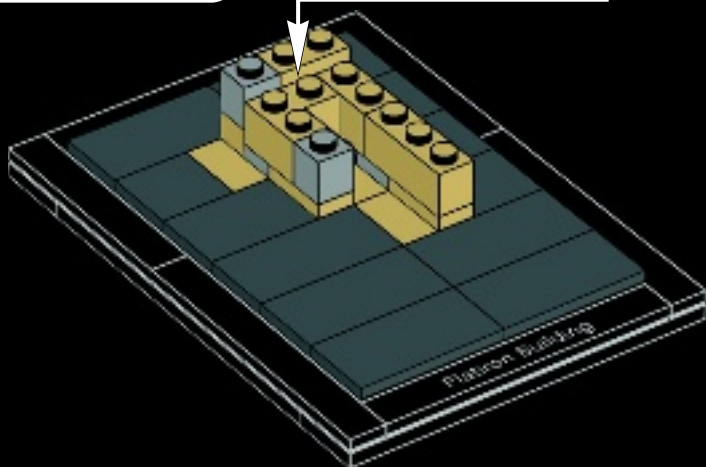
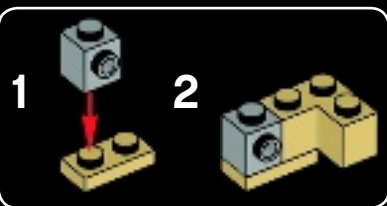



2x



1x



2x

11

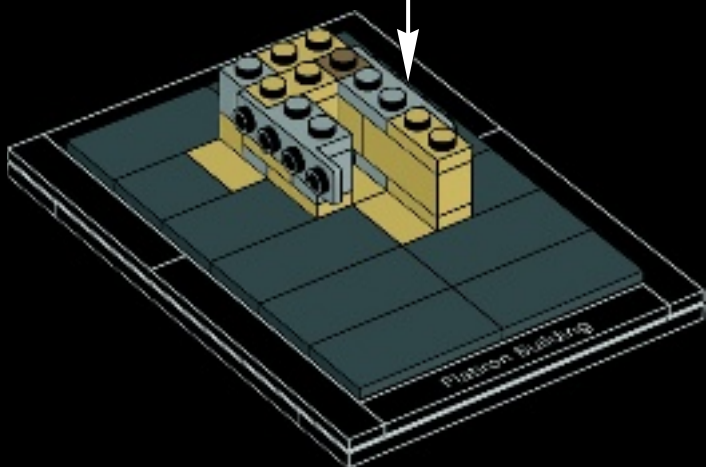

1x



1x

12

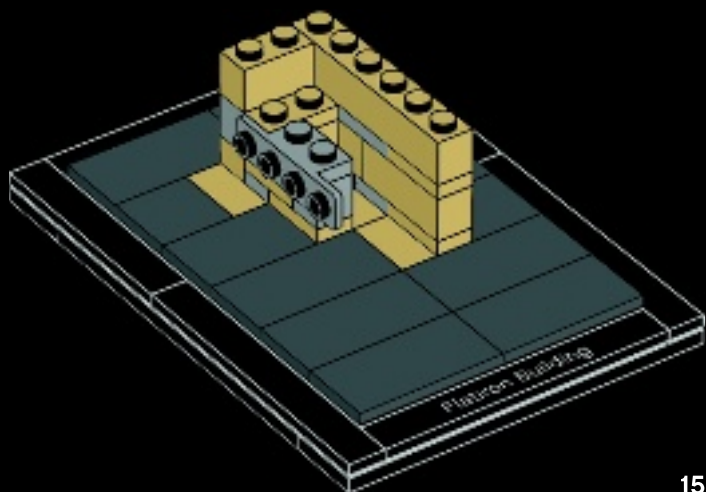



1x



1x

13

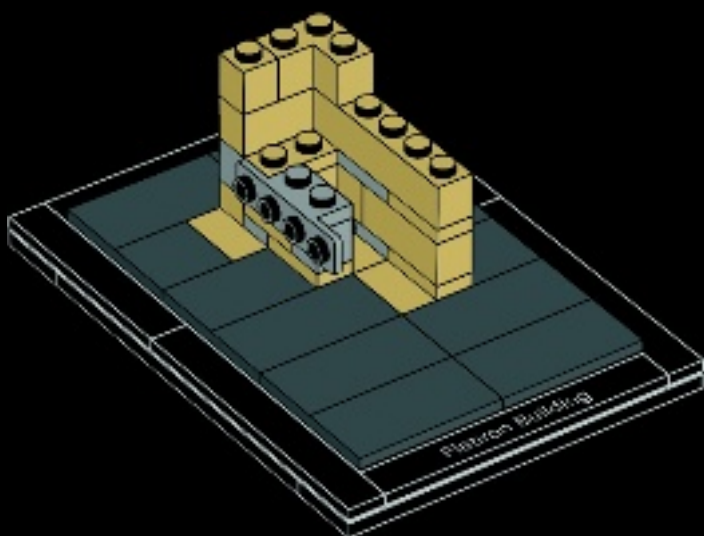

2x



1x



1x

14

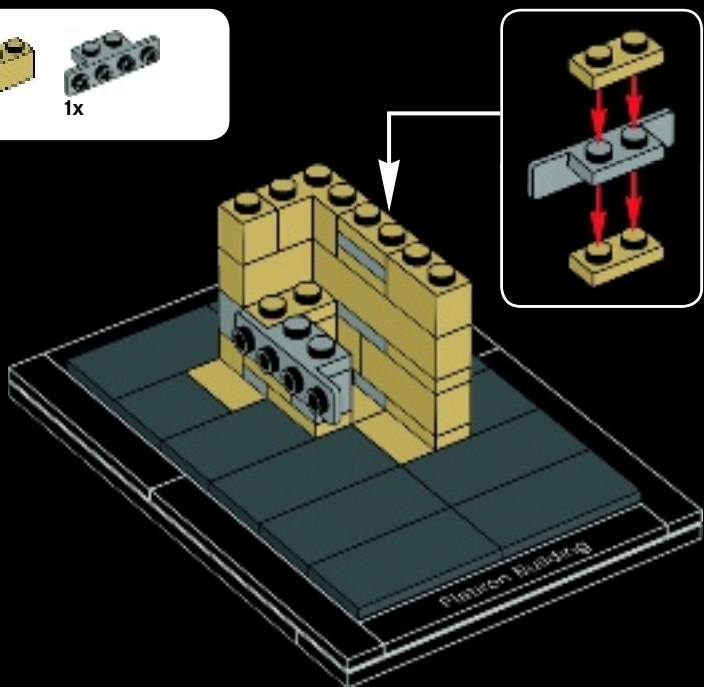



1x

15

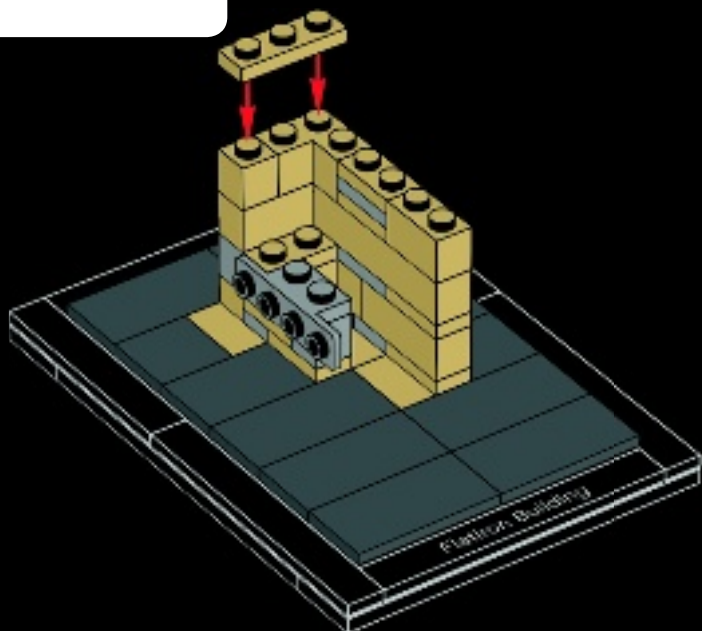

1x



1x

16

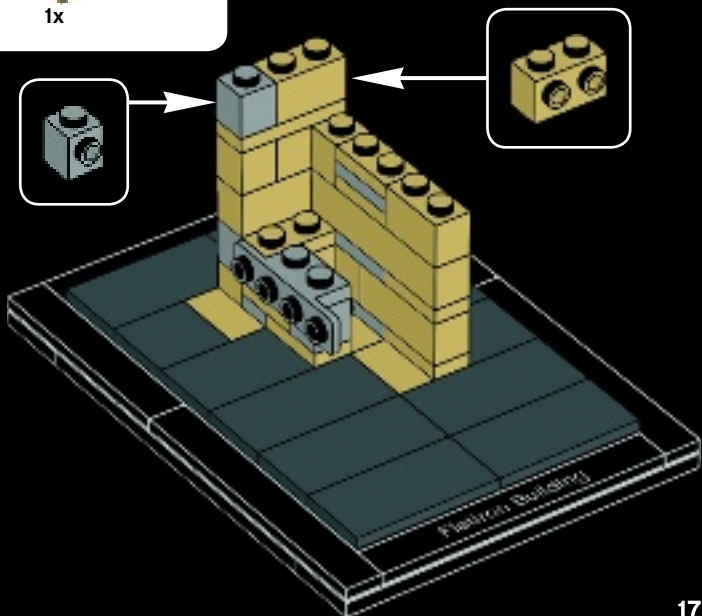



1x



1x

17

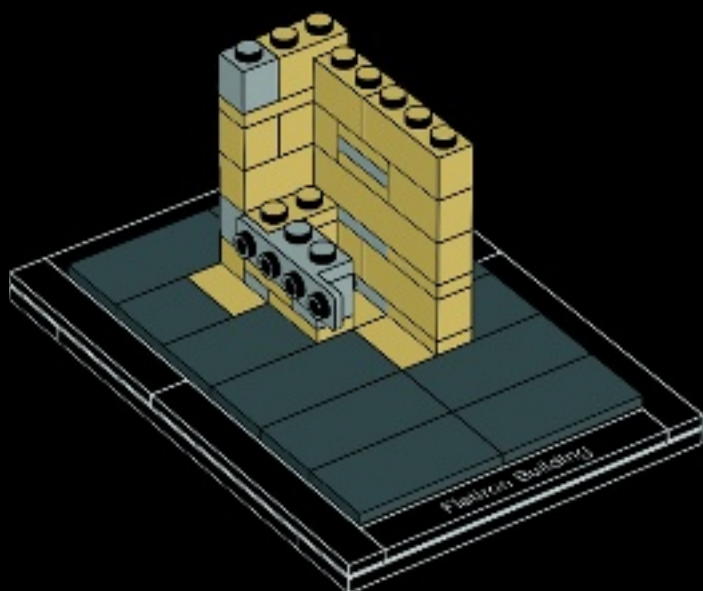

1x



1x



1x

18

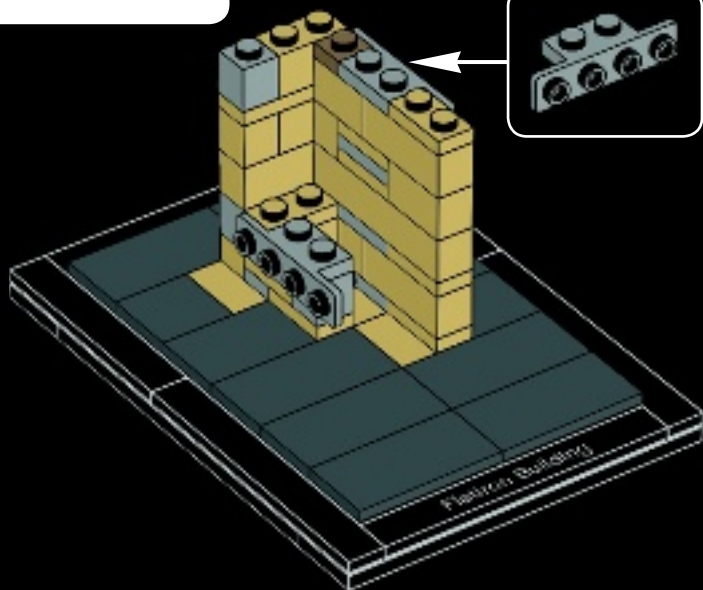



1x



1x

19

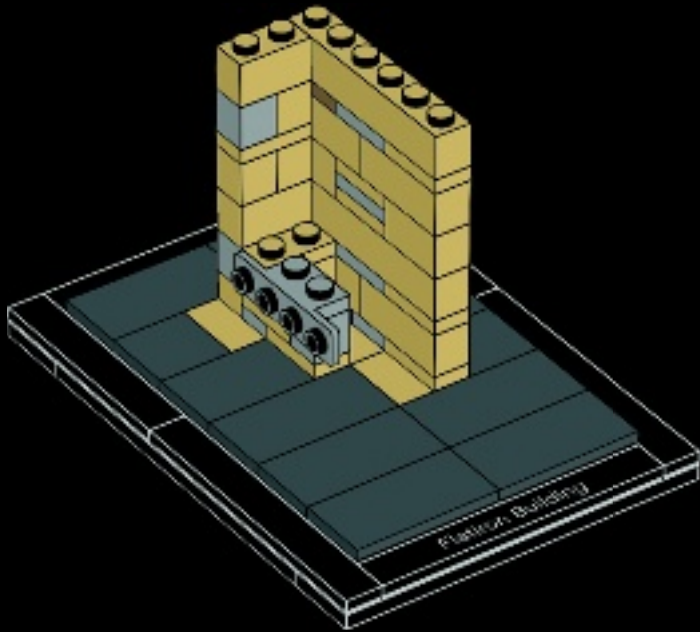

Due to the site's resemblance to a clothes iron it was called the "Flat Iron" long before the building itself was constructed.



© Shutterstock



1x



2x

20

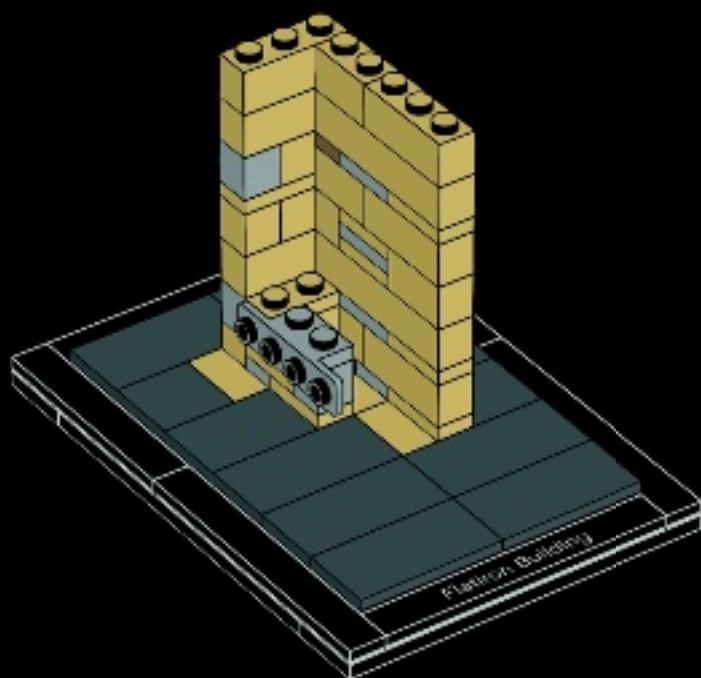



1x



1x

21

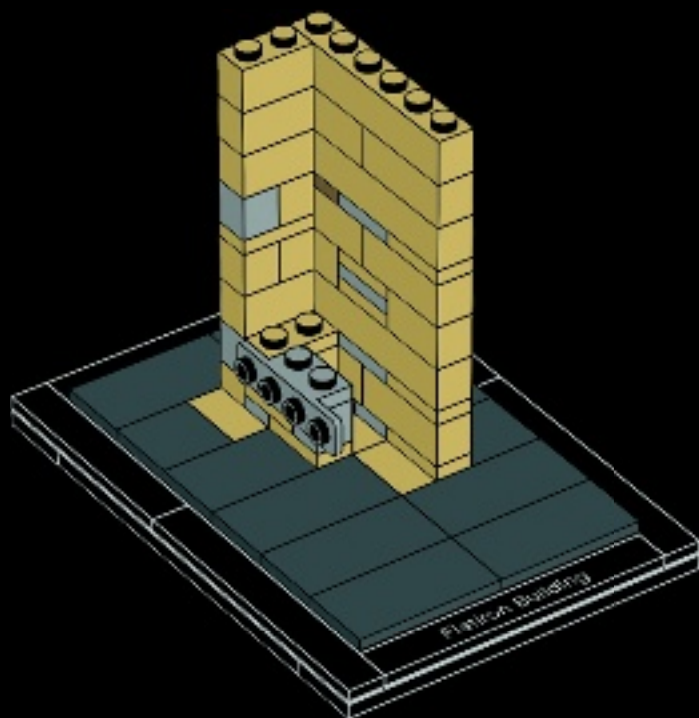



1x



1x

22

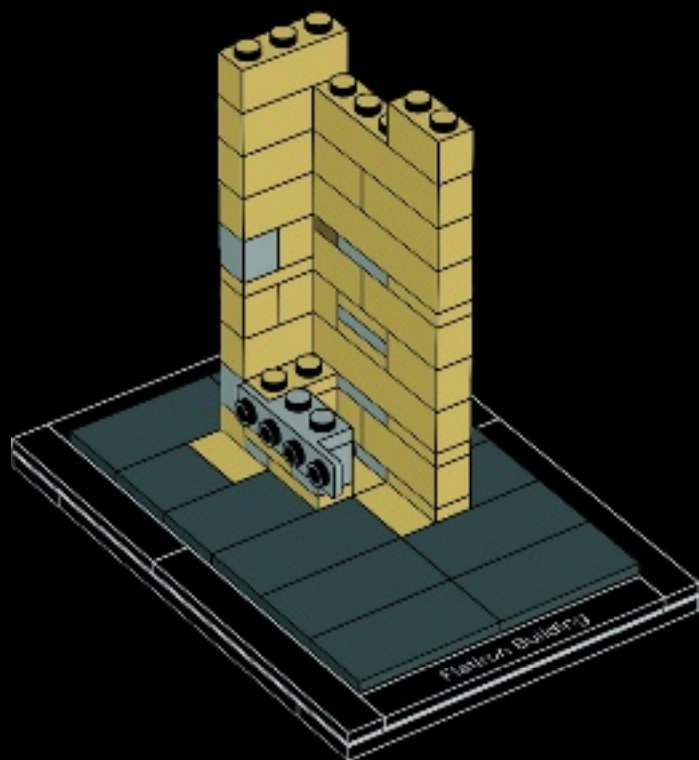

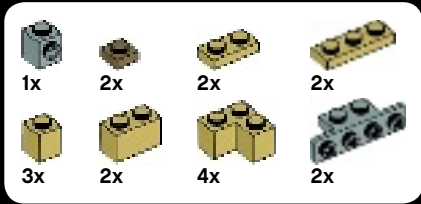

23

1



2



3

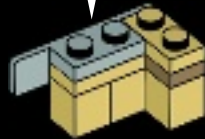

4

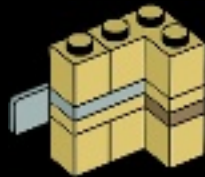

5





6

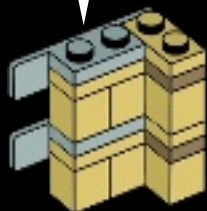

7

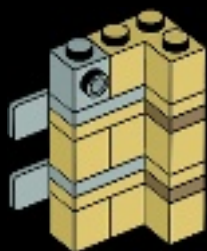

8

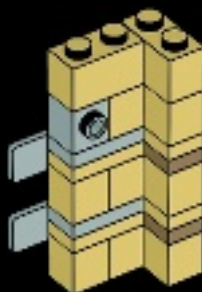

9

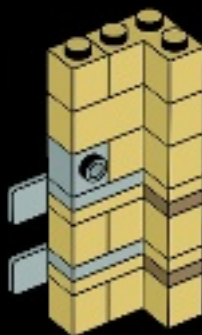

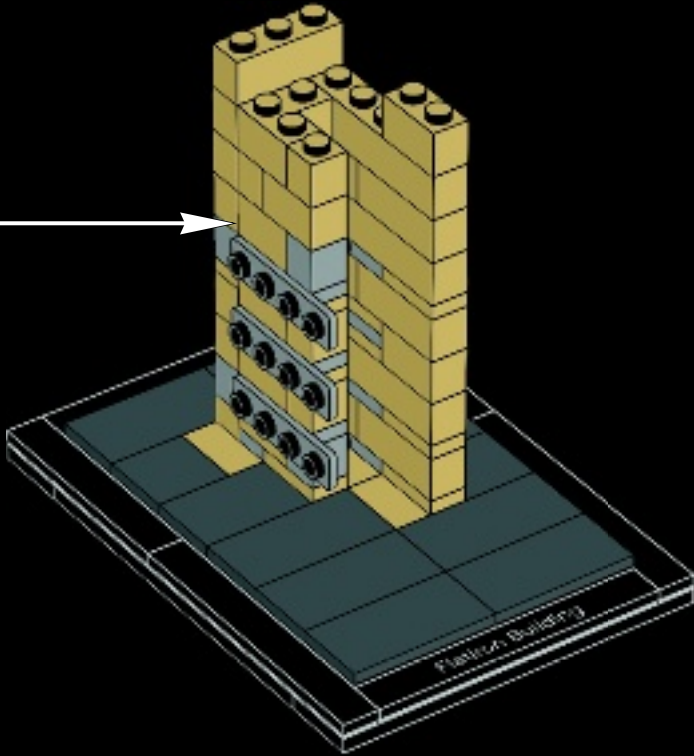

The steel for the building's skeleton frame came from the American Bridge Company mills in Pennsylvania, U.S.



©Veronica Mainetti



1x



1x



1x

24

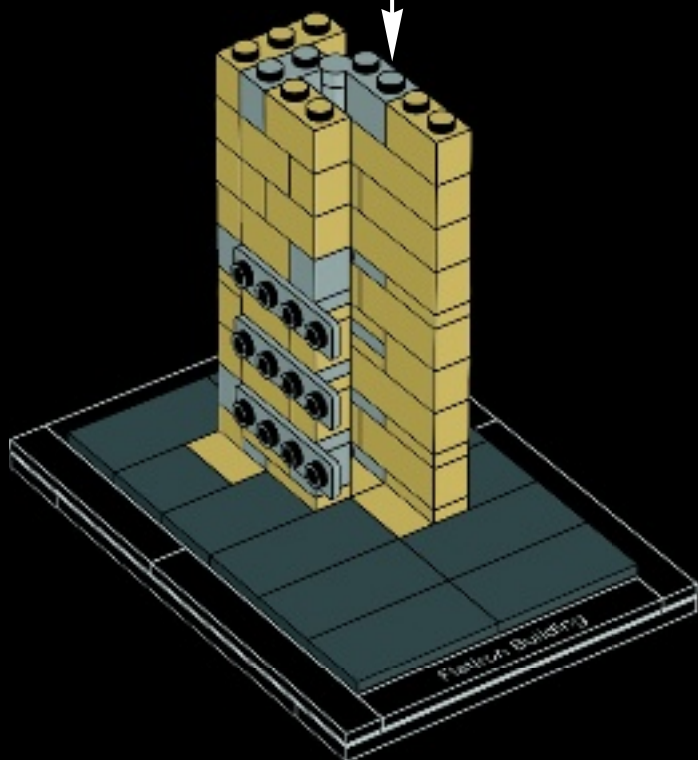
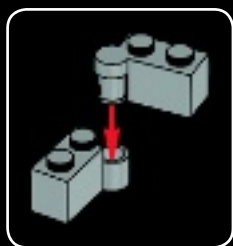



1x



1x



2x



1x



1x

25

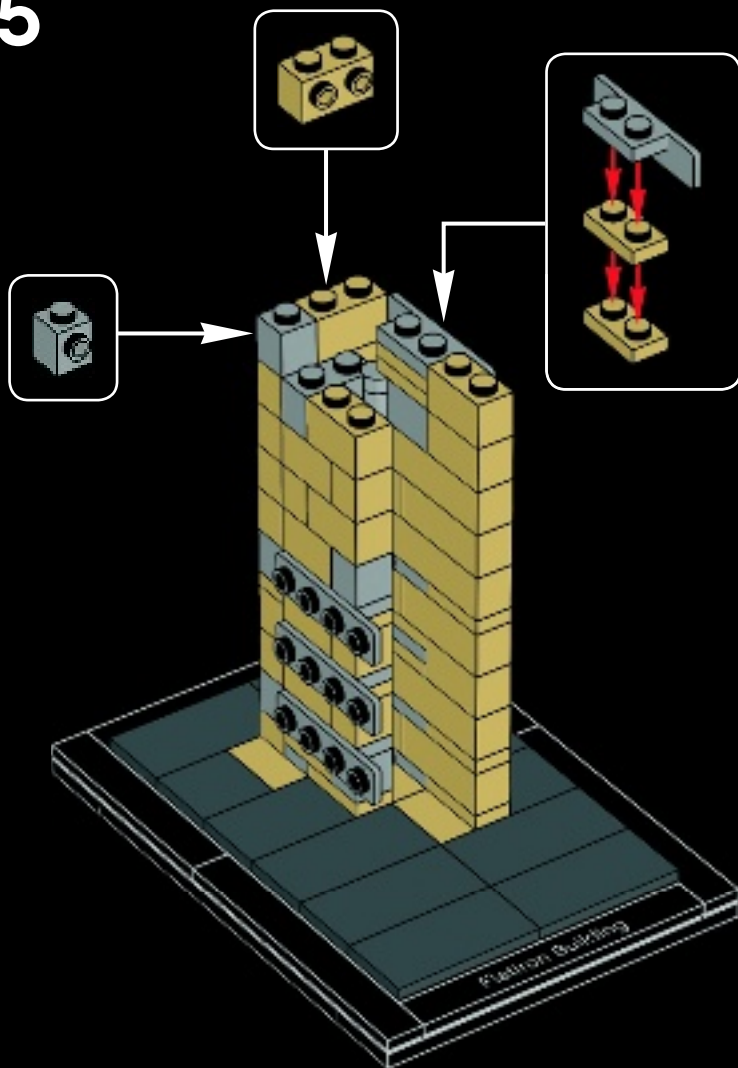



1x



1x

26

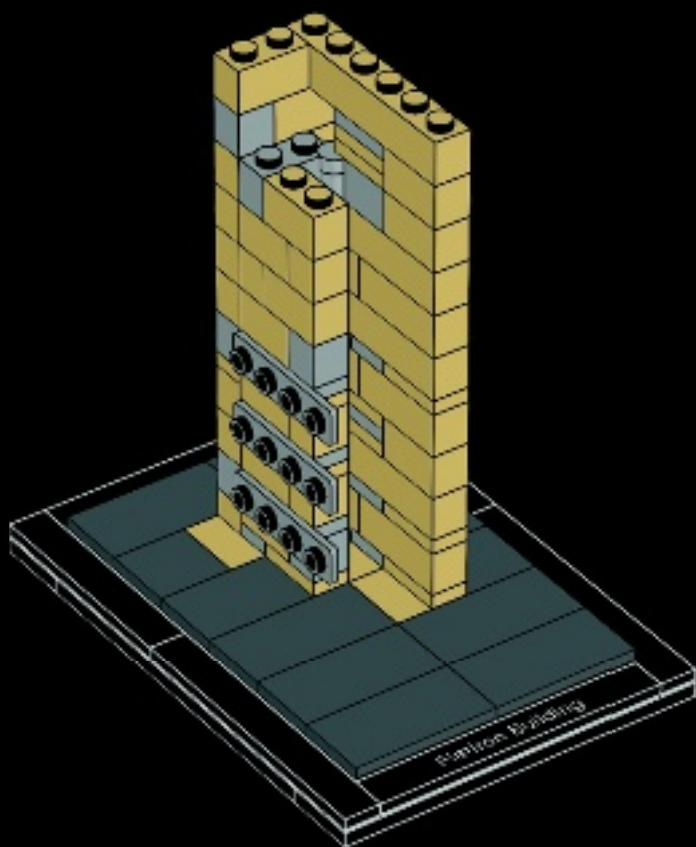



1x



1x



1x

27

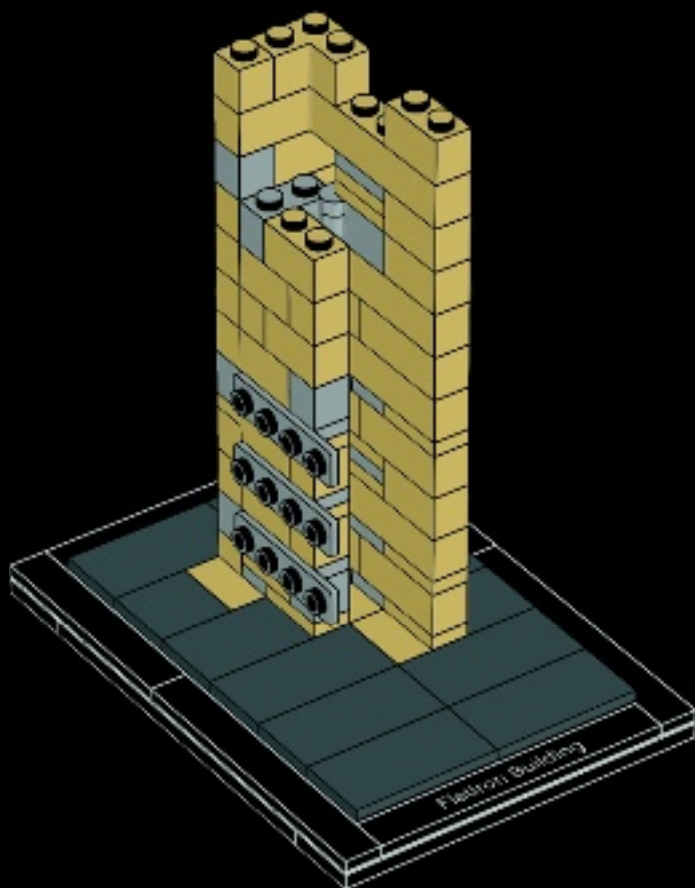

During the peak construction of the steel frame, builders were adding a new story every day.



©Veronica Mainetti



2x

1x

28

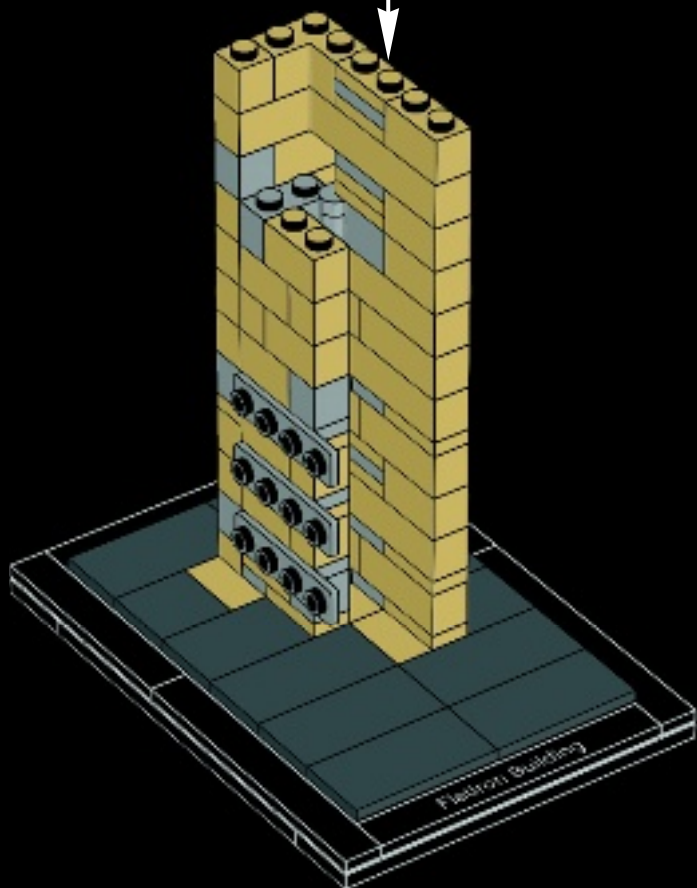
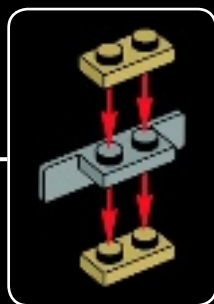



1x



1x



1x

29

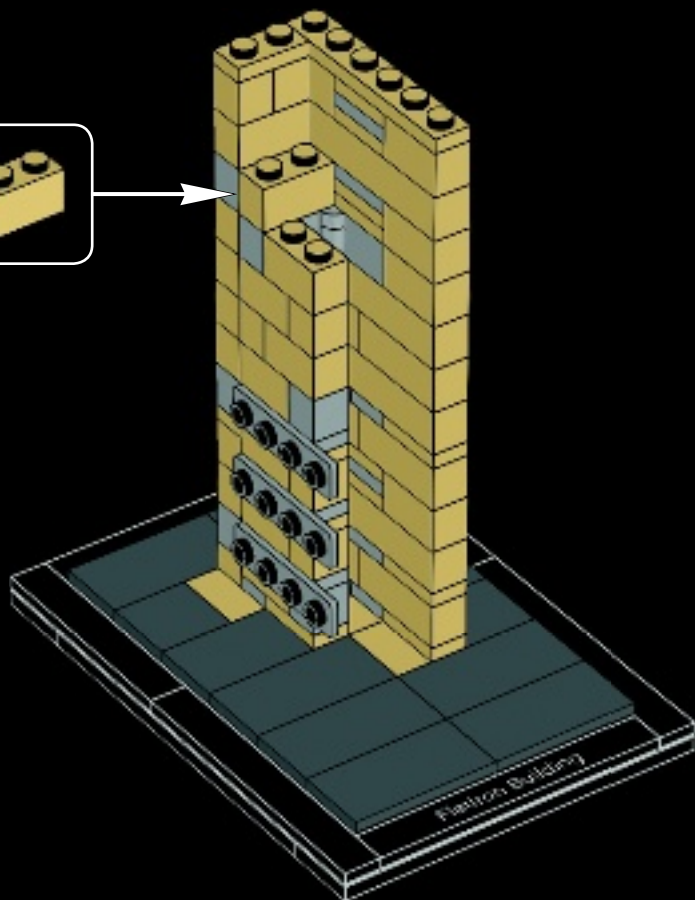



2x



1x

30

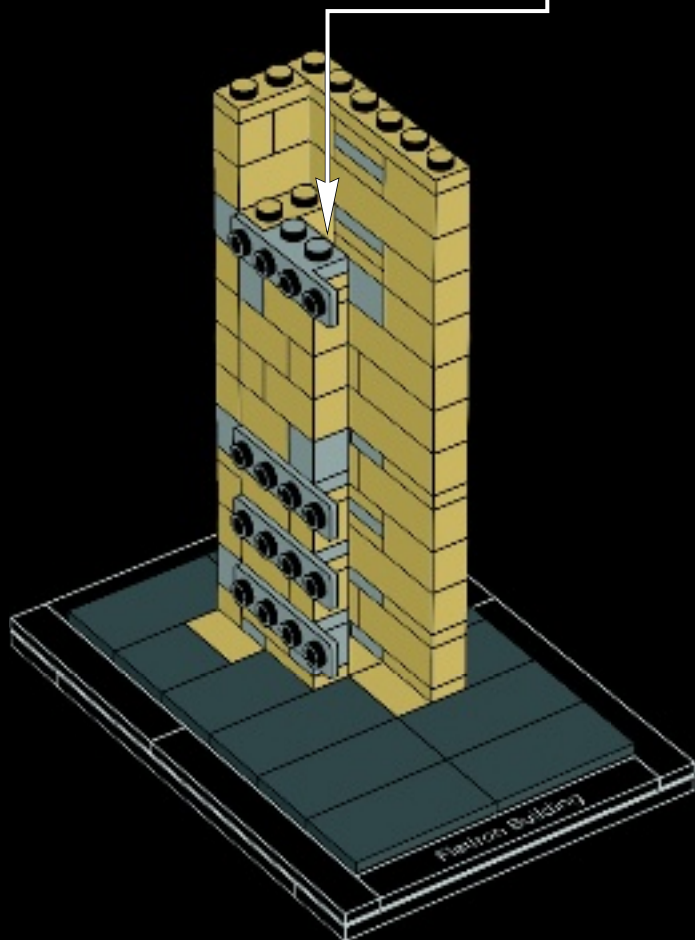
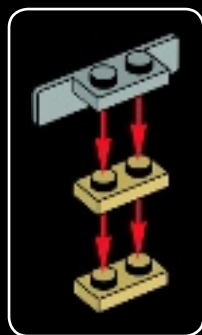

1x



1x



1x



2x



1x



1x



31

1



2



3

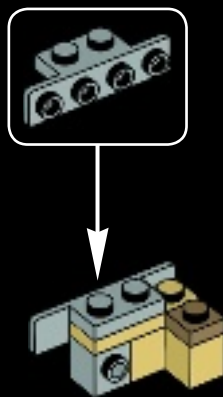

4

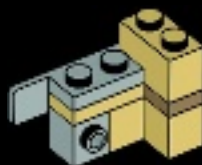

5

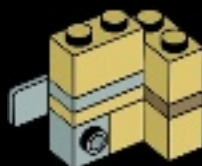

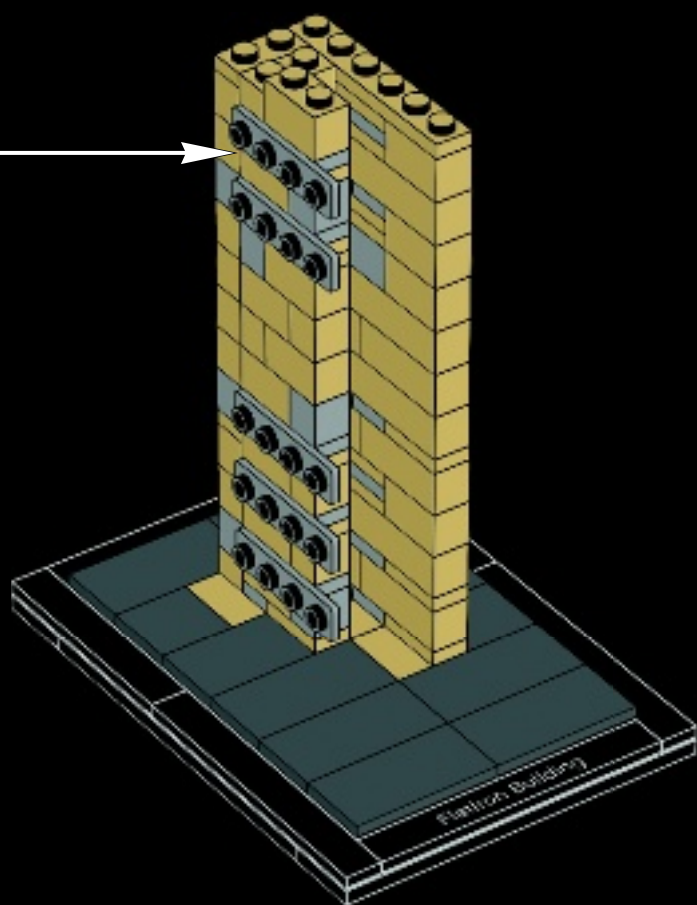



1x



1x



1x

32

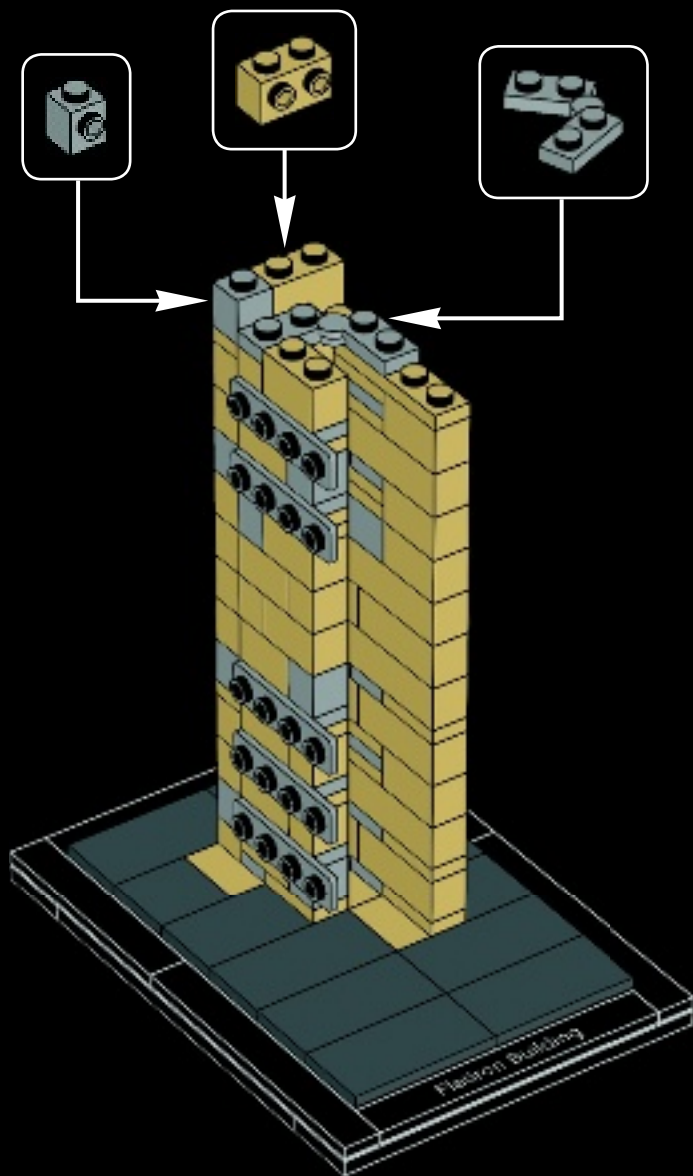



1x



1x

33

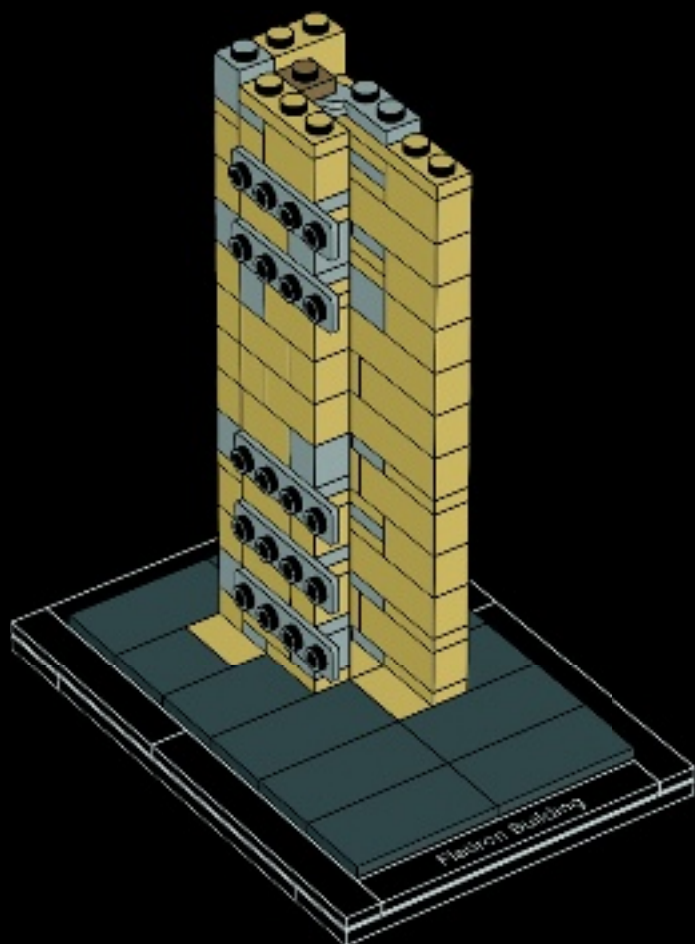



1x



1x



1x

34

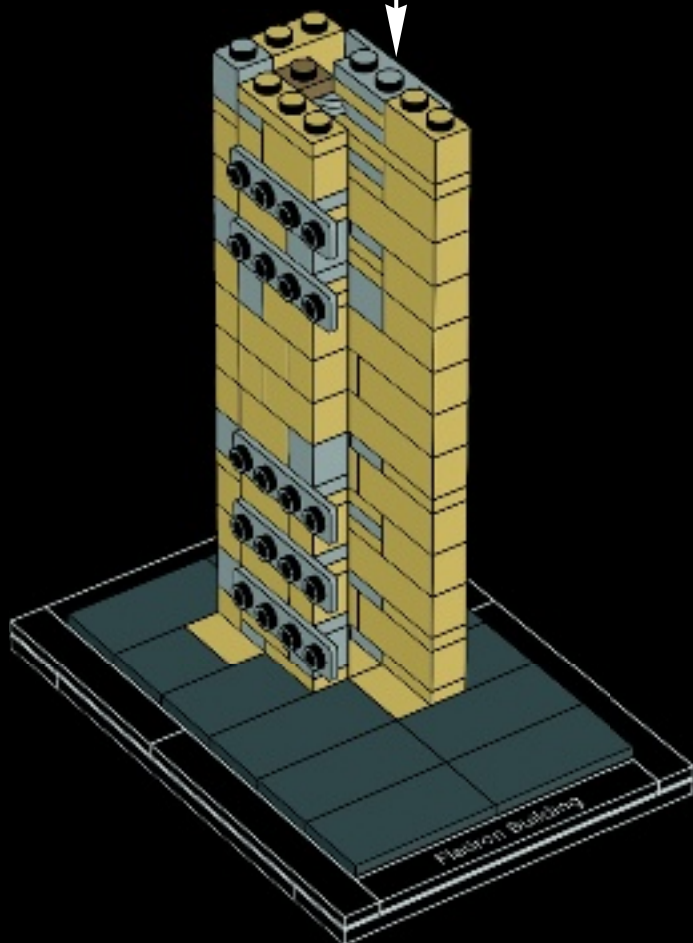
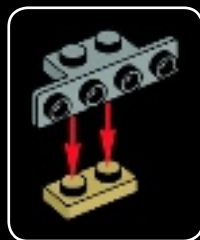



1x



1x

35

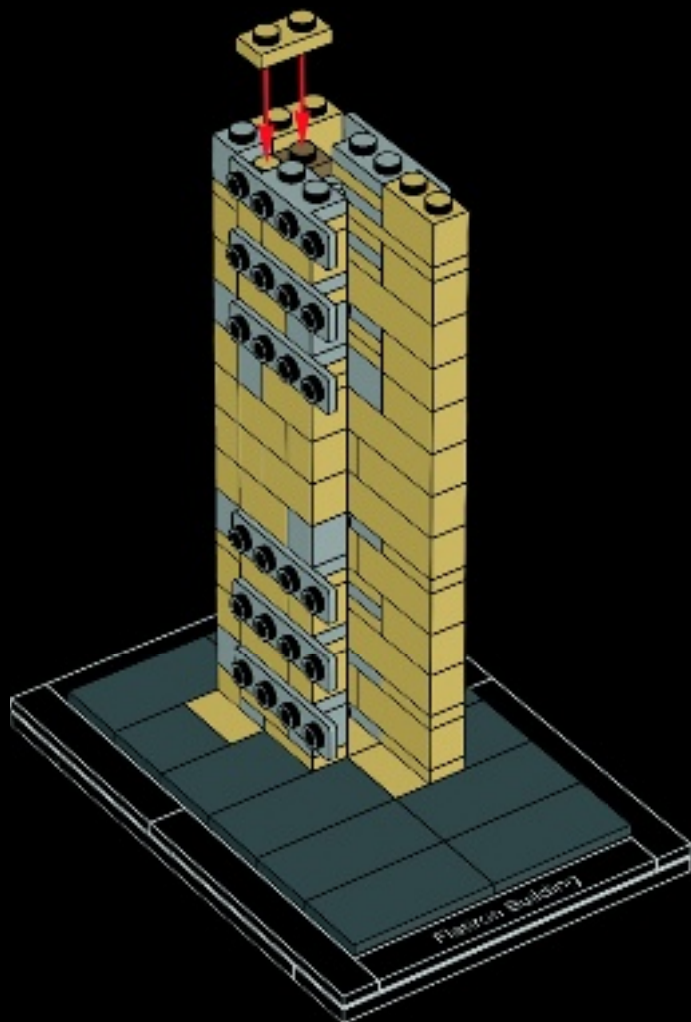



1x



1x

36

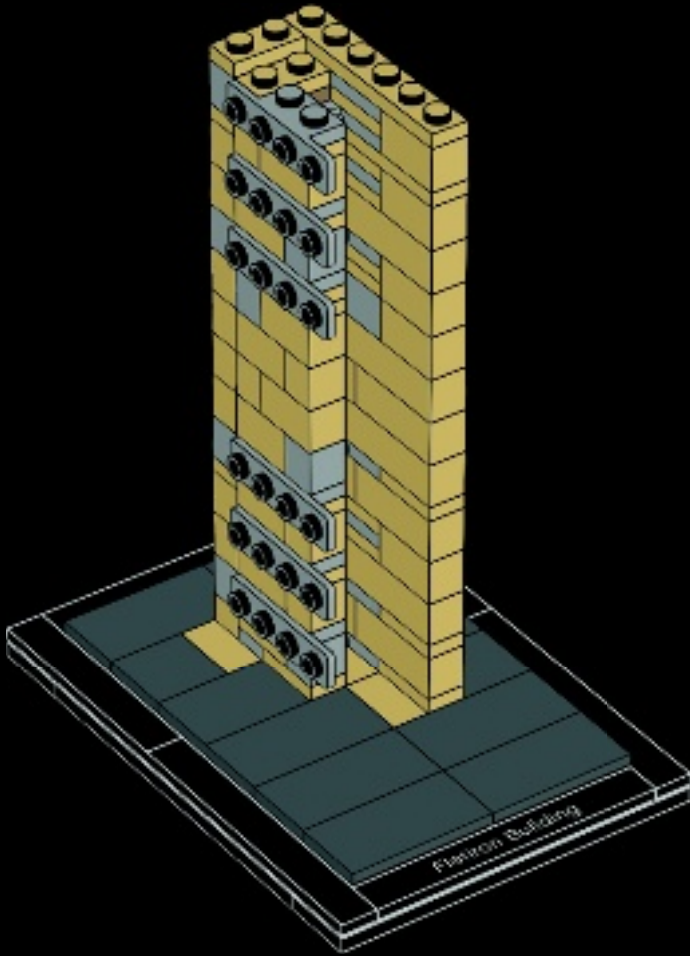

Six Otis Company hydraulic elevators were installed in the building, powered by water pressure and pistons that activated a system of ropes and pulleys.



©Wikipedia



1x



1x

37

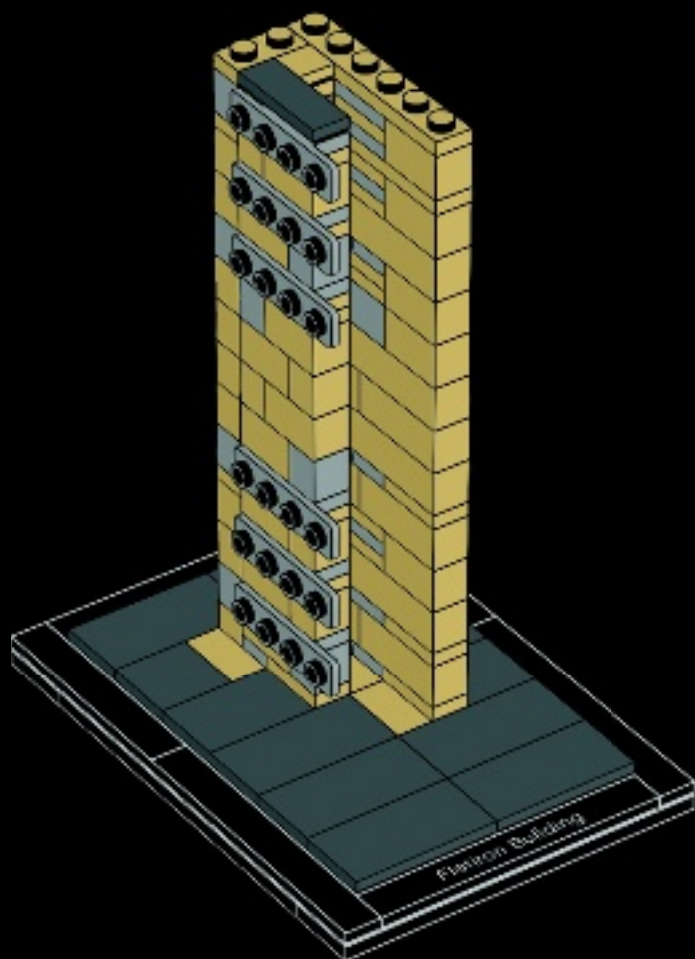



2x

38

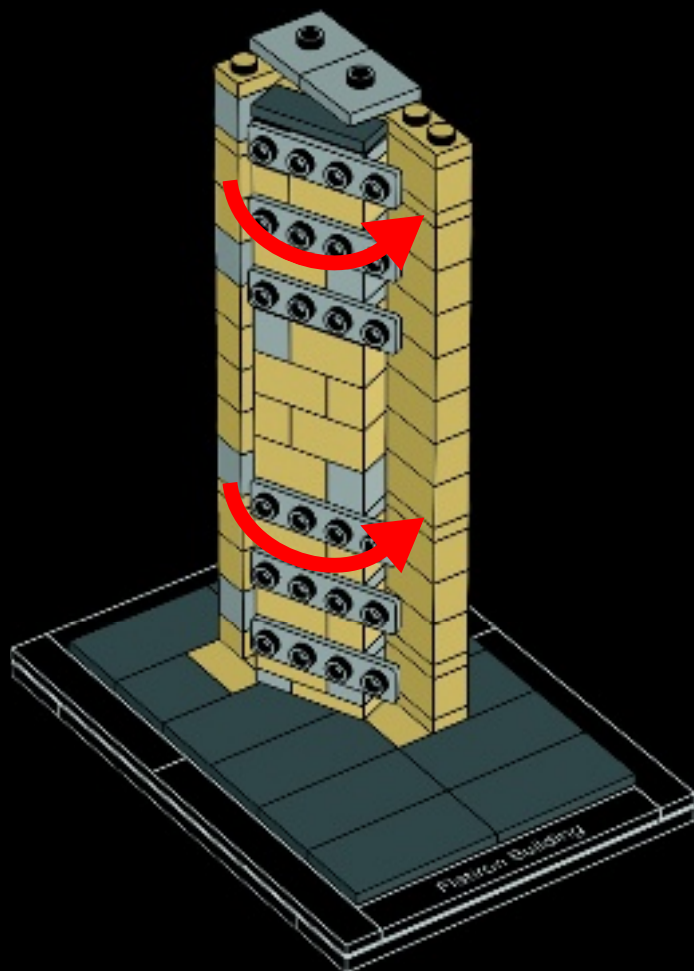

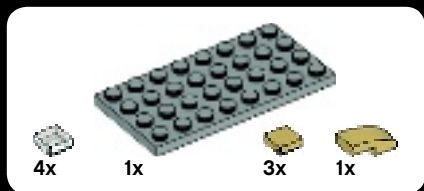

1

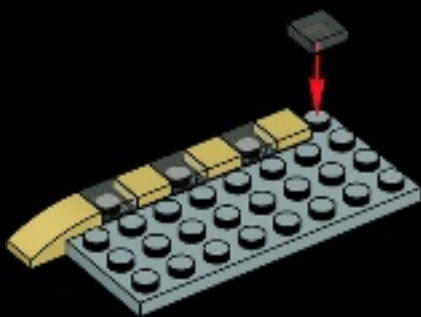

2

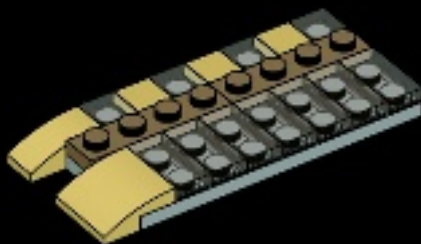

3

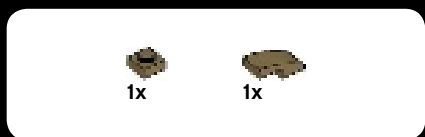

4

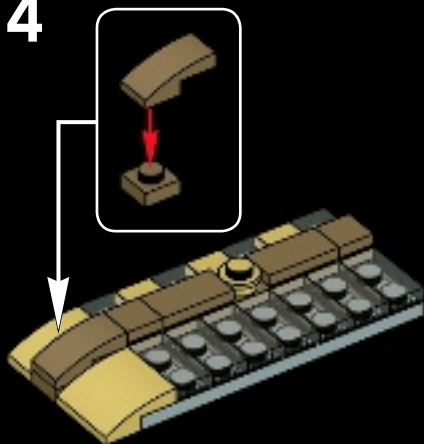

39

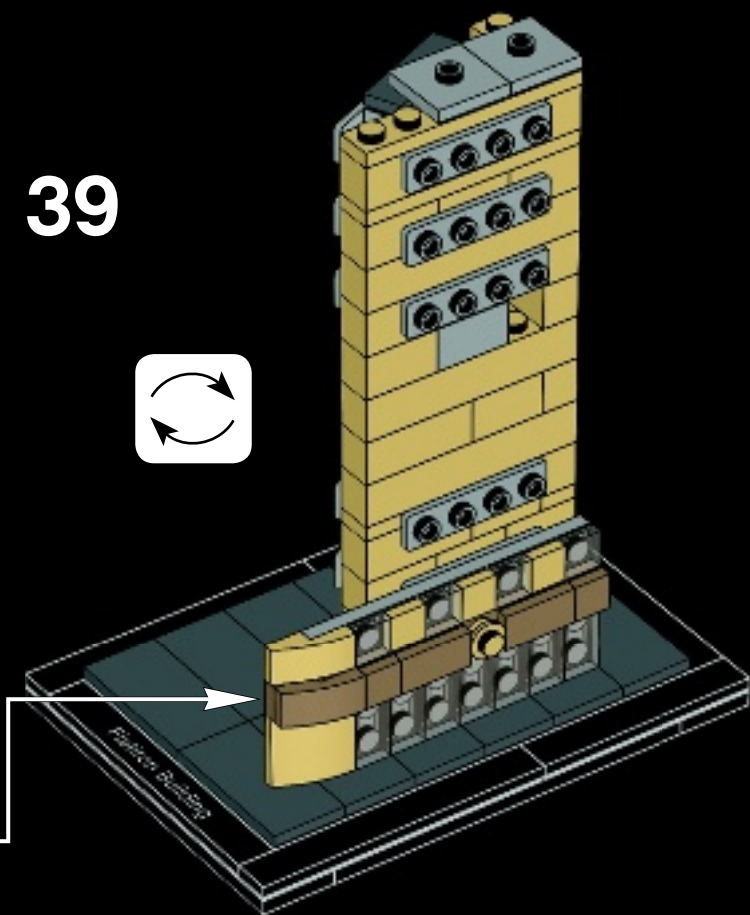

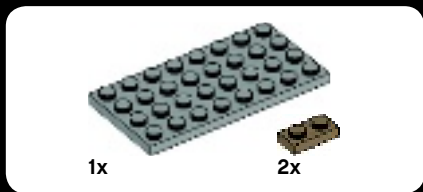

1

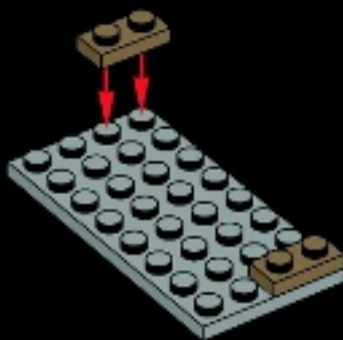

2

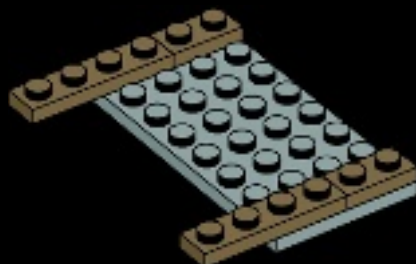



1x

3



6x



2x

4



The windows are deliberately small in size to ensure the building appears even more substantial.



©Veronica Meinert



3x



12x

5

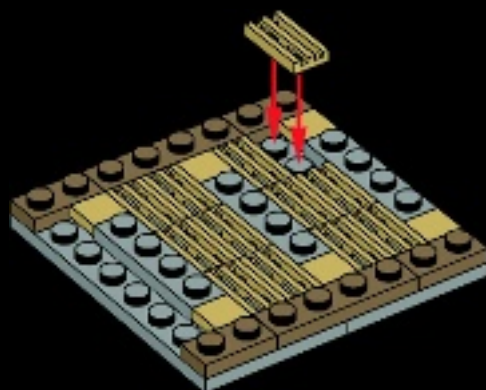

6x



3x

6

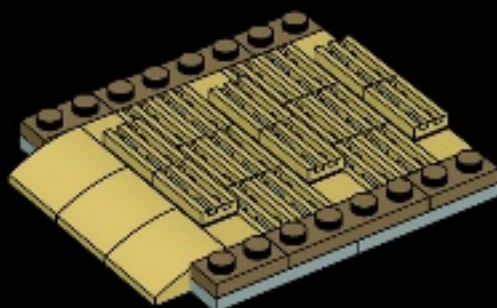



6x



4x

7

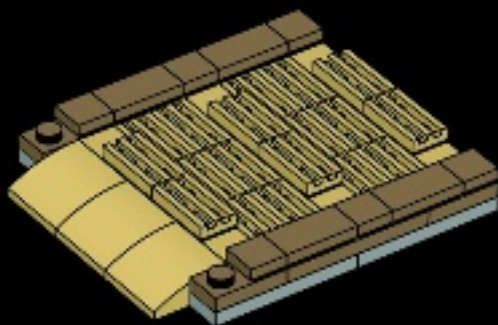

2x



2x

8

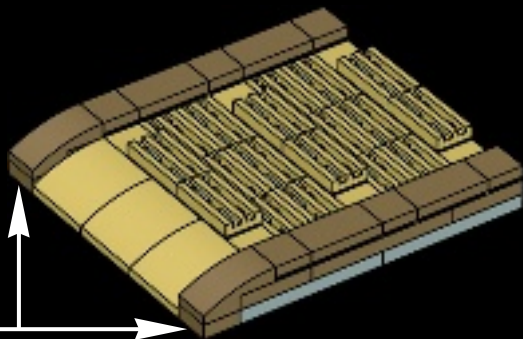

40

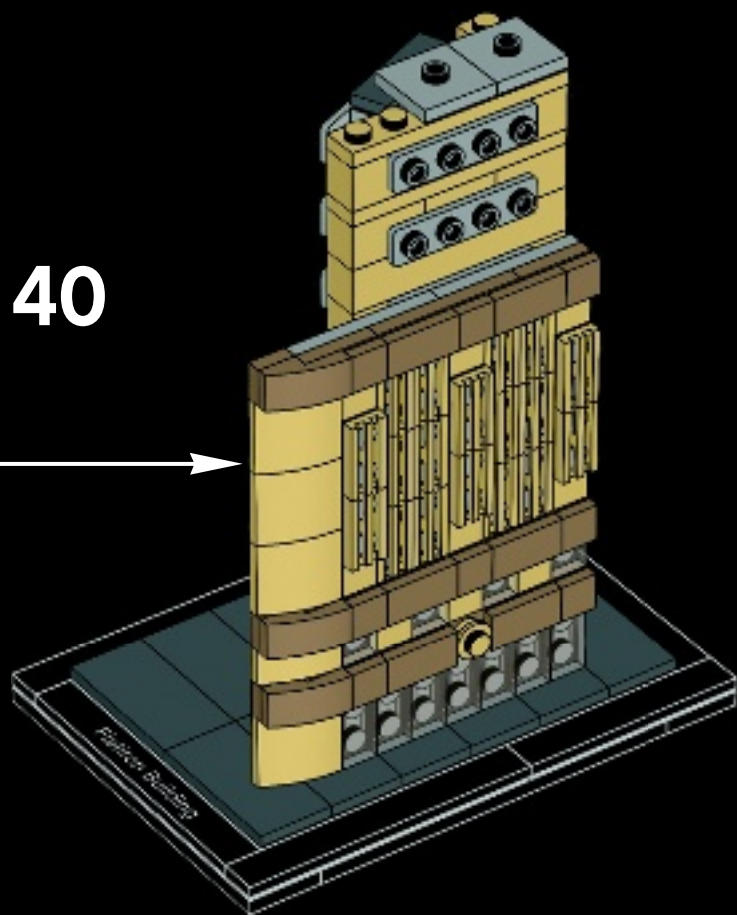

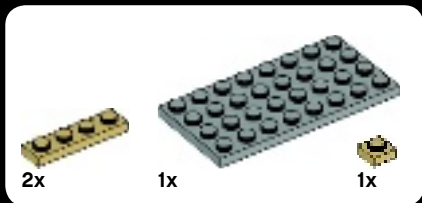

1

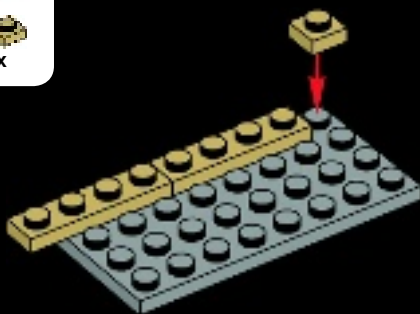

2



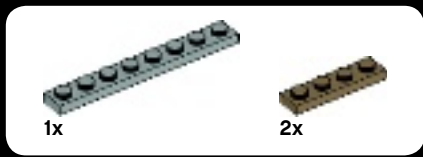

3

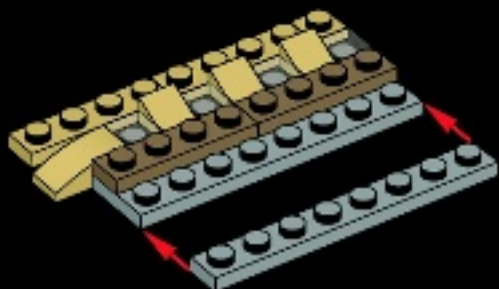

4

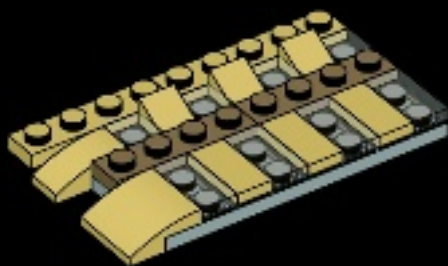



4x



1x



3x



1x



2x



1x

5

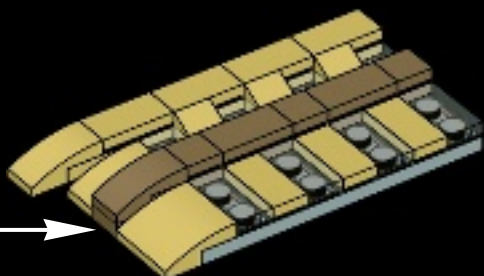

1x

6

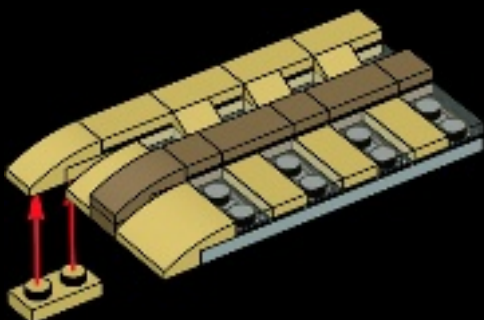

41

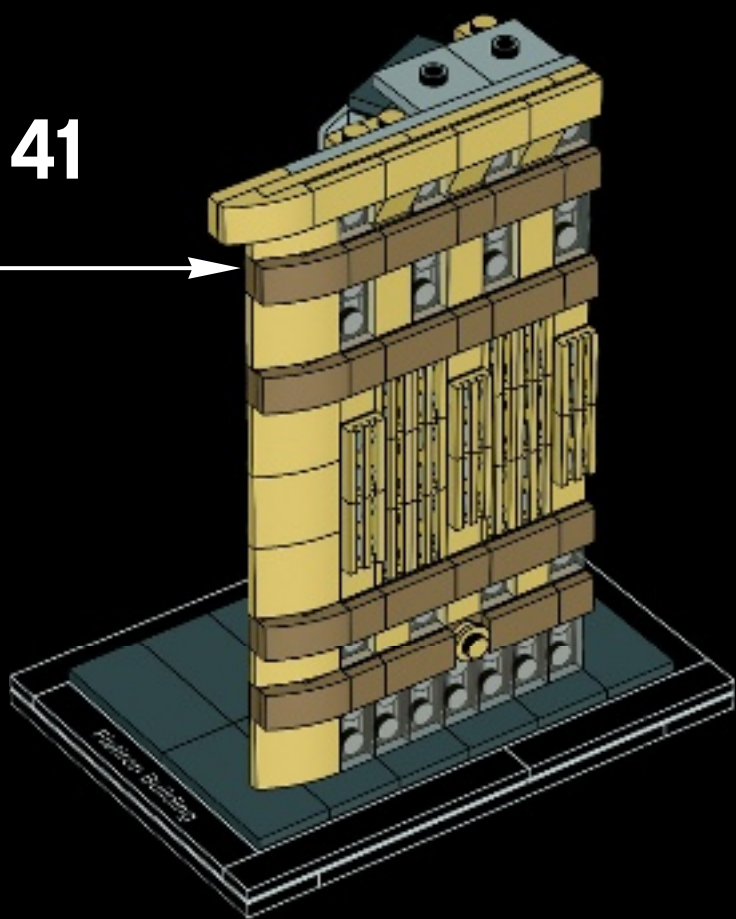



1



2

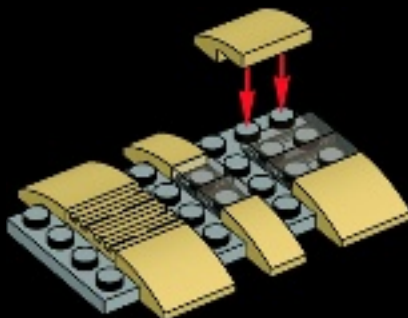

The façade includes many Italian and French Renaissance motifs, such as Greek faces and terracotta flowers.



©Veronica Mainetti



2x



2x

3

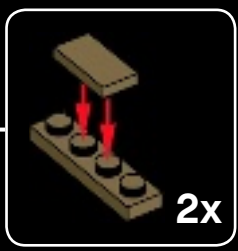
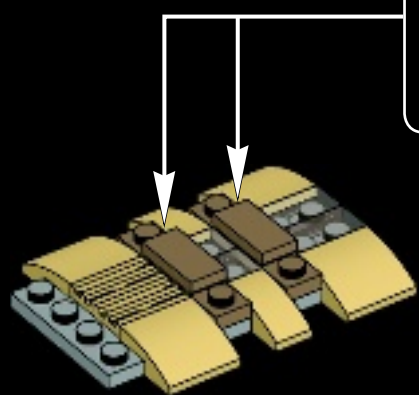

2x



4x



4x

4

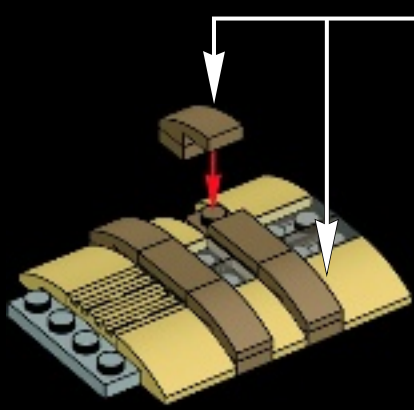

4x

42

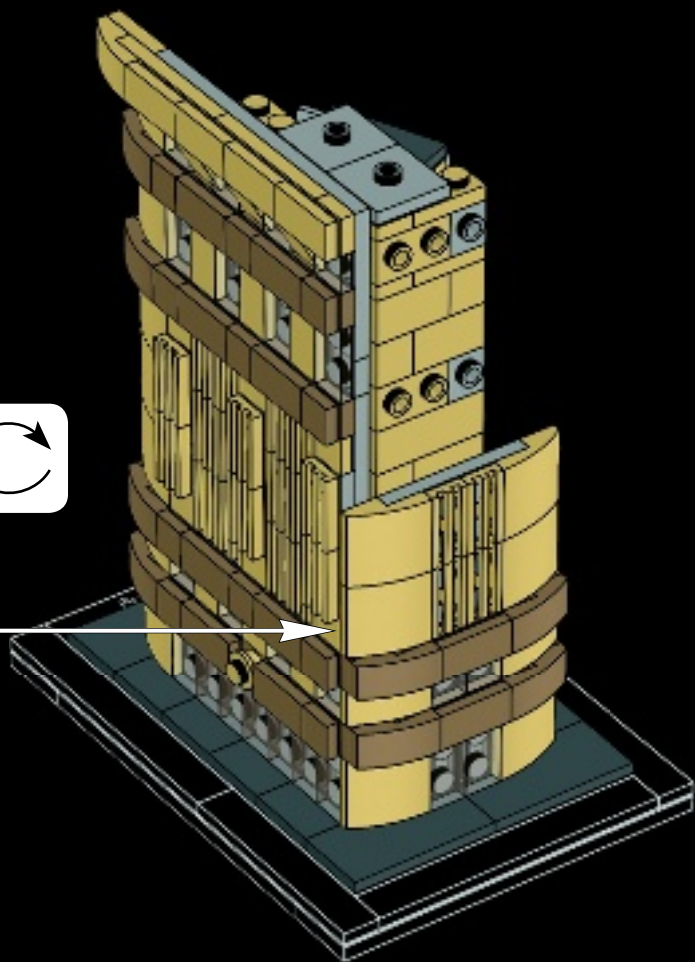
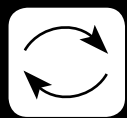

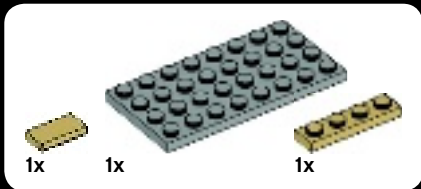

1



2

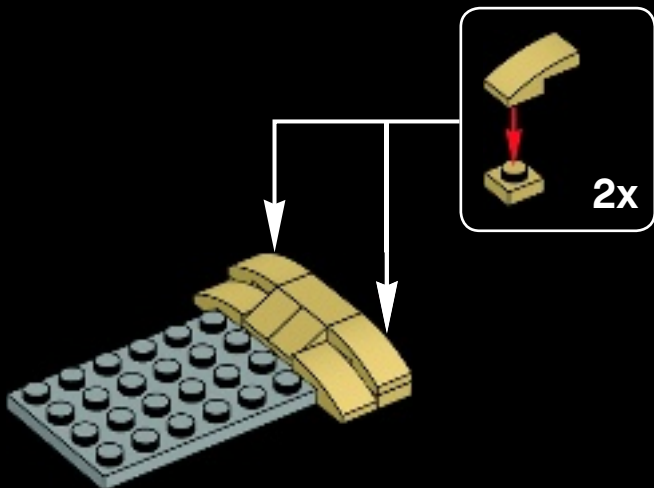



2x



2x



4x

3

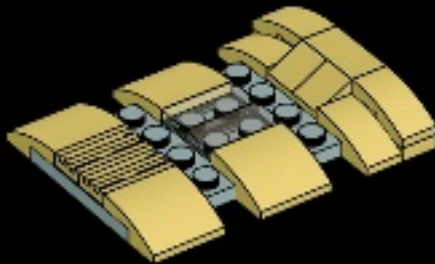

2x



2x

4

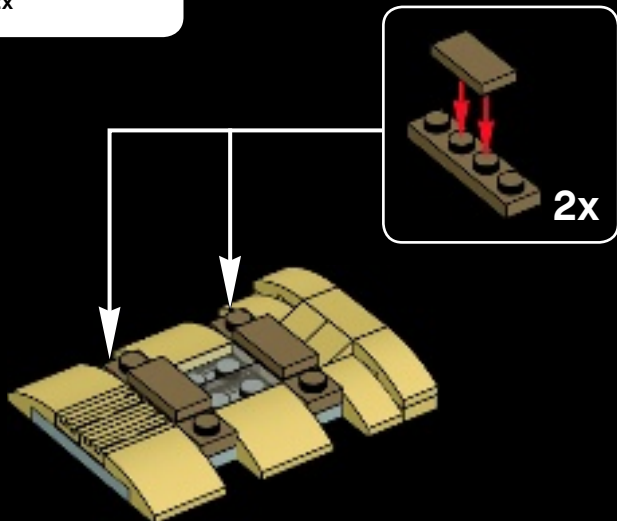



4x



4x

5

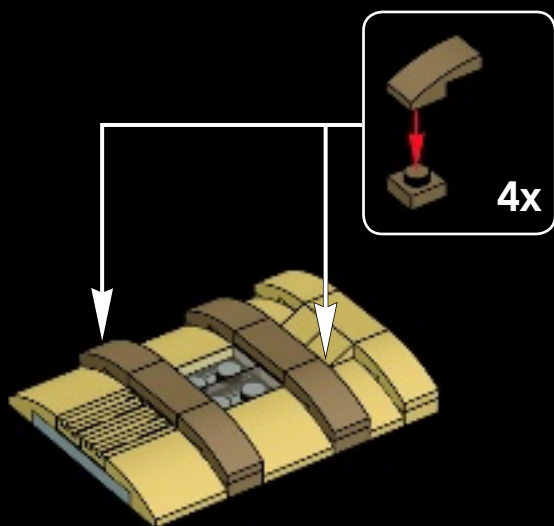

43



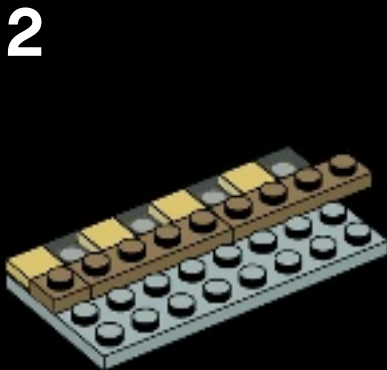
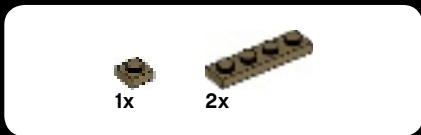
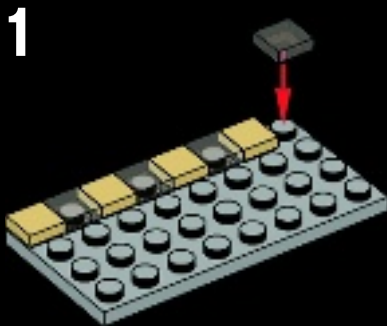

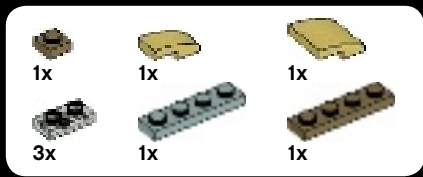

5

1

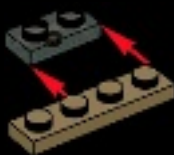

2



3

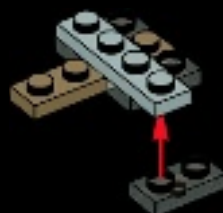

4

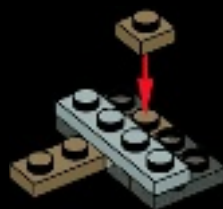

5



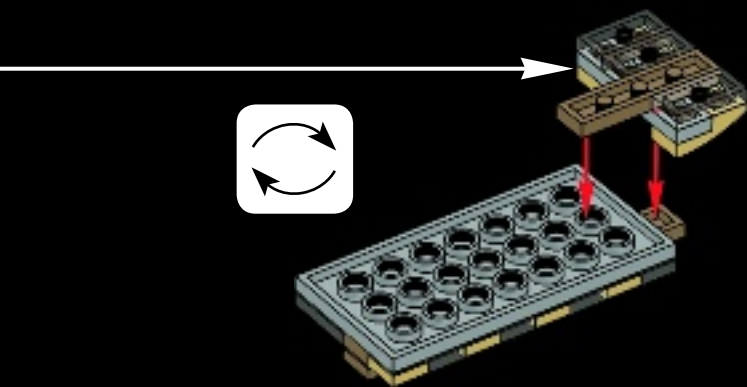

6

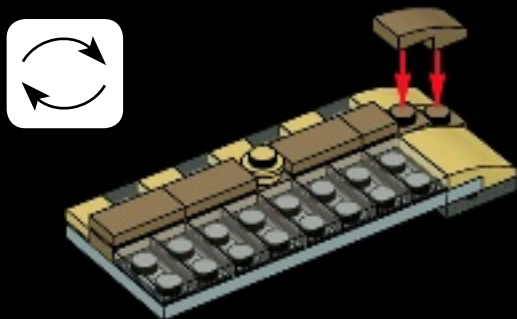

44

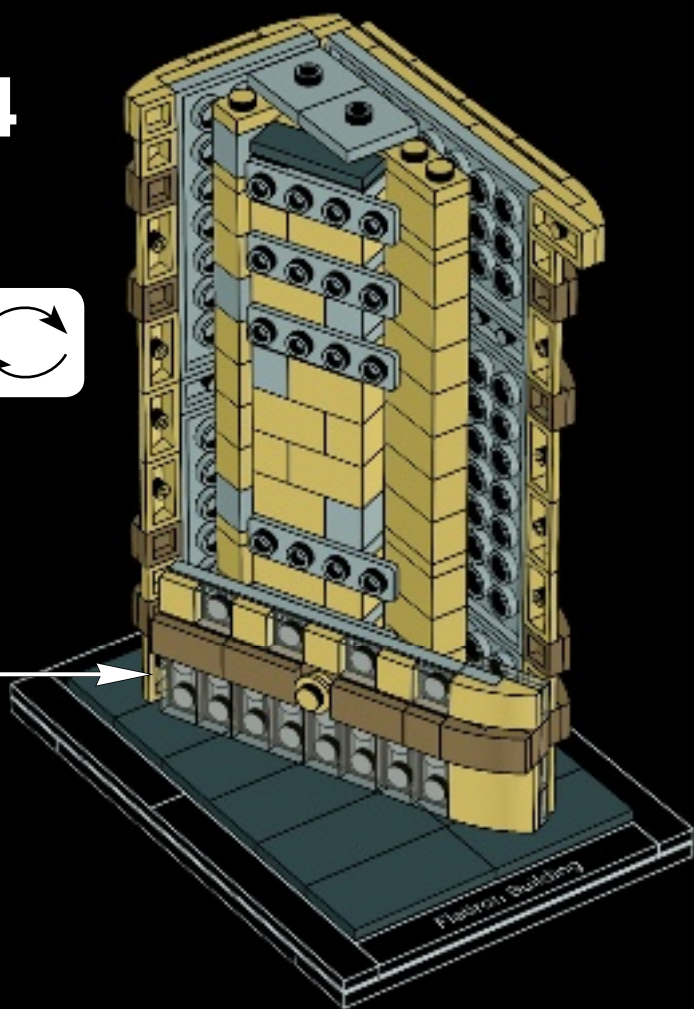



1x

3



2x



2x

4

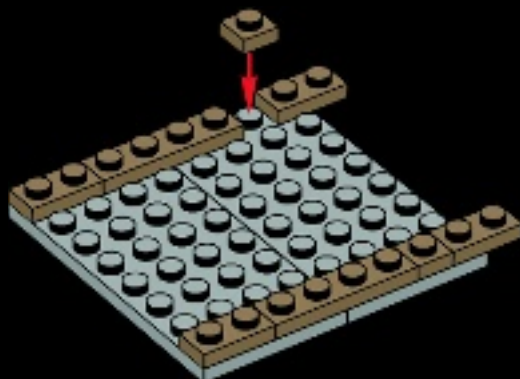



6x



3x

5



15x

6

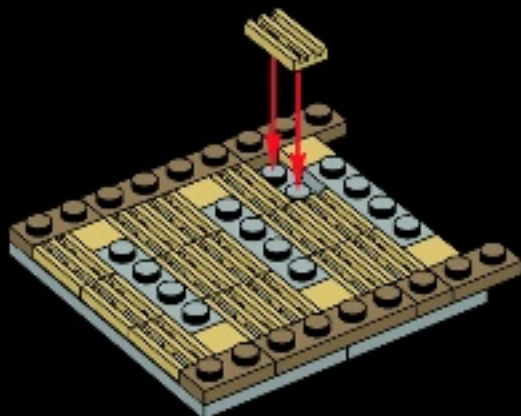



8x

7

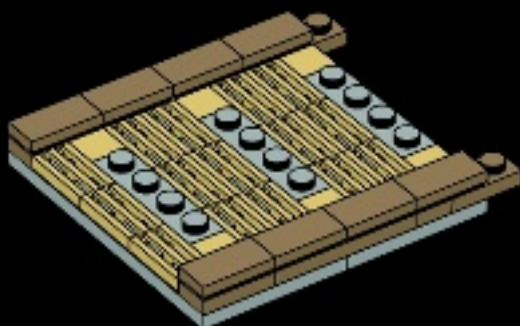

6x

8

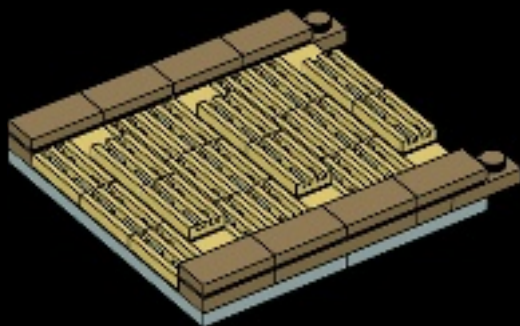

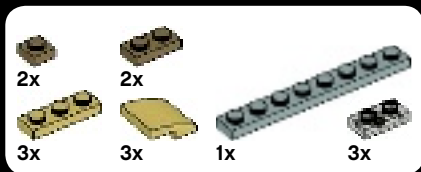

9

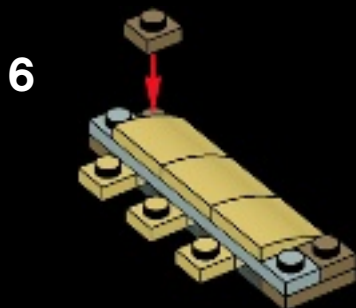
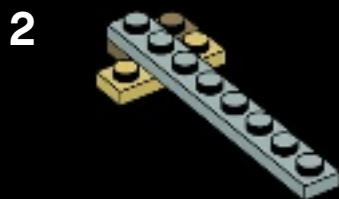
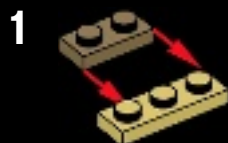

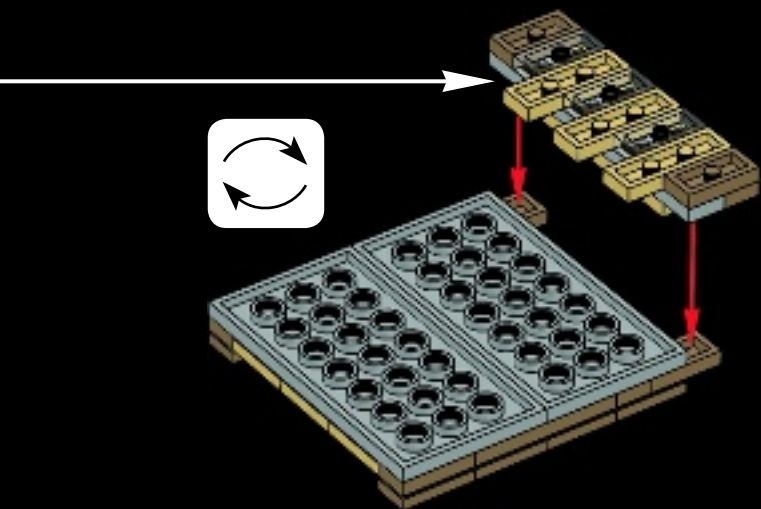

10

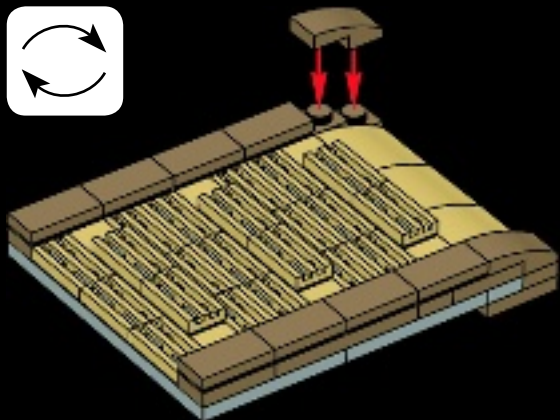

45

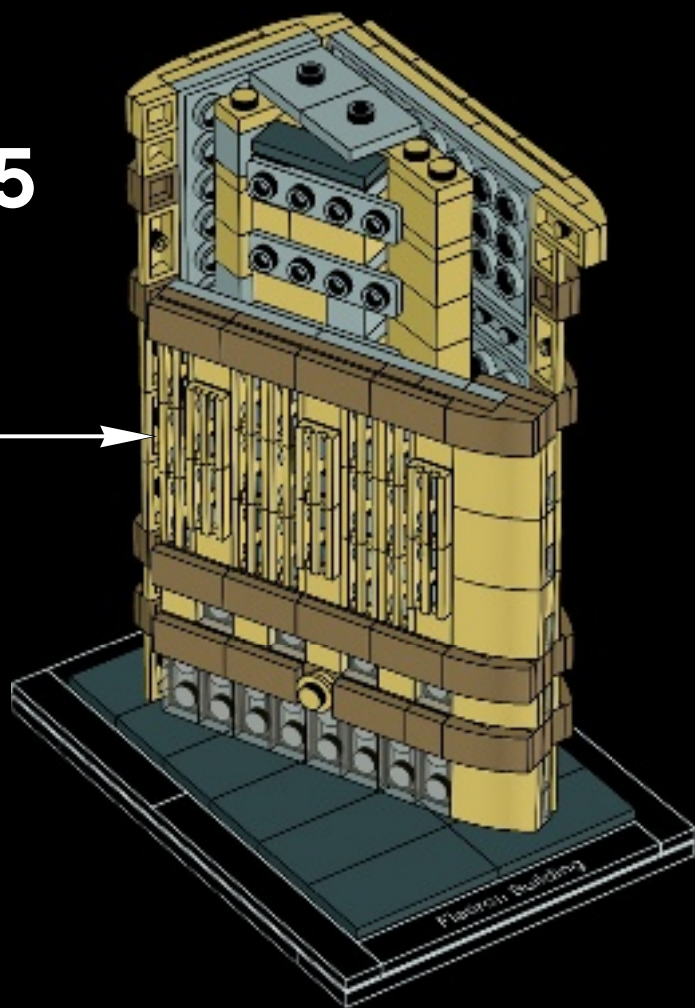

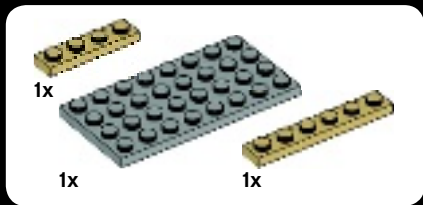

1

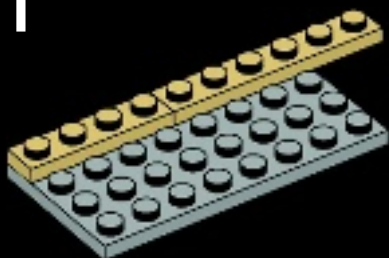

2

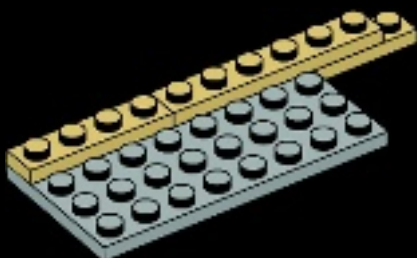

3

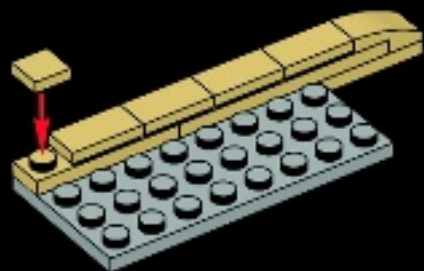

4

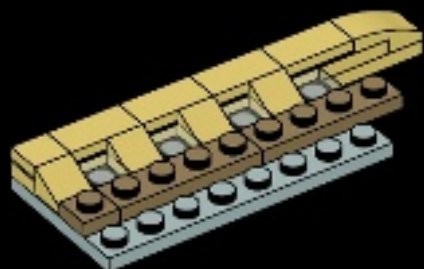

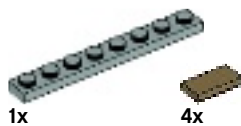

1x

4x

5

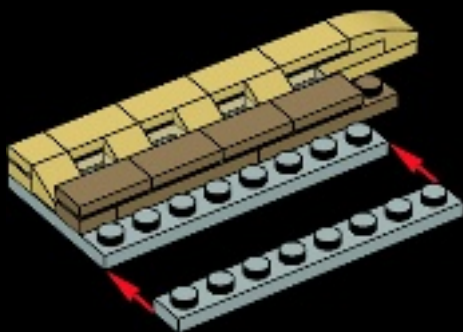

4x



4x

6

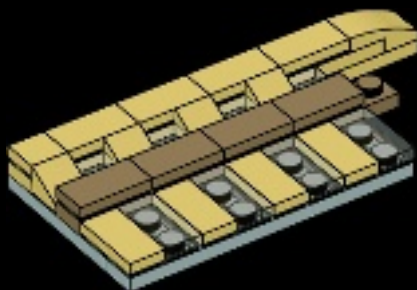



7

1



2



3



4



5



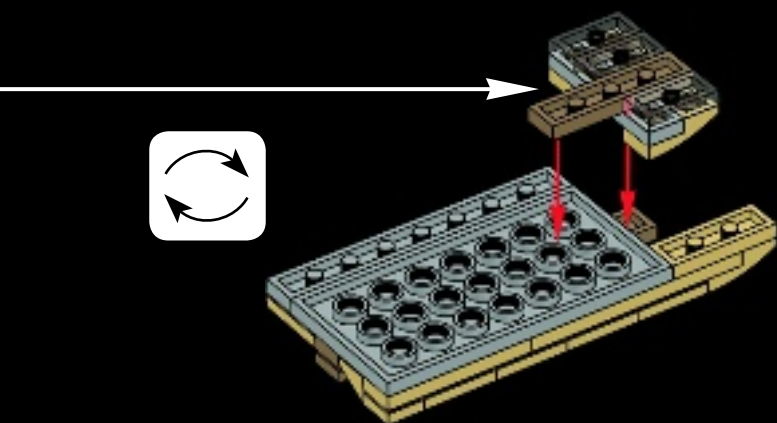

8

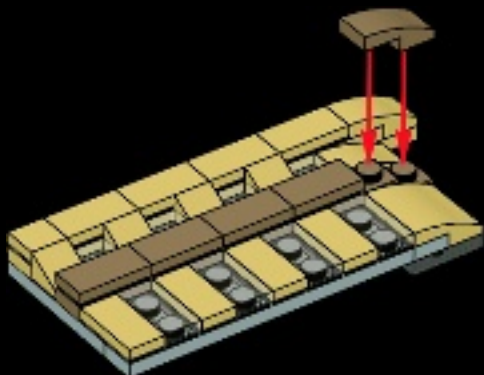

46

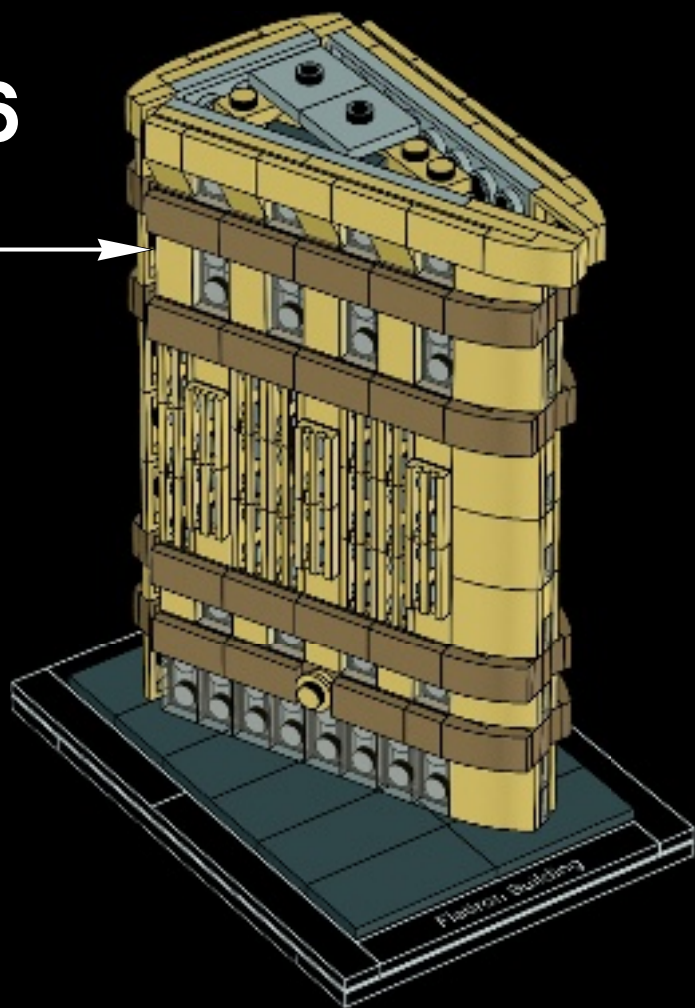

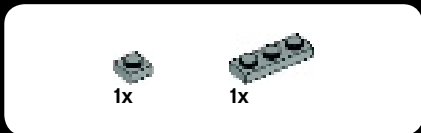

1

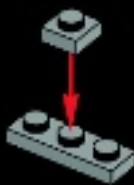

2

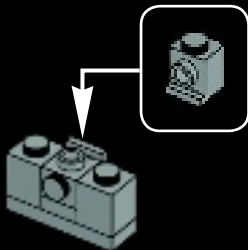

3

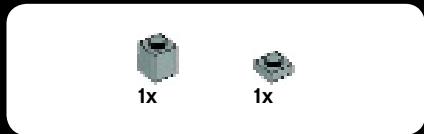
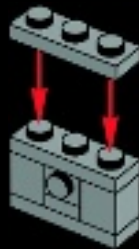

4

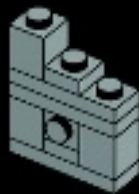

5

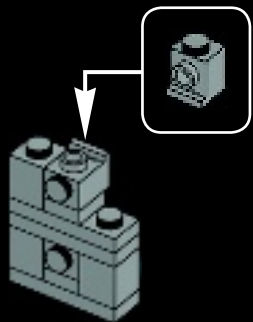



1x

6

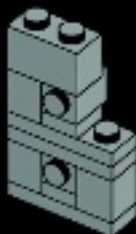

1x



1x

7

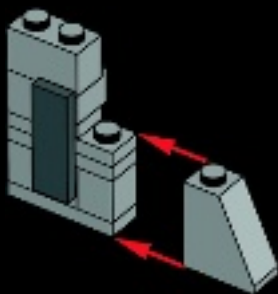

1x

8

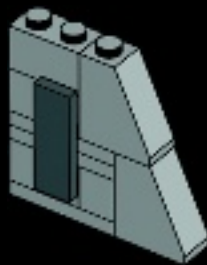

2x



1x

9

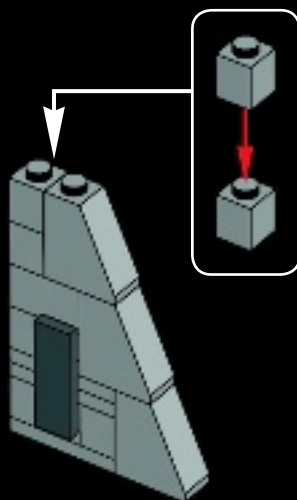

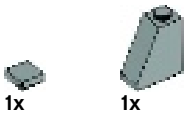

10

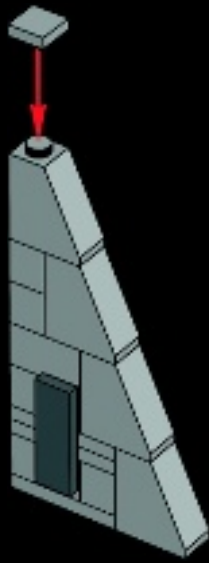

11

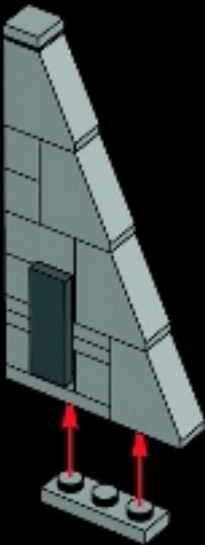

The upper floor originally housed a restaurant and an observation deck, both now closed.



©Veronica Mainetti

47

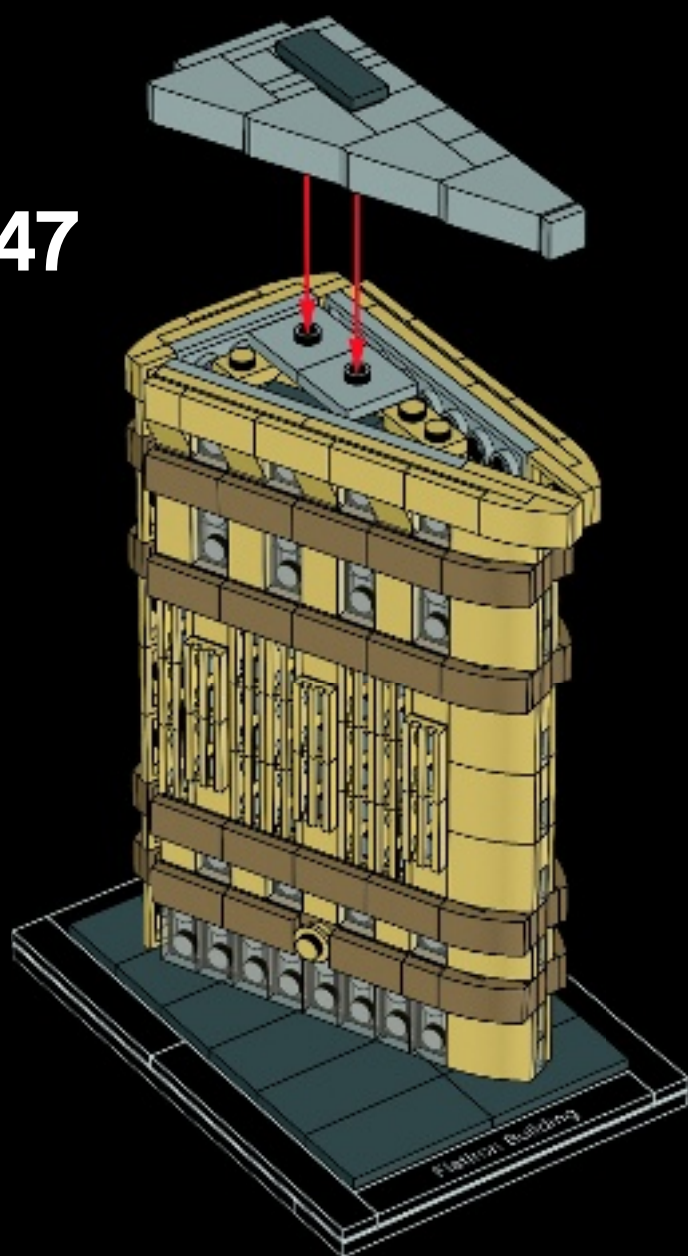

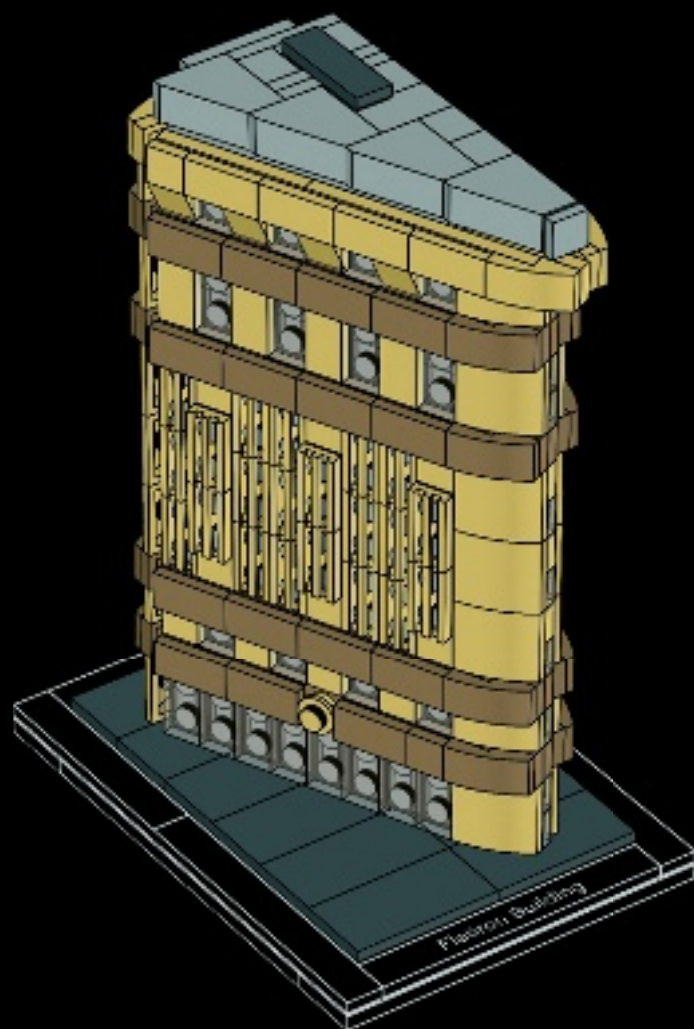

LEGO® Architecture – Then and Now

There has always been a natural connection between the LEGO® brick and the world of architecture. Fans who build with LEGO elements instinctively develop an interest in the form and function of the structures they create. At the same time, many architects have discovered that LEGO bricks are the perfect way of physically expressing their creative ideas.

This connection was confirmed in the early 1960s with the launch of the LEGO “Scale Model” line. It matched the spirit of the age where modern architects were redefining how houses look and people were taking an active interest in the design of their new homes. These sets were designed to be different from the normal, brightly colored LEGO boxes; they also included a book on architecture as a source of inspiration.



21050
LEGO Architecture Studio



Decades later, architect and LEGO fan Adam Reed Tucker revived the idea of expressing architecture using LEGO bricks and in partnership with the LEGO Group, launched the LEGO Architecture line that we know today. His first models, and the original sets in the current LEGO Architecture series, were interpretations of famous skyscrapers from his hometown of Chicago. Since then LEGO Architecture has developed and evolved, first with well-known buildings from other cities in the United States, and now with iconic structures from Europe, the Middle East, and Asia.

The introduction of our LEGO Architecture Studio set echoes the ambitions of the earlier LEGO “Scale Model” line and widens the potential of the LEGO Architecture series. Now you can enjoy building and learning about specific landmark buildings, or create exciting architectural models from your own fantasy. An inspiring 270-page book, featuring a number of renowned architects from around the world, guides you through the principles of architecture and encourages you in your own creative building.

Celebrate the world of architecture

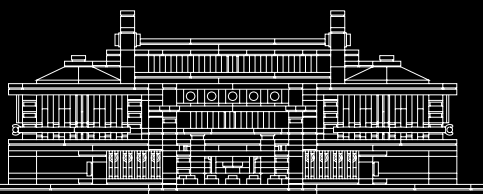

21017
Imperial Hotel

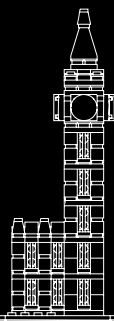

21013
Big Ben

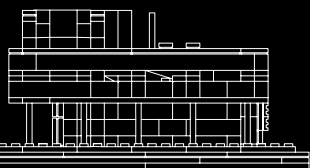

21014
Villa Savoye

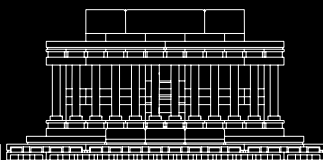

21022
Lincoln Memorial

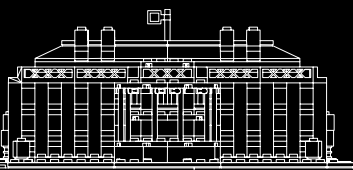

21006
The White House

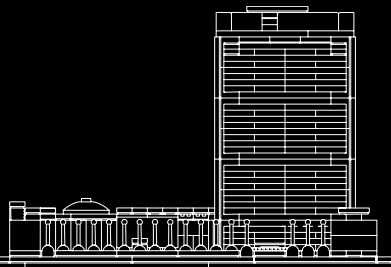

21018
United Nations Headquarters

and collect all the models

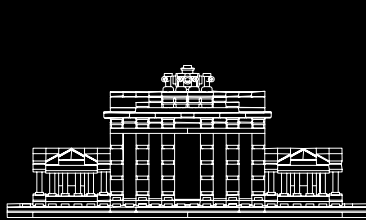

21011
Brandenburg Gate



21020
Trevi Fountain

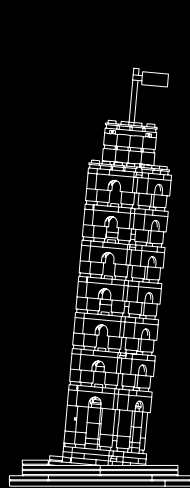

21015
The Leaning Tower
of Pisa

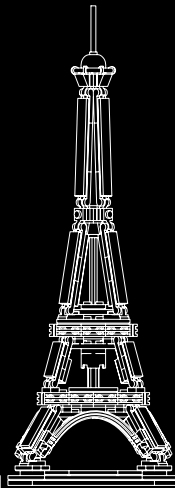

21019
Eiffel Tower



21003
Seattle
Space Needle

5x
4113915

18x
4109995

8x
4124455

6x
4162465

4x
4112982

4x
6024495

9x
4516055

12x
6046922

20x
6046924

3x
4159553

21x
4125253



45x
4124456

21x
4113917

20x
4114026

10x
4121921

4x
4113233

3x
4124067

2x
4161734

2x
663626

1x
6101020

3x
416226

4x
383226

18x
6038458

27x
4529685

9x
6001197

16x
6101254

12x
6055172

26x
4549436

10x
4528604

27x
4496699

18x
4626904

4x
4211055

2x
4568734

8x
4560184

1x
6011459

1x
4211461

5x
4211389

1x
4211388

7x
4558953

2x
4211476

2x
4211399

1x
4211415

2x
4565393

4x
4211429

9x
4211445

3x
4211425

10x
4211407

10x
4211407

2x
4211408

12x
6014615

2x
6102769

4x
4515374

1x
4654448

References

Text credits:

The Flatiron Building: The New York Landmark And The Incomparable City That Arose With It, Alice Sparberg Alexiou, Thomas Dunne Books, 2010.

Photo credits:

Shutterstock.com

Wikipedia.org

Veronica Mainetti, Sorgente Group of America

Per Tropp-Christiansen

Gettyimages.com

Customer Service

Kundenservice

Service Consommateurs

Servicio Al Consumidor

LEGO.com/service or dial



00800 5346 5555 :



1-800-422-5346 :



