



Architecture

21051

Tokyo

Japan



Booklet available in English on
Heft in deutscher Sprache erhältlich auf
Livret disponible en français sur
Libretto disponibile in italiano su
Folleto disponible en español en
Folheto disponível em português em
A füzet magyarul ezen a honlapon olvasható:
Buklets latviešu valodā pieejams vietnē
如需中文版手册, 请访问

LEGO.com/architecture



Tokyo

With Mount Fuji as its spectacular backdrop, Japan's capital city successfully mixes ancient tradition and the ultra-modern into one bustling, remarkable metropolis. Full of culture, commerce and people, Tokyo also contains some of the world's most stunning architecture.

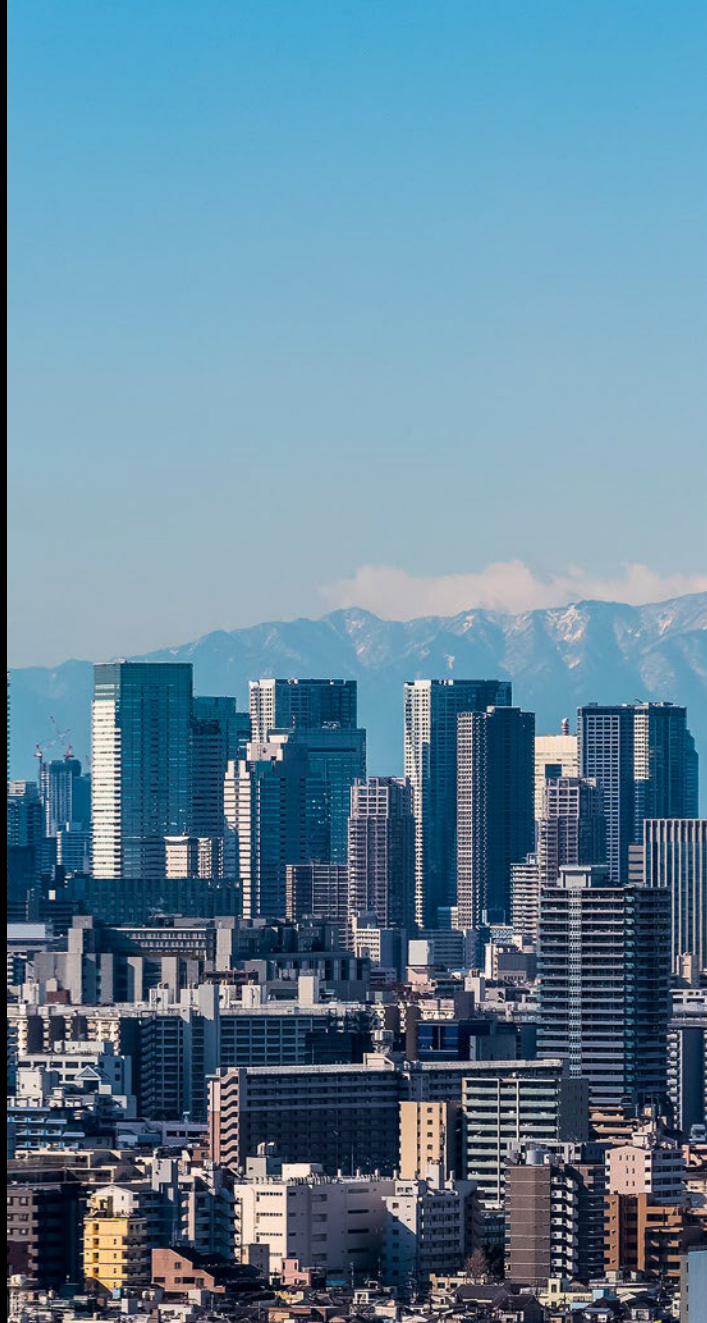

*“Living right in the heart of Tokyo itself is quite like living in the mountains
– in the midst of so many people, one hardly sees anyone.”*

Yūko Tsushima



Tokyo Tower

Built in prefabricated steel and reaching a height of 1,092 ft. (333m), this iconic structure has been one of the city's most popular attractions since its completion in 1958. As well as transmitting Tokyo's TV and radio stations signals, instruments at the top of the tower also monitor air conditions above the crowded city.







Mode Gakuen Cocoon Tower

Located in the Nishi-Shinjuku high-rise district, this 669 ft. (204 m) tall building is home to three colleges and over 10,000 students. Its distinctive curved shape, dark blue glass and crisscrossed web of white diagonal lines creates a nurturing environment for the students studying inside.

Chidorigafuchi Park

The park is a narrow path that runs alongside the moat of the city's Imperial Palace. Many locals and tourists flock to the area in early Spring to witness the spectacular cherry blossoms during the brief hanami or flower viewing season.



"Tokyo was a place you could quite happily exist alone and be self-contained."

Olivia Sudjic



TOKYO SKYTREE

TOKYO SKYTREE is the new symbol of the city of Tokyo. Though ultra-modern in both its appearance and construction, the architecture of TOKYO SKYTREE is similar to the classical design of the traditional 5-story Japanese pagoda. Opened to the public in May 2012, TOKYO SKYTREE is the tallest free-standing tower in the world, rising 2,080 ft. (634m)





Shibuya Crossing

This iconic crossing at the heart of the Shibuya shopping district is the busiest in Japan (and possibly the world). At peak times up to 3000 people will cross the intersection, coming from several directions at once. In the evening, the area comes alive with the colorful lights of the neon signs and jumbo screens.

Tokyo Big Sight

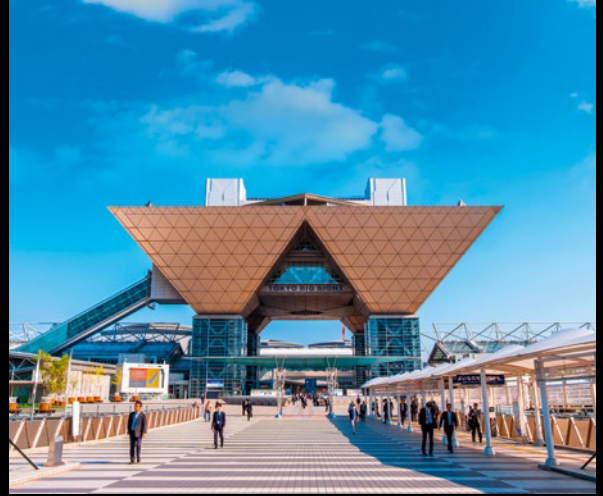

Overlooking Tokyo Bay and officially known as the Tokyo International Exhibition Center, Tokyo Big Sight attracts over 16 million visitors each year. Its most striking feature is the 190 ft. (58m) tall glass and titanium conference tower shaped like an inverted pyramid.



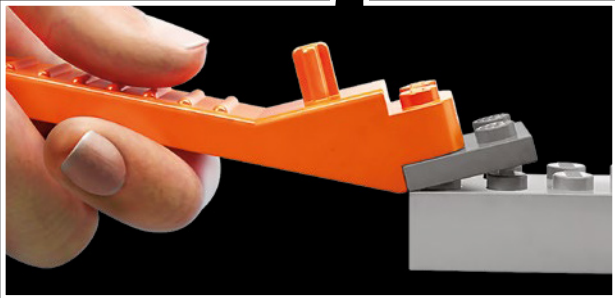
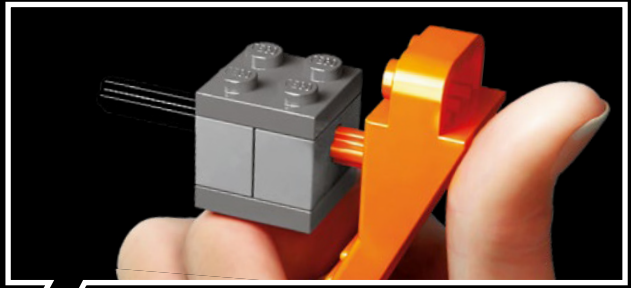
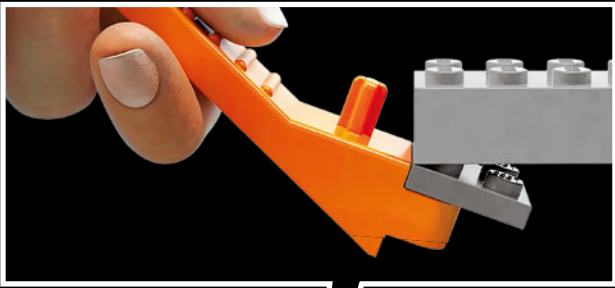



- 1** Scan the code on the front cover
 Scanne den Code auf der Titelseite
 Scanne le code sur la page de couverture
 Scanner le code sur la page couverture
 Scansiona il codice sulla copertina
 Escanea el código de la portada
 Faz scan do código na frente da capa
 Olvasd be a borítón látható kódot!
 Noskenē kodu uz priekšējā vāka
 扫描封面上的二维码



- 2** Get the Building Instructions
 Hol dir die Bauanleitung
 Obtens les instructions de montage
 Obtenir les instructions de montage
 Scarica le istruzioni per la costruzione
 Consulta las instrucciones de construcción
 Obtém as Instruções de Construção
 Szerezd be az építési útmutatókat!
 Saņem būvēšanas instrukcijas
 获取拼搭说明

LEGO.com/apps

Check for compatibility
 Kompatibilität prüfen
 Vérifier la compatibilité
 Controlla la compatibilità
 Comprueba tu compatibilidad

Verificar a compatibilidade
 Ellenőrizd a kompatibilitást
 Pārbaudīt saderību
 检查兼容性

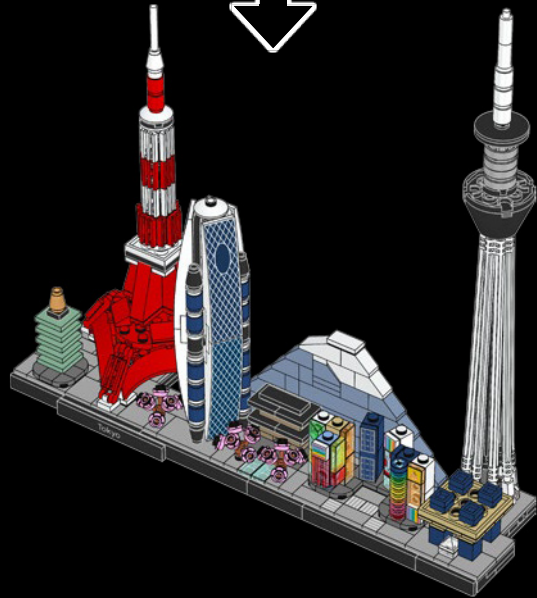
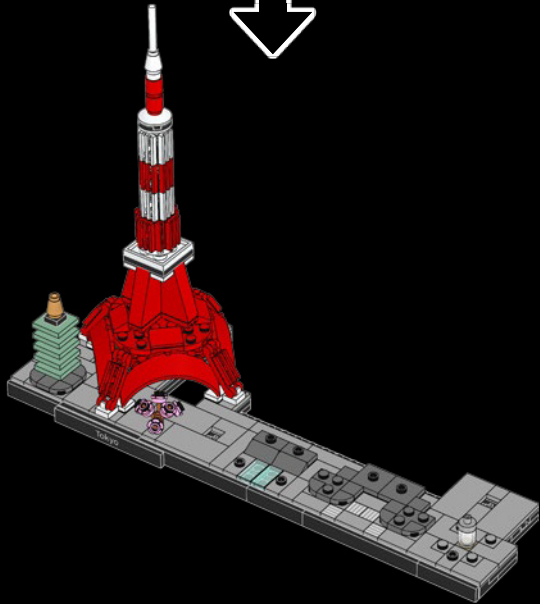

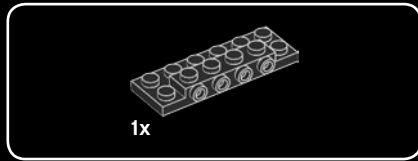
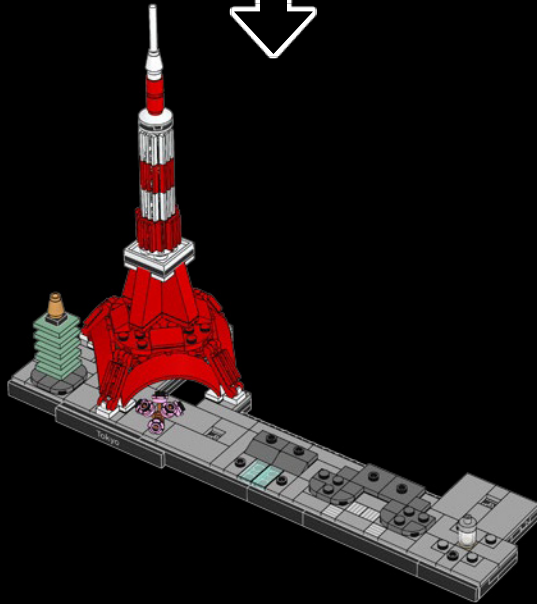

1

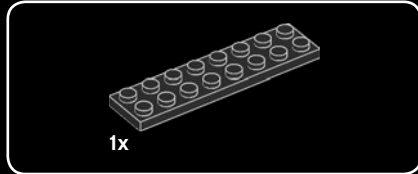
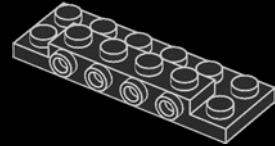

2

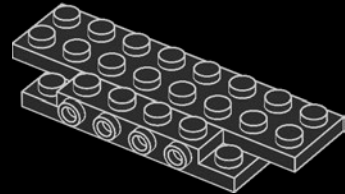

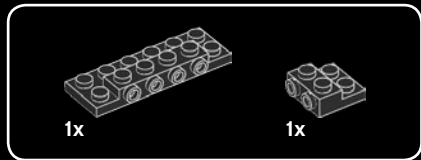

3

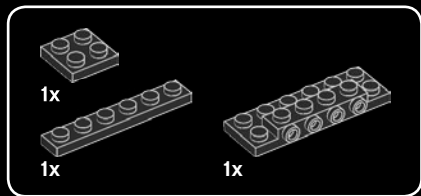
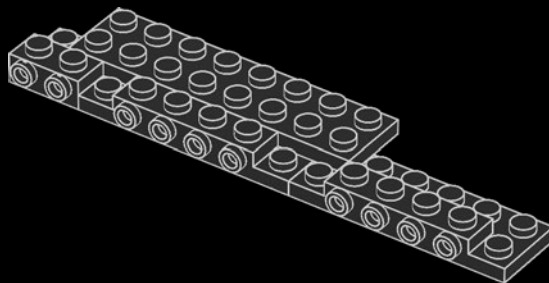

4

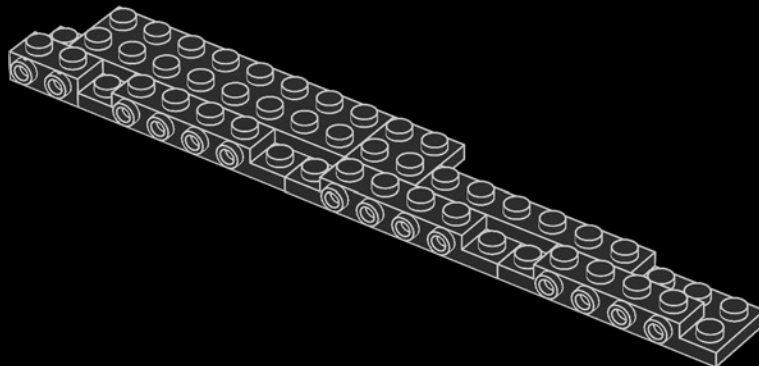

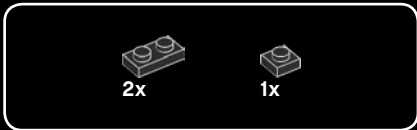

5

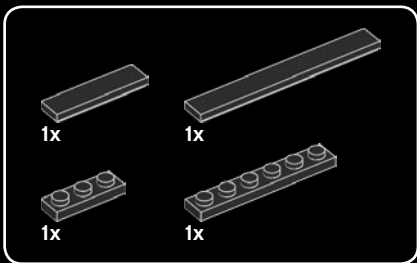
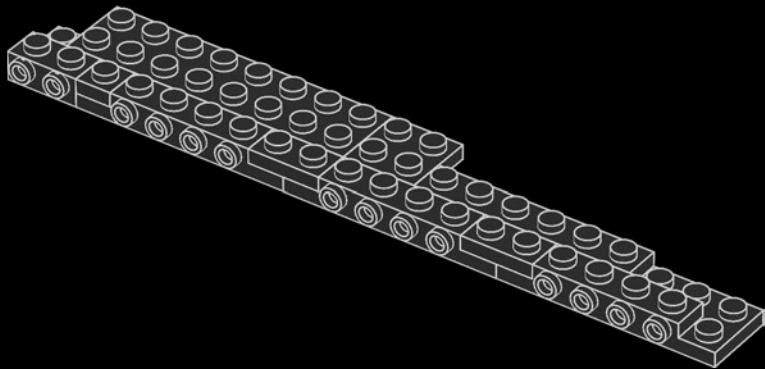

6

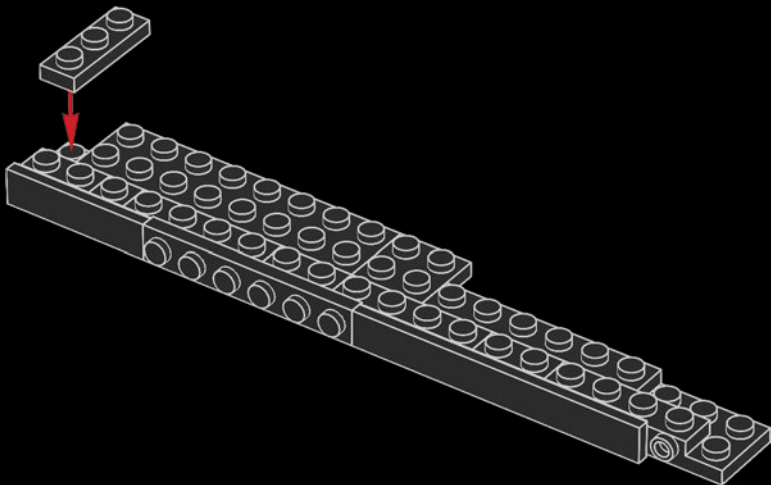

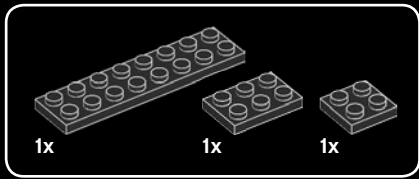

7

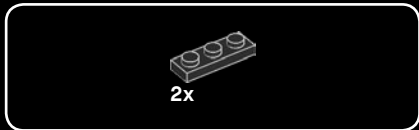
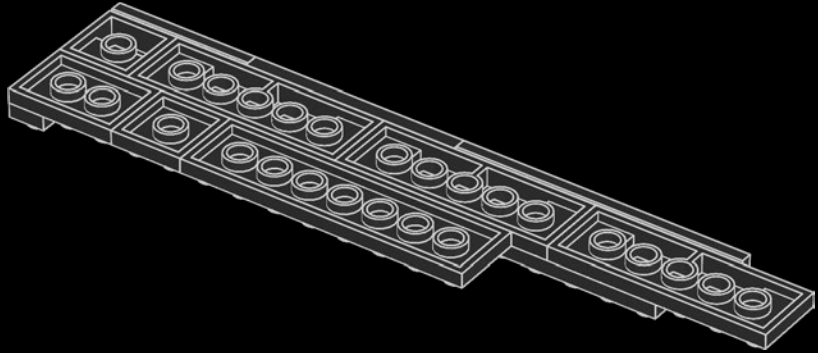

8

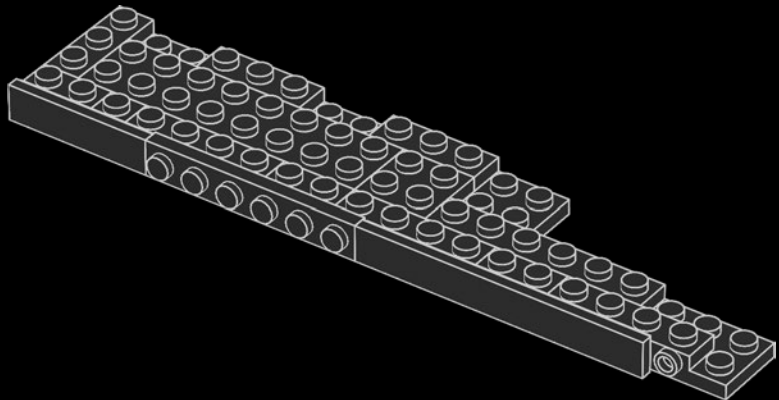

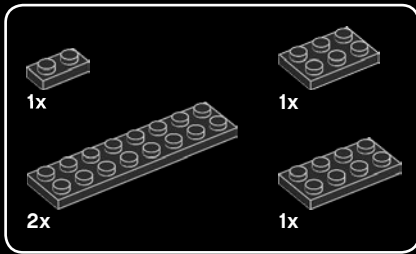

9

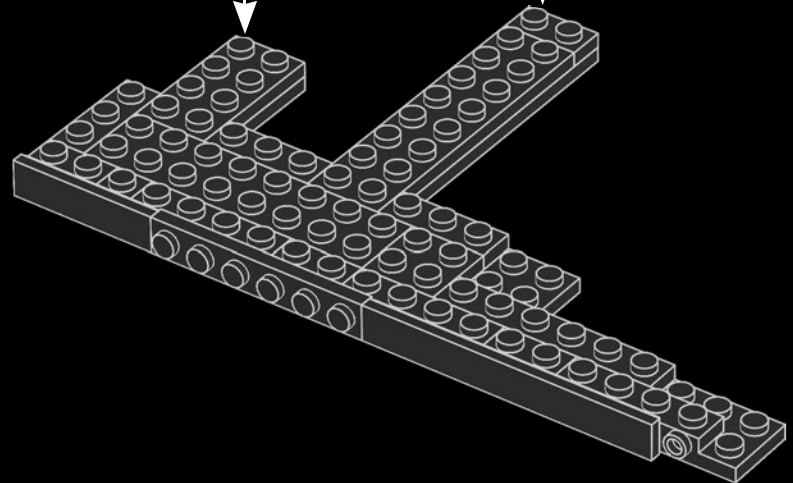
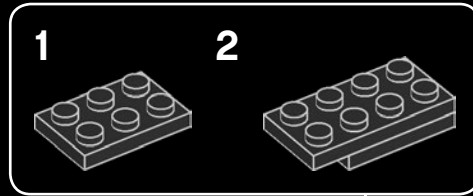
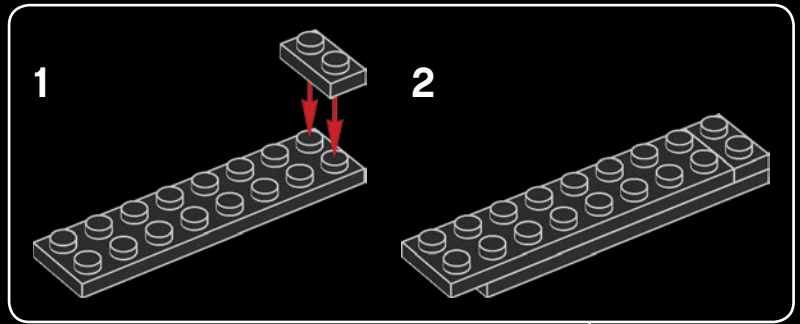

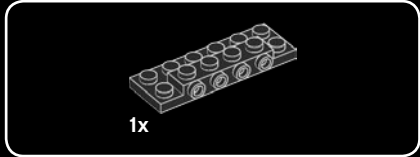
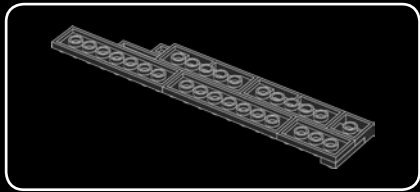

1x

10

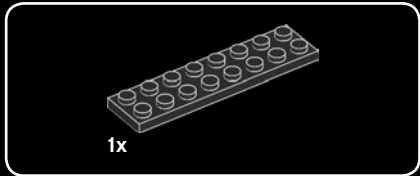
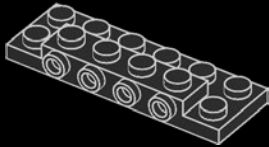

1x

11

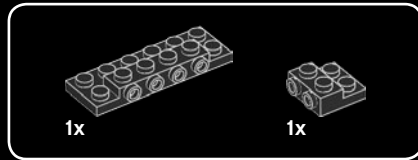
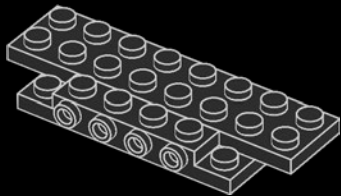

1x

1x

12

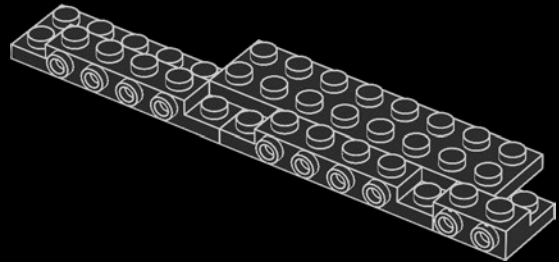

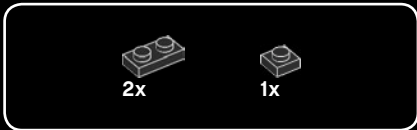

13

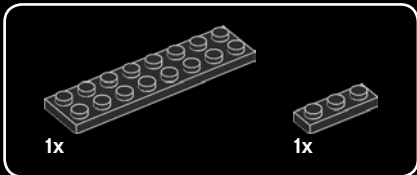
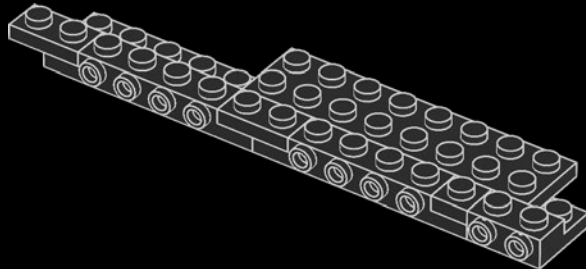

14

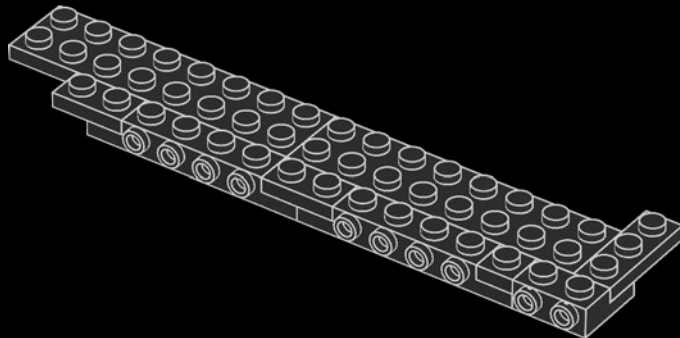

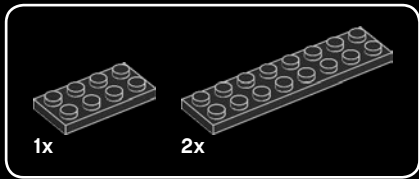

15

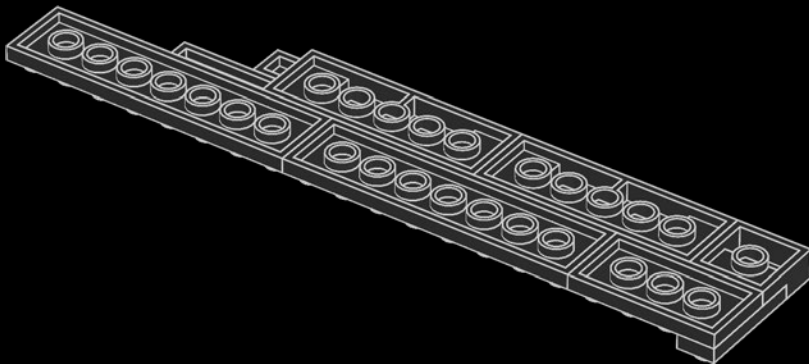

16

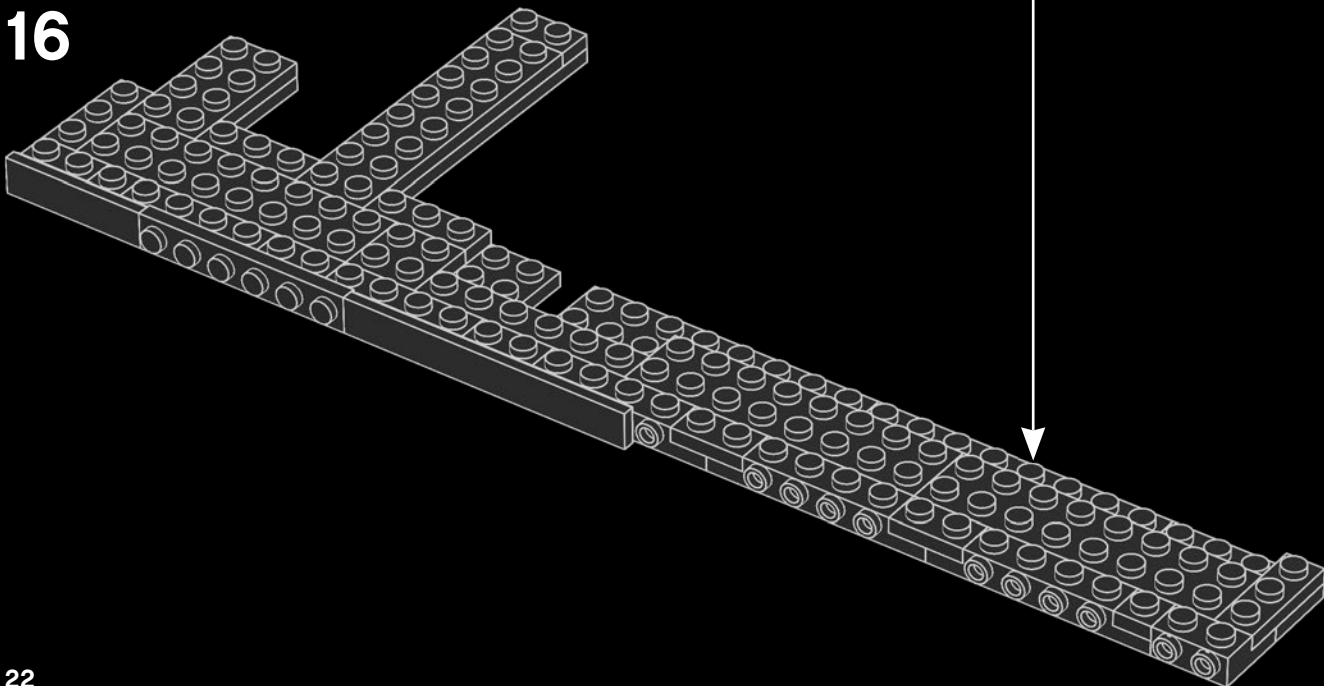

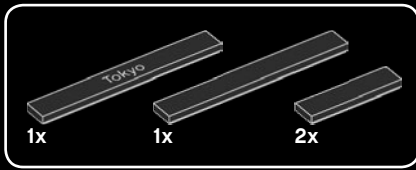

17

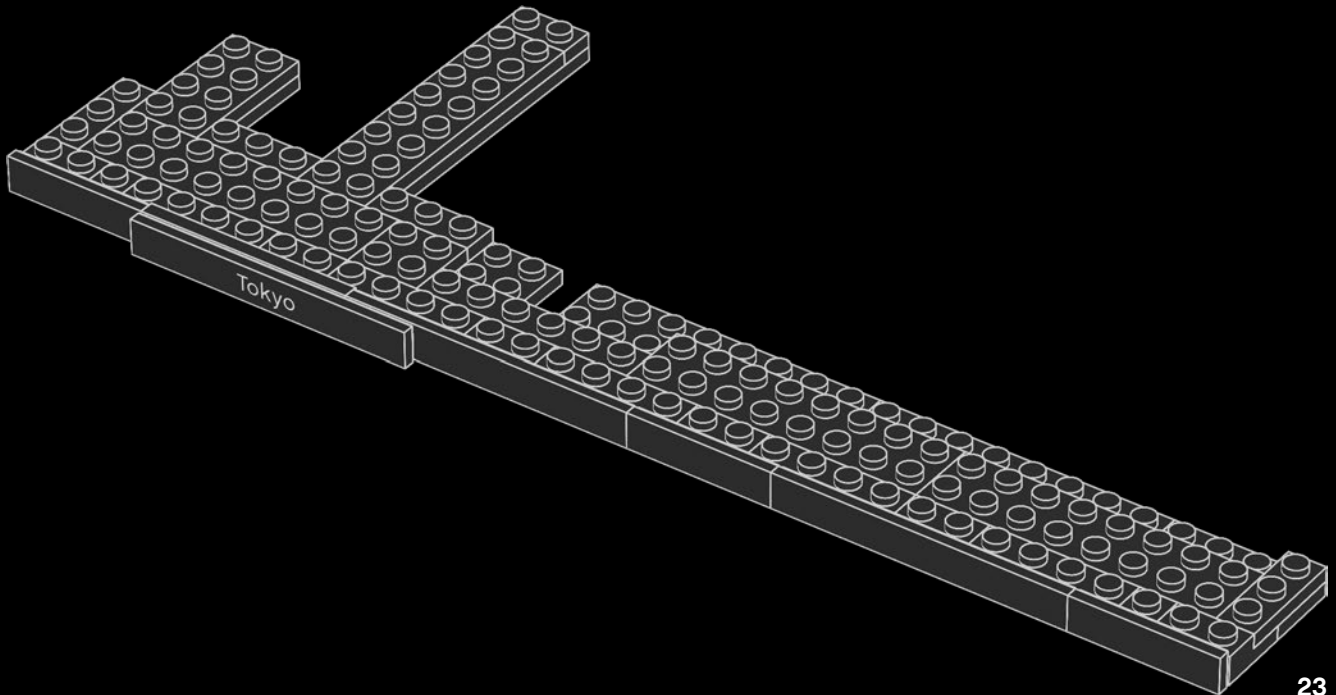

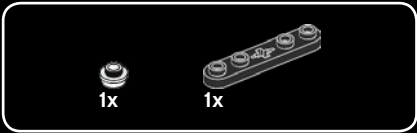

18

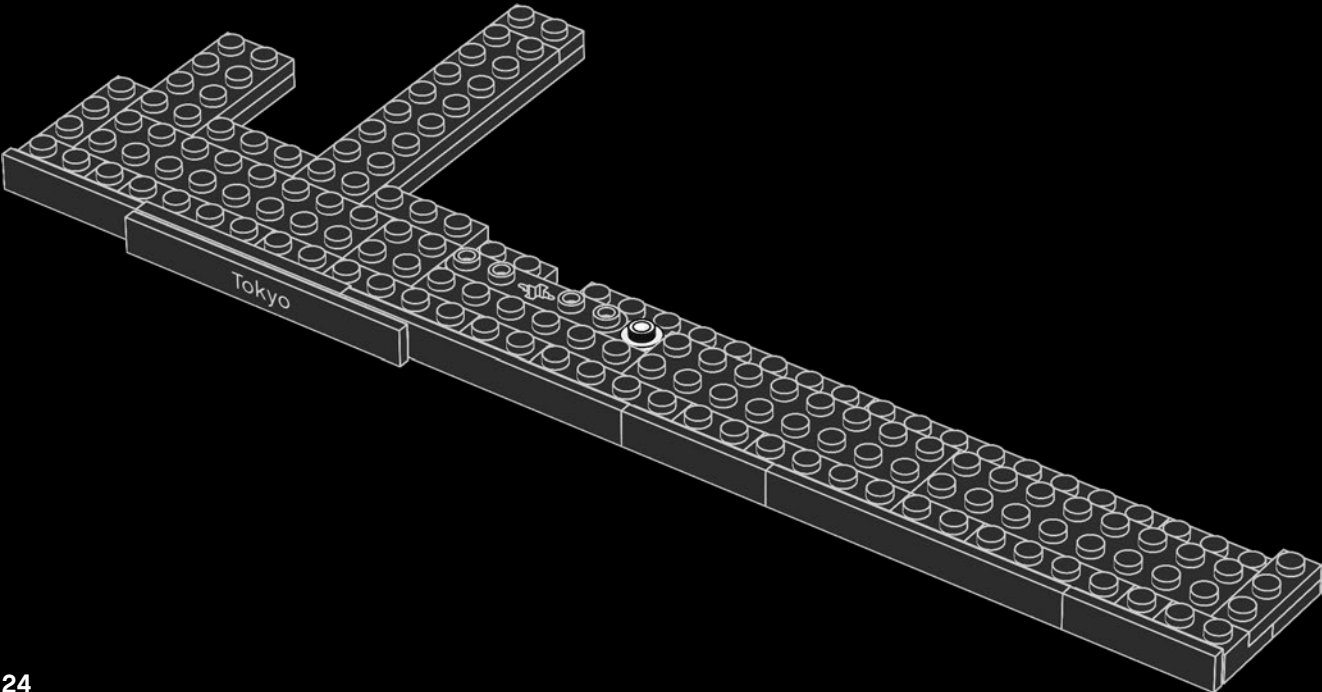

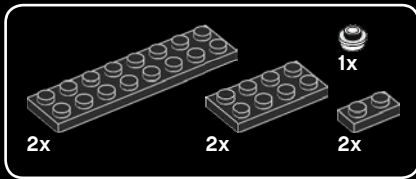

19

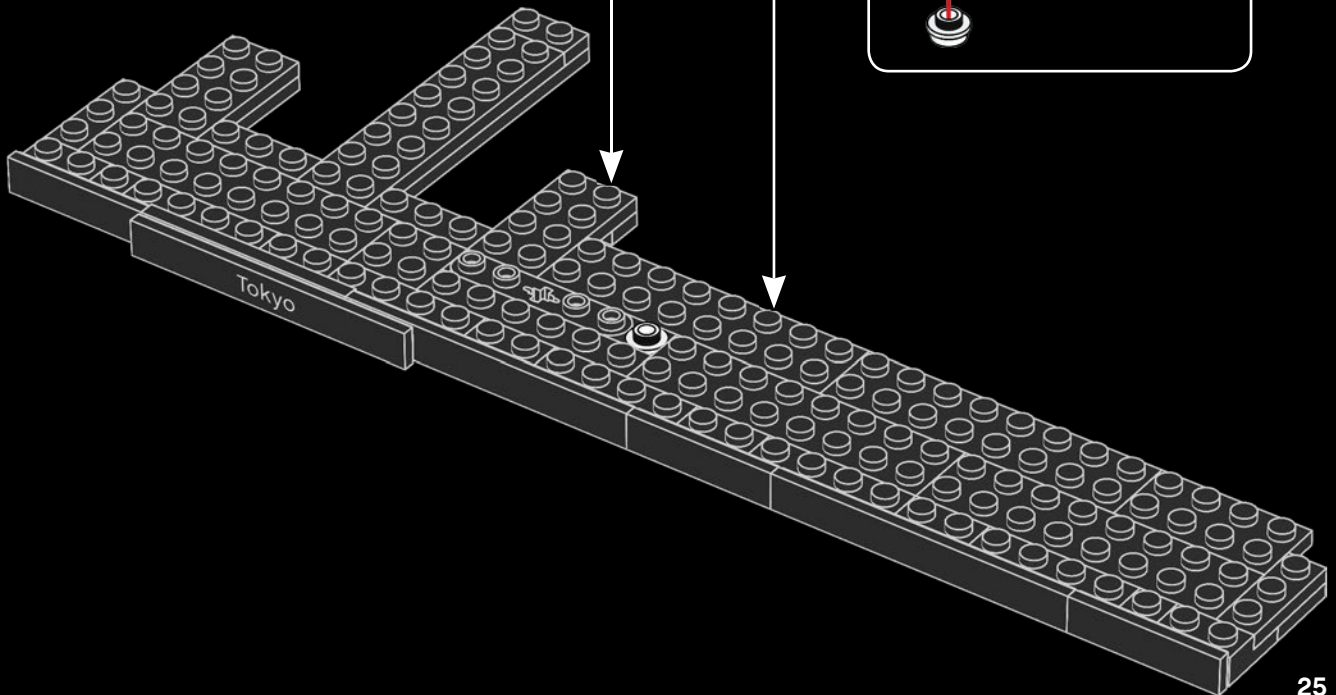
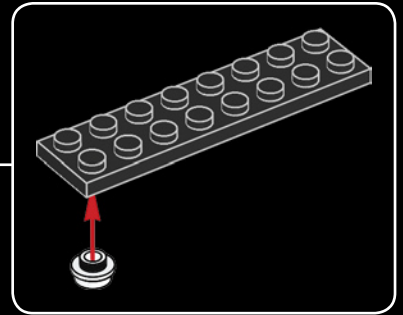
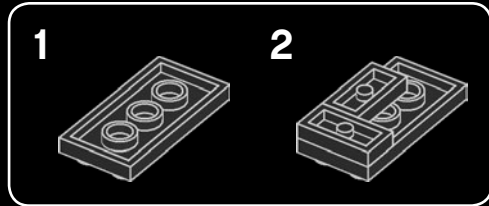

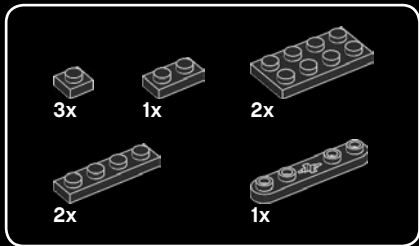

20

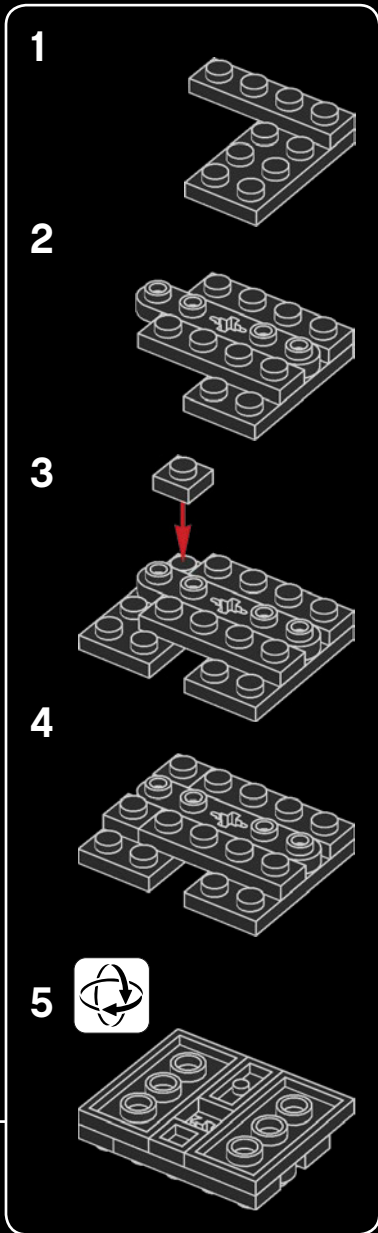
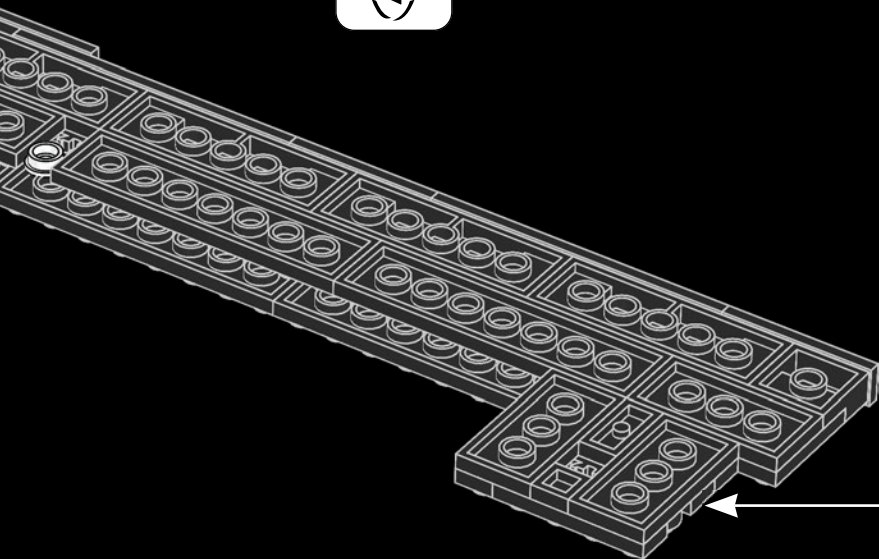

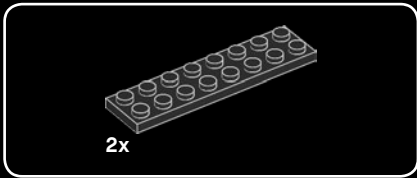

21

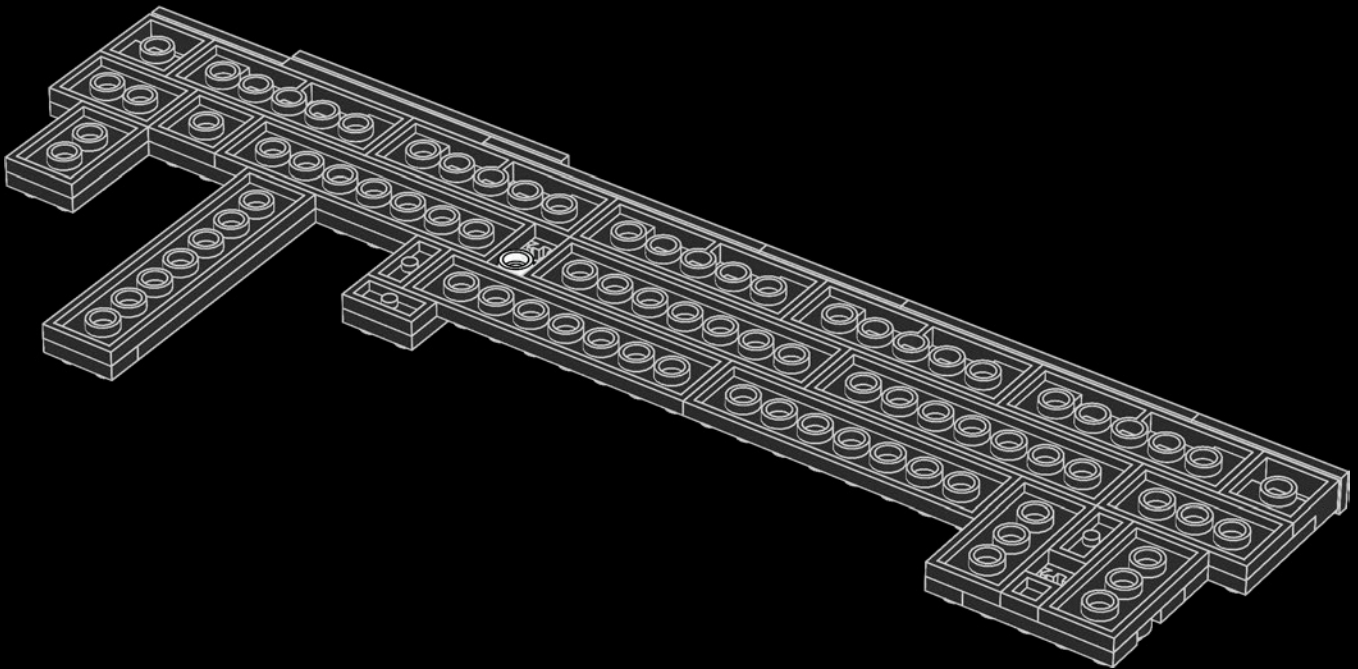

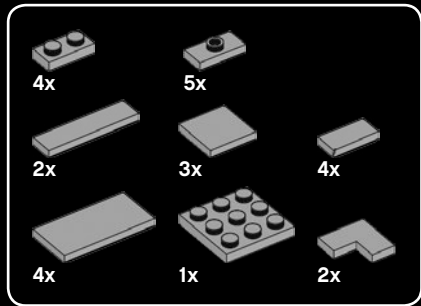

22

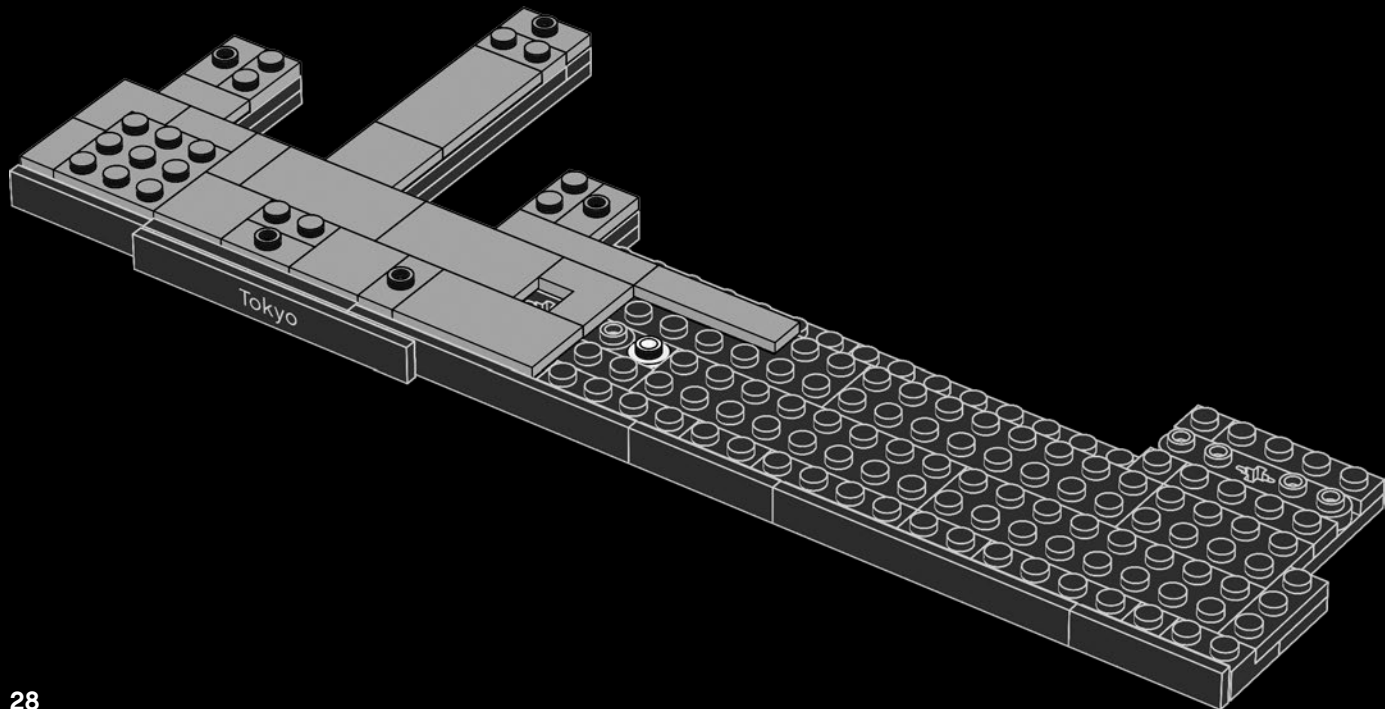

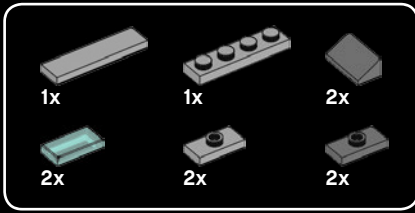

23

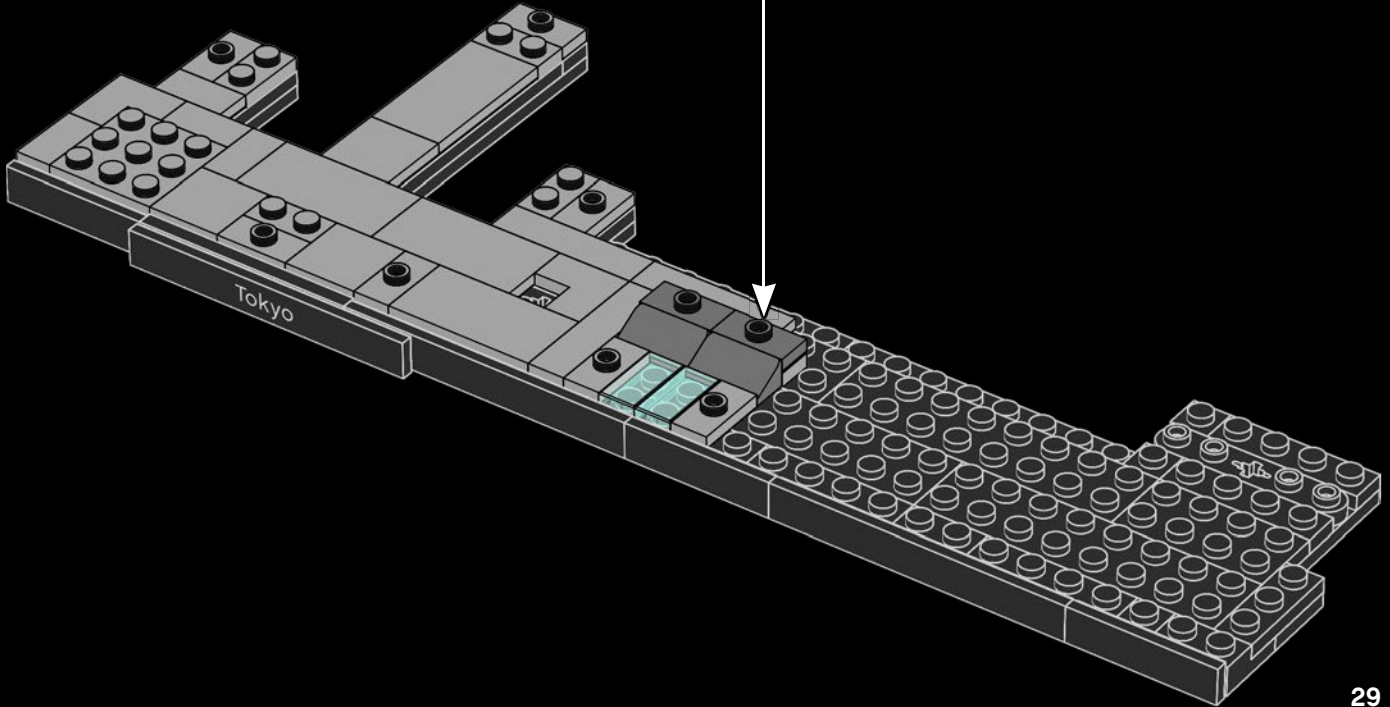
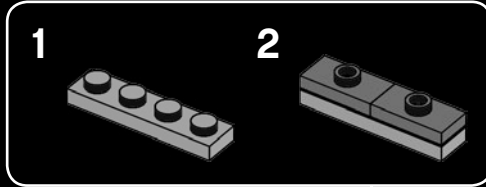

Shibuya Crossing

Seven crossroads meet at the Shibuya Crossing.

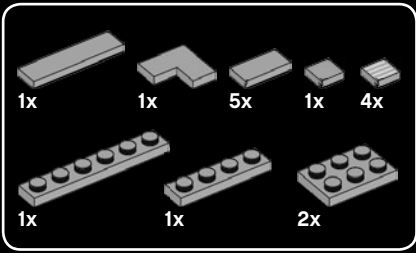

24

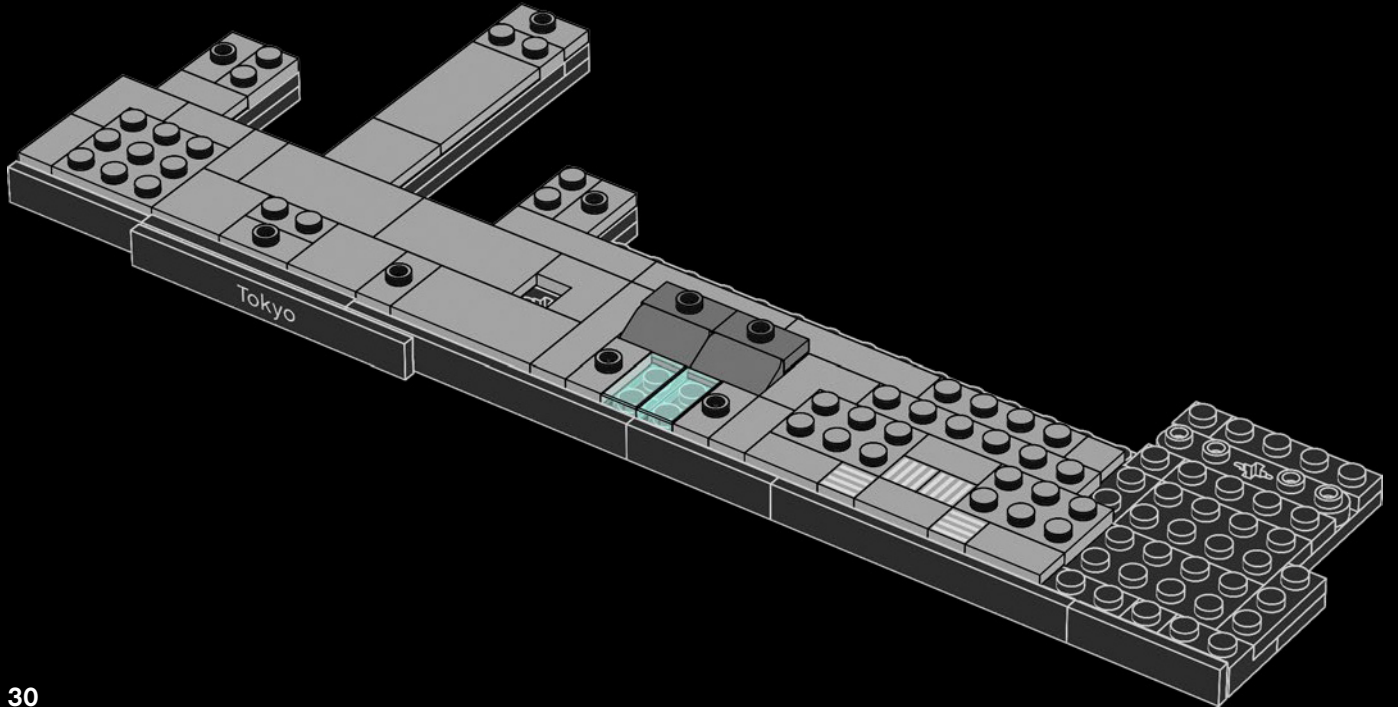

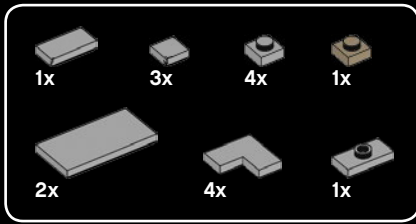

25

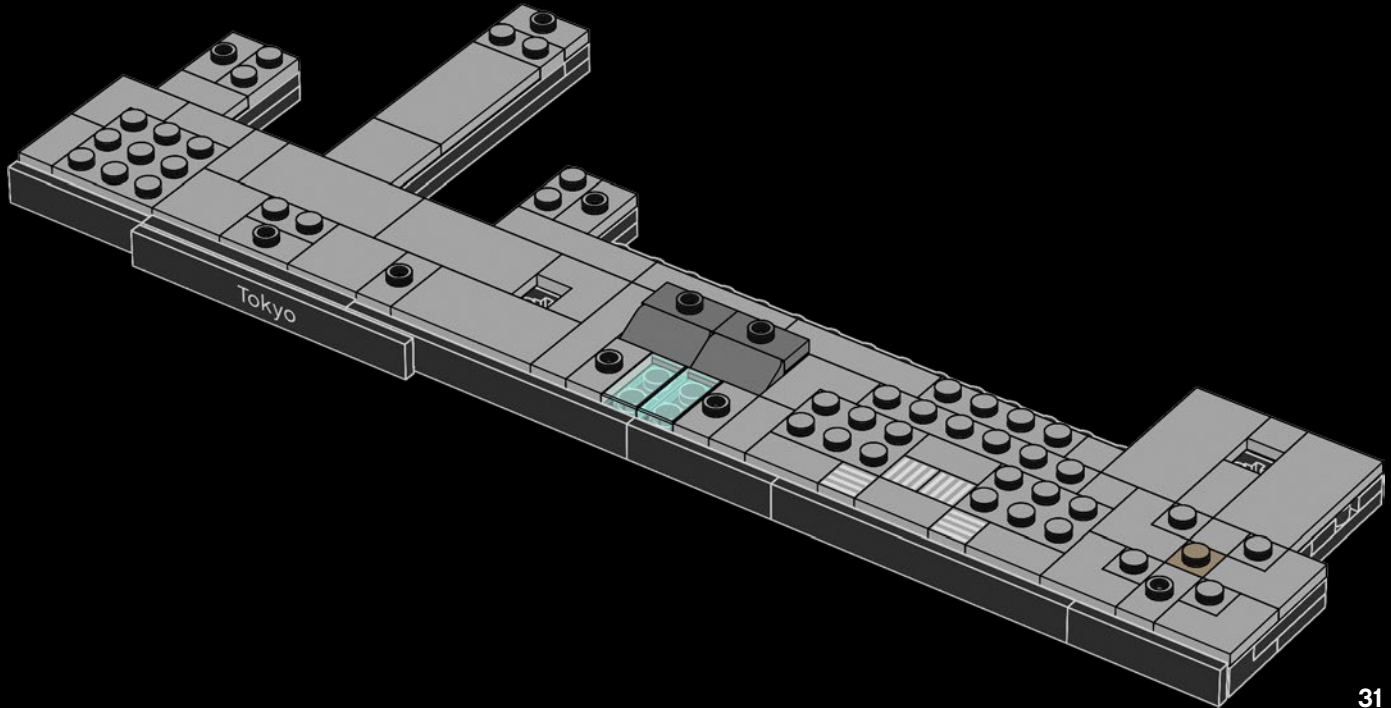

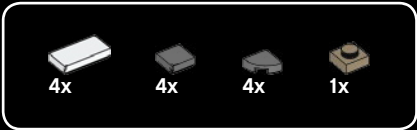

26

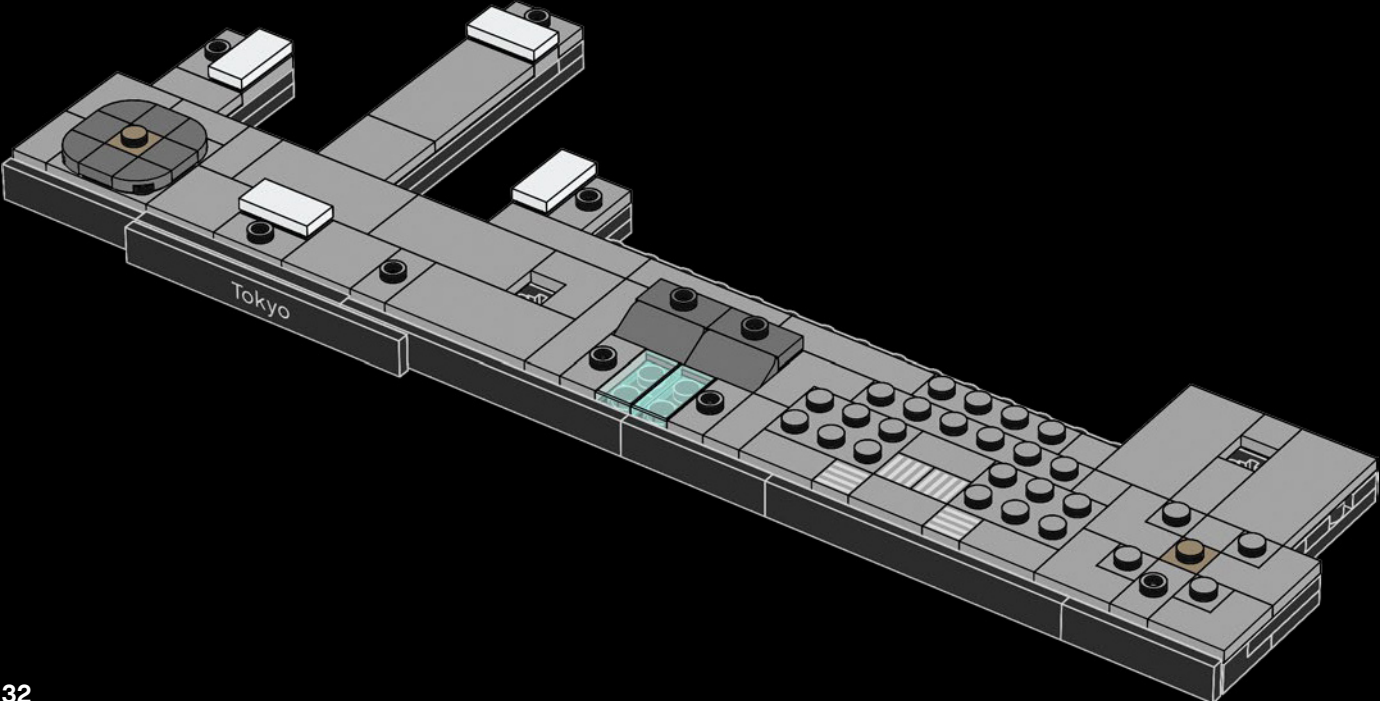

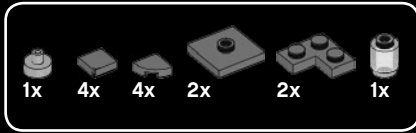

27

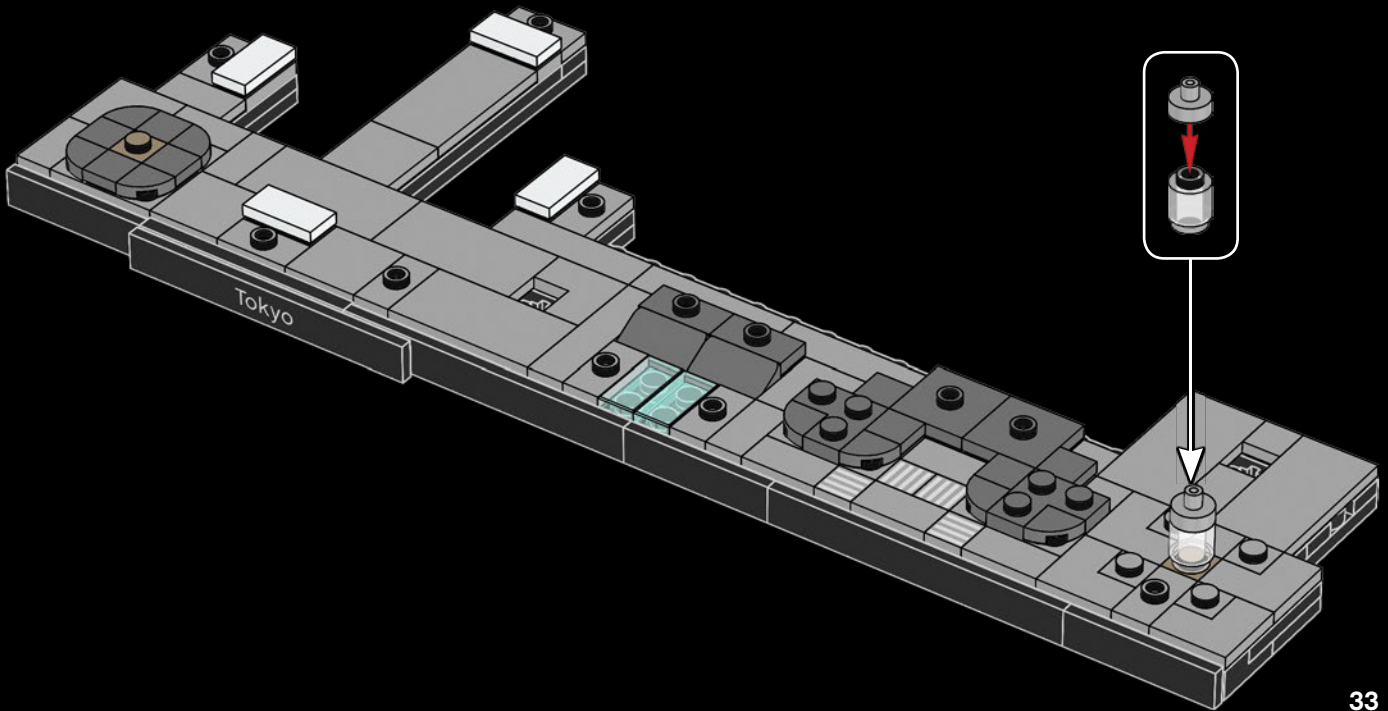

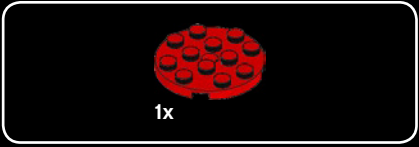
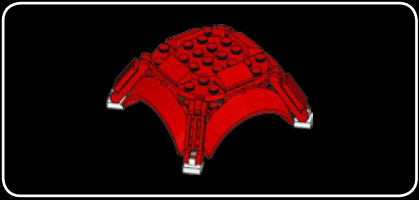

1x

28



2x

29

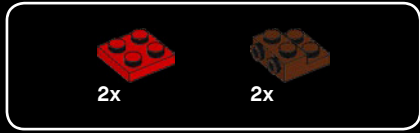
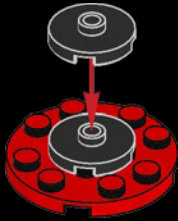

2x

2x

30

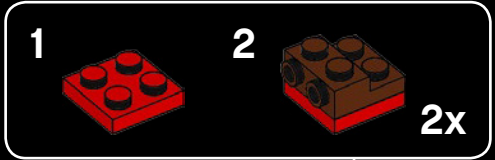

1

2

2x

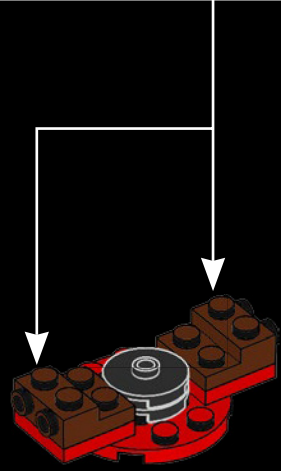

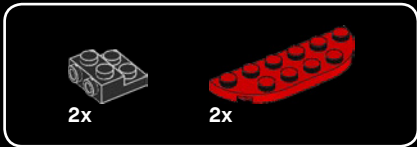

31

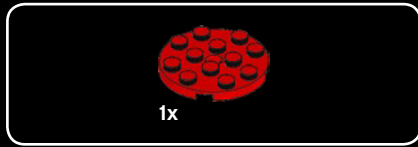
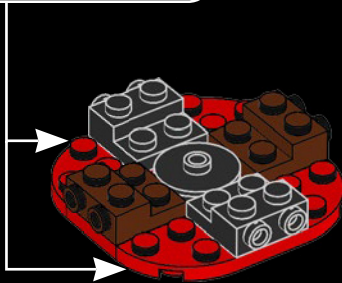
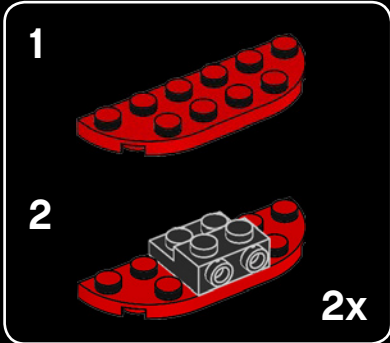

32

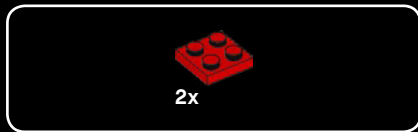

33

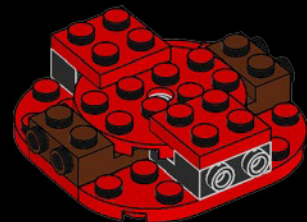

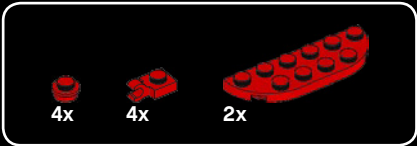

34

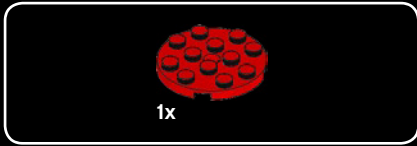
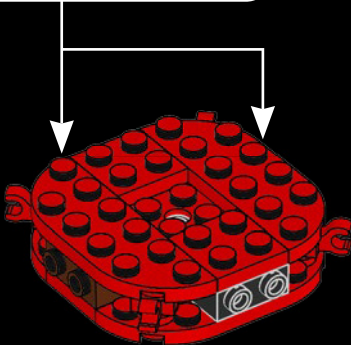
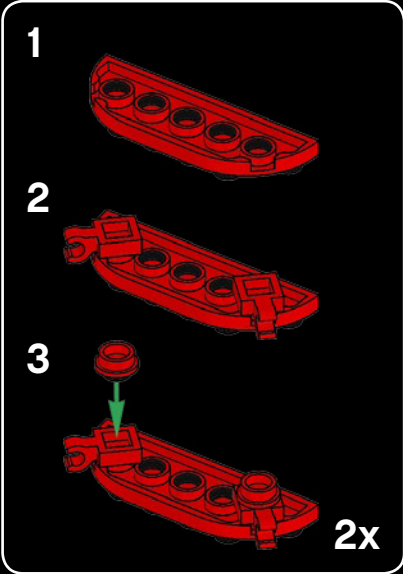

35

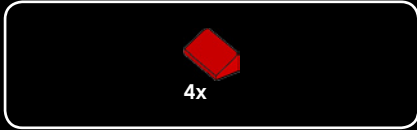
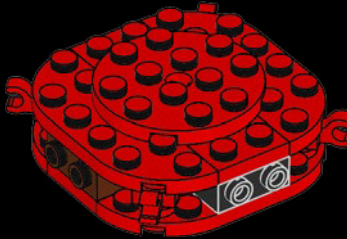

36

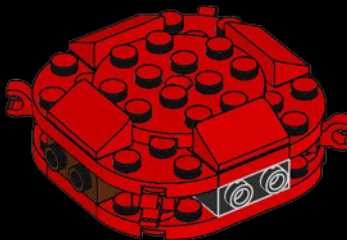

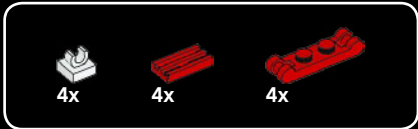

37

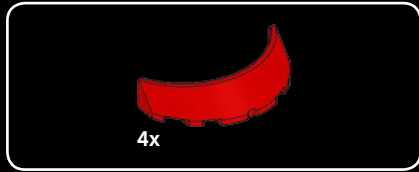
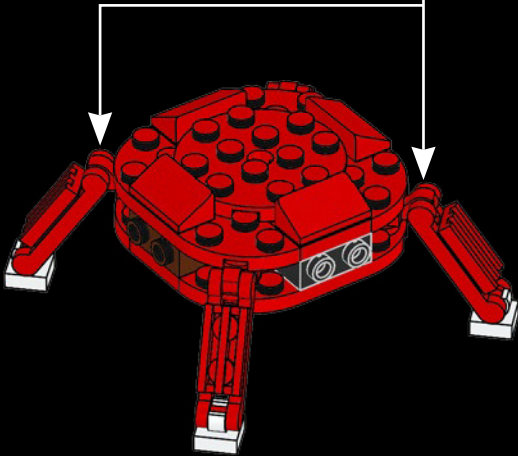
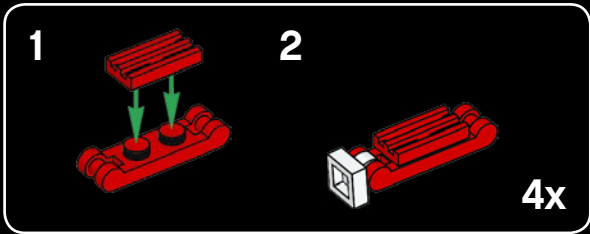

38

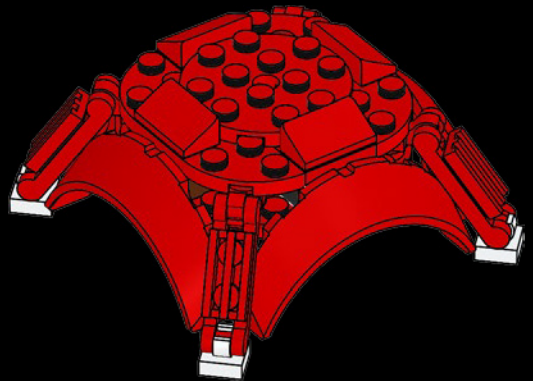

Tokyo Tower

The Tower has observation decks at 492 ft. (150m) and 820 ft. (250m).

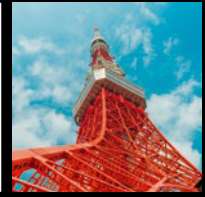

39

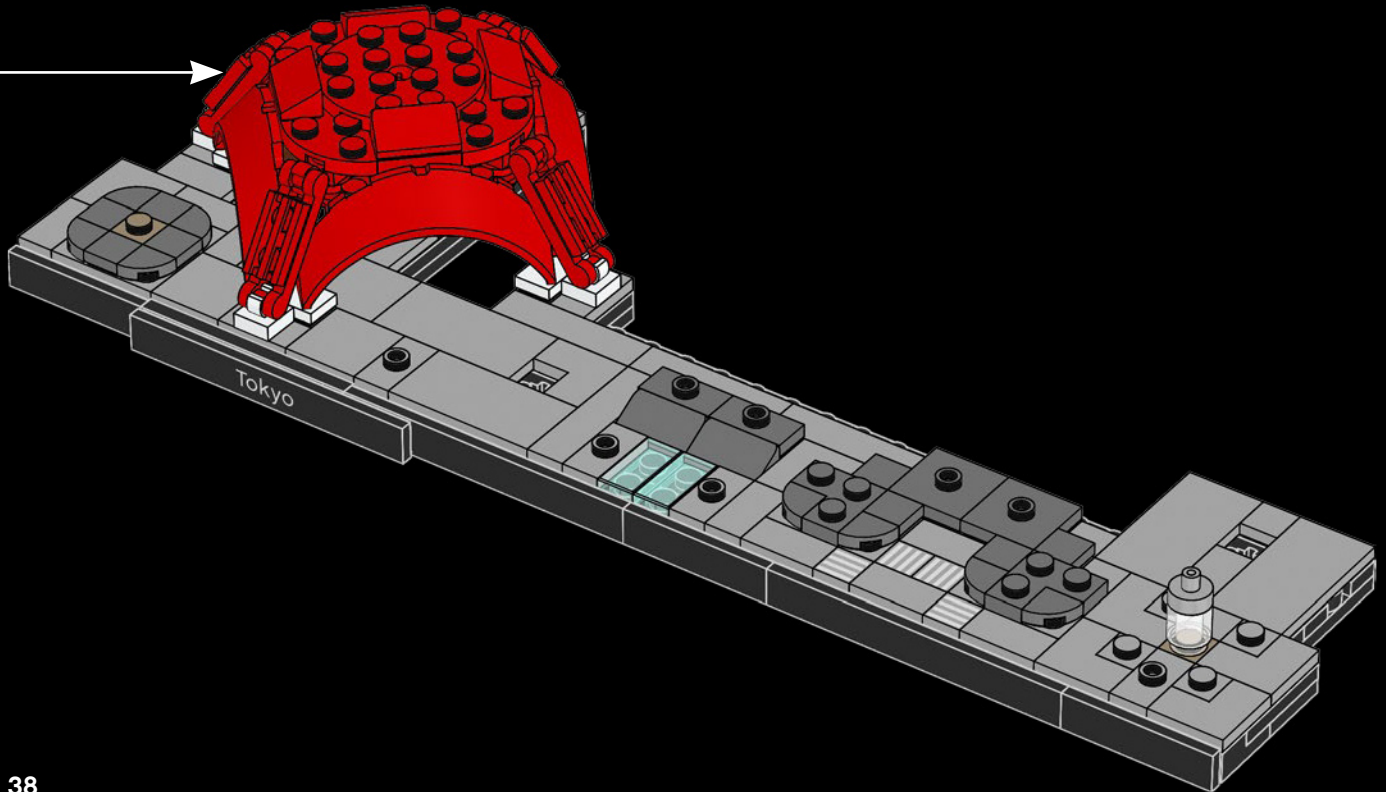

38

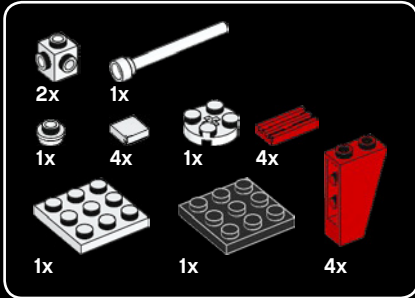

40

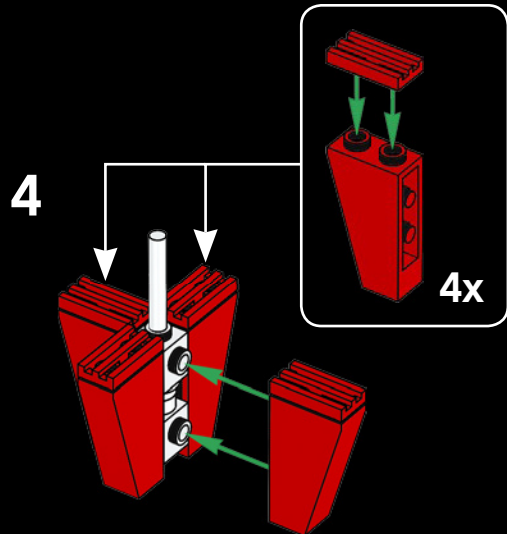
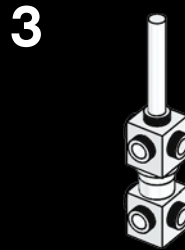
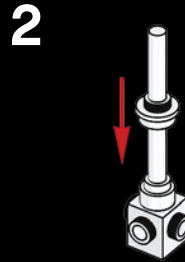
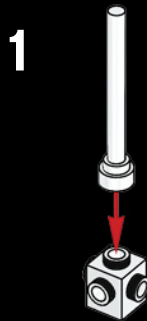

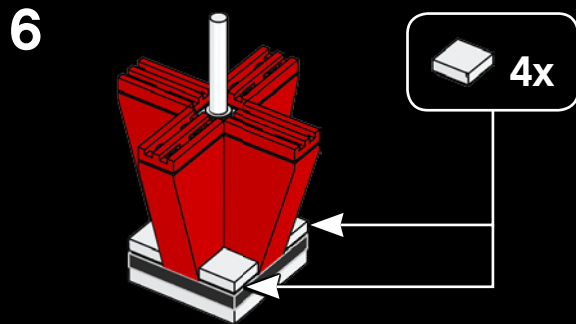
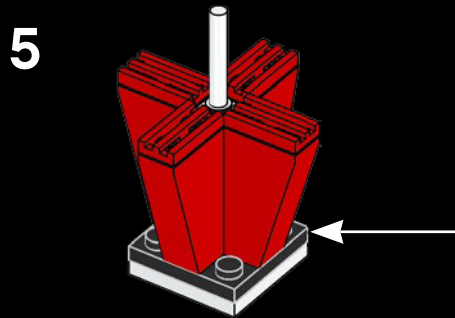
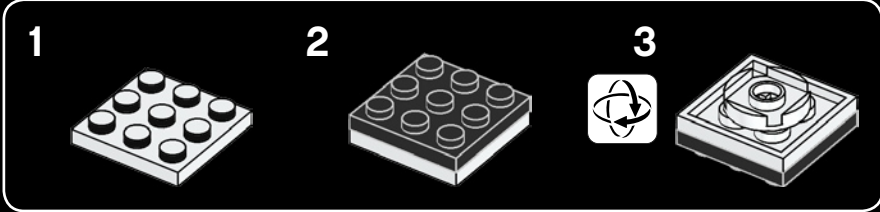

Tokyo Tower

The Tower can withstand windspeeds of up to 201 mph (90m/s).

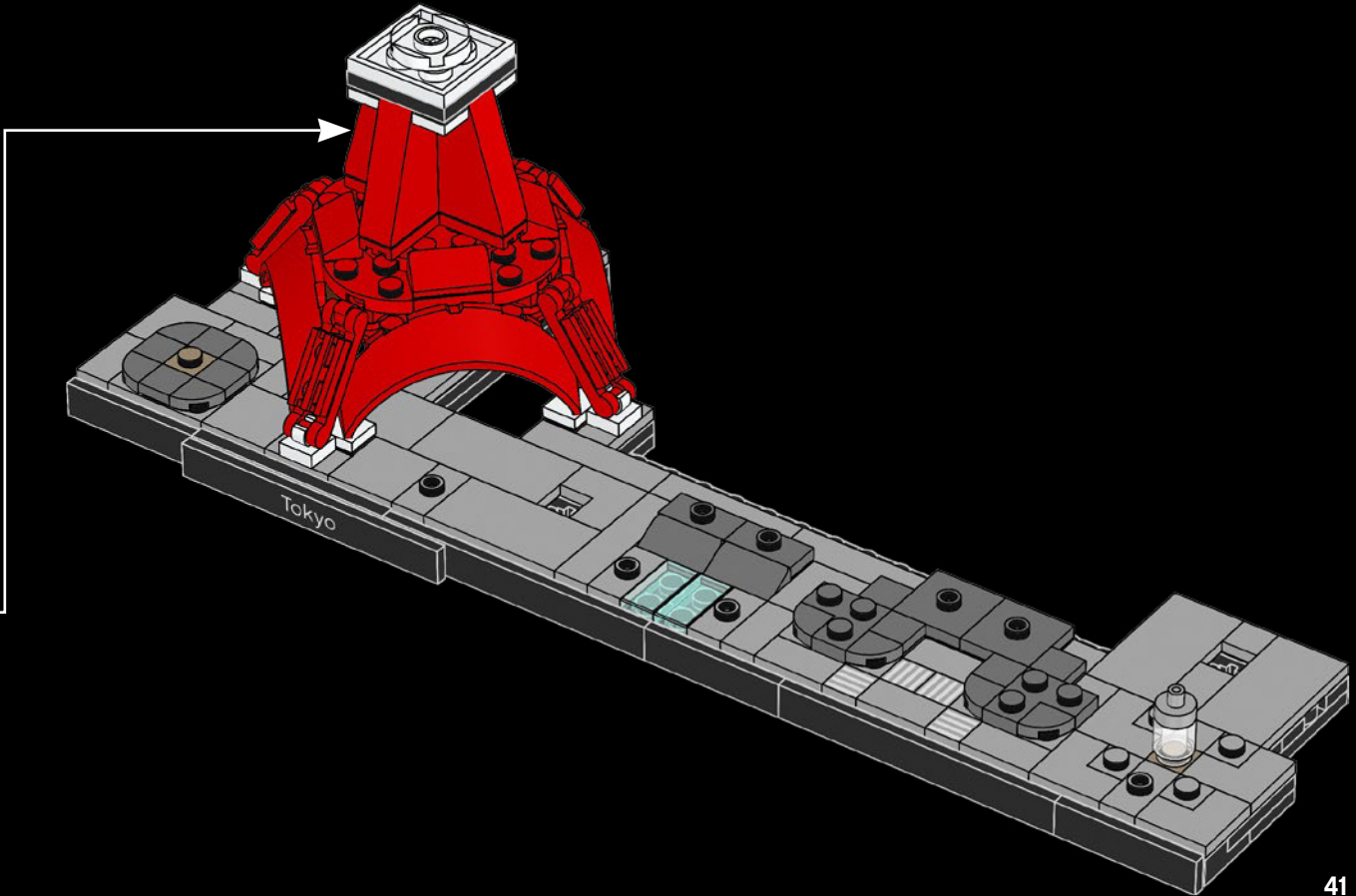

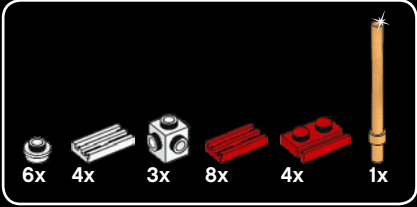
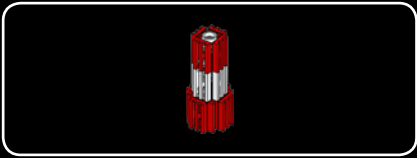

41

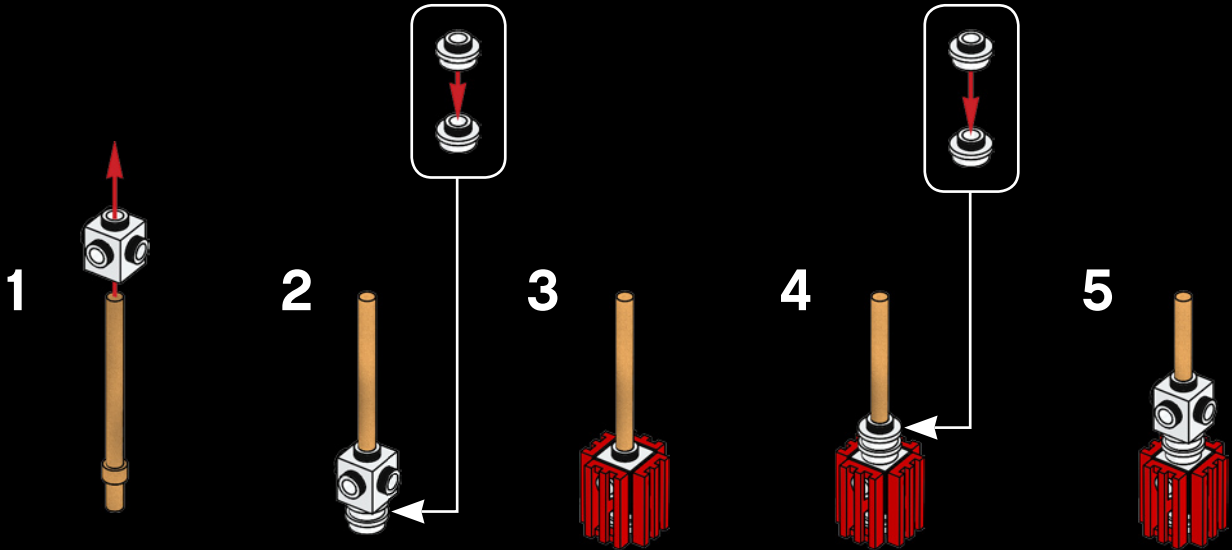

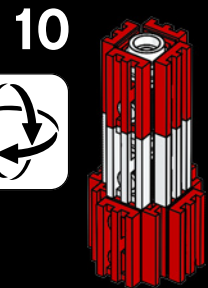
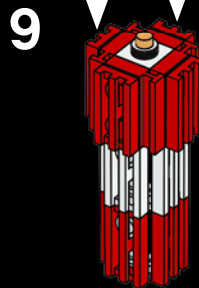
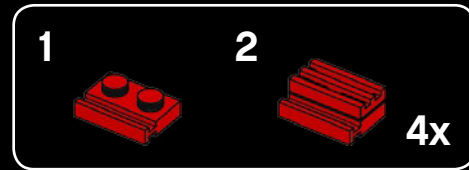
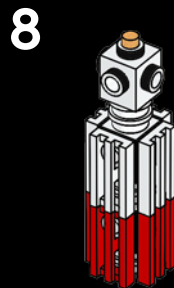
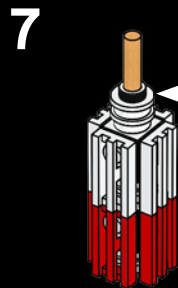
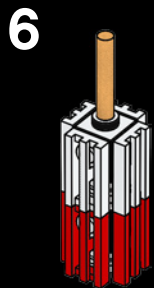

Tokyo Tower

Over 450 lamps light up the Tower in the evening.

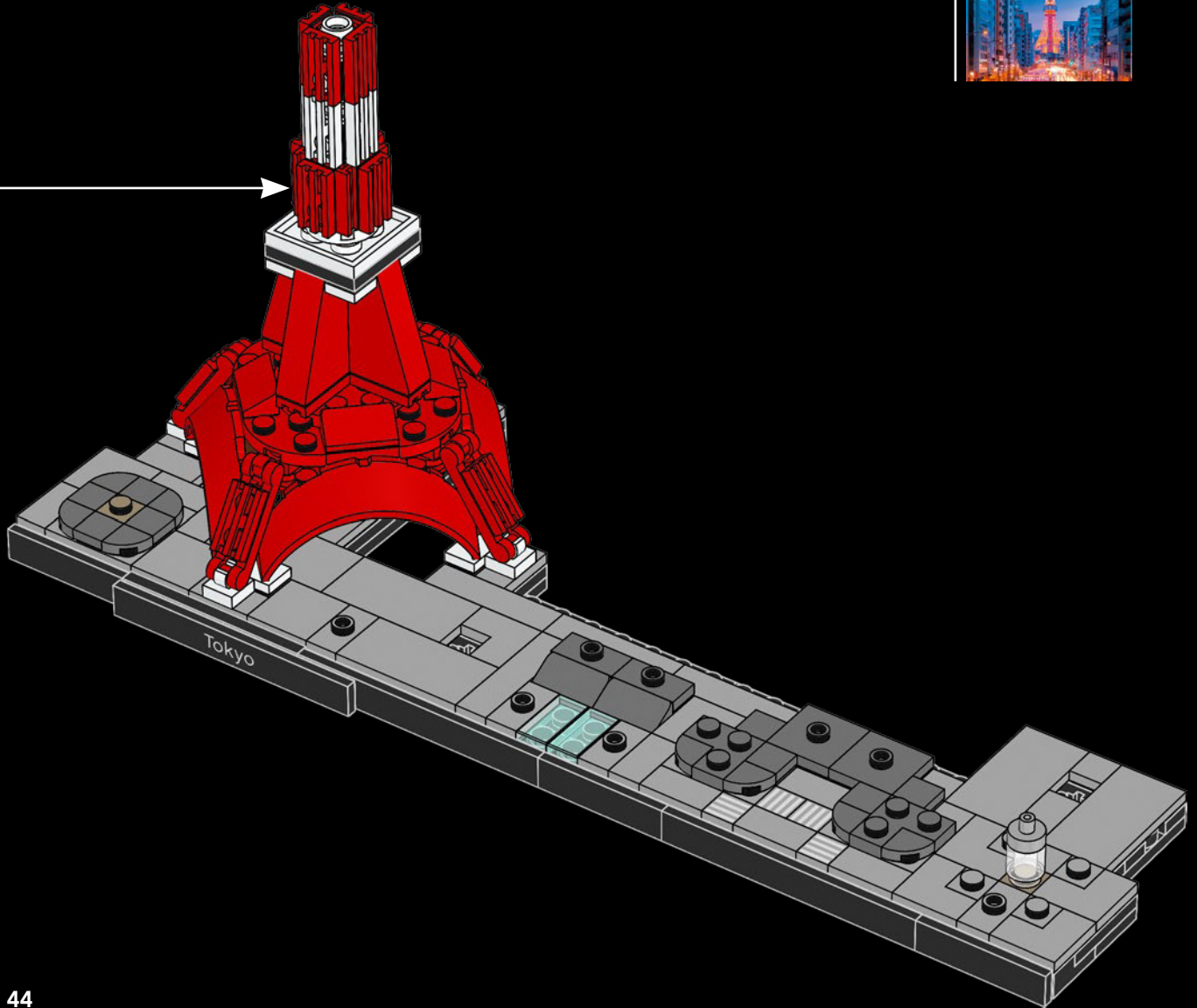

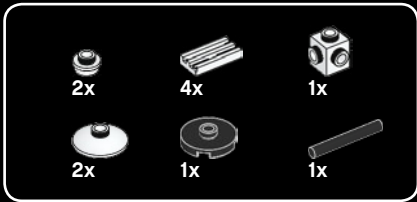

42

1



2



3

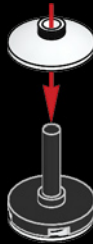

4

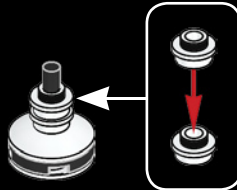

5



6



7



Tokyo Tower

It takes almost 8,982 gallons (34,000 litres) of paint to cover the Tower's surface.

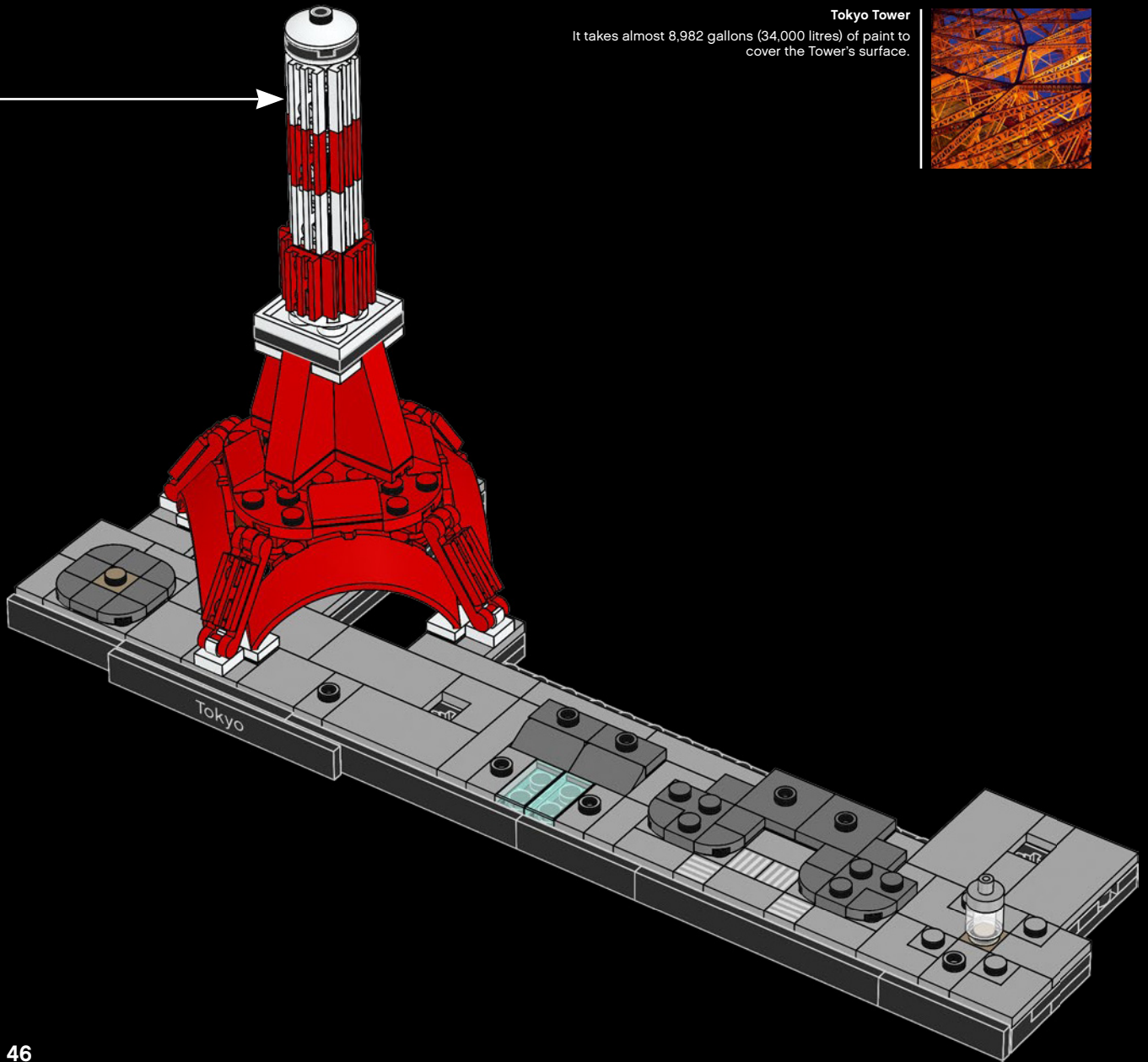
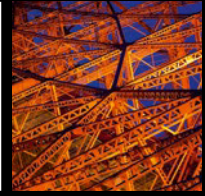



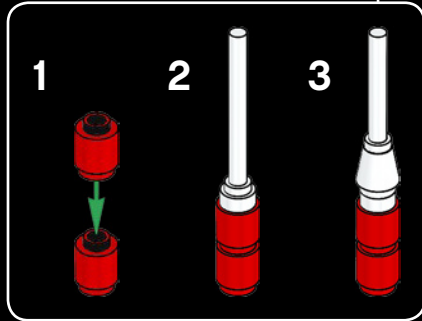
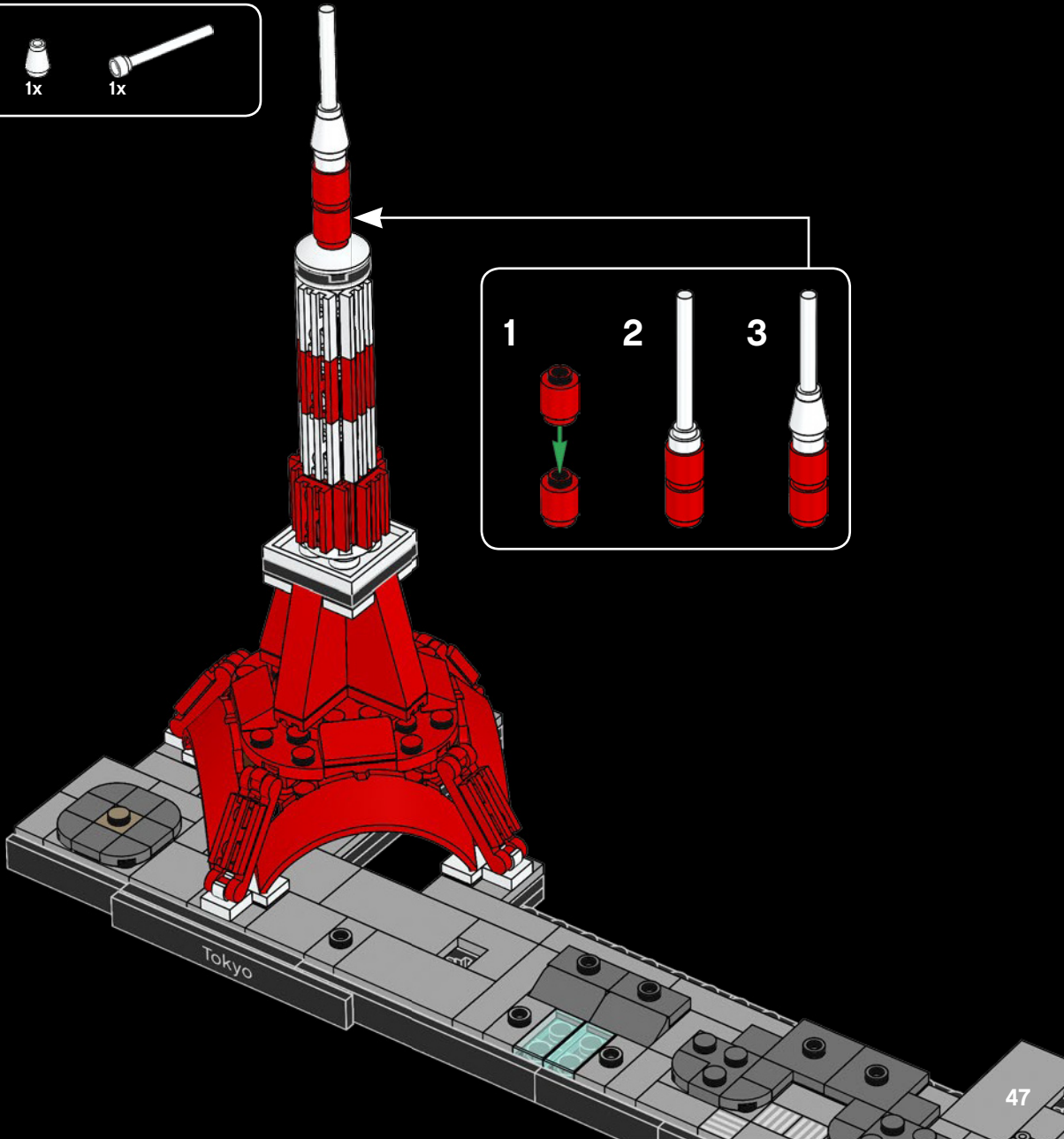

43

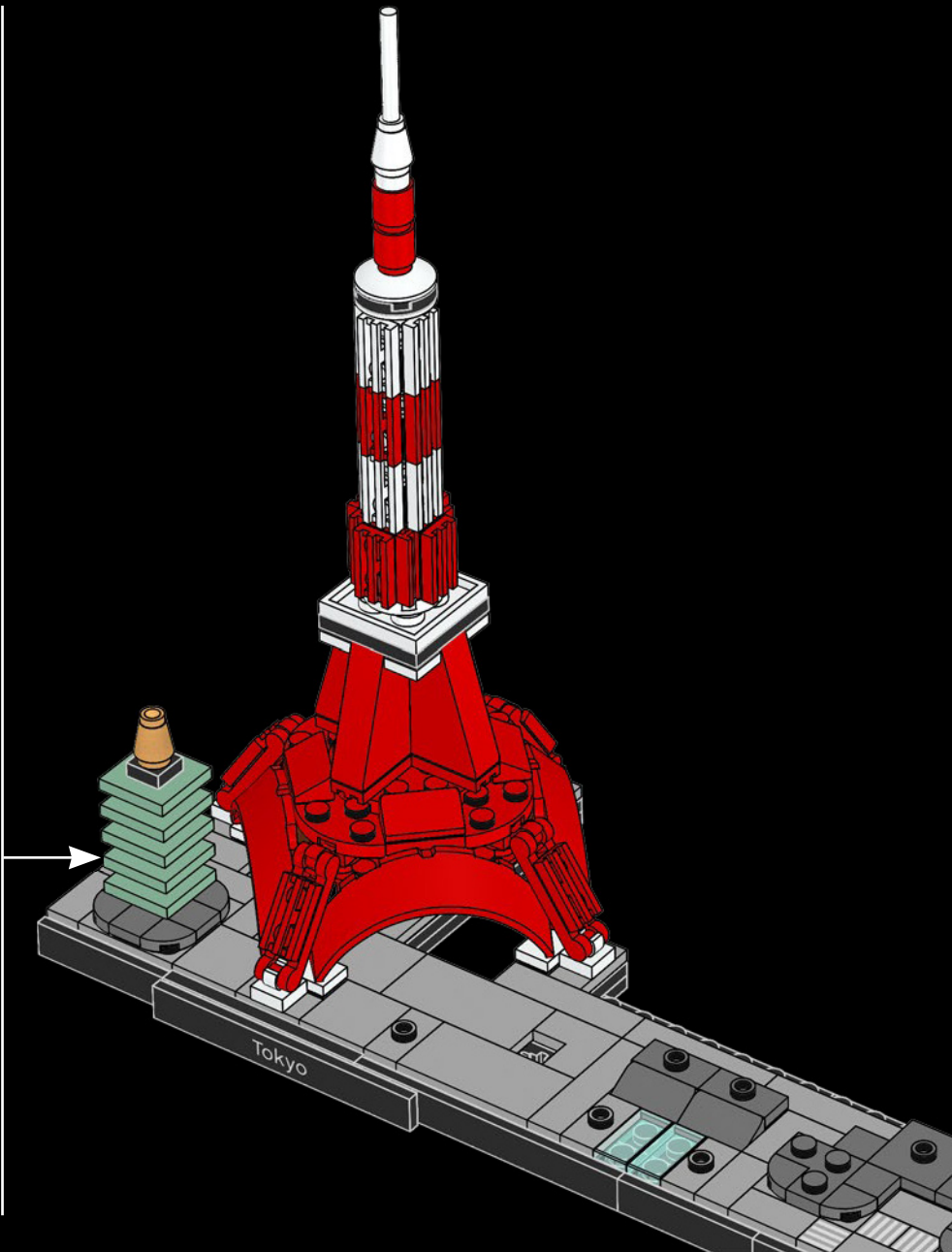
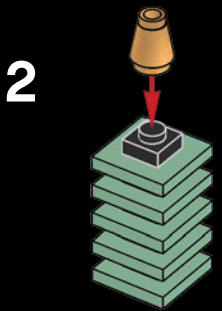
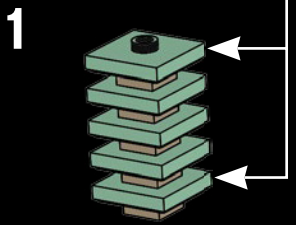
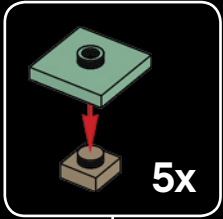

-  1x
-  5x
-  1x
-  5x

44





6x  1x 

45

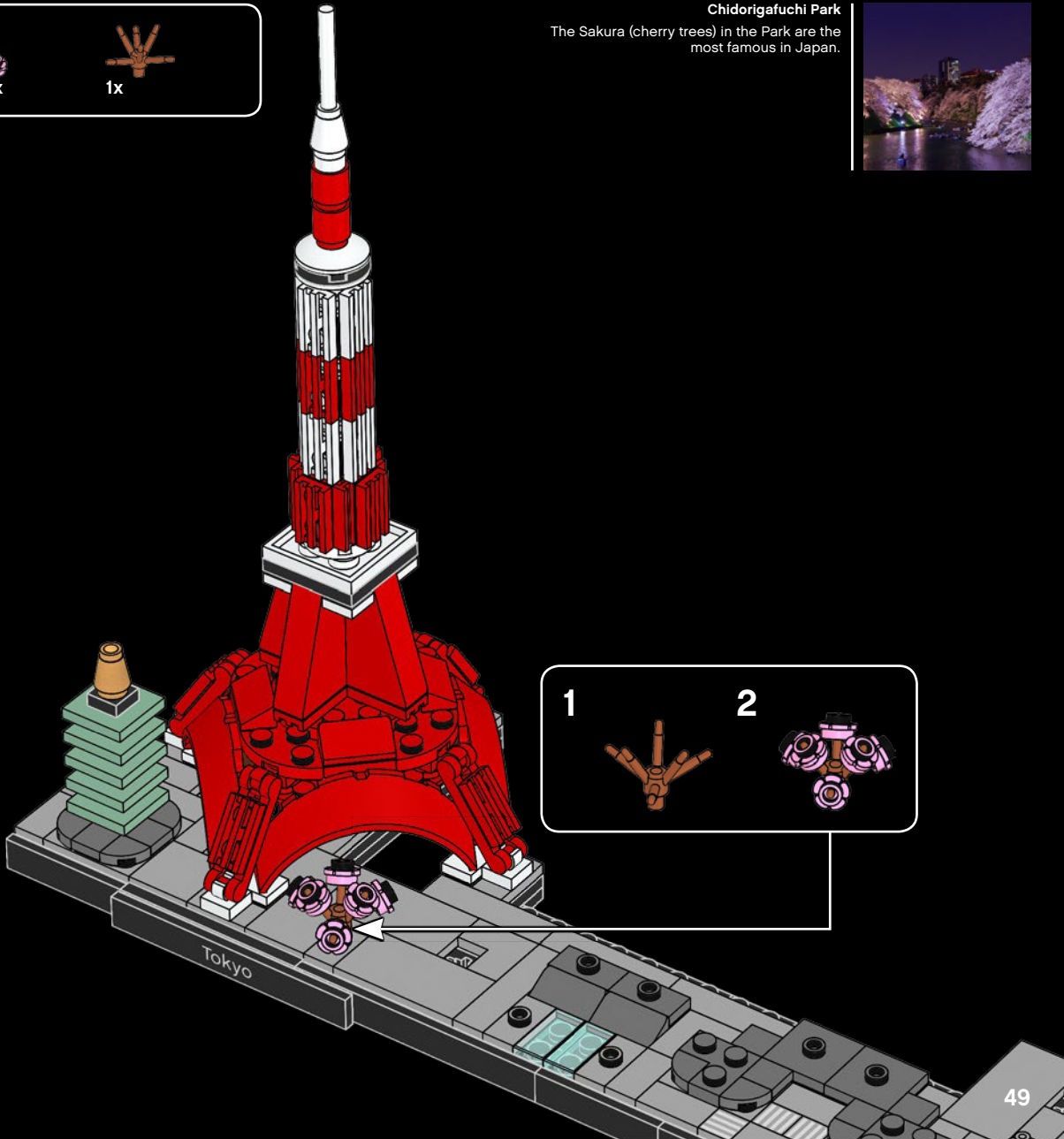
Chidorigafuchi Park
The Sakura (cherry trees) in the Park are the most famous in Japan.



1  2 

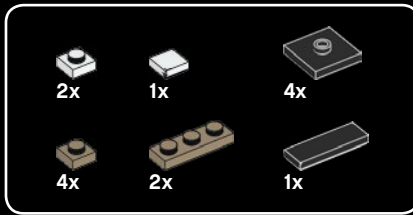
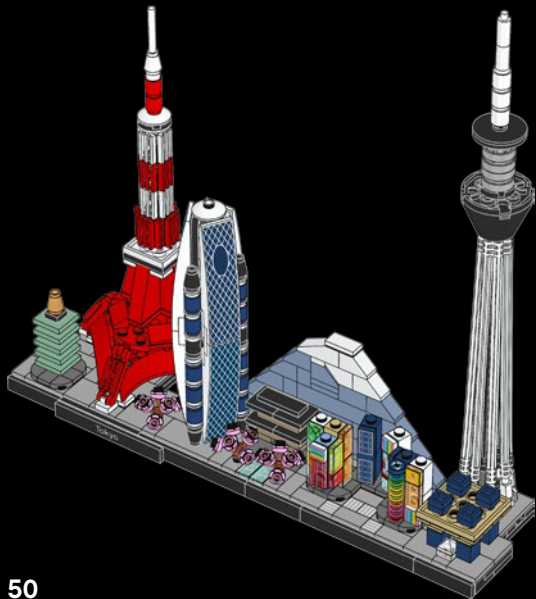
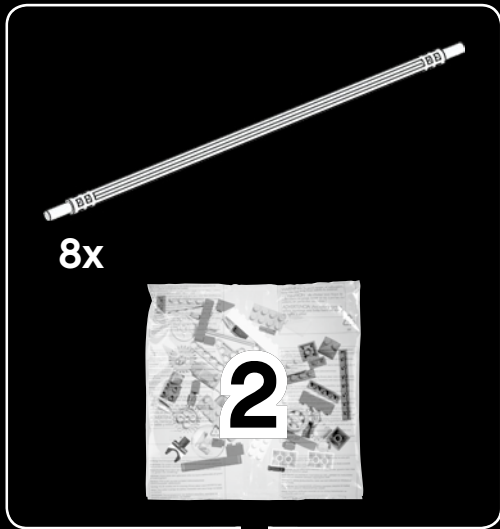

46

1



2

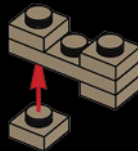

3

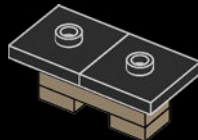

4

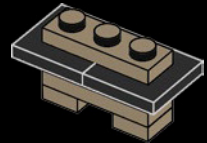

5

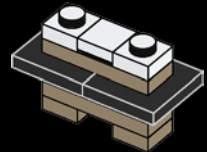

6

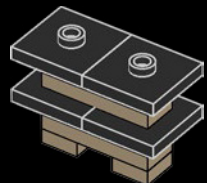

7

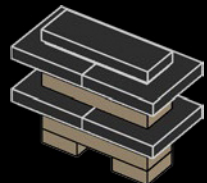

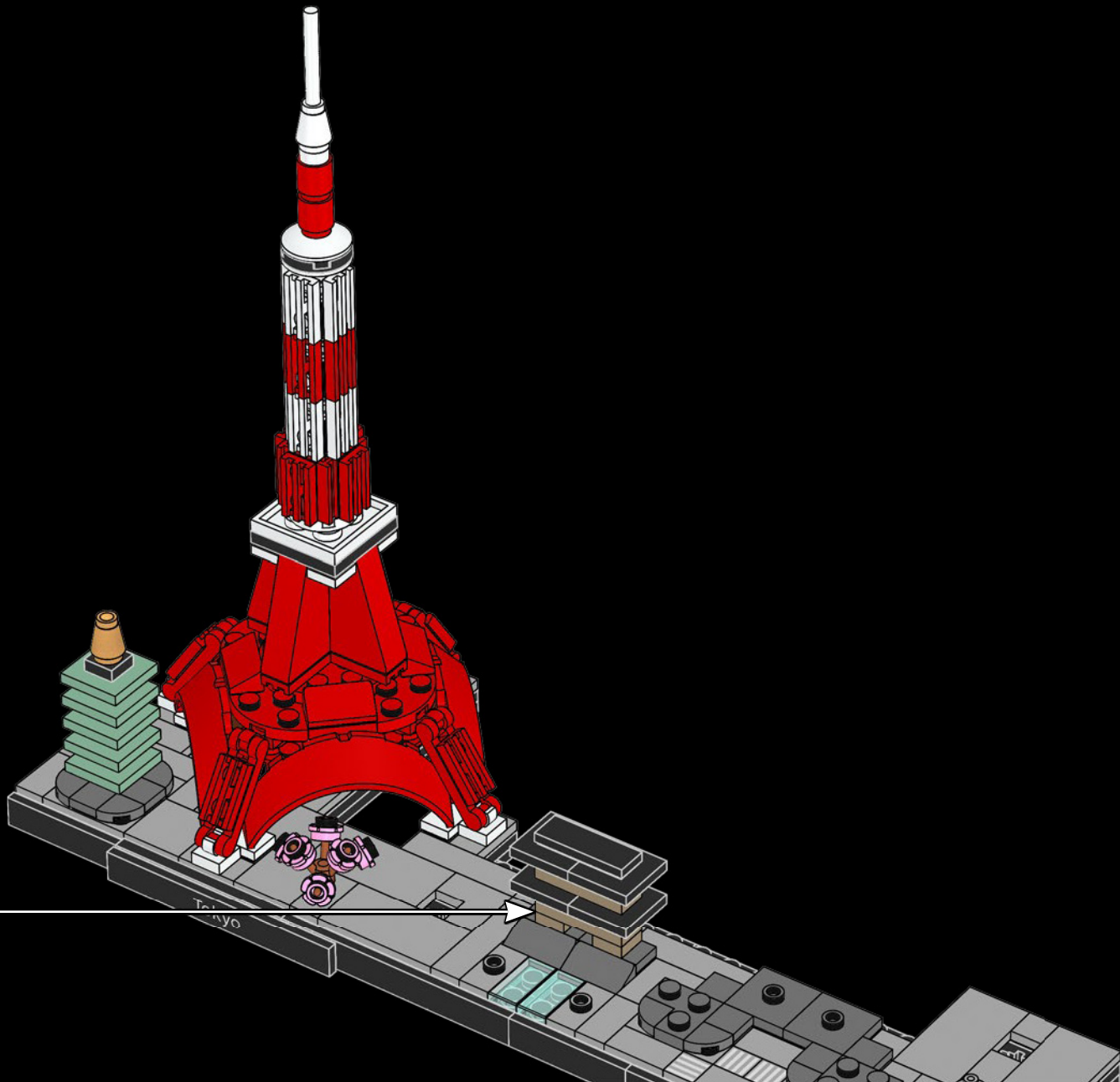

12x



2x

47

Chidorigafuchi Park

The flowering season occurs between late March and early May.

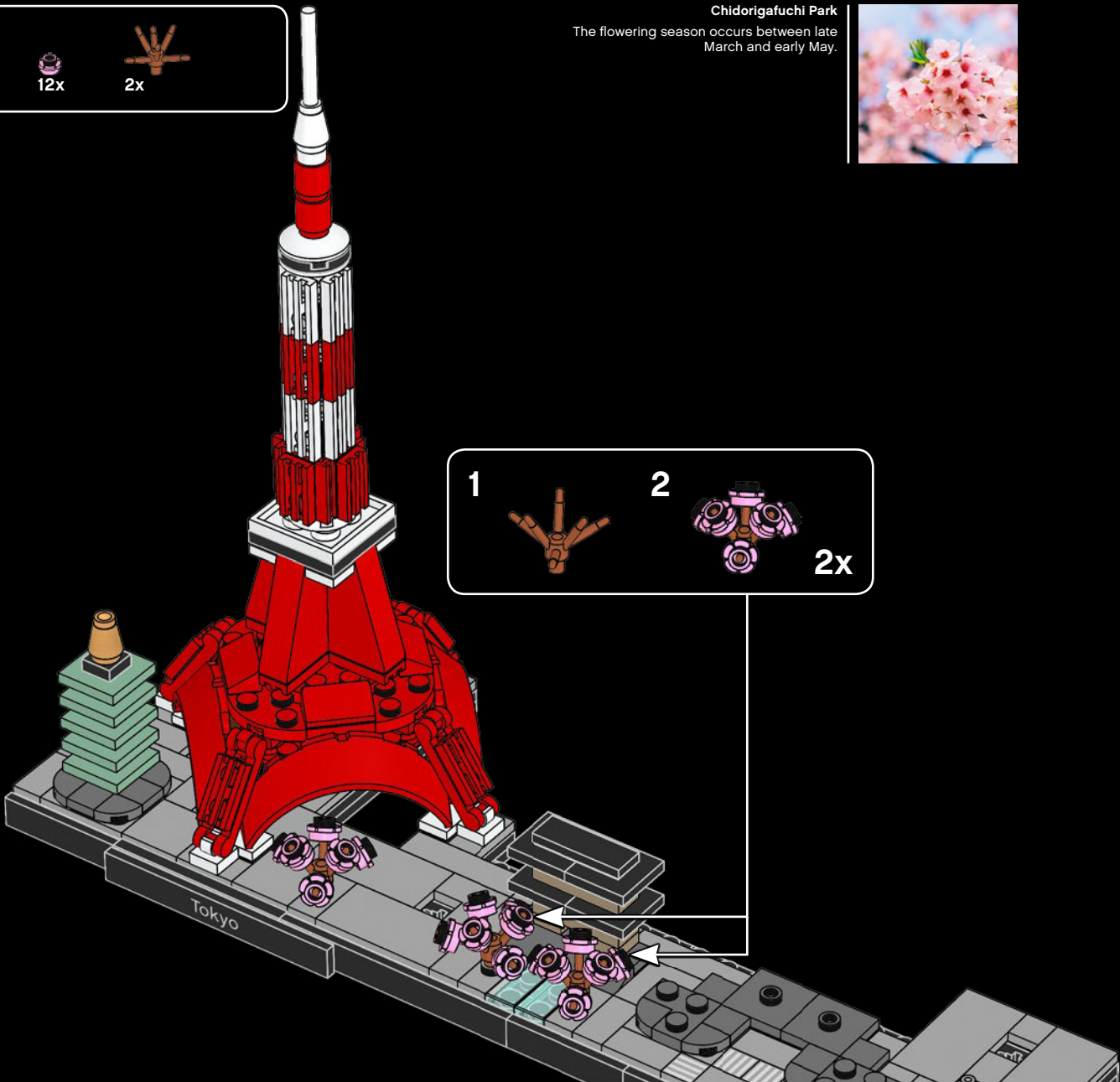

1



2



2x

- 1x
- 2x
- 2x
- 4x
- 1x
- 2x
- 1x
- 2x

48

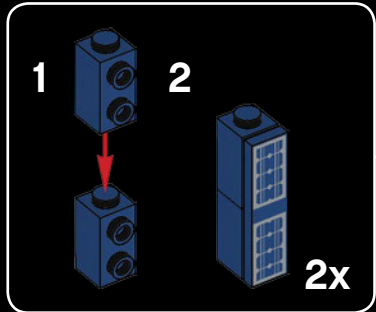
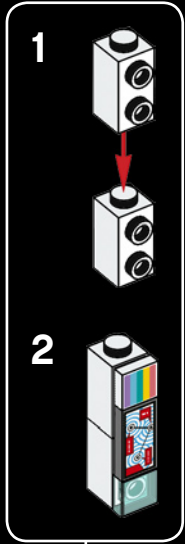
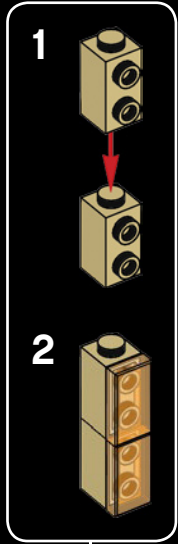
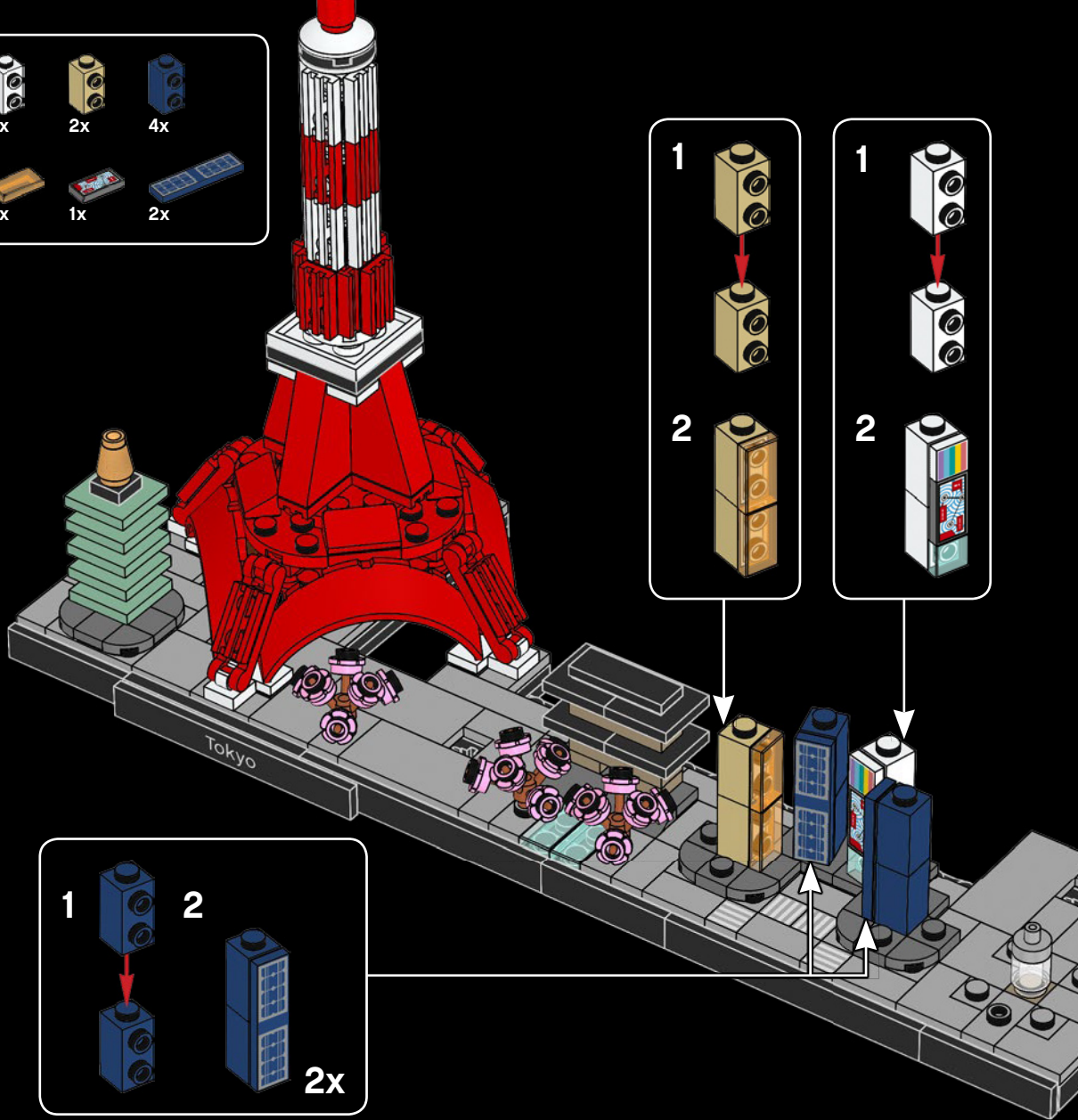

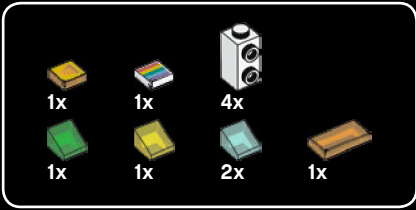

49

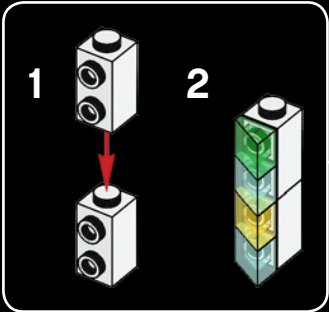
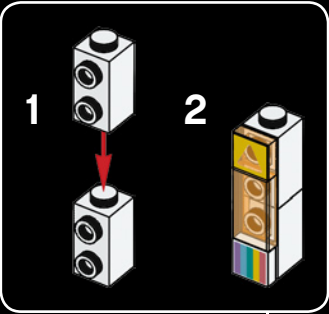
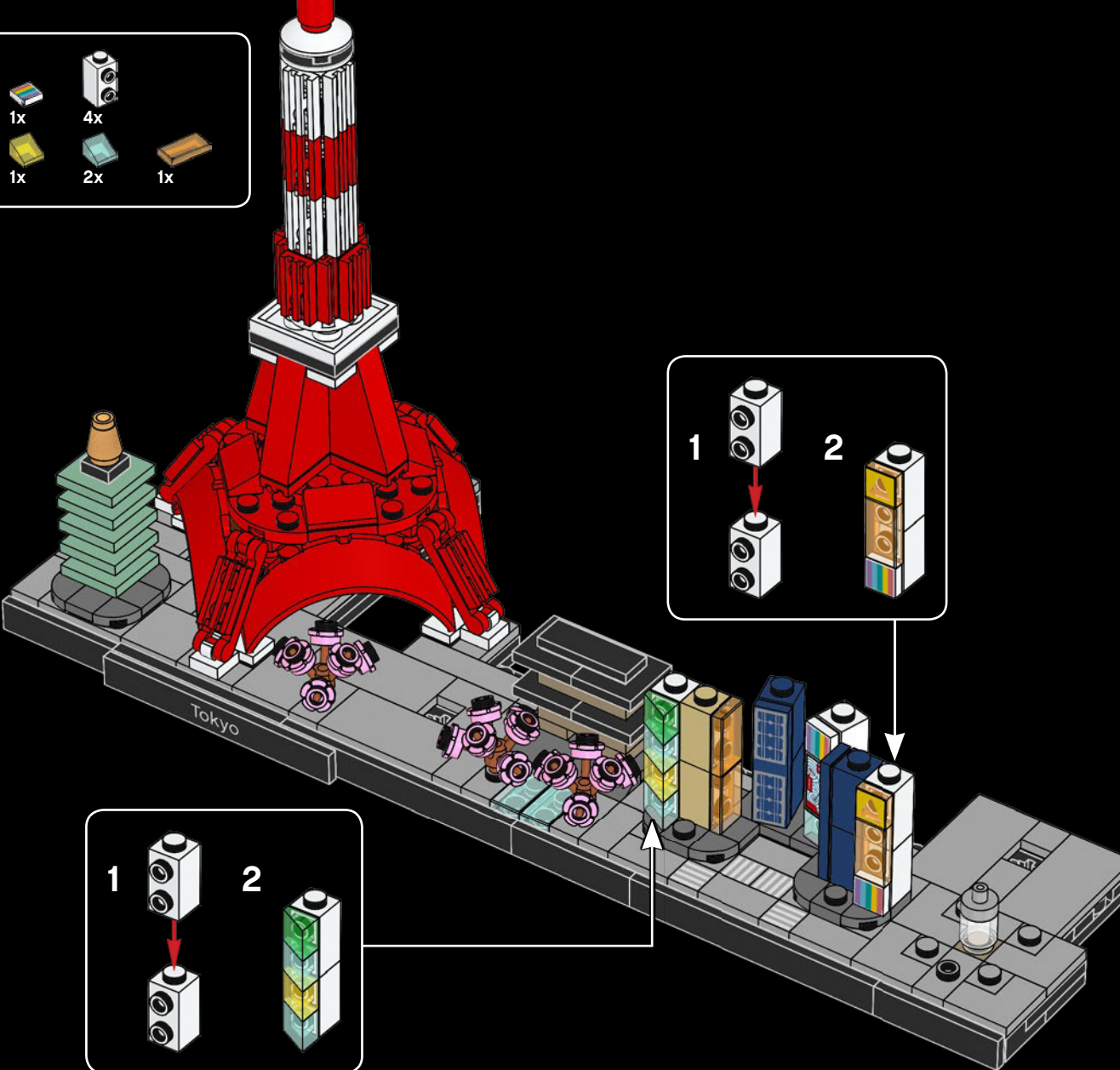

- | | | | | |
|----|----|----|----|----|
| | | | | |
| 2x | 1x | 1x | 1x | 1x |
| | | | | |
| 1x | 1x | 1x | 1x | 1x |
| | | | | |
| 1x | 2x | 1x | 2x | 2x |

Shibuya Crossing
 The Crossing is located in front of the busy
 Shibuya railway station.

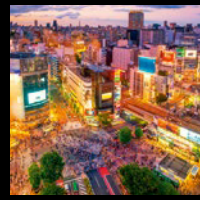

50

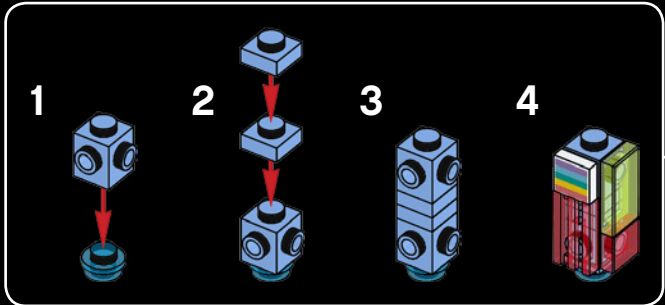
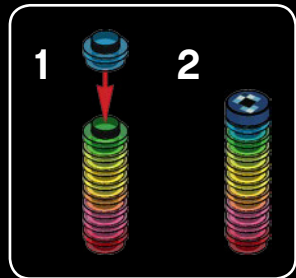
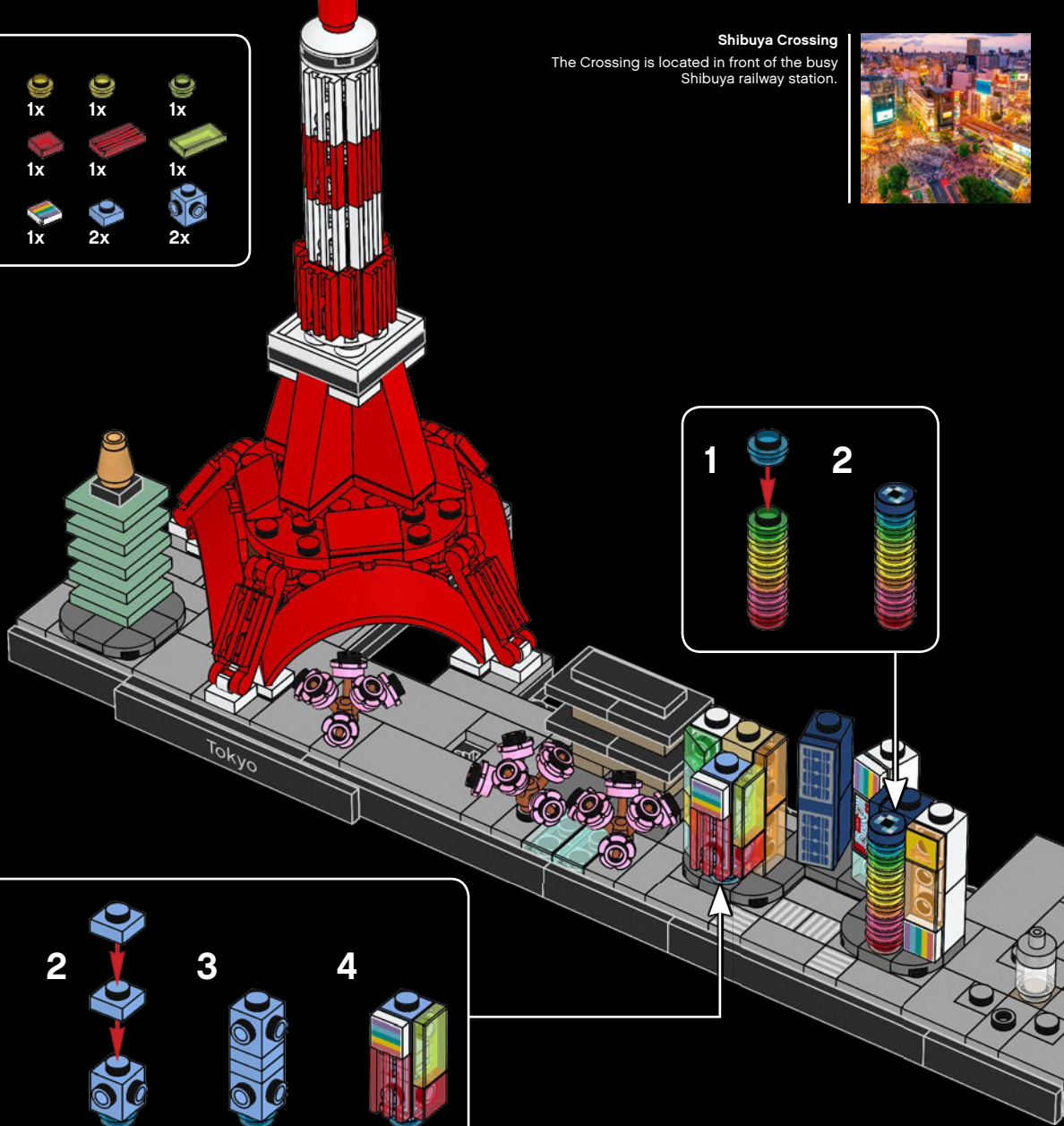



4x 4x 1x 1x

51



4x

56

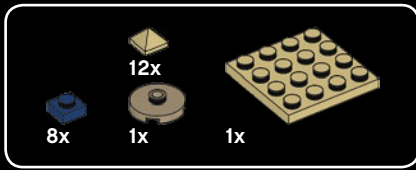

52

1



2

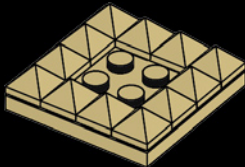

3

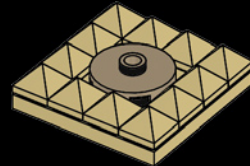

4

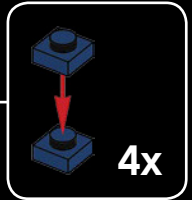
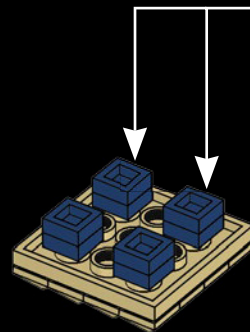

4x

Tokyo Big Sight

Eight oversized art pieces have been placed at the base of the tower.



Tokyo Big Sight

The tower opened in 1996 and cost 198.5 billion yen to construct.

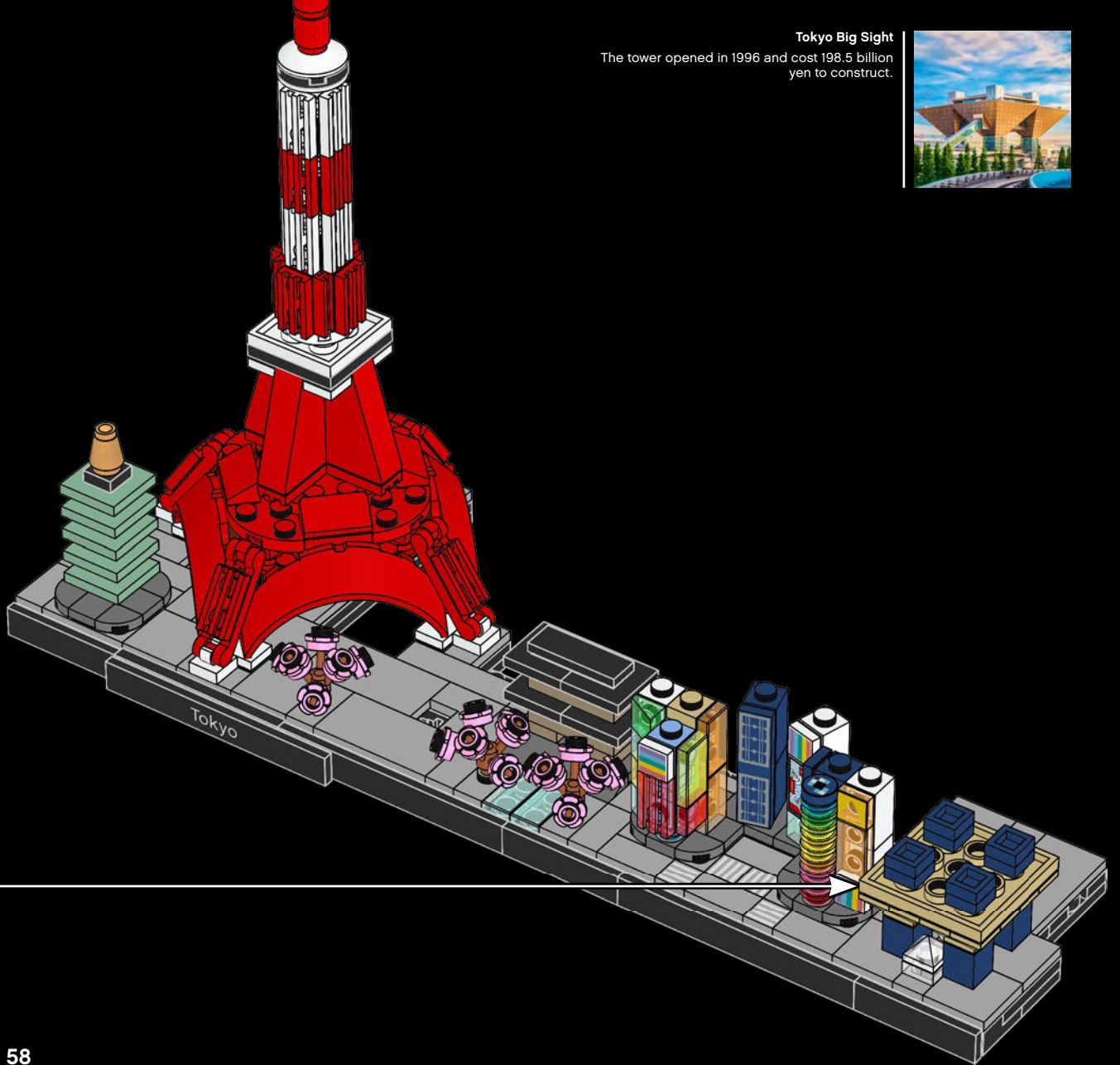

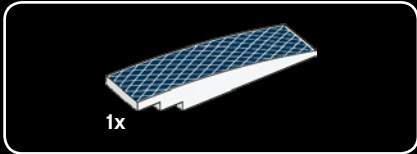

53

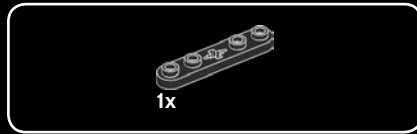
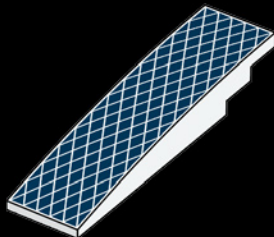

54



55

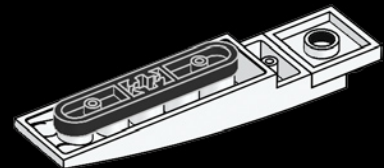



1x



1x

56

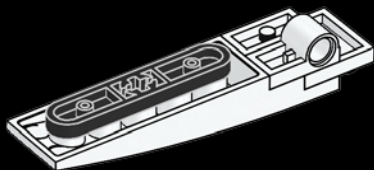

1x

57

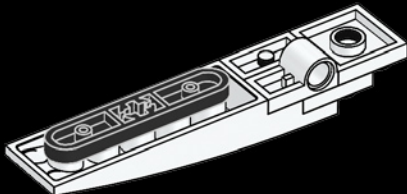

1x



1x

58

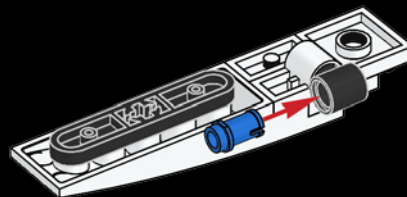

Mode Gakuen Cocoon Tower

The Tower has 50 floors above ground level and 3 below.



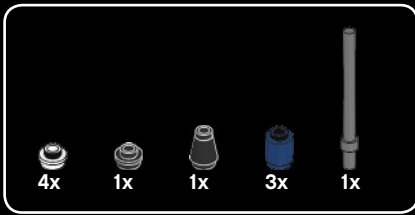

59

1



2



3



4

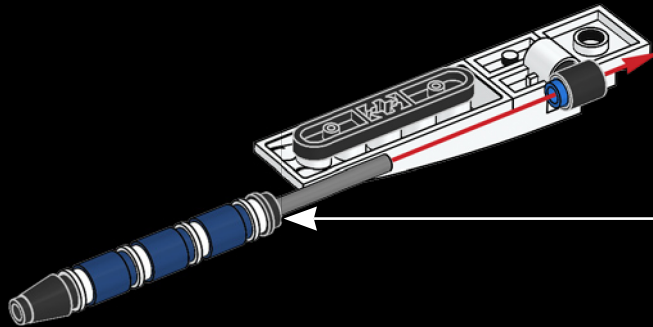

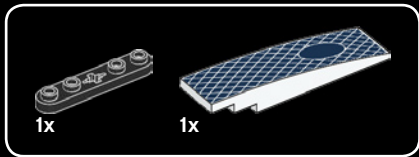

60

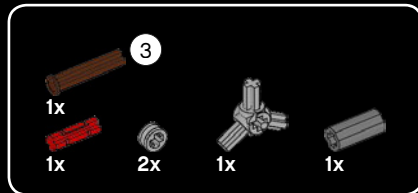
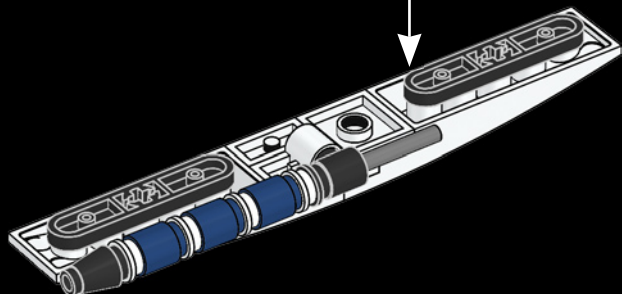
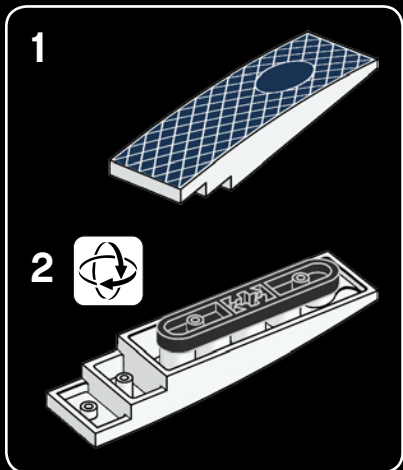

61

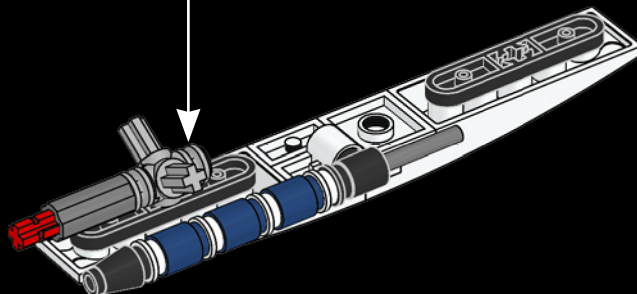
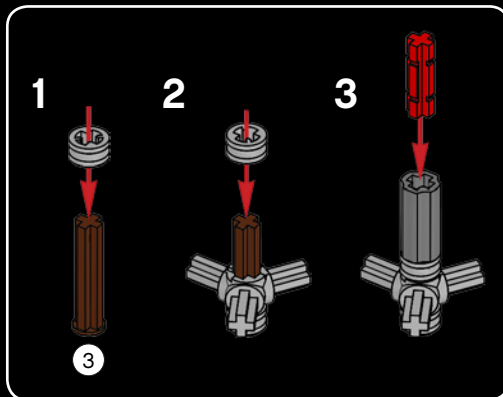

62

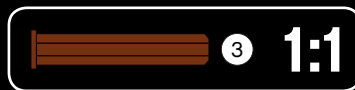



62

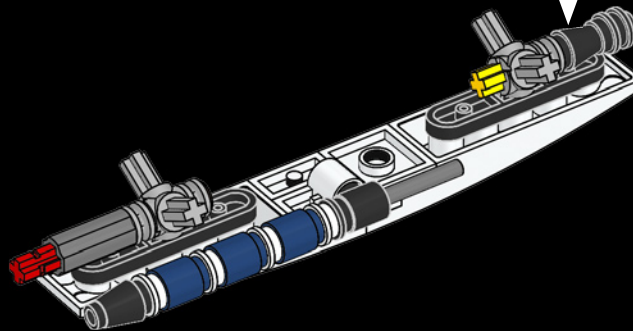
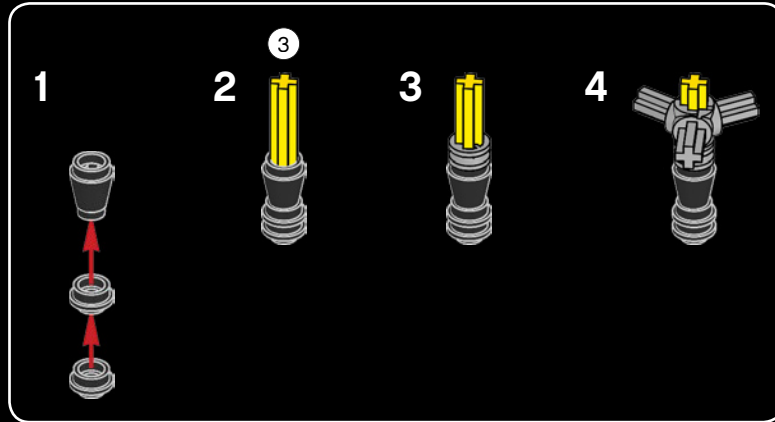

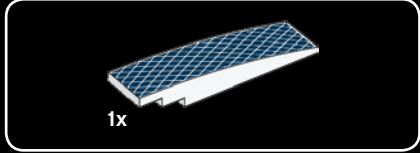
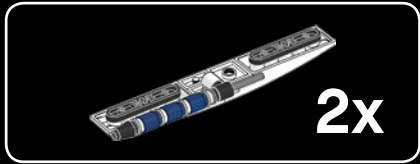

63

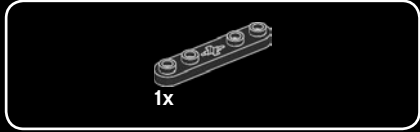
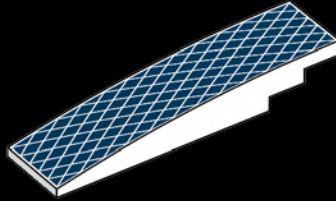

64



Mode Gakuen Cocoon Tower
The Tower is the second-highest educational building
in the world.



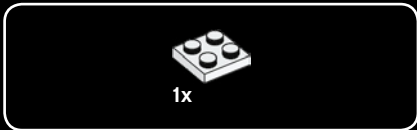

65

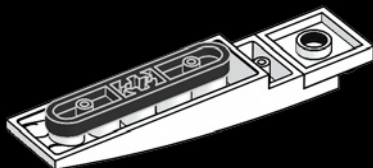

66

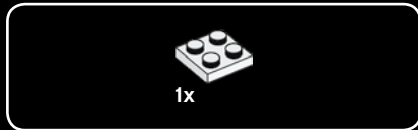
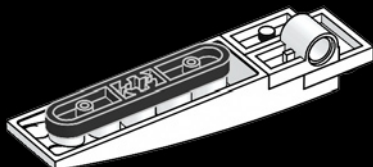

67

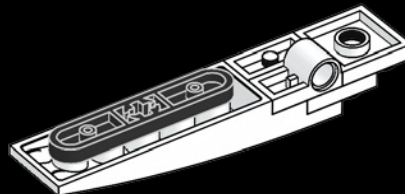

68

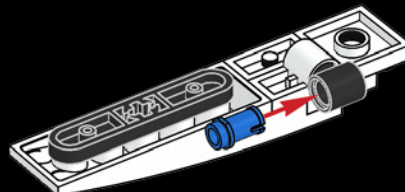

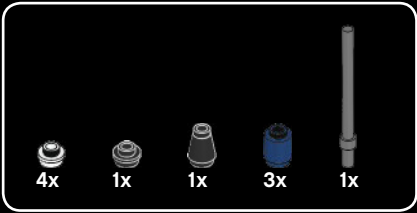

69

1



2



3

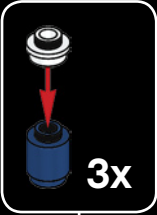

4



Mode Gakuen Cocoon Tower
 The Tower is home to colleges of design, technology and medicine.

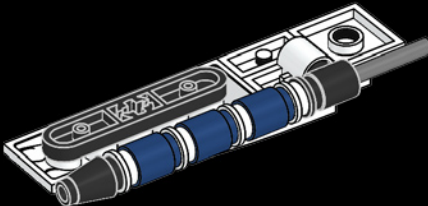

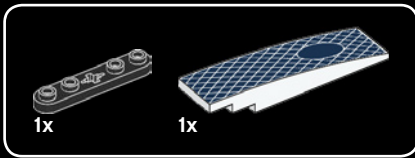

70

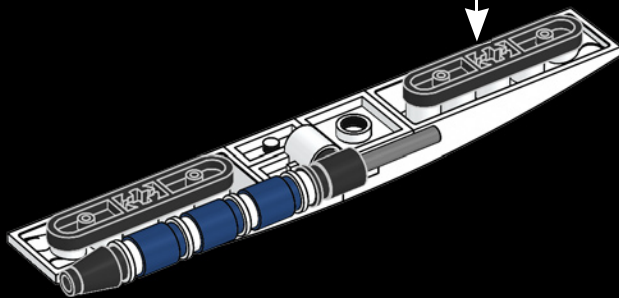
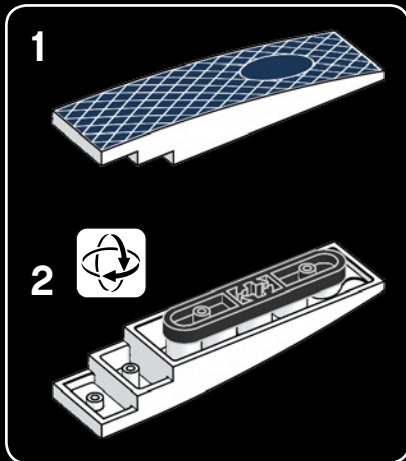

71

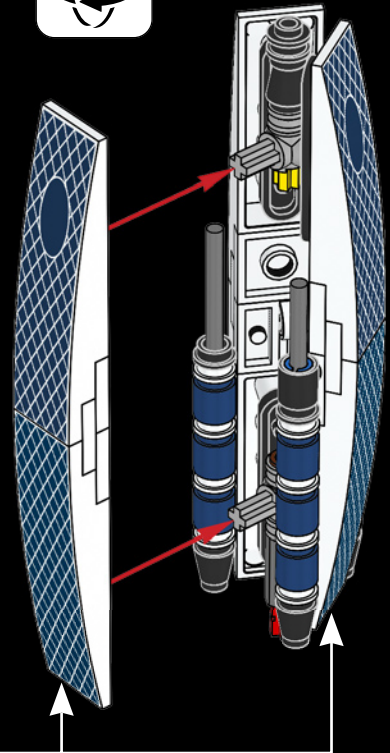



1x

72

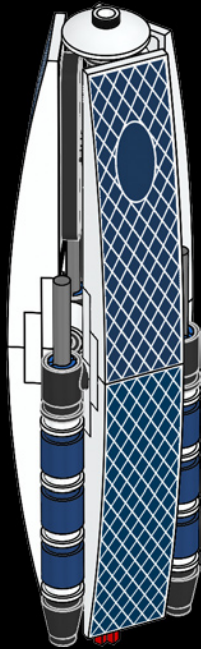

73

Mode Gakuen Cocoon Tower

The design was selected from more than 150 proposals.

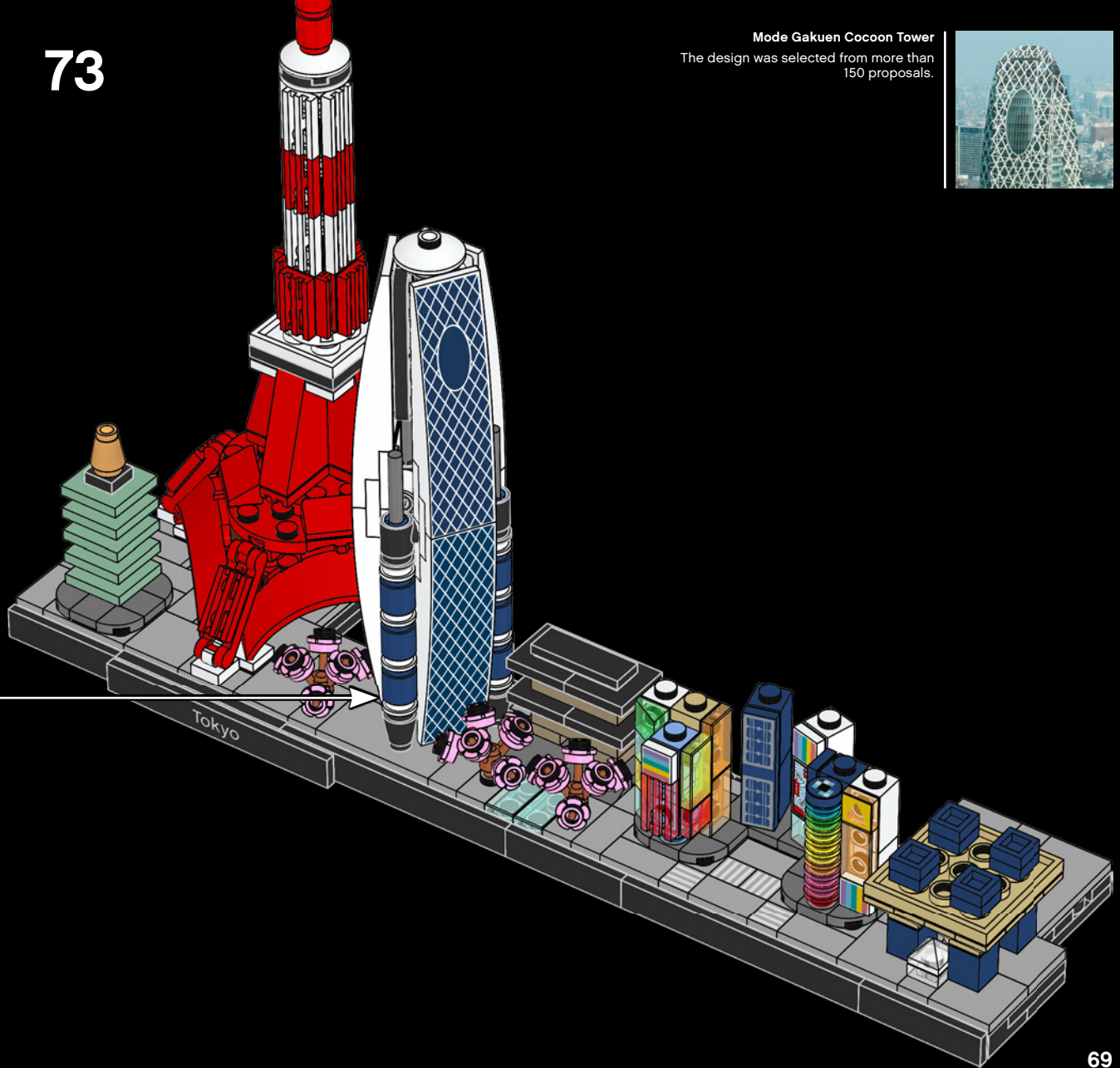

- 9x 
- 6x 
- 3x 

74

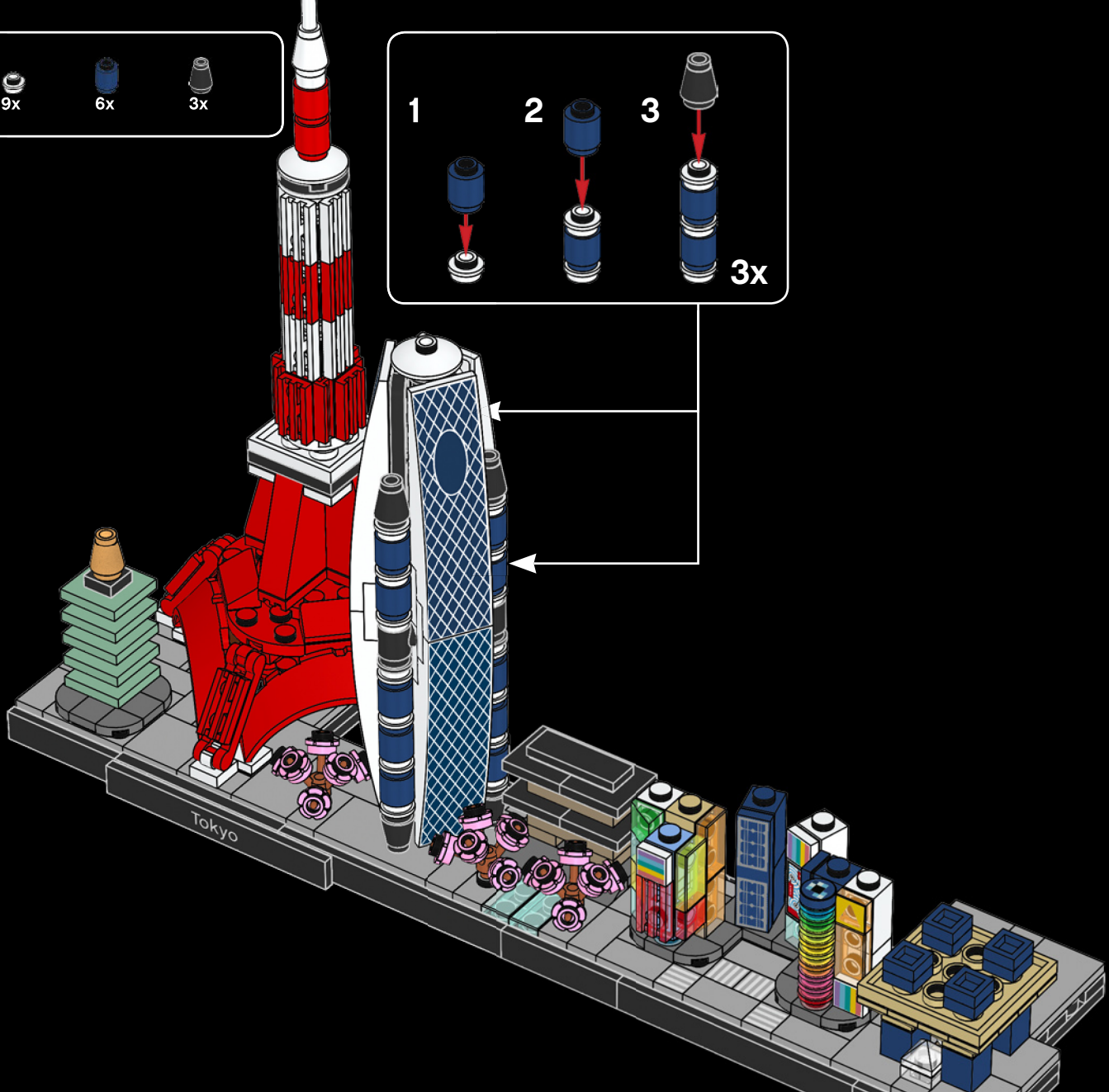
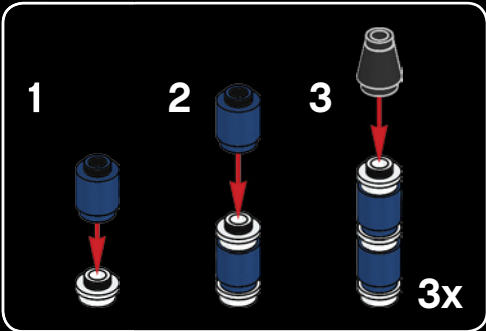

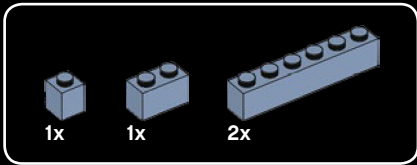

75

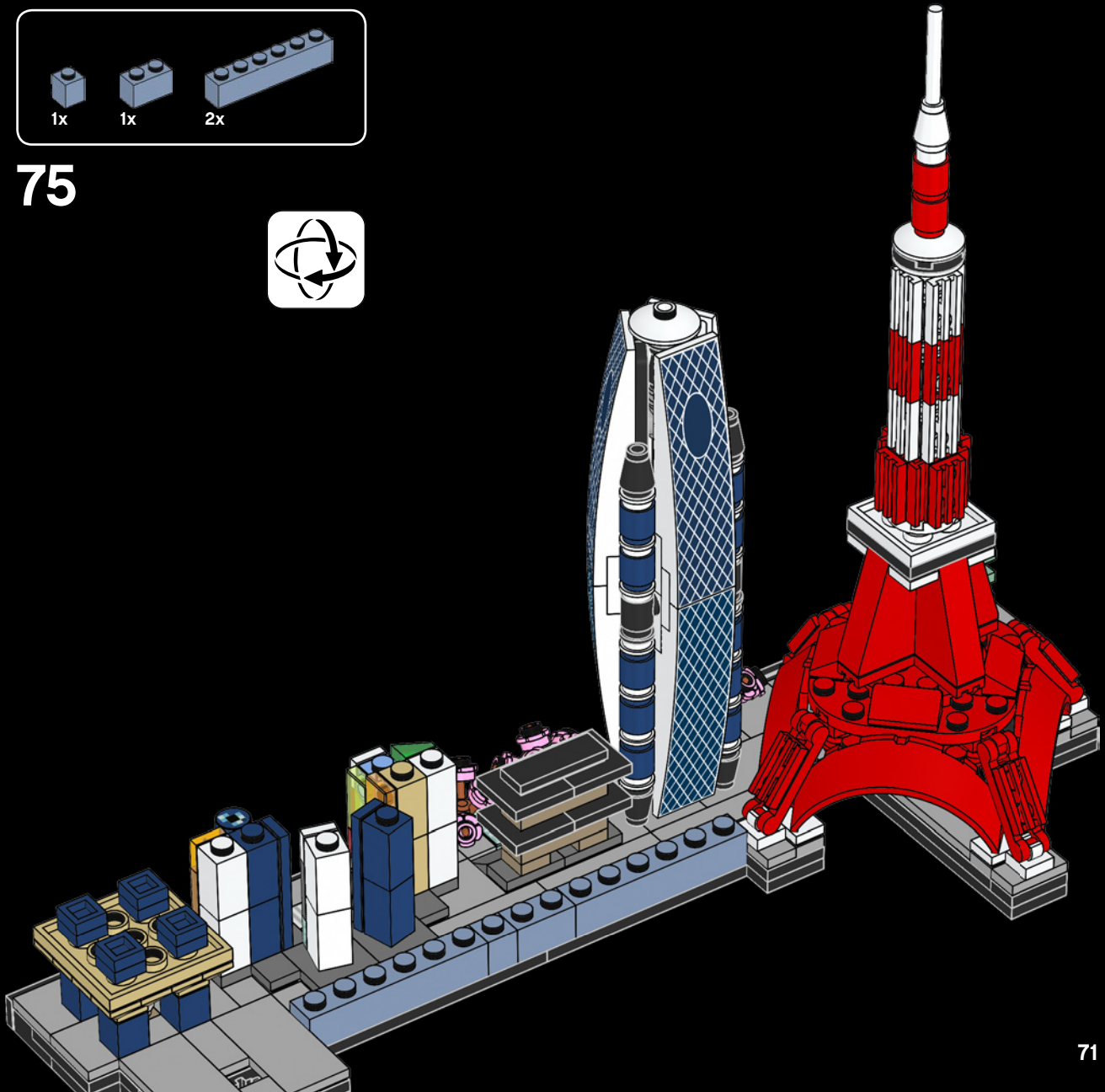

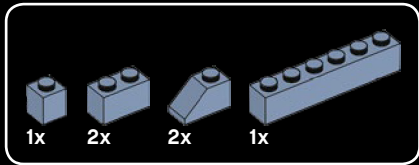

76



Mount Fuji

Mount Fuji is the tallest mountain in Japan and stands 12,380 ft. (3,776m) high.

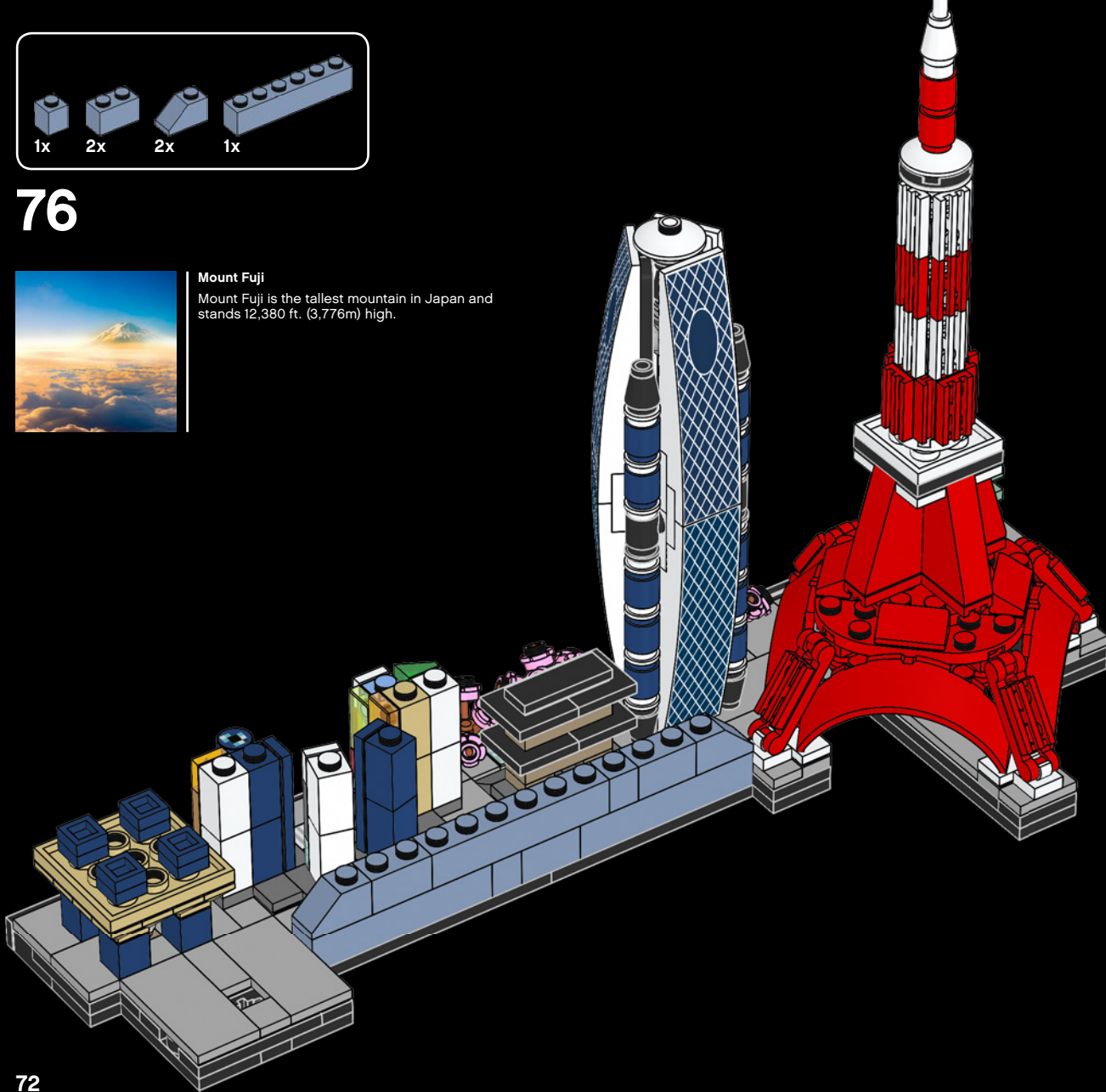

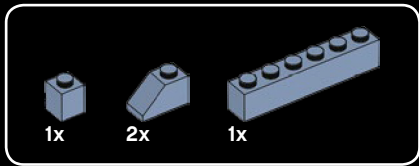

78



Mount Fuji

Mount Fuji is located only 60 miles (96 km) from the city of Tokyo.

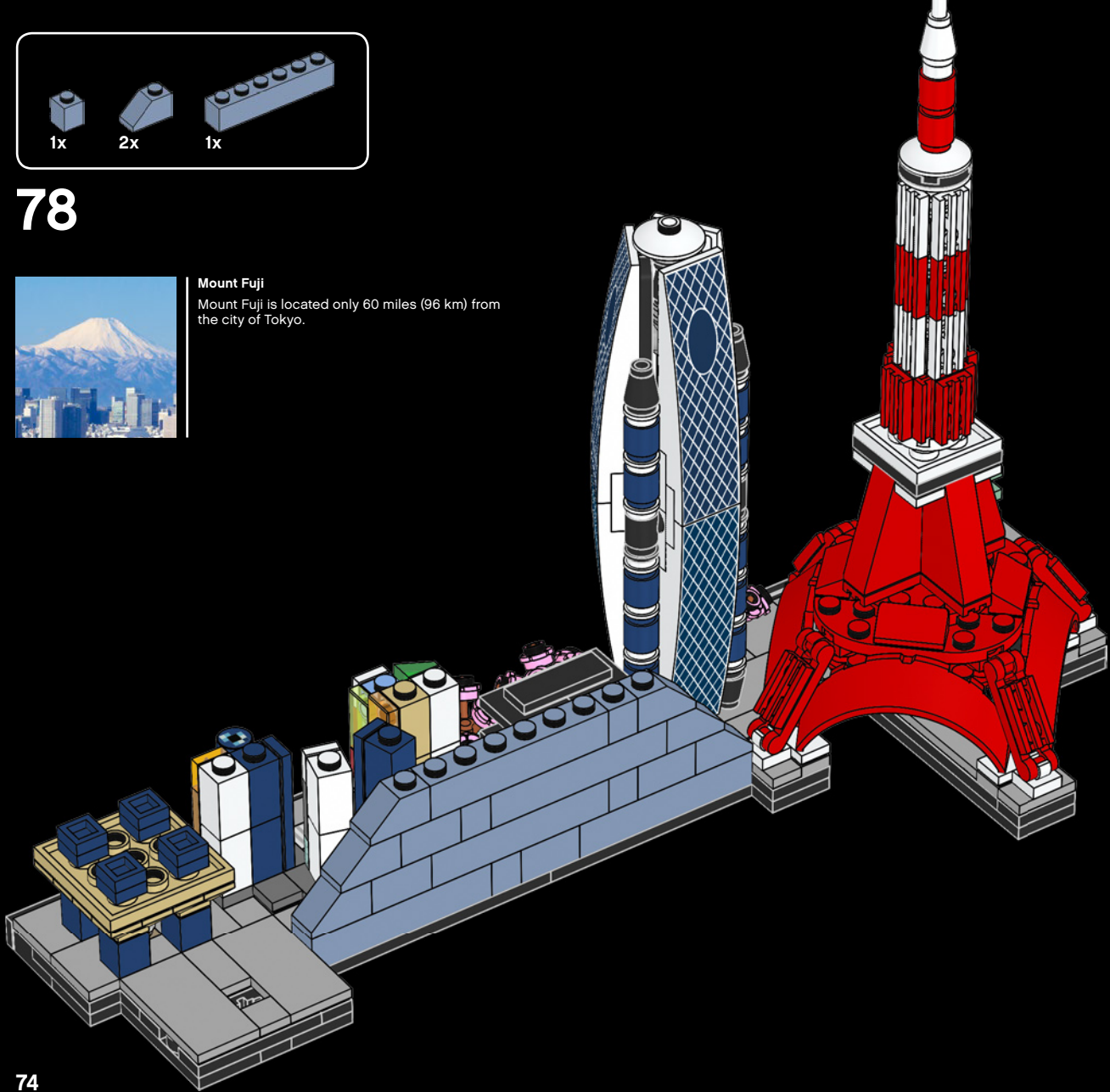

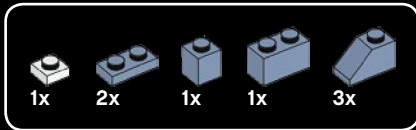

79

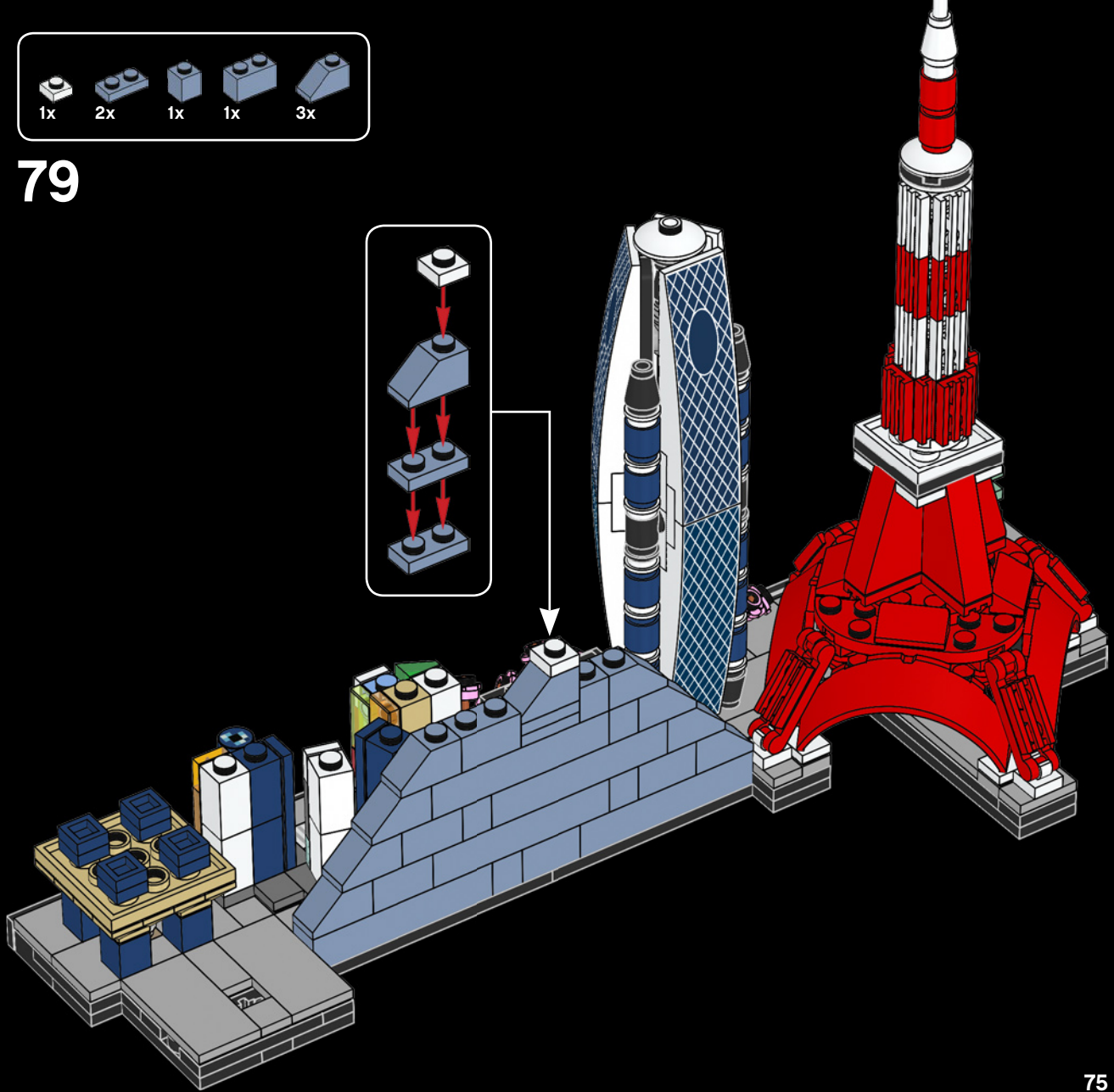
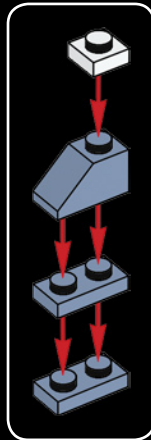



81



Mount Fuji

Mount Fuji is an active volcano. The last time it erupted was in 1707.

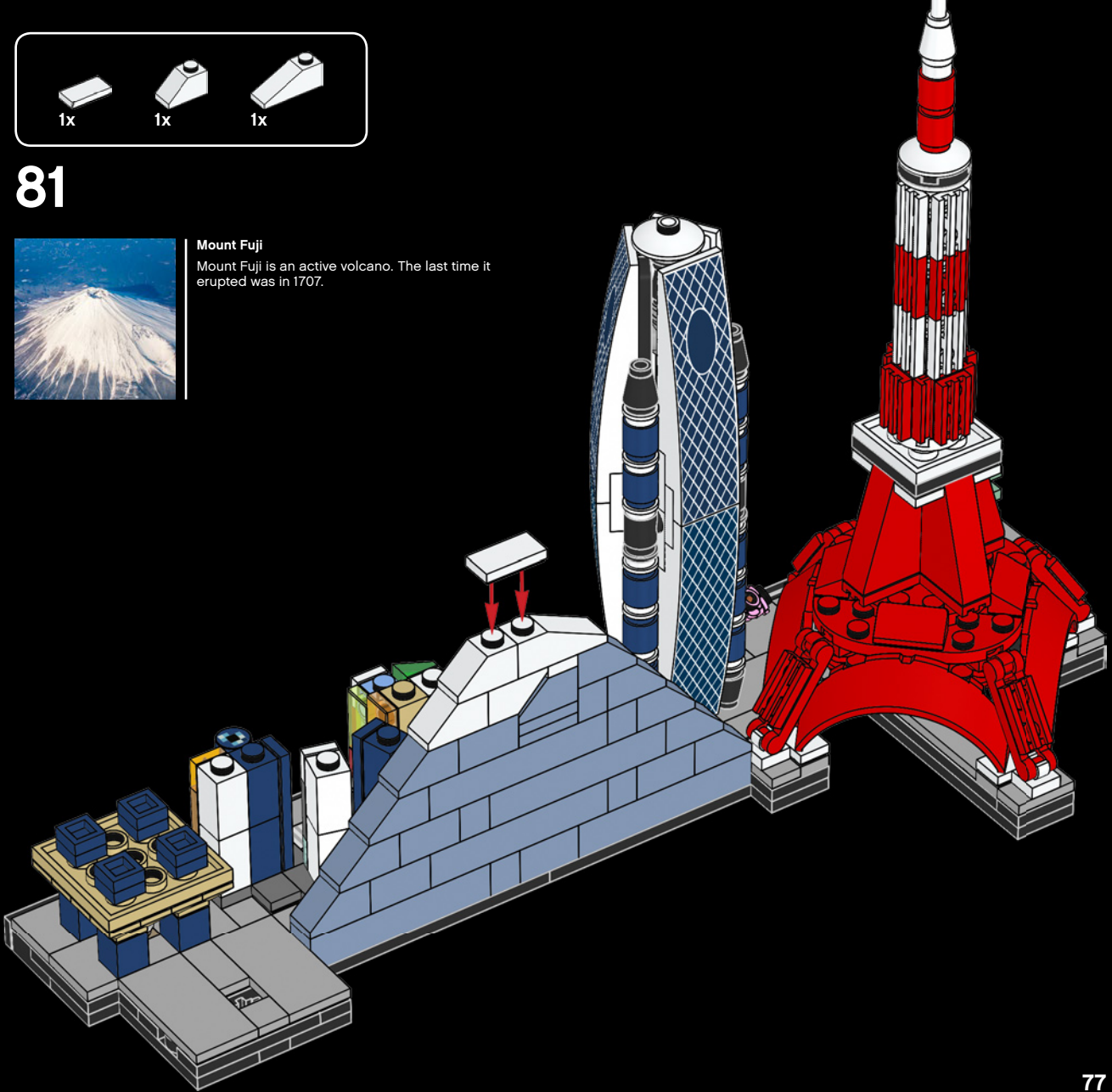

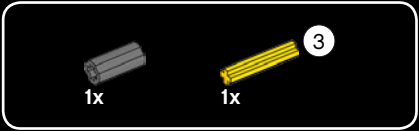

82

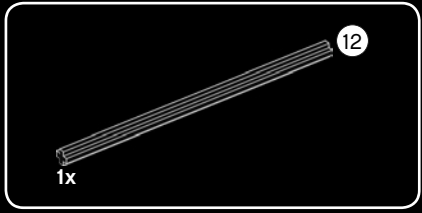

83



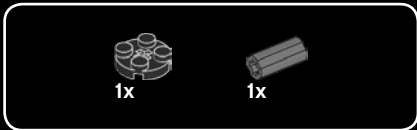

84

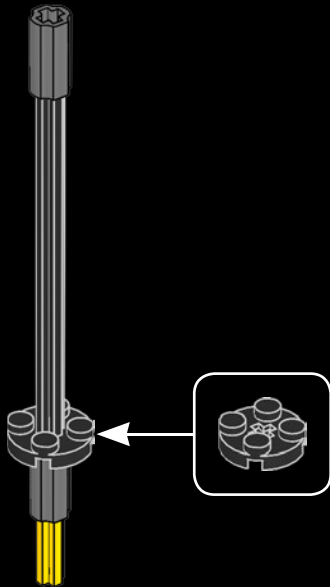

TOKYO SKYTREE
It took 1,325 days to complete the construction of the tower.



85

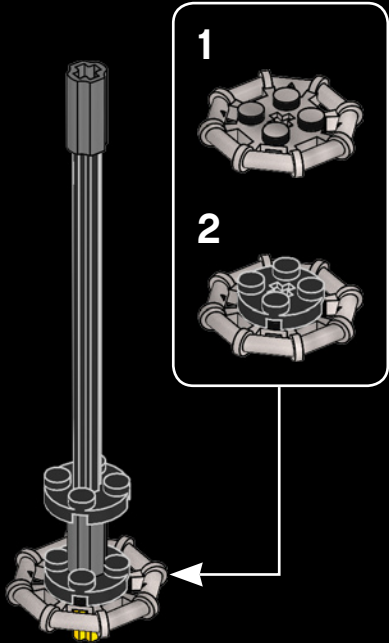



TOKYO SKYTREE

The exterior bluish-white color is based on a traditional Japanese color.

86

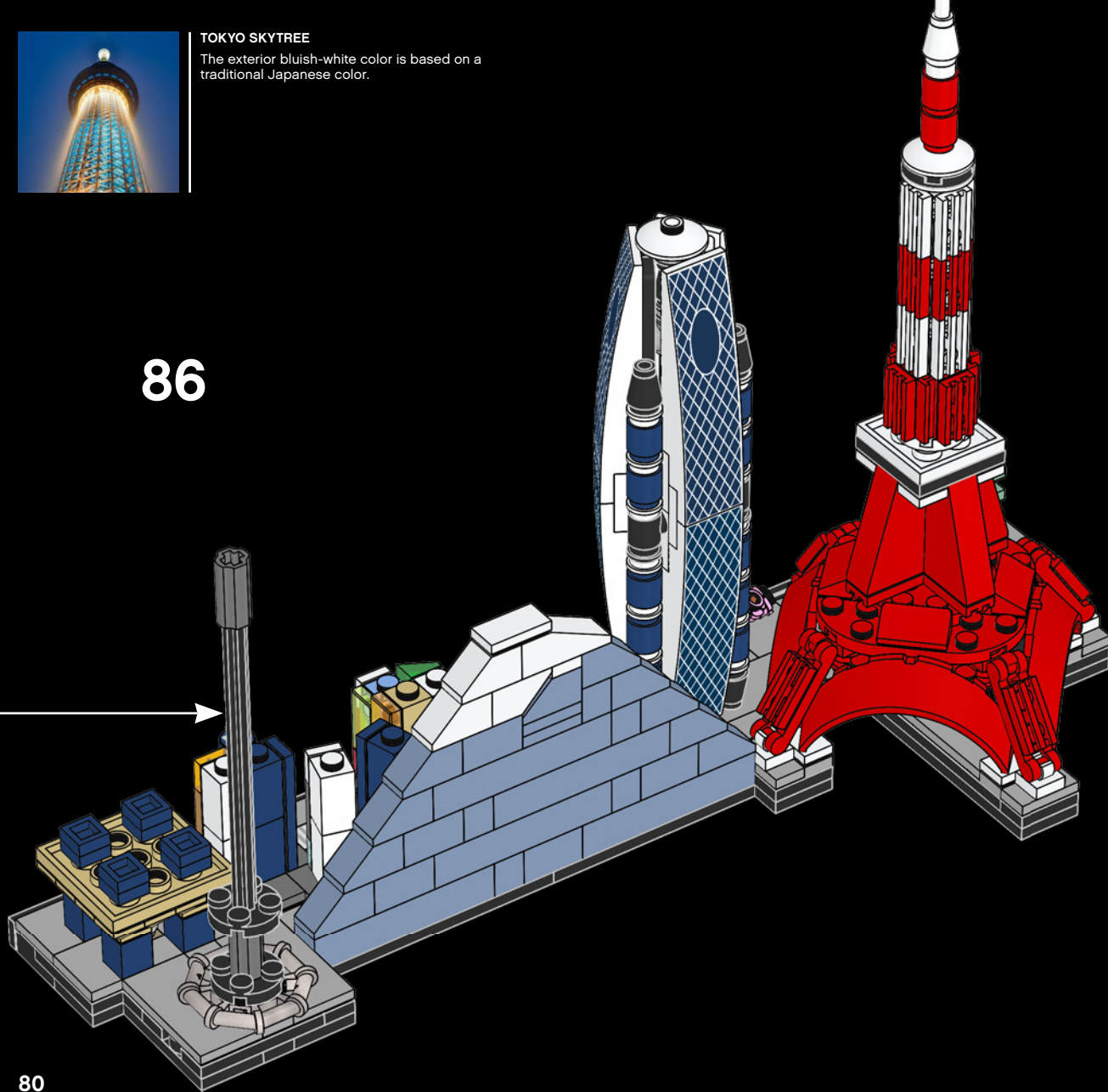

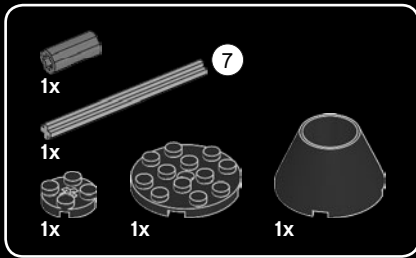

87

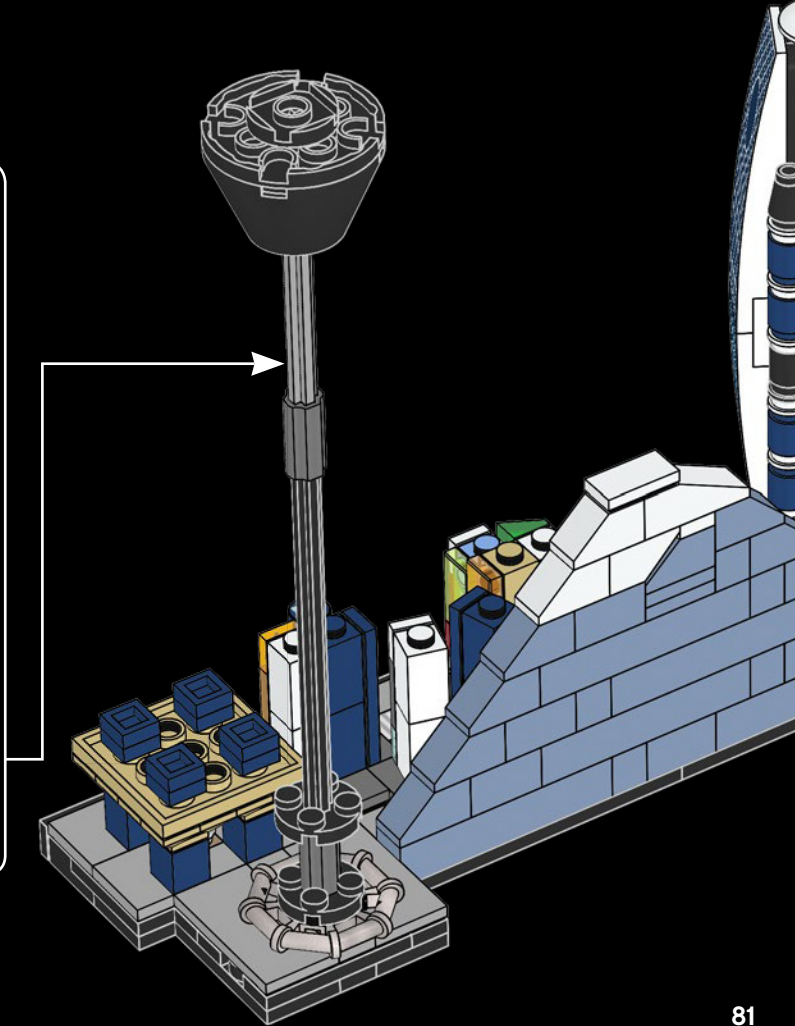
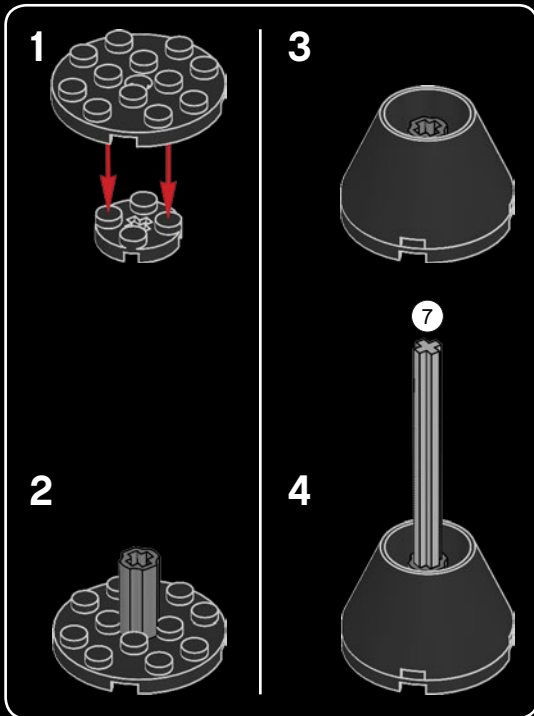

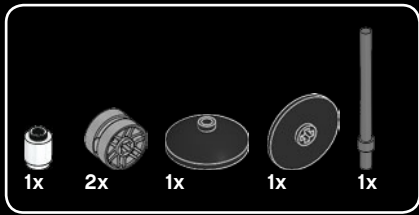

88

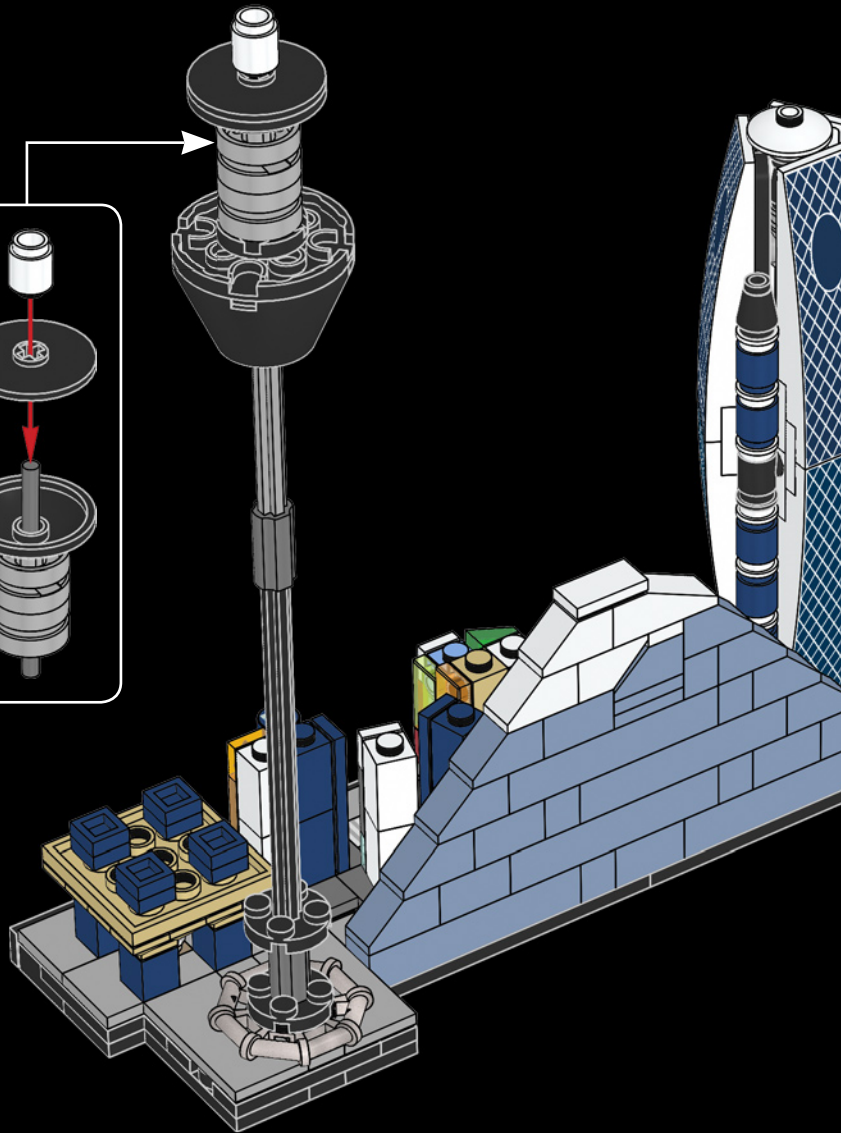
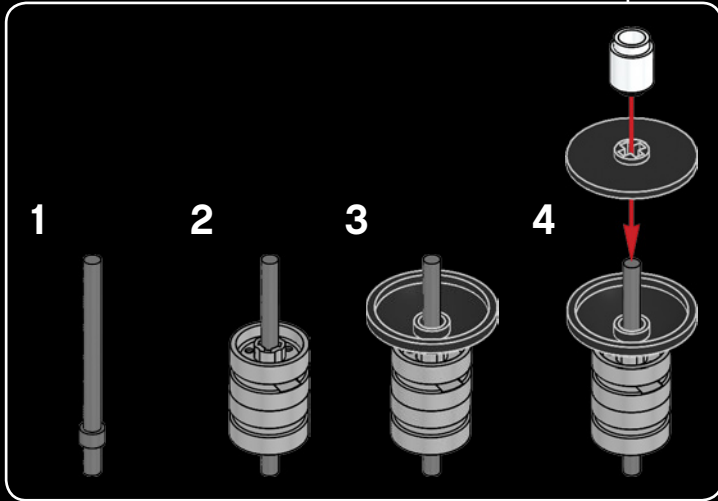



89

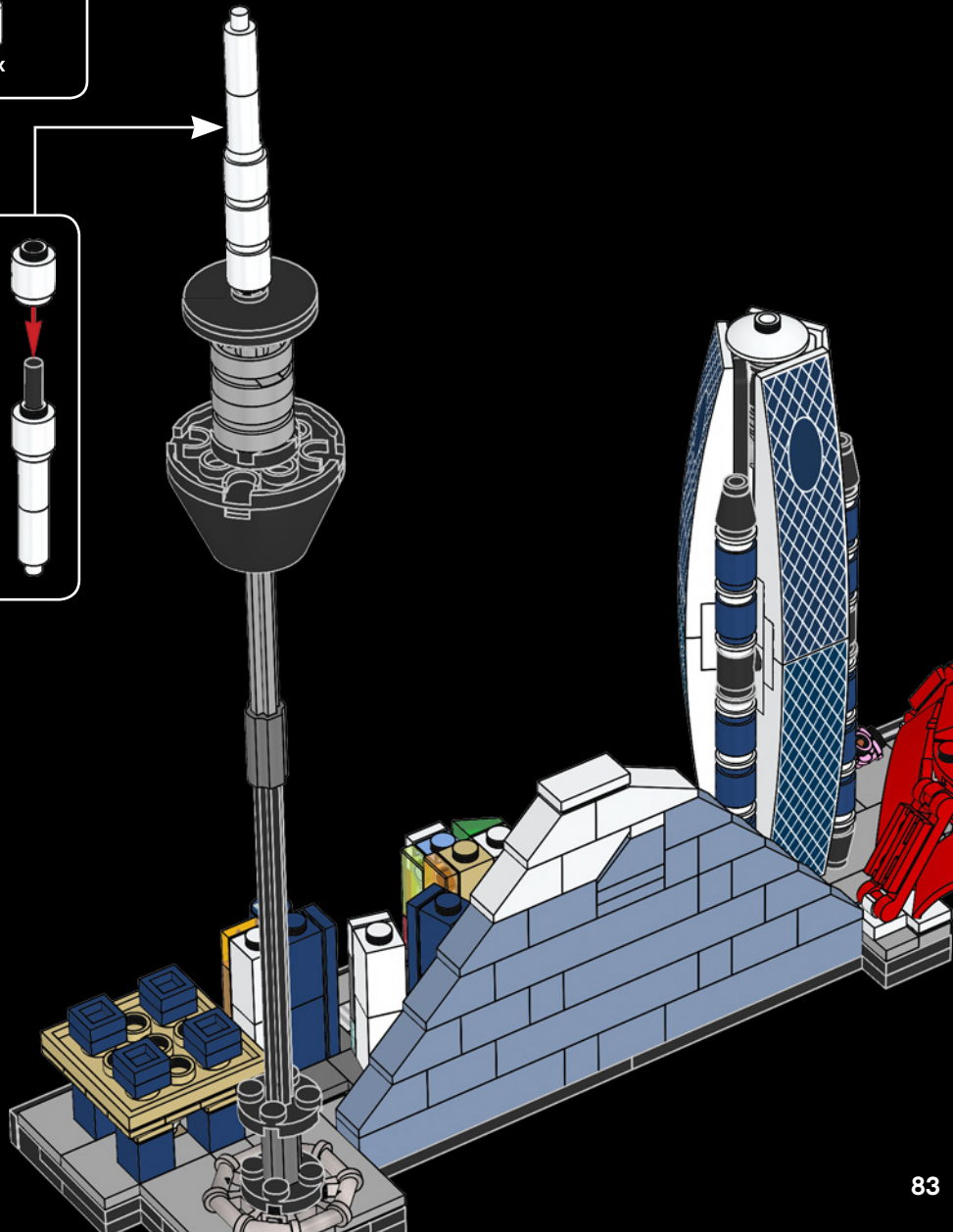
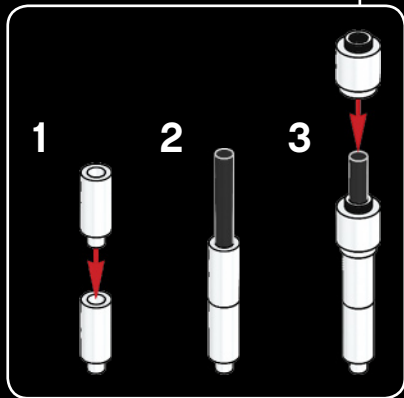

The name was chosen in 2008 through a nationwide poll, from 6 candidates submitted from the public in 2007.

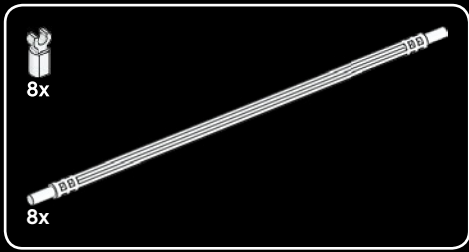
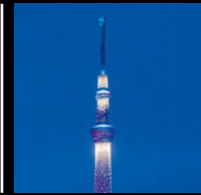

90

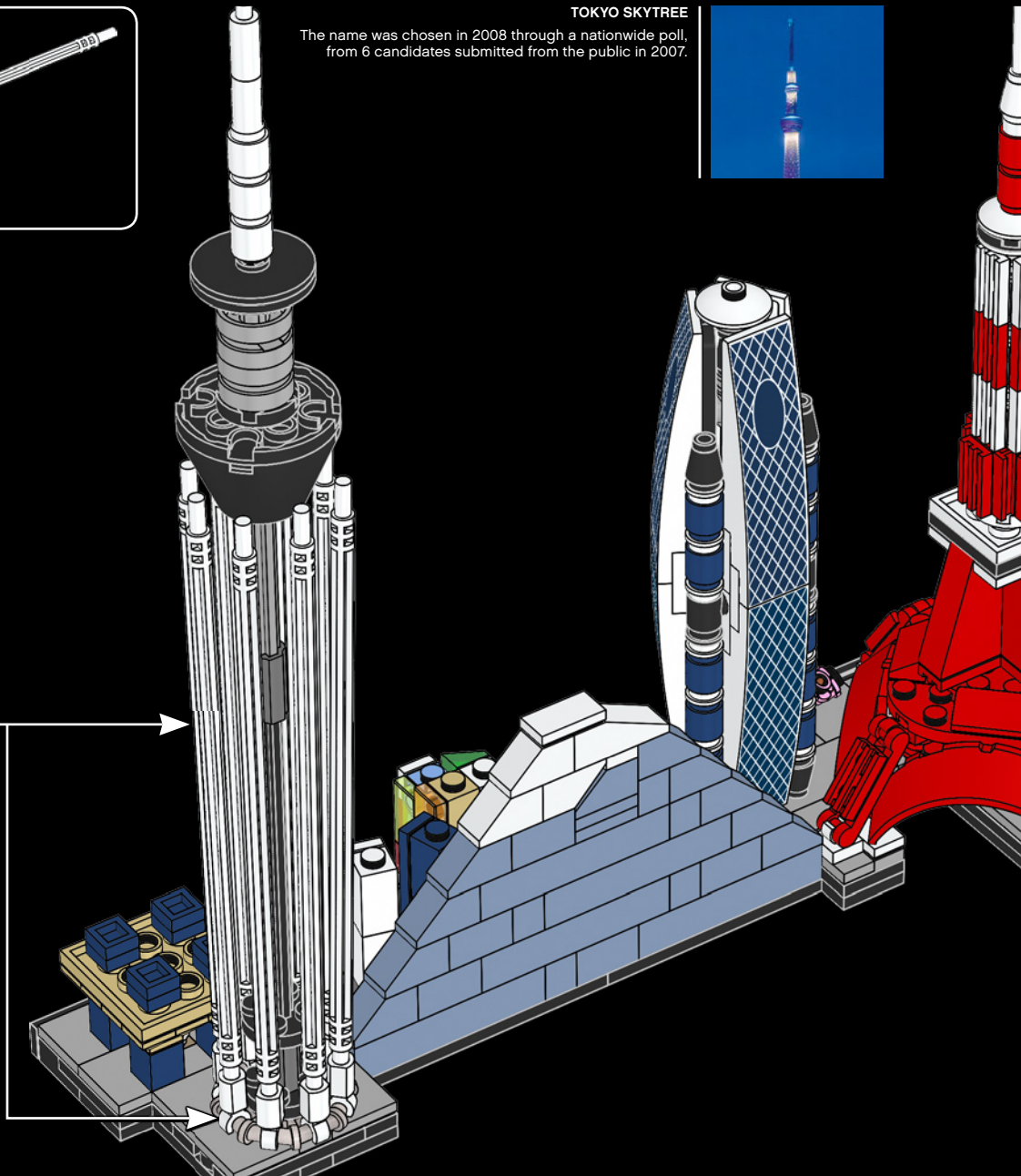
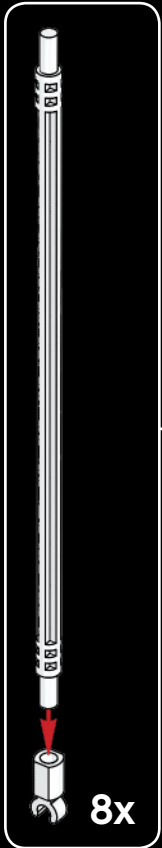

91

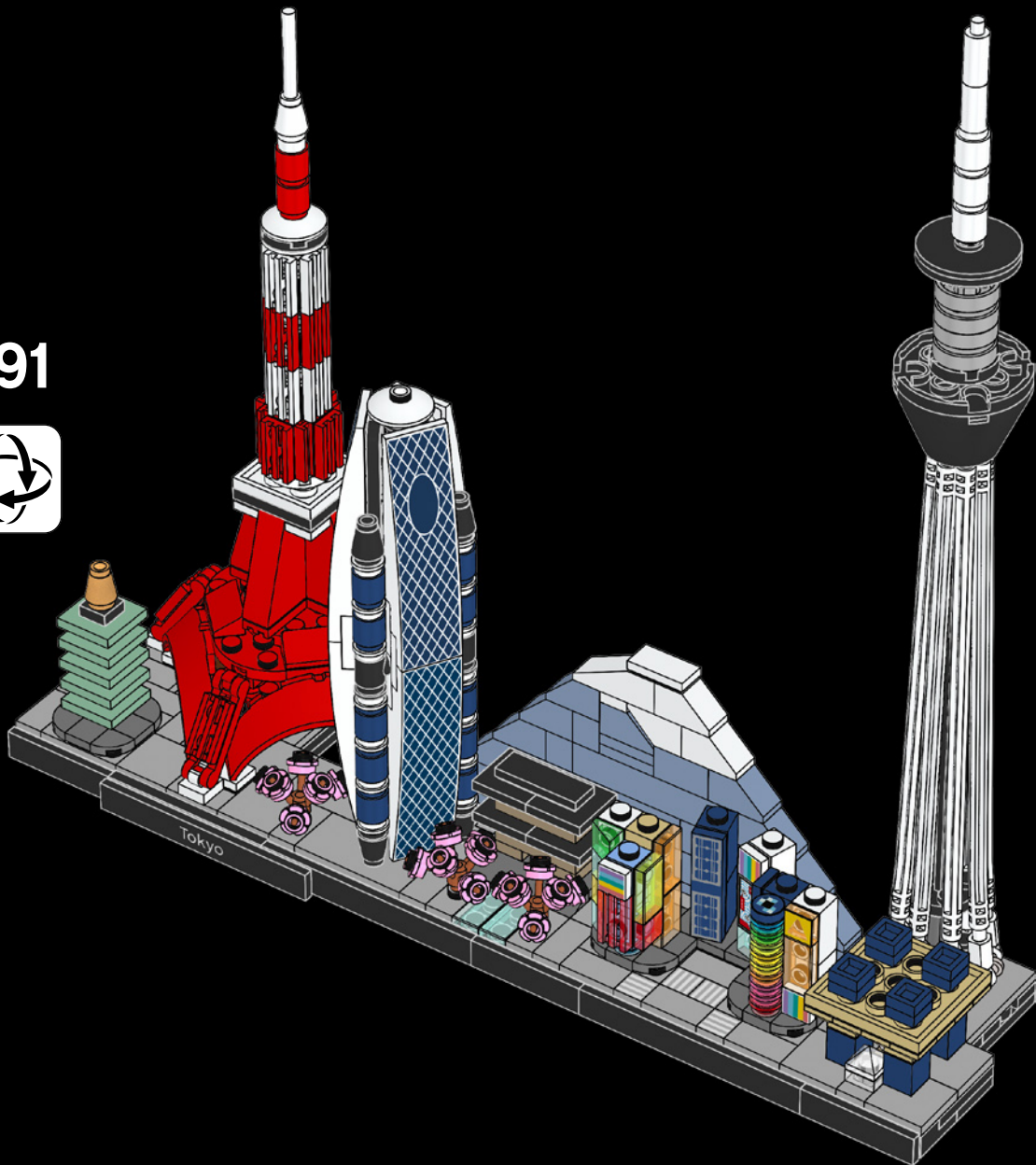



LEGO® Architecture – do you like it?

The LEGO Group would like your opinion on the new product you have just purchased. Your feedback will help shape the future development of this product series. Please visit:

[LEGO.com/productfeedback](https://www.lego.com/productfeedback)

By completing our short feedback survey, you will be automatically entered into a drawing to win a LEGO® prize.

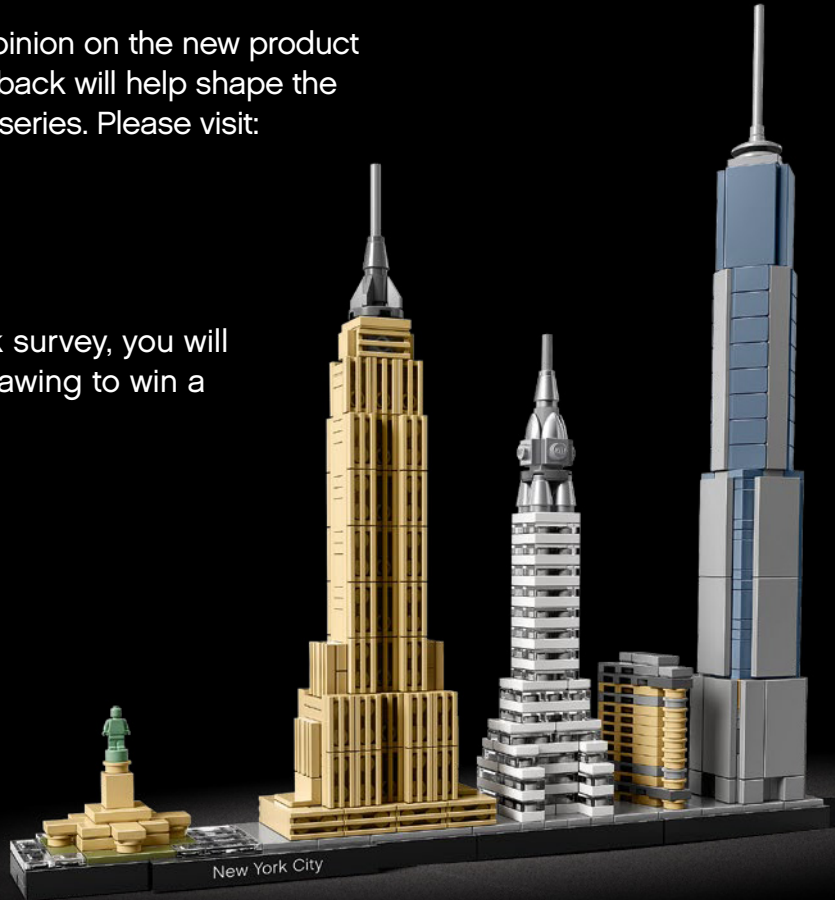



Terms & Conditions apply.

LEGO® Architecture

The LEGO® Architecture series creatively captures the essence of many of the world's most iconic landmarks while giving you an enjoyable and engaging LEGO building experience.

Whether your interest is in travel, design, history or architecture, these sets are a physical memento of a great trip abroad, a famous building you know well, or a city you still dream of visiting.

Every LEGO Architecture set is designed to be displayed. Much more than just a photo, building and displaying your model on your desk, in the bookcase or on the shelf, lets you be transported every time you admire the view.

Follow us on  

Adam Reed Tucker is the co-developer of the LEGO Architecture product line.



Celebrate the world of architecture and collect all the models

21045
Trafalgar Square



21042
Statue of Liberty



21046
Empire State Building



21028
New York City



21039
Shanghai

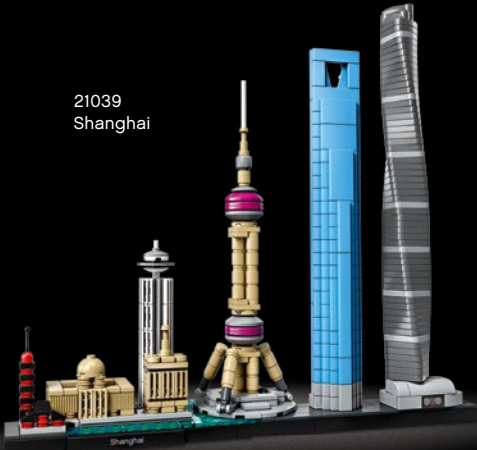

21043
San Francisco



21034
London



21044
Paris



21052
Dubai

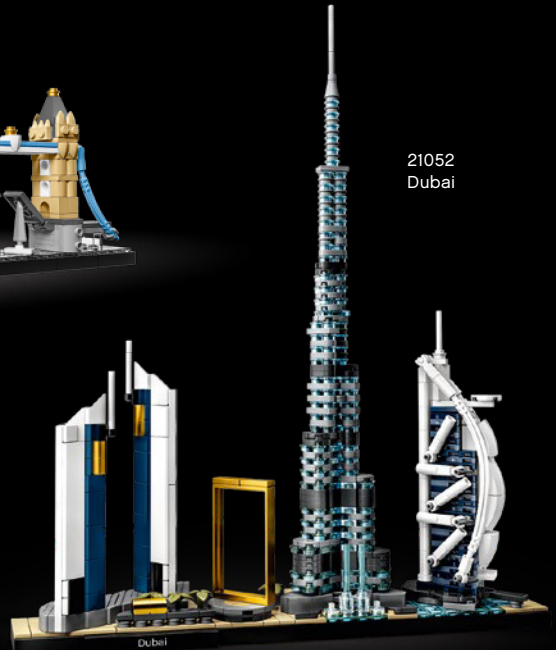

References

Pictures

© Shutterstock

Text

www.tokyotower.co.jp
www.tangeweb.com
www.gotokyo.org
www.tokyo-skytree.jp

Customer Service
Kundenservice
Service Consommateurs
Servicio Al Consumidor
LEGO.com/service or dial



00800 5346 5555 :

1-800-422-5346 :



32x
6168642

4x
6054551

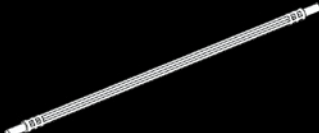
8x
6102484

1x
4518400

2x
6234807

5x
307001

3x
302401

3x
6253635

6x
6218841

6x
4111971

1x
403201

3x
474001

1x
366501

3x
302301

8x
6052824

8x
241201

5x
306901

3x
306201

3x
6232029

2x
4121932

6x
302201

1x
428601

1x
6104805

2x
395701

3x
6291465

3x
6286276

4x
614121

2x
306221

4x
4524644

4x
6108802

4x
4612575

4x
302221

4x
6286215

3x
4515348

4x
6286218

1x
4142865

4x
4651524

16x
241221

4x
4501534

5x
6168646

7x
4529236

3x
6073231

6x
302426

3x
403226

2x
366626

1x
370826

3x
6195325



8x
302326



1x
4218868



2x
6093525

2x
302226

5x
4653049

1x
6285764

2x
416226

12x
303426

12



4x
4565323



4x
6052126



1x
4180087



4x
362326



1x
4558170



2x
302126



3x
243126



2x
371026



1x
4515350



1x
4550922

94

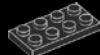

6x
302026

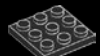

1x
6174917



8x
6280168



1x
6208450



1x
6254248



1x
6250158



1x
6240223



1x
6240216



1x
6245272



1x
6240227



1x
6255958



3x
6251306



2x
6130007



11x
4549436



1x
6132767



2x
6132768



16x
6249125



2x
6232135



1x
4243824



1x
6240206



1x
6251298



2x
6245277



1x
6254256



2x
6251295



2x
6240214



18x
6212501



2x
6240230



1x
6240221



1x
6245270



2x
4179826



2x
6195548



5x
4620077



2x
6198156

3x
4143005

15x
4177741

1x
6253178

8x
4184108

4x
4255413

4x
6253883

2x
6215341

5x
6177142

10x
6212055

5x
4620992

1x
6223655

1x
6252041

1x
6252962

10x
4211414

2x
4211396

1x
6258831

3x
4211573

4x
4211399

4x
4211415

4x
6286223

4x
4211398

8x
6066097

2x
6029209

2x
4502595

3x
4211413

7x
6065824

4x
4211356

6x
4560183

1x
4211438

1x
4211805

2x
4211445

1x
6015347

4x
6170420

8x
4210848

8x
6199549

2x
4567887

4x
4516546

1x
6226606

2x
6092572

2x
6126083

2x
4210635

1x
4529247

1x
6170470



2x
6146301

1x
6135494

5x
6186826



3x
6269941

1x
6020990

1x
6254100

7

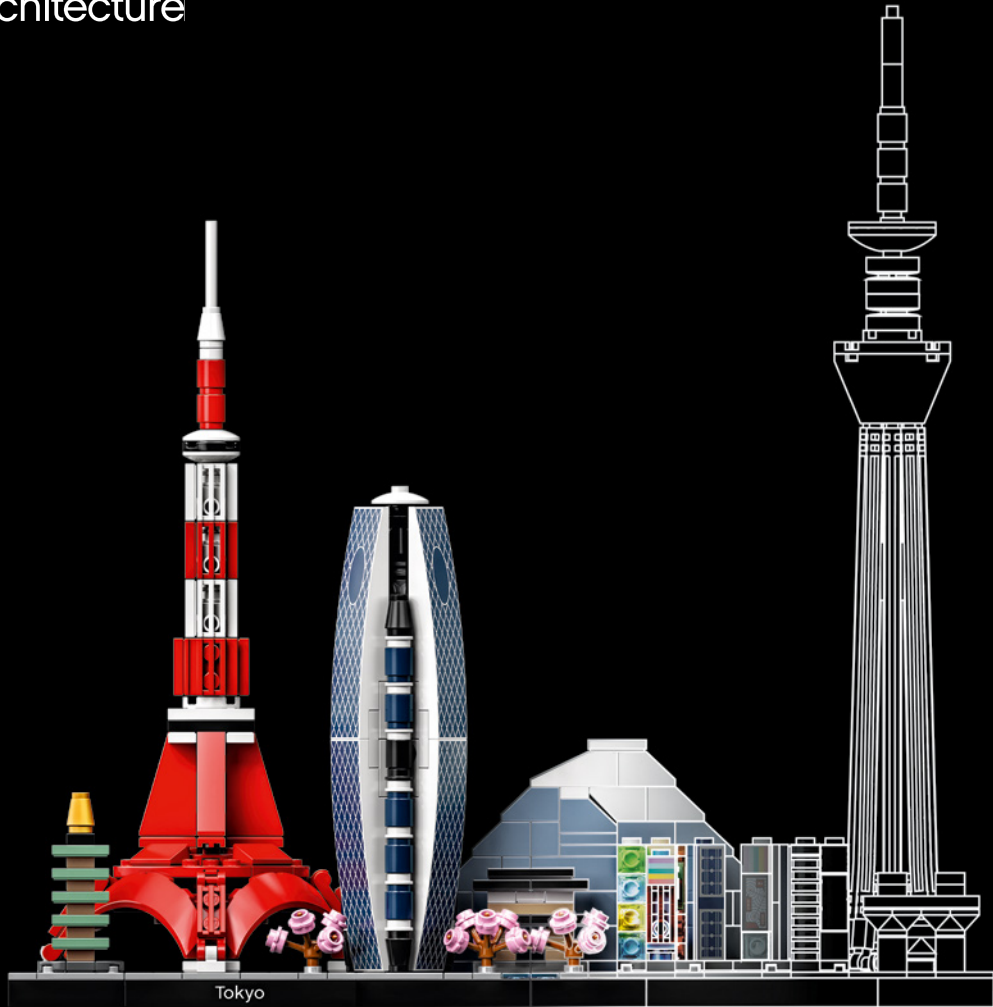
3



Tokyo

 LEGO.com/architecture

LEGO and the LEGO logo are trademarks of the LEGO Group.
©2020 The LEGO Group. 6326832

©TOKYO-SKYTREE
東京スカイツリー®/東京晴空塔®/TOKYO SKYTREE

Follow LEGO® Architecture on

