

**PRIME H610M-K**

**ASUS**

**Motherboard**

E22450  
First Edition  
August 2023

**Copyright © 2023 ASUSTeK COMPUTER INC. All Rights Reserved.**

No part of this manual, including the products and software described in it, may be reproduced, transmitted, transcribed, stored in a retrieval system, or translated into any language in any form or by any means, except documentation kept by the purchaser for backup purposes, without the express written permission of ASUSTeK COMPUTER INC. ("ASUS").

Product warranty or service will not be extended if: (1) the product is repaired, modified or altered, unless such repair, modification or alteration is authorized in writing by ASUS; or (2) the serial number of the product is defaced or missing.

ASUS PROVIDES THIS MANUAL "AS IS" WITHOUT WARRANTY OF ANY KIND, EITHER EXPRESS OR IMPLIED, INCLUDING BUT NOT LIMITED TO THE IMPLIED WARRANTIES OR CONDITIONS OF MERCHANTABILITY OR FITNESS FOR A PARTICULAR PURPOSE. IN NO EVENT SHALL ASUS, ITS DIRECTORS, OFFICERS, EMPLOYEES OR AGENTS BE LIABLE FOR ANY INDIRECT, SPECIAL, INCIDENTAL, OR CONSEQUENTIAL DAMAGES (INCLUDING DAMAGES FOR LOSS OF PROFITS, LOSS OF BUSINESS, LOSS OF USE OR DATA, INTERRUPTION OF BUSINESS AND THE LIKE), EVEN IF ASUS HAS BEEN ADVISED OF THE POSSIBILITY OF SUCH DAMAGES ARISING FROM ANY DEFECT OR ERROR IN THIS MANUAL OR PRODUCT.

SPECIFICATIONS AND INFORMATION CONTAINED IN THIS MANUAL ARE FURNISHED FOR INFORMATIONAL USE ONLY, AND ARE SUBJECT TO CHANGE AT ANY TIME WITHOUT NOTICE, AND SHOULD NOT BE CONSTRUED AS A COMMITMENT BY ASUS. ASUS ASSUMES NO RESPONSIBILITY OR LIABILITY FOR ANY ERRORS OR INACCURACIES THAT MAY APPEAR IN THIS MANUAL, INCLUDING THE PRODUCTS AND SOFTWARE DESCRIBED IN IT.

Products and corporate names appearing in this manual may or may not be registered trademarks or copyrights of their respective companies, and are used only for identification or explanation and to the owners' benefit, without intent to infringe.

# Contents

Safety information.....	iv
About this guide.....	v
Package contents.....	vi
PRIME H610M-K specifications summary .....	vi

## Chapter 1: Product Introduction

1.1 Before you proceed.....	1-1
1.2 Motherboard layout.....	1-2
1.3 Central Processing Unit (CPU).....	1-9
1.4 System memory.....	1-11

## Chapter 2: BIOS Information

2.1 Knowing BIOS.....	2-1
2.2 BIOS Setup program.....	2-2
2.3 ASUS EZ Flash 3.....	2-3
2.4 ASUS CrashFree BIOS 3.....	2-4

## Appendix

Notices .....	A-1
Warranty.....	A-5
ASUS contact information.....	A-7
Service and Support .....	A-7

# Safety information

## Electrical safety



- To prevent electrical shock hazard, disconnect the power cable from the electrical outlet before relocating the system.
- When adding or removing devices to or from the system, ensure that the power cables for the devices are unplugged before the signal cables are connected. If possible, disconnect all power cables from the existing system before you add a device.
- Before connecting or removing signal cables from the motherboard, ensure that all power cables are unplugged.
- Seek professional assistance before using an adapter or extension cord. These devices could interrupt the grounding circuit.
- Ensure that your power supply is set to the correct voltage in your area. If you are not sure about the voltage of the electrical outlet you are using, contact your local power company.
- If the power supply is broken, do not try to fix it by yourself. Contact a qualified service technician or your retailer.

## Operation safety

- Before installing the motherboard and adding devices on it, carefully read all the manuals that came with the package.
- Before using the product, ensure all cables are correctly connected and the power cables are not damaged. If you detect any damage, contact your dealer immediately.
- To avoid short circuits, keep paper clips, screws, and staples away from connectors, slots, sockets and circuitry.
- Avoid dust, humidity, and temperature extremes. Do not place the product in any area where it may become wet.
- Place the product on a stable surface.
- If you encounter technical problems with the product, contact a qualified service technician or your retailer.
- Your motherboard should only be used in environments with ambient temperatures between 10°C and 35°C.

## Button/Coin Batteries Safety Information



 <b>WARNING</b>	
<b>KEEP OUT OF REACH OF CHILDREN</b> Swallowing can lead to chemical burns, perforation of soft tissue, and death. Severe burns can occur within 2 hours of ingestion. Seek medical attention immediately.	

## About this guide

This user guide contains the information you need when installing and configuring the motherboard.

## How this guide is organized

This guide contains the following parts:

- **Chapter 1: Product Introduction**  
This chapter describes the features of the motherboard and the new technology it supports. It includes description of the switches, jumpers, and connectors on the motherboard.
- **Chapter 2: BIOS Information**  
This chapter tells how to boot into the BIOS and upgrade BIOS using the EZ Flash Utility.

## Where to find more information

Refer to the following sources for additional information and for product and software updates.

1. **ASUS website**  
The ASUS website ([www.asus.com](http://www.asus.com)) provides updated information on ASUS hardware and software products.
2. **Optional documentation**  
Your product package may include optional documentation, such as warranty flyers, that may have been added by your dealer. These documents are not part of the standard package.

## Conventions used in this guide

To ensure that you perform certain tasks properly, take note of the following symbols used throughout this user guide.



**CAUTION:** Information to prevent damage to the components and injuries to yourself when trying to complete a task.



**IMPORTANT:** Instructions that you **MUST** follow to complete a task.



**NOTE:** Tips and additional information to help you complete a task.

## Package contents

Check your motherboard package for the following items.

<b>Motherboard</b>	1 x PRIME H610M-K motherboard
<b>Cables</b>	2 x SATA 6Gb/s cables
<b>Miscellaneous</b>	1 x I/O Shield 1 x M.2 Anchor
<b>Documentation</b>	1 x User guide



If any of the above items is damaged or missing, contact your retailer.

## PRIME H610M-K specifications summary

<b>CPU</b>	Intel® Socket LGA1700 for 13 <sup>th</sup> Gen Intel® Core™ & 12 <sup>th</sup> Gen Intel® Core™, Pentium® Gold and Celeron® Processors* Supports Intel® Turbo Boost Technology 2.0 and Intel® Turbo Boost Max Technology 3.0** <b>* Refer to <a href="http://www.asus.com">www.asus.com</a> for CPU support list.</b> <b>** Intel® Turbo Boost Max Technology 3.0 support depends on the CPU types.</b>
<b>Chipset</b>	Intel® H610 Chipset
<b>Memory</b>	2 x DIMM slots, Max. 96GB, DDR5 Non-ECC, Un-buffered Memory* Dual Channel Memory Architecture Supports Intel® Extreme Memory Profile (XMP) <b>* Supported memory types, data rate (speed), and number of DRAM modules vary depending on the CPU and memory configuration, for more information please refer to CPU/Memory Support list under the Support tab of product information site or visit <a href="https://www.asus.com/support/">https://www.asus.com/support/</a>.</b> <b>* Non-ECC, un-buffered DDR5 memory supports On-Die ECC function.</b>
<b>Graphics</b>	1 x VGA port 1 x HDMI™ port** <b>* Graphics specifications may vary between CPU types. Please refer to <a href="http://www.intel.com">www.intel.com</a> for any updates.</b> <b>** Supports 4K@60Hz as specified in HDMI™ 2.1.</b>
<b>Expansion Slots</b>	<b>Intel® 13<sup>th</sup> &amp; 12<sup>th</sup> Gen Processors</b> 1 x PCIe 4.0 x16 slot <b>Intel® H610 Chipset</b> 1 x PCIe 3.0 x1 slot Note: To ensure compatibility of the device installed, please refer to <a href="https://www.asus.com/support/">https://www.asus.com/support/</a> for the list of supported peripherals.
<b>Storage</b>	<b>Total supports 1 x M.2 slot and 4 x SATA 6Gb/s ports</b> <b>Intel® H610 Chipset</b> M.2 slot (Key M), type 2242/2260/2280 (supports PCIe 3.0 x4 mode) 4 x SATA 6Gb/s ports
<b>Ethernet</b>	1 x Realtek 1Gb Ethernet
<b>USB</b>	<b>Rear USB (Total 6 ports)</b> 2 x USB 3.2 Gen 1 (5G) ports (2 x Type-A) 4 x USB 2.0 ports (4 x Type-A) <b>Front USB (Total 4 ports)</b> 1 x USB 3.2 Gen 1 (5G) header supports 2 additional USB 3.2 Gen 1 ports 1 x USB 2.0 header supports 2 additional USB 2.0 ports

(continued on the next page)

# PRIME H610M-K specifications summary

<p><b>Audio</b></p>	<p><b>Realtek 7.1 Surround Sound High Definition Audio CODEC*</b></p> <ul style="list-style-type: none"> <li>- Supports: Jack-detection, Multi-streaming, Front Panel Jack-retasking</li> <li>- Supports up to 24-Bit/192 kHz playback</li> </ul> <p><b>Audio Features</b></p> <ul style="list-style-type: none"> <li>- Audio Shielding</li> <li>- Premium audio capacitors</li> <li>- Dedicated audio PCB layers</li> </ul> <p>* <b>A chassis with an HD audio module in the front panel is required to support 7.1 Surround Sound audio output.</b></p>
<p><b>Back Panel I/O Ports</b></p>	<p>2 x USB 3.2 Gen 1 (5G) ports (2 x Type-A)</p> <p>4 x USB 2.0 ports (4 x Type-A)</p> <p>1 x VGA port</p> <p>1 x HDMI™ port</p> <p>1 x Realtek 1Gb Ethernet port</p> <p>3 x Audio jacks</p> <p>1 x PS/2 Keyboard/Mouse combo port</p>
<p><b>Internal I/O Connectors</b></p>	<p><b>Fan and Cooling related</b></p> <ul style="list-style-type: none"> <li>1 x 4-pin CPU Fan header</li> <li>2 x 4-pin Chassis Fan headers</li> </ul> <p><b>Power related</b></p> <ul style="list-style-type: none"> <li>1 x 24-pin Main Power connector</li> <li>1 x 8-pin +12V Power connector</li> </ul> <p><b>Storage related</b></p> <ul style="list-style-type: none"> <li>1 x M.2 slot (Key M)</li> <li>4 x SATA 6Gb/s ports</li> </ul> <p><b>USB</b></p> <ul style="list-style-type: none"> <li>1 x USB 3.2 Gen 1 (5G) header supports 2 additional USB 3.2 Gen 1 ports</li> <li>1 x USB 2.0 header supports 2 additional USB 2.0 ports</li> </ul> <p><b>Miscellaneous</b></p> <ul style="list-style-type: none"> <li>1 x RGB header</li> <li>1 x Clear CMOS header</li> <li>1 x COM Port header</li> <li>1 x Front Panel Audio header (AAFP)</li> <li>1 x S/PDIF Out header</li> <li>1 x Speaker header</li> <li>1 x SPI TPM header (14-1pin)</li> <li>1 x 10-1 pin System Panel header</li> </ul>
<p><b>Special Features</b></p>	<p><b>ASUS 5X PROTECTION III</b></p> <ul style="list-style-type: none"> <li>- DIGI+ VRM</li> <li>- LANGuard</li> <li>- Overvoltage Protection</li> <li>- SafeSlot Core</li> <li>- Stainless-Steel Back I/O</li> </ul>

*(continued on the next page)*

## PRIME H610M-K specifications summary

Special Features	<b>ASUS Q-Design</b> - Q-DIMM - Q-LED Core - Q-Slot
	<b>ASUS Thermal Solution</b> - Aluminum heatsink design
	<b>ASUS Lighting Control</b> - RGB header
Software Features	<b>ASUS Exclusive Software</b> Armoury Crate - Fan Xpert 2+ AI Suite 3 - EPU - DIGI+ VRM - PC Cleaner ASUS CPU-Z Norton 360 Deluxe (60 Days Free Trial) WinRAR <b>UEFI BIOS</b> ASUS EZ DIY - ASUS CrashFree BIOS 3 - ASUS EZ Flash 3 - ASUS UEFI BIOS EZ Mode
	<b>BIOS</b> 128 Mb Flash ROM, UEFI AMI BIOS
	<b>Manageability</b> WOL by PME, PXE
	<b>Operating System</b> Windows® 11, Windows® 10 64-bit
	<b>Form Factor</b> micro-ATX Form Factor 9.2 inch x 8.0 inch (23.4 cm x 20.3 cm)



- Specifications are subject to change without notice. Please refer to the ASUS website for the latest specifications.
- For more information on downloading and installing drivers and utilities for your motherboard, please scan the code below:





# Product Introduction

# 1

## 1.1 Before you proceed

Take note of the following precautions before you install motherboard components or change any motherboard settings.



- 
- Unplug the power cord from the wall socket before touching any component.
  - Before handling components, use a grounded wrist strap or touch a safely grounded object or a metal object, such as the power supply case, to avoid damaging them due to static electricity.
  - Hold components by the edges to avoid touching the ICs on them.
  - Whenever you uninstall any component, place it on a grounded antistatic pad or in the bag that came with the component.
  - Before you install or remove any component, ensure that the ATX power supply is switched off or the power cord is detached from the power supply. Failure to do so may cause severe damage to the motherboard, peripherals, or components.



- 
- The pin definitions in this chapter are for reference only. The pin names depend on the location of the header/jumper/connector.
  - For more information on installing your motherboard, please scan the code below:



## 1.2 Motherboard layout

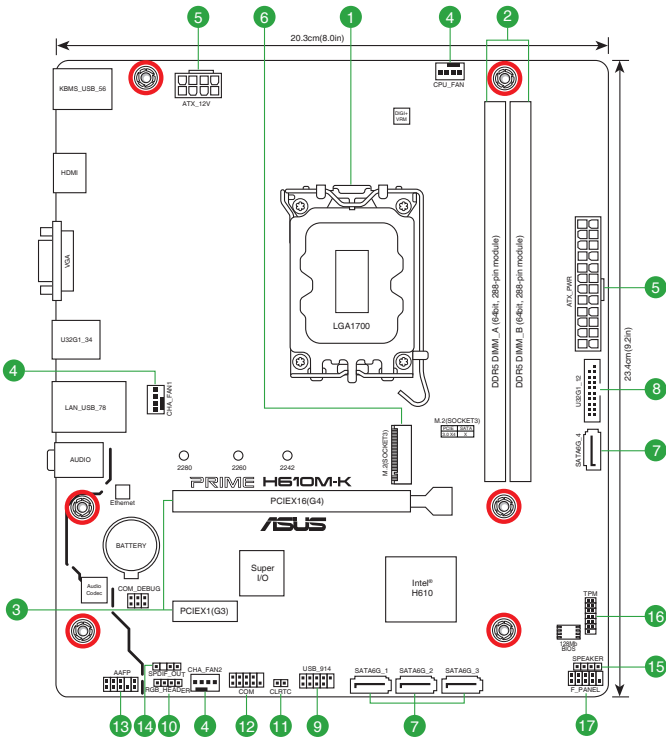

Unplug the power cord before installing or removing the motherboard. Failure to do so can cause you physical injury and damage motherboard components.

### 1.2.1 Layout contents

#### 1. CPU socket

The motherboard comes with a LGA1700 socket designed for 13<sup>th</sup> Gen Intel® Core™ & 12<sup>th</sup> Gen Intel® Core™, Pentium® Gold and Celeron® Processors.



For more details, refer to **Central Processing Unit (CPU)**.

#### 2. DDR5 DIMM slots

The motherboard comes with Dual Inline Memory Modules (DIMM) slots designed for DDR5 (Double Data Rate 5) memory modules.



For more details, refer to **System memory**.

### 3. Expansion slots

This motherboard supports one PCIe x16 graphics card and one PCIe x1 network card, SCSI card or other cards that comply with the PCI Express specification.

### 4. Fan headers

The Fan headers allow you to connect fans to cool the system.

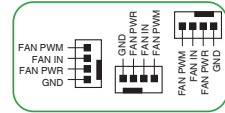

### 5. Power connectors

These Power connectors allow you to connect your motherboard to a power supply. The power supply plugs are designed to fit in only one orientation. Find the proper orientation and push down firmly until the power supply plugs are fully inserted.



Ensure to connect the 8-pin power plug.



We recommend that you use a PSU with a higher power output when configuring a system with more power-consuming devices. The system may become unstable or may not boot up if the power is inadequate.

### 6. M.2 slot (Key M)

The M.2 slot allows you to install an M.2 device such as an M.2 SSD module.



**Intel® H610 Chipset**

- M.2 slot (Key M), type 2242/2260/2280 (supports PCIe 3.0 x4 mode)



The M.2 SSD module is purchased separately.

### 7. SATA 6Gb/s ports

The SATA 6Gb/s ports allow you to connect SATA devices such as optical disc drives and hard disk drives via SATA cables.

### 8. USB 3.2 Gen 1 header

The USB 3.2 Gen 1 header allows you to connect a USB 3.2 Gen 1 module for additional USB 3.2 Gen 1 ports. The USB 3.2 Gen 1 header provides data transfer speeds of up to 5 Gb/s.



The USB 3.2 Gen 1 module is purchased separately.

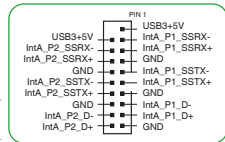

### 9. USB 2.0 header

The USB 2.0 header allows you to connect a USB module for an additional USB 2.0 port. The USB 2.0 header provides data transfer speeds of up to 480 Mb/s.



DO NOT connect a 1394 cable to the USB connectors. Doing so will damage the motherboard!



The USB 2.0 module is purchased separately.

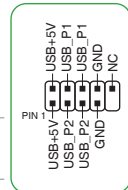

## 10. RGB header

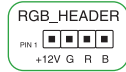

The RGB header allows you to connect RGB LED strips.



The RGB header supports 5050 RGB multi-color LED strips (12V/G/R/B), with a maximum power rating of 3A (12V), and no longer than 3m.



Before you install or remove any component, ensure that the ATX power supply is switched off or the power cord is detached from the power supply. Failure to do so may cause severe damage to the motherboard, peripherals, or components.



- Actual lighting and color will vary with LED strip.
- If your LED strip does not light up, check if the RGB LED extension cable and the RGB LED strip are connected in the correct orientation, and the 12V connector is aligned with the 12V header on the motherboard.
- The LED strip will only light up when the system is powered on.
- The LED strip is purchased separately.

## 11. Clear CMOS header

The Clear CMOS header allows you to clear the Real Time Clock (RTC) RAM in the CMOS, which contains the date, time, system passwords, and system setup parameters.

To erase the RTC RAM:

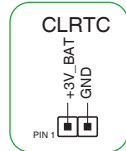

1. Turn OFF the computer and unplug the power cord.
2. Short-circuit pin 1-2 with a metal object or jumper cap for about 5-10 seconds.
3. Plug the power cord and turn ON the computer.
4. Hold down the <Del> key during the boot process and enter BIOS setup to re-enter data.



DO NOT short-circuit the pins except when clearing the RTC RAM. Short-circuiting or placing a jumper cap will cause system boot failure!



If the steps above do not help, remove the onboard button cell battery and short the two pins again to clear the CMOS RTC RAM data. After clearing the CMOS, reinstall the button cell battery.

## 12. COM Port header

The COM (Serial) Port header allows you to connect a COM port module. Connect the COM port module cable to this header, then install the module to a slot opening on the system chassis.

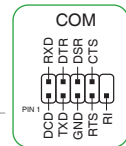

The COM port module is purchased separately.

### 13. Front Panel Audio header

The Front Panel Audio header is for a chassis-mounted front panel audio I/O module that supports HD Audio. Connect one end of the front panel audio I/O module cable to this header.



We recommend that you connect a high-definition front panel audio module to this header to avail of the motherboard's high-definition audio capability.

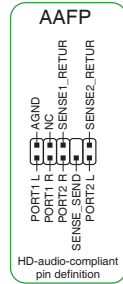

### 14. S/PDIF Out header

The S/PDIF Out header allows you to connect the Sony/Philips Digital Interface (S/PDIF) Out module.



The S/PDIF module is purchased separately.

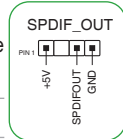

### 15. Speaker header

The Speaker header allows you to connect the chassis-mounted system warning speaker. The speaker allows you to hear system beeps and warnings.

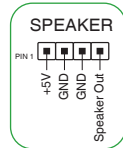

### 16. SPI TPM header

This header supports a Trusted Platform Module (TPM) system with a Serial Peripheral Interface (SPI), allowing you to securely store keys, digital certificates, passwords, and data. A TPM system also helps enhance network security, protects digital identities, and ensures platform integrity.



The TPM module is purchased separately.

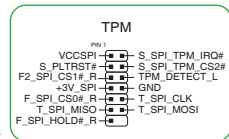

### 17. System Panel header

The System Panel header supports several chassis-mounted functions.

- **System Power LED header (+PWR\_LED-)**

The 2-pin header allows you to connect the System Power LED. The System Power LED lights up when the system is connected to a power source, or when you turn on the system power, and blinks when the system is in sleep mode.

- **Storage Device Activity LED header (+HDD\_LED-)**

The 2-pin header allows you to connect the Storage Device Activity LED. The Storage Device Activity LED lights up or blinks when data is read from or written to the storage device or storage device add-on card.

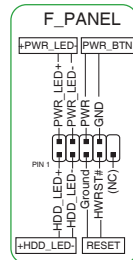

- **Power Button/Soft-off Button header (PWR\_BTN)**

The 2-pin header allows you to connect the system power button. Press the power button to power up the system, or put the system into sleep or soft-off mode (depending on the operating system settings).

- **Reset button header (RESET)**

The 2-pin header allows you to connect the chassis-mounted reset button. Press the reset button to reboot the system.

## 1.2.2 Rear panel connectors

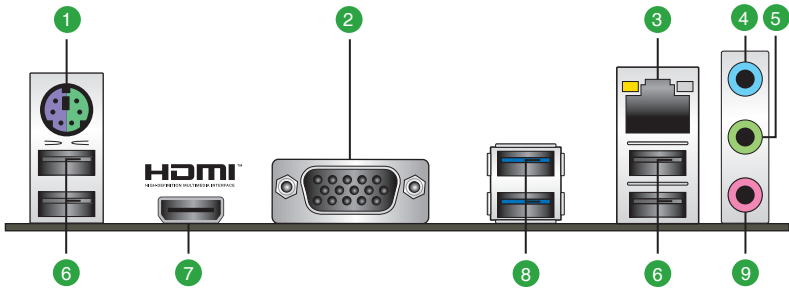

1. **PS/2 Keyboard/Mouse combo port.** This port is for a PS/2 keyboard or mouse.
2. **Video Graphics Adapter (VGA) port.** This 15-pin port is for a VGA monitor or other VGA-compatible devices.
3. **1Gb Ethernet port.** This port allows Gigabit connection to a Local Area Network (LAN) through a network hub. Refer to the table below for the Ethernet port LED indications.

### Realtek 1Gb Ethernet port LED indications

Activity Link LED		Speed LED	
Status	Description	Status	Description
OFF	No link	OFF	10Mbps connection
ORANGE	Linked	ORANGE	100Mbps connection
BLINKING	Data activity	GREEN	1Gbps connection

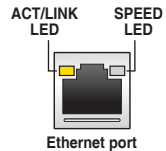

4. **Line In port (light blue).** This port connects the tape, CD, DVD player, or other audio sources.
5. **Line Out port (lime).** This port connects a headphone or a speaker. In 4-channel, 5.1-channel, and 7.1-channel configurations, the function of this port becomes Front Speaker Out.
6. **USB 2.0 ports.** These Universal Serial Bus (USB) ports are for USB 2.0 devices.
7. **HDMI™ port.** This port is for a High-Definition Multimedia Interface (HDMI™) connector, and is HDCP compliant allowing playback of HD DVD, Blu-ray, and other protected content.
8. **USB 3.2 Gen 1 (up to 5Gbps) ports.** These Universal Serial Bus (USB) ports connect to USB 3.2 Gen 1 devices.

**9. Microphone port (pink).** This port connects a microphone.



Refer to the audio configuration table below for the function of the audio ports in 2, 4, 5.1, or 7.1-channel configuration.

**Audio 2, 4, 5.1 or 7.1-channel configuration**

Port	2-channel	4-channel	5.1-channel	7.1-channel
Light Blue (Rear panel)	-	Rear Speaker Out	Rear Speaker Out	Rear Speaker Out
Lime (Rear panel)	Front Speaker Out	Front Speaker Out	Front Speaker Out	Front Speaker Out
Pink (Rear panel)	-	-	Center / Subwoofer	Center / Subwoofer
Lime (Front panel)	-	-	-	Side Speaker Out
Pink (Front panel)	-	-	-	-



**To configure a 7.1-channel audio output:**

Use a chassis with HD audio module in the front panel to support a 7.1-channel audio output.



## 1.3 Central Processing Unit (CPU)

This motherboard comes with a LGA1700 socket designed for 13<sup>th</sup> Gen Intel® Core™ & 12<sup>th</sup> Gen Intel® Core™, Pentium® Gold and Celeron® Processors.

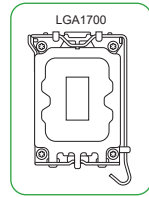

Unplug all power cables before installing the CPU.



- Ensure that you install the correct CPU designed for LGA1700 socket only. DO NOT install a CPU designed for LGA1155, LGA1156, LGA1151, and LGA1200 sockets on the LGA1700 socket.
- ASUS will not cover damages resulting from incorrect CPU installation/removal, incorrect CPU orientation/placement, or other damages resulting from negligence by the user.

### Installing the CPU

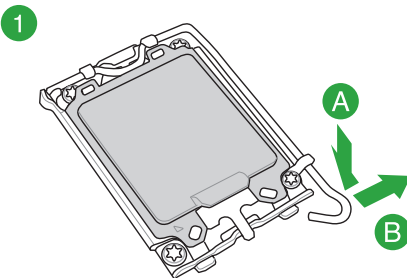
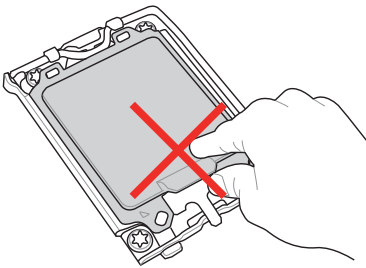

Take caution when lifting the load lever, ensure to hold onto the load lever when releasing the load lever. Letting go of the load lever immediately after releasing it may cause the load lever to spring back and cause damage to your motherboard.

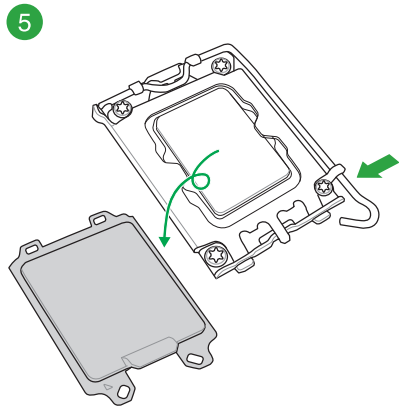
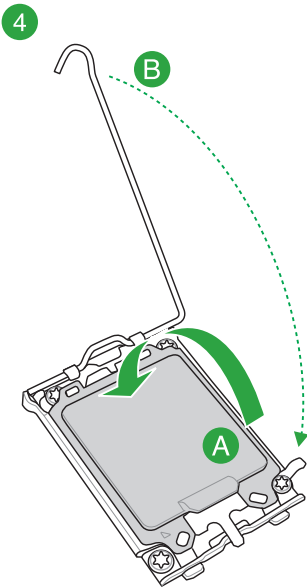
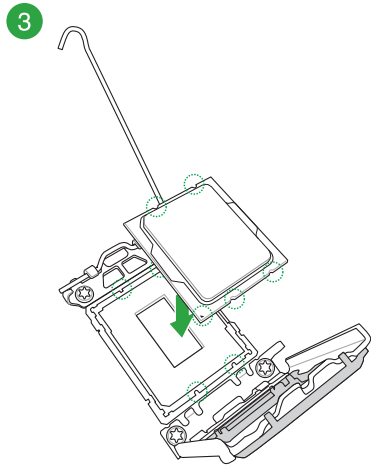
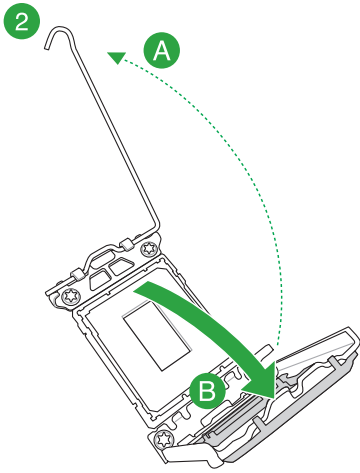

## 1.4 System memory

This motherboard comes with two Double Data Rate 5 (DDR5) Dual Inline Memory Module (DIMM) sockets. The figure illustrates the location of the DDR5 DIMM sockets:



Channel	Sockets
Channel A	DIMM_A
Channel B	DIMM_B



A DDR5 memory module is notched differently from a DDR, DDR2, DDR3, or DDR4 module. DO NOT install a DDR, DDR2, DDR3, or DDR4 memory module to the DDR5 slot.



- You may install varying memory sizes in Channel A and Channel B. The system maps the total size of the lower-sized channel for the dual-channel configuration. Any excess memory from the higher-sized channel is then mapped for single-channel operation.
- You may install 8 GB, 16 GB, 24 GB, 32 GB and 48 GB unbuffered and Non-ECC DDR5 DIMMs into the DIMM sockets.



- The default memory operation frequency is dependent on its Serial Presence Detect (SPD), which is the standard way of accessing information from a memory module. Under the default state, some memory modules for overclocking may operate at a lower frequency than the vendor-marked value.
- For system stability, use a more efficient memory cooling system to support a full memory load.
- Always install DIMMs with the same CAS latency. For optimal compatibility, we recommend that you install memory modules of the same version or date code (D/C) from the same vendor. Check with the retailer to get the correct memory modules.
- Supported memory types, data rate (speed), and number of DRAM modules vary depending on the CPU and memory configuration, for more information please refer to CPU/Memory Support list under the Support tab of product information site or visit <https://www.asus.com/support/>.

### Recommended memory configurations

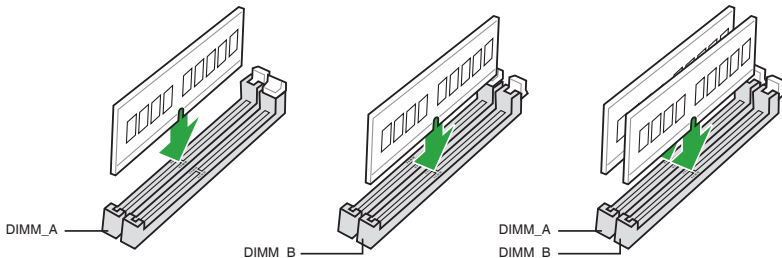

# Installing a DIMM

1

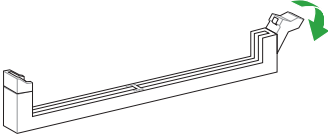

2

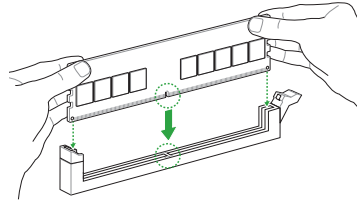

3

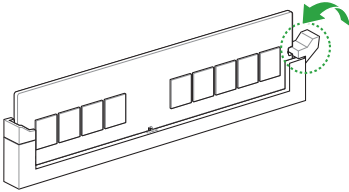

## To remove a DIMM

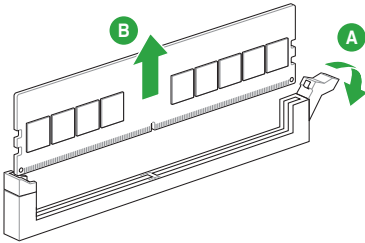

# BIOS Information

# 2

## 2.1 Knowing BIOS



The new ASUS UEFI BIOS is a Unified Extensible Interface that complies with UEFI architecture, offering a user-friendly interface that goes beyond the traditional keyboard-only BIOS controls to enable a more flexible and convenient mouse input. You can easily navigate the new UEFI BIOS with the same smoothness as your operating system. The term "BIOS" in this user guide refers to "UEFI BIOS" unless otherwise specified.

BIOS (Basic Input and Output System) stores system hardware settings such as storage device configuration, overclocking settings, advanced power management, and boot device configuration that are needed for system startup in the motherboard CMOS. In normal circumstances, the default BIOS settings apply to most conditions to ensure optimal performance. **DO NOT change the default BIOS settings** except in the following circumstances:

- An error message appears on the screen during the system bootup and requests you to run the BIOS Setup.
- You have installed a new system component that requires further BIOS settings or update.



Inappropriate BIOS settings may result in instability or boot failure. **We strongly recommend that you change the BIOS settings only with the help of a trained service personnel.**



BIOS settings and options may vary due to different BIOS release versions. Please refer to the latest BIOS version for settings and options.



For more information on BIOS configurations, please refer to <https://www.asus.com/support>, or download the BIOS manual by scanning the code.



## 2.2 BIOS Setup program

Use the BIOS Setup to update the BIOS or configure its parameters. The BIOS screens include navigation keys and brief onscreen help to guide you in using the BIOS Setup program.

### Entering BIOS at startup

To enter BIOS Setup at startup, press <Delete> or <F2> during the Power-On Self Test (POST). If you do not press <Delete> or <F2>, POST continues with its routines.

### Entering BIOS Setup after POST

To enter BIOS Setup after POST:

- Press <Ctrl>+<Alt>+<Delete> simultaneously.
- Press the reset button on the system chassis.
- Press the power button to turn the system off then back on. Do this option only if you failed to enter BIOS Setup using the first two options.

After doing either of the three options, press <Delete> key to enter BIOS.



- 
- Ensure that a USB mouse is connected to your motherboard if you want to use the mouse to control the BIOS setup program.
  - If the system becomes unstable after changing any BIOS setting, load the default settings to ensure system compatibility and stability. Select the **Load Optimized Defaults** item under the **Exit** menu or press hotkey <F5>.
  - If the system fails to boot after changing any BIOS setting, try to clear the CMOS and reset the motherboard to the default value.
  - The BIOS setup program does not support Bluetooth devices.
- 

### BIOS menu screen

The BIOS Setup program can be used under two modes: **EZ Mode** and **Advanced Mode**. You can change modes from **Setup Mode** in **Boot menu** or by pressing the <F7> hotkey.

## 2.3 ASUS EZ Flash 3

The ASUS EZ Flash 3 feature allows you to update the BIOS without using an OS-based utility.



---

Ensure to load the BIOS default settings to ensure system compatibility and stability. Select the **Load Optimized Defaults** item under the **Exit** menu or press hotkey **<F5>**.

---

### To update the BIOS:



- This function can support devices such as a USB flash disk with FAT 32/16 format and single partition only.
  - DO NOT shut down or reset the system while updating the BIOS to prevent system boot failure!
- 

1. Insert the USB flash disk that contains the latest BIOS file to the USB port.
2. Enter the Advanced Mode of the BIOS setup program. Go to the **Tool** menu to select **ASUS EZ Flash 3 Utility** and press **<Enter>**.
3. Press the Left/Right arrow keys to switch to the **Drive** field.
4. Press the Up/Down arrow keys to find the USB flash disk that contains the latest BIOS, and then press **<Enter>**.
5. Press the Left/Right arrow keys to switch to the **Folder** field.
6. Press the Up/Down arrow keys to find the BIOS file, and then press **<Enter>** to perform the BIOS update process. Reboot the system when the update process is done.

## 2.4 ASUS CrashFree BIOS 3

The ASUS CrashFree BIOS 3 utility is an auto recovery tool that allows you to restore the BIOS file when it fails or gets corrupted during the updating process. You can restore a corrupted BIOS file using a USB flash drive that contains the BIOS file.

### Recovering the BIOS

1. Download the latest BIOS version for this motherboard from <https://www.asus.com/support/>.
2. Rename the BIOS file as **ASUS.CAP** or **PH610MK5.CAP** and copy the renamed BIOS file to a USB flash drive.
3. Turn on the system.
4. Insert the USB flash drive containing the BIOS file to a USB port.
5. The utility automatically checks the devices for the BIOS file. When found, the utility reads the BIOS file and enters ASUS EZ Flash 3 automatically.
6. The system requires you to enter BIOS Setup to recover the BIOS setting. To ensure system compatibility and stability, we recommend that you press <F5> to load default BIOS values.



---

DO NOT shut down or reset the system while updating the BIOS! Doing so can cause system boot failure!

---



# Appendix

## Notices

### FCC Compliance Information

Responsible Party: Asus Computer International

Address: 48720 Kato Rd., Fremont, CA 94538, USA

Phone / Fax No: (510)739-3777 / (510)608-4555

This device complies with part 15 of the FCC Rules. Operation is subject to the following two conditions: (1) This device may not cause harmful interference, and (2) this device must accept any interference received, including interference that may cause undesired operation.

This equipment has been tested and found to comply with the limits for a Class B digital device, pursuant to part 15 of the FCC Rules. These limits are designed to provide reasonable protection against harmful interference in a residential installation. This equipment generates, uses and can radiate radio frequency energy and, if not installed and used in accordance with the instructions, may cause harmful interference to radio communications. However, there is no guarantee that interference will not occur in a particular installation. If this equipment does cause harmful interference to radio or television reception, which can be determined by turning the equipment off and on, the user is encouraged to try to correct the interference by one or more of the following measures:

- Reorient or relocate the receiving antenna.
- Increase the separation between the equipment and receiver.
- Connect the equipment into an outlet on a circuit different from that to which the receiver is connected.
- Consult the dealer or an experienced radio/TV technician for help.

### HDMI Trademark Notice

The terms HDMI, HDMI High-Definition Multimedia Interface, HDMI Trade dress, and the HDMI Logo are trademarks or registered trademarks of HDMI Licensing Administrator, Inc.



### Safety Precautions

Accessories that came with this product have been designed and verified for the use in connection with this product. Never use accessories for other products to prevent the risk of electric shock or fire.

#### 安全上のご注意

付属品は当該専用用品です。他の機器には使用しないでください。機器の破損もしくは、火災や感電の原因となることがあります。

## France sorting and recycling information



## Compliance Statement of Innovation, Science and Economic Development Canada (ISED)

This device complies with Innovation, Science and Economic Development Canada licence exempt RSS standard(s). Operation is subject to the following two conditions: (1) this device may not cause interference, and (2) this device must accept any interference, including interference that may cause undesired operation of the device.

CAN ICES-003(B)/NMB-003(B)

## Déclaration de conformité de Innovation, Sciences et Développement économique Canada (ISED)

Le présent appareil est conforme aux CNR d'Innovation, Sciences et Développement économique Canada applicables aux appareils radio exempts de licence. L'exploitation est autorisée aux deux conditions suivantes : (1) l'appareil ne doit pas produire de brouillage, et (2) l'utilisateur de l'appareil doit accepter tout brouillage radioélectrique subi, même si le brouillage est susceptible d'en compromettre le fonctionnement.

CAN ICES-003(B)/NMB-003(B)

## Japan JATE

本製品は電気通信事業者(移动通信会社、固定通信会社、インターネットプロバイダ等)の通信回線(公衆無線LANを含む)に直接接続することができません。本製品をインターネットに接続する場合は、必ずルーター等を経由し接続してください。

## VCCI: Japan Compliance Statement

### Class B ITE

この装置は、クラスB情報技術装置です。この装置は、家庭環境で使用することを目的としていますが、この装置がラジオやテレビジョン受信機に近接して使用されると、受信障害を引き起こすことがあります。

取扱説明書に従って正しい取り扱いをして下さい。

V C C I - B

## KC: Korea Warning Statement

B급 기기 (가정용 방송통신기자재)

이 기기는 가정용(B급) 전자파적합기기로서 주로 가정에서 사용하는 것을 목적으로 하며, 모든 지역에서 사용할 수 있습니다.

## Declaration of compliance for product environmental regulation

ASUS follows the green design concept to design and manufacture our products, and makes sure that each stage of the product life cycle of ASUS product is in line with global environmental regulations. In addition, ASUS disclose the relevant information based on regulation requirements.

Please refer to <http://csr.asus.com/Compliance.htm> for information disclosure based on regulation requirements ASUS is complied with:

### EU REACH and Article 33

Complying with the REACH (Registration, Evaluation, Authorisation, and Restriction of Chemicals) regulatory framework, we published the chemical substances in our products at ASUS REACH website at <http://csr.asus.com/english/REACH.htm>.

### EU RoHS

This product complies with the EU RoHS Directive. For more details, see <http://csr.asus.com/english/article.aspx?id=35>

### India RoHS

This product complies with the “India E-Waste (Management) Rules, 2016” and prohibits use of lead, mercury, hexavalent chromium, polybrominated biphenyls (PBBs) and polybrominated diphenyl ethers (PBDEs) in concentrations exceeding 0.1% by weight in homogenous materials and 0.01% by weight in homogenous materials for cadmium, except for the exemptions listed in Schedule II of the Rule.

### Vietnam RoHS

ASUS products sold in Vietnam, on or after September 23, 2011, meet the requirements of the Vietnam Circular 30/2011/TT-BCT.

Các sản phẩm ASUS bán tại Việt Nam, vào ngày 23 tháng 9 năm 2011 trở về sau, đều phải đáp ứng các yêu cầu của Thông tư 30/2011/TT-BCT của Việt Nam.

### Türkiye RoHS

AEEE Yönetmeliğine Uygundur

### ASUS Recycling/Takeback Services

ASUS recycling and takeback programs come from our commitment to the highest standards for protecting our environment. We believe in providing solutions for you to be able to responsibly recycle our products, batteries, other components as well as the packaging materials. Please go to <http://csr.asus.com/english/Takeback.htm> for detailed recycling information in different regions.



---

DO NOT throw the motherboard in municipal waste. This product has been designed to enable proper reuse of parts and recycling. This symbol of the crossed out wheeled bin indicates that the product (electrical and electronic equipment) should not be placed in municipal waste. Check local regulations for disposal of electronic products.

---



---

DO NOT throw the mercury-containing button cell battery in municipal waste. This symbol of the crossed out wheeled bin indicates that the battery should not be placed in municipal waste.

---

## Simplified UKCA Declaration of Conformity

ASUSTeK Computer Inc. hereby declares that this device is in compliance with the essential requirements and other relevant provisions of related UKCA Directives. Full text of UKCA declaration of conformity is available at: [www.asus.com/support](http://www.asus.com/support).

## Simplified EU Declaration of Conformity

**English** ASUSTeK Computer Inc. hereby declares that this device is in compliance with the essential requirements and other relevant provisions of related Directives. Full text of EU declaration of conformity is available at: [www.asus.com/support](http://www.asus.com/support).

**Français** ASUSTeK Computer Inc. déclare par la présente que cet appareil est conforme aux critères essentiels et autres clauses pertinentes des directives concernées. La déclaration de conformité de l'UE peut être téléchargée à partir du site Internet suivant: [www.asus.com/support](http://www.asus.com/support).

**Deutsch** ASUSTeK Computer Inc. erklärt hiermit, dass dieses Gerät mit den wesentlichen Anforderungen und anderen relevanten Bestimmungen der zugehörigen Richtlinien übereinstimmt. Der gesamte Text der EU-Konformitätserklärung ist verfügbar unter: [www.asus.com/support](http://www.asus.com/support).

**Italiano** ASUSTeK Computer Inc. con la presente dichiara che questo dispositivo è conforme ai requisiti essenziali e alle altre disposizioni pertinenti con le direttive correlate. Il testo completo della dichiarazione di conformità UE è disponibile all'indirizzo: [www.asus.com/support](http://www.asus.com/support).

**Русский** Компания ASUS заявляет, что это устройство соответствует основным требованиям и другим соответствующим условиям соответствующих директив. Подробную информацию, пожалуйста, смотрите на [www.asus.com/support](http://www.asus.com/support).

**Български** С настоящото ASUSTeK Computer Inc. декларира, че това устройство е в съответствие със съществените изисквания и другите приложими постановления на свързаните директиви. Пълният текст на декларацията за съответствие на ЕС е достъпен на адрес: [www.asus.com/support](http://www.asus.com/support).

**Hrvatski** ASUSTeK Computer Inc. ovom izjavljuju da je ovaj uređaj sukladan s bitnim zahtjevima i ostalim odgovarajućim odredbama vezanih direktiva. Cijeli tekst EU izjave o sukladnosti dostupan je na: [www.asus.com/support](http://www.asus.com/support).

**Čeština** Společnost ASUSTeK Computer Inc. tímto prohlašuje, že toto zařízení splňuje základní požadavky a další příslušná ustanovení souvisejících směrnic. Plné znění prohlášení o shodě EU je k dispozici na adrese: [www.asus.com/support](http://www.asus.com/support).

**Dansk** ASUSTeK Computer Inc. erklærer hermed, at denne enhed er i overensstemmelse med hovedkravene og andre relevante bestemmelser i de relaterede direktiver. Hele EU-overensstemmelseserklæringen kan findes på: [www.asus.com/support](http://www.asus.com/support).

**Nederlands** ASUSTeK Computer Inc. verklaart hierbij dat dit apparaat voldoet aan de essentiële vereisten en andere relevante bepalingen van de verwante richtlijnen. De volledige tekst van de EU-verklaring van conformiteit is beschikbaar op: [www.asus.com/support](http://www.asus.com/support).

**Eesti** Käesolevaga kinnitab ASUSTeK Computer Inc. et see seade vastab asjakohaste direktiivide olulistele nõuetele ja teistele asjassepuutuvatele sätetele. EL vastavusdeklaratsiooni täielik tekst on saadaval järgmisel aadressil: [www.asus.com/support](http://www.asus.com/support).

**Suomi** ASUSTeK Computer Inc. ilmoittaa täten, että tämä laite on asiaankuuluvien direktiivien olennaisten vaatimusten ja muiden tätä koskevien säädösten mukainen. EU-yhdenmukaisuusilmoituksen koko teksti on luettavissa osoitteessa: [www.asus.com/support](http://www.asus.com/support).

**Ελληνικά** Με το παρόν, η AsusTeK Computer Inc. δηλώνει ότι αυτή η συσκευή συμμορφώνεται με τις θεμελιώδεις απαιτήσεις και άλλες σχετικές διατάξεις των Οδηγιών της ΕΕ. Το πλήρες κείμενο της δήλωσης συμμορφότητας είναι διαθέσιμο στη διεύθυνση: [www.asus.com/support](http://www.asus.com/support).

**Magyar** Az ASUSTeK Computer Inc. ezennel kijelenti, hogy ez az eszköz megfelel a kapcsolódó irányelvek lényeges követelményeinek és egyéb vonatkozó rendelkezéseinek. Az EU megfeleléségi nyilatkozat teljes szövege innen letölthető: [www.asus.com/support](http://www.asus.com/support).

**Latviski** ASUSTeK Computer Inc. ar šo paziņo, ka šis ierīcenis atbilst Direktīvu būtiskajām prasībām un citiem citiem saistošajiem nosacījumiem. Pilns ES atbilstības paziņojuma teksts pieejams šeit: [www.asus.com/support](http://www.asus.com/support).

**Lietuviai** „ASUSTEK Computer Inc.“ šiuo tvirtina, kad šis įrenginys atitinka pagrindinius reikalavimus ir kitas svarbias susijusių direktyvų nuostatas. Visą ES atitikties deklaracijos tekstą galima rasti: [www.asus.com/support](http://www.asus.com/support).

**Norsk** ASUSTeK Computer Inc. erklærer herved at denne enheten er i samsvar med hovedsaklige krav og andre relevante forskrifter i relaterte direktiver. Fullstendig tekst for EU-samsvarserklæringen finnes på: [www.asus.com/support](http://www.asus.com/support).

**Polski** Firma ASUSTeK Computer Inc. niniejszym oświadcza, że urządzenie to jest zgodne z zasadniczymi wymogami i innymi właściwymi postanowieniami powiązanych dyrektyw. Pełny tekst deklaracji zgodności UE jest dostępny pod adresem: [www.asus.com/support](http://www.asus.com/support).

**Português** A ASUSTEK Computer Inc. declara que este dispositivo está em conformidade com os requisitos essenciais e outras disposições relevantes das Diretivas relacionadas. Texto integral da declaração da UE disponível em: [www.asus.com/support](http://www.asus.com/support).

**Română** ASUSTEK Computer Inc. declară că acest dispozitiv se conformează cerințelor esențiale și altor prevederi relevante ale directivelor conexe. Textul complet al declarației de conformitate a Uniunii Europene se găsește la: [www.asus.com/support](http://www.asus.com/support).

**Srpski** ASUSTEK Computer Inc. ovom izjavljuju da je ovaj uređaj u saglasnosti sa osnovnim zahtjevima i drugim relevantnim odredbama povezanih Direktiva. Pun tekst EU deklaracije o usaglasnosti je dostupan da adresi: [www.asus.com/support](http://www.asus.com/support).

**Slovensky** Spoločnosť ASUSTEK Computer Inc. týmto vyhlasuje, že toto zariadenie vyhovuje základným požiadavkám a ostatým príslušným ustanoveniam príslušných smerníc. Celý text vyhlásenia o zhode pre štáty EÚ je dostupný na adrese: [www.asus.com/support](http://www.asus.com/support).

**Slovenščina** ASUSTEK Computer Inc. izjavlja, da je ta naprava skladna z bistvenimi zahtevami in drugimi ustreznimi določbami povezanih direktiv. Celotno besedilo EU-izjave o skladnosti je na voljo na spletnem mestu: [www.asus.com/support](http://www.asus.com/support).

**Español** Por la presente, ASUSTEK Computer Inc. declara que este dispositivo cumple los requisitos básicos y otras disposiciones pertinentes de las directivas relacionadas. El texto completo de la declaración de la UE de conformidad está disponible en: [www.asus.com/support](http://www.asus.com/support).

**Svenska** ASUSTEK Computer Inc. förklarar härmed att denna enhet överensstämmer med de grundläggande kraven och andra relevanta föreskrifter i relaterade direktiv. Fulltext av EU-försäkran om överensstämmelse finns på: [www.asus.com/support](http://www.asus.com/support).

**Українська** ASUSTEK Computer Inc. заявляє, що цей пристрій відповідає основним вимогам та іншим відповідним положенням відповідних Директив. Повний текст декларації відповідності стандартам CE доступний на: [www.asus.com/support](http://www.asus.com/support).

**Türkçe** AsusTeK Computer Inc., bu aygıtın temel gereksinimlerle ve ilişkili Yönergelerin diğer ilgili koşullarına uyumlu olduğunu beyan eder. AB uygunluk bildirimini tam metni şu adreste bulabilirsiniz: [www.asus.com/support](http://www.asus.com/support).

**Bosanski** ASUSTEK Computer Inc. ovom izjavljuju da je ovaj uređaj uskladan sa bitnim zahtjevima i ostalim odgovarajućim odredbama vezanih direktiva. Cijeli tekst EU izjave o uskladenosti dostupan je na: [www.asus.com/support](http://www.asus.com/support).

# Warranty

## EN: ASUS Guarantee Information

- ASUS offers a voluntary manufacturer's Commercial Guarantee.
- ASUS reserves the right to interpret the provisions of the ASUS Commercial Guarantee.
- This ASUS Commercial Guarantee is provided independently and in addition to the statutory Legal Guarantee and in no way affects or limits the rights under the Legal Guarantee.

For all the guarantee information, please visit <https://www.asus.com/support>.

## F: Garantie ASUS

- ASUS fournit une garantie commerciale en tant que garantie volontaire du fabricant.
- ASUS se réserve le droit d'interpréter et de clarifier les informations relatives à la garantie commerciale ASUS.
- Cette garantie commerciale ASUS est fournie indépendamment et parallèlement à la garantie légale, elle n'affecte ou ne limite d'aucune façon les droits acquis par la garantie légale.

Pour plus d'informations sur la garantie, consultez le site <https://www.asus.com/fr/support/>.

## G: ASUS Garantieinformationen

- ASUS bietet eine freiwillige Warengarantie des Herstellers an.
- ASUS behält sich das Recht zur Auslegung der Bestimmungen in der ASUS Warengarantie vor.
- Diese ASUS Warengarantie wird unabhängig und zusätzlich zur rechtmäßigen gesetzlichen Garantie gewährt und beeinträchtigt oder beschränkt in keiner Weise die Rechte aus der gesetzlichen Garantie.

Die vollständigen Garantieinformationen finden Sie unter <https://www.asus.com/de/support/>.

## I: Informativa sulla Garanzia ASUS

- ASUS offre una Garanzia Commerciale volontaria del produttore.
- ASUS si riserva il diritto di interpretare le disposizioni della Garanzia Commerciale ASUS.
- La presente Garanzia Commerciale ASUS viene fornita in modo indipendente e in aggiunta alla Garanzia Legale prevista per legge e non pregiudica o limita in alcun modo i diritti previsti dalla Garanzia Legale.

Per tutte le informazioni sulla garanzia, visitare <https://www.asus.com/it/support>.

## R: Информация о гарантии ASUS

- ASUS предлагает добровольную гарантию от производителя.
- ASUS оставляет за собой право интерпретирования положений гарантии ASUS.
- Настоящая гарантия ASUS никоим образом не ограничивает Ваши права, предусмотренные локальным законодательством.

Для получения полной информации о гарантии посетите <https://www.asus.com/ru/support/>.

## DA: ASUS garantioplysninger

- ASUS tilbyder en valgfri handelsmæssig garanti.
- ASUS forbeholder sig retten til at fortolke bestemmelserne i ASUS' handelsmæssige garanti.
- Denne handelsmæssige garanti fra ASUS tilbydes uafhængigt, og den er tilføjet til den lovbestemte juridiske garanti og den påvirker eller begrænser på ingen måde rettighederne i den juridiske garanti.

Alle garantioplysningerne kan findes på <https://www.asus.com/dk/support/>.

## BG: Информация за гаранцията от ASUS

- ASUS предлага доброволна търговска гаранция от производителя.
- ASUS си запазва правото да тълкува условията на търговската гаранция на ASUS.
- Тази търговска гаранция на ASUS се предлага независимо от и в допълнение на законната гаранция. Тя по никакъв начин не оказва влияние върху правата на потребителя в законната гаранция и по никакъв начин не ги ограничава.

За цялостна информация относно гаранцията, моля, посетете <https://www.asus.com/support>.

## CZ: Informace o záruce společnosti ASUS

- Společnost ASUS nabízí dobrovolnou komerční záruku výrobce.
- Společnost ASUS si vyhrazuje právo vykládat ustanovení komerční záruky společnosti ASUS.
- Tato komerční záruka společnosti ASUS je poskytována nezávisle a jako doplněk zákonné záruky a žádným způsobem neovlivňuje ani neomezuje práva vyplývající ze zákonné záruky.

Všechny informace o záruce najdete na adrese <https://www.asus.com/cz/support/>.

## CR: Informacije o ASUS jamstvu

- ASUS dragovoljno nudi komercijalno proizvođačko jamstvo.
- ASUS zadržava prava na tumačenje odredbi ASUS komercijalnog jamstva.
- Ovo ASUS komercijalno jamstvo daje se neovisno i kao dodatak zakonskom jamstvu i ni na koji način ne ograničuje prava iz okvira zakonskog jamstva.

Sve informacije o jamstvu potražite na <https://www.asus.com/support>.

## DU: ASUS-garantie-informatie

- SUS biedt een vrijwillige commerciële garantie van de fabrikant.
- ASUS behoudt zich het recht voor om de bepalingen van de commerciële garantie van ASUS uit te leggen.
- Deze commerciële garantie van ASUS wordt onafhankelijk en als aanvulling op de statutaire Wettelijke garantie geboden en beïnvloedt of beperkt in geen geval de rechten onder de wettelijke garantie.

Voor alle informatie over de garantie, gaat u naar <https://www.asus.com/nl/support/>.

## EE: Teave ASUS-e garantii kohta

- ASUS pakub vabatahtlikku tasulist tootjagarantii.
- ASUS jätab endale õiguse tõlgendada ASUS-e tasulise garantii tingimusi.
- See ASUS-e tasuline garantii on sõltumatu lisagarantii seadusega kehtestatud garantii ega mõjuta mingil määral seadusega kehtestatud garantii ning seadusega kehtestatud garantii piiranguid.

Vaadake garantiiga seotud teavet veebisaidil <https://www.asus.com/ee/>.

## GK: Πληροφορίες εγγύησης ASUS

- H ASUS προσφέρει μια εθελοντική Εμπορική εγγύηση κατασκευαστή.
- H ASUS διατηρεί το δικαίωμα ερμηνείας των διατάξεων της Εμπορικής εγγύησης ASUS.
- Αυτή η Εμπορική εγγύηση ASUS παρέχεται ανεξάρτητα και επιπροσθέτως της θεσμικής Νομικής εγγύησης και δε καμία περίπτωση δεν επηρεάζει ή περιορίζει τα δικαιώματα βάσει της Νομικής εγγύησης.

Για όλες τις πληροφορίες εγγύησης, επισκεφθείτε τη διεύθυνση <https://www.asus.com/gr-ee/>.

## HUG: ASUS garanciális információk

- Az ASUS önkéntes gyártói kereskedelmi garanciát kínál.
- Az ASUS fenntartja magának a jogot, hogy értelmezze az ASUS kereskedelmi garanciára vonatkozó rendelkezéseket.
- Ezt a kereskedelmi garanciát az ASUS függetlenül és a törvényes garancia mellett nyújtja és semmilyen módon nem befolyásolja, vagy korlátozza a jogi garancia nyújtotta jogokat.

A garanciára vonatkozó teljes körű információért látogasson el a <https://www.asus.com/hu/support/oldalra>.

## LV: ASUS garantijas informācija

- ASUS piedāvā brīvprātīgu ražotāja komerciālo garantiju.
- ASUS patur tiesības interpretēt ASUS komerciālās garantijas noteikumus.
- Šī ASUS komerciālā garantija tiek piedāvāta neatkarīgi un tā nekādā veidā neietekmē vai neierobežo juridiskajai garantijai noteiktās tiesības.

Lai iegūtu informāciju par garantiju, apmeklējiet vietni <https://www.asus.com/lv/>.

## LT: Informacija apie ASUS garantiją

- ASUS siūlo savanorišką komercinę gamintojo garantiją.
- ASUS pasilieka teisę savo nuožūra aiškinti šios komercinės ASUS garantijos nuostatas.
- Ši komercinė ASUS garantija suteikiama nepriklausoma, be įstatyminės teisinės garantijos, ir jokiu būdu nepaveikia ar neapriboja teisinės garantijos suteikiami teisę.

Norėdami gauti visą informaciją apie garantiją, apsilankykite <https://www.asus.com/lt/>.

## PL: Informacje o gwarancji firmy ASUS

- Firma ASUS oferuje dobrowolną gwarancję handlową producenta.
- Firma ASUS zastrzega sobie prawo do interpretacji warunków gwarancji handlowej firmy ASUS.
- Niniejsza gwarancja handlowa firmy ASUS jest udzielana niezależnie, jako dodatek do wymaganej ustawowo gwarancji prawnej i w żaden sposób nie wpływa na prawa przysługujące na mocy gwarancji prawnej ani ich nie ogranicza.

Wszelkie informacje na temat gwarancji można znaleźć na stronie <https://www.asus.com/pl/support>.

**PG: Informações de Garantia ASUS**

- A ASUS oferece uma Garantia Comercial voluntária do fabricante.
- A ASUS reserva o direito de interpretar as disposições da Garantia Comercial da ASUS.
- Esta Garantia Comercial da ASUS é fornecida de forma independente além da Garantia Legal estatutária e não afeta nem limita de qualquer forma os direitos estabelecidos na Garantia Legal.

Para consultar todas as informações sobre a garantia, visite <https://www.asus.com/pl/support/>.

**RO: Informații despre garanția ASUS**

- ASUS oferă o garanție comercială voluntară a producătorului.
- ASUS își rezervă dreptul de a interpreta prevederile garanției comerciale ASUS.
- Această garanție comercială ASUS este oferită independent și în plus față de garanția obligatorie legală și nu afectează sau limitează în niciun fel drepturile acordate conform garanției legale.

Pentru toate informațiile legate de garanție, vizitați <https://www.asus.com/ro/support/>.

**SL: Informacije o garanciji ASUS**

- ASUS ponuja prostovoljno tržno garancijo proizvajalca.
- ASUS si pridružuje pravico do razlage določb tržne garancije družbe ASUS.
- Ta tržna garancija družbe ASUS je na voljo neodvisno in kot dodatek zakonsko predpisani pravni garanciji ter na noben način ne vpliva na pravice, ki jih zagotavlja pravna garancija, oziroma jih omejuje.

Vse informacije o garanciji najdete na spletnem mestu <https://www.asus.com/sk/support/>.

**SK: Informácie o záruke ASUS**

- ASUS ponúka dobrovoľnú obchodnú záruku výrobcu.
- ASUS si vyhradzuje právo interpretovať ustanovenia obchodnej záruky ASUS.
- Táto obchodná záruka ASUS je poskytnutá nezávisle a navyše k zákonnej záruke a v ziadnom prípade neovplyvňuje ani neobmedzuje tieto práva podľa tejto zákonnej záruky.

Všetky ďalšie informácie o záruke nájdete na <https://www.asus.com/sk/support/>.

**ES: Información de garantía de ASUS**

- ASUS ofrece una garantía comercial voluntaria del fabricante.
- ASUS se reserva el derecho de interpretar las disposiciones de esta garantía comercial de ASUS.
- Esta garantía comercial de ASUS se proporciona de forma independiente y adicional a la garantía estatutaria y de ninguna manera afecta a los derechos bajo la garantía legal ni los limita.

Para obtener toda la información sobre la garantía, visite <https://www.asus.com/ES/support/>.

**TR: ASUS Garanti Bilgileri**

- ASUS, gönüllü olarak üçüncü Ticari Garantisi sunar.
- ASUS, ASUS Ticari Garantisinin hükümlerini yorumlama hakkını saklı tutar.
- Bu ASUS Ticari Garantisi, bağımsız olarak ve hukuki Yasal Garanti'ye ek olarak sağlanır ve hiçbir şekilde Yasal Garanti kapsamındaki hakları etkilemez veya sınırlamaz.

Tüm garanti bilgileri için lütfen <https://www.asus.com/tr/support/> adresini ziyaret edin.

**FI: ASUS-takuutiedot**

- ASUS tarjoaa vapaaehtoisien valmistajan kaupallisen takuun.
- ASUS pidättää oikeuden tulkita ASUS-kaupallisen takuun ehdot.
- Tämä ASUS-kaupallinen takuu tarjotaan itsenäisesti lakisääteisten oikeudellisten takuun lisäksi eikä se vaikuta millään tavoin laillisen takuun oikeuksiin tai rajoita niitä.

Saadaksesi kaikki takuutiedot, siirry osoitteeseen <https://www.asus.com/fi/support/>.

**NW: Informasjon om ASUS-garanti**

- ASUS tilbyr som produsent en frivillig kommersiell garanti.
- ASUS forbeholder seg retten til å tolke bestemmelsene i ASUS sin kommersielle garanti.
- ASUS sin kommersielle garanti gir uavhengig og i tillegg til den lovbestemte juridiske garantien, og verken påvirker eller begrenser rettighetene under den juridiske garantien på noen måte.

Du finner fullstendig informasjon om garantii på <https://www.asus.com/no/support/>.

**SB: Informacije o ASUS garanciji**

- ASUS nudi dobrovoljnu proizvođačku komercijalnu garanciju.
- ASUS zadržava pravo da tumači odredbe svoje ASUS komercijalne garancije.
- Ova ASUS komercijalna garancija daje se nezavisno, kao dodatak zakonskoj pravnoj garanciji, i ni ka koji način ne utiče na i ne ograničava prava data pravnom garancijom.

Za sve informacije o garanciji, posetite <https://www.asus.com/support/>.

**SW: ASUS garantiinformation**

- ASUS erbjuder en frivillig kommersiell tillverkningssgaranti.
- ASUS förbehåller sig rätten att tolka bestämmelserna i ASUS kommersiella garanti.
- Denna kommersiella garanti från ASUS tillhandahålls separat och som tillägg till den lagstadgade garantin, och påverkar eller begränsar på intet sätt rättsigheterna under den lagstadgade garantin.

För all garantiinformation, besök <https://www.asus.com/se/support/>.

**UA: Інформація про Гарантію ASUS**

- ASUS пропонує добровільну Комерційну Гарантію виробника.
- ASUS застерігає за собою право тлумачити положення Комерційної Гарантії ASUS.
- Цю Комерційну Гарантію надано незалежно і на додаток до обов'язкової Законної Гарантії; вона жодним чином не впливає на права за Законовою Гарантією і не обмежує їх.

Всю інформацію про гарантію подано тут: <https://www.asus.com/ua/support/>.

**MX: Garantía y Soporte**

Esta Garantía aplica en el país de compra. Usted acepta que en esta garantía:

- Los procedimientos de servicio pueden variar en función del país.
- Algunos servicios y/o piezas de reemplazo pueden no estar disponibles en todos los países.
- Algunos países pueden tener tarifas y restricciones que se apliquen en el momento de realizar el servicio, visite el sitio de soporte de ASUS en <https://www.asus.com/mx/support/> para ver más detalles.
- Si tiene alguna queja o necesidad de un centro de reparación local o el periodo de garantía del producto ASUS, por favor visite el sitio de Soporte de ASUS en <https://www.asus.com/mx/support/> para mayores detalles.

**Información de contacto ASUS**

Esta garantía está respaldada por:  
ASUSTeK Computer Inc.  
Centro de Atención ASUS +52 (55) 1496-3663

**BP: Informações de garantia ASUS**

Esta garantia aplica-se ao período definido pela garantia legal (90 dias) mais o período de garantia comercial oferecido pela ASUS. Por exemplo: 12M significa 12 meses de garantia no total (3 meses de garantia legal mais 9 meses de garantia contratual), 24 meses significa 24 meses de garantia no total (3 meses de garantia legal mais 21 meses de garantia contratual) e 36 meses significa 36 meses de garantia no total (3 meses de garantia legal e 33 de garantia contratual) a contar da data da garantia declarada (Data de Início da Garantia).

Para todas as informações de garantia, visite <https://www.asus.com/br/support/>.

**ID: Informasi Garansi ASUS**

Garansi ini berlaku di negara tempat pembelian.

Periode Garansi tertera pada kemasan/kotak dari Produk dan Masa Garansi dimulai sejak tanggal pembelian Produk ASUS dengan kondisi baru.

Silahkan pindai Kode QR di bagian bawah halaman terakhir untuk Kartu Garansi versi Web dalam format PDF untuk lebih informasi jelas mengenai jaminan garansi Produk ASUS.

- Informasi Dukungan ASUS, silakan kunjungi <https://www.asus.com/id/support/>.
- Informasi Lokasi Layanan, silakan kunjungi <https://www.asus.com/id/support/Service-Center/Indonesia>.
- Layanan Call Center: 1500128

**Vì: Thông tin đảm bảo của ASUS**

- ASUS cung cấp Bảo hành thương mại tự nguyện của Nhà sản xuất.
- ASUS bảo lưu quyền giải thích các điều khoản của Bảo hành thương mại của ASUS.
- Bảo hành thương mại này của ASUS được cung cấp độc lập và ngoài Bảo đảm pháp lý theo luật định và không có cách nào ảnh hưởng đến hoặc giới hạn các quyền theo Bảo hành pháp lý. Để biết chi tiết các thông tin bảo hành, vui lòng truy cập <https://www.asus.com/vn/support/>.



## **ASUS contact information**

### **ASUSTeK COMPUTER INC.**

Address: 1F., No. 15, Lide Rd., Beitou Dist., Taipei City 112

### **ASUS COMPUTER INTERNATIONAL (America)**

Address: 48720 Kato Rd., Fremont, CA 94538, USA

### **ASUS COMPUTER GmbH (Germany and Austria)**

Address: Harkortstrasse 21-23, 40880 Ratingen, Germany

### **ASUSTeK (UK) LIMITED**

Address: 1st Floor, Sackville House, 143-149 Fenchurch Street, London, EC3M 6BL,  
England, United Kingdom

## **Service and Support**

Visit our multi-language website at <https://www.asus.com/support/>.

