

E15521
June 2019
First Edition

ASUS VivoWatch™ BP

HC-A04 / HC-A04A
User Manual



Android App



iOS App

Table of Contents

Introduction.....	4
About this manual.....	5
Conventions used in this manual.....	6
Typography.....	6
Safety precautions.....	7
Battery precautions.....	9

Chapter 1: Getting started

Getting to know your ASUS VivoWatch BP	12
Electrode	14
PPG (Photoplethysmogram) sensor	14
Touch screen display panel	14
Home button	15
Strap (Medical grade silicone)	15
Charging connectors (Input: 5Vdc, 0.5A).....	15
Charging your ASUS VivoWatch BP	16

Chapter 2: Using your ASUS VivoWatch BP

Installing the companion app.....	20
Pairing for the first time.....	21
Pairing with another device or pairing again	22

Navigating your ASUS VivoWatch BP	24
Unlocking your ASUS VivoWatch BP	24
Scrolling through ASUS VivoWatch BP features.....	25
Viewing more information for the selected feature	26
ASUS VivoWatch BP features.....	27
Home screen	27
Measuring screen.....	28
Heart rate screen.....	30
Settings.....	31
Activities screen.....	32
Exercise screen	33
Notifications	35
Reminders	35
Updating your ASUS VivoWatch BP.....	36
Updating through the ASUS HealthConnect App	36

Appendices

Introduction

Thank you for purchasing the ASUS VivoWatch BP! ASUS VivoWatch BP is the world's first wearable device that packs ASUS HealthAI technology and some fitness functions with all the benefits of being accurate, smart, and compact. Please fill in the following information for future reference:

DATE PURCHASED: _____

SERIAL NUMBER: _____

Staple your receipt here

Register your product at https://account.asus.com/product_reg.aspx

About this manual

This manual provides information about the hardware and software features of your ASUS VivoWatch BP, organized through the following chapters:

Chapter 1: Getting started

This chapter details the hardware components of your ASUS VivoWatch BP and shows you how to use the different parts of your ASUS VivoWatch BP.

Chapter 2: Using your ASUS VivoWatch BP

This chapter provides an overview of using your ASUS VivoWatch BP.

Appendix

This section includes notices for your ASUS VivoWatch BP.



Read all of the information in the instruction manual and any other literature in the box before operating the device. For the full manual version of your ASUS VivoWatch BP, visit our multi-language web site at:

https://www.asus.com/VivoWatch/ASUS-VivoWatch-BP-HC-A04/HelpDesk_Manual/ or

https://www.asus.com/VivoWatch/ASUS-VivoWatch-BP-HC-A04A/HelpDesk_Manual/.

Conventions used in this manual

To highlight key information in this manual, some text are presented as follows:



This message contains vital information that must be followed to complete a task.



This message contains additional information and tips that can help complete tasks.



This message contains important information that must be followed to keep you safe while performing tasks and prevent damage to your ASUS VivoWatch BP's data and components.

Typography

Bold = This indicates a menu or an item that must be selected.

Italic = This indicates sections that you can refer to in this user guide.

Safety precautions

- The ASUS VivoWatch BP and the charging dock must be recycled or disposed of properly.
- Keep any small components away from children.
- Your ASUS VivoWatch BP should only be used in environments with ambient temperatures between 5°C and 40°C, and stored in environments with ambient temperatures between -20°C and 45°C.
- DO NOT leave your ASUS VivoWatch BP in a hot car. Temperatures in a parked car on sunny days can exceed the recommended ambient temperatures.
- Some people may experience irritations to certain materials used in jewelry, watches, and other wearable items that are in prolonged contact with their skin. This can be due to allergies, environmental factors, extended exposure to irritants like soap, sweat, or other causes.
- You may be more likely to experience irritation from any wearable device if you have allergies or other sensitivities.
- If you have known skin sensitivities, please take special care when wearing your ASUS VivoWatch BP.
- You may be more likely to experience irritation from your ASUS VivoWatch BP if you wear it too tightly.
- Remove your ASUS VivoWatch BP periodically to allow your skin to breathe.

- Keeping your ASUS VivoWatch BP and the strap clean and dry will reduce the possibility of skin irritation.
- If you experience redness, swelling, itchiness, or any other irritation or discomfort on your skin around, or beneath, your ASUS VivoWatch BP, please remove your ASUS VivoWatch BP and consult your physician before resuming wear.
- Continued use, even after symptoms subside, may result in renewed or increased irritation.



- *The ASUS VivoWatch BP is not a medical device and makes no medical claims. It is not intended to diagnose health conditions. The measurement results are only for your reference.*
- *DO NOT adjust medication based on the measurement results from the ASUS VivoWatch BP. Take medication as prescribed by your physician. Only a physician is qualified to diagnose and treat the disease.*

Battery precautions

- Do not dispose of in fire.
- Never attempt to short-circuit the battery.
- Never attempt to disassemble and reassemble the battery.
- Discontinue usage if leakage is found.

1

Getting started

Getting to know your ASUS VivoWatch BP

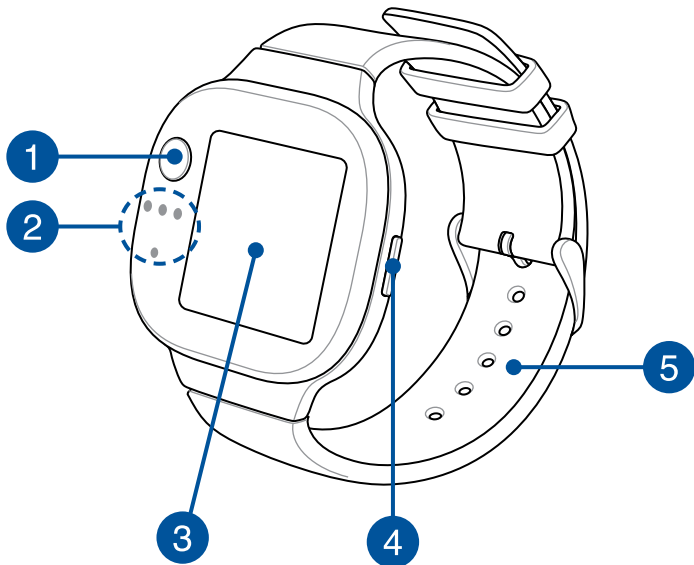

- *Your ASUS VivoWatch BP can be used as a standalone device for measurements and time adjustments.*
- *Download and install the companion app for a complete overview of your health data. For more details, refer to the *Installing the companion app* section in this manual.*

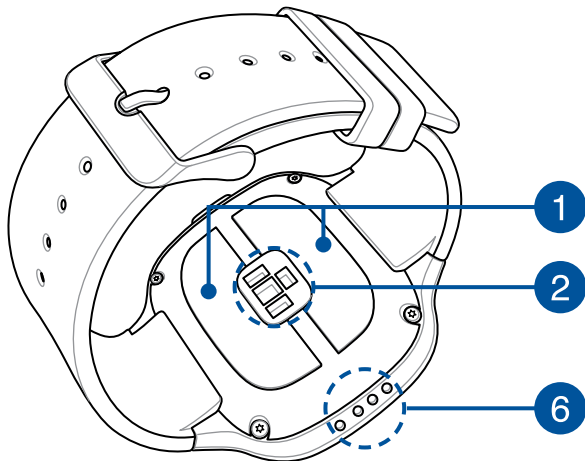

- *ASUS VivoWatch BP complies with IP67 for dust and water-resistant. Suitable for splashes, rain, snow, or showering. Not suitable for swimming, diving, snorkeling, scuba diving, or high speed watersports.*
- *DO NOT use your ASUS VivoWatch BP in liquids with chemicals or salt water (such as sea water, swimming pools, or hot springs) as it may damage the charging connectors. If your ASUS VivoWatch BP has been in contact with the mentioned liquids, ensure to thoroughly rinse the connectors with fresh water and dry it with a clean cloth to prevent corrosion.*

1

Electrode

This electrode works in conjunction with the PPG sensor to allow you to measure your heart rate and health data.



For more details, refer to the Using your ASUS VivoWatch BP section in this manual.

2

PPG (Photoplethysmogram) sensor

This sensor works in conjunction with the electrode to allow you to measure your health data. This sensor also allows you to measure your heart rates.



For more details, refer to the Using your ASUS VivoWatch BP section in this manual.

3

Touch screen display panel

Use the touch screen display panel to operate your ASUS VivoWatch BP using gestures.



For more details, refer to the Using your ASUS VivoWatch BP section in this manual.

4

Home button

Press this button on your ASUS VivoWatch BP to return to the home screen. You can also press this button to unlock your ASUS VivoWatch BP or enable other functions.

Press and hold this button for two (2) seconds to power on your ASUS VivoWatch BP, or press and hold this button for fifteen (15) seconds to power off your ASUS VivoWatch BP.



To prevent data lost, ensure to upload your data before powering off your ASUS VivoWatch BP.

5

Strap (Medical grade silicone)

The strap allows you to wear your ASUS VivoWatch BP on your wrist.

6

Charging connectors (Input: 5Vdc, 0.5A)

Align and connect these charging connectors to the charging connectors on your charging dock to charge the battery of your ASUS VivoWatch BP.

Charging your ASUS VivoWatch BP

1. Align and place the charging connectors on your ASUS VivoWatch BP onto the charging connectors in the charging dock.

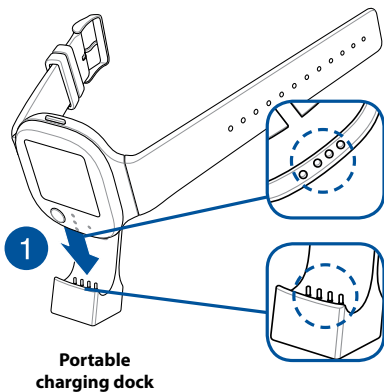
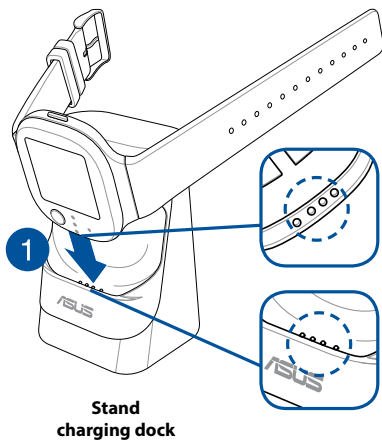

The stand charging dock comes bundled with the HC-A04 and HC-A04A models, and the portable charging dock comes bundled with the HC-A04A model only.



- *Ensure that the charging connectors are clean and dry before charging.*

2. Gently push your ASUS VivoWatch BP so that it is firmly seated inside the charging dock.

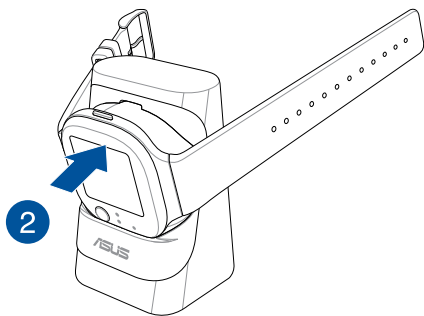

**Stand
charging dock**

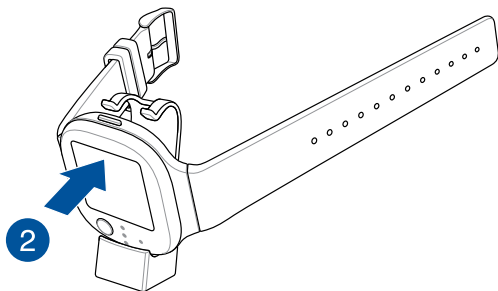

**Portable
charging dock**

3. Connect the USB cable to the charging dock, then connect the USB cable to a power source to start charging.

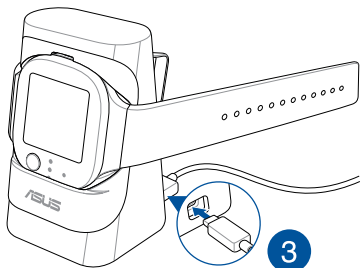

**Stand
charging dock**

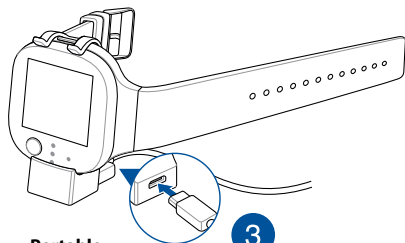

**Portable
charging dock**



Your ASUS VivoWatch BP automatically powers on when fully charged.



- *Connecting the USB cable improperly may cause serious damage to the ASUS VivoWatch BP. Any damage caused by misuse is not covered by the warranty.*
- *Do not short circuit the charging connectors on the dock.*
- *Some power banks can not detect low current devices, and will therefore not be able to charge the ASUS VivoWatch BP.*

2

Using your ASUS VivoWatch BP

Installing the companion app

Pair your ASUS VivoWatch BP with the companion app to take advantage of all its features, such as activity data, pill reminders, path tracking, message and call notifications, and sleep and health recommendations.

1. On your phone, log in or sign up for a Google account or Apple ID.
2. Launch **Play Store** or **App Store**.



3. Search for **ASUS HealthConnect App**, then install the companion app.

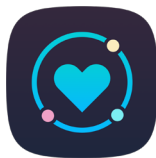

Pairing for the first time



- Turn on the Bluetooth of your phone before pairing.
- Ensure that the ASUS VivoWatch BP is within three meters from your phone.

1. Press and hold the home button for two (2) seconds to power on your ASUS VivoWatch BP.
2. Launch the **ASUS HealthConnect App**.
3. Follow the onscreen instructions on your phone and ASUS VivoWatch BP to complete the pairing process.

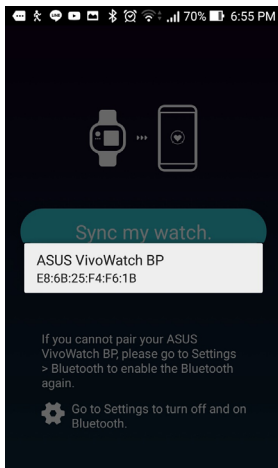
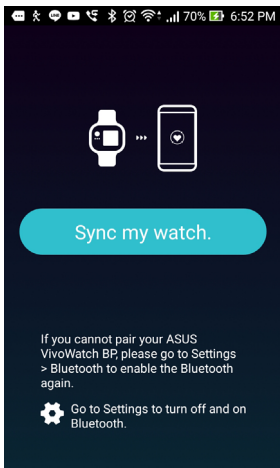

Pairing with another device or pairing again



- Turn on the Bluetooth of your phone before pairing.
- Ensure that the ASUS VivoWatch BP is within three meters from your phone.

1. From the Today screen, tap **Device** on the bottom of the screen.

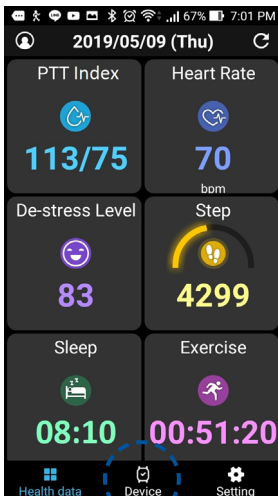

Device icon

2. From the Device screen, tap **Pairing**.
3. Select your ASUS VivoWatch BP from the available list, then tap **OK** to start the pairing.

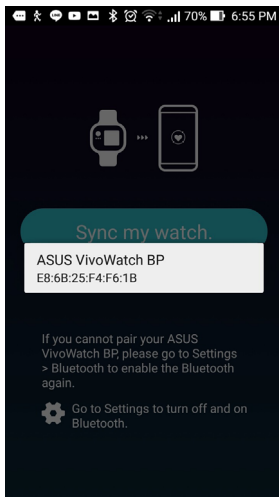
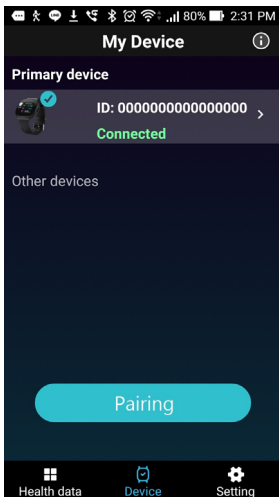

Navigating your ASUS VivoWatch BP

Unlocking your ASUS VivoWatch BP

Press the **Home button** to unlock your ASUS VivoWatch BP. You can scroll through the ASUS VivoWatch BP features after it is unlocked.

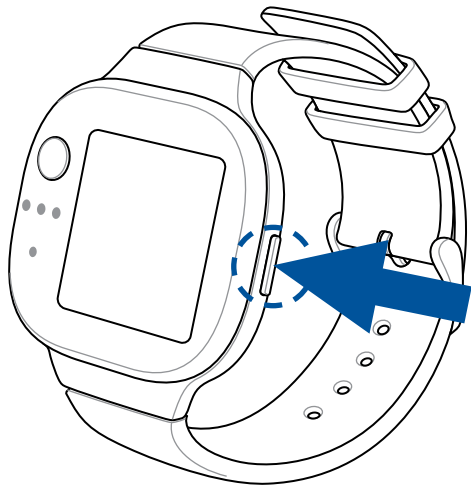

After a period of inactivity, the ASUS VivoWatch BP returns to the home screen and is locked to prevent unwanted operations.

Scrolling through ASUS VivoWatch BP features

Swipe left or right to scroll through the ASUS VivoWatch BP features.



You can press the **Home button** to return to the HOME screen.

Viewing more information for the selected feature

Swipe up or down to view more information for the selected ASUS VivoWatch BP feature or change the watch face.



Not all features contain additional information.

ASUS VivoWatch BP features

Your ASUS VivoWatch BP shows information about your daily activity status, exercise time, and sleep quality to assist you towards a healthier life.



The screens shown in this manual are for reference only.

Home screen

The ASUS VivoWatch BP home screen displays the time, date, and status of your ASUS VivoWatch BP.



Icon	Description
	Locked
	Battery level
	Connected
	Alarm



Swipe up or down to change the watch face.

Measuring screen

This screen allows you to measure your heart rate and health data. Your ASUS VivoWatch BP can also estimate your emotional stress by using the PTT (Pulse Transit Time) Index and the estimated the blood flow rate. Swipe right from the **Home screen** to enter the **Measuring screen**.

To measure your heart rate and health data, scroll to this screen, then place your finger onto the electrode and the PPG (green light) sensor.

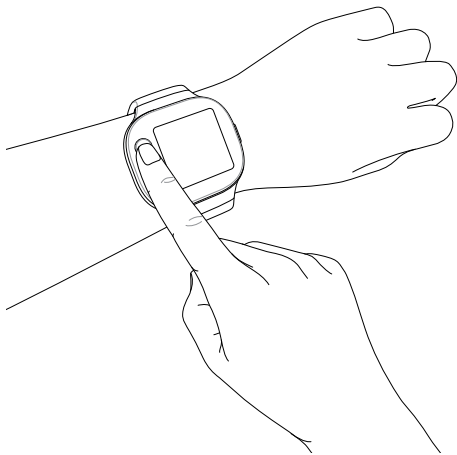
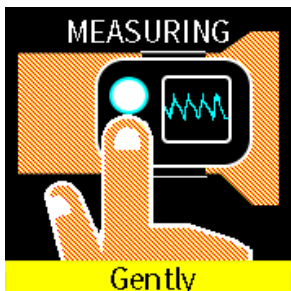

Your ASUS VivoWatch BP uses the PPG sensor in conjunction with the electrode to allow you to pick up your health data, and the way you wear your ASUS VivoWatch BP can affect the accuracy of the measurements.

To get more accurate results:

- Wear the ASUS VivoWatch BP in a normal way with the watch face facing up, the bottom of the ASUS VivoWatch BP touching your skin, and the ASUS VivoWatch BP away from your wrist bone.
- Wear your ASUS VivoWatch BP in a way without being uncomfortable. Do not strap the ASUS VivoWatch BP too tight to your wrist.
- Place your finger **gently** on the electrode and cover the green light while measuring your health data.
- Remain still while measuring to get the most accurate results.



- *The accuracy of the PPG sensor may vary depending on measurement conditions and surroundings. If the PPG sensor is dirty, clean the sensor and try again.*
- *Do not look directly into the PPG sensor, the sensor light may impair your vision.*
- *Please make sure children do not look directly into the sensor light.*
- *The ASUS VivoWatch BP is not a medical device and makes no medical claims. It is not intended to diagnose health conditions. The measurement results are only for your reference.*

Heart rate screen

This screen shows your current heart rate. The PPG sensor on your ASUS VivoWatch BP automatically determines your current heart rate.

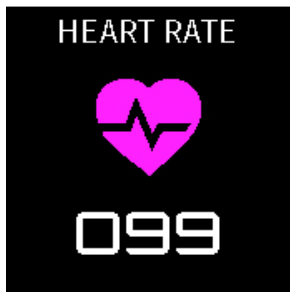

To get more accurate results:

1. Wear the ASUS VivoWatch BP in a normal way with the watch face facing up, the bottom of the ASUS VivoWatch BP touching your skin, and the ASUS VivoWatch BP away from your wrist bone.
2. Wear your ASUS VivoWatch BP in a way without being uncomfortable. Do not strap the ASUS VivoWatch BP too tight to your wrist.
3. You can get the most accurate results from the heart rate monitor when you are warmed up.

Settings

This screen allows you to change settings directly on your ASUS VivoWatch BP. Swipe right from the **Home screen** three times to enter the **Settings screen**.

Swipe up or down on the **Settings screen** to view the configurable settings listed below.

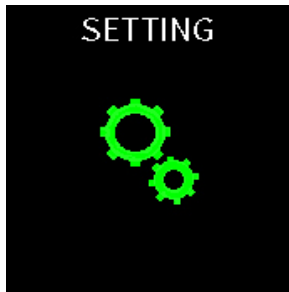

Setting	Description
Alarm	Turn alarms on or off.
Time	Adjust the time.
Profile	Adjust your profile. Enter your personal information correctly for more accurate health data.
Language	Change device language.
Brightness	Adjust the brightness of your ASUS VivoWatch BP. This effect is more noticeable in darker environments.
About	View more information about your device, such as firmware version, serial number, e-labels, and etc.

Activities screen

Your ASUS VivoWatch BP will automatically record your daily activities and display them on this screen. Swipe left from the **Home screen** to enter the **Activities screen**.

You can view your daily activities such as steps you have taken, calories you have burned, your sleep time, and your comfort sleep time as they are recorded.



Swipe up or down to view other activities.

Exercise screen

This screen allows you to keep track of your exercise sessions. When you start exercise mode, your ASUS VivoWatch BP will record information about the current exercise session and show the information as they are recorded.

Entering exercise mode

To enter exercise mode, swipe left or right to the **EXERCISE** screen, then tap **START** to enter exercise mode.

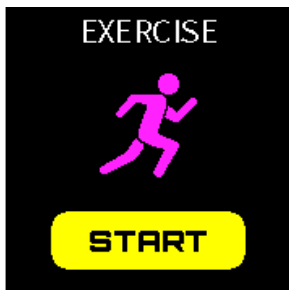

- During Exercise mode, select **Outdoor** to turn on the GPS feature. Wait for the GPS signal to lock on in an outdoor open area before you start your exercise session.
- A **GPS** icon will be shown when the GPS signal is locked on.

From the exercise screen, swipe left or right to view information such as the real time heart rate, exercise time, calories, steps, and distance for the current exercise session.

Exiting exercise mode

Press the home button and tap **END** to exit exercise mode.



Notifications

When you receive a call or message on your paired phone, your ASUS VivoWatch BP will vibrate and show you the phone number of the caller or a preview of the message.

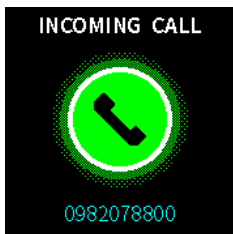

Reminders

Your ASUS VivoWatch BP will also show you walk and pill reminders to aid you towards a healthier lifestyle.



Updating your ASUS VivoWatch BP

Updating through the ASUS HealthConnect App

1. Launch the **ASUS HealthConnect App**.
2. From the Today screen, tap **Device** on the bottom of the screen.

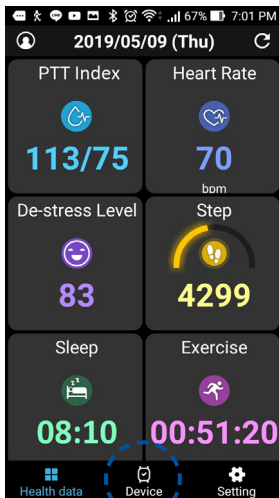

Device icon

3. From the Device screen, tap on the device you would like to update.
4. Tap **Update**. A pop-up message will appear when the firmware update is completed.

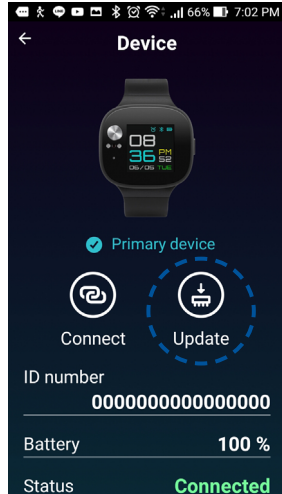
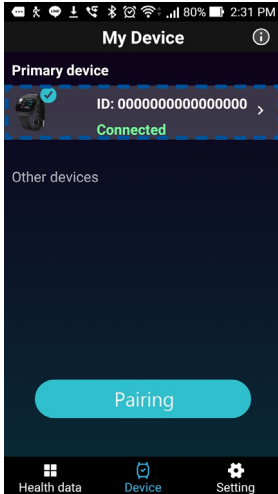

Appendix

Federal Communications Commission Interference Statement

This equipment has been tested and found to comply with the limits for a Class B digital device, pursuant to part 15 of the FCC Rules. These limits are designed to provide reasonable protection against harmful interference in a residential installation. This equipment generates, uses and can radiate radio frequency energy and, if not installed and used in accordance with the instructions, may cause harmful interference to radio communications. However, there is no guarantee that interference will not occur in a particular installation. If this equipment does cause harmful interference to radio or television reception, which can be determined by turning the equipment off and on, the user is encouraged to try to correct the interference by one or more of the following measures:

- Reorient or relocate the receiving antenna.
- Increase the separation between the equipment and receiver.
- Connect the equipment into an outlet on a circuit different from that to which the receiver is connected.
- Consult the dealer or an experienced radio/ TV technician for help.

CAUTION:

Any changes or modifications not expressly approved by the grantee of this device could void the user's authority to operate the equipment.

This device complies with Part 15 of the FCC Rules. Operation is subject to the following two conditions: (1) this device may not cause harmful interference, and (2) this device must accept any interference received, including interference that may cause undesired operation.

RF exposure warning

The equipment complies with FCC RF exposure limits set forth for an uncontrolled environment.

The equipment must not be co-located or operating in conjunction with any other antenna or transmitter.

Compliance Statement of Innovation, Science and Economic Development Canada (ISED)

This device complies with Innovation, Science and Economic Development Canada licence exempt RSS standard(s). Operation is subject to the following two conditions: (1) this device may not cause interference, and (2) this device must accept any interference, including interference that may cause undesired operation of the device.

CAN ICES-3(B)/NMB-3(B)

Déclaration de conformité de Innovation, Sciences et Développement économique Canada (ISED)

Le présent appareil est conforme aux CNR d'Innovation, Sciences et Développement économique Canada applicables aux appareils radio exempts de licence. L'exploitation est autorisée aux deux conditions suivantes : (1) l'appareil ne doit pas produire de brouillage, et (2) l'utilisateur de l'appareil doit accepter tout brouillage radioélectrique subi, même si le brouillage est susceptible d'en compromettre le fonctionnement.

CAN ICES-3(B)/NMB-3(B)

Radio Frequency (RF) Exposure Information

The radiated output power of the Wireless Device is below the Industry Canada (IC) radio frequency exposure limits. The Wireless Device should be used in such a manner such that the potential for human contact during normal operation is minimized.

This device has also been evaluated and shown compliant with the IC RF Exposure limits under portable exposure conditions (antennas are less than 20 cm of a person's body).

Informations concernant l'exposition aux fréquences radio (RF)

La puissance de sortie émise par cet appareil sans fil est inférieure à la limite d'exposition aux fréquences radio d'Industrie Canada (IC). Utilisez l'appareil sans fil de façon à minimiser les contacts humains lors d'un fonctionnement normal.

Cet appareil est conforme aux limites d'exposition aux rayonnements IC établies pour un environnement exposé à des appareils mobiles (les antennes se situant à une distance inférieure à 20 cm du corps de l'utilisateur).

Simplified EU Declaration of Conformity

ASUSTek Computer Inc. hereby declares that this device is in compliance with the essential requirements and other relevant provisions of Directive 2014/53/EU. Full text of EU declaration of conformity is available at <https://www.asus.com/support/>.



The Simplified EU Declaration of Conformity of this device has been updated. This device now complies with Radio Equipment Directive 2014/53/EU, and no longer complies with R&TTE Directive 1999/5/EC.

RED RF Output table

Function	Frequency	Maximum Output Power (EIRP)
Bluetooth	2402 - 2480 MHz	4 dBm

NCC警語：

經型式認證合格之低功率射頻電機，非經許可，公司、商號或使用者均不得擅自變更頻率、加大功率或變更原設計之特性及功能。

低功率射頻電機之使用不得影響飛航安全及干擾合法通信；經發現有干擾現象時，應立即停用，並改善至無干擾時方得繼續使用。

前項合法通信，指依電信法規定作業之無線電通信。低功率射頻電機須忍受合法通信或工業、科學及醫療用電波輻射性電機設備之干擾。

注意！使用過度恐傷害視力：

1. 使用 30 分鐘請休息 10分鐘。
2. 未滿 2 歲幼兒不看螢幕，2 歲以上每天看螢幕不要超過 1 小時。

「產品之限用物質含有情況」之相關資訊，請參考下表。

單元	限用物質及其化學符號					
	鉛 (Pb)	汞 (Hg)	鎘 (Cd)	六價鉻 (Cr ⁺⁶)	多溴聯苯 (PBB)	多溴二苯醚 (PBDE)
印刷電路板及電子組件	—	○	○	○	○	○
外殼	○	○	○	○	○	○
液晶螢幕	—	○	○	○	○	○
錶帶	○	○	○	○	○	○
其他及其配件	—	○	○	○	○	○

○：係指該項限用物質之百分比含量未超出百分比含量基準值。

—：係指該項限用物質為排除項目。

Global Environmental Regulation Compliance and Declaration

ASUS follows the green design concept to design and manufacture our products, and makes sure that each stage of the product life cycle of ASUS product is in line with global environmental regulations. In addition, ASUS disclose the relevant information based on regulation requirements.

Please refer to <http://csr.asus.com/english/Compliance.htm> for information disclosure based on regulation requirements ASUS is complied with:

EU REACH SVHC

ASUS Recycling/Takeback Services

ASUS recycling and takeback programs come from our commitment to the highest standards for protecting our environment. We believe in providing solutions for you to be able to responsibly recycle our products, batteries, other components as well as the packaging materials. Please go to <http://csr.asus.com/english/Takeback.htm> for detailed recycling information in different regions.

Proper disposal



Do not throw your ASUS VivoWatch BP in municipal waste. This product has been designed to enable proper reuse of parts and recycling. The symbol of the crossed out wheeled bin indicates that the product (electrical, electronic equipment and mercury-containing button cell battery) should not be placed in municipal waste. Check local regulations for disposal of electronic products.



Do not throw the battery in municipal waste. The symbol of the crossed out wheeled bin indicates that the battery should not be placed in municipal waste.

Rechargeable Battery Recycling Service in North America



For US and Canada customers, you can call 1-800-822-8837 (toll-free) for recycling information of your ASUS products' rechargeable batteries.

Regional notice for California



WARNING

Cancer and Reproductive Harm -
www.P65Warnings.ca.gov

Regional notice for Mexico



La operación de este equipo está sujeta a las siguientes dos condiciones:

- (1) es posible que este equipo o dispositivo no cause interferencia perjudicial;
- (2) este equipo o dispositivo debe aceptar cualquier interferencia, incluyendo la que pueda causar su operación no deseada.

Notices for removable batteries

- Risk of explosion if battery is replaced by an incorrect type.
- The battery and its component must be recycled or disposed of properly.

Avis concernant les batteries remplaçables

- La batterie de l'ordinateur portable peut présenter un risque d'incendie ou de brûlure si celle-ci est retirée ou désassemblée.
- La batterie et ses composants doivent être recyclés de façon appropriée.



Nordic Lithium Cautions (for lithium-ion batteries)

CAUTION! Danger of explosion if battery is incorrectly replaced. Replace only with the same or equivalent type recommended by the manufacturer. Dispose of used batteries according to the manufacturer's instructions. (English)

ATTENZIONE! Rischio di esplosione della batteria se sostituita in modo errato. Sostituire la batteria con un una di tipo uguale o equivalente consigliata dalla fabbrica. Non disperdere le batterie nell'ambiente. (Italian)

VORSICHT! Explosionsgefahr bei unsachgemäßen Austausch der Batterie. Ersatz nur durch denselben oder einem vom Hersteller empfohlenem ähnlichen Typ. Entsorgung gebrauchter Batterien nach Angaben des Herstellers. (German)

ADVARSEL! Lithiumbatteri - Eksplosionsfare ved fejlagtig håndtering. Udskiftning må kun ske med batteri af samme fabrikat og type. Levér det brugte batteri tilbage til leverandøren. (Danish)

WARNING! Explosionsfara vid felaktigt batteribyte. Använd samma batterityp eller en ekvivalent typ som rekommenderas av apparattillverkaren. Kassera använt batteri enligt fabrikantens instruktion. (Swedish)

VAROITUS! Paristo voi räjähtää, jos se on virheellisesti asennettu. Vaihda paristo ainoastaan laitevalmistajan suosittelemaan tyyppiin. Hävitä käytetty paristo valmistajan ohjeiden mukaisesti. (Finnish)

ATTENTION! Il y a danger d'explosion s'il y a remplacement incorrect de la batterie. Remplacer uniquement avec une batterie du même type ou d'un type équivalent recommandé par le constructeur. Mettre au rebut les batteries usagées conformément aux instructions du fabricant. (French)

ADVARSEL! Eksplosjonsfare ved feilaktig skifte av batteri. Benytt samme batteritype eller en tilsvarende type anbefalt av apparatfabrikanten. Brukte batterier kasseres i henhold til fabrikantens instruksjoner. (Norwegian)

標準品以外の使用は、危険の元になります。交換品を使用する場合、製造者に指定されるものを使って下さい。製造者の指示に従って処理して下さい。

(Japanese)

ВНИМАНИЕ! При замене аккумулятора на аккумулятор иного типа возможно его возгорание. Утилизируйте аккумулятор в соответствии с инструкциями производителя. (Russian)

Manufacturer	ASUSTek COMPUTER INC.
Address	4F, No. 150, LI-TE RD., PEITOU, TAIPEI 112, TAIWAN
Authorized Representative in Europe	ASUS COMPUTER GmbH
Address	HARKORT STR. 21-23, 40880 RATINGEN, GERMANY

COPYRIGHT AND WARRANTY INFORMATION

No part of this user guide, including the products and software described in it, may be reproduced, transmitted, transcribed, stored in a retrieval system, or translated into any language in any form or by any means, except documentation kept by the purchaser for backup purposes, without the express written permission of ASUSTeK Computer INC. (“ASUS”).

Product warranty or service will not be extended if: (1) the product is repaired, modified or altered, unless such repair, modification or alteration is authorized in writing by ASUS; or (2) the serial number of the is defaced or missing.

ASUS PROVIDES THIS User guide “AS IS” WITHOUT WARRANTY OF ANY KIND, EITHER EXPRESS OR IMPLIED, INCLUDING BUT NOT LIMITED TO THE IMPLIED WARRANTIES OR CONDITIONS OF MERCHANTABILITY OR FITNESS FOR A PARTICULAR PURPOSE. IN NO EVENT SHALL ASUS, ITS DIRECTORS, OFFICERS, EMPLOYEES OR AGENTS BE LIABLE FOR ANY INDIRECT, SPECIAL, INCIDENTAL, OR CONSEQUENTIAL DAMAGES (INCLUDING DAMAGES FOR LOSS OF PROFITS, LOSS OF BUSINESS, LOSS OF USE OR DATA, INTERRUPTION OF BUSINESS AND THE LIKE), EVEN IF ASUS HAS BEEN ADVISED OF THE POSSIBILITY OF SUCH DAMAGES ARISING FROM ANY DEFECT OR ERROR IN THIS User guide OR PRODUCT.

Products and corporate names appearing in this user guide may or may not be registered trademarks or copyrights of their respective companies, and are used only for identification or explanation and to the owners’ benefit, without intent to infringe.

SPECIFICATIONS AND INFORMATION CONTAINED IN THIS User guide ARE FURNISHED FOR INFORMATIONAL USE ONLY, AND ARE SUBJECT TO CHANGE AT ANY TIME WITHOUT NOTICE, AND SHOULD NOT BE CONSTRUED AS A COMMITMENT BY ASUS. ASUS ASSUMES NO RESPONSIBILITY OR LIABILITY FOR ANY ERRORS OR INACCURACIES THAT MAY APPEAR IN THIS User guide, INCLUDING THE PRODUCTS AND SOFTWARE DESCRIBED IN IT.

Copyright © 2019 ASUSTeK Computer INC. All Rights Reserved.

LIMITATION OF LIABILITY

Circumstances may arise where because of a default on ASUS' part or other liability, you are entitled to recover damages from ASUS. In each such instance, regardless of the basis on which you are entitled to claim damages from ASUS, ASUS is liable for no more than damages for bodily injury (including death) and damage to real property and tangible personal property; or any other actual and direct damages resulted from omission or failure of performing legal duties under this Warranty Statement, up to the listed contract price of each product.

ASUS will only be responsible for or indemnify you for loss, damages or claims based in contract, tort or infringement under this Warranty Statement.

This limit also applies to ASUS' suppliers and its reseller. It is the maximum for which ASUS, its suppliers, and your reseller are collectively responsible.

UNDER NO CIRCUMSTANCES IS ASUS LIABLE FOR ANY OF THE FOLLOWING: (1) THIRD-PARTY CLAIMS AGAINST YOU FOR DAMAGES; (2) LOSS OF, OR DAMAGE TO, YOUR RECORDS OR DATA; OR (3) SPECIAL, INCIDENTAL, OR INDIRECT DAMAGES OR FOR ANY ECONOMIC CONSEQUENTIAL DAMAGES (INCLUDING LOST PROFITS OR SAVINGS), EVEN IF ASUS, ITS SUPPLIERS OR YOUR RESELLER IS INFORMED OF THEIR POSSIBILITY.

SERVICE AND SUPPORT

Visit our multi-language web site at <https://www.asus.com/support/>

