



CS1942 / CS1944

2/4-Port USB 2.0 Dual View
Mini DisplayPort KVMP Switch

User Manual



EMC Information

Federal Communication Commission Interference Statement

This equipment has been tested and found to comply with the limits for a Class B digital service, pursuant to Part 15 of the FCC rules. These limits are designed to provide reasonable protection against harmful interference in a residential installation. Any changes or modifications made to this equipment may void the user's authority to operate this equipment. This equipment generates, uses, and can radiate radio frequency energy. If not installed and used in accordance with the instructions, may cause harmful interference to radio communications. However, there is no guarantee that interference will not occur in a particular installation. If this equipment does cause harmful interference to radio or television reception, which can be determined by turning the equipment off and on, the user is encouraged to try to correct the interference by one or more of the following measures:

- ◆ Reorient or relocate the receiving antenna.
- ◆ Increase the separation between the equipment and receiver.
- ◆ Connect the equipment into an outlet on a circuit different from that to which the receiver is connected.
- ◆ Consult the dealer or an experienced radio/TV technician for help.

FCC Caution:

Any changes or modifications not expressly approved by the party responsible for compliance could void the user's authority to operate this equipment.

RoHS

This product is RoHS compliant.

SJ/T 11364-2006

The following contains information that relates to China.

部件名称	有毒有害物质或元素					
	铅	汞	镉	六价铬	多溴联苯	多溴二苯醚
电器部件	●	○	○	○	○	○
机构部件	○	○	○	○	○	○

- : 表示该有毒有害物质在该部件所有均质材料中的含量均在SJ/T 11363-2006规定的限量要求之下。
- : 表示符合欧盟的豁免条款, 但该有毒有害物质至少在该部件的某一均质材料中的含量超出SJ/T 11363-2006的限量要求。
- ×: 表示该有毒有害物质至少在该部件的某一均质材料中的含量超出SJ/T 11363-2006的限量要求。



User Information

Online Registration

Be sure to register your product at our online support center:

International	http://eservice.aten.com
---------------	---

Telephone Support

For telephone support, call this number:

International	886-2-8692-6959
China	86-10-5255-0110
Japan	81-3-5615-5811
Korea	82-2-467-6789
North America	1-888-999-ATEN ext 4988
United Kingdom	44-8-4481-58923

User Notice

All information, documentation, and specifications contained in this manual are subject to change without prior notification by the manufacturer. The manufacturer makes no representations or warranties, either expressed or implied, with respect to the contents hereof and specifically disclaims any warranties as to merchantability or fitness for any particular purpose. Any of the manufacturer's software described in this manual is sold or licensed *as is*. Should the programs prove defective following their purchase, the buyer (and not the manufacturer, its distributor, or its dealer), assumes the entire cost of all necessary servicing, repair and any incidental or consequential damages resulting from any defect in the software.

The manufacturer of this system is not responsible for any radio and/or TV interference caused by unauthorized modifications to this device. It is the responsibility of the user to correct such interference.

The manufacturer is not responsible for any damage incurred in the operation of this system if the correct operational voltage setting was not selected prior to operation. **PLEASE VERIFY THAT THE VOLTAGE SETTING IS CORRECT BEFORE USE.**

Package Contents

The basic CS1942 / CS1944 package consists of:

- ◆ 1 CS1942 / CS1944 2/4-Port USB 2.0 Dual View Mini DisplayPort KVMP Switch
- ◆ 2 Mini DisplayPort 1.1a 1 m Cables (CS1942)
- ◆ 2 Mini DisplayPort 1.1a 2 m Cables (CS1942)
- ◆ 2 USB 2.0 1.8 m Cables (CS1942)
- ◆ 2 Audio Jack 1.8 m Cable Sets (CS1942)
- ◆ 4 Mini DisplayPort 1.1a 1 m Cables (CS1944)
- ◆ 4 Mini DisplayPort 1.1a 2 m Cables (CS1944)
- ◆ 4 USB 2.0 1.8 m Cables (CS1944)
- ◆ 4 Audio Jack 1.8 m Cable Sets (CS1944)
- ◆ 1 Power Adapter
- ◆ 1 User Instructions*

Check to make sure that all the components are present and that nothing got damaged in shipping. If you encounter a problem, contact your dealer.

Read this manual thoroughly and follow the installation and operation procedures carefully to prevent any damage to the unit, and/or any of the devices connected to it.

* Features may have been added to the CS1942 / CS1944 since this manual was published. Please visit our website to download the most up-to-date version.

Contents

EMC Information	ii
User Information	iii
Online Registration	iii
Telephone Support	iii
User Notice	iii
Package Contents	iv
About this Manual	vii
Conventions	viii
Product Information	viii
1. Introduction	
Overview	1
Features	2
Requirements	3
Console	3
Computers	3
Cables	3
CS1942	3
CS1944	3
Operating Systems	4
Components	5
CS1942 Front View	5
CS1944 Front View	5
CS1942 / CS1944 Rear View	8
CS1944 Side View	8
2. Hardware Setup	
Cable Connection	11
Installation Diagram	13
3. Basic Operation	
Manual Switching	15
Hot Plugging	16
Powering Off and Restarting	16
Port ID Numbering	16
4. Keyboard Port Operation	
Port Switching	17
Cycling Through the Ports	17
Going Directly to a Port	18
Auto Scanning	19
Hotkey Setting Mode (HSM)	20
Invoking HSM	20

Alternate HSM Invocation Keys	21
Alternate Port Switching Keys	21
Keyboard Operating Platform	22
List Switch Settings	22
USB Reset	23
Hotkey Beeper Control	23
Disable Port Switching Keys	23
Firmware Upgrade Mode	23
Restore Default Settings	24
Keyboard Emulation	24
Mouse Emulation Control	24
Mouse Port Switching	24
Power On Detection	24
USB Quick Charge	25
SPC Mode	25

5. Keyboard Emulation

Mac Keyboard	27
------------------------	----

6. The Firmware Upgrade Utility

Before you Begin	29
Starting the Upgrade	29
Upgrade Succeeded	32
Upgrade Failed	32

Appendix

Safety Instructions	33
General	33
Technical Support	35
International	35
North America	35
Specifications	36
Troubleshooting	37
Overview	37
Factory Default Settings	39
Limited Warranty	39

About this Manual

This User Manual is provided to help you get the most from your system. It covers all aspects of installation, configuration and operation. An overview of the information found in the manual is provided below.

Chapter 1, Introduction, introduces you to the CS1942 / CS1944 system. Its purpose, features and benefits are presented, and its front, side, and back panel components are described.

Chapter 2, Hardware Setup, describes how to set up your installation, with a diagram showing the necessary steps.

Chapter 3, Basic Operation, explains the fundamental concepts involved in operating the CS1942 / CS1944.

Chapter 4, Keyboard Port Operation, details all of the concepts and procedures involved in the keyboard hotkey operation of your CS1942 / CS1944 installation

Chapter 5, Keyboard Emulation, provides tables that list the PC to Mac keyboard emulation mappings.

Chapter 6, The Firmware Upgrade Utility, explains how to use this utility to upgrade the CS1942 / CS1944's firmware with the latest available versions.

An Appendix, provides specifications and other technical information regarding the CS1942 / CS1944.

Conventions

This manual uses the following conventions:

- Monospaced Indicates text that you should key in.
- [] Indicates keys you should press. For example, [Enter] means to press the **Enter** key. If keys need to be chorded, they appear together in the same bracket with a plus sign between them: [Ctrl+Alt].
1. Numbered lists represent procedures with sequential steps.
- ◆ Bullet lists provide information, but do not involve sequential steps.
- Indicates selecting the option (on a menu or dialog box, for example), that comes next. For example, Start → Run means to open the *Start* menu, and then select *Run*.
-  Indicates critical information.

Product Information

For information about all ATEN products and how they can help you connect without limits, visit ATEN on the Web or contact an ATEN Authorized Reseller. Visit ATEN on the Web for a list of locations and telephone numbers:

International	http://www.aten.com
North America	http://www.aten-usa.com

Chapter 1

Introduction

Overview

The CS1942 / CS1944 2/4-Port USB 2.0 Dual View Mini DisplayPort KVM Switch allows quick switch access between 2/4 computers from a single USB keyboard and mouse. The amazing functionality combines a Dual View 2/4-Port switch with 2-Port USB 2.0 hub and front panel USB quick charge feature.

The latest CS1942 / CS1944 KVM design enhances performance with Mini-DisplayPort and Mini-TOSLINK connectors, providing digital audio and video with ultra high resolution, vivid picture quality, and superior surround sound with SPDIF connections.

The CS1942 / CS1944's independent switching allows the KVM focus to be on one computer while USB peripheral and audio focus are on others. As a USB hub, it permits each computer to access connected peripherals on a one-computer-at-a-time basis, eliminating the need to purchase a separate USB hub. All keyboard and mouse data transfers via fast custom KVM cables for seamless response. In addition, the hotkey function fully supports multifunction gaming keyboards and mice.

The CS1942 / CS1944 setup is easy; simply plug the cables into their appropriate ports and you are ready. There is no software to configure, no installations, and no incompatibility issues. In addition, the CS1942 / CS1944 intercepts keyboard input directly, allowing it to work on multiple OS platforms including; Windows, Linux, and Mac.

With all displays and peripherals connected to the CS1942 / CS1944, you simply select which source you want to view by one of three switching methods: front touch panel, hotkey, or mouse wheel – simply double-click on the scroll wheel of your mouse to switch ports.

With its unique design and innovative features, the CS1942 / CS1944 provides style and super functionality in any SOHO environment. The CS1942 / CS1944 is ideal for multimedia applications, gaming setups, and multi-computer office environments- offering the ultimate in space-saving, streamlined KVM technology for any desktop.

Features

- ◆ One Dual-View USB console independently and simultaneously controls two/four Mini DisplayPort computers and two additional USB devices
- ◆ 2-Port USB 2.0 hub built in, fully compliant with USB 2.0 specifications
- ◆ Computer selection via front touch panel/hotkey/mouse wheel*
- ◆ Mini DisplayPort 1.1a & HDCP compatible
- ◆ Full bass response provides a rich HD digital surround sound experience via Mini-TOSLINK connections
- ◆ Superior video quality - supports up to 2560 x 1600 resolution and 3D video up to 1920x1080 resolution at 120Hz
- ◆ Nvidia 3D Vision Ready
- ◆ USB Quick Charge Feature (front panel USB port)
- ◆ Independent switching of USB peripherals, audio, and KVM focus
- ◆ Keyboard and Mouse support emulation and bypass
- ◆ Auto scan feature
- ◆ Power on Detection
- ◆ Mac keyboard support and emulation**
- ◆ Multilingual keyboard mapping - Supports English, Japanese, and French keyboards
- ◆ Multiplatform support- Windows, Linux and Mac
- ◆ Upgradeable firmware via USB interface

*Mouse port switching only works with 3-key USB mouse wheel in emulation mode.

**PC keyboards emulate Mac keyboards, and Mac keyboards only work with their own computers.

Requirements

Console

- ◆ Two Mini DisplayPort (mDP) monitors or DP monitors with mDP adapters
- ◆ USB mouse
- ◆ USB keyboard
- ◆ Microphone and Speakers

Computers

- ◆ Mini DisplayPort (Display Port with mDP adapters)
- ◆ USB Type A Port
- ◆ Audio Ports (optional)

Cables

CS1942

- ◆ Two Mini DisplayPort 1.1a 1 m cables, and two Mini DisplayPort 1.1a 2 m cables, included with the CS1942 package
- ◆ Two USB 2.0 1.8 m cables and two 3.5mm Audio Jack 1.8 m cables, included with the CS1942 package

CS1944

- ◆ Four Mini DisplayPort 1.1a 1 m cables, and four Mini DisplayPort 1.1a 2 m cables, included with the CS1944 package
- ◆ Four USB 2.0 1.8 m cables and four 3.5mm Audio Jack 1.8 m cables, included with the CS1944 package

Operating Systems

Supported operating systems are shown in the table, below:

OS		Version
Windows		2000 SP4 and higher, XP, 2003, 2008, Vista (x64, x86), Windows 7 (x64, x86)
Linux	RedHat	Fedora and higher, RHEL AS 4, RHEL 5, RHEL 5
	SuSE	10 and higher, OpenSUSE 10.2; SLES 10 SP1
	Debian	3.1, 4.0
	Ubuntu	7.04, 7.10
UNIX	FreeBSD	5.5, 6.1, 6.2
Novell	Netware	6.0, 6.5
Mac		9.0, 9.1, 10.1, 10.2, 10.3, 10.4, 10.5

Components

CS1942 Front View

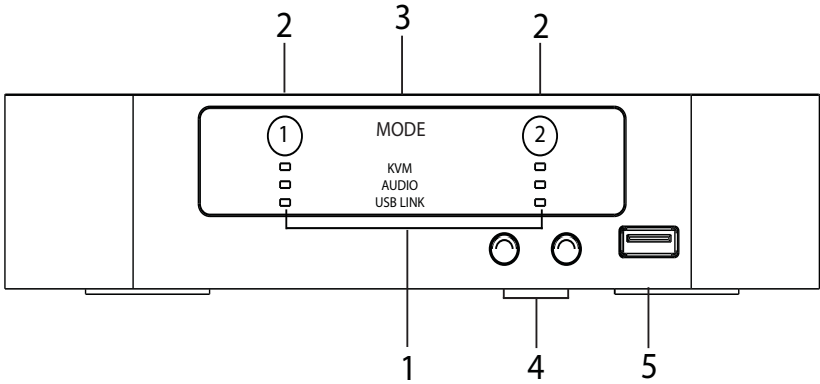

CS1944 Front View

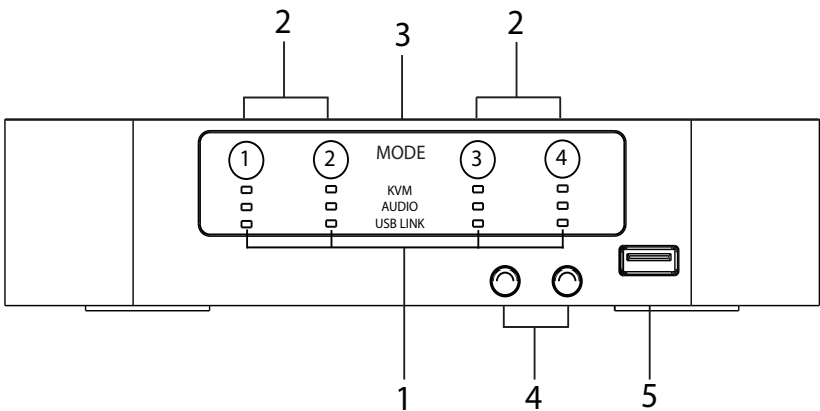

No.	Component	Description
1	LED Status Panel	<p>This panel contains LED icons that light to indicate mode and port status. The Mode and Port Selection touch panels have three corresponding LED icons that light to indicate status – KVM, Audio, and USB Link. LED Status Indications:</p> <p>KVM</p> <ul style="list-style-type: none"> ◆ DIM Orange LED: Device is connected to the KVMP switch but the port is not selected for use ◆ Bright Orange LED: Port has focus on the switch for KVM (Keyboard, video and mouse) use <p>AUDIO</p> <ul style="list-style-type: none"> ◆ Green LED: Port is selected for audio use <p>USB LINK</p> <ul style="list-style-type: none"> ◆ Green LED: Port is selected for USB peripheral use
2	Port Selection Touch Panels	<p>For manual port selection (see <i>Manual Switching</i>, page 15):</p> <ul style="list-style-type: none"> ◆ To bring complete focus (KVM, Audio, and USB Link) to a computer, <i>either</i>: a) press the port selection touch panel that corresponds to that computer, <i>or</i>: b) press the Mode touch panel once (the Mode touch panel icons flash) and then press the port selection touch panel (1, 2, 3, 4) that corresponds to that computer. All three port icons light up. ◆ To bring only the KVM focus to a computer, press the Mode touch panel twice (the Mode touch panel KVM icon will flash), and then press the port selection touch panel that corresponds to that computer. The port's KVM icon lights up. ◆ To bring only the Audio focus to a computer, press the Mode touch panel three times (the Mode touch panel Audio icon will flash), and then press the port selection touch panel that corresponds to that computer. The port's Audio icon lights up. ◆ To bring only the USB focus to a computer, press the Mode touch panel four times (the Mode touch panel USB icon will flash), and then press the port selection touch panel that corresponds to that computer. The port's USB icon lights up. ◆ Press and hold port selection touch panel 1 and 2 simultaneously for 2 <i>seconds</i> to start Auto Scan Mode (see <i>Auto Scanning</i>, page 19) <p>Note: If a port is not selected within five seconds of pushing the Mode touch panel, the Mode touch panel will power off.</p>

No.	Component	Description
3	Mode Selection Touch Panel	This touch panel allows you to cycle through the four focus modes – complete, KVM, audio, and USB.
4	Analog Audio Ports	Your console speakers and microphone plug in here.
5	USB 2.0 Peripheral Port	USB 2.0 peripherals (printers, scanners, etc.) plug in here, in addition this port provides the USB quick charge feature.

CS1942 / CS1944 Rear View

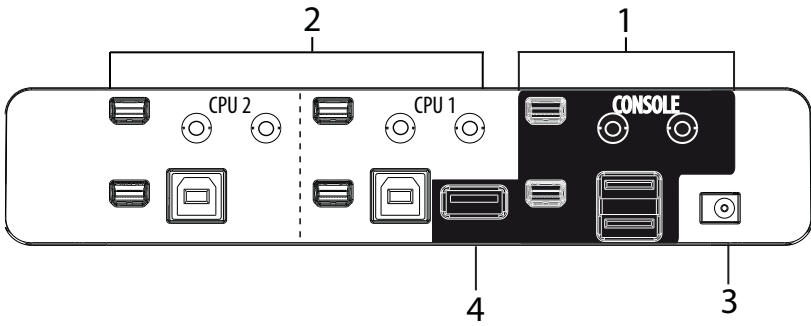

CS1944 Side View

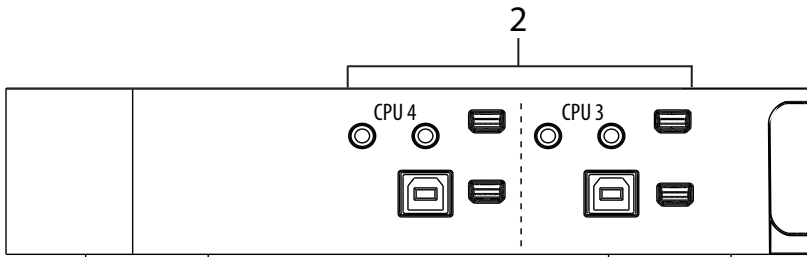

No.	Component	Description
1	Console Port Section	The cables from your Mini DisplayPort monitor, USB keyboard, USB mouse, speakers, and microphone plug in here. Each connector is marked with an appropriate icon to indicate itself.
2	KVM Port Section	The cables that link the switch to your computers plug in here. Each KVM port section is comprised of a microphone jack, speaker jack, USB type B socket and 2 Mini DisplayPort connectors.
3	Power Jack	The power adapter cable plugs into this jack.
4	USB 2.0 Hub	USB 2.0 peripherals (printers, scanners, etc.) plug into this port.

This Page Intentionally Left Blank

Chapter 2

Hardware Setup



1. Important safety information regarding the placement of this device is provided on page 33. Please review it before proceeding.
2. Make sure that the power to all devices connected to the installation are turned off. You must unplug the power cords of any computers that have the Keyboard Power On function.

Cable Connection

To set up your CS1942 / CS1944 installation, refer to the installation diagram on page 13 (the numbers in the diagram correspond to the steps below), and do the following:

1. Plug your USB keyboard and USB mouse into the USB console ports located on the unit's rear panel.
2. Plug the console monitor(s) into the Mini DisplayPort console ports located on the unit's rear panel and power on the monitors.

Note: Connections may require a DP to mDP adapter.

3. Plug your analog microphone and headphones into the console microphone and speaker jacks located on the unit's front panel.

Note: The microphone and headphones plugged into this panel have priority over those plugged into the rear panel. Analog audio cables are required on the CPU side for this connection.

4. Plug your analog/digital (Mini-TOSLINK) microphone and speakers into the audio console ports located on the unit's rear panel.

Note: Digital sound equipment requires Mini-TOSLINK cables.

- Using the Mini DisplayPort 1.1a cable, plug the Mini DisplayPort connector into an available Mini DisplayPort “**A**” socket on the KVM port (CPU 1, CPU 2, etc.) section of the switch , then plug the USB 2.0 cable, and microphone/speaker cables into their corresponding sockets.

Note: Verify that all the plugs are in the same KVM Port sockets (all in CPU 1, all in CPU 2, etc.). Each socket is marked with an appropriate icon.

- At the other end of the cable sets from step 5, plug the Mini DisplayPort 1.1a cable, USB 2.0 cable, and microphone/speaker cables into their respective ports on the computer.
- Using another Mini DisplayPort 1.1a cable, plug the Mini DisplayPort cable connector into the Mini DisplayPort socket “**B**” on the same KVM port (CPU 1, CPU 2, etc.) section of the switch.
- At the other end of the Mini DisplayPort 1.1a cable from step 7, plug the monitor cable into its respective port on the computer.

Note: Repeat steps 5, 6, 7, and 8 for each dual-screen PC system you are installing.

- Plug your USB peripherals into the front (a) or rear (b) USB peripheral ports (optional).
- Plug the power adapter that came with your switch into an AC power source, then plug power adapter cable into the switch’s Power Jack.
- Power on the computers.

Installation Diagram

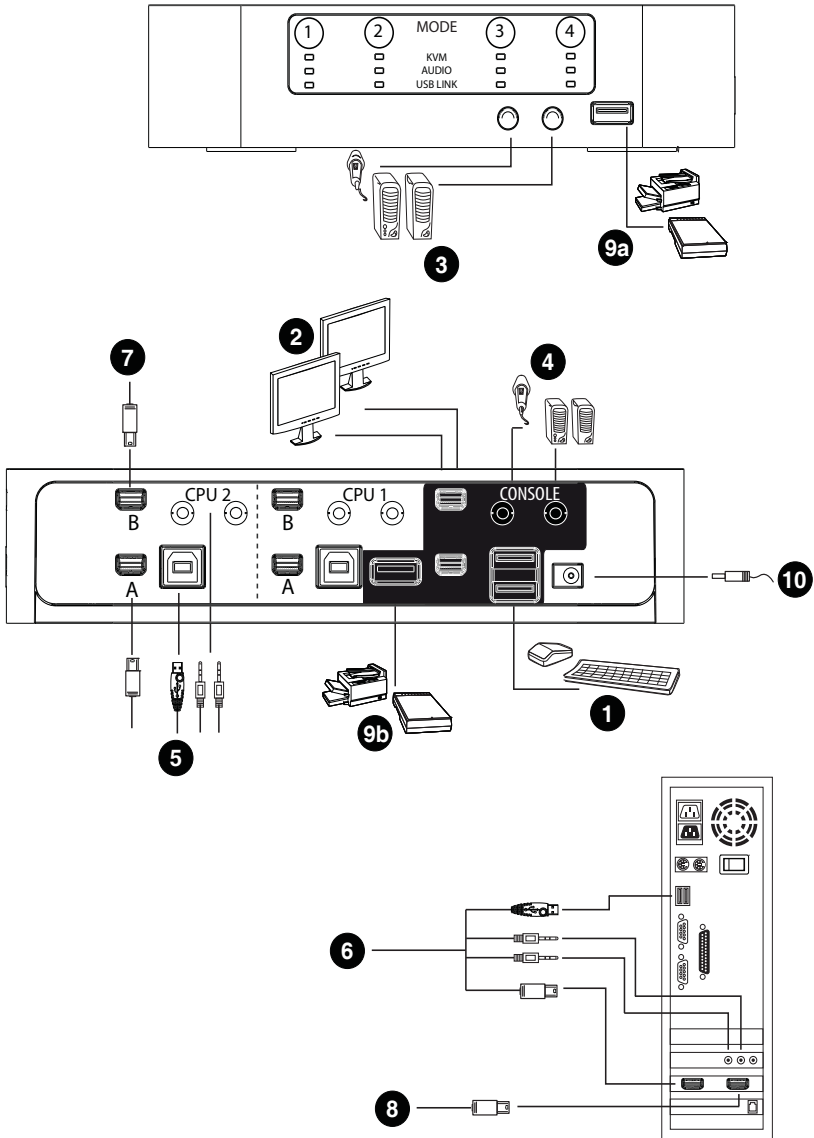

This Page Intentionally Left Blank

Chapter 3

Basic Operation

Manual Switching

There are three convenient methods to access the computers: Manual – which involves pressing the port selection touch panel located on the unit’s front panel; Mouse port-switching, and Hotkey – which involves entering combinations from the keyboard. Hotkey port selection and Mouse port-switching are discussed in the next chapter.

For manual port selection:

- ◆ To bring complete focus (**audio, KVM, and USB**) to a computer, *either*:
a) press the port selection touch panel that corresponds to that computer;
or: b) press the Mode touch panel **once** (the Mode touch panel three icons flash) and then press the port selection touch panel that corresponds to that computer. All three port icons light up.
- ◆ To bring only the **KVM** focus to a computer, press the Mode touch panel **twice** (the Mode touch panel KVM icon flashes), and then press the port selection touch panel that corresponds to that computer. The port’s KVM icon lights up.
- ◆ To bring only the **audio** focus to a computer, press the Mode touch panel **three times** (the Mode touch panel audio icon flashes), and then press the port selection touch panel that corresponds to that computer. The port’s audio icon lights up.
- ◆ To bring only the **USB** focus to a computer, press the Mode touch panel **four times** (the Mode touch panel USB icon flashes), and then press the port selection touch panel that corresponds to that computer. The port’s USB icon lights up.

-
- Note:**
1. Press and release either port selection touch panel to stop Auto Scan Mode (See *Auto Scanning*, page 19). The KVM focus goes to the computer attached to the corresponding port of the touch panel you pressed.
 2. Allow the output device a few seconds to stabilize and display video content before switching to another input source.
 3. If a port is not selected within five seconds of pushing the Mode touch panel, the Mode touch panel will power off.
-

Hot Plugging

The CS1942 / CS1944 supports USB hot plugging – components can be removed and added back into the installation by unplugging their cables from the USB hub ports without the need to shut the unit down.

Powering Off and Restarting

If it becomes necessary to Power Off the unit, before starting it back up you must do the following:

1. Shut down all the computers that are attached to the switch.
2. Unplug the switch's power adapter cable.
3. Wait 10 seconds, then plug the switch's power adapter cable back in.
4. After the switch is up, Power On the computers.

Port ID Numbering

Each KVM port on the CS1942 / CS1944 switch is assigned a port number (1 and 2 on the CS1942; 1, 2, 3, and 4 on the CS1944). The port numbers are marked on the rear and side panels of the switch (see *CS1942 / CS1944 Rear View*, page 8, for details).

The Port ID of a computer is derived from the KVM port number it is connected to. For example, a computer connected to KVM port 2 has a Port ID of 2.

The Port ID is used to specify which computer gets the KVM USB peripheral, and audio focus with the Hotkey port selection method (see *Port Switching*, page 17, for details).

Chapter 4

Keyboard Port Operation

The CS1942 / CS1944 provides an extensive, easy-to-use, hotkey function that makes it convenient to control and configure your KVM installation from the keyboard. Hotkeys provide asynchronous (independent) switching of the KVM, USB hub and audio focus. If you wish, you can give one computer the KVM console focus, another the USB hub focus and the other(s) the audio focus.

Port Switching

All port switches begin with tapping the **Scroll Lock** key twice. The tables below describe the actions that each combination performs.

Note: If using the Scroll Lock key conflicts with other programs running on the computer, the **Ctrl** key can be used, instead. See *Alternate Port Switching Keys*, page 21, for details.

Cycling Through the Ports

Hotkey	Action
[Scroll Lock] [Scroll Lock] [Enter]	Brings the KVM , USB hub , and audio focus from the port that currently has the KVM focus to the next port on the installation (1 to 2; 2 to 1 for the CS1942: 1 to 2; 2 to 3; 3 to 4; 4 to 1 for the CS1944).
[Scroll Lock] [Scroll Lock] [K] [Enter]	Brings only the KVM focus from the port that currently has it to the next port on the installation. The USB and audio focus remain where they are.
[Scroll Lock] [Scroll Lock] [U] [Enter]	Brings only the USB hub focus from the port that currently has it to the next port on the installation. The KVM and audio focus remain where they are.
[Scroll Lock] [Scroll Lock] [S] [Enter]	Brings only the audio focus from the port that currently has it to the next port on the installation. The KVM and USB hub focus remain where they are.

Going Directly to a Port

Hotkey	Action
[Scroll Lock] [Scroll Lock] [n] [Enter]	Brings the KVM , USB hub , and audio focus to the computer attached to the port corresponding to the specified Port ID.
[Scroll Lock] [Scroll Lock] [n] [K] [Enter]	Brings only the KVM focus to the computer attached to the specified port. The USB hub and audio focus remain where they are.
[Scroll Lock] [Scroll Lock] [n] [U] [Enter]	Brings only the USB hub focus to the computer attached to the specified port. The KVM and audio focus remain where they are.
[Scroll Lock] [Scroll Lock] [n] [S] [Enter]	Brings only the audio focus to the computer attached to the specified port. The KVM and USB hub focus remain where they are.
[Scroll Lock] [Scroll Lock] [n] [K] [U] [Enter]	Brings the KVM and USB hub focus to the computer attached to the specified port. The audio focus remains where it is.
[Scroll Lock] [Scroll Lock] [n] [K] [S] [Enter]	Brings the KVM and audio focus to the computer attached to the specified port. The USB hub focus remains where it is.
[Scroll Lock] [Scroll Lock] [n] [U] [S] [Enter]	Brings the USB hub and audio focus to the computer attached to the specified port. The KVM focus remains where it is.

Note: The **n** stands for the computer's Port ID number (1, 2, 3, or 4). See *Port ID Numbering*, page 16, for details. Replace the **n** with the appropriate Port ID when entering hotkey combinations.

Auto Scanning

The CS1942 / CS1944's Auto Scan feature automatically cycles the KVM focus through the computer ports at regular intervals. This allows you to monitor the computer activity without having to take the trouble of switching from port to port manually. See the table below for details.

Hotkey	Action
[Scroll Lock] [Scroll Lock] [A] [Enter]	Invokes Auto Scan. The KVM focus cycles from port to port at 5 second intervals . Five second intervals is the Default setting.
[Scroll Lock] [Scroll Lock] [A] [n] [Enter]	The KVM focus cycles from port to port at n second intervals.

- Note:**
1. The **n** stands for the number of seconds that the CS1942 / CS1944 should dwell on a port before moving on to the next. Replace the **n** with a number between 1 and 99 when entering this hotkey combination.
 2. While Auto Scan Mode is in effect, ordinary keyboard and mouse functions are suspended – only Auto Scan Mode compliant keystrokes and mouse clicks can be input. You must exit Auto Scan Mode in order to regain normal control of the console.
 3. Although the video focus switches from port to port, the audio and USB focus do not switch. They stay at the port they were on when Auto Scanning started.
 4. To exit Auto Scan Mode, press the **Esc** key, or the **Spacebar**.

Hotkey Setting Mode (HSM)

Hotkey Setting Mode (HSM) is used to set up your CS1942 / CS1944 switch configuration. All operations begin with invoking Hotkey Setting Mode (HSM).

Invoking HSM

To invoke HSM do the following:

1. Press and hold down [**Num Lock**].
2. Press and release [-].
3. Release [**Num Lock**].

Note: There is an alternate key combination to invoke HSM. See below for details.

When HSM is active, the Caps Lock, and Scroll Lock LEDs flash in succession to indicate that HSM is in effect. They stop flashing and revert to normal status when you exit HSM.

Ordinary keyboard and mouse functions are suspended – only Hotkey compliant keystrokes and mouse clicks (described in the sections that follow), can be input.

At the conclusion of some hotkey operations, you automatically exit hotkey mode. With some operations, you must exit manually. To exit HSM manually, press the **Esc** key, or the **Spacebar**.

Alternate HSM Invocation Keys

An alternate set of HSM invocation keys is provided in case the default set conflicts with programs running on the computers.

To switch to the alternate HSM invocation set, do the following:

1. Invoke HSM (see page 20).
2. Press and release [**H**].

The HSM invocation keys become the Ctrl key (instead of Num Lock) and the F12 key (instead of minus).

Note: This procedure is a toggle between the two methods. To revert back to the original HSM invocation keys, invoke HSM, then press and release the **H** key again.

Alternate Port Switching Keys

The port switching activation keys can be changed from tapping the Scroll Lock key twice ([Scroll Lock] [Scroll Lock]) to tapping the Ctrl key twice. To change the port switching activation keys, do the following:

1. Invoke HSM (see page 20).
2. Press and release [**T**].

Note: This procedure is a toggle between the two methods. To revert back to the original [Scroll Lock] [Scroll Lock] method, invoke HSM, then press and release the **T** key again.

Keyboard Operating Platform

The CS1942 / CS1944's default port configuration is for a PC compatible keyboard operating platform. If your console uses a PC compatible keyboard and you have a Mac attached to a port, for example, you can change the port's keyboard operating platform configuration so that the PC compatible keyboard emulates the Mac keyboard. In addition the keyboard can be set to replicate different language keyboards. The procedures are as follows:

1. Bring the KVM focus to the port you want to set.
2. Invoke HSM (see page 20).
3. Press and release the appropriate Function key (see table below). After completing this procedure, you automatically exit HSM.

Function Key	Operation
[F2]	Enables Mac keyboard emulation, see page 27, for details.
[F6] [nn] [Enter]	Sets the keyboard language layout. Where "nn" is the two digit number that represents the keyboard language code: U.S. English: 33 French: 08 Japanese: 15
[F10]	Auto detects the keyboard operating platform (for PC compatible systems). Activates Pass Through keyboard mode (keystrokes are sent directly to the computer instead of through the Mac emulator).

List Switch Settings

To see a listing of the current switch settings, do the following:

1. Open a text editor or word processor and place the cursor in the page window.
2. Invoke HSM (see page 20).
3. Press and release **[F4]** to display the settings.

USB Reset

If the USB loses focus and needs to be reset, do the following:

1. Invoke HSM (see page 20).
2. Press and release **[F5]**

Hotkey Beeper Control

The Beeper can be hotkey toggled On and Off. To toggle the Beeper, do the following:

1. Invoke HSM (see page 20).
2. Press and release **[B]**.

The Beeper toggles On or Off.

Disable Port Switching Keys

To disable the Port Switching Keys (**[Scroll Lock] [Scroll Lock] / [Ctrl] [Ctrl]**), do the following:

1. Invoke HSM (see page 20).
2. Press **[X] [Enter]**.

Note: This procedure is a toggle. To enable the Port Switching keys repeat steps 1 and 2.

Firmware Upgrade Mode

To set the CS1942 / CS1944 to Firmware Upgrade Mode, do the following:

1. Invoke HSM (see page 20).
2. Key in: upgrade
3. Press **[Enter]**.

The front panel LEDs flash to indicate Firmware Upgrade Mode is in effect.

Note: To exit Firmware Upgrade Mode, you must power off the switch. For information on upgrading your switch see *The Firmware Upgrade Utility*, page 29.

Restore Default Settings

To reset the CS1942 / CS1944 to its default hotkey settings, do the following:

1. Invoke HSM (see page 20).
2. Press [**R**] [**Enter**].

All hotkey settings return to the factory default settings.

Keyboard Emulation

To toggle between keyboard emulation enabled and disabled, do the following:

1. Invoke HSM (see page 20).

Press [**N**].

Mouse Emulation Control

To toggle between mouse emulation enabled and disabled, do the following:

1. Invoke HSM (see page 20).
2. Press [**M**].

Mouse Port Switching

Mouse Port Switching allows you to use the mouse wheel button (clicked twice) to switch ports. For Mouse Port Switching to work Mouse Emulation must be enabled. To toggle between mouse port switching enabled and disabled, do the following:

1. Invoke HSM (see page 20).

Press [**W**].

Power On Detection

With Power on Detection if one of the video sources is powered off the CS1942 / CS1944 automatically switches to the next powered-on source. To toggle between Power on Detection enabled and disabled, do the following:

1. Invoke HSM (see page 20).

Press [**E**].

USB Quick Charge

This feature switches the front panel USB function from Datalink mode to Quick Charge mode. To toggle between Datalink mode and Quick Charge mode, do the following:

1. Invoke HSM (see page 20).

Press [**L**].

Note: The default setting is USB Datalink mode with 500mA power support. Quick Charge mode provides up to 1.4A power support.

SPC Mode

To set the keyboard and mouse to use SPC mode so that they work under special operating systems as a standard (104 key) keyboard and mouse , do the following:

1. Invoke HSM (see page 20).
2. Press [**F1**].

HSM Summary Table

After invoking HSM (see page 20), key in one of the following keys to perform the corresponding function:









Key	Function
[B]	Toggles the beeper On and Off.
[E]	Toggles between Power on Detection enable and disable.
[H]	Toggles between the default and alternate HSM invocation keys.
[L]	Switches the front panel USB function from Datalink mode to Quick Charge mode.
[M]	Toggles between mouse emulation enable and disable.
[N]	Toggles between Keyboard Emulation mode enable and disable.
[T]	Toggles between the default and alternate Port Switching keys.
[W]	Toggles between Mouse Port Switching enabled and disabled. When enabled, click the mouse wheel twice to switch ports. Mouse emulation must be enabled.
[R] [Enter]	Resets the hotkey settings to their default status.
[X] [Enter]	Enables/Disables the Port Switching keys.
[u][p][g][r][a][d][e] [Enter]	Invokes Firmware Upgrade Mode.
[F1]	Sets the keyboard and mouse to SPC mode so that they work under special operating systems as a standard (104 key) keyboard and mouse.
[F2]	Enables Mac keyboard emulation.
[F4]	Print the switch's current settings via a text editor or word processor.
[F5]	Performs a reset on all USB devices.
[F10]	Auto detects the keyboard operating platform. Activates Pass Through keyboard mode (see <i>Keyboard Operating Platform</i> , page 22).

Chapter 5

Keyboard Emulation

Mac Keyboard

The PC compatible (101/104 key) keyboard can emulate the functions of the Mac keyboard. The emulation mappings are listed in the table below.

PC Keyboard	Mac Keyboard
[Shift]	Shift
[Ctrl]	Ctrl
	
[Ctrl] [1]	
[Ctrl] [2]	
[Ctrl] [3]	
[Ctrl] [4]	
[Alt]	Alt
[Print Screen]	F13
[Scroll Lock]	F14
	=
[Enter]	Return
[Backspace]	Delete
[Insert]	Help
[Ctrl] 	F15

Note: When using key combinations, press and release the first key (Ctrl), then press and release the activation key.

This Page Intentionally Left Blank

Chapter 6

The Firmware Upgrade Utility

The Windows-based Firmware Upgrade Utility (FWUpgrade.exe) provides a smooth, automated process for upgrading the CS1942 / CS1944's firmware.

The Utility comes as part of a Firmware Upgrade Package that is specific for each device. New firmware upgrade packages are posted on our website as new firmware revisions become available. Check the website regularly to find the latest packages and information relating to them:

<http://www.aten.com>

Before you Begin

To prepare for the firmware upgrade, do the following:

1. From a computer that is connected to your KVM installation, go to our Internet support site and choose the model name that relates to your device (CS1942 / CS1944) to get a list of available Firmware Upgrade Packages.
2. Choose the Firmware Upgrade Package you want to install (usually the most recent), and download it to your computer.
3. Shut down all other computers (except the one used to download your Firmware Upgrade Package) on your CS1942 / CS1944 installation.
4. Invoke Firmware Upgrade Mode (see *Firmware Upgrade Mode*, page 23).
The front panel LEDs flash together to indicate Firmware Upgrade Mode is in effect.

Starting the Upgrade

To upgrade your firmware:

1. Run the downloaded Firmware Upgrade Package file – either by double clicking the file icon, or by opening a command line and entering the full path to it.

The *Firmware Upgrade Utility* Welcome screen appears:

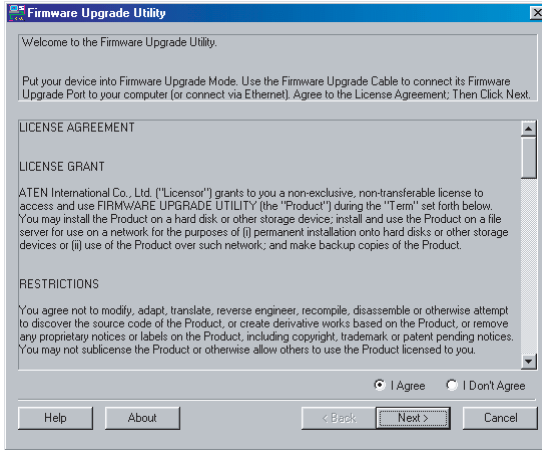

Note: The screens shown in this section are for reference only. The wording and layout of the actual screens put up by the Firmware Upgrade Utility may vary slightly from these examples.

2. Read the License Agreement (enable the *I Agree* radio button).
3. Click **Next** to continue. The Firmware Upgrade Utility main screen appears:

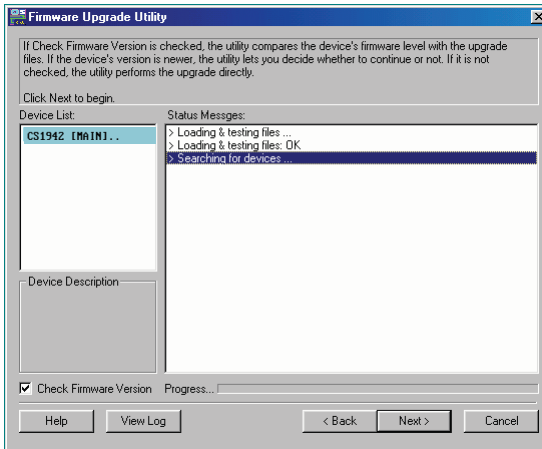

The Utility inspects your installation. All the devices capable of being upgraded by the package are listed in the *Device List* panel.

4. As you select a device in the list, its description appears in the Device Description panel.

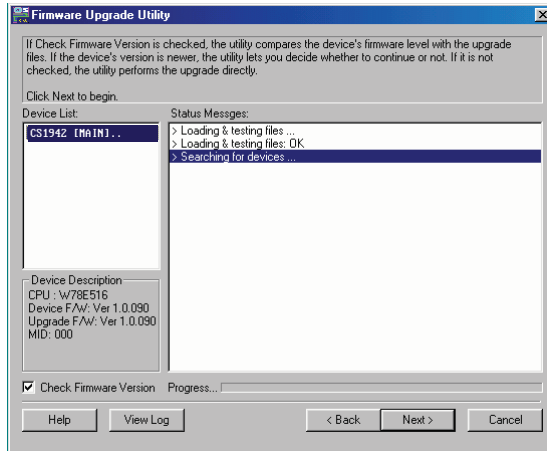

5. After you have made your device selection(s), Click **Next** to perform the upgrade.

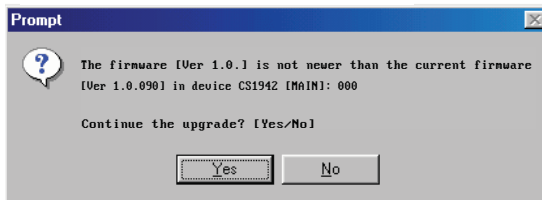

If you enabled *Check Firmware Version*, the Utility compares the device's firmware level with that of the upgrade files. If it finds that the device's version is higher than the upgrade version, it brings up a dialog box informing you of the situation and gives you the option to Continue or Cancel.

If you didn't enable *Check Firmware Version*, the Utility installs the upgrade files without checking whether they are a higher level, or not.

As the Upgrade proceeds, status messages appear in the Status Messages panel, and the progress toward completion is shown on the *Progress* bar.

Upgrade Succeeded

After the upgrade has completed, a screen appears to inform you that the procedure was successful:

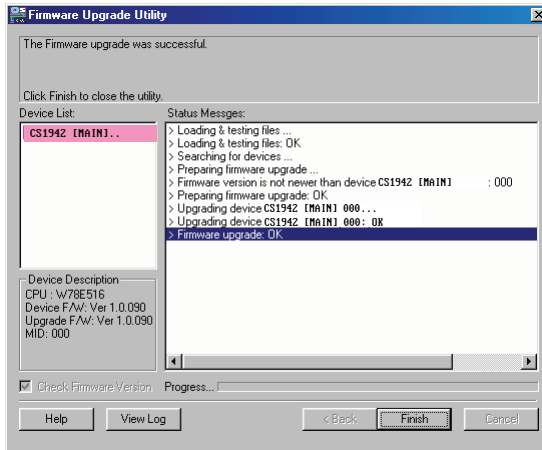

Click **Finish** to close the Firmware Upgrade Utility.

After a successful completion, the switches exit Firmware Upgrade Mode, and reset themselves.

Upgrade Failed

If the *Upgrade Succeeded* screen doesn't appear, it means that the upgrade failed to complete successfully, in which case you should do the following:

1. Unplug all USB cables and DC power adapter from the CS1942 / CS1944.
2. Plug a single USB 2.0 cable into the last CPU port with the PC powered on.
3. Plug-in the CS1942 / CS1944 DC power adapter, the CS1942 / CS1944's port LEDs will start flashing after powered back on.
4. Run the Firmware Upgrade Utility program again.

Safety Instructions

General

- ◆ Read all of these instructions. Save them for future reference.
- ◆ Follow all warnings and instructions marked on the device.
- ◆ This product is for indoor use only.
- ◆ Do not place the device on any unstable surface (cart, stand, table, etc.). If the device falls, serious damage will result.
- ◆ Do not use the device near water.
- ◆ Do not place the device near, or over, radiators or heat registers.
- ◆ The device cabinet is provided with slots and openings to allow for adequate ventilation. To ensure reliable operation, and to protect against overheating, these openings must never be blocked or covered.
- ◆ The device should never be placed on a soft surface (bed, sofa, rug, etc.) as this will block its ventilation openings. Likewise, the device should not be placed in a built in enclosure unless adequate ventilation has been provided.
- ◆ Never spill liquid of any kind on the device.
- ◆ Unplug the device from the wall outlet before cleaning. Do not use liquid or aerosol cleaners. Use a damp cloth for cleaning.
- ◆ The device should be operated from the type of power source indicated on the marking label. If you are not sure of the type of power available, consult your dealer or local power company.
- ◆ The device is designed for IT power distribution systems with 230V phase-to-phase voltage.
- ◆ To prevent damage to your installation it is important that all devices are properly grounded.
- ◆ The device is equipped with a 3-wire grounding type plug. This is a safety feature. If you are unable to insert the plug into the outlet, contact your electrician to replace your obsolete outlet. Do not attempt to defeat the purpose of the grounding-type plug. Always follow your local/national wiring codes.
- ◆ Do not allow anything to rest on the power cord or cables. Route the power cord and cables so that they cannot be stepped on or tripped over.

- ◆ If an extension cord is used with this device make sure that the total of the ampere ratings of all products used on this cord does not exceed the extension cord ampere rating. Make sure that the total of all products plugged into the wall outlet does not exceed 15 amperes.
- ◆ To help protect your system from sudden, transient increases and decreases in electrical power, use a surge suppressor, line conditioner, or un-interruptible power supply (UPS).
- ◆ Position system cables and power cables carefully; Be sure that nothing rests on any cables.
- ◆ Never push objects of any kind into or through cabinet slots. They may touch dangerous voltage points or short out parts resulting in a risk of fire or electrical shock.
- ◆ Do not attempt to service the device yourself. Refer all servicing to qualified service personnel.
- ◆ If the following conditions occur, unplug the device from the wall outlet and bring it to qualified service personnel for repair.
 - ◆ The power cord or plug has become damaged or frayed.
 - ◆ Liquid has been spilled into the device.
 - ◆ The device has been exposed to rain or water.
 - ◆ The device has been dropped, or the cabinet has been damaged.
 - ◆ The device exhibits a distinct change in performance, indicating a need for service.
 - ◆ The device does not operate normally when the operating instructions are followed.
- ◆ Only adjust those controls that are covered in the operating instructions. Improper adjustment of other controls may result in damage that will require extensive work by a qualified technician to repair.
- ◆ Do not connect the RJ-11 connector marked “UPGRADE” to a public telecommunication network.

Technical Support

International

- ◆ For online technical support – including troubleshooting, documentation, and software updates: <http://eservice.aten.com>
- ◆ For telephone support, see *Telephone Support*, page iii:

North America

Email Support		support@aten-usa.com
Online Technical Support	Troubleshooting Documentation Software Updates	http://www.aten-usa.com/support
Telephone Support		1-888-999-ATEN ext 4988

When you contact us, please have the following information ready beforehand:

- ◆ Product model number, serial number, and date of purchase.
- ◆ Your computer configuration, including operating system, revision level, expansion cards, and software.
- ◆ Any error messages displayed at the time the error occurred.
- ◆ The sequence of operations that led up to the error.
- ◆ Any other information you feel may be of help.

Specifications

Function		CS1942	CS1944	
Computer Connections		2	4	
Port Selection		Touch Panel, Hotkey, Mouse*		
Connectors	Console Ports	Keyboard	1 x USB Type A F (Black, rear panel)	
		Video	2 x Mini DisplayPort F (Black)	
		Mouse	1 x USB Type A F (Black, rear panel)	
		Speaker	1 x Mini-TOSLINK Jack F (Black, rear panel) 1 x 3.5mm Audio Jack F (Green, front panel)	
		Microphone	1 x Mini-TOSLINK Jack F (Black, rear panel) 1 x 3.5mm Audio Jack F (Pink, front panel)	
	KVM Ports	Keyboard/ Mouse	2 x USB Type B F (White)	4 x USB Type B F (White)
		Video	4 x Mini DisplayPort F (Black)	8 x Mini DisplayPort F (Black)
		Speaker	2 x Mini-TOSLINK Jack F (Black)	4 x Mini-TOSLINK Jack F (Black)
		Microphone	2 x Mini-TOSLINK Jack F (Black)	4 x Mini-TOSLINK Jack F (Black)
	USB 2.0 Hub		2 x USB Type A F (White; 1 x Front panel, 1 x Rear panel)	
Power		1 x DC Jack		
Switches	Selected	3 x Point Touch Panel	5 x Point Touch Panel	
LEDs	KVM	2 x Orange	4 x Orange	
	Audio	2 x Green	4 x Green	
	USB	2 x Green	4 x Green	
Emulation	Keyboard/Mouse	USB		
Video		DP: 2560 x 1600 resolution @ 60Hz, or 3D Display 1920 x 1080 resolution @ 120Hz		
Scan Interval		1 ~ 99 seconds (Default: 5 seconds)		
Power Consumption		DC 5.3V, 6.68W	DC 5.3V, 8.63W	
Environment	Operation Temp.	0–50°C		
	Storage Temp.	-20–60°C		
	Humidity	0–80% RH, Non-condensing		
Physical Properties	Housing	Plastic		
	Weight	556 g	614 g	
	Dimension (L x W x H)	197 x 197 x 44.7 mm		

*Port switching only works with 3-key USB mouse wheel in emulation mode.

Troubleshooting

Overview

Operation problems can be due to a variety of causes. The first step in solving them is to make sure that all cables are securely attached and seated completely in their sockets.

In addition, updating the product's firmware may solve problems that have been discovered and resolved since the prior version was released. If your product is not running the latest firmware version, we strongly recommend that you upgrade. *The Firmware Upgrade Utility*, page 29, for upgrade details.

Symptom	Possible Cause	Action
Erratic behavior.	Unit not receiving enough power.	Use a DC 5.3 V power adapter if you are not already using one. If you are already using a power adapter, check that it matches the system specifications, and that it is plugged in and functioning properly.
	Keyboard and/or mouse need to be reset.	Unplug the cable(s) from the console port(s), then plug it/them back in.
	No connection to the computer.	Check the cable from the switch to the computer to make sure it is properly connected.
	KVM switch needs to be reset.	Power off all devices on the installation; power off the KVM switch; wait five seconds; then power up.
USB devices not responding.	USB ports need to be reset.	Unplug the device's USB cable from the USB port on the switch's rear panel, then plug it back in.
		Use the USB Reset hotkey combination (see page 23), to reset the USB ports.
Cannot switch ports by pressing [Scroll Lock] twice	Keyboard is incompatible with Scroll Lock invocation.	Switch to the Alternate HSM invocation keys. See page 21 for details.
Monitor does not display after KVM cable set is hot plugged.	Some graphics cards are incompatible with cable set hot plugging.	Power off all devices on the installation; power off the CS1942 / CS1944; confirm all KVM cables are properly connected; power on the CS1942 / CS1944; power on the computers

Symptom	Possible Cause	Action
When switching ports, the monitor does not display.	Monitor is new or this is the first time installation.	Switch ports again and wait two or more seconds for the monitor's EDID to pass to the PC.
When switching ports, there is a several second delay before the change happens.	This can occur when keyboard emulation is disabled.	Use the [F10] hotkey to enable keyboard emulation. See <i>Keyboard Operating Platform</i> , page 22.

Factory Default Settings

The factory default settings are as follows:

Setting	Default	Alternate
Port Switching	[Scroll Lock] [Scroll Lock]	[Ctrl] [Ctrl]
Invoke HSM	[Num Lock] + -	[Ctrl] + [F12]
Auto Scan Interval	5 Seconds	1~99 Seconds
Keyboard OS Platform	PC Compatible	Mac, Linux
Mouse Emulation	Enabled	Disabled
Mouse Port-switching	Disabled	Enabled
Power-on Detection	Enabled	Disabled
Keyboard Emulation	Enabled	Disabled
Firmware Upgrade Mode	Disabled	Enabled
Port Switching Keys	Enabled	Disabled
Buzzer	Enabled	Disabled
Keyboard Language Layout	English	Japanese, French

Limited Warranty

IN NO EVENT SHALL THE DIRECT VENDOR'S LIABILITY EXCEED THE PRICE PAID FOR THE PRODUCT FROM DIRECT, INDIRECT, SPECIAL, INCIDENTAL, OR CONSEQUENTIAL DAMAGES RESULTING FROM THE USE OF THE PRODUCT, DISK, OR ITS DOCUMENTATION.

The direct vendor makes no warranty or representation, expressed, implied, or statutory with respect to the contents or use of this documentation, and especially disclaims its quality, performance, merchantability, or fitness for any particular purpose.

The direct vendor also reserves the right to revise or update the device or documentation without obligation to notify any individual or entity of such revisions, or update. For further inquiries, please contact your direct vendor.

Manual Part No. PAPE-0351-AT2G



Printing Date: 2014-12-15

© Copyright 2008–2014 ATEN® International Co., Ltd.

ATEN and the ATEN logo are registered trademarks of ATEN International Co., Ltd. All rights reserved.
All other brand names and trademarks are the registered property of their respective owners.