



BOSCH

Register your
new device on
MyBosch now and
get free benefits:
[bosch-home.com/
welcome](https://www.bosch-home.com/welcome)



Wine storage compartment

KUW21..

[en]

User manual

Table of contents

Safety	3	Presentation mode	14
General information	3	Alarm	14
Intended use.....	3	Door alarm	14
Restriction on user group.....	3	Temperature alarm	14
Safe transport.....	4	Wine storage compartment	14
Safe installation	4	Arranging the maximum number	
Safe use	5	of standard bottles	14
Damaged appliance	6	Tips for storing wine.....	15
Preventing material damage	8	Drinking temperatures.....	15
Environmental protection and		Defrosting	16
saving energy	8	Defrosting in the wine storage	
Disposing of packaging	8	compartment	16
Saving energy.....	8	Cleaning and servicing	16
Installation and connection	9	Preparing the appliance for	
Scope of delivery.....	9	cleaning	16
Installing and connecting the ap-		Cleaning the appliance	16
pliance	9	Cleaning the condensation	
Criteria for the installation loca-		channel and drainage hole	17
tion.....	9	Removing the fittings.....	17
Preparing the appliance for the		Troubleshooting	18
first time	10	Malfunctions	18
Connecting the appliance to the		Information on display panel.....	18
electricity supply	10	Temperature problem.....	19
Familiarising yourself with		Noise	19
your appliance	11	Odours.....	20
Appliance	11	Storage and disposal	21
Controls	12	Switching off the appliance	21
Features	12	Disposing of old appliance	21
Bottle shelf.....	12	Customer Service	21
Basic operation	13	Product number (E-Nr.) and pro-	
Switching on the appliance	13	duction number (FD)	22
Operating tips.....	13	Technical data	22
Switching off the appliance	13		
Setting the temperature.....	13		
Button lock (childproof lock).....	13		
Additional functions	13		
Interior lighting.....	13		



Safety

Please read the safety information to ensure that you use the appliance safely.

General information

You can find general information for this instruction manual here.

- Read this instruction manual carefully. Only this will ensure you use the appliance safely and efficiently.
- This manual is intended for the user of the appliance.
- Follow the safety instructions and warnings.
- Keep the instruction manual and the product information safe for future reference or for the next owner.
- Check the appliance after unpacking it. Do not connect the appliance if it has been damaged in transit.

Intended use

Read the information on intended use to ensure that you use the appliance correctly and safely.

Only use this appliance:

- As specified in this instruction manual.
- For storing wine.
- In private households and in enclosed spaces in a domestic environment.
- Up to an altitude of max. 2000 m above sea level.

Restriction on user group

Avoid risks to children and vulnerable persons.

This appliance may be used by children aged 8 or over and by people who have reduced physical, sensory or mental abilities or inadequate experience and/or knowledge, provided that they are supervised or have been instructed on how to use the appliance safely and have understood the resulting dangers.

Children must not play with the appliance.

Cleaning and user maintenance must not be performed by children unless they are being supervised.

Keep children under the age of 8 years away from the appliance and power cable.

Safe transport

Follow these safety instructions when transporting the appliance.

WARNING – Risk of injury!

The high weight of the appliance may result in injury when lifted.

- ▶ Do not lift the appliance on your own.

Safe installation

Follow these safety instructions when installing the appliance.

WARNING – Risk of electric shock!

- Improper installation is dangerous.
 - ▶ Connect and operate the appliance only in accordance with the specifications on the rating plate.
 - ▶ Connect the appliance to a power supply with alternating current only via a properly installed socket with earthing.
 - ▶ The protective conductor system of the domestic electrical installation must be properly installed.
 - ▶ Never equip the appliance with an external switching device, e.g. a timer or remote control.
 - ▶ When the appliance is installed, the mains plug of the power cord must be freely accessible. If free access is not possible, an all-pole isolating switch must be installed in the permanent electrical installation according to the installation regulations.
 - ▶ When installing the appliance, check that the power cable is not trapped or damaged.
- If the insulation of the power cord is damaged, this is dangerous.
 - ▶ Never let the power cord come into contact with heat sources.
 - ▶ Never let the power cord come into contact with sharp points or edges.

- ▶ Never kink, crush or modify the power cord.

⚠ WARNING – Risk of explosion!

If the appliance's ventilation openings are sealed, a leak in the refrigeration circuit may result in a flammable mixture of gas and air.

- ▶ Keep ventilation openings, in the appliance enclosure or in the built-in structure, clear of obstruction.

⚠ WARNING – Risk of fire!

- It is dangerous to use an extended power cord and non-approved adapters.
 - ▶ Do not use extension cables or multiple socket strips.
 - ▶ If the power cord is too short, contact Customer Service.
 - ▶ Only use adapters approved by the manufacturer.
- Portable multiple socket strips or portable power supply units may overheat and cause a fire.
 - ▶ Do not place portable multiple socket strips or power supply units on the back of the appliance.

Safe use

Follow these safety instructions when using the appliance.

⚠ WARNING – Risk of electric shock!

An ingress of moisture can cause an electric shock.

- ▶ Only use the appliance in enclosed spaces.
- ▶ Never expose the appliance to intense heat or humidity.
- ▶ Do not use steam- or high-pressure cleaners to clean the appliance.

⚠ WARNING – Risk of suffocation!

- Children may put packaging material over their heads or wrap themselves up in it and suffocate.
 - ▶ Keep packaging material away from children.
 - ▶ Do not let children play with packaging material.
- Children may breathe in or swallow small parts, causing them to suffocate.
 - ▶ Keep small parts away from children.

- ▶ Do not let children play with small parts.

⚠ WARNING – Risk of explosion!

- Mechanical devices or other devices may damage the refrigeration circuit; flammable refrigerant may escape and explode.
 - ▶ To accelerate the defrosting process, do not use any other mechanical devices or devices other than those recommended by the manufacturer.
- Products which contain flammable propellants and explosive substances may explode, e.g. spray cans.
 - ▶ Do not store products which contain flammable propellants (e.g. spray cans) or explosive substances in the appliance.

⚠ WARNING – Risk of fire!

Electrical devices within the appliance may cause a fire, e.g. heaters or electric ice makers.

- ▶ Do not operate electrical devices within the appliance.

⚠ WARNING – Risk of injury!

Injury to the eyes caused by escaping flammable refrigerant and hazardous gases.

- ▶ Do not damage the tubes of the refrigerant circuit or the insulation.

Damaged appliance

Follow the safety instructions if your appliance is damaged.

⚠ WARNING – Risk of electric shock!

- If the appliance or the power cord is damaged, this is dangerous.
 - ▶ Never operate a damaged appliance.
 - ▶ Never operate an appliance with a cracked or fractured surface.
 - ▶ Never pull on the power cord to unplug the appliance. Always unplug the appliance at the mains.
 - ▶ If the appliance or the power cord is damaged, immediately unplug the power cord or switch off the fuse in the fuse box.

- ▶ "Call Customer Service." → *Page 21*
- ▶ Repairs to the appliance should only be carried out by trained specialist staff.
- Incorrect repairs are dangerous.
 - ▶ Repairs to the appliance should only be carried out by trained specialist staff.
 - ▶ Only use genuine spare parts when repairing the appliance.
 - ▶ If the power cord of this appliance is damaged, it must be replaced by the manufacturer, the manufacturer's Customer Service or a similarly qualified person in order to prevent any risk.

 **WARNING – Risk of fire!**



If the tubes are damaged, flammable refrigerant and harmful gases may escape and ignite.

- ▶ Keep naked flames and ignition sources away from the appliance.
- ▶ Ventilate the room.
- ▶ "Switch off the appliance." → *Page 13*
- ▶ Unplug the appliance from the mains or switch off the circuit breaker in the fuse box.
- ▶ "Call after-sales service." → *Page 21*

Preventing material damage

Follow these instructions to prevent material damage to your appliance, accessories or other objects in your kitchen.

ATTENTION!

- Using the base, runners or appliance doors as a seat surface or climbing surface may damage the appliance.
 - ▶ Do not stand or support yourself on the base, runners or doors.
- Contamination with oil or fat may cause plastic parts and door seals to become porous.
 - ▶ Keep plastic parts and door seals free of oil and grease.

Environmental protection and saving energy

Help protect the environment by using your appliance in a way that conserves resources and by disposing of reusable materials properly.

Disposing of packaging

The packaging materials are environmentally compatible and can be recycled.

- ▶ Sort the individual components by type and dispose of them separately.

Information about current disposal methods are available from your specialist dealer or local authority.

Saving energy

If you follow these instructions, your appliance will use less power.

Selecting the installation location

Follow these instructions when installing your appliance.

- Keep the appliance out of direct sunlight.
- Install the appliance as far away as possible from heating elements, cookers and other heat sources:
 - Maintain a 30 mm clearance to electric or gas cookers.
 - Maintain a 300 cm clearance to oil or solid-fuel cookers.
- Do not cover or block ventilation openings.

Saving energy during use

Follow these instructions when using your appliance.

Note: The arrangement of the fittings does not affect the energy consumption of the appliance.

- Do not cover or block ventilation openings.
- Open the appliance door only briefly.

Installation and connection

You can find out where and how best to install your appliance here. You will also learn how to connect your appliance to the power supply.

Scope of delivery

After unpacking all parts, check for any transport damage and for completeness of delivery.

If you have any complaints, contact your dealer or our "after-sales service" → *Page 21*.

The delivery consists of the following:

- Built-under appliance
- Equipment and accessories¹
- Installation material
- Installation instructions
- User manual
- Customer service directory
- Warranty enclosure²
- Energy label
- Information on energy consumption and noises

Installing and connecting the appliance

Requirement: "The scope of delivery of the appliance is checked."
→ *Page 9*

1. "Observe the criteria for the appliance's installation location."
→ *Page 9*
2. Install the appliance in accordance with the enclosed installation instructions.
3. "Prepare the appliance for first use." → *Page 10*

4. "Electrically connect the appliance." → *Page 10*

Criteria for the installation location

Follow these instructions when installing your appliance.

WARNING **Risk of explosion!**

If the appliance is in a space that is too small, a leak in the refrigeration circuit may result in a flammable mixture of gas and air.

- ▶ Only install the appliance in a space with a volume of at least 1 m³ per 8 g refrigerant. The volume of refrigerant is indicated on the rating plate. → "Appliance", *Fig. 1/4*, *Page 11*

The weight of the appliance ex works may be up to 70 kg depending on the model.

The subfloor must be sufficiently stable to bear the weight of the appliance.

Permitted room temperature

The permitted room temperature depends on the appliance's climate class.

The climate class can be found on the rating plate. → "Appliance", *Fig.*

1/4, *Page 11*

Climate class	Permitted room temperature
SN	10 °C to 32 °C
N	16 °C to 32 °C
ST	16 °C to 38 °C
T	16 °C to 43 °C

¹ Depending on the appliance specifications

² Not in all countries

en Installation and connection

The appliance is fully functional within the permitted room temperature.

If an appliance with climate class SN is operated at colder room temperatures, the appliance will not be damaged up to a room temperature of 5 °C.

Preparing the appliance for the first time

1. Remove the informative material.
2. Remove the protective foil and transit bolts, e.g. remove the adhesive strips and carton.
3. "Clean the appliance for the first time." → *Page 16*

Connecting the appliance to the electricity supply

1. Insert the mains plug of the appliance's power cable in a socket nearby.

The connection data of the appliance can be found on the rating plate. → "Appliance", Fig. **1**/**4**, *Page 11*

2. Check the mains plug is inserted properly.
- ✓ The appliance is now ready for use.

Familiarising yourself with your appliance

Familiarise yourself with the parts of your appliance.

Appliance

You can find an overview of the parts of your appliance here.

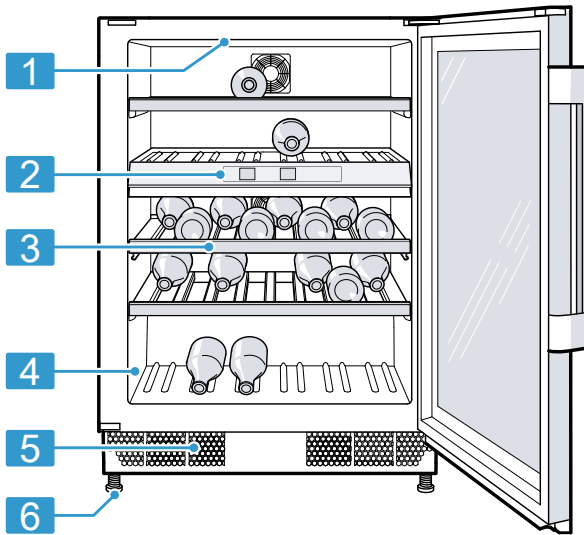
**1****1** Interior lighting**2** Controls**3** Bottle shelf**4** Rating plate

5 Ventilation grille

6 Screw foot

Note: Deviations between your appliance and the diagrams may differ with regard to their features and size.

Controls

You can use the control panel to configure all functions of your appliance and to obtain information about the operating status.

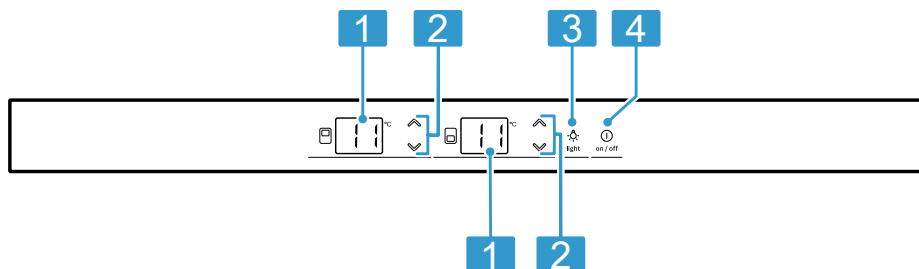

2

1 Displays the set temperature of the wine-storage compartment °C.

2 ∇/∧ sets the temperature of the wine storage compartment.

3 ☼ switches the interior lighting on or off.

4 ⏻ switches the appliance on or off.

Bottle shelf

Store bottles securely on the bottle shelf.

ATTENTION!

If you exceed the maximum load-bearing capacity, this may damage the bottle trays and holders.

- ▶ Do not exceed the maximum weight of 8 kg per bottle rack.

To store the maximum number of bottles, you can remove the bottle trays.

→ "Removing the bottle shelf",
Page 17

Tip: If you insert the short bottle shelf at the lowest holder, you can set bottles vertically on the appliance floor.

Features

Here you can see an overview of the features of your appliance and their use.

The features of your appliance depend on the model.

Basic operation

You can find out everything you need to know about operating your appliance here.

Switching on the appliance

1. "Electrically connect the appliance." → *Page 10*

Note: If the appliance was previously switched off using the controls, press .

- ✓ The appliance begins to cool.
2. "Set the required temperature." → *Page 13*

Operating tips

- Once you have switched on the appliance, the set temperature is only reached after several hours.
- When you close the door, a vacuum may be created. The door is then difficult to open again. Wait a moment until the vacuum is offset.

Switching off the appliance

- ▶ Press .
- ✓ The appliance stops cooling.

Setting the temperature

After you have switched on the appliance, you can set the temperature.

Setting the temperature of the wine storage compartment







- ▶ Press  repeatedly until the temperature display shows the required temperature.

Note: If you press and hold  for a longer time, the temperature value changes continuously.

Button lock (childproof lock)







The button lock prevents the appliance from being operated accidentally or incorrectly while running.

Switching on the button lock

- ▶ Press and hold  () +  () at the same time for three seconds.
- ✓ The temperature displays show  and  for three seconds, then the temperature that was previously set is displayed again.

Note: If you press a touch field while the button lock is switched on, the temperature display indicates  for three seconds.

Switching off the button lock

- ▶ Press and hold  () +  () at the same time for three seconds.
- ✓ The temperature displays show  and  for three seconds, then the temperature that was previously set is displayed again.

Additional functions

Find out which additional functions can be used for your appliance.

Interior lighting

The interior lighting switches on automatically when you open the appliance.

Tip: If the interior lighting is switched on when the door is closed too, you can switch on the presentation mode.

Switching on the interior lighting

- ▶ Press .

Switching off the interior lighting

- ▶ Press .
- ✓ The interior lighting is permanently switched off.

Presentation mode

In presentation mode, the interior lighting is permanently switched on.

Switching on the presentation mode

- ▶ Press and hold  for three seconds.
- ✓ If the interior lighting is switched on, the interior lighting remains switched on, even if the appliance door is closed.

Switching off the presentation mode

- ▶ Press and hold  for three seconds.

Alarm

Your appliance is equipped with alarm functions.

Door alarm

If the appliance door is open for a longer period, the door alarm switches on.

Switching off the door alarm

- ▶ Close the appliance door.
- ✓ The warning tone is switched off.

Temperature alarm

If the wine storage compartment is too warm or too cold for an extended period, the temperature alarm switches on.

If the temperature in a wine storage compartment lies more than 2 °C below the set temperature for an exten-

ded period, a warning signal sounds and **L0** flashes in the corresponding temperature display.

If the temperature in a wine storage compartment lies more than 5 °C above the set temperature for an extended period, a warning signal sounds and **H I** flashes in the corresponding temperature display.

Switching off the temperature alarm

- ▶ Press any touch field.
- ✓ The warning tone is switched off.

Note: **L0** or **H I** flashes until the set temperature is reached again.

Wine storage compartment

In the wine storage compartment, you store wine at a constant temperature.

You can set the temperature in the refrigerator compartment from 5 °C to 20 °C.

Arranging the maximum number of standard bottles

- ▶ To place the maximum number of bottles in the appliance, place wine bottles into the appliance laying down with the neck of the bottle facing forwards.

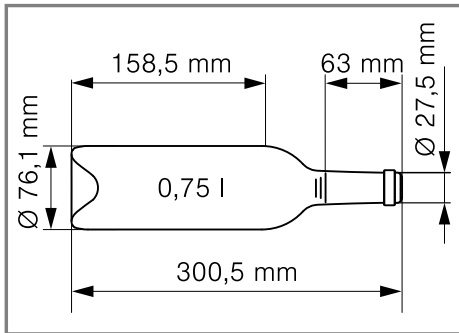

Standard bottle

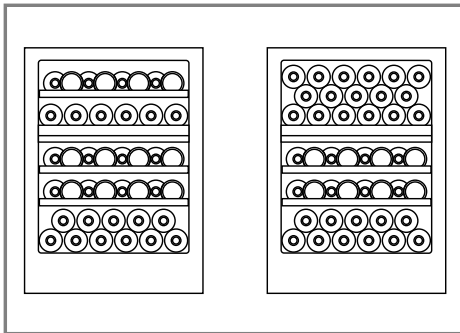

Storage example with 38 standard bottles and 44 standard bottles

Note: If you remove the top bottle tray, instead of 38 standard bottles, you can place a total of 44 standard bottles in the appliance.

Tips for storing wine

Note the following tips for storing wine.

- Do not store the wine bottles in crates or boxes in the appliance. The open bottle shelves allow for continuous air circulation. As a result, excess humidity is quickly removed.
- Before you enjoy your wine, you should slowly warm it to room temperature. Take rosé out of the appliance two to five hours before consuming, and take red wine out

of the appliance four to five hours before consuming. Serve white wine immediately after taking it out of the appliance. Sparkling wine and champagne should be chilled in the refrigerator for a short while before drinking.

- Always store wine a little cooler than its ideal serving temperature, as the wine warms up as soon as it is poured into the glass.

Drinking temperatures

The correct serving temperature is crucial for the taste of the wine.

Type of wine	Drinking temperature
Full-bodied red Bordeaux	18 °C
Côtes du Rhône red, Barolo	17 °C
Full-bodied red Burgundy, red Bordeaux	16 °C
Port	15 °C
Young red Burgundy	14 °C
Young red wines	12 °C
Young Beaujolais, all white wines with little residual sugar	11 °C
Old white wines, full-bodied Chardonnay	10 °C
Sherry	9 °C
Young white wines, from late vintage onward	8 °C
Loire, Entre-deux-Mers white wines	7 °C

Defrosting

Observe the information when you want to defrost your appliance.

Defrosting in the wine storage compartment

When the appliance is operating, condensation droplets or frost form on the rear panel of the wine storage compartment due to functional reasons. The back panel in the wine storage compartment defrosts automatically.

The condensation drains into the drainage hole via the condensation channel.

To ensure that the condensation can drain and odours do not form, observe the following information:

→ *"Cleaning the condensation channel and drainage hole", Page 17.*

Cleaning and servicing

To keep your appliance working efficiently for a long time, it is important to clean and maintain it carefully. Customer Service must clean inaccessible points. Cleaning by customer service can give rise to costs.

Preparing the appliance for cleaning

Find out how to prepare your appliance for cleaning.

1. "Switch off the appliance."
→ *Page 13*
2. Disconnect the appliance from the power supply.
Unplug the appliance from the mains or switch off the circuit breaker in the fuse box.

3. "Remove all fittings from the appliance." → *Page 17*

Cleaning the appliance

Clean the appliance as specified to ensure that it is not damaged by incorrect cleaning or unsuitable cleaning products.

WARNING **Risk of electric shock!**

- An ingress of moisture can cause an electric shock.
 - ▶ Do not use steam- or high-pressure cleaners to clean the appliance.
- Liquid in the lighting or in the controls can be dangerous.
 - ▶ The rinsing water must not drip into the lighting or controls.

ATTENTION!

- Unsuitable cleaning products may damage the surfaces of the appliance.
 - ▶ Do not use hard scouring pads or cleaning sponges.
 - ▶ Do not use harsh or abrasive detergents.
 - ▶ Do not use cleaning products with a high alcohol content.
 - If you clean fittings and accessories in the dishwasher, this may cause them to become deformed or discoloured.
 - ▶ Never clean fittings and accessories in the dishwasher.
1. "Prepare the appliance for cleaning." → *Page 16*
 2. Clean the appliance, the fittings and the door seals with a dish cloth, lukewarm water and a little pH-neutral washing-up liquid.
 3. Dry thoroughly with a soft, dry cloth.
 4. Insert the fittings.

- Electrically connect the appliance.

Cleaning the condensation channel and drainage hole

Regularly clean the condensation channel and drainage hole to ensure that the condensation can drain.

- Carefully clean the condensation channel and the drainage hole, e.g. using a moistened cotton bud.

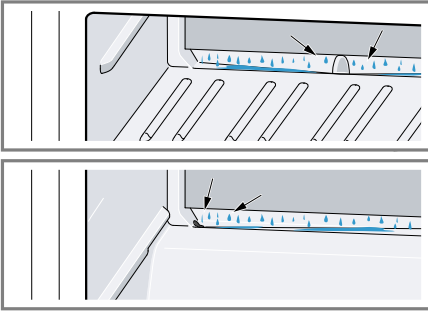

Removing the fittings

If you want to clean the fittings thoroughly, remove these from your appliance.

Removing the bottle shelf

- Slightly lift the rear of the bottle tray and remove it.

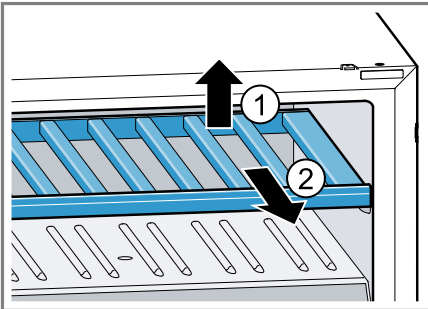

Troubleshooting

You can rectify minor faults on your appliance yourself. Read the troubleshooting information before contacting after-sales service. This will avoid unnecessary costs.

WARNING

Risk of electric shock!

Incorrect repairs are dangerous.

- ▶ Repairs to the appliance should only be carried out by trained specialist staff.
- ▶ Only use genuine spare parts when repairing the appliance.
- ▶ If the power cord of this appliance is damaged, it must be replaced by the manufacturer, the manufacturer's Customer Service or a similarly qualified person in order to prevent any risk.

Malfunions

Fault	Cause	troubleshooting
The appliance is not working. No displays light up.	The mains plug has not been inserted properly.	▶ Check whether the mains plug for the power cord is fully inserted into the socket.
	Fuse has been tripped.	▶ Check the fuses.
	The power has failed.	▶ Check whether the power is on.
The LED lighting does not work. Do not remove the lamp cover.	Different causes are possible.	▶ Call the after-sales service. → "Customer Service", Page 21
The refrigeration unit is switching on more frequently and for longer.	The appliance door was opened frequently.	▶ Do not open appliance door unnecessarily.
	The ventilation openings are covered up.	▶ Remove any obstructions from in front of the ventilation openings.
The base of the refrigerator compartment is wet.	The condensation channel or drainage hole are blocked.	▶ "Clean the condensation channel and the drainage hole." → Page 17

Information on display panel

Fault	Cause	troubleshooting
E or d appears in the temperature display.	The electronics have detected a fault.	▶ Call the after-sales service. → "Customer Service", Page 21
⏏ appears in the temperature display.	The button lock is switched on.	▶ "Switch off the button lock." → Page 13

Fault	Cause	troubleshooting
A warning signal sounds and H i flashes in the temperature display.	It was too warm in the wine storage compartment for an extended period. The ventilation openings are covered up.	▶ Press any touch field. Note: H i flashes until the set temperature is reached again.
A warning signal sounds and L U flashes in the temperature display.	It was too cold in the wine storage compartment for an extended period.	▶ Press any touch field. Note: L U flashes until the set temperature is reached again.

Temperature problem

Fault	Cause	troubleshooting
The temperature differs greatly from the setting.	Different causes are possible.	<ol style="list-style-type: none"> 1. "Switch off the appliance." → <i>Page 13</i> 2. "Switch the appliance back on after five minutes." → <i>Page 13</i> <ul style="list-style-type: none"> – If the temperature is too warm, check the temperature again after a couple of hours. – If the temperature is too cold, check the temperature again on the following day.

Noise

Fault	Cause	troubleshooting
Appliance has a humming sound.	Not a fault. A motor is running, e.g. refrigerating unit, fan.	No action required.
The appliance bubbles, buzzes or gargles.	Not a fault. Refrigerant flows through the pipes.	No action required.
The appliance clicks.	Not a fault. Motor, switches or solenoid valves are switching on or off.	No action required.
The appliance makes noises.	Fittings wobble or stick.	▶ Check the removable fittings and, if required, replace these.

Odours

Fault	Cause	troubleshooting
The appliance has an unpleasant smell.	Different causes are possible.	<ol style="list-style-type: none">1. "Prepare the appliance for cleaning." → <i>Page 16</i>2. "Clean the appliance." → <i>Page 16</i>3. Clean all of the bottles and check whether the bottle cap is tight.4. After 24 hours, check whether odours are still forming.

Storage and disposal

You can find out here how to prepare your appliance for storage. You will also find out how to dispose of old appliances.

Switching off the appliance

1. "Switch off the appliance."
→ *Page 13*
2. Disconnect the appliance from the power supply.
Unplug the appliance from the mains or switch off the circuit breaker in the fuse box.
3. "Defrost the appliance." → *Page 16*
4. "Clean the appliance." → *Page 16*
5. To ensure the ventilation inside the appliance, leave the appliance open.

Disposing of old appliance

Valuable raw materials can be re-used by recycling.

WARNING **Risk of harm to health!**

Children can lock themselves in the appliance, thereby putting their lives at risk.

- ▶ Leave shelves and containers inside the appliance to prevent children from climbing in.
- ▶ Keep children away from the redundant appliance.

WARNING **Risk of fire!**

If the tubes are damaged, flammable refrigerant and harmful gases may escape and ignite.

- ▶ Do not damage the tubes of the refrigerant circuit or the insulation.

1. Unplug the appliance from the mains.
2. Cut through the power cord.
3. Dispose of the appliance in an environmentally friendly manner.



This appliance is labelled in accordance with European Directive 2012/19/EU concerning used electrical and electronic appliances (waste electrical and electronic equipment - WEEE). The guideline determines the framework for the return and recycling of used appliances as applicable throughout the EU.

Customer Service

If you have any queries, are unable to rectify faults on the appliance yourself or if your appliance needs to be repaired, contact Customer Service. You can solve many problems yourself by consulting the information on troubleshooting in these instructions or on our website. If this is not the case, contact our after-sales service. We will always find an appropriate solution and try to avoid unnecessary visits being made by a Customer Service technician.

With any warranty claims, we will make sure that your appliance is repaired by trained after-sales technicians using genuine spare parts, including after the manufacturer's warranty has expired.

For safety reasons repairs to the appliance should only be carried out by trained specialist staff. The warranty claim becomes void if repairs or interventions have been carried out by persons not authorised by us for that purpose or if our appliances have been fitted with spare, supplementary

or accessory parts that were not genuine parts and then resulted in a defect.

Function-relevant genuine spare parts according to the corresponding Eco-design Order can be obtained from Customer Service for a period of at least 10 years from the date on which your appliance was placed on the market within the European Economic Area.

Note: Under the terms of the manufacturer's warranty applicable to the location, the use of Customer Service is free of charge. The minimum duration of the warranty (manufacturer's warranty for private consumers) in the European Economic Area is 2 years according to the terms of warranty applicable to the location. The terms of warranty do not affect other rights or claims held by yourself under local legislation.

Detailed information on the warranty period and terms of warranty in your country is available from our after-sales service, your retailer or on our website.

If you contact Customer Service, you will require the product number (E-Nr.) and the production number (FD) of your appliance.

The contact details for Customer Service can be found in the enclosed Customer Service directory or on our website.

Product number (E-Nr.) and production number (FD)

You can find the product number (E-Nr.) and the production number (FD) on the appliance's rating plate.

→ "Appliance", Fig. 1/4, Page 11

Make a note of your appliance's details and the Customer Service telephone number to find them again quickly.

Technical data

Refrigerant, cubic capacity and further technical specifications can be found on the rating plate.

→ "Appliance", Fig. 1/4, Page 11
More information about your model can be found online at <https://energylabel.bsh-group.com>¹. This web address is linked to the official EU EPREL product database. At the time of printing its web address had not yet been published. Please then follow the instructions on searching for models. The model identifier is made up of the characters before the slash in the product number (E-Nr.) on the rating plate. Alternatively you can also find the model identifier in the first line of the EU energy label.

¹ Only applies to countries in the European Economic Area



Thank you for buying a Bosch Home Appliance!

Register your new device on MyBosch now and profit directly from:

- **Expert tips & tricks for your appliance**
- **Warranty extension options**
- **Discounts for accessories & spare-parts**
- **Digital manual and all appliance data at hand**
- **Easy access to Bosch Home Appliances Service**

Free and easy registration – also on mobile phones:

www.bosch-home.com/welcome



Looking for help? You'll find it here.

Expert advice for your Bosch home appliances, help with problems or a repair from Bosch experts.

Find out everything about the many ways Bosch can support you:

www.bosch-home.com/service

Contact data of all countries are listed in the attached service directory.

Robert Bosch Hausgeräte GmbH

Carl-Wery-Straße 34

81739 München

GERMANY

www.bosch-home.com



9001581604 (000807)

en