



Questo manuale d'istruzione è fornito da trovaprezzi.it. Scopri tutte le offerte per [Bose Bass Module 700 Nero](#) o cerca il tuo prodotto tra le [migliori offerte di Diffusori Audio](#)



BASS MODULE 700

Please read and keep all safety, security, and use instructions.

CE Bose Corporation hereby declares that this product is in compliance with the essential requirements and other relevant provisions of Directive 2014/53/EU and all other applicable EU directive requirements. The complete declaration of conformity can be found at: www.Bose.com/compliance

**UK
CA** This product conforms to all applicable Electromagnetic Compatibility Regulations 2016 and all other applicable UK regulations. The complete declaration of conformity can be found at: www.Bose.com/compliance

Bose Corporation hereby declares that this product is in compliance with the essential requirements per Radio Equipment Regulations 2017 and all other applicable UK regulations. The complete declaration of conformity can be found at: www.Bose.com/compliance

Important Safety Instructions

1. Read these instructions.
2. Keep these instructions.
3. Heed all warnings.
4. Follow all instructions.
5. Do not use this apparatus near water.
6. Clean only with a dry cloth.
7. Do not block any ventilation openings. Install in accordance with the manufacturer's instructions.
8. Do not install near any heat sources such as radiators, heat registers, stoves, or other apparatus (including amplifiers) that produce heat.
9. Protect the power cord from being walked on or pinched particularly at plugs, convenience receptacles, and the point where they exit from the apparatus.
10. Only use attachments/accessories specified by the manufacturer.
11. Unplug this apparatus during lightning storms or when unused for long periods of time.
12. Refer all servicing to qualified personnel. Servicing is required when the apparatus has been damaged in any way, such as power-supply cord or plug is damaged, liquid has been spilled or objects have fallen into the apparatus, the apparatus has been exposed to rain or moisture, does not operate normally, or has been dropped.

WARNINGS/CAUTIONS



This symbol on the product means there is uninsulated, dangerous voltage within the product enclosure that may present a risk of electrical shock.



This symbol on the product means there are important operating and maintenance instructions in this guide.



This product contains a tempered glass surface. Use caution to avoid impact. In the event of breakage, use care in handling broken glass.



This product contains magnetic material. Consult your physician on whether this might affect your implantable medical device.

- To reduce the risk of fire or electrical shock, do NOT expose this product to rain, liquids or moisture.
- Do NOT expose this product to dripping or splashing, and do not place objects filled with liquids, such as vases, on or near the product.
- Keep the product away from fire and heat sources. Do NOT place naked flame sources, such as lighted candles, on or near the product.
- Do NOT make unauthorized alterations to this product.
- Do NOT use a power inverter with this product.
- Do NOT use in vehicles or boats.
- The speaker wire and interconnect cables included with this system are not approved for in-wall installation. Please check your local building codes for the correct type of wire and cable required for in-wall installation.
- Where the mains plug or an appliance coupler is used as the disconnect device, the disconnect device shall remain readily operable.



仅适用于 2000m 以下地区安全使用
Use at altitude less than 2000 meters only.

- Due to ventilation requirements, Bose does not recommend placing the product in a confined space such as in a wall cavity or in an enclosed cabinet.
- The product label is located on the bottom of the product.

NOTE: This equipment has been tested and found to comply with the limits for a Class B digital device, pursuant to Part 15 of the FCC Rules. These limits are designed to provide reasonable protection against harmful interference in a residential installation. This equipment generates, uses, and can radiate radio frequency energy and, if not installed and used in accordance with the instructions, may cause harmful interference to radio communications. However, there is no guarantee that interference will not occur in a particular installation. If this equipment does cause harmful interference to radio or television reception, which can be determined by turning the equipment off and on, the user is encouraged to try to correct the interference by one or more of the following measures:

- Reorient or relocate the receiving antenna.
- Increase the separation between the equipment and receiver.
- Connect the equipment into an outlet on a circuit different from that to which the receiver is connected.
- Consult the dealer or an experienced radio/TV technician for help.

Changes or modifications not expressly approved by Bose Corporation could void the user's authority to operate this equipment.

This device complies with part 15 of the FCC Rules and with ISED Canada license-exempt RSS standard(s). Operation is subject to the following two conditions: (1) This device may not cause harmful interference, and (2) this device must accept any interference received, including interference that may cause undesired operation.

This device complies with FCC and ISED Canada radiation exposure limits set forth for general population.

This equipment should be installed and operated with a minimum distance of 20 cm between radiator and your body. This transmitter must not be co-located or operating in conjunction with any other antenna or transmitter.

This device for operation in the 5150 - 5250 MHz is only for indoor use to reduce the potential for harmful interference to co-channel mobile satellite systems.

Receiver Category = 2

CAN ICES-3(B)/NMB-3(B)

For Europe:

Frequency bands of operation 2400 to 2483.5 MHz, 5150 to 5350 MHz, and 5470 to 5725 MHz.

Maximum transmit power less than 20 dBm EIRP.

Frequency band of operation 5725 to 5850 MHz.

Maximum transmit power less than 14 dBm (25mW) EIRP.

Maximum transmit power is below regulatory limits such that SAR testing is not necessary and exempt per applicable regulations.

This device is restricted to indoor use when operating in the 5150 to 5350 MHz frequency range in all EU Member States listed in the table.

									
BE	DK	IE	UK(NI)	FR	CY	SK	HU	AT	SE
BG	DE	PT	EL	HR	LV	LT	MT	PL	
CZ	EE	FI	ES	IT	RO	LU	NL	SI	

 This symbol means the product must not be discarded as household waste, and should be delivered to an appropriate collection facility for recycling. Proper disposal and recycling helps protect natural resources, human health and the environment. For more information on disposal and recycling of this product, contact your local municipality, disposal service, or the shop where you bought this product.

Management Regulation for Low-power Radio-frequency Devices

Article XII

According to “Management Regulation for Low-power Radio-frequency Devices” without permission granted by the NCC, any company, enterprise, or user is not allowed to change frequency, enhance transmitting power or alter original characteristic as well as performance to an approved low power radio-frequency devices.

Article XIV

The low power radio-frequency devices shall not influence aircraft security and interfere legal communications; If found, the user shall cease operating immediately until no interference is achieved. The said legal communications means radio communications operated in compliance with the Telecommunications Act.

The low power radio-frequency devices must be susceptible with the interference from legal communications or ISM radio wave radiated devices.

Product Power State Table

The product, in accordance with the Ecodesign Requirements for Energy Related Products Directive 2009/125/EC and the Ecodesign for Energy-Related Products and Energy Information (Amendment) (EU Exit) Regulations 2020, is in compliance with the following norm(s) or document(s): Regulation (EC) No. 1275/2008, as amended by Regulation (EU) No. 801/2013.

Required Power State Information	Power Modes	
	Standby	Networked Standby
Power consumption in specified power mode, at 230V/50Hz input	≤ 0.5 W	Bose Wireless ≤ 2.0 W
Time after which equipment is automatically switched into mode	≤ 2 hours	≤ 20 minutes
Power consumption in networked standby if all wired network ports are connected and all wireless network ports are activated, at 230V/50Hz input	N/A	≤ 2.0 W
Network port deactivation/activation procedures. Deactivating all networks will enable standby mode.	Per Annex II 3(a) of Regulation 801/2013 (“Lot 26” amendment of 1275/2008), the requirement to deactivate a wireless port “does not apply to products which rely on a single wireless network connection for intended use and have no wired network connection.”	

China Restriction of Hazardous Substances Table

Names and Contents of Toxic or Hazardous Substances or Elements						
Part Name	Toxic or Hazardous Substances and Elements					
	Lead (Pb)	Mercury (Hg)	Cadmium (Cd)	Hexavalent (CR(VI))	Polybrominated Biphenyl (PBB)	Polybrominated diphenylether (PBDE)
PCBs	X	0	0	0	0	0
Metal Parts	X	0	0	0	0	0
Plastic Parts	0	0	0	0	0	0
Speakers	X	0	0	0	0	0
Cables	X	0	0	0	0	0
This table is prepared in accordance with the provisions of SJ/T 11364. 0: Indicates that this toxic or hazardous substance contained in all of the homogeneous materials for this part is below the limit requirement of GB/T 26572. X: Indicates that this toxic or hazardous substance contained in at least one of the homogeneous materials used for this part is above the limit requirement of GB/T 26572.						

Taiwan Restriction of Hazardous Substances Table

Equipment name: Bass Module, Type designation: 420132						
Restricted substances and its chemical symbols						
Unit	Lead (Pb)	Mercury (Hg)	Cadmium (Cd)	Hexavalent chromium (Cr+6)	Polybrominated biphenyls (PBB)	Polybrominated diphenyl ethers (PBDE)
PCBs	-	o	o	o	o	o
Metal Parts	-	o	o	o	o	o
Plastic Parts	o	o	o	o	o	o
Speakers	-	o	o	o	o	o
Cables	-	o	o	o	o	o

Note 1: "o" indicates that the percentage content of the restricted substance does not exceed the percentage of reference value of presence.

Note 2: The "-" indicates that the restricted substance corresponds to the exemption.

Date of Manufacture: The eighth digit in the serial number indicates the year of manufacture; "1" is 2011 or 2021.

China Importer: Bose Electronics (Shanghai) Company Limited, Part C, Plant 9, No. 353 North Riyang Road, China (Shanghai) Pilot Free Trade Zone

EU Importer: Bose Products B.V., Gorslaan 60, 1441 RG Purmerend, The Netherlands

Taiwan Importer: Bose Taiwan Branch, 9F-A1, No. 10, Section 3, Minsheng East Road, Taipei City 104, Taiwan
Phone Number: +886-2-2514 7676

Mexico Importer: Bose de México, S. de R.L. de C.V., Paseo de las Palmas 405-204, Lomas de Chapultepec, 11000 México, D.F. Phone Number: +5255 (5202) 3545

UK Importer: Bose Limited, Bose House, Quayside Chatham Maritime, Chatham, Kent, ME4 4QZ, United Kingdom

Input Rating: 100-240V 50/60 Hz, 180W

The CMIIT ID is located on the bottom of the bass module.

Please complete and retain for your records

The serial and model numbers are located on the bottom of the bass module.

Serial number: _____

Model number: _____

Please keep your receipt with your owner's guide. Now is a good time to register your Bose product. You can easily do this by going to global.Bose.com/register

Security Information



This product is capable of receiving automatic security updates from Bose. To receive automatic security updates, you must complete the product setup process in the Bose Music app and connect the product to the Internet. **If you do not complete the setup process, you will be responsible for installing security updates that Bose makes available.**

Apple and the Apple logo are trademarks of Apple Inc., registered in the U.S. and other countries. App Store is a service mark of Apple Inc.

The *Bluetooth*[®] word mark and logos are registered trademarks owned by Bluetooth SIG, Inc. and any use of such marks by Bose Corporation is under license.

Google and Google Play are trademarks of Google LLC.

Acoustimass, ADAPTiQ, Bose, Bose Bass Module, Bose Music, the Bose Music logo, Bose Smart Soundbar, Bose TV Speaker, Lifestyle, SoundTouch, the wireless note design, and UNIFY are registered trademarks of Bose Corporation in the U.S. and other countries.

Bose Corporation Headquarters: 1-877-230-5639

©2021 Bose Corporation. No part of this work may be reproduced, modified, distributed or otherwise used without prior written permission.

WHAT'S IN THE CARTON

Contents 10

BASS MODULE PLACEMENT

Recommendations..... 11
 Placing a second bass module 12

POWER

Connect the bass module to power 13

CONNECT TO A SOUNDBAR OR SPEAKER

Choose your connection method 14
 Connect using the Bose music app 15
 New to the Bose Music app? 15
 Connect using the SoundTouch 300 remote..... 16
 Check for sound 16
 Connect using an audio cable 17
 Connect a second bass module (optional)..... 19
 Compatible bass modules..... 19
 Connect to a Bose Smart Soundbar or SoundTouch 300 soundbar . 19
 Connect to a Lifestyle 650/600 home entertainment system 19

BASS MODULE STATUS

Status light 20

CARE AND MAINTENANCE

Clean the bass module 21
 Replacement parts and accessories..... 21
 Limited warranty 21

TROUBLESHOOTING

Try these solutions first 22
Other solutions 22

REFERENCE

Access your soundbar or speaker owner’s guide 24

CONTENTS

Confirm that the following parts are included:

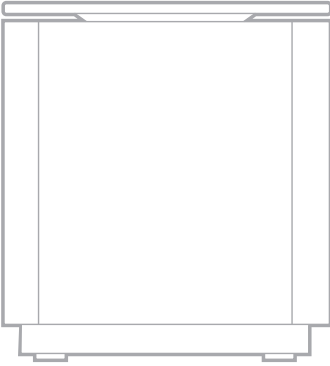

Bose Bass Module 700



Power cord*

*May ship with multiple power cords. Use the power cord for your region.

NOTE: If any part of the product is damaged or if the glass on the bass module is broken, do NOT use it. Contact your authorized Bose dealer or Bose customer service.

Visit: [worldwide.bose.com/Support](https://www.worldwide.bose.com/Support)

RECOMMENDATIONS

For best performance, follow these recommendations when placing the bass module:

Do NOT place any objects on top of the bass module.

To avoid wireless interference, keep other wireless equipment 1 – 3 ft. (0.3 – 0.9 m) away from the bass module. Place the bass module outside and away from metal cabinets, other audio/video components and direct heat sources.

Place the bass module on a stable and level surface. Vibration can cause the bass module to move, particularly on smooth surfaces like marble, glass or highly polished wood.

Place the bass module along the same wall as your TV, or along any other wall in the front third of the room.

Keep the front side of the bass module (the side opposite the POWER connector) at least 3 in. (7.6 cm) from any other surface. Blocking the port on the bottom of this side may affect acoustic performance.

For more bass, place the bass module closer to walls and corners. For less bass, place the bass module further from walls and corners.

Make sure there is an AC (mains) outlet nearby.

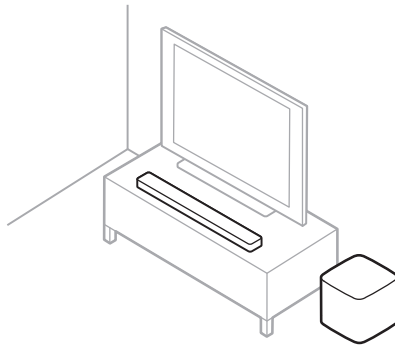

CAUTION: Do NOT place the bass module on its top or sides when in use.

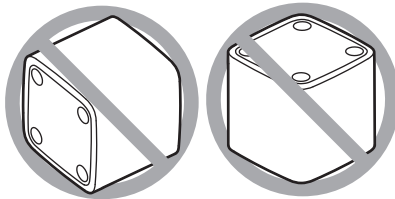

Placing a second bass module

Try placing each bass module in multiple locations to see what sounds best for your listening area. After placing a module in a new location, run ADAPTiQ audio calibration using the instructions in your soundbar owner's guide (see page 24). For more bass, place the modules closer to each other or closer to walls and corners.

CONNECT THE BASS MODULE TO POWER

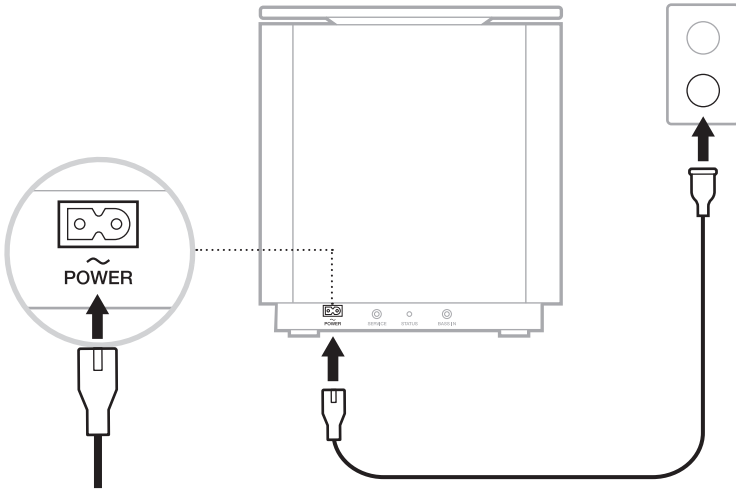

1. Connect the power cord to the **POWER** connector on the bass module.



2. Plug the other end of the power cord into an AC (mains) power outlet.

CHOOSE YOUR CONNECTION METHOD

The way you connect the bass module depends on your soundbar or speaker. Choose your connection method from the table below.

SOUNDBAR OR SPEAKER	CONNECTION METHOD
<p>Bose Smart Soundbar (voice-enabled soundbar)</p> 	<p>Connect using the Bose Music app (see page 15).</p> <p>NOTE: If you can't access or have trouble connecting using the Bose Music app, see "Troubleshooting" on page 22.</p>
<p>SoundTouch 300 soundbar</p> 	<p>Connect using your soundbar's remote (see page 16).</p>
<p>Bose TV Speaker (or alternate wired setup for soundbars)</p> 	<p>Connect using an audio cable (not provided) (see page 17).</p>

CONNECT USING THE BOSE MUSIC APP

1. In the Bose Music app, select your soundbar.
2. Go to the Settings menu to add your bass module.



New to the Bose Music app?

1. On your mobile device, download the Bose Music app.



2. Follow the app instructions.

CONNECT USING THE SOUNDTOUCH 300 REMOTE

1. On the SoundTouch 300 remote, press the SoundTouch button .
2. Press and hold 7 until the connectivity light  on the soundbar blinks white.

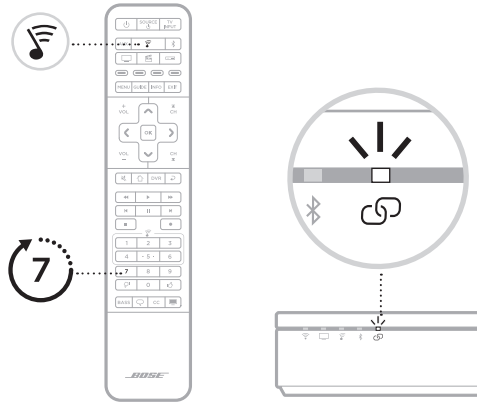

Once connected, you hear a tone. The light on the back of the bass module and  on the soundbar glow white.

NOTES: Connecting may take several minutes.

If the bass module doesn't connect to the soundbar, see "Troubleshooting" on page 22.

Check for sound

NOTE: To avoid hearing distorted audio, turn off your TV speakers. Refer to your TV owner's guide for more information.

1. Power on your TV.
2. If you are using a cable/satellite box or other secondary source:
 - a. Power on this source.
 - b. If this source is connected to your TV, select the appropriate TV input.
3. Power on the soundbar.

You hear sound coming from the bass module.

NOTE: If you do not hear sound from the bass module, see "Troubleshooting" on page 22.

CONNECT USING AN AUDIO CABLE

You can connect the module to the soundbar or speaker using a 3.5 mm audio cable (not provided).

If you don't have a 3.5 mm audio cable (commonly used for headphones and mobile devices), visit [Bose.com/BM700](https://www.bose.com/BM700) to purchase a 15 ft. (4.5 m) cable. You can also purchase this part at your local electronics store.

1. Connect one end of a 3.5 mm audio cable to the **BASS IN** connector on the bass module.

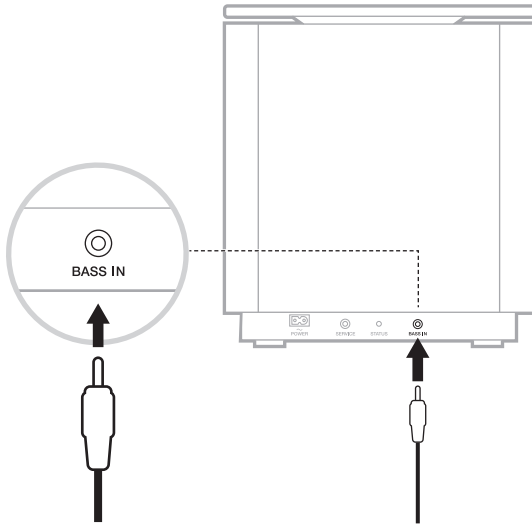

2. Connect the other end of the cable to the **BASS** connector on the back of the soundbar or speaker.

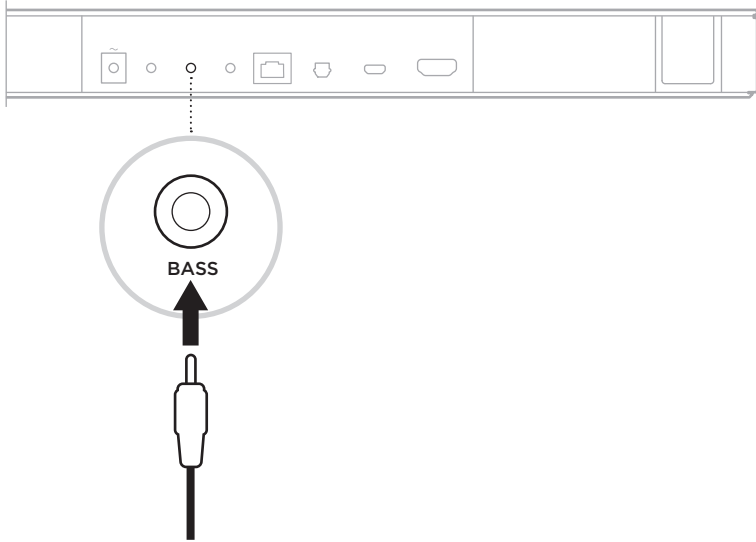

NOTES:

Bose Smart Soundbar: Make sure to connect the cable to the **BASS** connector, not the **IR** connector.

Bose TV Speaker: Make sure to connect the cable to the **BASS** connector, not the **AUX IN** connector.

SoundTouch 300 soundbar: Connect the cable to the **ACOUSTIMASS** connector.

3. Check for sound (see page 16).

CONNECT A SECOND BASS MODULE (OPTIONAL)

Connecting a second bass module may produce more consistent or powerful bass throughout your listening area.

NOTES:

For more information about placing a second bass module, see page 12.

If your current bass module is connected to your soundbar or system with a 3.5 mm audio cable (see page 17), you can't connect a second bass module.

Compatible bass modules

You can connect a Bose Bass Module 700 or an Acoustimass 300 bass module as a second bass module.

Connect to a Bose Smart Soundbar or SoundTouch 300 soundbar

Choose the connection method that's appropriate for your soundbar (see page 14).

Connect to a Lifestyle 650/600 home entertainment system

1. On the Lifestyle 650/600 remote, press **SETUP**.
2. From the UNIFY menu, select **Speaker Management**, then select **Setup Second Bass Module**.
3. Follow the on-screen instructions to connect your second bass module.

STATUS LIGHT

The light on the back of the module shows system status.

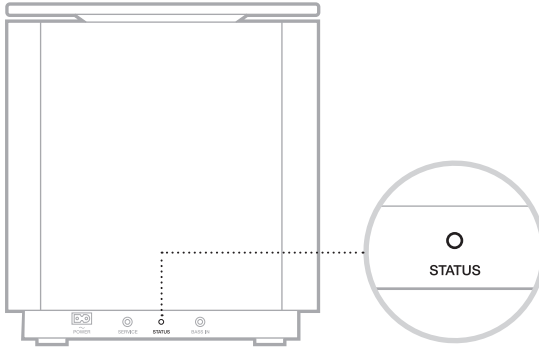

LIGHT ACTIVITY	SYSTEM STATE
Solid white	Connected to the soundbar or speaker
Blinking white	Downloading a software update
Solid amber	Network standby (wireless connection)
Blinking amber	Ready to connect to the soundbar or speaker
Off	Power-saving mode (wired connection)
Blinking red	Error - contact Bose customer service

CLEAN THE BASS MODULE

Clean the exterior of the bass module with a soft, dry cloth.

CAUTIONS:

Do NOT allow liquids to spill onto the bass module or into any openings.

Do NOT use any sprays near the bass module.

Do NOT use any solvents, chemicals or cleaning solutions containing alcohol, ammonia or abrasives.

Do NOT allow objects to drop into any openings.

REPLACEMENT PARTS AND ACCESSORIES

Replacement parts and accessories can be ordered through Bose customer service.

Visit: worldwide.Bose.com/Support

LIMITED WARRANTY

Your bass module is covered by a limited warranty. Visit our website at global.Bose.com/warranty for details of the limited warranty.

To register your product, visit global.Bose.com/register for instructions. Failure to register will not affect your limited warranty rights.

TRY THESE SOLUTIONS FIRST

If you experience problems with the bass module:

Unplug the power cords for the bass module and soundbar or speaker, wait 30 seconds and plug them firmly into a live AC (mains) outlet.

Secure all cables.

Check the bass module status (see page 20).

Move the bass module and soundbar or speaker away from possible interference (wireless routers, cordless phones, televisions, microwaves, etc.).

Move the bass module within the recommended range of your wireless router or mobile device for proper operation.

Place the bass module according to the placement guidelines (see page 11).

OTHER SOLUTIONS

If you could not resolve your issue, see the table below to identify symptoms and solutions to common problems. If you are unable to resolve your issue, contact Bose customer service.

Visit: worldwide.Bose.com/contact

SYMPTOM	SOLUTION
Bose Music app doesn't work on mobile device	Make sure your mobile device is compatible with the Bose Music app and meets minimum system requirements. For more information, refer to the app store on your mobile device.
Bass module doesn't wirelessly connect to the soundbar	<p>Confirm that the status light is blinking amber, indicating that the bass module is ready to connect (see page 20).</p> <p>Repeat the connection process (page 14).</p> <p>Unplug the power cords for the bass module and soundbar, wait 30 seconds and plug them firmly into a live AC (mains) outlet.</p> <p>Connect the bass module to the soundbar using a 3.5 mm audio cable (see page 17).</p> <p>NOTE: If you don't have a 3.5 mm audio cable (commonly used for headphones and mobile devices), visit Bose.com/BM700 to purchase a 15 ft. (4.5 m) cable. You can also purchase this part at your local electronics store.</p>

SYMPTOM	SOLUTION
Intermittent or no audio	<p>Unmute the system.</p> <p>Increase the volume.</p> <p>Confirm that the soundbar or speaker is playing audio. If not, refer to your soundbar or speaker owner's guide for troubleshooting (see page 24).</p> <p>Test different sources (if available).</p> <p>Make sure that you're playing audio that has bass frequencies, such as music or movies.</p> <p>For wireless connections:</p> <ul style="list-style-type: none"> Confirm that the system status light is glowing solid white, indicating that the bass module is connected to the soundbar (see page 20). Repeat the connection process (see page 14). <p>Place the bass module according to the placement guidelines (see page 11).</p>
Poor or distorted sound from bass module	<p>Test different sources (if available).</p> <p>Place the bass module according to the placement guidelines (see page 11).</p> <p>Remove all protective films from the bass module.</p> <p>If the bass module is connected to a Bose Smart Soundbar or SoundTouch 300 soundbar, run ADAPTiQ audio calibration. For more information, refer to your soundbar owner's guide (see page 24).</p> <p>NOTES:</p> <ul style="list-style-type: none"> This solution does not apply to the Bose Smart Soundbar 300. If you no longer have the ADAPTiQ headset (provided with your soundbar), contact Bose customer service for a replacement. <p>If the bass module is connected to a Bose TV Speaker or Bose Smart Soundbar 300, make sure the 3.5 mm audio cable (not provided) is connected to the BASS connector on the back of the speaker or soundbar, not the AUX IN or IR connector.</p>
Bass is too heavy or low	<p>Adjust the bass. For instructions, refer to your soundbar or speaker owner's guide (see page 24).</p> <p>If the bass module is connected to a Bose Smart Soundbar or SoundTouch 300 soundbar, run ADAPTiQ audio calibration. For more information, refer to your soundbar owner's guide (see page 23).</p> <p>NOTES:</p> <ul style="list-style-type: none"> This solution does not apply to the Bose Smart Soundbar 300. If you no longer have the ADAPTiQ headset (provided with your soundbar), contact Bose customer service for a replacement. <p>Place the bass module according to the placement guidelines (see page 11).</p>

ACCESS YOUR SOUNDBAR OR SPEAKER OWNER'S GUIDE

For instructions and troubleshooting specific to your soundbar or speaker, refer to your soundbar or speaker owner's guide. Visit:

Bose Smart Soundbar: worldwide.bose.com/Support

Bose TV Speaker: worldwide.bose.com/Support/TVS

SoundTouch 300 soundbar: global.bose.com/Support/ST300



772090-0020