



SPORT EARBUDS

Please read and keep all safety, security, and use instructions.

CE Bose Corporation hereby declares that this product is in compliance with the essential requirements and other relevant provisions of Directive 2014/53/EU and all other applicable EU directive requirements. The complete declaration of conformity can be found at: www.Bose.com/compliance

Important Safety Instructions

1. Read these instructions.
2. Keep these instructions.
3. Heed all warnings.
4. Follow all instructions.
5. Do not use this apparatus near water.
6. Clean only with a dry cloth.
7. Only use attachments/accessories specified by the manufacturer.

WARNINGS/CAUTIONS

- To avoid accidental ingestion, keep the earbuds away from children and pets. The earbuds contain a lithium-ion battery, and may be hazardous if swallowed. If ingested, seek immediate medical attention. When not in use, store the earbuds in the charging case with the charging lid closed, and keep out of the reach of children and pets.
- Do NOT allow children to use the earbuds.
- Do NOT use the earbuds at a high volume for any extended period.
 - To avoid hearing damage, use your earbuds at a comfortable, moderate volume level.
 - Turn the volume down on your device before placing the earbuds in/on your ears, then turn the volume up gradually until you reach a comfortable listening level.
- When using this product, basic precautions should always be followed, including the following:
 - Read all the instructions before using the charging case.
 - To reduce the risk of injury, close supervision is necessary when the charging case is used near children.
 - Do not expose the charging case to water, rain, liquids or snow.
 - Use of a power supply or charger not recommended or sold by power pack manufacturer may result in a risk of fire or injury to persons.
 - Do not use the charging case in excess of its output rating. Overload outputs above rating may result in a risk of fire or injury to persons.
 - Do not use a charging case that is damaged or modified. Damaged or modified batteries may exhibit unpredictable behavior resulting in fire, explosion or risk of injury to persons.
 - Do not disassemble the charging case. Take it to a qualified service person when service or repair is required. Incorrect reassembly may result in risk of fire or injury to persons.
 - Do not open, crush, or expose a charging case to fire or excessive temperature. Exposure to fire or temperature above 212° F, 100° C may cause explosion.
 - Have servicing performed by a qualified repair person using only identical replacement parts. This will ensure that the safety of the product is maintained.
- Use caution and follow applicable laws regarding mobile phone and headphone use if using the earbuds for phone calls while driving. Some jurisdictions impose specific limitations, such as single earpiece configuration, on the use of such products while driving. DON'T use the earbuds for any other purpose while driving.

- Focus on your safety and that of others if you use the earbuds while engaging in any activity requiring your attention, e.g., while riding a bicycle or walking in or near traffic, a construction site or railroad, etc. Remove the earbuds or adjust your volume to ensure you can hear surrounding sounds, including alarms and warning signals.
- Do NOT use the earbuds if they emit any loud unusual noise. If this happens, turn the earbuds off and contact Bose customer service.
- Do NOT submerge or expose the earbuds for extended period to water, or wear while participating in water sports, e.g., swimming, waterskiing, surfing, etc.
- Remove earbuds immediately if you experience a warming sensation or loss of audio.



Contains small parts which may be a choking hazard. Not suitable for children under age 3.



This product contains magnetic material. Consult your physician on whether this might affect your implantable medical device.



These earbuds are classified as a CLASS 1 LASER PRODUCT according to EN / IEC 60825-1:2014.

- Do NOT make unauthorized alterations to this product.
- Do NOT use the earbuds without the supplied eartips attached.
- Use this product only with an agency-approved power supply that meets local regulatory requirements (e.g., UL, CSA, VDE, CCC).
- The battery provided with this product may present a risk of fire or chemical burn if mishandled.
- Do not expose products containing batteries to excessive heat (e.g. from storage in direct sunlight, fire or the like).
- Wipe off sweat from the earbuds and the charging case before charging.
- IPX4 is not a permanent condition, and resistance might decrease as a result of normal wear.
- To avoid hazardous radiation exposure from the internal laser component, use the product only as specified in the instructions. The earbuds should not be adjusted or repaired by anyone except properly qualified service personnel.
- Complies with 21 CFR 1040.10 and 1040.11 except for conformance with IEC 60825-1 Ed. 3 as described in Laser Notice 56, date May 8, 2019.

NOTE: This equipment has been tested and found to comply with the limits for a Class B digital device, pursuant to Part 15 of the FCC Rules. These limits are designed to provide reasonable protection against harmful interference in a residential installation. This equipment generates, uses, and can radiate radio frequency energy and, if not installed and used in accordance with the instructions, may cause harmful interference to radio communications. However, there is no guarantee that interference will not occur in a particular installation. If this equipment does cause harmful interference to radio or television reception, which can be determined by turning the equipment off and on, the user is encouraged to try to correct the interference by one or more of the following measures:

- Reorient or relocate the receiving antenna.
- Increase the separation between the equipment and receiver.
- Connect the equipment into an outlet on a circuit different from that to which the receiver is connected.
- Consult the dealer or an experienced radio/TV technician for help.

Changes or modifications not expressly approved by Bose Corporation could void the user's authority to operate this equipment.

This device complies with part 15 of the FCC Rules and with ISED Canada license-exempt RSS standard(s). Operation is subject to the following two conditions: (1) This device may not cause harmful interference, and (2) this device must accept any interference received, including interference that may cause undesired operation.

This device complies with FCC and ISED Canada radiation exposure limits set forth for general population. This transmitter must not be co-located or operating in conjunction with any other antenna or transmitter.

FCC ID: A94427929 / FCC ID: A94BL2R / FCC ID: A94BL2L

IC: 3232A-427929 / IC: 3232A-BL2R / IC: 3232A-BL2L

Case Model: 427929

Right Earbud Model: BL2R

Left Earbud Model: BL2L



007-AH0181 (L)
007-AH0182 (R)
007-AH0183 (CASE)

CAN ICES-3(B)/NMB-3(B)

For Europe:

Frequency band of operation 2400 to 2483.5 MHz.

Maximum transmit power less than 20 dBm EIRP.

Maximum transmit power is below regulatory limits such that SAR testing is not necessary and exempt per applicable regulations.



This symbol means the product must not be discarded as household waste, and should be delivered to an appropriate collection facility for recycling. Proper disposal and recycling helps protect natural resources, human health and the environment. For more information on disposal and recycling of this product, contact your local municipality, disposal service, or the shop where you bought this product.

Management Regulation for Low-power Radio-frequency Devices

Article XII

According to "Management Regulation for Low-power Radio-frequency Devices" without permission granted by the NCC, any company, enterprise, or user is not allowed to change frequency, enhance transmitting power or alter original characteristic as well as performance to an approved low power radio-frequency devices.

Article XIV

The low power radio-frequency devices shall not influence aircraft security and interfere legal communications; If found, the user shall cease operating immediately until no interference is achieved. The said legal communications means radio communications operated in compliance with the Telecommunications Act.

The low power radio-frequency devices must be susceptible with the interference from legal communications or ISM radio wave radiated devices.

DON'T attempt to remove the rechargeable lithium-ion battery from this product. Contact your local Bose retailer or other qualified professional for removal.



Please dispose of used batteries properly, following local regulations. Do not incinerate.



China Restriction of Hazardous Substances Table

Names and Contents of Toxic or Hazardous Substances or Elements						
Part Name	Toxic or Hazardous Substances and Elements					
	Lead (Pb)	Mercury (Hg)	Cadmium (Cd)	Hexavalent (CR(VI))	Polybrominated Biphenyl (PBB)	Polybrominated diphenylether (PBDE)
PCBs	X	0	0	0	0	0
Metal Parts	X	0	0	0	0	0
Plastic Parts	0	0	0	0	0	0
Speakers	X	0	0	0	0	0
Cables	X	0	0	0	0	0
This table is prepared in accordance with the provisions of SJ/T 11364.						
O: Indicates that this toxic or hazardous substance contained in all of the homogeneous materials for this part is below the limit requirement of GB/T 26572.						
X: Indicates that this toxic or hazardous substance contained in at least one of the homogeneous materials used for this part is above the limit requirement of GB/T 26572.						

Taiwan Restriction of Hazardous Substances Table

Equipment name: Charging Case, Type designation: 427929						
Unit	Restricted substances and its chemical symbols					
	Lead (Pb)	Mercury (Hg)	Cadmium (Cd)	Hexavalent chromium (Cr+6)	Polybrominated biphenyls (PBB)	Polybrominated diphenyl ethers (PBDE)
PCBs	-	o	o	o	o	o
Metal Parts	-	o	o	o	o	o
Plastic Parts	o	o	o	o	o	o
Speakers	-	o	o	o	o	o
Cables	-	o	o	o	o	o
Note 1: "o" indicates that the percentage content of the restricted substance does not exceed the percentage of reference value of presence. Note 2: The "-" indicates that the restricted substance corresponds to the exemption.						

Date of Manufacture: The eighth digit in the serial number indicates the year of manufacture; “0” is 2010 or 2020.

Location of Manufacture: The seventh digit in the serial number indicates the location of manufacture.

China Importer: Bose Electronics (Shanghai) Company Limited, Part C, Plant 9, No. 353 North Riyang Road, China (Shanghai) Pilot Free Trade Zone

EU Importer: Bose Products B.V., Gorslaan 60, 1441 RG Purmerend, The Netherlands

Taiwan Importer: Bose Taiwan Branch, 9F-A1, No. 10, Section 3, Minsheng East Road, Taipei City 104, Taiwan
Phone Number: +886-2-2514 7676

Mexico Importer: Bose de México, S. de R.L. de C.V., Paseo de las Palmas 405-204, Lomas de Chapultepec, 11000 México, D.F. Phone Number: +5255 (5202) 3545

Input Rating: 5V \approx 0.8A

The CMIIT IDs are located on the charging case.

Please complete and retain for your records

The earbud date code is located on the earbud nozzle. The charging case serial number is located on the earbud well in the charging case. The model numbers are located on the bottom of the charging case.

Serial number: _____

Model number: _____

Please keep your receipt with your owner's guide. Now is a good time to register your Bose product. You can easily do this by going to global.bose.com/register

Security Information



This product is capable of receiving automatic security updates from Bose. To receive automatic security updates, you must complete the product setup process in the Bose Music app and connect the product to the Internet. **If you do not complete the setup process, you will be responsible for installing security updates that Bose makes available.**

Apple, the Apple logo, iPad, iPhone, and iPod are trademarks of Apple Inc., registered in the U.S. and other countries. The trademark “iPhone” is used in Japan with a license from Aiphone K.K. App Store is a service mark of Apple Inc.

Use of the Made for Apple badge means that an accessory has been designed to connect specifically to the Apple product(s) identified in the badge, and has been certified by the developer to meet Apple performance standards. Apple is not responsible for the operation of this device or its compliance with safety and regulatory standards.

The *Bluetooth*[®] word mark and logos are registered trademarks owned by Bluetooth SIG, Inc. and any use of such marks by Bose Corporation is under license.

Google and Google Play are trademarks of Google LLC.

Bose, Bose Music, and Bose Sport Earbuds are trademarks of Bose Corporation.

Bose Corporation Headquarters: 1-877-230-5639

©2020 Bose Corporation. No part of this work may be reproduced, modified, distributed, or otherwise used without prior written permission.

The following license disclosures apply to certain third-party software packages used as components in the product.

Package: FreeRTOS

Copyright © Amazon Web Services, Inc. or its affiliates. All rights reserved.

The FreeRTOS package is subject to the license terms reprinted below:

MIT License

Permission is hereby granted, free of charge, to any person obtaining a copy of this software and associated documentation files (the "Software"), to deal in the Software without restriction, including without limitation the rights to use, copy, modify, merge, publish, distribute, sublicense, and/or sell copies of the Software, and to permit persons to whom the Software is furnished to do so, subject to the following conditions:

The above copyright notice and this permission notice shall be included in all copies or substantial portions of the Software.

THE SOFTWARE IS PROVIDED "AS IS", WITHOUT WARRANTY OF ANY KIND, EXPRESS OR IMPLIED, INCLUDING BUT NOT LIMITED TO THE WARRANTIES OF MERCHANTABILITY, FITNESS FOR A PARTICULAR PURPOSE AND NONINFRINGEMENT. IN NO EVENT SHALL THE AUTHORS OR COPYRIGHT HOLDERS BE LIABLE FOR ANY CLAIM, DAMAGES OR OTHER LIABILITY, WHETHER IN AN ACTION OF CONTRACT, TORT OR OTHERWISE, ARISING FROM, OUT OF OR IN CONNECTION WITH THE SOFTWARE OR THE USE OR OTHER DEALINGS IN THE SOFTWARE.

Package: Nanopb

Copyright © 2011 Petteri Aimonen <jpa at nanopb.mail.kapsi.fi>.

The Nanopb package is subject to the license terms reprinted below:

Zlib License

© 2011 Petteri Aimonen <jpa at nanopb.mail.kapsi.fi>

This software is provided 'as-is', without any express or implied warranty. In no event will the authors be held liable for any damages arising from the use of this software.

Permission is granted to anyone to use this software for any purpose, including commercial applications, and to alter it and redistribute it freely, subject to the following restrictions:

1. The origin of this software must not be misrepresented; you must not claim that you wrote the original software. If you use this software in a product, an acknowledgment in the product documentation would be appreciated but is not required.
2. Altered source versions must be plainly marked as such, and must not be misrepresented as being the original software.
3. This notice may not be removed or altered from any source distribution.

Package: Mbed TLS 2.16.1

© ARM Limited. All rights reserved.

The Mbed TLS package is subject to the license terms reprinted below:

Apache License

Version 2.0, January 2004

<http://www.apache.org/licenses/>

TERMS AND CONDITIONS FOR USE, REPRODUCTION, AND DISTRIBUTION

1. Definitions.

"License" shall mean the terms and conditions for use, reproduction, and distribution as defined by Sections 1 through 9 of this document.

"Licensor" shall mean the copyright owner or entity authorized by the copyright owner that is granting the License.

“Legal Entity” shall mean the union of the acting entity and all other entities that control, are controlled by, or are under common control with that entity. For the purposes of this definition, “control” means (i) the power, direct or indirect, to cause the direction or management of such entity, whether by contract or otherwise, or (ii) ownership of fifty percent (50%) or more of the outstanding shares, or (iii) beneficial ownership of such entity.

“You” (or “Your”) shall mean an individual or Legal Entity exercising permissions granted by this License.

“Source” form shall mean the preferred form for making modifications, including but not limited to software source code, documentation source, and configuration files.

“Object” form shall mean any form resulting from mechanical transformation or translation of a Source form, including but not limited to compiled object code, generated documentation, and conversions to other media types.

“Work” shall mean the work of authorship, whether in Source or Object form, made available under the License, as indicated by a copyright notice that is included in or attached to the work (an example is provided in the Appendix below).

“Derivative Works” shall mean any work, whether in Source or Object form, that is based on (or derived from) the Work and for which the editorial revisions, annotations, elaborations, or other modifications represent, as a whole, an original work of authorship. For the purposes of this License, Derivative Works shall not include works that remain separable from, or merely link (or bind by name) to the interfaces of, the Work and Derivative Works thereof.

“Contribution” shall mean any work of authorship, including the original version of the Work and any modifications or additions to that Work or Derivative Works thereof, that is intentionally submitted to Licensor for inclusion in the Work by the copyright owner or by an individual or Legal Entity authorized to submit on behalf of the copyright owner. For the purposes of this definition, “submitted” means any form of electronic, verbal, or written communication sent to the Licensor or its representatives, including but not limited to communication on electronic mailing lists, source code control systems, and issue tracking systems that are managed by, or on behalf of, the Licensor for the purpose of discussing and improving the Work, but excluding communication that is conspicuously marked or otherwise designated in writing by the copyright owner as “Not a Contribution.”

“Contributor” shall mean Licensor and any individual or Legal Entity on behalf of whom a Contribution has been received by Licensor and subsequently incorporated within the Work.

2. Grant of Copyright License. Subject to the terms and conditions of this License, each Contributor hereby grants to You a perpetual, worldwide, non-exclusive, no-charge, royalty-free, irrevocable copyright license to reproduce, prepare Derivative Works of, publicly display, publicly perform, sublicense, and distribute the Work and such Derivative Works in Source or Object form.
3. Grant of Patent License. Subject to the terms and conditions of this License, each Contributor hereby grants to You a perpetual, worldwide, non-exclusive, no-charge, royalty-free, irrevocable (except as stated in this section) patent license to make, have made, use, offer to sell, sell, import, and otherwise transfer the Work, where such license applies only to those patent claims licensable by such Contributor that are necessarily infringed by their Contribution(s) alone or by combination of their Contribution(s) with the Work to which such Contribution(s) was submitted. If You institute patent litigation against any entity (including a cross-claim or counterclaim in a lawsuit) alleging that the Work or a Contribution incorporated within the Work constitutes direct or contributory patent infringement, then any patent licenses granted to You under this License for that Work shall terminate as of the date such litigation is filed.
4. Redistribution. You may reproduce and distribute copies of the Work or Derivative Works thereof in any medium, with or without modifications, and in Source or Object form, provided that You meet the following conditions:
 - a. You must give any other recipients of the Work or Derivative Works a copy of this License; and
 - b. You must cause any modified files to carry prominent notices stating that You changed the files; and
 - c. You must retain, in the Source form of any Derivative Works that You distribute, all copyright, patent, trademark, and attribution notices from the Source form of the Work, excluding those notices that do not pertain to any part of the Derivative Works; and

d. If the Work includes a “NOTICE” text file as part of its distribution, then any Derivative Works that You distribute must include a readable copy of the attribution notices contained within such NOTICE file, excluding those notices that do not pertain to any part of the Derivative Works, in at least one of the following places: within a NOTICE text file distributed as part of the Derivative Works; within the Source form or documentation, if provided along with the Derivative Works; or, within a display generated by the Derivative Works, if and wherever such third-party notices normally appear. The contents of the NOTICE file are for informational purposes only and do not modify the License. You may add Your own attribution notices within Derivative Works that You distribute, alongside or as an addendum to the NOTICE text from the Work, provided that such additional attribution notices cannot be construed as modifying the License.

You may add Your own copyright statement to Your modifications and may provide additional or different license terms and conditions for use, reproduction, or distribution of Your modifications, or for any such Derivative Works as a whole, provided Your use, reproduction, and distribution of the Work otherwise complies with the conditions stated in this License.

5. Submission of Contributions. Unless You explicitly state otherwise, any Contribution intentionally submitted for inclusion in the Work by You to the Licensor shall be under the terms and conditions of this License, without any additional terms or conditions. Notwithstanding the above, nothing herein shall supersede or modify the terms of any separate license agreement you may have executed with Licensor regarding such Contributions.
6. Trademarks. This License does not grant permission to use the trade names, trademarks, service marks, or product names of the Licensor, except as required for reasonable and customary use in describing the origin of the Work and reproducing the content of the NOTICE file.
7. Disclaimer of Warranty. Unless required by applicable law or agreed to in writing, Licensor provides the Work (and each Contributor provides its Contributions) on an “AS IS” BASIS, WITHOUT WARRANTIES OR CONDITIONS OF ANY KIND, either express or implied, including, without limitation, any warranties or conditions of TITLE, NON-INFRINGEMENT, MERCHANTABILITY, or FITNESS FOR A PARTICULAR PURPOSE. You are solely responsible for determining the appropriateness of using or redistributing the Work and assume any risks associated with Your exercise of permissions under this License.
8. Limitation of Liability. In no event and under no legal theory, whether in tort (including negligence), contract, or otherwise, unless required by applicable law (such as deliberate and grossly negligent acts) or agreed to in writing, shall any Contributor be liable to You for damages, including any direct, indirect, special, incidental, or consequential damages of any character arising as a result of this License or out of the use or inability to use the Work (including but not limited to damages for loss of goodwill, work stoppage, computer failure or malfunction, or any and all other commercial damages or losses), even if such Contributor has been advised of the possibility of such damages.
9. Accepting Warranty or Additional Liability. While redistributing the Work or Derivative Works thereof, You may choose to offer, and charge a fee for, acceptance of support, warranty, indemnity, or other liability obligations and/or rights consistent with this License. However, in accepting such obligations, You may act only on Your own behalf and on Your sole responsibility, not on behalf of any other Contributor, and only if You agree to indemnify, defend, and hold each Contributor harmless for any liability incurred by, or claims asserted against, such Contributor by reason of your accepting any such warranty or additional liability.

END OF TERMS AND CONDITIONS

©2020 Bose Corporation

Licensed under the Apache License, Version 2.0 (the “License”); you may not use this file except in compliance with the License.

You may obtain a copy of the License at: <http://www.apache.org/licenses/LICENSE-2.0>

Unless required by applicable law or agreed to in writing, software distributed under the License is distributed on an “AS IS” BASIS, WITHOUT WARRANTIES OR CONDITIONS OF ANY KIND, either express or implied.

See the License for the specific language governing permissions and limitations under the License.

WHAT'S IN THE BOX

Contents 13

BOSE MUSIC APP SETUP

Download the Bose Music app..... 14
 Add the earbuds to an existing account 14

SWEAT AND WEATHER RESISTANCE 15

HOW TO WEAR

Insert the earbuds..... 16
 Check your fit 17
 Try another eartip size 18
 Change the eartips..... 19

POWER

Power on 20
 Power off..... 21
 Standby..... 21

TOUCH CONTROL

Touch surface area 22
 Media playback and volume 22
 Phone calls..... 23
 Call notifications 23
 Mobile device voice control..... 23

IN-EAR DETECTION

Auto Play/Pause..... 24
 Auto Answer Call 24

CUSTOMIZE TOUCH CONTROL

Shortcut 25

Set a Shortcut 25

Use your Shortcut..... 25

Remove or change your Shortcut 25

BATTERY

Charge the earbuds 26

Charge the charging case..... 27

Check the earbud battery level..... 27

While using the earbuds 27

While charging the earbuds 27

Check the charging case battery level 28

Charging time..... 28

EARBUD AND CHARGING CASE STATUS

Earbud status lights 29

Bluetooth[®] status 29

Battery status..... 29

Charging case status lights..... 30

Battery status..... 30

Update and error status..... 30

BLUETOOTH CONNECTIONS

Connect using the *Bluetooth* menu on your mobile device 31

Disconnect a mobile device..... 32

Reconnect a mobile device..... 32

Clear the earbud device list..... 33

CARE AND MAINTENANCE

Store the earbuds	34
Clean the earbuds and charging case	34
Replacement parts and accessories.....	34
Limited warranty	34
Update the earbuds	35
View the earbud date code.....	35
View the charging case serial number	35

TROUBLESHOOTING

Try these solutions first	36
Other solutions	36
Reboot the earbuds and charging case.....	41

CONTENTS

Confirm that the following parts are included:

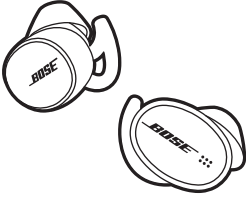

Bose Sport Earbuds



Charging case

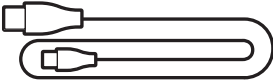

USB-C to USB-A cable

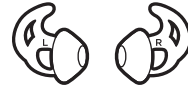
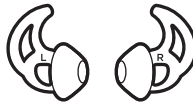

Eartips (sizes 1 and 3)

NOTE: Size 2 eartips are attached to the earbuds. For help identifying the eartip sizes, see page 18.

NOTE: If any part of the product is damaged, don't use it. Contact your authorized Bose dealer or Bose customer service.

Visit: worldwide.Bose.com/Support/SportEarbuds

The Bose Music app lets you set up and control the earbuds from any mobile device, such as a smartphone or tablet.

Using the app, you can manage *Bluetooth* connections, manage earbud settings, choose your voice prompt language, and get new features.

NOTE: If you have already created a Bose account for another Bose product, see “Add the earbuds to an existing account.”

DOWNLOAD THE BOSE MUSIC APP

1. On your mobile device, download the Bose Music app.

NOTE: If you're located in mainland China, download the Bose音乐 app.



2. Follow the app instructions.

ADD THE EARBUDS TO AN EXISTING ACCOUNT

In the Bose Music app, go to the My Products screen and add your Bose Sport Earbuds.

The earbuds are rated IPX4 water resistant. They are designed to be sweat and weather resistant but aren't meant to be submerged under water.

CAUTIONS:

- Do NOT swim or shower with the earbuds.
- Do NOT submerge the earbuds.



NOTES:

- To prevent rusting, regularly clean the charging contacts on the earbuds with a dry, soft cotton swab or equivalent.
- IPX4 is not a permanent condition, and resistance might decrease as a result of normal wear.

INSERT THE EARBUDS

1. Insert the earbud so the eartip gently rests at the opening of your ear canal.

NOTE: Each eartip is marked with either an **L** (left) or an **R** (right).



2. Slightly rotate the earbud back until the eartip creates a comfortable seal at your ear canal.

NOTE: Rotating the earbud too far back (or forward) may impact audio and microphone sound quality.

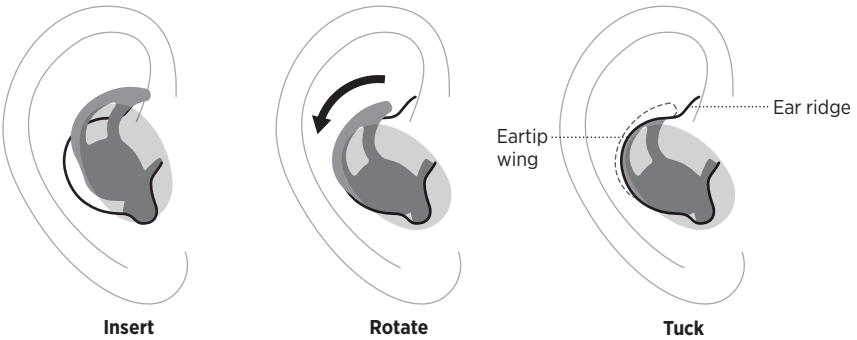

3. Tuck the eartip wing under your ear ridge.



4. Check the fit (see page 17).
5. Repeat steps 1 - 4 to insert the other earbud.

CHECK YOUR FIT

Use a mirror to make sure you have successfully rotated the earbud back, tucked the eartip wing, and that you're using the best eartip size for each ear.

FIT	WHAT TO CHECK
<p>Proper fit</p>	 <p>When the eartip fits properly:</p> <ul style="list-style-type: none"> • The eartip gently rests at the opening of your ear canal to create a comfortable seal. Background noise should sound muffled. • The eartip wing doesn't stick out or feel squished under your ear ridge.
<p>Too big</p>	 <p>When the eartip is too big:</p> <ul style="list-style-type: none"> • The eartip feels squished in your ear canal. • The eartip wing is sticking out or feels squished under your ear ridge.
<p>Too small</p>	 <p>When the eartip is too small:</p> <ul style="list-style-type: none"> • The eartip rests inside your ear canal, feels loose in your ear, or falls out when you move your head. • The eartip wing doesn't reach your ear ridge.

TRY ANOTHER EARTIP SIZE

Wear the earbuds for an extended period of time. If the eartips don't feel comfortable or secure, or sound quality isn't as expected, try another eartip size.

The size is marked on the bottom of each eartip with a **1** (small), **2** (medium), or **3** (large).



The size 2 eartips come attached to the earbuds. If size 2 feels too loose, try size 3. If it feels too tight, try size 1.

You may need to try all three eartip sizes or use a different size eartip for each ear.

CHANGE THE EARTIPS

1. Holding the earbud, gently stretch the eartip base and peel it away from the earbud.

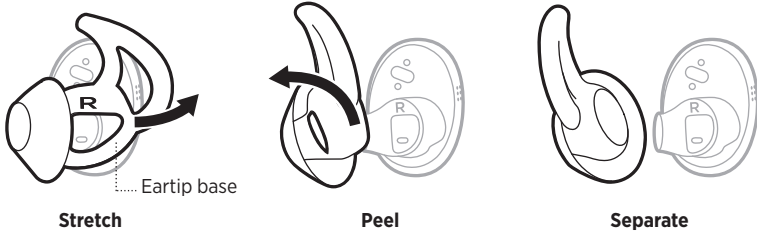

CAUTION: To prevent tearing, do NOT pull on the top of the eartip.

2. Choose a new eartip size (see page 18).
3. Align the earbud nozzle with the back of the eartip, and slide the earbud nozzle onto the eartip.

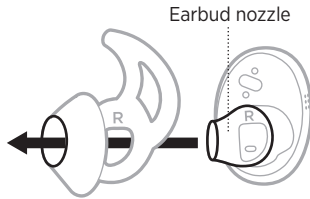

4. Gently stretch the base of the eartip around the nozzle, and press down until the eartip clicks securely into place.

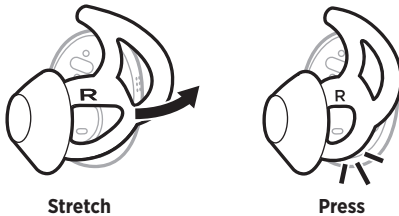

5. Insert the earbuds (see page 16).
6. Check the fit (see page 17).

POWER ON

Press the button on the front of the charging case.

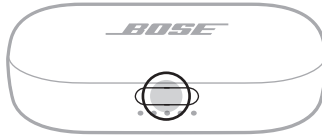

When the charging case opens, the earbuds power on. The earbud status lights (see page 29) and charging case status lights glow (see page 30).

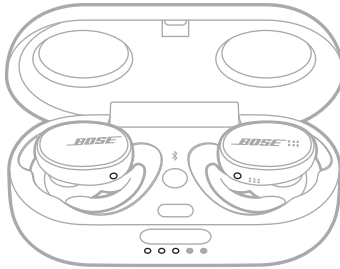

NOTE: When you remove the earbuds from the charging case, close the case to help preserve the battery life and keep the case free of debris.

POWER OFF

1. Place both earbuds in the charging case.

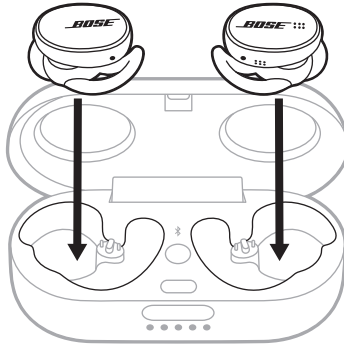

The earbud status lights glow according to the charging status (see page 29).

2. Close the case.

The earbuds power off.

STANDBY

Standby conserves the earbud battery when the earbuds are out of the case and not in use. The earbuds switch to Standby when you remove both earbuds from your ears for 20 minutes.

To wake the earbuds, insert the right earbud into your ear.



Use touch control by tapping or swiping the touch surface of the earbuds. With touch control, you can play/pause audio, change the volume (if enabled), perform basic call functions, access mobile device voice control, and use a Shortcut (see page 25).

TOUCH SURFACE AREA

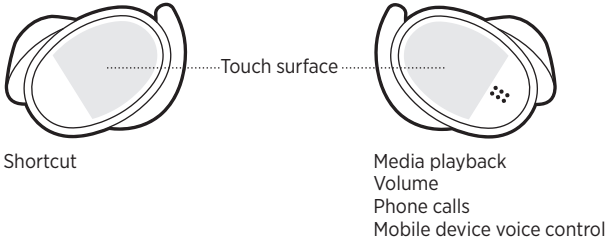
The touch surface is located on the outer surface of each earbud. The right earbud controls media playback, volume, phone calls, and mobile device voice control. The left earbud controls your Shortcut.





MEDIA PLAYBACK AND VOLUME

CONTROL	WHAT TO DO	
Play/Pause	Double-tap the right earbud.	
Increase the volume*	Swipe up on the right earbud.	
Decrease the volume*	Swipe down on the right earbud.	

*To enable this feature, use the Bose Music app. You can access this option from the Settings menu.

PHONE CALLS

CONTROL	WHAT TO DO	
Answer/End a call	Double-tap the right earbud.	
Decline a call	Touch and hold the right earbud.	

NOTE: The microphone is located on the right earbud. When talking on the phone, you must wear the right earbud. You hear audio from both earbuds.



Call notifications

A voice prompt announces incoming callers and call status.

To stop call notifications, disable voice prompts using the Bose Music app. You can access this option from the Settings menu.

MOBILE DEVICE VOICE CONTROL

You can access your mobile device voice control using the earbuds. The microphone on the right earbud acts as an extension of the microphone in your mobile device.

CONTROL	WHAT TO DO	
Access mobile device voice control	Touch and hold the right earbud until you hear a tone. Release, then say your request.	
Stop mobile device voice control	Double-tap the right earbud.	

In-ear detection uses sensors to identify when you're wearing the right earbud. You can automatically play/pause audio and answer phone calls (if enabled) by inserting or removing the right earbud.

NOTE: To disable in-ear detection features, use the Bose Music app. You can access these options from the Settings menu.

AUTO PLAY/PAUSE

When you remove the right earbud, audio pauses on both earbuds.

To resume audio, reinsert the right earbud.

AUTO ANSWER CALL

You can answer phone calls by inserting the right earbud.

NOTE: To enable this feature, use the Bose Music app. You can access this option from the Settings menu.

SHORTCUT

A Shortcut enables you to quickly and easily access one of the following functions:

- Check the earbud battery level.
- Skip a track.

Set a Shortcut

To set a Shortcut, use the Bose Music app. You can access this option from the Settings menu.

Use your Shortcut

To use your Shortcut, double-tap the left earbud.



Remove or change your Shortcut

To remove or change your Shortcut, use the Bose Music app. You can access this option from the Settings menu.

CHARGE THE EARBUDS

1. Align the charging contacts on the left earbud with the charging pins on the left side of the charging case.

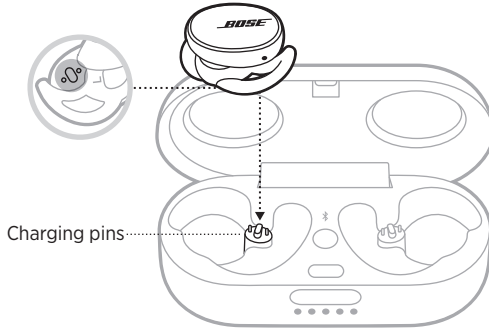

NOTE: Before charging, make sure the earbuds are at room temperature, between 46° F (8° C) and 102° F (39° C).

2. Place the earbud in the charging case until it magnetically snaps into place.
The earbud status light glows according to the charging status (see page 29).

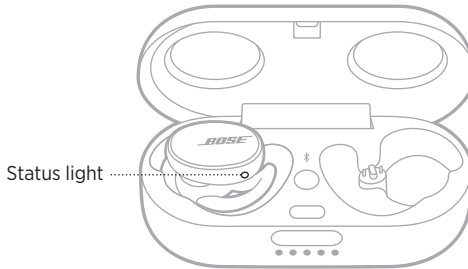

3. Repeat steps 1 - 2 for the right earbud.
4. Close the charging case.

NOTE: If the case is also charging, it can remain open.

CHARGE THE CHARGING CASE

CAUTION: Use this product only with an agency approved power supply which meets local regulatory requirements (e.g., UL, CSA, VDE, CCC).

1. With the charging case closed, connect the small end of the USB cable to the USB-C port.

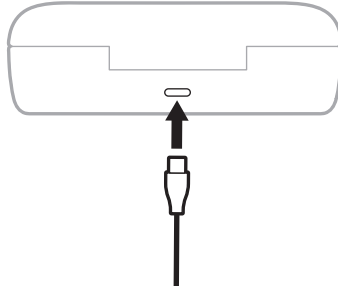

2. Connect the other end to a USB-A wall charger (not provided).
The charging case status lights glow (see page 30).

NOTES:

- If the earbuds are in the case, the case can remain open.
- Before charging, make sure the case is at room temperature, between 46° F (8° C) and 102° F (39° C).

CHECK THE EARBUD BATTERY LEVEL

While using the earbuds

- When you remove the earbuds from the charging case and insert them into your ears, a voice prompt announces the earbud battery level.
- If you set your Shortcut to check the battery level, double-tap the left earbud (see page 25). A voice prompt announces the earbud battery level.
- Use the Bose Music app. The earbud battery level is displayed on the My Products screen and the home screen.

NOTE: If one earbud has a lower battery level than the other, the voice prompt announces the lower battery level. If the battery is low, you hear “Battery low, please charge now.”

While charging the earbuds

When you place the earbuds into the charging case, the earbud status lights glow according to the charging status (see page 29).

CHECK THE CHARGING CASE BATTERY LEVEL

Press the button on the front of the charging case to open the case.

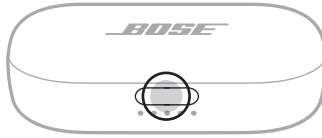

The charging case status lights glow according to the battery level (see page 30).

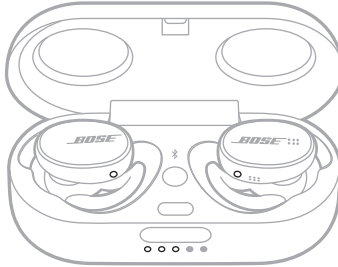

CHARGING TIME

COMPONENT	CHARGING TIME
Earbuds	2 hours
Charging case	3 hours

NOTES:

- When the earbud battery level is low, a 15-minute charge powers the earbuds for up to 2 hours.
- A full charge powers the earbuds for up to 5 hours.
- When the case is fully charged, you can fully charge the earbuds up to 2 times.
- When the earbuds are inside of the case, the case charging time varies.

EARBUD STATUS LIGHTS

The earbud status lights are located on the outside surface of each earbud.

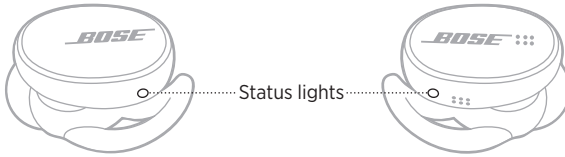

Bluetooth status

Shows the *Bluetooth* connection status of mobile devices.

LIGHT ACTIVITY	SYSTEM STATE
Slowly pulses blue	Ready to connect
Blinks blue	Connecting
Solid blue	Connected

Battery status

Shows the earbud battery status.

LIGHT ACTIVITY	SYSTEM STATE
Slowly pulses white	Charging
Solid white	Fully charged
Slowly pulses red	Need to charge
Blinks red and white	Error - contact Bose customer service

CHARGING CASE STATUS LIGHTS

The charging case status lights are located on the front of the charging case. They show the charge status and battery level of the case and the earbud update status.

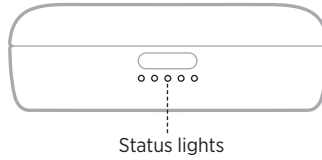

Battery status

Shows the charging case battery level.

LIGHT ACTIVITY	CHARGING PERCENTAGE
○ ● ● ● ●	0% - 20%
○ ○ ● ● ●	21% - 40%
○ ○ ○ ● ●	41% - 60%
○ ○ ○ ○ ●	61% - 80%
○ ○ ○ ○ ○	81% - 100%

NOTE: When the case is charging, the last light blinks according to the current battery level. When it is fully charged, all five charging case status lights glow solid white.

Update and error status

Shows the update and error status.

LIGHT ACTIVITY	SYSTEM STATE
◌ ● ● ● ●	Updating earbuds (see page 35) NOTE: The charging case status lights blink sequentially, starting with the first light.
◌ ● ◌ ● ◌ ●	Charging error – contact Bose customer service

CONNECT USING THE *BLUETOOTH* MENU ON YOUR MOBILE DEVICE

You can store up to seven devices in the earbud device list. You can connect and play audio from only one device at a time.

NOTE: For the best experience, use the Bose Music app to set up and connect your mobile device (see page 14).

1. Press and hold the *Bluetooth* button  in the charging case until you hear “Ready to connect.”

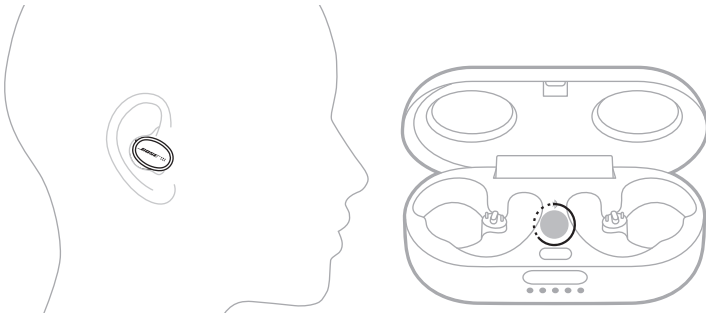

NOTE: If you're not wearing the earbuds, press and hold the *Bluetooth* button  in the charging case until the earbud status lights slowly pulse blue.

2. On your device, enable the *Bluetooth* feature.

NOTE: The *Bluetooth* feature is usually found in the Settings menu.

3. Select the earbuds from the device list.

NOTE: Look for the name you entered for your earbuds in the Bose Music app. If you didn't name your earbuds, the default name appears.

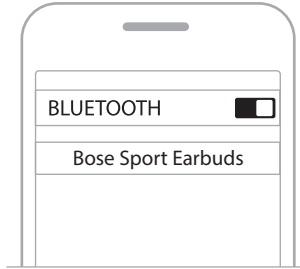

Once connected, you hear "Connected to <mobile device name>." The earbuds name appears in the mobile device list.

NOTE: If you're not wearing the earbuds, the status lights glow solid blue.

DISCONNECT A MOBILE DEVICE

Use the Bose Music app to disconnect your mobile device.

TIP: You can also use *Bluetooth* settings to disconnect your device. Disabling the *Bluetooth* feature disconnects all other devices.

RECONNECT A MOBILE DEVICE

When powered on, the earbuds try to connect with the most recently-connected device.

NOTES:

- The device must be within range (30 ft or 9 m) and powered on.
- Make sure the *Bluetooth* feature is enabled on your mobile device.

CLEAR THE EARBUD DEVICE LIST

1. Press and hold the *Bluetooth* button  in the charging case until you hear “*Bluetooth* device list cleared.”

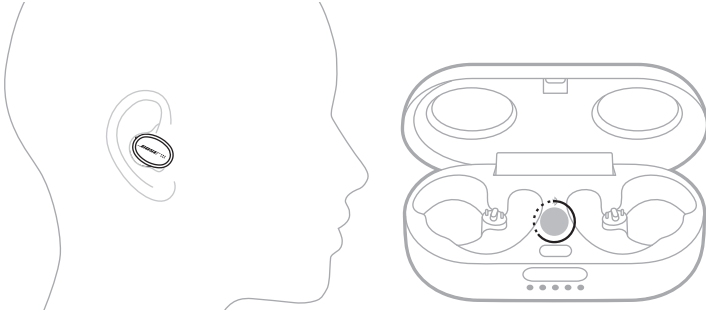

NOTE: If you're not wearing the earbuds, press and hold the *Bluetooth* button  in the charging case for 10 seconds. The earbud status lights slowly pulse blue.

2. Delete the earbuds from the *Bluetooth* list on your mobile device.

All devices are cleared, and the earbuds are ready to connect (see page 14).

STORE THE EARBUDS

When you're not using the earbuds, store them in the charging case. Close the charging case to help preserve battery life and keep the charging case free of debris.

When storing the earbuds for an extended period of time (more than 4 weeks), make sure they are stored at room temperature and the charging case battery level is greater than 40% (see page 30).

CLEAN THE EARBUDS AND CHARGING CASE

COMPONENT	PROCEDURE
Eartips	Remove the tips from the earbuds and wash them with a mild detergent and water. NOTE: Make sure you thoroughly rinse and dry the tips before re-attaching them to the earbuds.
Earbud nozzles	Wipe only with a dry, soft cotton swab or equivalent. CAUTION: Never insert any cleaning tool into the nozzle.
Charging contacts (on earbuds) and charging pins (in charging case)	To prevent rusting, wipe with a dry, soft cotton swab or equivalent.
Charging case	Wipe only with a dry, soft cotton swab or equivalent.

REPLACEMENT PARTS AND ACCESSORIES

Replacement parts and accessories can be ordered through Bose customer service.

Visit: worldwide.Bose.com/Support/SportEarbuds

LIMITED WARRANTY

The earbuds are covered by a limited warranty. Visit our website at global.Bose.com/warranty for details of the limited warranty.

To register your product, visit global.Bose.com/register for instructions. Failure to register will not affect your limited warranty rights.

UPDATE THE EARBUDS

The earbuds and charging case begin updating automatically when connected to the Bose Music app and an update is available. Follow the app instructions.

TIP: You can also update the earbuds and charging case using the Bose updater website. On your computer, visit: btu.bose.com and follow the on-screen instructions.

VIEW THE EARBUD DATE CODE

Remove the eartip from the earbud (see page 19).

The date code is located on the earbud nozzle.

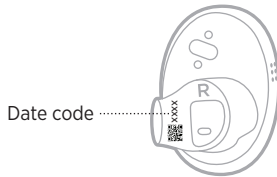

VIEW THE CHARGING CASE SERIAL NUMBER

Remove the right earbud from the charging case.

The charging case serial number is located on the left side of the right earbud well.

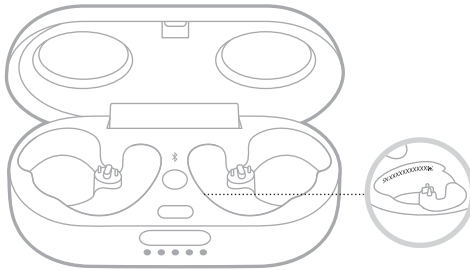

TIP: The charging case serial number is also located on the carton outer label.

TRY THESE SOLUTIONS FIRST

If you experience problems with the earbuds, try these solutions first:

- Charge the battery (see page 26).
- Power on the earbuds (see page 20).
- Check the earbud status lights and charging case status lights (see page 29).
- Make sure your mobile device supports *Bluetooth* connections (see page 31).
- Download the Bose Music app and run available software updates (see page 14).
- Move your mobile device closer to the earbuds (30 ft or 9 m) and away from any interference or obstructions.
- Increase the volume on the earbuds, your mobile device, and the music app.
- Connect another mobile device (see page 14).

OTHER SOLUTIONS

If you could not resolve your issue, see the table below to identify symptoms and solutions to common problems. If you are unable to resolve your issue, contact Bose customer service.

Visit: worldwide.bose.com/contact

SYMPTOM	SOLUTION
Earbuds don't power on	<p>Make sure the earbuds aren't in Standby mode. To wake the earbuds, insert the right earbud in your ear.</p> <p>Place both earbuds in the charging case until they magnetically snap into place. Close and re-open the case. The earbud status lights display charge status (see page 29).</p> <p>If the earbuds have been exposed to high or low temperatures, let the earbuds return to room temperature.</p>

SYMPTOM	SOLUTION
Earbuds don't connect with mobile device	<p>On your device:</p> <ul style="list-style-type: none"> • Turn the <i>Bluetooth</i> feature off and then on. • Delete the earbuds from the <i>Bluetooth</i> list on your device. Connect again (see page 14). <p>Place both earbuds in the charging case until they magnetically snap into place, and the status lights display charge status (see page 29). Close and re-open the case. Connect again (see page 14).</p> <p>Make sure you're wearing the right earbud.</p> <p>Make sure the right earbud is within range (30 ft or 9 m) of the charging case and the case is open.</p> <p>Clear the earbud device list (see page 33). Connect again (see page 14).</p> <p>Visit: worldwide.bose.com/Support/SportEarbuds to see how-to videos.</p> <p>Reboot the earbuds and charging case (see page 41).</p>
Earbuds don't respond during app setup	<p>Make sure you're using the Bose Music app for setup (see page 14).</p> <p>Make sure the <i>Bluetooth</i> feature is on in your mobile device Settings menu.</p>
Bose Music app can't find earbuds	<p>While wearing the earbuds, press and hold the <i>Bluetooth</i> button  in the charging case until you hear "Ready to connect."</p> <p>Place both earbuds in the charging case until they magnetically snap into place. Close and re-open the case. Remove the earbuds.</p>
Bose Music app doesn't work on mobile device	<p>Make sure your mobile device is compatible with the Bose Music app and meets minimum system requirements. For more information, refer to the app store on your mobile device.</p> <p>Uninstall the Bose Music app on your mobile device. Reinstall the app (see page 14).</p>
Intermittent <i>Bluetooth</i> connection	<p>Clear the earbud device list (see page 33). Connect again (see page 14).</p> <p>Move your mobile device closer to the right earbud.</p> <p>Reboot the earbuds and charging case (see page 41).</p>

SYMPTOM	SOLUTION
No sound	<p>Make sure that both eartips fit securely in your ear and they aren't rotated too far back (see page 16).</p> <p>Make sure your head is upright when inserting the earbuds.</p> <p>Press play on your mobile device to make sure audio is playing.</p> <p>Play audio from a different application or music service.</p> <p>Play audio from content stored directly on your device.</p> <p>Restart your mobile device.</p> <p>Make sure the earbuds are within range of each other.</p> <p>Disable in-ear detection features using the Bose Music app.</p>
No sound from one earbud	<p>Make sure that both eartips fit securely in your ear and they aren't rotated too far back (see page 16).</p> <p>Make sure your head is upright when inserting the earbuds.</p> <p>Make sure the earbuds are within range of each other.</p> <p>Place both earbuds in the charging case until they magnetically snap into place, and the earbud status lights display charge status (see page 29). Remove the earbuds.</p>
Audio and video are out of sync	<p>Close and re-open the application or music service.</p> <p>Play audio from a different application or music service.</p> <p>Place both earbuds in the charging case until they magnetically snap into place. Close the case for 10 seconds. Open the case. Remove the earbuds.</p>
Poor sound quality	<p>Make sure that both eartips fit securely in your ear and they aren't rotated too far back (see page 16).</p> <p>Try a different audio track.</p> <p>Play audio from a different application or music service.</p> <p>Clear any debris or wax buildup from the eartips and earbud nozzles.</p> <p>Turn off any audio enhancement features on the device or music app.</p> <p>Make sure your earbuds are connected over the correct <i>Bluetooth</i> profile: Stereo A2DP. Check your device's <i>Bluetooth</i>/audio settings menu to make sure the correct profile is selected.</p> <p>On your device:</p> <ul style="list-style-type: none"> • Turn the <i>Bluetooth</i> feature off and then on. • Delete the earbuds from the <i>Bluetooth</i> list on your device. Connect again (see page 14).

SYMPTOM	SOLUTION
<p>Microphone doesn't pick up sound</p>	<p>Make sure that both eartips fit securely in your ear and they aren't rotated too far back (see page 16).</p> <p>Make sure the microphone openings on the right earbud aren't blocked.</p> <p>Make sure the microphone isn't muted on your phone.</p> <p>If you're on a phone call, make sure you're using the right earbud.</p> <p>Try another phone call.</p> <p>Try another compatible device.</p> <p>On your device:</p> <ul style="list-style-type: none"> • Turn the <i>Bluetooth</i> feature off and then on. • Delete the earbuds from the <i>Bluetooth</i> list on your device. Connect again (see page 14).
<p>Earbuds don't charge</p>	<p>Make sure the earbuds are properly placed in the charging case. To help preserve the battery life, the case should be closed while the earbuds are charging (see page 26).</p> <p>Make sure there is no dirt or debris covering the charging contacts on the earbuds or the charging pins in the case.</p> <p>Make sure the USB cable is correctly aligned with the port on the charging case.</p> <p>Secure both ends of the USB cable.</p> <p>Try another USB cable.</p> <p>Try another wall charger.</p> <p>If the earbuds or charging case have been exposed to high or low temperatures, let the earbuds or case return to room temperature. Charge again (see page 26).</p>
<p>Charging case doesn't charge</p>	<p>Make sure the USB cable is correctly aligned with the port on the charging case.</p> <p>Secure both ends of the USB cable.</p> <p>Try another USB cable.</p> <p>Make sure the charging case is closed. To help preserve the battery life, the case should be closed while it's charging (see page 27).</p> <p>Try another wall charger.</p> <p>If the charging case has been exposed to high or low temperatures, let the case return to room temperature. Charge again (see page 27).</p>

SYMPTOM	SOLUTION
Eartips falling off	Securely attach the eartips to the earbuds (see page 19).
Earbuds don't respond	<p>Place both earbuds in the charging case until they magnetically snap into place, and the status lights display charge status. Close and re-open the case. The earbud status lights display charge status (see page 29).</p> <p>Reboot the earbuds and charging case (see page 41).</p>
Earbuds don't respond to touch control	<p>Make sure you're tapping the correct touch control surface (see page 22).</p> <p>Make sure your finger is making good contact with the touch control surface (see page 22).</p> <p>For multi-tap functions, vary the tap pressure.</p> <p>Make sure your hands are dry.</p> <p>If your hair is wet, make sure it isn't interfering with the touch surface.</p> <p>If wearing gloves, remove them before tapping the touch control surface.</p> <p>Disable in-ear detection features using the Bose Music app (see page 24).</p> <p>If the earbuds have been exposed to high or low temperatures, let the earbuds return to room temperature.</p> <p>Reboot the earbuds and charging case (see page 41).</p>
Can't adjust volume	<p>Make sure volume control is enabled using the Bose Music app (see page 22).</p> <p>Make sure you're swiping the touch control surface in the right direction (see page 22).</p> <p>See "Earbuds don't respond to touch control" above.</p>
Can't access Shortcut	Make sure you have set a Shortcut using the Bose Music app (see page 25).
Voice prompt language isn't correct	Change the voice prompt language using the Bose Music app (see page 14). You can access this option from the Settings menu.
Not receiving call notifications	Make sure voice prompts are enabled using the Bose Music app (see page 14). You can access this option from the Settings menu.

REBOOT THE EARBUDS AND CHARGING CASE

If the earbuds are unresponsive, you can reboot them.

NOTE: Rebooting the earbuds clears the earbud device list. It doesn't clear other settings.

1. Place the earbuds in the charging case.
2. Press and hold the *Bluetooth* button ✂ in the charging case for 30 seconds until the earbud status lights blink.

When the reboot is complete, the earbud status lights (see page 29) and charging case status lights glow (see page 30).



836279-0010