

brother

Reference Guide

Brief explanations for routine operations

DCP-L2531DW / DCP-L2535DW / DCP-L2550DW / HL-L2395DW /
MFC-L2710DW / MFC-L2713DW / MFC-L2715DW / MFC-L2716DW /
MFC-L2730DW / MFC-L2750DW / MFC-L2751DW / MFC-L2770DW /
MFC-L2771DW

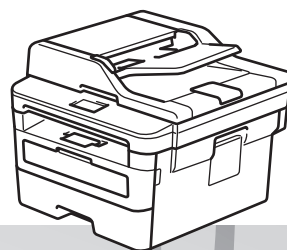

Brother recommends keeping this guide next to your Brother machine for quick reference.



Online User's Guide

For more advanced instructions, information, and product specifications, see the *Online User's Guide* at support.brother.com/manuals



User's Guides and Where to Find Them

| Which Guide? | What's in It? | Where Is It? |
|---|---|--|
| Product Safety Guide | Read this Guide first. Please read the Safety Instructions before you set up your machine. See this Guide for trademarks and legal limitations. | Printed / In the box |
| Quick Setup Guide | Follow the instructions for setting up your machine, and installing the Full Driver & Software Package for the operating system and connection type you are using. | Printed / In the box |
| Reference Guide | Learn the basic Fax, Copy and Scan operations and basic machine maintenance. See troubleshooting tips. | Printed or on Brother Installation Disc / In the Box |
| Online User's Guide | This guide includes the additional contents of the <i>Reference Guide</i> . In addition to information about the Print, Scan, Copy, Fax, mobile device functions, Brother ControlCenter operations and troubleshooting, other useful information is included about using the machine on a network. | Brother Solutions Center ¹ |
| Mobile Print/Scan Guide for Brother iPrint&Scan | This Guide provides useful information about printing from your mobile device, and scanning from your Brother machine to your mobile device when connected to a Wi-Fi® network. | Brother Solutions Center ¹ |

¹ Visit support.brother.com/manuals.

The Online User's Guide Helps You Get the Most Out of Your Machine

We hope that you find this guide helpful. To learn more about your machine's features, please take a look at our *Online User's Guide*. It offers:

Quicker Navigation!

- ✓ Search box
- ✓ Navigation index in a separate panel

Comprehensive Format!

- ✓ Every topic in one guide

Simplified Layout!

- ✓ Step-by-step instructions
- ✓ Feature summary at the top of the page



1. Search Box
2. Navigation
3. Summary
4. Step-by-Step Instructions

To View Online User's Guides

To view the *Online User's Guide* and other available guides, visit support.brother.com/manuals.

(Windows®)

You can also access your machine's guides using Brother Utilities. The Brother Utilities tool is included in the standard installation and, when installed, you can find it either as a shortcut on your desktop, or from the Windows® **Start** menu.

Questions or Problems? Take a Look at our FAQs, Solutions, and Videos Online.

Go to your model's **FAQs & Troubleshooting** page on the Brother Solutions Center at support.brother.com

- **Provides several ways to search**
- **Displays related questions for more information**
- **Receives regular updates based on customer feedback**

©2017 Brother Industries, Ltd. All rights reserved.

Control Panel Overview

Related Models:

DCP-L2531DW/DCP-L2535DW/DCP-L2550DW/MFC-L2710DW/MFC-L2713DW/MFC-L2715DW/MFC-L2716DW

The control panel may vary depending on your model.

MFC-L2710DW/MFC-L2713DW/MFC-L2715DW/MFC-L2716DW

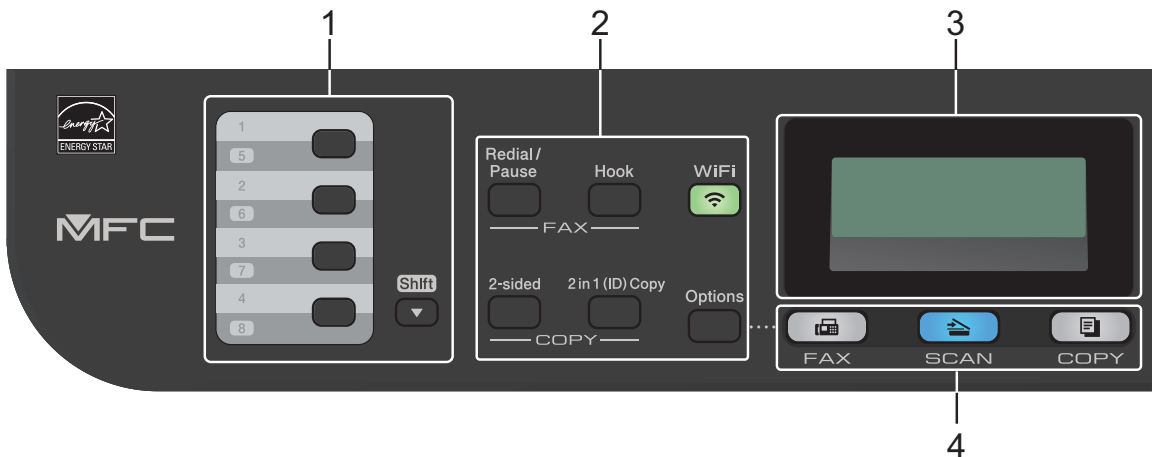

1. One Touch buttons

Store and recall up to eight fax and telephone numbers.

To access stored One Touch fax and telephone numbers 1-4, press the One Touch button assigned to that number. To access stored One Touch fax and telephone numbers 5-8, press and hold **Shift** as you press the button.

2. Function buttons

Redial/Pause

Press to dial the last number you called. This button also inserts a pause when programming quick dial numbers or when dialling a number manually.

Hook

Press **Hook** before dialing to ensure a fax machine answers, and then press **Start**.

If the machine is in Fax/Tel (F/T) Mode and you pick up the handset of an external telephone during the F/T ring (pseudo double-rings), press **Hook** to talk.

WiFi (for wireless models)

Press the **WiFi** button and launch the wireless installer on your computer. Follow the on-screen instructions to set up a wireless connection between your machine and your network.

When the **WiFi** light is on, your Brother machine is connected to a wireless access point. When the **WiFi** light blinks, the wireless connection is down, or your machine is in the process of connecting to a wireless access point.

Resolution (for certain models only)

Press to change the Fax resolution.

2 in 1 (ID) Copy

Press to copy both sides of an identification card onto a single page.

2-sided

Press to copy on both sides of a sheet of paper.

Options

Press to access temporary settings for faxing, scanning, or copying.

3. Liquid Crystal Display (LCD)

Displays messages to help you set up and use the machine.

If the machine is in Fax Mode, the LCD displays:

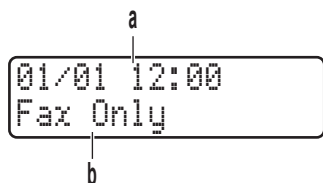

- a. Date & Time
- b. Receive Mode

When you press **COPY**, the LCD displays:

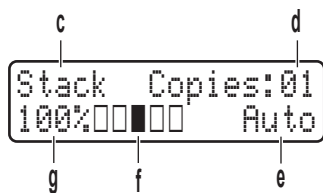

- c. Type of copy
- d. Number of copies
- e. Quality
- f. Contrast
- g. Copy ratio

4. Mode buttons

FAX

Press to switch the machine to FAX Mode.

SCAN

Press to switch the machine to SCAN Mode.

COPY

Press to switch the machine to COPY Mode.

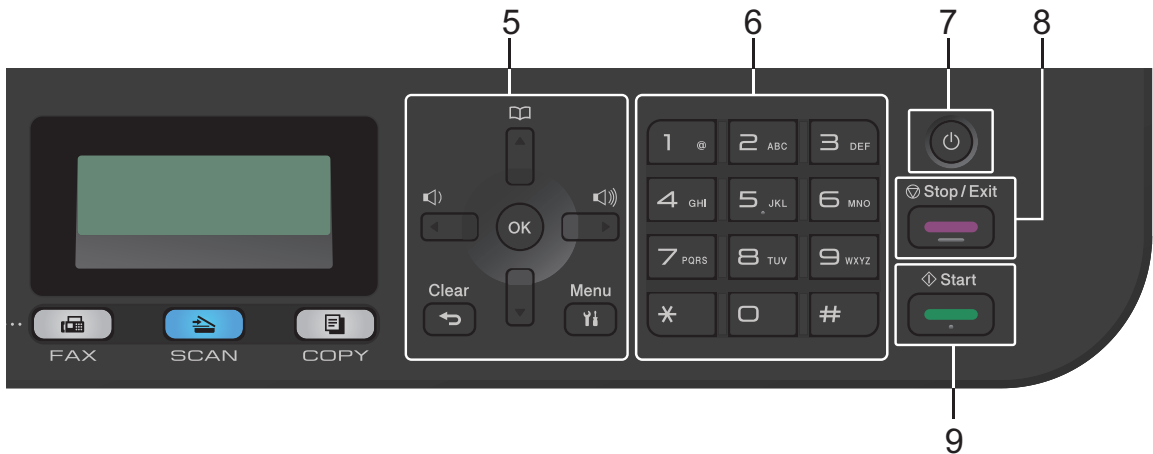

5. Menu buttons

Clear

Press to delete entered data or cancel the current setting.

Menu

Press to access the Menu for programming your machine settings.

OK

Press to store your machine settings.

◀ or ▶

Press to scroll back or forward through menu selections.

▲ or ▼

- Press to scroll up or down through menus and options.
- Press to change the resolution in Fax Mode.





Press  to access speed dial numbers.

6. Dial Pad

- Use to dial fax and telephone numbers.
- Use as a keyboard to enter text or characters.

7. Power On/Off

- Turn on the machine by pressing .
- Turn off the machine by pressing and holding . The LCD displays [Shutting Down] and stays on for a few seconds before turning off. If you have an external telephone or TAD connected, it is always available.

8. Stop/Exit



- Press to stop an operation.
- Press to exit from a menu.

9. Start

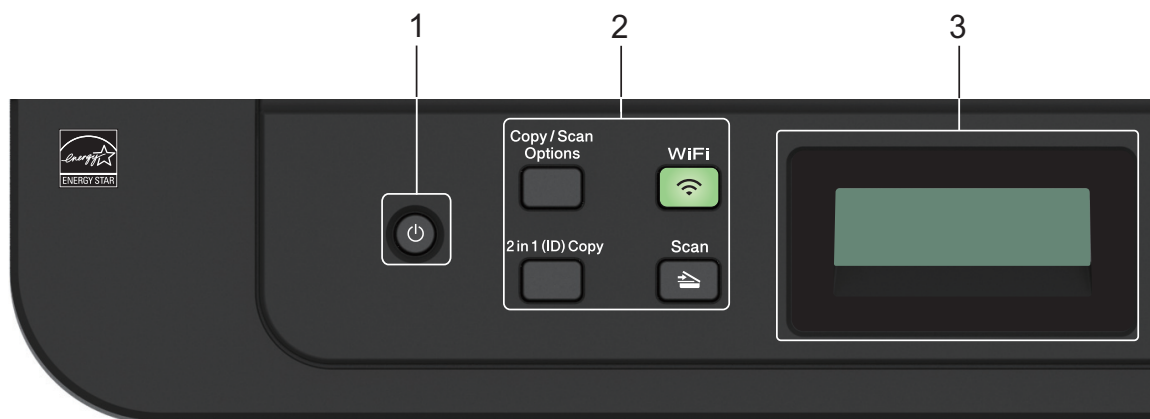
- Press to start sending faxes.
- Press to start copying.
- Press to start scanning documents.



1. Power On/Off

- Turn on the machine by pressing .
- Turn off the machine by pressing and holding . The LCD displays [Shutting Down] and stays on for a few seconds before turning off.

2. Function buttons

Copy/Scan Options

Press to access temporary settings for scanning or copying.

WiFi (for wireless models)

Press the **WiFi** button and launch the wireless installer on your computer. Follow the on-screen instructions to set up a wireless connection between your machine and your network.

When the **WiFi** light is on, your Brother machine is connected to a wireless access point. When the **WiFi** light blinks, the wireless connection is down, or your machine is in the process of connecting to a wireless access point.

Scan

Press to switch the machine to Scan Mode.

2 in 1 (ID) Copy

Press to copy both sides of an identification card onto a single page.

2-sided (for certain models only)

Press to copy on both sides of a sheet of paper.

3. Liquid Crystal Display (LCD)

Displays messages to help you set up and use the machine.

If the machine is in Ready Mode or COPY Mode, the LCD displays:

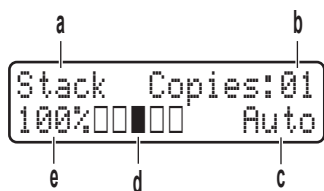

- a. Type of copy
- b. Number of copies
- c. Quality
- d. Contrast
- e. Copy ratio

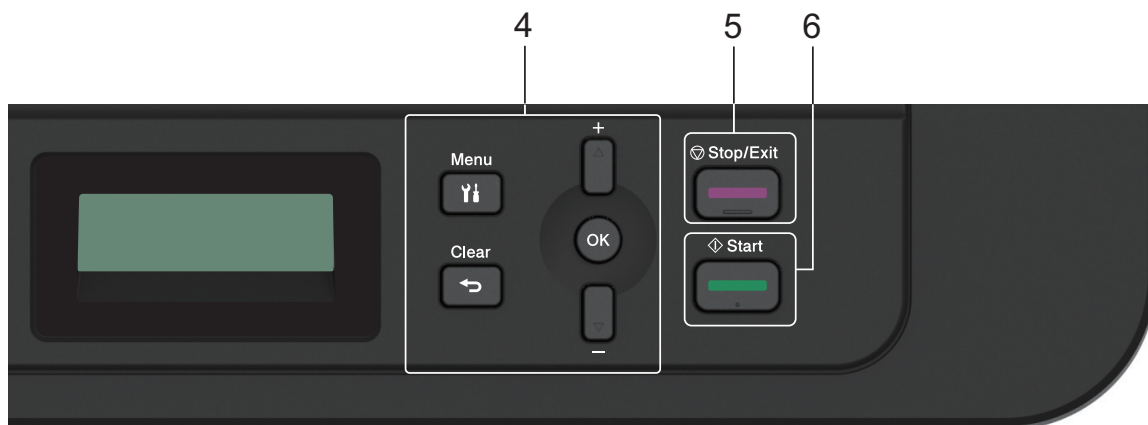

4. Menu buttons

Menu

Press to access the Menu for programming your machine settings.

Clear

- Press to delete entered data.
- Press to cancel the current setting.

OK

Press to store your machine settings.

▲ or ▼

Press to scroll up or down through menus and options.

5. Stop/Exit

- Press to stop an operation.
- Press to exit from a menu.

6. Start

- Press to start copying.

- Press to start scanning documents.

Control Panel Overview

Related Models:

HL-L2395DW/MFC-L2730DW/MFC-L2750DW/MFC-L2751DW/MFC-L2770DW/MFC-L2771DW

The control panel may vary depending on your model.

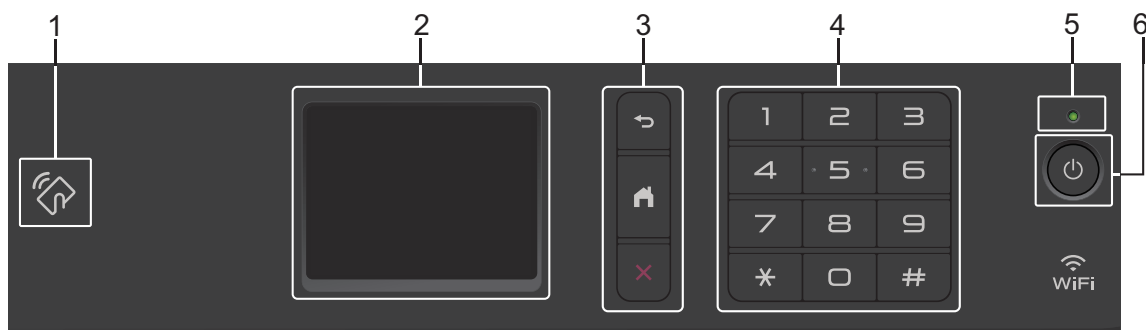

1. Near Field Communication (NFC) (HL-L2395DW/MFC-L2750DW/MFC-L2751DW/MFC-L2770DW/MFC-L2771DW)

If your Android™ device supports the NFC feature, you can print from your device or scan documents to your device by touching it to the NFC symbol on the control panel.

2. Touchscreen Liquid Crystal Display (LCD)

Access menus and options by pressing them on the touchscreen.

3. Menu Buttons



Press to go back to the previous menu.



Press to return to the Home screen.



Press to cancel an operation.



4. Dial Pad (Numerical buttons)

Press the numbers on the touchpanel to dial telephone or fax numbers and to enter the number of copies.

5. LED Power Indicator

The LED lights up depending on the machine's power status.

6. Power On/Off

- Turn on the machine by pressing .
- Turn off the machine by pressing and holding down . The touchscreen LCD displays [Shutting Down] and stays on for a few seconds before turning off. If you have an external telephone or TAD connected, it is always available.

Touchscreen LCD Overview

Related Models:

HL-L2395DW/MFC-L2730DW/MFC-L2750DW/
MFC-L2751DW/MFC-L2770DW/MFC-L2771DW

When a Home screen is displayed, press ◀ or ▶ to display the other Home screens.

The Home screen displays the machine's status when the machine is idle. When displayed, this screen indicates that your machine is ready for the next command.



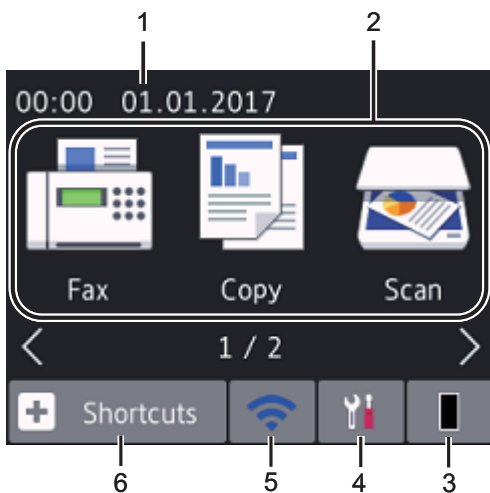

The available features will vary depending on your model.



1. Date & Time

Displays the date and time set on the machine.

2. Modes

-  [Fax]
Press to access Fax mode.
-  [Copy]
Press to access Copy mode.
-  [Scan]
Press to access Scan mode.
-  [Secure Print]
Press to access the [Secure Print] option.

-  [Web]

Press to connect the Brother machine to an Internet service.

-  [Apps]

Press to connect the Brother machine to the Brother Apps service.

3. Toner

Displays the remaining toner life. Press to access the [Toner] menu.

When the Toner cartridge is near the end of life or has a problem, an error icon  appears on the Toner icon.

4. [Settings]

Press to access the [Settings] menu.

If Secure Function Lock or Setting Lock has been turned on, a lock  icon appears on the LCD. You must unlock the machine to use Settings.

5. or

(Wireless Status for wireless models)

Press to configure wireless settings.

If you are using a wireless connection, a four-level indicator in each of the Home screens displays the current wireless signal strength.

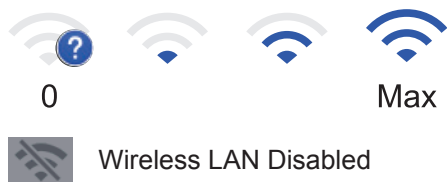

6.  [Shortcuts]

Press to create Shortcuts for frequently-used operations, such as sending a fax, making a copy, scanning and using Web Connect.



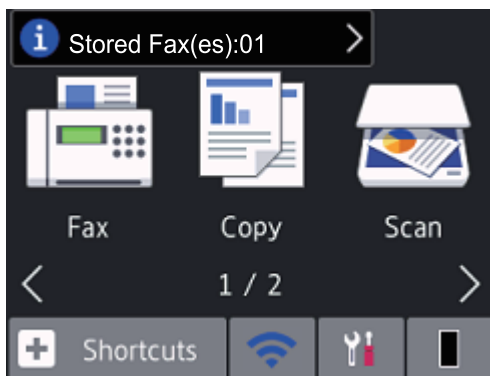

- Three Shortcuts screens are available with up to four Shortcuts on each Shortcuts screen. A total of 12 Shortcuts are available.
- To display the other Shortcuts screens, press ◀ or ▶.

Stored Fax(es)

The number of received faxes in memory appears at the top of the screen.

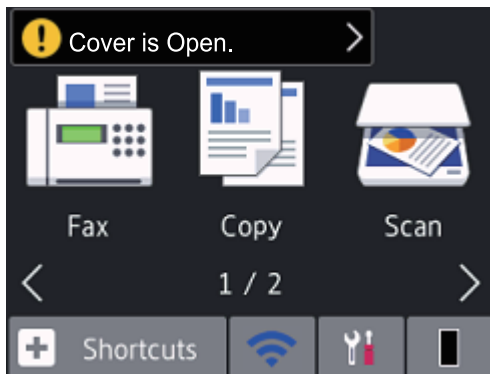
Press , and then press [Yes] to print the faxes.

Warning icon

The warning icon  appears when there is an error or maintenance message; press the message area to view it, and then press  to return to Ready Mode.

NOTE

- This product adopts the font of ARPHIC TECHNOLOGY CO., LTD.

How to Navigate the Touchscreen LCD**Related Models:**

HL-L2395DW/MFC-L2730DW/MFC-L2750DW/
MFC-L2751DW/MFC-L2770DW/MFC-L2771DW

Press your finger on the LCD to operate it. To display and access all the options, press ◀▶ or ▲▼ on the LCD to scroll through them.

The following steps explain how to navigate through changing a machine setting. In this example, the LCD Backlight setting is changed from [Light] to [Med].

IMPORTANT

DO NOT press the LCD with a sharp object such as a pen or stylus. It may damage the machine.

NOTE

DO NOT touch the LCD immediately after plugging in the power cord or turning on the machine. Doing this may cause an error.

1 Press  ([Settings]).

2 Press [All Settings].

- 3 Press ▲ or ▼ to display the [General Setup] option, and then press [General Setup].

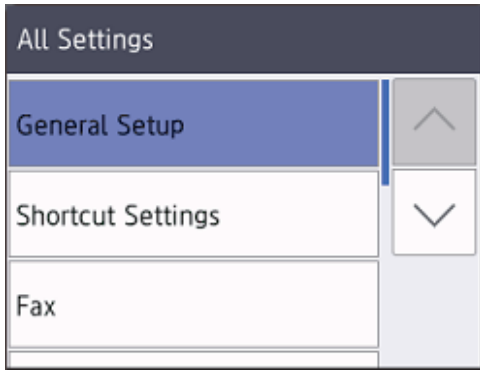

- 4 Press ▲ or ▼ to display the [LCD Settings] option, and then press [LCD Settings].

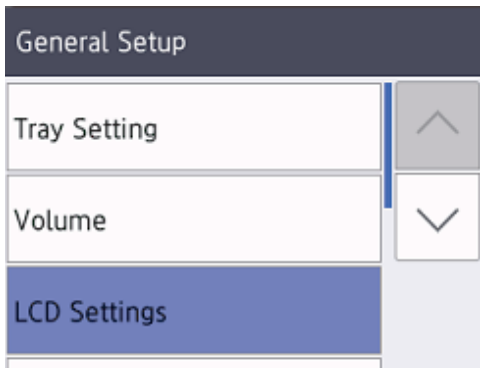

- 5 Press [Backlight].

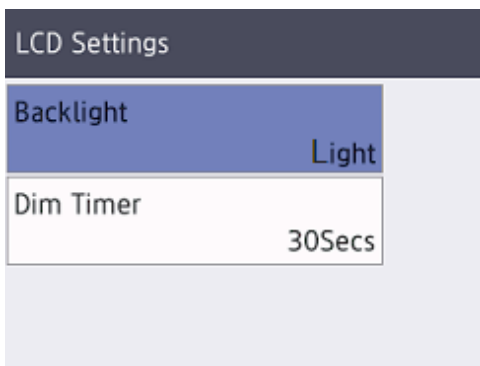

- 6 Press [Med].

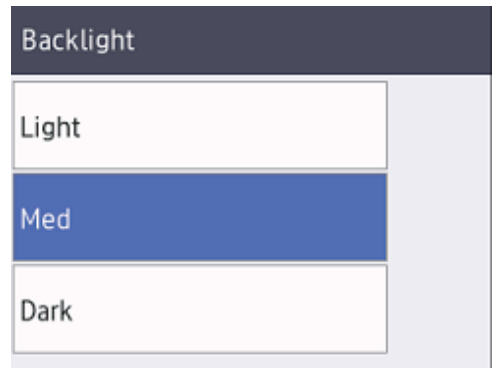

- 7 Press .

Load Paper in the Paper Tray

Use the paper tray when printing on the following media:

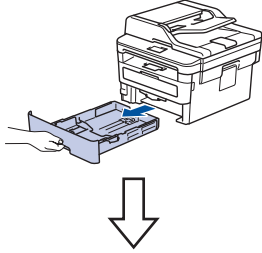
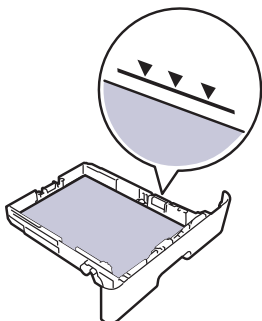
| | |
|--|--|
| <p>Plain paper Thin paper Recycled paper Thick paper</p> |  <ul style="list-style-type: none"> • Adjust the guides • Fan the paper • Do not exceed this mark  |
|--|--|

For more information, see the *Online User's Guide: Load Paper in the Paper Tray*.

Load Paper in the Multi-purpose Tray (MP Tray)

Related Models:

MFC-L2770DW/MFC-L2771DW

Use the MP tray when printing on the following media:

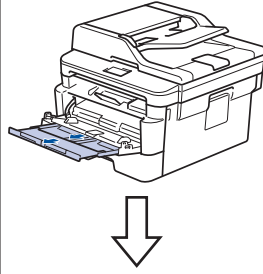
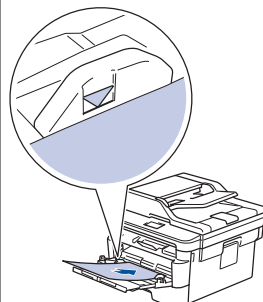
| | |
|--|--|
| <p>Plain paper Thin paper Recycled paper Bond paper Thick paper Labels ¹ Envelopes ¹</p> |  <ul style="list-style-type: none"> • Adjust the guides • Fan the paper • Do not exceed this mark  |
|--|--|

¹ Open the back cover (face up output tray) before printing to let the printed paper exit onto the face up output tray.

For more information, see the *Online User's Guide: Load and Print Using the Multi-purpose Tray (MP Tray)*.

Load Paper in the Manual Feed Slot

Related Models:

DCP-L2531DW/DCP-L2535DW/DCP-L2550DW/
HL-L2395DW/MFC-L2710DW/MFC-L2713DW/
MFC-L2715DW/MFC-L2716DW/MFC-L2730DW/
MFC-L2750DW/MFC-L2751DW

Use the Manual Feed Slot when printing on the following media:

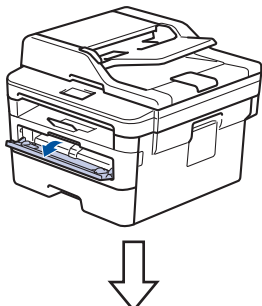
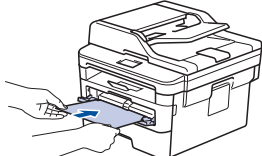
| | |
|--|---|
| <p>Plain paper Thin paper Recycled paper Bond paper Thick paper Labels ¹ Envelopes ¹</p> |  <ul style="list-style-type: none">• Adjust the guides• Use both hands to insert one sheet of paper• Continue pressing the paper against the rollers for about two seconds, or until the machine grabs the paper and pulls it in further  |
|--|---|

¹ Open the back cover (face up output tray) before printing to let the printed paper exit onto the face up output tray.

For more information, see the *Online User's Guide: Load and Print Paper in the Manual Feed Slot*.





Use this section to resolve problems you may encounter when using your Brother machine.

Identify the Problem

Even if there seems to be a problem with your machine, you can correct most problems yourself.

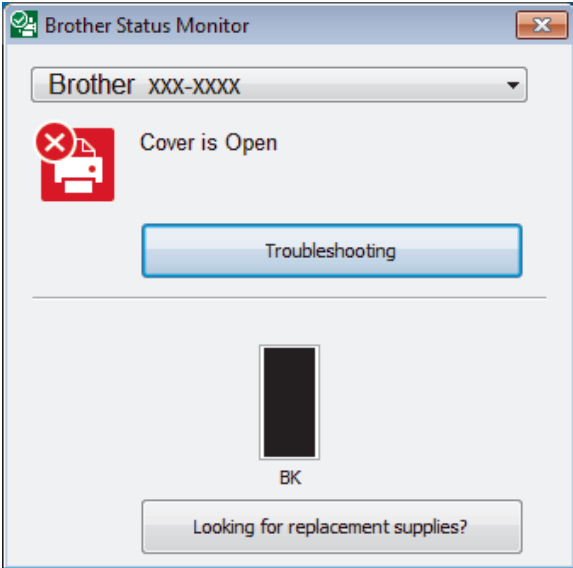
First, check the following:

- The machine's power cord is connected correctly and the machine's power is on.
- All of the machine's orange protective parts have been removed.
- (For network models) The access point (for wireless network), router, or hub is turned on and its link indicator is blinking.
- Paper is inserted correctly in the paper tray.
- The interface cables are securely connected to the machine and the computer.
- Check the machine's status on your machine or in **Brother Status Monitor** on your computer.

| Find the Error | Find the Solution |
|--|---|
| <p>Using the Status Monitor</p> <ul style="list-style-type: none"> • Double-click the  icon in the task tray.  <ul style="list-style-type: none"> • (Windows®) If you select the Load Status Monitor on Startup check box, the Status Monitor will launch automatically each time you start your computer. | <ul style="list-style-type: none"> • A green icon indicates the normal stand-by condition. <ul style="list-style-type: none">  • A yellow icon indicates a warning. <ul style="list-style-type: none">  • A red icon indicates an error has occurred. <ul style="list-style-type: none">  • A grey icon indicates the machine is offline. <ul style="list-style-type: none">  • Click the Troubleshooting button to access Brother's troubleshooting website. |

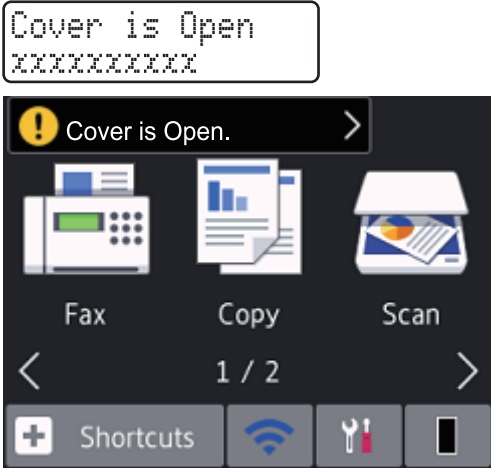
| Find the Error | Find the Solution |
|--|---|
| <p>Using the LCD</p>  <p>The image shows a printer's LCD screen displaying the error message "Cover is Open" in a pixelated font, with "XXXXXXXXXX" below it. Below the screen is a control panel with a yellow warning icon and the text "Cover is Open." followed by a right arrow. Underneath are three large buttons labeled "Fax", "Copy", and "Scan", each with a corresponding icon. At the bottom of the panel are navigation arrows, a "Shortcuts" button with a plus sign, and icons for Wi-Fi, a wrench, and a mobile phone.</p> | <ol style="list-style-type: none"> 1. Follow the messages on the LCD. 2. If you cannot resolve the error, refer to the following: <i>Online User's Guide: Error and Maintenance Messages</i> FAQs & Troubleshooting page at support.brother.com |

Error and Maintenance Messages

For information on the most common error and maintenance messages, see the *Online User's Guide*.

To view the *Online User's Guide* and other available guides, visit support.brother.com/manuals.

Document and Paper Jams

An error message indicates where the paper is stuck in your machine.

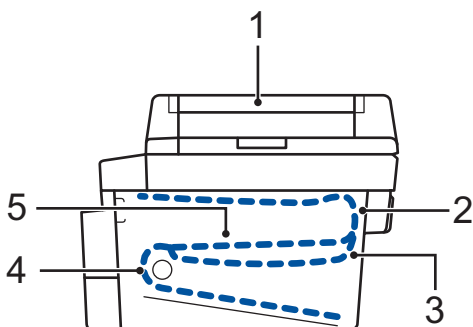

Error messages:

1. Document Jam
2. Jam Rear
3. Jam 2-sided
4. Jam Tray
5. Jam Inside

See the messages in **Brother Status Monitor** on your computer.

Solutions for Wireless Connection

If you cannot connect your Brother machine to the wireless network, see the following:

- *Online User's Guide: Print the WLAN Report*
- *Quick Setup Guide: Alternative wireless setup*

To view the *Online User's Guide* and other available guides, visit support.brother.com/manuals.

Supplies

When the time comes to replace supplies, such as the toner or drum, an error message will appear on your machine's control panel or in the Status Monitor. For more information about the supplies for your machine, visit www.brother.com/original/index.html or contact your local Brother dealer.



- The supply model name will vary depending on your country and region.

Toner Cartridge

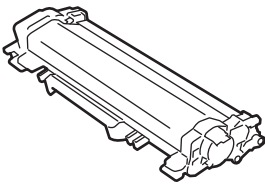

| For Australia and New Zealand | | |
|---|--|--|
| Supply Model Name | Approximate Life (Page Yield) | Applicable Models |
| Standard Toner: TN-2430 (For Australia) TN-2415 (For New Zealand) | Approximately 1,200 pages ^{1 2} | HL-L2395DW/MFC-L2710DW/ MFC-L2713DW/ MFC-L2730DW/ MFC-L2750DW/ MFC-L2770DW |
| High Yield Toner: TN-2450 (For Australia) TN-2445 (For New Zealand) | Approximately 3,000 pages ^{1 2} | HL-L2395DW/MFC-L2710DW/ MFC-L2713DW/ MFC-L2730DW/ MFC-L2750DW/ MFC-L2770DW |
| Super High Yield Toner: TN-2454 (For Australia) TN-2449 (For New Zealand) | Approximately 4,500 pages ^{1 2} | MFC-L2770DW |

¹ Approximate cartridge yield is declared in accordance with ISO/IEC 19752.

² A4/Letter simplex pages

| For Other countries | | |
|--|--|---|
| Supply Model Name | Approximate Life (Page Yield) | Applicable Models |
| Standard Toner: (Not available in India and Turkey) | Approximately 1,200 pages ^{1 2} | DCP-L2531DW/ DCP-L2535DW/ DCP-L2550DW/HL-L2395DW/ MFC-L2710DW/ |

| For Other countries | | |
|--|--|--|
| Supply Model Name | Approximate Life (Page Yield) | Applicable Models |
| TN-2481 (For Indonesia and Vietnam) TN-2460 (For Other countries) | | MFC-L2713DW/ MFC-L2715DW/ MFC-L2716DW/ MFC-L2730DW/ MFC-L2750DW/ MFC-L2751DW/ MFC-L2770DW/ MFC-L2771DW |
| High Yield Toner: TN-2465 (For India) TN-2485 (For Indonesia and Vietnam) TN-2456 (For Turkey) TN-2480 (For Other countries) | Approximately 3,000 pages ^{1 2} | DCP-L2531DW/ DCP-L2535DW/ DCP-L2550DW/HL-L2395DW/ MFC-L2710DW/ MFC-L2713DW/ MFC-L2715DW/ MFC-L2716DW/ MFC-L2730DW/ MFC-L2750DW/ MFC-L2751DW/ MFC-L2770DW/ MFC-L2771DW |

¹ Approximate cartridge yield is declared in accordance with ISO/IEC 19752.

² A4/Letter simplex pages

Drum Unit

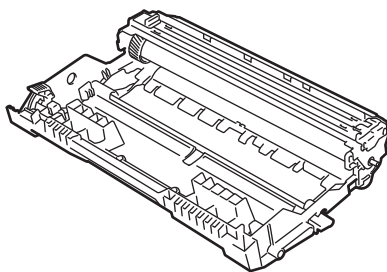

| Supply Model Name | Approximate Life (Page Yield) | Applicable Models |
|---|---|---|
| DR-2425 (For Australia) DR-2415 (For New Zealand) DR-2465 (For India) DR-2485 (For Indonesia and Vietnam) DR-2406 (For Turkey) DR-2455 (For Other countries) | Approximately 12,000 pages ¹ | DCP-L2531DW/ DCP-L2535DW/ DCP-L2550DW/ HL-L2395DW/ MFC-L2710DW/ MFC-L2713DW/ MFC-L2715DW/ MFC-L2716DW/ MFC-L2730DW/ MFC-L2750DW/ MFC-L2751DW/ |

| Supply Model Name | Approximate Life (Page Yield) | Applicable Models |
|-------------------|----------------------------------|-----------------------------|
| | | MFC-L2770DW/ MFC-L2771DW |

¹ Approximately 12,000 pages based on 1 page per job [A4/Letter simplex pages]. The number of pages may be affected due to a variety of factors including but not limited to media type and media size.



If you are using Windows[®], double-click the **Brother Creative Center** icon  on your desktop to access our **FREE** website designed as a resource to help you easily create and print customised materials for business and home use with photos, text and creativity.

Mac users can access Brother CreativeCenter at this web address:

www.brother.com/creativecenter

Print and Scan Using Your Mobile Device

Brother iPrint&Scan for Mobile allows you to use features of your Brother machine directly from your mobile device, without using a computer. The *Mobile Print/Scan Guide for Brother iPrint&Scan* contains information on printing from your mobile device. Go to your model's **Manuals** page on the Brother Solutions Center at support.brother.com to see the guide.

For Australia Only:

Support – For technical support of your Brother Product other than what you can resolve through the User's Guide, please visit our website or Solutions website (see below) to find an answer to FAQs/Troubleshooting, locating Drivers & Software.

Alternatively, please contact the Product Support Centre for any customer care/technical support enquiry.

To contact Brother International (Aust) Pty Ltd for support on a Brother product please see the details listed below:

Product Support Centre:

Australia

Brother International

(Aust) Pty Ltd

Phone: 02 8875 6000

Solutions Site: support.brother.com

Website: <http://www.brother.com.au>

Email: To submit an e-mail enquiry, visit <http://www.brother.com.au> go to Service and Support area and follow the prompts.

Our Technical Support Consultants are available 5 days a week by phone during the hours of 8.30am to 5.00pm (EST/EDST) Monday to Friday.

For New Zealand Only:

For technical support for your Brother Product please refer to this user guide and the FAQ's available on our Brother Solutions website, support.brother.com.

Drivers, software, user guides and technical references are all available on our Brother Solutions website.

If you require further assistance please contact Brother International (NZ) Limited on the following numbers

| | |
|---|--------------|
| Technical Brother Support | 0800 329 111 |
| Technical Support for those not using Genuine Consumables | 0900 552 152 |
| Fax Assistance | 0800 837 822 |

Our Technical Support Consultants are available 7 days a week by phone during the hours of 8.30am to 5pm Monday to Friday and 9am to 5pm Saturday and Sunday.

Email Assistance

Please visit <http://www.brother.co.nz> and submit a helpdesk enquiry from our Service and Support page.

Web Assistance

Please visit <http://www.brother.co.nz> under Service and Support for Frequently Asked Questions, Driver downloads, Warranty information and Service Centres.

brother

Visit us on the World Wide Web
www.brother.com

These machines are approved for use in the country of purchase only. Local Brother companies or their dealers will support only machines purchased in their own countries.



D00RY1001-01
OCE/ASA
Version A