

# User's Guide

## D800W

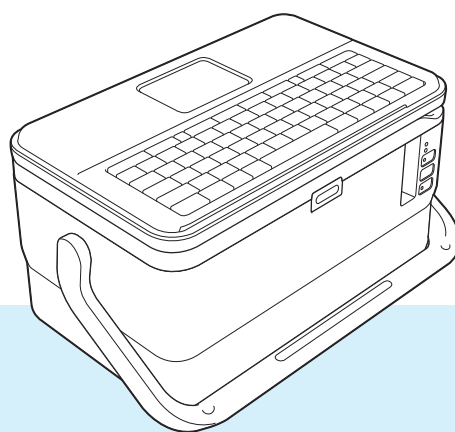

# Introduction

## Important Notice

---

- The contents of this document and the specifications of this product are subject to change without notice.
- Brother reserves the right to make changes without notice in the specifications and materials contained herein and shall not be responsible for any damages (including consequential) caused by reliance on the materials presented, including but not limited to typographical and other errors relating to the publications.
- Screen images in this document may differ depending on your computer's operating system, your product model and, the software version.
- Before using the P-touch labelling machine, make sure you read all documents included with the machine for information about safety and proper operation.
- Not all options and the consumables such as TZe tape, FLe label, and HSe tube are available in all countries.
- The available options and supplies may vary depending on the country.

## Available Manuals

---

Visit the Brother Solutions Center at [support.brother.com](http://support.brother.com) and click Manuals on your model page to download the latest manuals.

<b>Product Safety Guide</b> <sup>1</sup>	This guide provides safety information; read it before you use the machine.
<b>Quick Setup Guide</b> <sup>1</sup>	This guide provides basic information about using the machine along with troubleshooting tips.
<b>User's Guide</b> <sup>2</sup>	This guide provides additional information about the machine settings and operations, network connection and settings, troubleshooting tips, and maintenance instructions.





<sup>1</sup> Printed manual in the box

<sup>2</sup> PDF manual on the Brother Solutions Center website

## Symbols Used in This Guide

---

The following symbols are used throughout this guide:

 <b>WARNING</b>	Tells you what to do to avoid the risk of injury.
 <b>CAUTION</b>	Tells you about procedures you must follow to avoid minor personal injury or damage to the machine.
 <b>Important</b>	Indicates information or directions that should be followed. Ignoring them may result in damage, or failed operations.
 <b>Note</b>	Indicates notes that provide information or directions that can help you better understand and use the product more efficiently.

## IMPORTANT NOTE

- This product is approved for use in the country of purchase only. Do not use this product outside the country of purchase as it may violate the wireless telecommunication and power regulations of that country.
- Windows Vista® in this document represents all editions of Windows Vista®.
- Windows® 7 in this document represents all editions of Windows® 7.
- Windows® 8 in this document represents all editions of Windows® 8.
- Windows® 8.1 in this document represents all editions of Windows® 8.1.
- Windows® 10 in this document represents Windows® 10 Home, Windows® 10 Pro, Windows® 10 Enterprise, and Windows® 10 Education.  
Windows® 10 in this document does not represent Windows® 10 Mobile, Windows® 10 Mobile Enterprise, or Windows® 10 IoT Core.
- Windows Server® 2008 in this document represents all editions of Windows Server® 2008 and Windows Server® 2008 R2.
- Windows Server® 2012 in this document represents all editions of Windows Server® 2012 and Windows Server® 2012 R2.
- Not all models are available in all countries.

©2016 Brother Industries, Ltd. All rights reserved.

# Table of Contents

## Section I Basic Operations

<b>1</b>	<b>Setting Up the P-touch Labelling Machine</b>	<b>2</b>
	General Description .....	2
	Front/Back .....	2
	Inside .....	3
	Attaching the Keyboard LCD Unit.....	4
	Connecting the Power Supply .....	5
	Inserting a Tape Cassette.....	6
	Turning Power On/Off.....	7
	Feeding Tape .....	8
<b>2</b>	<b>Printing a Label Using the P-touch Labelling Machine Keyboard</b>	<b>9</b>
	Keyboard LCD Unit Description.....	9
	Key Names and Functions .....	9
	LCD .....	10
	Editing a Label.....	14
	Opening the Label Creation Screen .....	14
	Entering Text from the Keyboard.....	14
	Inserting Text.....	14
	Adding a New Line .....	14
	Deleting Text .....	15
	Using Text Reminder.....	16
	Inserting a Tab.....	17
	Adding a New Block .....	17
	Adding a New Page.....	17
	Entering Accented Characters.....	18
	Entering Symbols .....	18
	Entering a Serialised Label.....	20
	Creating a Barcode Label.....	26
	Using the Time Stamp Function .....	28
	Setting Character Attributes .....	31
	Setting Frames .....	32
	Using Auto Format Layouts.....	33
	Cable Label Type .....	34
	Printing a Label.....	40
	Feeding Tape .....	40
	Tape Cutting Options.....	40
	Label Adjustment.....	43
	Label Preview .....	44
	Printing Labels.....	45
	Mirror Printing .....	46
	Using the File Memory.....	47
	Storing a Label in the File Memory.....	47
	Opening/Printing a Stored Label File.....	48
	Deleting a Stored Label File .....	48

Registering a Program.....	49
Registering a New Program .....	49
Recalling and Using a Registered Program .....	49
Deleting a Program.....	50

### **3 Using the Data Transferred to the P-touch Labelling Machine 51**

---

Transferring Data from the Computer.....	51
Transferred Symbols .....	51
Printing the Transferred Template.....	51
When the Template has No Object to be Edited .....	51
When the Template has an Object to be Edited.....	52
When the Template is Linked to the Database and will not be Edited .....	53
Using Transferred Database Data.....	54
Searching the Database.....	56
Editing the Database .....	58
Deleting the Transferred Data .....	61
Deleting Transferred Symbols.....	61
Deleting Templates.....	61
Deleting Databases .....	61

### **4 Printing Using the Computer 62**

---

Installing the Printer Driver and Software.....	62
Connecting the Machine to a Computer.....	62
Connecting Using USB.....	62
Connecting Using Wi-Fi.....	63
Printing from a Computer.....	69
Available Applications.....	69
Printing from Your Computer.....	70
Attaching Labels .....	72

### **5 Printing Using the Mobile Device 73**

---

Installing Applications for Use with Mobile Devices.....	73
Available Applications.....	73
Connecting the machine to a Mobile Device .....	73
Turning the Wireless Function On or Off.....	75
Printing from a Mobile Device.....	76
Printing from Your Mobile Device .....	76
Using a Mobile Device to Print Templates Created on a Computer.....	78
Attaching Labels .....	79

### **6 Changing the P-touch Labelling Machine Settings 80**

---

Printer Setting Tool for Windows®.....	80
Before Using the Printer Setting Tool.....	80
Using the Printer Setting Tool for Windows®.....	81
Communication Settings for Windows®.....	83
Settings Dialog Box .....	83
Menu Bar.....	85
General Tab.....	88
Wireless LAN Tab.....	90

Wireless Direct Tab .....	94
Applying Setting Changes to Multiple Machines .....	95
Device Settings for Windows® .....	96
Settings Dialog Box .....	96
Menu Bar .....	98
Basic Tab .....	100
Label Settings Tab .....	101
Applying Setting Changes to Multiple Machines .....	102
Printer Setting Tool for Mac .....	103
Before Using the Printer Setting Tool .....	103
Using the Printer Setting Tool for Mac .....	103
Settings Dialog Box .....	104
Basic Tab .....	105
Label Settings Tab .....	106
Wireless LAN Tab .....	107
Applying Setting Changes to Multiple Machines .....	108
Changing Settings When Printing from a Mobile Device .....	109

## **7 Other Functions 110**

---

Confirming the P-touch Labelling Machines Settings .....	110
Printing Labels Distributed to Multiple Machines (Windows® only) .....	111
Distributed Printing .....	111
Printing Labels in High Resolution Mode .....	115
Printing Labels in High Speed Mode .....	116
Mass Storage Mode .....	117
Description .....	117
Using the Mass Storage Mode .....	117

## **Section II Application for Windows®**

### **8 Using P-touch Software 120**

---

Installing P-touch Software .....	120
-----------------------------------	-----

### **9 How to Use Cable Label Tool 121**

---

Starting Cable Label Tool .....	121
Creating a Cable Label .....	122
Faceplate .....	122
Cable Wrap .....	123
Cable Flag .....	124
Patch Panel .....	125
Punch-Down Block .....	125
Die-cut Flag .....	126
Heat Shrink Tube .....	126
Linking a Database .....	127
Numbering Function (Serialised Number) Printing .....	128
Printing with Cable Label Tool .....	128
Transferring Templates from Cable Label Tool to the P-touch Labelling Machine .....	129

<b>10</b>	<b>How to Use P-touch Editor</b>	<b>130</b>
	Starting P-touch Editor.....	130
	Printing with P-touch Editor .....	132
	Express mode.....	132
	Professional mode.....	132
	Snap mode .....	133
	Transferring Data to the P-touch Labelling Machine .....	133
<b>11</b>	<b>How to Use P-touch Transfer Manager</b>	<b>134</b>
	Transferring the Template to P-touch Transfer Manager .....	134
	Transferring Templates or Other Data from the Computer to the Machine .....	137
	Backing up Templates or Other Data Saved in the Machine.....	142
	Deleting All the Machine Data .....	143
	Creating a BLF File .....	144
<b>12</b>	<b>How to Use P-touch Library</b>	<b>145</b>
	Starting P-touch Library .....	145
	Opening and Editing Templates .....	147
	Printing Templates.....	148
	Searching for Templates.....	149
<b>13</b>	<b>Transferring Templates with P-touch Transfer Express</b>	<b>151</b>
	Preparing P-touch Transfer Express .....	151
	Transferring the Template to P-touch Transfer Manager .....	152
	Saving the Template as a Transfer Package File (.pdz).....	153
	Distributing the Transfer Package File (.pdz) and P-touch Transfer Express to the User .....	155
	Transferring the Transfer Package File (.pdz) to Your Machine.....	156
<b>14</b>	<b>How to Update P-touch Software</b>	<b>159</b>
	Updating Cable Label Tool and P-touch Editor .....	159
	Updating the Firmware .....	161

## Section III Application for Mac

<b>15</b>	<b>Using P-touch Software</b>	<b>165</b>
	Installing P-touch Software .....	165
<b>16</b>	<b>How to Use P-touch Editor</b>	<b>166</b>
	Starting P-touch Editor.....	166
	Operation modes .....	167
	Standard Mode .....	167
	Snap mode .....	168
	Transferring Data to the Machine .....	168

---

**17 How to Update P-touch Software 169**

---

Updating P-touch Editor.....	169
Updating the Firmware .....	171

## Section IV Wireless Network

---

**18 Introduction 174**

---

Network Features .....	174
------------------------	-----

---

**19 Changing Your P-touch Labelling Machine Network Settings 175**

---

Changing Your Machine's Network Settings (IP Address, Subnet Mask and Gateway) Using Windows® .....	175
Using the BRAdmin Light Utility.....	175
Other Management Utilities .....	177
Using Web Based Management (Web Browser).....	177
Using the BRAdmin Professional Utility (Windows® Only) .....	177

---

**20 Web Based Management 178**

---

Overview.....	178
Configuring the Machine Settings Using Web Based Management (Web Browser) .....	179

## Section V Appendix

---

**21 Resetting the P-touch Labelling Machine 181**

---

Resetting All Settings to the Factory Settings Using the Machine Buttons.....	181
Resetting Data Using the Settings in the Home screen.....	182
Resetting Data Using the Printer Setting Tool .....	182

---

**22 Maintenance 183**

---

Cleaning the Unit .....	183
Cleaning the Print Head.....	183
Cleaning the Label Roller .....	184
Cleaning the Tape Cutter Unit .....	184
Cleaning the FLe Sensor .....	185
Replacing the Coin Cell Battery.....	185

---

**23 Useful Settings 188**

---

Auto Power-Off Time .....	188
Adjusting the LCD Settings .....	189
LCD Contrast.....	189
Backlight.....	189
Setting Language and Unit .....	190
Language.....	190

	Setting Unit.....	190
<b>24</b>	<b>Using the Rechargeable Li-ion Battery/Battery Base (Optional: PA-BT-4000LI/PA-BB-003)</b>	<b>191</b>
	Installing the Rechargeable Li-ion Battery.....	191
	Removing the Rechargeable Li-ion Battery.....	192
	Charging the Rechargeable Li-ion Battery.....	192
	Stopping Rechargeable Li-ion Battery Charging.....	193
	Notes on Using the Rechargeable Li-ion Battery.....	193
	Rechargeable Li-ion Battery Characteristics.....	193
	Product Specifications.....	194
<b>25</b>	<b>Troubleshooting</b>	<b>195</b>
	Overview.....	195
	LCD Problems.....	196
	Printing Problems.....	196
	Version Information.....	199
	Network Setup Problems.....	200
	Machine Cannot Print over the Network	
	Machine Is Not Found on the Network Even after Successful Installation.....	201
	Security Software Problems.....	201
	Checking the Operation of Network Devices.....	202
	Error Messages.....	203
	LED Indicators.....	204
	Indicator Warnings.....	207
<b>26</b>	<b>Product Specifications</b>	<b>208</b>
	P-touch Labelling Machines Specifications.....	208
	Operating Environment.....	210
<b>27</b>	<b>Notes on Using P-touch Transfer Manager</b>	<b>211</b>
	Notes on Creating Templates.....	211
	Notes on Transferring Templates.....	211
	Notes on Transferring Data Other Than Templates.....	212
<b>28</b>	<b>Network Terms and Information</b>	<b>213</b>
	Supported Protocols and Security Features.....	213
	Types of Network Connections and Protocols.....	214
	Types of Network Connections.....	214
	Configuring Your Machine for a Network.....	216
	IP Addresses, Subnet Masks and Gateways.....	216
	Wireless Network Terms and Concepts.....	218
	Security Terms.....	218
<b>29</b>	<b>Symbols/Characters/Styles</b>	<b>223</b>
	Symbols.....	223
	Accented Characters.....	225

Character Attribute.....226

Frames.....229

Auto Format.....231

    Template.....231

    Block Layout.....234

Barcodes.....236

    Barcode Settings Table.....236

    Special Character List.....236

Time & Date.....238

    Time & Date Format Options Table.....238



# Basic Operations

---

<b>Setting Up the P-touch Labelling Machine</b>	<b>2</b>
<b>Printing a Label Using the P-touch Labelling Machine Keyboard</b>	<b>9</b>
<b>Using the Data Transferred to the P-touch Labelling Machine</b>	<b>51</b>
<b>Printing Using the Computer</b>	<b>62</b>
<b>Printing Using the Mobile Device</b>	<b>73</b>
<b>Changing the P-touch Labelling Machine Settings</b>	<b>80</b>
<b>Other Functions</b>	<b>110</b>

# 1

# Setting Up the P-touch Labelling Machine

1

## General Description



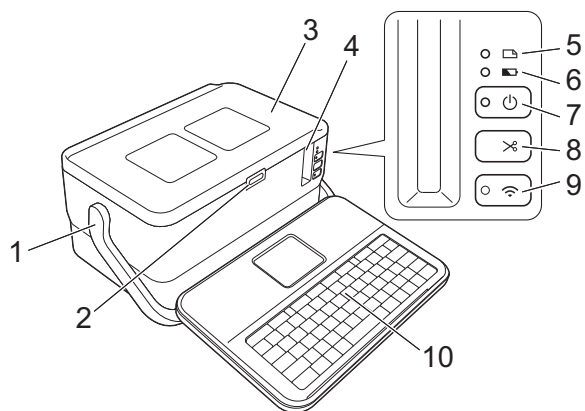

### Front/Back

#### ■ Front

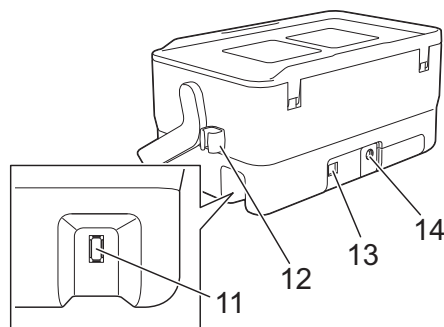

#### ■ Back



- 1 Handle
- 2 Cover open button
- 3 Top cover
- 4 Tape exit slot
- 5  (Label) indicator
- 6  (Battery) indicator
- 7  (Power) button
- 8  (Feed and Cut) button
- 9  (Wi-Fi) button
- 10 Keyboard LCD unit
- 11 Keyboard LCD unit interface socket

**12 Cable holder (holder for the keyboard LCD unit cable)**

**13 USB port**

**14 AC adapter socket**

## Inside

---

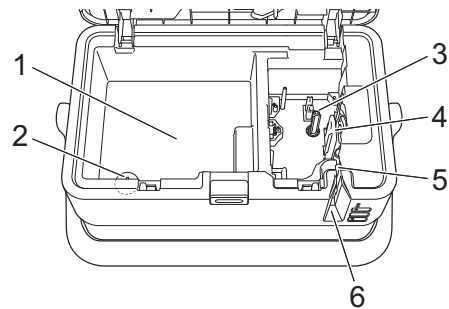

**1 Accessory storage compartment**

Use this space to store TZe tape cassettes and the AC adapter.

**2 Coin cell battery holder**

**3 Tape cassette compartment**

**4 Print head**

**5 Tape cutter unit**

**6 Tape exit slot**

## Attaching the Keyboard LCD Unit

1

- 1 Slide the cover on the bottom of the keyboard LCD unit to remove it, and then connect the keyboard LCD unit cable. Install the cover.

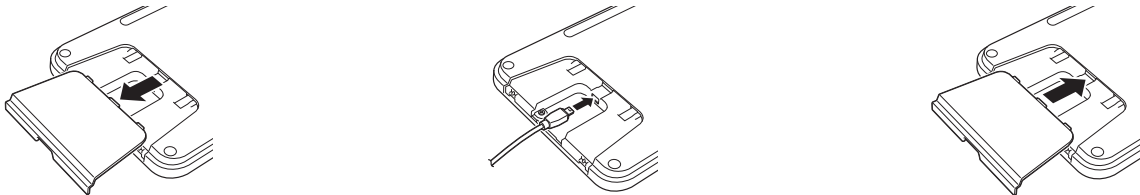

- 2 Connect the USB cable on the keyboard LCD unit to the socket on the side of the machine.

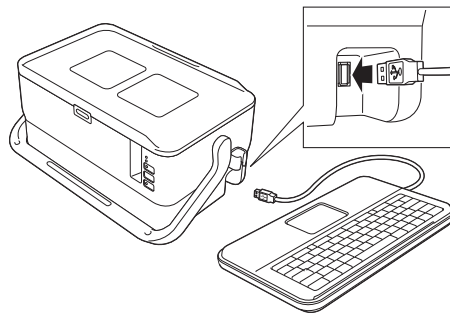

### Note

- When you turn the machine on, the keyboard LCD unit is also turned on.
- The keyboard LCD unit can be installed on the machine by sliding it on the top cover.  
When storing the keyboard LCD unit, turn it upside down and install it to the top cover to prevent it from becoming dusty or dirty.
- You can place the excess cable in the cable holder.

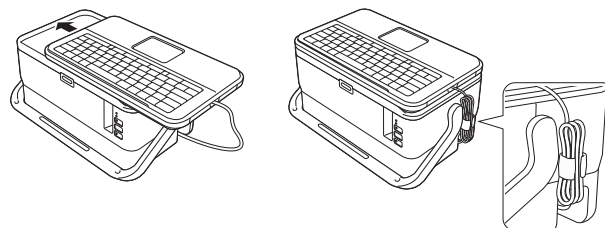

## Connecting the Power Supply

Use the AD9100ESA (AC adapter) for this machine. Connect the AC adapter directly to the machine.

- 1 Insert the plug on the AC adapter cord into the AC adapter socket marked DC IN 24 V on the machine.
- 2 Insert the plug on the power supply cord into the AC adapter.

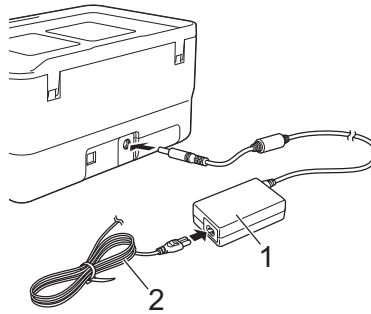

- 1 AC adapter
- 2 Power supply cord

- 3 Insert the power supply plug into a standard electrical socket.

### ! Important

- Turn the machine off before disconnecting the AC adapter.
- Do not pull or bend the AC adapter cord and power supply cord.
- After the power supply plug is inserted into the electrical socket, it may take a few seconds until the  (Power) button is enabled.

### Note

To safeguard and back up the machine memory, when the power supply is unplugged it is recommended to leave the rechargeable Li-ion batteries (optional: PA-BT-4000LI) installed in the machine.

## Inserting a Tape Cassette

The TZe tape, FLe label, and HSe tube cassettes can be used in your machine.

### ! Important

If the new tape cassette has a cardboard stopper, be sure to remove the stopper before inserting the cassette.

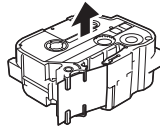

- 1 Check that the end of the tape is not bent and that it passes through the tape guide. If it does not, pass it through the tape guide as shown in the illustration.

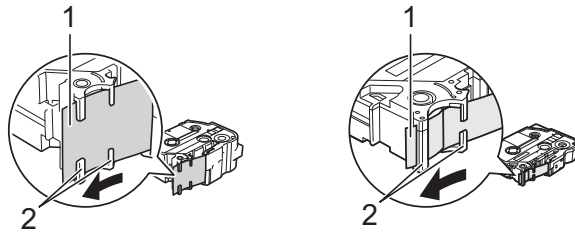

1 End of tape

2 Tape guides (The actual shape may be different depending on the tape width.)

- 2 Press the cover open button to open the top cover.
- 3 Carefully insert the tape cassette into the tape cassette compartment with the end of the tape facing the machine tape exit slot, then push down evenly until the tape cassette is installed correctly.

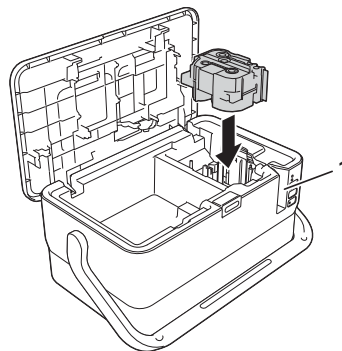

1 Tape exit slot

### ! Important

- When inserting the tape cassette, make sure that the tape and ink ribbon do not catch on the print head.

- Make sure that there is no slack in the tape. Otherwise the tape may catch on the protrusion (2) and become bent or wrinkled, causing the tape to jam. To fix the slack in the tape, refer to the illustration in step ① and pull the tape outside of the tape guide.
- When removing the tape cassette, make sure that the tape does not catch on the protrusion (2).

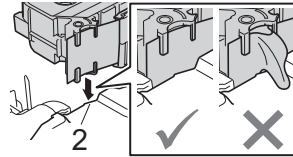



④ Close the top cover.

**! Important**



Store tape cassettes in a cool dark location, away from direct sunlight and high temperature, high humidity, or dusty locations. After opening the sealed package, use the tape cassette as quickly as possible.

## Turning Power On/Off

**On:** Press the  (Power) button to turn the machine on. The  (Power) indicator lights in green.

 **Note**

When the machine is turned on for the first time, the language selection screen appears. Select the language you want using the  $\uparrow$  or  $\downarrow$  key. The language setting can also be changed later. (See *Setting Language and Unit* on page 190.)

**Off:** Press and hold the  (Power) button again to turn the machine off. The  (Power) indicator may light in orange until the power is off.

**! Important**

When turning the machine off, do NOT remove the battery or disconnect the AC adapter until the  (Power) indicator turns off.

## Feeding Tape

### Important

- Be sure to feed tape to remove any slack in the tape and ink ribbon after inserting the tape cassette.
- **Do not pull the label when the machine is ejecting it from the tape exit slot.** Doing so will cause the ink ribbon to be discharged with the tape. The tape may no longer be functional after the ink ribbon discharges.
- Do not block the tape exit slot during printing or when feeding tape. Doing so will cause the tape to jam.

### Feed and Cut

The Feed and Cut function feeds approximately 22.3 mm of blank tape, and then cuts the tape.

- 1 Press the  (Feed and Cut) button.  
[Feed & Cut?] appears on the LCD.
- 2 Select [Feed & Cut] using the  $\uparrow$  or  $\downarrow$  key, and then press the **OK** or **Enter** key. The message [Feeding Tape... Please Wait] appears while the tape is fed, and then the tape is cut.



### Note

To exit or cancel this function press the **Esc** key.

### Feed Only

This function ejects the tape approximately 22.3 mm, resulting in a blank label sticking out of the tape cassette. This action is recommended when using Fabric tapes, which should be cut with scissors.

- 1 Press the  (Feed and Cut) button.  
[Feed & Cut?] appears on the LCD.
- 2 Select [Feed Only] using the  $\uparrow$  or  $\downarrow$  key, and then press the **OK** or **Enter** key. The message [Feeding Tape... Please Wait] appears while the tape is fed.



### Note

To exit or cancel this function press the **Esc** key.

# 2

## Printing a Label Using the P-touch Labelling Machine Keyboard

### Keyboard LCD Unit Description

#### Key Names and Functions

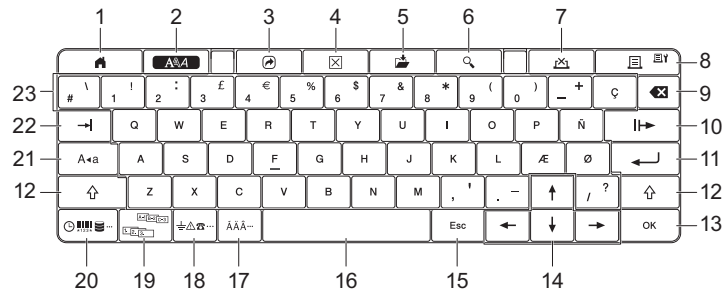

#### 1 Home

Returns to the Home screen to select a menu.

#### 2 Format

Sets characters and attributes.

#### 3 Program

Opens a registered program

#### 4 Clear

Clears all text entered, or all text and current settings.

#### 5 Save

Saves the created data in the file memory.

#### 6 Preview

Displays an image of the label that will be printed in the set layout.

#### 7 Cancel

Deletes the print job.

#### 8 Print/Print Options

- Prints the current data onto the tape.
- Prints multiple copies or changes the print settings when used in combination with the **Shift** key.

#### 9 Backspace

Deletes the character to the left of the cursor.

#### 10 Next

Creates the next page.

#### 11 Enter

Adds a new line when entering text.  
Selects the displayed option.

**12 Shift**

Enters upper-case letters or symbols when used in combination with the letter keys or number keys.

**13 OK**

Selects the displayed option.

**14 Cursor (↑ ↓ ← →)**

Moves the cursor in the direction of the arrow.

**15 Esc (Escape)**

Cancels the current command and returns the display to the data entry screen or the previous step.

**16 Space**

- Inserts a blank space.
- Returns a setting to the default value.

**17 Accent**

Selects and enters an accented character.

**18 Symbol**

Selects and enters a symbol from a list of available symbols.

**19 Serialize**

Sets serialised numbers.

**20 Insert**

Inserts a time stamp, barcode, database, or transferred symbol.

**21 Caps**

Turns the Caps mode on and off.

**22 Tab**

Inserts a tab.

**23 Letter**

- Enters letters or numbers.
- Enters upper-case letters or symbols when used in combination with the **Caps** or **Shift** key.

**LCD**

■ **Home Screen**

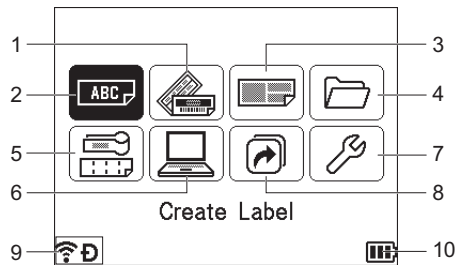

**1 Auto Format (Templates)**

Specifies the label format from the preset templates.

**2 Create Label**

Displays the label creation screen.

**3 Auto Format (Block Layouts)**

Specifies the label format from the preset layouts.

**4 File**

Retrieves data that is saved in the file memory.

**5 Cable Label**

Specifies the label type from the following seven types: Faceplate/Cable Wrap/Cable Flag/Patch Panel/Punch-Down Block/Die-cut Flag/Inverted Label.

**6 Transferred Templates**

Retrieves data that was transferred from a computer.

**7 Settings**

Specifies various settings for the machine.

**8 Register Programmable Function**

Registers, deletes, and renames programs.

**9 Wireless Connection**

The left icon indicates the status of the Wi-Fi® connection and the right icon indicates the status of the Wireless Direct connection.

	Connected in Wi-Fi mode
	Disconnected in Wi-Fi mode
	Wireless direct mode ON
 (Blinking)	Connecting using the Setup Wizard
 (Off)	Wireless connection OFF

**10 Battery Level**

Indicates the remaining battery level. It appears only when using the Li-ion battery.

- Full      - Low      - Charging
- Half      - Empty

## ■ Label Creation Screen

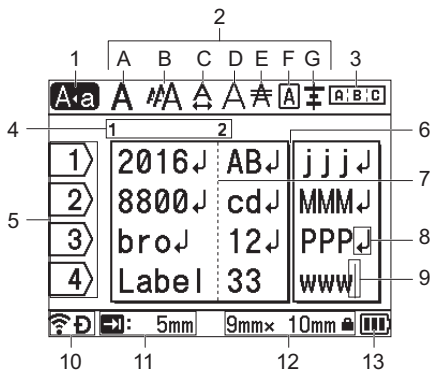

### 1 Caps mode

Indicates that the Caps mode is on.

### 2 Style Guidance

Indicates the current font (A), character size (B), character width (C), character style (D), line (E), frame (F), and alignment (G) settings.

### 3 Layout Guidance

Indicates the orientation, layout, separator, reverse, and repeated text settings. The displayed items vary according to the selected label type.

### 4 Block Number

Indicates the block number.

### 5 Line Number

Indicates the line number within the label layout.

### 6 Page Separator Line

Indicates the end of one page and the beginning of the next page.

### 7 Block Separator Line

Indicates the end of a block.

### 8 Enter/Return Symbol

Indicates the end of a line of text.

### 9 Cursor

Indicates the current data input position. Characters are entered to the left of the cursor.

### 10 Wireless Connection

Indicates the current status of the wireless connection. See *Wireless Connection* in the Home Screen section.

### 11 Tab Length Setting

Indicates the set tab length.

### 12 Tape Size

Indicates the tape size as follows for the text entered: Tape width × Label length. If the label length has been specified,  also appears on the right side of the tape size.

### **13 Battery Level**

Indicates the remaining battery level. It appears only when using the Li-ion battery. See *Battery Level* in the Home Screen section.

## Editing a Label

This chapter explains how to enter text and symbols in labels to create original labels and how to create labels using previously created templates.

### Opening the Label Creation Screen

---

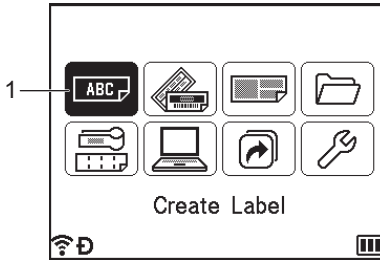

#### 1 Create Label

The labels are created using the label creation screen. To open the label creation screen, select [Create Label] in the Home screen using the **↑**, **↓**, **←** or **→** key, and then press the **OK** or **Enter** key.

### Entering Text from the Keyboard

---

You can use your machine's keyboard in the same way as a standard computer keyboard.

### Inserting Text

---

To insert additional text into an existing line of text, move the cursor to the character at the position where you want to start inserting text, and then enter the additional text. The new text is inserted at the position of the cursor.

### Adding a New Line

---

A return mark appears at the end of the line and the cursor moves to the start of the new line.

**!** Important

- Maximum number of lines (Labels)
  - 36 mm tape: 17 lines
  - 24 mm tape: 13 lines
  - 18 mm tape: 10 lines
  - 12 mm tape: 6 lines
  - 9 mm tape: 4 lines
  - 6 mm tape: 3 lines
  - 3.5 mm tape: 1 line
- Maximum number of lines (Heat shrink tubes)
  - 23.6 mm tape: 12 lines
  - 17.7 mm tape: 10 lines
  - 11.7 mm tape: 6 lines
  - 8.8 mm tape: 4 lines
  - 5.8 mm tape: 2 lines

## Deleting Text

### Deleting One Character at a Time

To delete a character from an existing line of text, move the cursor to the character at the right of the position where you want to start deleting text, and then press the **Backspace** key. The character to the left of the cursor is deleted each time the **Backspace** key is pressed.



**Note**

If you press and hold the **Backspace** key, the characters to the left of the cursor are continuously deleted.

### Deleting All Text at Once

Use the **Clear** key to delete all text at once.

- 1 Press the **Clear** key.  
The Clear options appear.

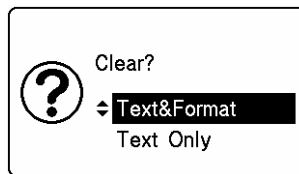

- 2 Using the ↑ or ↓ key, select [Text Only] to delete all text while retaining the current format settings, or select [Text&Format] to delete all text and format settings.

 **Note**

- Press the **Esc** key to return to the label creation screen without erasing (or clearing) the text or the format settings.
- When [Text&Format] is selected, all text is cleared and the character attribute and cutting option settings are reset to the factory settings.

- 3 Press the **OK** or **Enter** key.  
All text is deleted. If you have selected [Text&Format], all format settings are also deleted.

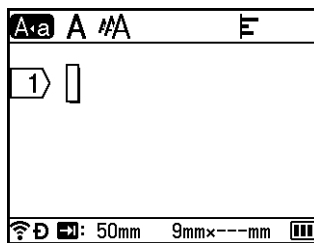

## Using Text Reminder

When you enter a character, the machine retrieves all character sequences beginning with that character from a history of all printed character sequences to date, and displays those character sequences as a list of options that you can select.

For example, if you enter "B", a mark appears on the screen if there is a character sequence beginning with "B" in the history. If you press the **OK** key, the machine displays a list of words beginning with the letter "B", such as "Brother". Select the word you want using the ↑ or ↓ key, and then press the **OK** or **Enter** key to insert the selected word on the text line.

The factory setting is "On".

 **Note**

- To close the list of words, press the **Esc** key.
- To display the entire word, press the → key, and to return to the list of words, press the ← key.
- To delete the text reminder memory, select [Settings] - [Text Reminder] - [Clear Memory] in the Home screen, and then press the **OK** or **Enter** key.
- To change the text reminder setting, select [Settings] - [Text Reminder] - [On/Off] in the Home screen, and then press the **OK** or **Enter** key.
- The memory can store up to 99 words.

## Inserting a Tab

---

To insert a tab into an existing line of text, move the cursor to the character at the position where you want to insert a tab, and then press the **Tab** key.

The inserted tab appears as a mark (▬) in the label creation screen.



### Note

---

To delete a tab from a label, position the cursor to the right of the tab mark on the label creation screen, and then press the **Backspace** key.

---

## Changing the Tab Length

- 1 Press the **Format** key.
- 2 Select [Tab Length] using the ← or → key.
- 3 Select the tab length you want using the ↑ or ↓ key, and then press the **OK** or **Enter** key.



### Note

---

- To return to the label creation screen, press the **Esc** key.
  - You can also set the tab length by typing in the tab length you want. To apply the setting, after typing in the tab length, press the **OK** or **Enter** key, and then press the **OK** or **Enter** key again.
  - The tab length can be set to between 0 mm and 100 mm.
- 

## Adding a New Block

---

You can create up to 99 new blocks. To create a new block of text and lines, press the **Shift** and **Enter** keys. The text to the right of the cursor will be moved to the new block. In some label types, you can set the number of blocks when selecting the label type.

## Adding a New Page

---

You can press the **Next** key to create a new page. The cursor moves to the start of the new page. You can create up to 99 new pages.

## Entering Accented Characters

The machine can display and print a set of accented characters, such as other language-specific characters. Selectable “Accented Characters” are listed in the Appendix. (See *Accented Characters* on page 225.)

- 1 Enter the character you want to change to an accented character.



### Note

Caps mode can be used with the accent function.

- 2 Press the **Accent** key.  
The selectable accented characters appear on the screen.
- 3 Select the accented character you want using the **↑** or **↓** key, and then press the **OK** or **Enter** key.  
The character you entered will change to the selected accented character.



### Important

The order of accented characters displayed will differ depending on the selected LCD language.



### Note

To return to the previous step, press the **Esc** key.

## Entering Symbols

In addition to the symbols available on the keyboard, there are various symbols (including international, extended ASCII characters and transferred symbols <sup>1</sup>) available with the symbol function.

To enter a symbol, use the symbol function (see *Entering Symbols Using the Symbol Function* on page 18).

Alternatively, press the **Shift** key and a key on the keyboard simultaneously to enter the symbol printed on the selected key's upper-right corner.

<sup>1</sup> A bitmap image of a user-created character that is not supplied with the machine.

## Entering Symbols Using the Symbol Function

Selectable symbols (excluding transferred symbols) are listed in the Appendix. (See *Symbols* on page 223.)

- 1 Press the **Symbol** key.  
A list of symbol categories and symbols in that category appears.



### Note

The last symbol entered is selected in the displayed list.

- 2 Select a symbol category using the **↑** or **↓** key, and then press the **OK** or **Enter** key.
- 3 Select a symbol using the **↑**, **↓**, **←** or **→** key, and then press the **OK** or **Enter** key.  
The selected symbol is inserted into the line of text.



**Note**

When selecting a symbol:

- To return to the previous page, press the **Shift** key and **Symbol** key.
- To go to the next page, press the **Symbol** key.
- To return to the previous step, press the **Esc** key.

## Entering Transferred Symbols



**Important**

Before using transferred symbols, transfer the images to the machine using P-touch Transfer Manager. For more information about using P-touch Transfer Manager, see *How to Use P-touch Transfer Manager* on page 134.



1 Press the **Insert** key.



2 Select [Transferred Symbols] using the ↑ or ↓ key, and then press the **OK** or **Enter** key.



3 Select a transferred symbol using the ↑ or ↓ key, and then press the **OK** or **Enter** key.  
The selected image is inserted into the line of text.



**Note**

- When selecting a symbol, press the **Shift** key and ↓ key to go to the next page, and press the **Shift** key and ↑ key to go to the previous page.
- The inserted transferred symbol appears as a mark (📎) in the label creation screen.
- To view the transferred symbol in the label creation screen, move the cursor to the mark (📎) and press the **Insert** key.
- To return to the previous step, press the **Esc** key.

## Using Symbol History

You can create your personal category of symbols using [Symbol History]. [History] appears first when selecting the symbols to help you locate the symbols you want quickly.



**Important**

Transferred symbols cannot be added to [Symbol History].



1 Select [Settings] in the Home screen using the ↑, ↓, ← or → key, and then press the **OK** or **Enter** key.



2 Select [Symbol History] using the ↑ or ↓ key, and press the **OK** or **Enter** key.



3 Select [On] to create your personal category using the ↑ or ↓ key, and then press the **OK** or **Enter** key.

- 4 In the label creation screen, enter the symbol you want to add to your history by pressing the **Symbol** key, selecting a symbol category using the ↑ or ↓ key, pressing the **OK** or **Enter** key, selecting a symbol using the ↑, ↓, ← or → key, and then pressing the **OK** or **Enter** key.
- 5 Press the **Symbol** key.  
[History] appears, including the symbol entered in step 4.

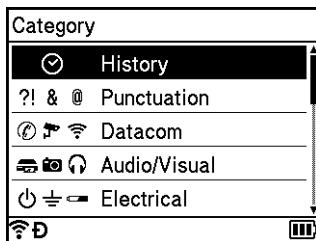

**Note**

- Up to 30 symbols can be added to [History]. The oldest symbol will be deleted from the category when the symbols added to [History] exceed 30 symbols.
- To stop using [Symbol History], follow steps 1 and 2 above, and then select [Off] in the [Symbol History] screen in step 3.

## Entering a Serialised Label



Numerically serialised labels can be created. You can set the increment and count for the series. In the serialize mode, you can create a series of labels by incrementing one numeric character in the pattern. In the advanced serialize mode, you can select between Simultaneous or Group. Simultaneous mode creates a series of labels by incrementing two different numbers at the same time. Group mode creates a series of labels by allowing you to select two sequences in the pattern and increment them consecutively.

### Serialize Mode

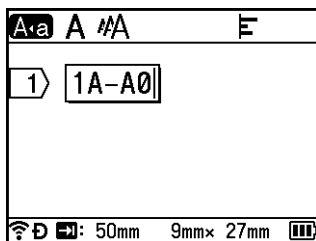
- 1 Enter the text except the text that you want to serialise.  
**Example:** To create labels 1A-A01, 1A-A02, 1A-A03, and 1A-A04, enter only "1A-A0".



- 2 Position the cursor where you want to insert serialised text, and then press the **Serialize** key.

Serialize	2/4
Type	◀ Normal ▶
Format	: 000-999
From	: 1
To	: 1
Increasedby	: 1
 	

- 3 Select [Type], [Format], [From], [To] and [Increased by] using the ↑ or ↓ key, and set the values using the ← or → key.



**Note**

You can also set [From], [To] and [Increased by] by typing in the numbers you want.

**Example:** [Type]: Normal, [Format]: 000-999, [From]: 1, [To]: 4, and [Increased by]: 1  
 See the following Serialise Settings table (factory settings are shown in bold):

Attribute		Value	Description
Type		<b>Normal</b> , Octal, Hex, Alphabet	Specifies the format of the serialised number from decimal, octal, hexadecimal, and alphabetic.
Format	Normal	<b>000-999</b> , __0-999, 0-999	Specifies how the digits of the serialised numbers are aligned. ■ 000-***: Zeroes are used to align the digits. ■ __0-***: Blank spaces are used to align the digits. ■ 0-***: The digits are not aligned.
	Octal	<b>000-777</b> , __0-777, 0-777	
	Hex	<b>000-FFF</b> , __0-FFF, 0-FFF	
	Alphabet	<b>a-z</b> , A-Z	
From	Normal	000-999	Specifies the starting text for the serialised numbers.
	Octal	000-777	
	Hex	000-FFF	
	Alphabet	a-z, A-Z	
To	Normal	000-999	Specifies the ending text for the serialised numbers.
	Octal	000-777	
	Hex	000-FFF	
	Alphabet	a-z, A-Z	
Increased by		1-9	Specifies the increment for increasing the serialised numbers.

4 Press the **OK** or **Enter** key to display an image of the labels on the screen.

**Example:** 1A-A01 1A-A02 1A-A03 1A-A04

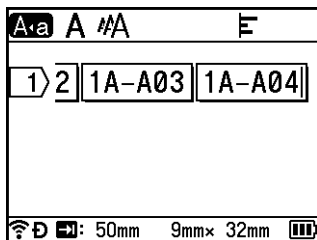

**Note**

- Although the machine creates multiple pages of labels after you complete the serialise settings, you can select the pages and print only the pages you want. See *Printing a Range of Pages* on page 46.
- When you want to print multiple copies of the serialised labels, you can select [Serialize] or [Copy] for the printing order in [Settings] - [Print Order] in the Home screen.
- When creating labels with a serialised barcode, select the entered barcode, and then press the **Serialize** key. For more information about barcodes, see *Creating a Barcode Label* on page 26.
- To return to the previous step, press the **Esc** key.

### Advanced Serialize Mode

#### Simultaneous

1 Enter the text except the text that you want to serialise.  
**Example:** To create labels 1A-A01, 1A-B02, 1A-C03, and 1A-D04, enter only "1A-0".

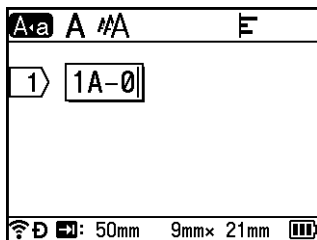

2 Position the cursor where you want to insert the first serialised text (to the right of "0"), and then press the **Shift** and **Serialize** keys. Select [Simultaneous] using the **↑** or **↓** key, and then press the **OK** or **Enter** key.

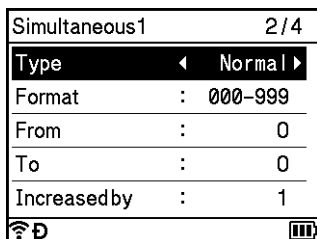

- For the first serialised text, select [Type], [Format], [From], [To] and [Increased by] using the ↑ or ↓ key, set the values using the ← or → key, and then press the **OK** or **Enter** key.



**Note**

You can also set [From], [To] and [Increased by] by typing in the numbers you want.

**Example:** [Type]: Normal, [Format]: 000-999, [From]: 1, [To]: 4, and [Increased by]: 1  
See the Serialize Settings table in step 3 of *Serialize Mode* for more information.

- Position the cursor where you want to insert the second serialised text (to the left of "0"), and then press the **OK** or **Enter** key.

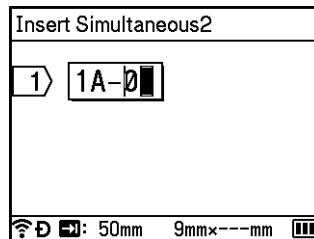

- For the second serialised text, select [Type], [Format], [From], and [Increased by] using the ↑ or ↓ key, set the values using the ← or → key, and then press the **OK** or **Enter** key.

**Example:** [Type]: Alphabet, [Format]: A-Z, [From]: A, and [Increased by]: 1  
See the Serialize Settings table in step 3 of *Serialize Mode* for more information.



**Note**

Because the serialised number count is the same for the first serialised text and second serialised text, the value for [To] is set automatically.

- Press the **OK** or **Enter** key to display an image of the labels on the screen.

**Example:** 1A-A01 1A-B02 1A-C03 1A-D04

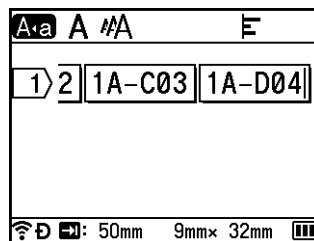

**Note**

- Although the machine creates multiple pages of labels after you complete the serialise settings, you can select the pages and print only the pages you want. See *Printing a Range of Pages* on page 46.
- When you want to print multiple copies of the serialised labels, you can select [Serialize] or [Copy] for the printing order in [Settings] - [Print Order] in the Home screen.
- When creating labels with a serialised barcode, select the entered barcode, and then press the **Serialize** key. For more information about barcodes, see *Creating a Barcode Label* on page 26.
- To return to the previous step, press the **Esc** key.

### Group

- 1 Enter the text except the text that you want to serialise.  
**Example:** To create labels 1A-A01, 1A-A02, 1A-A03, 1A-A04, 1A-B01, 1A-B02, 1A-B03 and 1A-B04, enter only "1A-0".

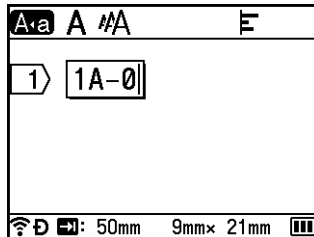

- 2 Position the cursor where you want to insert the first serialised text (to the right of "0"), and then press the **Shift** and **Serialize** keys. Select [Group] using the ↑ or ↓ key, and then press the **OK** or **Enter** key.

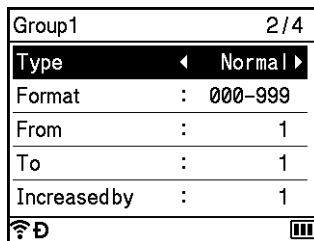

- 3 For the first serialised text, select [Type], [Format], [From], [To] and [Increased by] using the ↑ or ↓ key, set the values using the ← or → key, and then press the **OK** or **Enter** key.  
**Example:** [Type]: Normal, [Format]: 000-999, [From]: 1, [To]: 4, and [Increased by]: 1  
 See the Serialise Settings table in step 3 of *Serialize Mode* for more information.

- 4 Position the cursor where you want to insert the second serialised text (to the left of "0"), and then press the **OK** or **Enter** key.

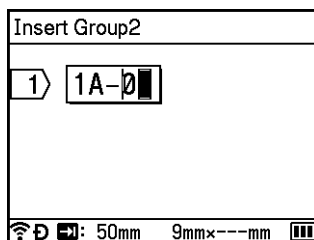

- 5 For the second serialised text, select [Type], [Format], [From], [To] and [Increased by] using the ↑ or ↓ key, set the values using the ← or → key, and then press the **OK** or **Enter** key.  
**Example:** [Type]: Alphabet, [Format]: A-Z, [From]: A, [To]: B, and [Increased by]: 1  
 See the Serialise Settings table in step 3 of *Serialize Mode* for more information.

6 Press the **OK** or **Enter** key to display an image of the labels on the screen.

**Example:**

1A-A01	1A-A02	1A-A03	1A-A04
1A-B01	1A-B02	1A-B03	1A-B04

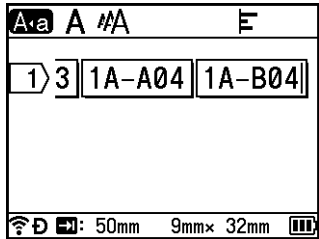

**Note**

- Although the machine creates multiple pages of labels after you complete the serialise settings, you can select the pages and print only the pages you want. See *Printing a Range of Pages* on page 46.
- When you want to print multiple copies of the serialised labels, you can select [Serialize] or [Copy] for the printing order in [Settings] - [Print Order] in the Home screen.
- When creating labels with a serialised barcode, select the entered barcode, and then press the **Serialize** key. For more information about barcodes, see *Creating a Barcode Label* on page 26.
- To return to the previous step, press the **Esc** key.

**Note**

Letters and numbers increase as shown below:

0 → 1 → 2 → 3... → 999 → 000 → 001 → 002 → 003...

A → B → C → D... → Z → A → B → C → D...

a → b → c → d... → z → a → b → c → d...

## Creating a Barcode Label

You can use the barcode function to create labels with one dimensional barcodes for use with asset control tags, serialised number labels, and even POS and stock control systems.

Selectable “Barcodes” are listed in the Appendix. See *Barcodes* on page 236.



### Note

- The machine is not designed exclusively for creating barcode labels. Always check that barcode labels can be read by the barcode reader.
- For best results, print barcode labels in black ink on white tape. Some barcode readers may not be able to read barcode labels created using coloured tape or ink.
- Use the [Large] setting for [width] whenever possible. Some barcode readers may not be able to read barcode labels created using the [Small] setting.
- Continuously printing a large number of labels with barcodes can overheat the print head, which may affect printing quality.

## Setting Barcode Parameters and Entering Barcode Data



Press the **Insert** key.



Select [Bar Code] using the ↑ or ↓ key, and then press the **OK** or **Enter** key.  
The [Bar Code] screen appears.



### Note

Up to five barcodes can be entered on a label.



Select an attribute using the ↑ or ↓ key, and then select the setting for that attribute using the ← or → key. (Factory settings are shown in bold.)

- Protocol: **CODE39**, CODE128, EAN-8, EAN-13, GS1-128 (UCC/EAN-128), UPC-A, UPC-E, I-2/5 (ITF), CODABAR
- Width: **Small**, Large
- Under#: **On**, Off
- C.Digit: **Off**, On

The check digit is available only for CODE39, I-2/5 and CODABAR protocols.



### Note

Characters may not appear below the barcode even when [On] is selected for [Under#] depending on the width of the tape being used, the number of lines entered, or the current character style settings.



Press the **OK** or **Enter** key to apply the settings.



### Note

New settings are NOT applied unless you press the **OK** or **Enter** key.

- 5 Type in the barcode data.  
You can enter special characters in the barcode when using the CODE39, CODE128, CODABAR or GS1-128 protocols. When not using special characters, go to step 8.

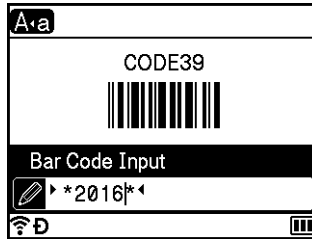

- 6 Press the **Symbol** key.  
A list of characters available for the current protocol appears.
- 7 Select a character using the ↑ or ↓ key, and then press the **OK** or **Enter** key to insert the character in the barcode data.

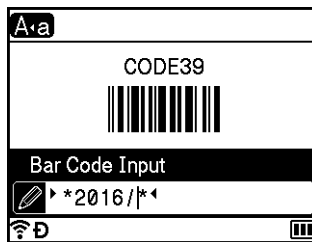

- 8 Press the **OK** or **Enter** key to insert the barcode in the label.  
The barcode appears on the label creation screen.

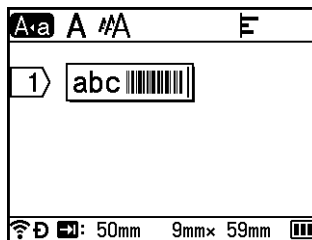

 **Note**

- To return to the previous step, press the **Esc** key.
- To set the selected attribute as the default setting, press the **Space** key .

**Editing and Deleting a Barcode**

- To edit barcode parameters and barcode data, select the barcode, and then press the **OK** or **Enter** key. See *Setting Barcode Parameters and Entering Barcode Data* on page 26 for more information.
- To delete a barcode from a label, position the cursor to the right of the barcode mark or select the barcode, and then press the **Backspace** key.

## Using the Time Stamp Function

---

You can add the time and date to your label.

### Clock Setting

Set the time and date in the [Set Clock] screen. After setting the time and date, you can add this information to your label using the [Time Stamp] function.

- 1 Select [Settings] in the Home screen using the ↑, ↓, ← or → key, and then press the **OK** or **Enter** key.
- 2 Select [Set Clock] using the ↑ or ↓ key, and then press the **OK** or **Enter** key.
- 3 Set the year according to the current date using the ↑ or ↓ key. Move to the next parameter using the ← or → key, and then set the parameter according to the current date and time using the ↑ or ↓ key. After you set all the parameters, press the **OK** or **Enter** key to apply the settings.



#### Note

---

- You can also set the time and date by typing in the numbers you want.
  - The clock will activate from when the clock setting is applied.
  - The coin cell battery is used to back up the clock setting when the AC adapter is unplugged.
- 

### Time & Date Format Setting

You can select from various formats of the time and date to add to your label.

Selectable "Time & Date" formats are listed in the Appendix. (See *Time & Date* on page 238.)

- 1 Select [Settings] in the Home screen using the ↑, ↓, ← or → key, and then press the **OK** or **Enter** key.
- 2 Select [Time & Date Format] using the ↑ or ↓ key, and then press the **OK** or **Enter** key.
- 3 Select [Date] or [Time] using the ↑ or ↓ key according to the item that you want to set. Select the format you want using the ↑ or ↓ key, and then press the **OK** or **Enter** key to apply the settings.



#### Note

---

The values for the date and time are used to display a sample setting. When a format is selected, the time and date set in the clock setting will appear in the selected format style.

---

## Time Stamp Setting

You can insert a time stamp in your label using the following procedure.

Press the **Insert** key, select [Time Stamp] using the ↑ or ↓ key, and then press the **OK** or **Enter** key.

You can change the time stamp settings to display the time stamp in various formats. (Factory settings are shown in bold.)

### ■ Timing

You can select whether to print the date and time when you press the **Insert** key, select [Time Stamp] using the ↑ or ↓ key, and then press the **OK** or **Enter** key, or the date and time when you press the **Print**, **OK** or **Enter** key to add to your label.

- 1 Select [Settings] in the Home screen using the ↑, ↓, ← or → key, and then press the **OK** or **Enter** key.
- 2 Select [Time Stamp Setting] using the ↑ or ↓ key, and then press the **OK** or **Enter** key.
- 3 Select [Timing] using the ↑ or ↓ key, select [Auto] or [Fixed] using the ← or → key, and then press the **OK** or **Enter** key to apply the settings.

Attribute	Setting	Description
Timing	<b>Auto</b>	Press the <b>Insert</b> key, select [Time Stamp] using the ↑ or ↓ key, and then press the <b>OK</b> or <b>Enter</b> key; the current date and time (a future date and time or a past date and time when [Forward] is set) and a clock icon will be inserted where the cursor is positioned on the label creation screen.  When you press the <b>Print</b> , <b>OK</b> , or <b>Enter</b> key to print, the current date and time will be printed on the label where the date, time, and the clock icon are positioned on the label layout.
	Fixed	Press the <b>Insert</b> key, select [Time Stamp] using the ↑ or ↓ key, and then press the <b>OK</b> or <b>Enter</b> key; the current date and time will be inserted where the cursor is positioned on the label creation screen. When you press the <b>Print</b> , <b>OK</b> , or <b>Enter</b> key to print, the date and time will be printed as shown on the label creation screen.



### Note

When [Auto] is selected for the [Timing] setting and a clock icon is added to the text by pressing the **Insert** key, selecting [Time Stamp] using the ↑ or ↓ key, and then pressing the **OK** or **Enter** key, you can confirm the icon settings as follows. Position the cursor to the left of the clock icon, press the **Insert** key, select [Time Stamp] using the ↑ or ↓ key, and then press the **OK** or **Enter** key.

■ **Format**

You can select which information to use when adding the date and time to your label.

- 1 Select [Settings] in the Home screen using the ↑, ↓, ← or → key, and then press the **OK** or **Enter** key.
- 2 Select [Time Stamp Setting] using the ↑ or ↓ key, and then press the **OK** or **Enter** key.
- 3 Select [Format] using the ↑ or ↓ key, select the value for the setting using the ← or → key, and then press the **OK** or **Enter** key to apply the settings.

Attribute	Setting	Description
Format	Date	Prints only the date on the label.
	Time	Prints only the time on the label.
	D&T	Prints the date and time on the label.
	T&D	Prints the time and date on the label.

■ **Forward**

You can select whether to use a future date and time, a past date and time, or the current date and time when [Timing] is set to [Auto].

- 1 Select [Settings] in the Home screen using the ↑, ↓, ← or → key, and then press the **OK** or **Enter** key.
- 2 Select [Time Stamp Setting] using the ↑ or ↓ key, and then press the **OK** or **Enter** key.
- 3 Select [Forward] using the ↑ or ↓ key, select [On] using the ← or → key, and then press the **OK** or **Enter** key.
- 4 Select [Add] or [Reduce] using the ↑ or ↓ key, select the year, month, week, date, hour or minute using the ← or → key, and then set the amount to increase or decrease from the currently set clock using the ↑ or ↓ key. After all parameters are set, press the **OK** or **Enter** key to apply the settings.



**Note**

You can also set the date and time by typing in the numbers you want.

Attribute	Setting	Description
Forward	Off	Prints the current time and date.
	On	Increases or decreases the date and time according to the value selected in the [Forward] setting.

## Changing and Deleting the Time Stamp Settings

To change the [Time Stamp] settings, select the clock icon, and then press the **OK** or **Enter** key.

To delete a time stamp from a label, position the cursor to the right of the clock icon or select the clock icon, and then press the **Backspace** key.

## Setting Character Attributes

### Setting Character Attributes by Label

Using the **Format** key, you can select a font and apply size, width, style, line, and alignment attributes. Selectable “Character Attribute” options are listed in the Appendix. (See *Character Attribute* on page 226.)

- 1 Press the **Format** key.  
The [Font] dialog box appears.

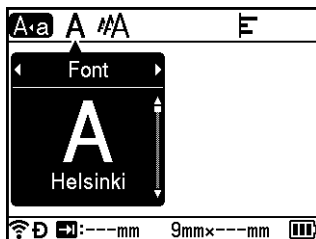

- 2 Select an attribute using the ← or → key.
- 3 Select the setting for that attribute using the ↑ or ↓ key, and then press the **OK** or **Enter** key to apply the settings.



#### Note

New settings are NOT applied unless you press the **OK** or **Enter** key.



#### Note

- To return to the previous step, press the **Esc** key.
- To set the selected attribute as the default setting, press the **Space** key.
- Small characters may be difficult to read when certain styles are applied (for example, Shadow + Italic).
- Depending on the label type, you cannot change the **Format** setting. In this case,  appears on the left side of the dialog box.

### Setting Character Attributes by Each Line

When a label consists of two or more lines of text, you can set different character attributes (font, size, width, style, line and alignment) for each line.

Move the cursor to the line you want to modify using the **↑**, **↓**, **←** or **→** key. Next, press the **Shift** and **Format** keys to display the setting dialog box. (≡ on the dialog box indicates that you are now setting the attributes for that specific line only.)

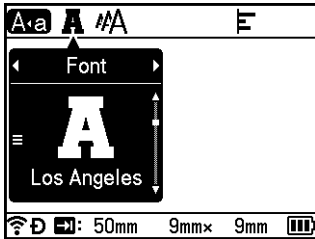

**! Important**

- When different attribute values are set for each line, the value appears as \*\*\*\*\* when you press the **Format** key. When you change the setting on this screen using the **↑** or **↓** key, the same change is applied to all lines of the label.
- When different attribute values are set for each line, the settings of the line where the cursor is positioned in the label creation screen appear at the top of the screen.

## Setting Frames

You can select the frame of the label using the **Format** key. Selectable “Frames” are listed in the Appendix. (See *Frames* on page 229.)

- 1 Press the **Format** key.
- 2 Select [Frame] using the **←** or **→** key.

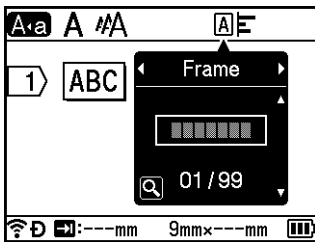

- 3 Select a frame using the **↑** or **↓** key, and then press the **OK** or **Enter** key. The selected frame is inserted.

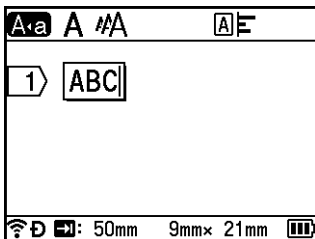

### Note

- If you press the **Preview** key when selecting a frame, you can display the frame list screen and select a frame from that screen.
- New settings are NOT applied unless you press the **OK** or **Enter** key.
- To return to the previous step, press the **Esc** key.
- To set the [Frame] setting as the default setting, press the **Space** key when the [Frame] dialog box appears.

## Using Auto Format Layouts

### Using Templates

You can use supplied templates to create labels by just entering the text or selecting the format. Selectable “Templates” are listed in the Appendix. (See *Template* on page 231.)

- 1 Select [Templates] in the Home screen using the ↑, ↓, ← or → key, and then press the **OK** or **Enter** key.
- 2 Select a category using the ↑ or ↓ key, and then press the **OK** or **Enter** key.

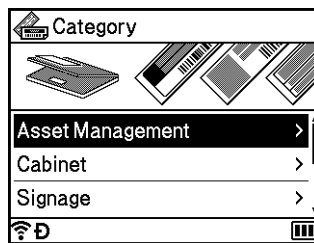

- 3 Select a template using the ↑ or ↓ key, and then press the **OK** or **Enter** key.
- 4 Enter text or a barcode for each text field if needed, and then press the **OK** or **Enter** key.
- 5 When finished, press the **OK** or **Enter** key.  
To print the label, select [Print] using the ↑ or ↓ key, and then press the **OK** or **Enter** key.

### Note

- For more information about barcodes, see *Creating a Barcode Label* on page 26.
- You can use the serialise settings with the entered text and barcodes. To specify the serialise settings, see *Entering a Serialised Label* on page 20. (The advanced serialize mode cannot be used.)
- To print the label, see *Printing a Label* on page 40.
- To preview the label before printing, select [Preview] using the ↑ or ↓ key, and then press the **OK** or **Enter** key. For more information about the preview screen, see *Label Preview* on page 44.
- To save the label, select [Save] using the ↑ or ↓ key, and then press the **OK** or **Enter** key.

## Using Block Layouts

You can use pre-installed block layouts to create labels by just entering the text or barcodes. Selectable “Block Layouts” are listed in the Appendix. (See *Block Layout* on page 234.)

- 1 Select [Block Layouts] in the Home screen using the ↑, ↓, ← or → key, and then press the **OK** or **Enter** key.
- 2 Select the tape width using the ↑ or ↓ key, and then press the **OK** or **Enter** key.
- 3 Select a block layout using the ↑ or ↓ key, and then press the **OK** or **Enter** key.
- 4 Enter text or a barcode for each text field if needed, and then press the **OK** or **Enter** key.
- 5 When finished, press the **OK** or **Enter** key.  
To print the label, select [Print] using the ↑ or ↓ key, and then press the **OK** or **Enter** key.



### Note

- For more information about barcodes, see *Creating a Barcode Label* on page 26.
- You can use the serialise settings with the entered text and barcodes. To specify the serialise settings, see *Entering a Serialised Label* on page 20. (The advanced serialize mode cannot be used.)
- To print the label, see *Printing a Label* on page 40.
- To preview the label before printing, select [Preview] using the ↑ or ↓ key, and then press the **OK** or **Enter** key. For more information about the preview screen, see *Label Preview* on page 44.
- To save the label, see *Storing a Label in the File Memory* on page 47.

## Cable Label Type

You can create labels for cables, patch panels, and other equipment when performing electrical work by selecting the type of label and setting the necessary items.

- 1 Select [Cable Label] in the Home screen using the ↑, ↓, ← or → key, and then press the **OK** or **Enter** key.
- 2 Select a label type using the ↑ or ↓ key, and then press the **OK** or **Enter** key.

The available cable label types are as follows:



### Note

Factory settings are shown in bold.

### Faceplate

Labels of this type can be used to identify various faceplates. Blocks of text are evenly spaced on each label.

One block



Two blocks



- Label Length: **50 mm**, 10-999 mm
- # of Blocks: **1**, 1-5
- Orientation: **AB 12** (**Horizontal**), **꺾 ㄷ** (**Vertical**)

### Cable Wrap

Labels of this type can be wrapped around a cable or wire. The text is rotated 90° counterclockwise and printed.



- UOM (Unit of Measure): **Dia(Ø)**, Length, CAT5/6, CAT6A, COAX, AWG
- Value: Varies depending on the UOM (Unit of Measure) setting
- Repeat: **On**, Off



#### Note

##### When using Flexible ID Tape:

- We recommend using Flexible ID Tape for "Cable Wrap" labels.
- Labels made with Flexible ID Tape are not designed for use as electrical insulation.
- When wrapping labels around cylindrical objects, the diameter (1) of the object should be at least 3 mm.
- The overlapping (2) ends of the label or the label flag should be at least 5 mm.

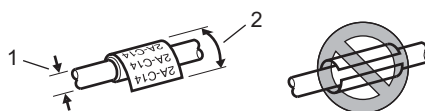

## Cable Flag

Labels of this type can be wrapped around a cable or wire, and both ends of the label stick together to form a flag. The text on flag labels is printed on both ends of the label, leaving a blank space in the middle that wraps around the cable.

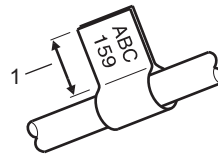

### 1 Flag length at least 5 mm

- Layout: 

AA	AA
----	----

 (same text on both sides), 

AA	BB
----	----

 (different text on each side)
- Flag Length: **30 mm**, 10-200 mm
- Cable Diameter: **6 mm**, 3-90 mm
- Orientation: 

ABC	123
-----	-----

 (**Horizontal**), 

ABC	123
-----	-----

 (Vertical)

Horizontal

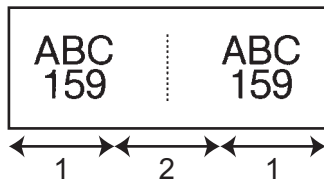

Vertical

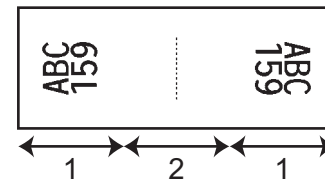

### 1 Flag length

### 2 Cable circumference



#### Note

- You can enter up to two barcodes when 





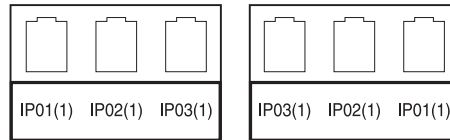

AA	AA
----	----

 is selected in flag layout.
- We recommend using Flexible ID Tape for "Cable Flag" labels.
- Labels made with Flexible ID Tape are not designed for use as electrical insulation.

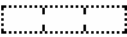
## Patch Panel

Labels of this type can be used to identify various types of panels.

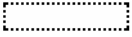

- Block Length: **15.0 mm**, 5.0-300.0 mm
- # of Blocks: **4**, 1-99
- Separator:  (**Tic**),  (**Dash**),  (**Line**),  (**Bold**),  (**Frame**),  (**None**)
- Orientation:  (**Horizontal**),  (**Vertical**)
- Reverse: **Off**, On
- Advanced: **Off**, On

Adjust block length independently when “Advanced” is set to “On”.

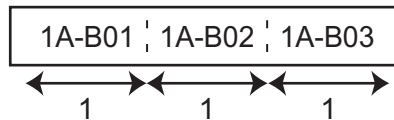

### 1 Block length

- No Margins: **Off**, On  
Set the left and right label margins to zero.



#### Note

“Advanced” and “No Margins” cannot be set to “On” at the same time.

### Punch-Down Block

Labels of this type can be used to identify a type of electrical connection, often used in telephony. You can enter up to eight lines for each block on a single label.

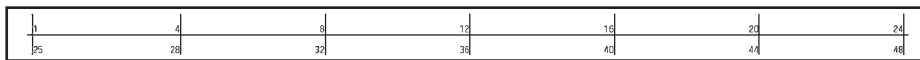

- Module Width: **200 mm**, 50-300 mm
- Block Type: **4 Pairs**, 2 Pairs, 3 Pairs, 5 Pairs, Blank
- Sequence Type: **| | | |** (**None**), **| 1 | 2 | 3** (Horizontal), **| 1 2 | 4 | 6** (Backbone)
- Start Value: ---, 1-99999



**Note**

- When "Blank" is selected in "Block Type", "Sequence Type" is set to "None".
- When "None" is selected in "Sequence Type", "---" appears for "Start Value" and you cannot set a value. Selecting "Horizontal" or "Backbone" however, allows you to set the "Start Value" setting from 1 to 99,999.

### Die-cut Flag

Labels of this type can be printed on special die-cut flag labels to create flag labels for cables and wires. Use FLe label cassettes for this type of application.

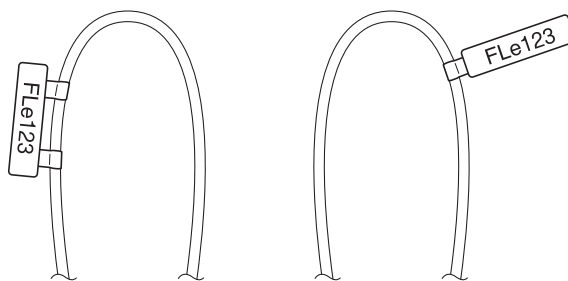

- Layout: 

AAA
AAA

 (same text in different directions on each side),  

AAA
AAA

 (same text in same direction on each side),  

AAA
BBB

 (different text in different directions on each side),  

AAA
BBB

 (different text in same direction on each side)
- Orientation: 

AB
----

 (**Horizontal**), 



☞
---

 (Vertical)

## Inverted Label

Labels of this type can be printed with the text and background colours reversed without changing the tape cassette. In addition, you can create labels with a small label height by setting [Orientation] to  (Vertical).



- Label Length: **Auto**, 5-999 mm
- Orientation:  (**Horizontal**),  (Vertical)



### Note

- The font and font style are set to Helsinki and bold respectively and cannot be changed.
- The following types of tape cannot be used:
  - 3.5 mm tape
  - Stencil tape
  - Heat Shrink Tube
  - Die-cut flag label

# Printing a Label

## Feeding Tape

---

### Important

- Be sure to feed tape to remove any slack in the tape and ink ribbon after inserting the tape cassette.
  - **Do not pull the label when the machine is ejecting it from the tape exit slot.** Doing so will cause the ink ribbon to be discharged with the tape. The tape may no longer be functional after the ink ribbon discharges.
  - Do not block the tape exit slot during printing or when feeding tape. Doing so will cause the tape to jam.
- 

## Feed and Cut

The Feed and Cut function feeds approximately 22.3 mm of blank tape, and then cuts the tape.

- 1 Press the  (Feed and Cut) button.  
[Feed & Cut?] appears on the LCD.
- 2 Select [Feed & Cut] using the  $\uparrow$  or  $\downarrow$  key, and then press the **OK** or **Enter** key. The message [Feeding Tape... Please Wait] appears while the tape is fed, and then the tape is cut.

### Note

To exit or cancel this function press the **Esc** key.

---

## Feed Only

This function ejects the tape approximately 22.3 mm, resulting in a blank label sticking out of the tape cassette. This action is recommended when using Fabric tapes, which should be cut with scissors.

- 1 Press the  (Feed and Cut) button.  
[Feed & Cut?] appears on the LCD.
- 2 Select [Feed Only] using the  $\uparrow$  or  $\downarrow$  key, and then press the **OK** or **Enter** key. The message [Feeding Tape... Please Wait] appears while the tape is fed.

### Note

To exit or cancel this function press the **Esc** key.

---

## Tape Cutting Options

---

The tape cutting options allow you to specify how the tape is fed and cut when printing labels.

- 1 Select [Settings] in the Home screen using the  $\uparrow$ ,  $\downarrow$ ,  $\leftarrow$  or  $\rightarrow$  key, and then press the **OK** or **Enter** key.

2 Select [Cut Options] using the ↑ or ↓ key, and then press the **OK** or **Enter** key.

3 Select the setting using the ↑ or ↓ key, and then press the **OK** or **Enter** key to apply the settings.



**Note**

New settings are NOT applied unless you press the **OK** or **Enter** key.



**Note**

- To return to the previous step, press the **Esc** key.
- See the following table for a list of all available settings.
- When printing multiple copies of different labels, you can select the chain printing option to reduce the blank space between the labels. The chain printing option is used for cutting option numbers 5-8. (See the following *Cut Option Table*.)
- When using the chain printing option, press the ✂ (Feed and Cut) button after the last label is printed.

**Cut Option Table**

Cut Option No.	Auto Cut	Half Cut	Chain Printing	Image
1	No	Yes	No	
2	Yes	Yes	No	
3	No	No	No	
4	Yes	No	No	

### Cut Option Table

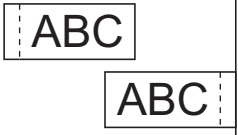
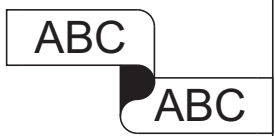
Cut Option No.	Auto Cut	Half Cut	Chain Printing	Image
5	No	Yes	Yes	
6	Yes	Yes	Yes	
7	No	No	Yes	
8	Yes	No	Yes	
9	Special tape			
(FLe Label) <sup>1</sup>	No	—	—	
(FLe Label) <sup>1</sup>	Yes	—	—	

<sup>1</sup> If you are using an FLe label cassette, set this cut option from a computer using the printer driver. These options cannot be set using the keyboard.

## Label Adjustment

---

### Adjusting the Label Length

When the tape cassette comes to the end, the printed length may be less accurate.

- 1 Select [Settings] in the Home screen using the ↑, ↓, ← or → key, and then press the **OK** or **Enter** key.
- 2 Select [Adjust Length] using the ↑ or ↓ key, and then press the **OK** or **Enter** key.
- 3 Set the value using the ↑ or ↓ key, and then press the **OK** or **Enter** key to apply the settings.



#### Note

Approximately 1% of the total label length will be adjusted by one level.

---

### Setting Auto Fit Style

When [Size] of the character attributes is set to [Auto] and the label length is set to a specific length, you can select the way of reducing the text size to fit within the label length.

- 1 Select [Settings] in the Home screen using the ↑, ↓, ← or → key, and then press the **OK** or **Enter** key.
- 2 Select [Auto Fit Style] using the ↑ or ↓ key, and then press the **OK** or **Enter** key.
- 3 Select the style using the ↑ or ↓ key.



#### Note

- When [Text Size] is selected, the total text size is modified to fit within the label.
  - When [Text Width] is selected, the text width will be reduced to the size of the [x 1/2] setting. (If further size reduction is needed to fit the text into the selected label length, the total text size will be modified after reducing the text width to the [x 1/2] setting.)
- 

- 4 Press the **OK** or **Enter** key to apply the settings.



#### Note

- To return to the previous step, press the **Esc** key.
  - To set the style as the default setting for [Text Size], press the **Space** key.
-

## Label Preview

---

You can preview the current page and check the layout before printing.

- 1 Press the **Preview** key.  
An image of the label appears on the screen.

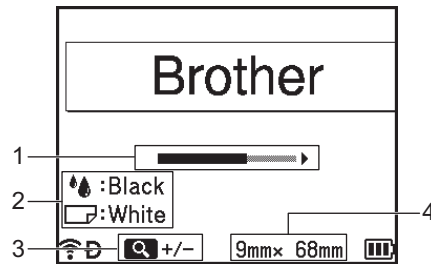

- 1 Indicates the position of the currently displayed portion of the label using the bar.
- 2 Indicates the information detected for the installed tape cassette. The first line indicates the character colour and the second line indicates the tape colour.
- 3 Press the **Preview** key to increase or decrease the magnification of the preview.
- 4 Indicates the tape width of the installed tape cassette and the label length as follows:  
Tape width x Label length.

Press the **↑**, **↓**, **←** or **→** key to scroll the preview.  
Press the **Preview** key to change the magnification of the preview.

### Note

---

- To return to the label creation screen, press the **Esc**, **OK** or **Enter** key.
  - To scroll the preview to the left or right end, press the **Shift** key, and then press the **←** or **→** key.
  - To print the label directly from the preview screen, press the **Print** key or open the [Print Options] screen and select a print option. See *Printing Labels* on page 45 for more information.
  - The print preview is a generated image of the label, and may differ from the actual label when printed.
  - The character colour and tape colour cannot be detected for some tape cassettes.
-

## Printing Labels

---

Labels can be printed when text entry and formatting is complete.

### ❗ Important

- **Do not pull the label when the machine is ejecting it from the tape exit slot.** Doing so will cause the ink ribbon to be discharged with the tape. The tape may no longer be functional after the ink ribbon discharges.
- To prevent damage to the tape, do not touch any key while the [Printing... Copies] or [Feeding Tape... Please Wait] message appears.
- Do not block the tape exit slot during printing or when feeding tape. Doing so will cause the tape to jam.
- Be sure to check that there is enough tape remaining when printing several labels continuously. If tape is running low, set fewer copies, print labels one at a time, or replace the tape cassette.
- Striped tape indicates the end of the tape cassette. If this appears during printing, press and hold the  (Power) button to turn the machine off. Attempting to print with an empty tape cassette may damage the machine.

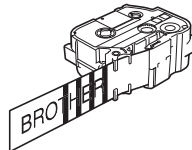

---

## Printing a Single Page

Press the **Print** key, and then press the **Print** or **OK** key to start printing.

## Printing Multiple Copies

Using this function you can print up to 99 copies of the same label.

- 1 Press the **Print** key, and then select the number of copies using the **←** or **→** key, or type the number using the number keys.



### Note

Press and hold the **←** or **→** key to change the number of copies quickly.



### Note

To cancel the current print job, press the **Cancel** key.

---

## Printing a Range of Pages

When there are multiple pages, you can specify the range of pages to print.

- 1 Press the **Shift** and **Print** keys.
- 2 Select [Current Page] or [Range] using the **↑** or **↓** key, and then press the **OK** or **Enter** key. If you select [Current Page], go to step 4.
- 3 Using the **↑**, **↓**, **←** or **→** key, specify the first page and the last page, and then select the number of copies.



### Note

Blank pages are not printed.

- 4 Press the **Print** or **OK** key to print.



### Note

- If you need all pages, press the **Print** key, and then press the **Print** or **OK** key to print all pages without specifying the range.
- To return to the previous step, press the **Esc** key.
- To cancel the current print job, press the **Cancel** key.
- The figures shown on the screen during printing indicate the “count/number of copies set”.
- Pressing the **Space** key when setting the number of copies resets the value to 01 (default).

## Mirror Printing

Use clear tape so the labels can be read correctly from the opposite side when attached on glass, windows or other transparent surfaces.

HTIM2.L

- 1 Press the **Shift** and **Print** keys.
- 2 Select [Mirror-print current page] using the **↑** or **↓** key, and then press the **OK** or **Enter** key.
- 3 Press the **Print** or **OK** key to print.

## Using the File Memory

You can store up to 99 of your most frequently used labels in the file memory. Each label is stored as a file, allowing you to quickly recall your label when needed again.



### Note

- When the file memory is full, each time you save a file you will need to overwrite one of your stored files.
- The available space <sup>1</sup> in the file memory can be confirmed using the following procedure:  
Select [Settings] in the Home screen using the ↑, ↓, ← or → key, and then press the **OK** or **Enter** key.  
Select [Memory Usage] using the ↑ or ↓ key, and then press the **OK** or **Enter** key.  
Select [Local Content] using the ↑ or ↓ key, and then press the **OK** or **Enter** key.

<sup>1</sup> Because the file size may vary depending on the characters input and the type of data, you may not be able to store a file even if the available space that appears in [Available : XXXXXchrs] indicates there is sufficient space.

## Storing a Label in the File Memory

- 1 After entering the text and formatting the label, press the **Save** key.
- 2 Select a file number using the ↑ or ↓ key, and then press the **OK** or **Enter** key.



### Note

- When there is already a stored file for the selected number, the file you are saving will overwrite the old one.
- To display the layout for the selected file number, press the **Preview** key.

- 3 Enter the file name, and then press the **OK** or **Enter** key.  
The file is saved and the screen returns to the label creation screen.



### Note

To return to the previous step, press the **Esc** key.

## Opening/Printing a Stored Label File

---

- 1 Select [File] in the Home screen using the ↑, ↓, ← or → key, and then press the **OK** or **Enter** key.
- 2 Select a file using the ↑ or ↓ key, and then press the **OK** or **Enter** key.
- 3 Select [Open] using the ↑ or ↓ key, and then press the **OK** or **Enter** key. The file appears on the label creation screen.
- 4 Press the **Print** key to print.



### Note

To return to the previous step, press the **Esc** key.

---

## Deleting a Stored Label File

---

### Important

To delete a label created using a transferred template, see *Deleting the Transferred Data* on page 61.

---

- 1 Select [File] in the Home screen using the ↑, ↓, ← or → key, and then press the **OK** or **Enter** key.
- 2 Select a file using the ↑ or ↓ key, and then press the **OK** or **Enter** key.



### Note

- To display the layout for the selected file, press the **Preview** key.
  - At this time, you can also delete by pressing the **Clear** key.
- 

- 3 Select [Delete] using the ↑ or ↓ key, and then press the **OK** or **Enter** key. The [Delete?] message appears.
- 4 Press the **OK** or **Enter** key to delete the file.



### Note

To cancel deleting the file and return to the previous screen, press the **Esc** key.

---

## Registering a Program

You can register symbols, databases, and other frequently used items.

This feature allows you to recall registered programs by pressing the **Program** key.



### Note

For more information on Register Programmable Function, see [FAQs & Troubleshooting] on the Brother Solutions Center at [support.brother.com](http://support.brother.com).

## Registering a New Program

- 1 Select [Register Programmable Function] in the Home screen using the ↑, ↓, ← or → key, and then press the **OK** or **Enter** key.
- 2 Select [\*\*\*] (not registered) using the ↑ or ↓ key, and then press the **OK** or **Enter** key.
- 3 Select the item category (symbol, transferred symbol, database, transferred template, or file) that you want to register using the ↑ or ↓ key, and then press the **OK** or **Enter** key.
- 4 Select the item that you want to register, and then press the **OK** or **Enter** key.
- 5 Enter the program name, and then press the **OK** or **Enter** key.  
The program registration is completed.



### Note

- The registered program name can also be changed later.
- You can register up to 10 programs. If 10 programs are already registered, you must delete one of the programs before registering a new program.
- If you recall a registered program and make changes to it, the revised program cannot be registered by overwriting the previous program. The revised program must be registered as a new program. Delete any unnecessary programs.

## Recalling and Using a Registered Program

- 1 Press the **Program** key while the Home screen or the label creation screen is displayed.
- 2 Select a program using the ↑ or ↓ key, and then press the **OK** or **Enter** key.



### Note

- You can also recall a program by typing the program number using the number keys.
- You can also recall a program by selecting [Register Programmable Function] in the Home screen.

## Deleting a Program

---

- 1 Select [Register Programmable Function] in the Home screen using the ↑, ↓, ← or → key, and then press the **OK** or **Enter** key.
- 2 Select a program using the ↑ or ↓ key, and then press the **OK** or **Enter** key.
- 3 Select [Delete] using the ↑ or ↓ key, and then press the **OK** or **Enter** key.  
The [Delete?] message appears.
- 4 Press the **OK** or **Enter** key.



### Note

---

You can also recall a program by:

- typing the program number using the number keys.
  - selecting [Register Programmable Function] in the Home screen.
-

# Using the Data Transferred to the P-touch Labelling Machine

You can use a template, database, or symbol transferred from the computer to print the label.

## Transferring Data from the Computer

You can use the transfer function of Cable Label Tool or P-touch Transfer Manager to transfer data from the computer to the machine.

For more information, see *Transferring Templates from Cable Label Tool to the P-touch Labelling Machine* on page 129 or *How to Use P-touch Transfer Manager* on page 134.

## Transferred Symbols

To enter transferred symbols, see *Entering Symbols* on page 18.

## Printing the Transferred Template

You can transfer a label layout created with P-touch Editor (\*.lhx file) to the machine, and then use it as a template for printing labels. To edit or print templates, type new text directly or use text from a database.

### Important

- Before editing a template, transfer the template to the machine.
- When the transfer of the data to the machine is complete, turn the machine off and then on again.

## When the Template has No Object to be Edited

- 1 Select [Transferred Templates] in the Home screen using the ↑, ↓, ← or → key, and then press the **OK** or **Enter** key.



### Note

The names and numbers of the transferred templates that can be selected appear, and a preview of the selected template appears.

- 2 Select the template you want using the ↑ or ↓ key, and then press the **OK** or **Enter** key.



### Note

When the template is linked to a database, the  icon appears in the upper-right corner of the screen.

- 3 Select [Print] or [Print from Database] using the ↑ or ↓ key to start printing.

 **Note**

To select the range from the database that you want to print, follow steps ③ - ⑤ in *When the Template is Linked to the Database and will not be Edited*.

## When the Template has an Object to be Edited

If needed, the template can be temporarily edited. However, the template cannot be saved after it is changed. When the template is not linked to a database, to print the label you must first select the label template, and then type text in each of its fields.

When the template is linked to a database, you can print a single record or a range of records in the database linked to the template.

 **Important**

You cannot add or delete line breaks.

- 1 Select [Transferred Templates] in the Home screen using the ↑, ↓, ← or → key, and then press the **OK** or **Enter** key.

- 2 Select the template using the ↑ or ↓ key, and then press the **OK** or **Enter** key.

 **Note**

When the template is linked to a database, the  icon appears in the upper-right corner of the screen.

- 3 Select [Edit Label without Saving] using the ↑ or ↓ key, and then press the **OK** or **Enter** key. Objects that can be edited appear.

- 4 Select the object to be edited using the ↑ or ↓ key, and then press the **OK** or **Enter** key.

- When the template is not linked to a database:

The contents of the selected object appear. Edit the object, and then press the **OK** or **Enter** key.

- When the template is linked to a database:

The first record of the database appears. Edit the object, and then press the **OK** or **Enter** key.

- 5 When finished, press the **Esc** key.

- 6 Select the menu using the ↑ or ↓ key to start printing.

- When the template is not linked to a database:

Select [Print] using the ↑ or ↓ key to start printing.

- When the template is linked to a database:

Select [Print from Database] or [Print Edited Label] using the ↑ or ↓ key to start printing.



### Note

- When editing templates linked to a database:
  - When an object that is not linked to the database was edited, select [Print from Database] to print.
  - When an object that is linked to the database was edited, the edited contents will be deleted if you select [Print from Database]. Therefore, print the template just by selecting [Print Edited Label] using the ↑ or ↓ key.
- To select the range from the database that you want to print, follow steps ③ - ⑤ in *When the Template is Linked to the Database and will not be Edited*.
- To edit the database, see *Editing the Database* on page 58.

## When the Template is Linked to the Database and will not be Edited

- ① Select [Transferred Templates] in the Home screen using the ↑, ↓, ← or → key, and then press the **OK** or **Enter** key.
- ② Select the template using the ↑ or ↓ key, and then press the **OK** or **Enter** key.



### Note

When the template is linked to a database, the  icon appears in the upper-right corner of the screen.

- ③ Select [Print from Database] using the ↑ or ↓ key, and then press the **OK** or **Enter** key. The contents of the database linked to the template appear.
- ④ Select the first record in the range that you want to print using the ↑, ↓, ← or → key, and then press the **OK** or **Enter** key.
- ⑤ Select the last record in the range that you want to print using the ↑, ↓, ← or → key, and then press the **OK** or **Enter** key to start printing. When the range is set, the selected records are highlighted.



### Note

To return to the previous step, press the **Esc** key.

## Using Transferred Database Data

You can transfer a database converted to a \*.csv file to the machine.

The data for a database that was transferred without a template can be imported into each label except auto format layouts and transferred templates. The database data is imported according to the number of blocks and pages set for each label.

### Important

- Before using a database, transfer the database to the machine.
- If a database and template are linked and transferred together, the database can use only that template.

### Note

- If the selected database range is larger than the set number of blocks and pages, the data will be imported until the maximum number of blocks and pages is reached.
- If the set number of blocks and pages is larger than the selected database range, the operation will finish when the complete database is imported. The remaining blocks and pages will not be printed.

1 Press the **Insert** key, select [Database] using the ↑ or ↓ key, and then press the **OK** or **Enter** key.

2 Select the database you want using the ↑ or ↓ key, and then press the **OK** or **Enter** key.  
The first record of the selected database appears.

### Note

- If the selected record is not changed within a certain time while the database is displayed, the contents of the record will be displayed at the bottom of the screen. However, the contents of the record will not be displayed if the record contains 11 one-byte characters or fewer.
- When the **Preview** key is pressed, the properties of the record appear.
- When setting the range, the "field names" line (first line of data) cannot be selected.

name	type
AAA	brother-...
ABC	brother-...
AC-D	brother-...
AD-D	brother-...
AEA	brother-...

brother-PT-printer

- 3 Select the first record in the range that you want to insert, and then press the **OK** or **Enter** key. The selected record is highlighted.

number	name
1A-B01	AAA
1A-B02	ABC
1A-B03	AC-D
1A-B04	AD-D
1A-B05	AEA

- 4 Select the last record in the range that you want to insert, and then press the **OK** or **Enter** key. The selected range is highlighted.

number	name
1A-B01	AAA
1A-B02	ABC
1A-B03	AC-D
1A-B04	AD-D
1A-B05	AEA

The contents of the selected database appear.

A a A #A E		
1	1A-B02	1A-B03

## Searching the Database

While selecting a database record you want to use in a template or added to a label, you can search for records containing specific characters or a specific number.

The search proceeds to the right after the first matched string. Then, the database records will be searched in the same direction as the import order for the label type. The "field names" line will also be searched.

The possible search characters include upper-case and lower-case letters (including accented characters), numbers, and the upper symbols shown on the keys.

- 1 Press the **Insert** key, select [Database] using the ↑ or ↓ key, and then press the **OK** or **Enter** key.
- 2 Select the database you want using the ↑ or ↓ key, and then press the **OK** or **Enter** key.  
The first record of the selected database appears.

number	name
1A-B01	AAA
1A-B02	ABC
1A-B03	AC-D
1A-B04	AD-D
1A-B05	AEA

- 3 Type in the first character (for example, "B") that you want to search for.  
**Example:** If you type "B", the fields will be searched from the first field for character strings containing "B".

num <b>B</b> er	name
1A-B01	AAA
1A-B02	ABC
1A-B03	AC-D
1A-B04	AD-D
1A-B05	AEA

If a string that contains "B" is found, the cursor moves to that data and "B" becomes highlighted. In addition, "B" will be stored in the internal memory.

If a string that contains the searched character "B" is not found, the cursor remains in its current position without moving and the character "B" will not be stored in the internal memory.

- 4 Type in the second character (for example, "R") that you want to search for.  
Next, if you type "R", the fields will be searched from the next field for character strings containing "BR".

name	type
AAA	brother-...
ABC	brother-...
AC-D	brother-...
AD-D	brother-...
AEA	brother-...

Q brother-PT-printer

If a string that contains "BR" is found, the cursor moves to that data and "BR" becomes highlighted. In addition, "BR" will be stored in the internal memory.

- 5 Continue searching the database using the same procedure.

 **Note**

- If the character that you searched for is contained in multiple fields in the database, press the **Next** key to move to the next field containing the character. The character will be highlighted in the field.

name	type
AAA	brother-...
ABC	brother-...
AC-D	brother-...
AD-D	brother-...
AEA	brother-...

Q brother-PT-printer

- Press the **Backspace** key to delete the last search character. The cursor will move to the field containing the remaining search characters.

number	name
1A-B01	AAA
1A-B02	ABC
1A-B03	AC-D
1A-B04	AD-D
1A-B05	AEA

## Editing the Database

- 1 Press the **Insert** key, select [Database] using the **↑** or **↓** key, and then press the **OK** or **Enter** key.
- 2 Select the database you want to edit using the **↑** or **↓** key, and then press the **OK** or **Enter** key.



### Note

You can also select the database you want to edit using the following procedure:

Select [Transferred Templates] in the Home screen using the **↑**, **↓**, **←** or **→** key, and then press the **OK** or **Enter** key. Select the template linked to a database you want to edit using the **↑** or **↓** key, and then press the **OK** or **Enter** key. Select [Print from Database] using the **↑** or **↓** key, and then press the **OK** or **Enter** key.

The first record of the selected database appears.

number	name
1A-B01	AAA
1A-B02	ABC
1A-B03	AC-D
1A-B04	AD-D
1A-B05	AEA

- 3 Select the cell you want using the **↑**, **↓**, **←** or **→** key, and then press and hold the **OK** or **Enter** key.

A·a
1   1A-B01

- 4 Enter the new text.

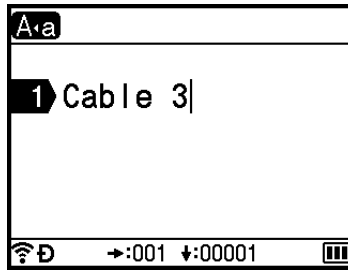

**Note**

To cancel editing the text and return to the previous screen, press the **Esc** key.

**Important**

- You can add or delete a line break.
- Each cell can contain a maximum of 17 lines.

- 5 Press the **OK** key.  
The new text appears.

A screenshot of a P-touch label editor interface showing a table with two columns: 'number' and 'name'. The table contains five rows of data. The first row is highlighted. The bottom status bar shows a Wi-Fi icon, a battery icon, and the text '→:001 ↓:00001'.

**Note**

If you do not want to print the database, press the **OK** key, and then press the **Esc** key. The edited data will be saved.

- 6 Press the **OK** key again.  
The edited record becomes highlighted.

A screenshot of a P-touch label editor interface showing a table with two columns: 'number' and 'name'. The table contains five rows of data. The first row, 'Cable 3' and 'AAA', is highlighted. The bottom status bar shows a Wi-Fi icon, a battery icon, and the text '→:001 ↓:00001'.

**7** Do one of the following:

- When the database has been transferred with a template:

Select the last record in the range that you want to print using the ↑, ↓, ← or → key, and then press the **OK** or **Enter** key to start printing.

When the range is set, the selected records become highlighted.

number	name
Cable 3	AAA
1A-B02	ABC
1A-B03	AC-D
1A-B04	AD-D
1A-B05	AEA

- When the database has been transferred without a template:

Select the last record in the range that you want to insert, and then press the **OK** or **Enter** key.

The selected range becomes highlighted.

The contents of the selected database appears.

number	name
Cable 3	AAA
1A-B02	ABC
1A-B03	AC-D
1A-B04	AD-D
1A-B05	AEA

A a	A #A	E
1	3	1A-B02 1A-B03

50mm 9mm× 32mm

**8** Press the **Print** key.

## Deleting the Transferred Data

Use the following methods to delete transferred data.

Multiple items cannot be deleted together. Delete each item separately.

### Deleting Transferred Symbols

---

3

- 1 Press the **Insert** key, select [Transferred Symbols] using the ↑ or ↓ key, and then press the **OK** or **Enter** key.
- 2 Select the transferred symbol you want to delete using the ↑ or ↓ key, and then press the **Clear** key. The [Delete?] message appears.
- 3 Press the **OK** or **Enter** key. The selected transferred symbol is deleted and the next image is selected. If needed, delete the next image.

### Deleting Templates

---

- 1 Select [Transferred Templates] in the Home screen using the ↑, ↓, ← or → key, and then press the **OK** or **Enter** key.
- 2 Select the template you want to delete using the ↑ or ↓ key, and then press the **OK** or **Enter** key.
- 3 Select [Delete] using ↑ or ↓ key, and then press the **OK** or **Enter** key. The [Delete?] message appears.
- 4 Press the **OK** or **Enter** key. The selected template is deleted and the next template is selected. If needed, delete the next template.

### Deleting Databases

---

- 1 Press the **Insert** key.
- 2 Select the database you want to delete using the ↑ or ↓ key, and then press the **Clear** key. The [Delete?] message appears.
- 3 Press the **OK** or **Enter** key. The selected database is deleted and the next database is selected. If needed, delete the next database.

## Installing the Printer Driver and Software

To print from your Windows® computer or Mac, install the printer driver, Cable Label Tool, P-touch Editor and other applications.

### Important

Do not connect the P-touch labelling machine to the computer until asked to do so.

- 1 Visit our website ([www.brother.com/inst](http://www.brother.com/inst)) and download the installer for the software and manuals.
- 2 Double-click the downloaded file and follow the on-screen instructions to proceed with the installation.

### Note

- After the installation starts, you can select which items to install.
  - To connect the machine to a computer using a wireless connection, we recommend the following:
    - Configure the wireless network settings while installing the software. You can change the settings later using the [Settings] in the Home screen or Printer Setting Tool. For more information, see *Connecting Using Wi-Fi* on page 63 or *Changing the P-touch Labelling Machine Settings* on page 80.
    - Install the software on a computer wirelessly connected to your network and configuring the machine using a USB cable.
    - Get the SSID (network name) and password (network key) of the wireless network in advance.
- 3 Close the dialog box when the installation is complete.

## Connecting the Machine to a Computer

Connect your machine using one of the methods below:

- USB cable connection  
See *Connecting Using USB* on page 62.
- Wireless LAN connection  
See *Connecting Using Wi-Fi* on page 63.

### Connecting Using USB

- 1 Before connecting the USB cable, make sure that the machine is turned off.
- 2 Connect the machine end of the USB cable to the USB port on the back of the machine.
- 3 Connect the other end of the USB cable to the USB port on the computer.
- 4 Turn the machine on.

## Connecting Using Wi-Fi

You can select the network type, configure or display the network settings using [Settings] in the Home screen. You can also use [Communication settings] in the Printer Setting Tool for detailed configuration. For more information see *Changing the P-touch Labelling Machine Settings* on page 80.

The following Wi-Fi connection methods are available:

- Infrastructure Mode
- Ad-Hoc Mode (To set the Ad-Hoc mode, use the Printer Setting Tool (see *Changing the P-touch Labelling Machine Settings* on page 80).)

### Infrastructure Mode

Infrastructure mode allows you to connect the machine to a computer via a wireless access point/router.

#### ■ Before You Begin

First you must configure the Wi-Fi settings of your machine to communicate with your wireless access point/router. After the machine has been configured, computers on your network will have access to the machine.

#### ! Important

- If you are going to connect the machine to your network, we recommend contacting your system administrator prior to installation. You must confirm your Wi-Fi settings before you proceed with this installation.
- To configure the Wi-Fi settings again, or if the status of the Wi-Fi connection for your machine is not clear, reset the Wi-Fi settings of the machine.
  - 1 Select [Settings] in the Home screen using the ↑, ↓, ← or → key, and then press the **OK** or **Enter** key.
  - 2 Select [Reset] using the ↑ or ↓ key, and then press the **OK** or **Enter** key.
  - 3 Select [Reset Wi-Fi Settings] using the ↑ or ↓ key, and then press the **OK** or **Enter** key.

#### Note

- We recommend preparing the SSID (network name) and password (network key) of the wireless network in advance.
- To achieve the best results with everyday document printing, use the machine as close to the wireless access point/router as possible with minimal obstructions. Large objects and walls between the two devices and interference from other electronic devices can affect the data transfer speed of your documents.

#### ■ Configuring using the Setup Wizard



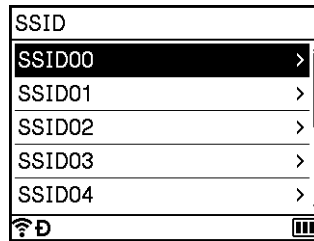

- 1 Select [Settings] in the Home screen using the ↑, ↓, ← or → key, and then press the **OK** or **Enter** key.
- 2 Select [WLAN] using the ↑ or ↓ key, and then press the **OK** or **Enter** key.

- 3 Select [Infrastructure Mode] using the ↑ or ↓ key, and then press the **OK** or **Enter** key.
- 4 Select [Network Setting] using the ↑ or ↓ key, and then press the **OK** or **Enter** key.
- 5 Select [Setup Wizard] using the ↑ or ↓ key, and then press the **OK** or **Enter** key.
- 6 If any messages appear, press the **OK** or **Enter** key for each message. The SSIDs for the available networks appear.

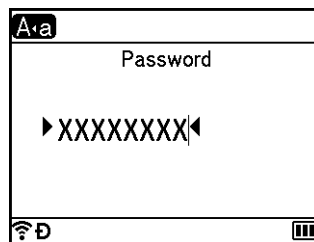

- 7 Select the SSID using the ↑ or ↓ key, or select [Other...] and enter the SSID (from 1 to 32 characters), and then press the **OK** or **Enter** key. The [Password] screen appears.





- 8 Enter the password (from 8 to 63 characters or, when using WEP, from 5 to 13 characters), and then press the **OK** or **Enter** key.
- 9 The screen returns to the [Settings] menu screen, and  blinks while the connection is being established. After 90 seconds, the indicator will change to , but your machine will continue trying to connect to the network.
- 10 When connected, depending on the strength of the wireless signal, the wireless connection indicator shows of the following symbols:   



**Note**

If you start the setup wizard for the Infrastructure mode or select the network settings for the Direct mode when the wireless function of the machine is turned off, [Turning on Wi-Fi Radio] appears and the wireless function turns itself on automatically (or after the **OK** key is pressed). It is no longer necessary to turn the Infrastructure mode or Direct mode on manually.

■ **Connecting the machine to your wireless access point/router using a computer**

- 1 First, write down the SSID (network name) and password (network key) of your wireless access point/router.
- 2 Connect the machine and computer with a USB cable.
- 3 Press and hold the  (Wi-Fi) button on your machine for one second to turn the Wi-Fi function on. The  (Wi-Fi) indicator starts flashing in green once every three seconds.
- 4 Configure the Infrastructure Mode settings of the machine using the computer.

■ For Windows®

Start the Printer Setting Tool on your computer, and click [**Communication settings**]. Select [**Infrastructure or Ad-hoc**] or [**Infrastructure and Wireless Direct**] for [**Selected Interface**] in [**Communication settings**] in the [**General**] tab, and select [**Infrastructure**] for [**Communication Mode**] in [**Wireless Settings**] in the [**Wireless LAN**] tab.

For details, see *Changing the P-touch Labelling Machine Settings* on page 80.

■ For Mac

Start the Wireless Device Setup Wizard included in the Printer Driver Package, and then follow the on-screen instructions. The Wireless Device Setup Wizard can be found in the [**Utilities**] folder.

- 5 Enter the SSID that you wrote down, or click [**Search**] and select the SSID from the displayed list.
- 6 Enter the password in the [**Passphrase**] field.



**Note**

The required information depends on the authentication method and encryption mode; enter only the information relevant to your network environment.

- 7 To send the settings to the machine, click [**Apply**].  
When the connection between the machine and your wireless access point/router is established, the  (Wi-Fi) indicator lights in green. Computers on the same network as the machine will have access to the machine.



**Note**

To change any other network settings, use the Printer Setting Tool (see *Changing the P-touch Labelling Machine Settings* on page 80).

## ■ WPS (Wi-Fi Protected Setup™)

If your wireless access point/router supports WPS, you can configure settings and connections wirelessly.

- 1 First, confirm that your wireless access point/router has the WPS symbol.



- 2 Select [Settings] in the Home screen using the ↑, ↓, ← or → key, and then press the **OK** or **Enter** key.
- 3 Select [WLAN] using the ↑ or ↓ key, and then press the **OK** or **Enter** key.
- 4 Select [Infrastructure Mode] using the ↑ or ↓ key, and then press the **OK** or **Enter** key.
- 5 Select [Network Setting] using the ↑ or ↓ key, and then press the **OK** or **Enter** key.
- 6 Place your machine within the range of your wireless access point/router. The range may differ depending on your environment. See the instructions provided with your wireless access point/router.
- 7 Select [Button Push] using the ↑ or ↓ key, and then press the **OK** or **Enter** key.
- 8 Press the **OK** or **Enter** key for a message that appears before the [Start WPS on Your Wireless Access Point].  
The [Start WPS on Your Wireless Access Point] message appears.
- 9 Press the WPS button on your wireless access point/router, and then press the **OK** or **Enter** key on your machine.



### Note

To return to the previous step, press the **Esc** key.

- 10 [Connecting...] appears for a while, and then [Connected!] appears.
- 11 Press the **OK** or **Enter** key.  
The screen returns to the [Settings] menu screen.  
Depending on the strength of the wireless signal, the wireless connection indicator may show one of the following symbols: 





### Note

- If you start the setup wizard for the Infrastructure mode or select the network settings for the Direct mode when the wireless function of the machine is turned off, [Turning on Wi-Fi Radio] appears and the wireless function turns itself on automatically (or after the **OK** key is pressed). It is no longer necessary to turn the Infrastructure mode or Direct mode on manually.
- Your machine will try to connect using WPS for two minutes. If the  (Wi-Fi) button is pressed and held during that time, the machine will continue trying to connect for an additional two minutes.
- If your machine could not connect to the network, a message indicating that the connection failed appears.

### ■ Configuring by entering the PIN

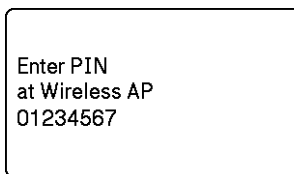
- 1 Select [Settings] in the Home screen using the ↑, ↓, ← or → key, and then press the **OK** or **Enter** key.
- 2 Select [WLAN] using the ↑ or ↓ key, and then press the **OK** or **Enter** key.
- 3 Select [Infrastructure Mode] using the ↑ or ↓ key, and then press the **OK** or **Enter** key.
- 4 Select [Network Setting] using the ↑ or ↓ key, and then press the **OK** or **Enter** key.
- 5 Select [PIN Code] using the ↑ or ↓ key, and then press the **OK** or **Enter** key.
- 6 If some messages appear, press the **OK** or **Enter** key for each message.
- 7 Type the PIN displayed on the screen into your wireless access point/router, and then press the **OK** or **Enter** key.



- 8 [Connecting...] appears for a while, and then [Connected!] appears.
- 9 Press the **OK** or **Enter** key.  
The screen returns to the [Settings] menu screen.  
Depending on the strength of the wireless signal, the wireless connection indicator may show one of the following symbols: 



#### Note

If you start the setup wizard for the Infrastructure mode or select the network settings for the Direct mode when the wireless function of the machine is turned off, [Turning on Wi-Fi Radio] appears and the wireless function turns itself on automatically (or after the **OK** key is pressed). It is no longer necessary to turn the Infrastructure mode or Direct mode on manually.



### Ad-Hoc Mode

For Windows, after installing the printer driver and other applications to your computer, set the Ad-Hoc mode using the Printer Setting Tool installed on the computer.

For Mac, set the Ad-Hoc mode using the Wireless Device Setup Wizard.

## Turning the Wireless Function On or Off

To turn the wireless function on or off, press the  (Wi-Fi) button.

- 1 Press the  (Wi-Fi) button. The wireless function is now on.
- 2 Press the  (Wi-Fi) button again to turn the wireless function off.



### Note

- If [Off] is selected in the [Direct Mode On/Off] and [Infrastructure Mode On/Off] screen, the wireless function will remain off even if you press the  (Wi-Fi) button. (The factory setting is "On" for both Direct mode and Infrastructure mode.) For more information see *Infrastructure Mode* on page 63 or *Connecting the machine to a Mobile Device* on page 73.
- When the wireless function is on, the Li-ion battery power will decrease quickly. To change the power source, connect the AC adapter.

# Printing from a Computer

## Available Applications

To use the machine effectively, a number of applications and functions are available.

You must install the printer driver to use these applications.

Visit our website ([www.brother.com/inst](http://www.brother.com/inst)) and download the installer for the applications and printer driver.

Application	Windows	Mac	Features
Cable Label Tool	✓		Create and print labels for cables, patch panels, faceplates, electrical equipment and more.
P-touch Editor	✓	✓	Design and print custom labels with built in drawing tools, text using different fonts and styles, imported graphic images and barcodes.
P-touch Transfer Manager	✓		It allows you to transfer templates and other data to the machine and save backups of your data on the computer. This application is installed with P-touch Editor.
P-touch Library	✓		Manage and print P-touch Editor templates. You can use P-touch Library to print templates. This application is installed with P-touch Editor.
P-touch Update Software	✓	✓	Update software to the latest version.
Printer Setting Tool	✓	✓	Specify the printer's device settings from a computer.
Wireless Device Setup Wizard		✓	This application allows you to configure your machine for a wireless network.
BRAdmin Light	✓		Finds the machine on your network and is used to make basic configuration settings from your computer.
BRAdmin Professional	✓		Finds the machine on your network and is used to make advanced configuration settings and updates from your computer.

Useful Function	Windows	Mac	Features
Distributed printing	✓		When printing a large number of labels, printing can be distributed among multiple machines. Because printing is performed at the same time, the total printing time can be reduced. For more information, see <i>Printing Labels Distributed to Multiple Machines (Windows® only)</i> on page 111.
High resolution printing	✓		Print in higher resolution. For more information, see <i>Printing Labels in High Resolution Mode</i> on page 115.
High speed printing	✓		Print faster. For more information, see <i>Printing Labels in High Speed Mode</i> on page 116.

## Printing from Your Computer

There are various methods for printing with this machine.

The following describes the procedure for printing from a computer using Cable Label Tool or P-touch Editor.



- 1 Start Cable Label Tool or P-touch Editor, and then open the document you want to print.
- 2 Create a label design.
- 3 Check the cutting options. (See *Cutting Options* on page 70.)
- 4 Select [**File**] then [**Print**] from the menu bar or by clicking the [**Print**] icon.

### Cutting Options



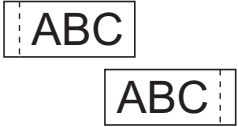

The cutting options allow you to specify how the item is fed and cut when it is printed. Use the printer driver to select the cutting option when printing from the computer using the application.

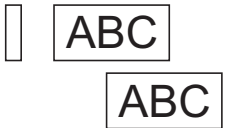
See the following table for a list of all available settings:

**Tape Cut Option Table**

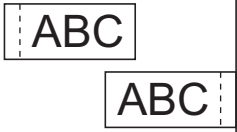
Auto Cut	Half Cut	Chain Printing	Image
No	Yes	No	
Yes	Yes	No	
No	No	No	
Yes	No	No	

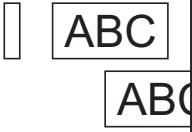
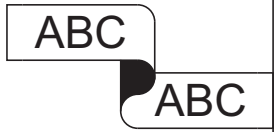
**Tape Cut Option Table**

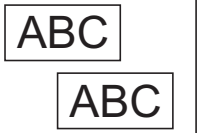
Auto Cut	Half Cut	Chain Printing	Image
No	Yes	Yes	
Yes	Yes	Yes	
No	No	Yes	
Yes	No	Yes	
Special tape			
No (FLe Label)	—	—	
Yes (FLe Label)	—	—	



**Note**

- When printing multiple copies of different labels, you can select the chain printing option to reduce the blank space between the labels. (See the *Tape Cut Option Table*.)
- When using the chain printing option, press the ✂ (Feed and Cut) button after the last label is printed.

---

## Attaching Labels

---

- 1 If needed, trim the printed label to the shape and length you want with scissors.
- 2 Peel the backing from the label.
- 3 Position the label, and then press firmly from top to bottom with your finger to attach the label.



**Note**

- The backing of some types of tapes may be pre-cut to make it easier to peel the backing. To remove the backing, simply fold the label lengthwise with the text facing inwards, to expose the inside edges of the backing. Next, peel off the backing one piece at a time.
  - Labels may be difficult to attach to surfaces that are wet, dirty, or uneven. The labels may peel off easily from these surfaces.
  - Extra Strength Adhesive Tape:
    - For rough and textured surfaces, we recommend using Extra Strength Adhesive Tape.
  - Be sure to read the instructions provided with Fabric Tapes, Extra Strength Adhesive Tapes or other special tapes and observe all precautions noted in the instructions.
-

## Installing Applications for Use with Mobile Devices

Brother offers various applications for use with your P-touch labelling machine, including applications that allow you to print directly from your Apple iPhone, iPad, and iPod touch or Android™ smartphone or tablets, and applications that allow you to transfer data, such as templates, symbols, and databases created using a computer, to your machine wirelessly.

### Available Applications

The following Brother applications can be installed free-of-charge from the App Store or Google Play™:

Application	Features
Mobile Cable Label Tool	Print labels for cables and patch panels using templates on a smartphone, tablet or other mobile device directly to your machine.
Brother iPrint&Label	Create and print labels using templates on a smartphone, tablet or other mobile device directly to your machine.
Mobile Transfer Express	Allows you to use a mobile device to download databases and label data, which was created on a computer using P-touch Editor and saved to a cloud service, and send them to your machine.

## Connecting the machine to a Mobile Device

You can connect your machine to a mobile device. To create and print labels directly from your mobile device, install the Brother mobile applications, and then connect your machine to your mobile device.

### ■ Connecting using the machine keyboard

- 1 Select [Settings] in the Home screen using the ↑, ↓, ← or → key, and then press the **OK** or **Enter** key.
- 2 Select [WLAN] using the ↑ or ↓ key, and then press the **OK** or **Enter** key.
- 3 Select [Direct Mode] using the ↑ or ↓ key, and then press the **OK** or **Enter** key.  
The machine displays the  symbol.
- 4 Select [Network Setting] using the ↑ or ↓ key, and then press the **OK** or **Enter** key.

**Note**

- If you start the setup wizard for the Infrastructure mode or select the network settings for the Direct mode when the wireless function of the machine is turned off, [Turning on Wi-Fi Radio] appears and the wireless function turns itself on automatically (or after the **OK** key is pressed). It is no longer necessary to turn the Infrastructure mode or Direct mode on manually.
- When the wireless function is on, the Li-ion battery power will decrease quickly. To change the power source, connect the AC adapter.

- 5 The current SSID appears on-screen. Enter the new SSID if needed, and then press the **OK** or **Enter** key.
- 6 The current password appears on-screen. Enter the new password if needed, and then press the **OK** or **Enter** key.
- 7 The screen to confirm the entered SSID and password appears. Press any key to continue, and then go to the wireless network settings page of your mobile device and type the SSID name and password.
- 8 You have completed the Wireless Direct network setup.



## ■ Connecting using a Computer

- 1 Confirm the Wireless Direct settings of the machine.
  - For Windows®
 

Connect the machine and computer with a USB cable. Start the Printer Setting Tool on your computer, and click [**Communication settings**]. Confirm that [**Infrastructure and Wireless Direct**] or [**Wireless Direct**] is selected for [**Selected Interface**] in [**Communication settings**] in the [**General**] tab.

For more information, see *Printer Setting Tool for Windows*® on page 80.
  - For Mac
 

Connect the machine and computer with a USB cable. Start the Printer Setting Tool on your computer, and confirm that [**WirelessDirect**] is set to [**On**] in the [**Wireless LAN**] tab.

For more information, see *Printer Setting Tool for Mac* on page 103.
- 2 Press and hold the  (Wi-Fi) button on your machine for one second to turn the Wi-Fi function on. The  (Wi-Fi) indicator starts flashing in green once every three seconds.
- 3 In the Wi-Fi settings screen of your mobile device, select the SSID of the machine and enter the password.





### Note

- The factory settings for the SSID and password are as follows:  
SSID: "PT-D800W" or "DIRECT-\*\*\*\*\*\_PT-D800W" where "\*\*\*\*\*" is the last five digits of the product serial number.  
(You can find the serial number label on the bottom of the machine.)  
Password (network key): 00000000
- You can connect the machine to a mobile device in the Infrastructure Mode via a wireless access point/router.
- You cannot connect to the Internet via Wi-Fi while using Wireless Direct. To use the Internet, connect using Infrastructure mode.

## Turning the Wireless Function On or Off

To turn the wireless function on or off, press the  (Wi-Fi) button.

- 1 Press the  (Wi-Fi) button. The wireless function is now on.
- 2 Press the  (Wi-Fi) button again to turn the wireless function off.



### Note

- If [Off] is selected in the [Direct Mode On/Off] and [Infrastructure Mode On/Off] screen, the wireless function will remain off even if you press the  (Wi-Fi) button. (The factory setting is "On" for both Direct mode and Infrastructure mode.) For more information see *Connecting the machine to a Mobile Device* on page 73 or *Infrastructure Mode* on page 63.
- When the wireless function is on, the Li-ion battery power will decrease quickly. To change the power source, connect the AC adapter.

# Printing from a Mobile Device

## Printing from Your Mobile Device

- 1 Start the application (Mobile Cable Label Tool/Brother iPrint&Label) on your mobile device. (See *Available Applications* on page 73.)



**Note**

Make sure that the machine is connected to your mobile device.  
See *Connecting the machine to a Mobile Device* on page 73.

- 2 Select a label template or design.



**Note**

You can also select a label or image you designed previously, and print it.

- 3 Check the cutting option. (See *Cutting Options* on page 76.)
- 4 Tap **[Print]** in the application menu.

### Cutting Options

The cutting options allow you to specify how the item is fed and cut when it is printed. Use the printing option to select the cutting option when printing from the mobile device using the application.

See the following table for a list of all available settings:

**Tape Cut Option Table**

Auto Cut	Half Cut	Chain Printing	Image
No	Yes	No	
Yes	Yes	No	
No	No	No	

**Tape Cut Option Table**

Auto Cut	Half Cut	Chain Printing	Image
Yes	No	No	
No	Yes	Yes	
Yes	Yes	Yes	
No	No	Yes	
Yes	No	Yes	
Special tape			
No (FLe Label) (Mobile Cable Label Tool only)	—	—	

### Tape Cut Option Table

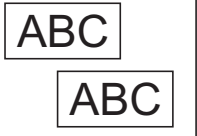
Auto Cut	Half Cut	Chain Printing	Image
Yes (FLe Label) (Mobile Cable Label Tool only)	—	—	



**Note**

- When printing multiple copies of different labels, you can select the chain printing option to reduce the blank space between the labels. (See the *Tape Cut Option Table*.)
- When using the chain printing option, press the  (Feed and Cut) button after the last label is printed.

### Using a Mobile Device to Print Templates Created on a Computer

You can use P-touch Transfer Manager to save template data, which was created using P-touch Editor, in the BLF format. Then, you can use Mobile Transfer Express to send the saved file from your mobile device to the machine and print the file.

- 1 Save the template data in the BLF format using P-touch Transfer Manager. For more information, see *Creating a BLF File* on page 144.
- 2 Use one of the following methods to use a .blf file with your mobile device.
  - Save the file using a cloud storage service, and then use the sharing function of the mobile device's OS to share the file.
  - Send the file as an email attachment from the computer to the mobile device, and then save the file to the mobile device.
- 3 Connect the machine to your mobile device, and then start Mobile Transfer Express. The template data appears.
- 4 Select the template that you want to print, and then transfer the template to the machine.



**Note**

To download a file from a cloud storage service to your mobile device, you must connect your mobile device using Infrastructure Mode. Therefore, if you also connect your mobile device to the machine using Infrastructure Mode, you can quickly transfer downloaded files.

- 5 Use the keyboard LCD unit of the machine to select the template that you want to print from the transferred file and print it.

## Attaching Labels

---

- 1 If needed, trim the printed label to the shape and length you want with scissors.
- 2 Peel the backing from the label.
- 3 Position the label, and then press firmly from top to bottom with your finger to attach the label.



### Note

---

- The backing of some types of tapes may be pre-cut to make it easier to peel the backing. To remove the backing, simply fold the label lengthwise with the text facing inwards, to expose the inside edges of the backing. Next, peel off the backing one piece at a time.
  - Labels may be difficult to attach to surfaces that are wet, dirty, or uneven. The labels may peel off easily from these surfaces.
  - Extra Strength Adhesive Tape:
    - For rough and textured surfaces, we recommend using Extra Strength Adhesive Tape.
  - Be sure to read the instructions provided with Fabric Tapes, Extra Strength Adhesive Tapes or other special tapes and observe all precautions noted in the instructions.
-

## Printer Setting Tool for Windows<sup>®</sup>

Using the “**Printer Setting Tool**”, you can specify the machine's communication settings or device settings from a computer.



### Note

The “**Printer Setting Tool**” is installed automatically when you use the initial installer to install the printer driver. For more information, see *Installing the Printer Driver and Software* on page 62.



### Important

The “**Printer Setting Tool**” is available only with compatible Brother machines.

## Before Using the Printer Setting Tool

- Make sure the AC adapter is connected to the machine and to an electrical socket, or a fully-charged battery is installed.
- Make sure the printer driver has been installed correctly and you can print.
- Connect this machine to a computer with a USB cable. Settings cannot be specified using Wi-Fi using this tool.

## Using the Printer Setting Tool for Windows®

- 1 Connect the machine you want to configure to the computer.
- 2 Start the Printer Setting Tool.
  - **For Windows Vista® / Windows® 7 / Windows Server® 2008 / Windows Server® 2008 R2:**  
From the Start button, click [All Programs] - [Brother] - [Label & Mobile Printer] - [Printer Setting Tool].
  - **For Windows® 8 / Windows® 8.1 / Windows Server® 2012 / Windows Server® 2012 R2:**  
Click the [Printer Setting Tool] icon on the [Apps] screen.
  - **For Windows® 10:**  
From the Start button, select [All apps], and then click [Brother] - [Label & Mobile Printer] - [Printer Setting Tool].The main window appears.

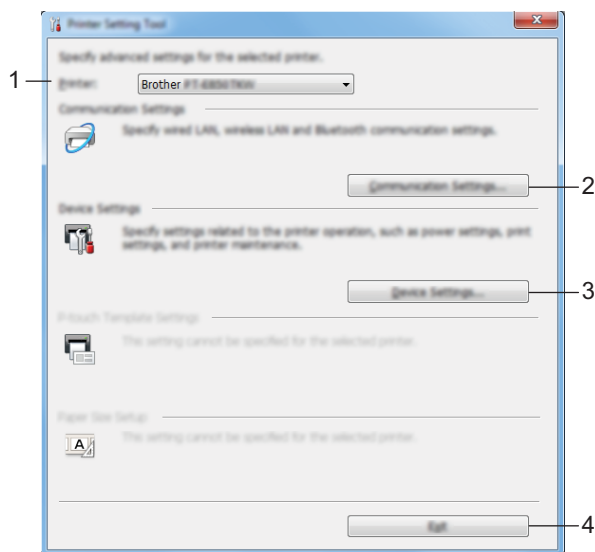

- 1 Printer**  
Lists the connected machines.
- 2 Communication settings**  
Specifies wireless LAN communication settings.
- 3 Device Settings**  
Specifies machine device settings, such as power settings and machine settings.
- 4 Exit**  
Closes the window.

- 3 Check that the machine you want to configure appears next to **[Printer]**. If a different machine appears, select the machine you want from the drop-down list.



**Note**

---

If only one machine is connected, it is unnecessary to make a selection because only that machine is available.

---

- 4 Select the setting you want to change, and then specify or change the settings in the dialog box. For more information on the settings dialog boxes, see *Communication Settings for Windows*<sup>®</sup> on page 83 or *Device Settings for Windows*<sup>®</sup> on page 96.
- 5 Click **[Apply]** - **[Exit]** in the settings dialog box to apply the settings to the machine.
- 6 Click **[Exit]** in the main window to finish specifying settings.



**Important**

---

Use the “**Printer Setting Tool**” to configure the machine only when the machine is in standby. The machine may malfunction if you try to configure it while it is handling a job.

---

# Communication Settings for Windows®

With [Communication settings] in the “Printer Setting Tool”, the machine communication information can be specified or changed when connecting the machine and computer with a USB cable. Not only can you change the communication settings for one machine, but you can also apply the same settings to multiple machines.

## Settings Dialog Box

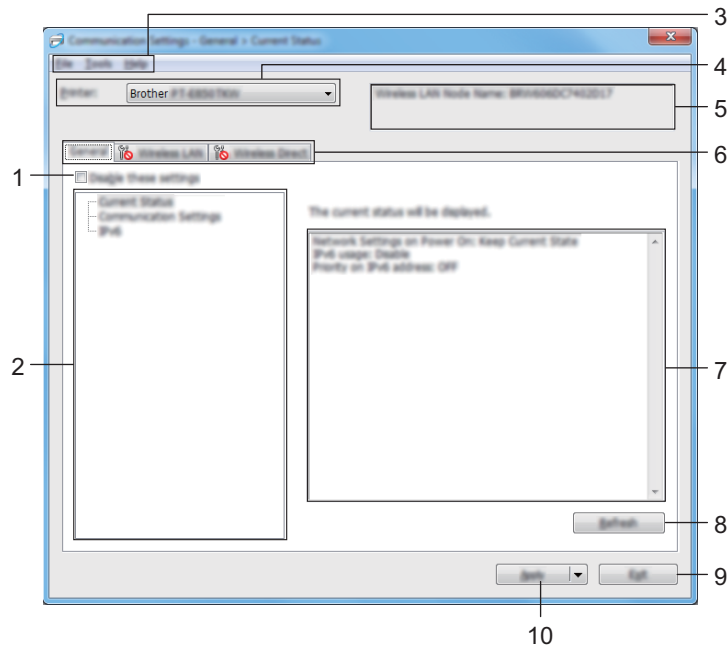

### 1 Disable these settings

When this check box is selected,  appears in the tab, and the settings can no longer be specified or changed.

Settings in a tab where  appears will not be applied to the machine even if [Apply] is clicked. In addition, the settings in the tab will not be saved or exported when the [Save in Command File] or [Export] command is executed.

To apply the settings to the machine or save or export them, make sure you clear the check box.

### 2 Items

When [Current Status] is selected, the current settings appear in the settings display/change area. Select the item for the settings that you want to change.

### 3 Menu Bar

### 4 Printer

Lists the connected machines.

### 5 Node Name

Displays node name (nodes can be renamed).

## 6 Settings Tabs

Contains settings that may be specified or changed.

If  appears in the tab, the settings in that tab will not be applied to the machine.

## 7 Settings Display/Change Area

Displays the current settings for the selected item.

## 8 Refresh

Updates the displayed settings with the most recent information.

## 9 Exit

Exits [**Communication settings**], and returns to the main window of the “**Printer Setting Tool**”.

### Important

---

Settings are not applied to machines if [**Exit**] is clicked without clicking [**Apply**] after changing settings.

---

## 10 Apply

Applies the settings to the machine.

To save the specified settings in a command file, select [**Save in Command File**] from the drop-down list. The saved command file can be used with the mass storage mode to apply the settings to a machine. (See *Mass Storage Mode* on page 117.)

### Important

---

Clicking [**Apply**] applies all settings in all tabs to the machine.

If the [**Disable these settings**] check box is selected, the settings in that tab are not applied.

---

## Menu Bar

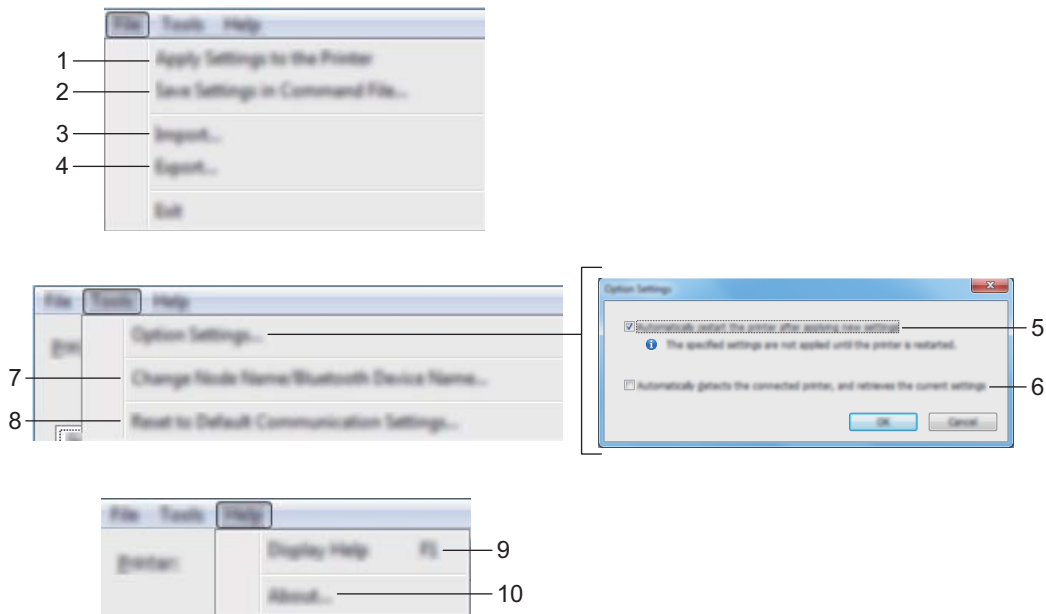

### 1 Apply Settings to the Printer

Applies the settings to the machine.

### 2 Save Settings in Command File

Saves the specified settings in a command file. The file extension is .bin.

The saved command file can be used with the mass storage mode to apply the settings to a machine. (See *Mass Storage Mode* on page 117.)



#### Note

If the [**Disable these settings**] check box is selected, the settings in that tab are not saved.

#### ! Important

- The following information is not saved with the command file:
  - Node name
  - IP address, subnet mask and default gateway (when the IP address is set to [**STATIC**])
- The saved communication settings commands are intended to be used only for applying settings to a machine. To apply the settings to the machine using this command file, use the mass storage mode.
- Saved command files contain authentication keys and passwords. Take necessary measures to protect saved command files, such as saving them in a location that cannot be accessed by other users.
- Do not send the command file to a different machine model.

### 3 Import

#### ■ Import from the current computer wireless settings

Imports the settings from the computer.



#### Note

- When importing the computer wireless settings, administrator privileges for the computer are needed.
- Only personal security authentication settings (open system, public key authentication and WPA/WPA2-PSK) can be imported. Enterprise security authentication (such as LEAP and EAP-FAST), WPA2-PSK (TKIP) and WPA-PSK (AES) settings cannot be imported.
- If multiple wireless LANs are enabled for the computer you use, the first wireless settings (only personal settings) that are detected will be considered for the import data.
- Only the settings (communication mode, SSID, authentication method, encryption mode and authentication key) from the **[Wireless LAN]** tab - **[Wireless Settings]** pane can be imported.

#### ■ Select a Profile to import

Imports the exported file and applies the settings to a machine.

Click **[Browse]** and select the file you want to import. The settings in the selected file appear in the settings display/change area.



#### Note

- All settings, such as wireless settings or TCP/IP settings, can be imported, except for node names.
- Only profiles that are compatible with the selected machine can be imported.
- If the imported profile's IP address is set to **[STATIC]**, change the IP address of the imported profile, if needed, so that it does not duplicate the IP address of an existing configured machine on the network.

### 4 Export

Saves the current settings in a file.



#### Note

If the **[Disable these settings]** check box is selected, the settings in that tab are not saved.



#### Important

Exported files are not encrypted.

### 5 Automatically restart the printer after applying new settings

If this check box is selected, the machine automatically restarts after communication settings are applied.

If this check box is cleared, you must restart the machine manually.



#### Note

When configuring multiple machines, you can reduce the time needed to change settings by clearing this check box. In this case, we recommend selecting this check box when configuring the first machine so that you can confirm that each setting is operating as intended.

## **6 Automatically detects the connected printer, and retrieves the current settings**

If this check box is selected and a machine is connected to the computer, the machine is automatically detected and the machine's current settings are displayed in the [**Current Status**] pane.



### **Note**

If the model of the connected machine is different from that of the machine shown in the [**Printer**] drop-down list, the settings available on all tabs change to match the connected machine.

## **7 Change Node Name/Bluetooth Device Name**

Allows renaming a node.

## **8 Reset to Default Communication Settings**

Returns the communication settings to their factory settings.

## **9 Display Help**

Displays the Help.

## **10 About**

Displays the version information.

## General Tab

### Communication Settings

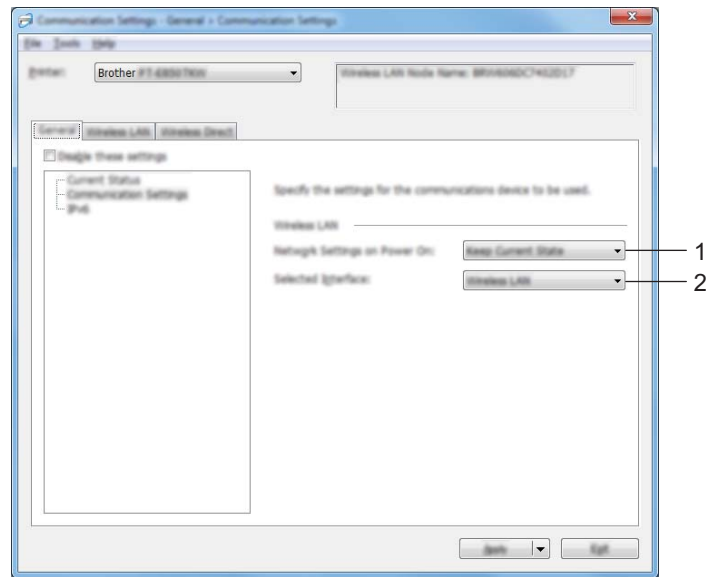

#### 1 Network Settings on Power On

Specifies the conditions for connecting via Wi-Fi when the machine is turned on. Select [**On by Default**], [**Off by Default**] or [**Keep Current State**].

#### 2 Selected Interface

Select [**Infrastructure or Ad-hoc**], [**Infrastructure and Wireless Direct**] or [**Wireless Direct**].

## IPv6

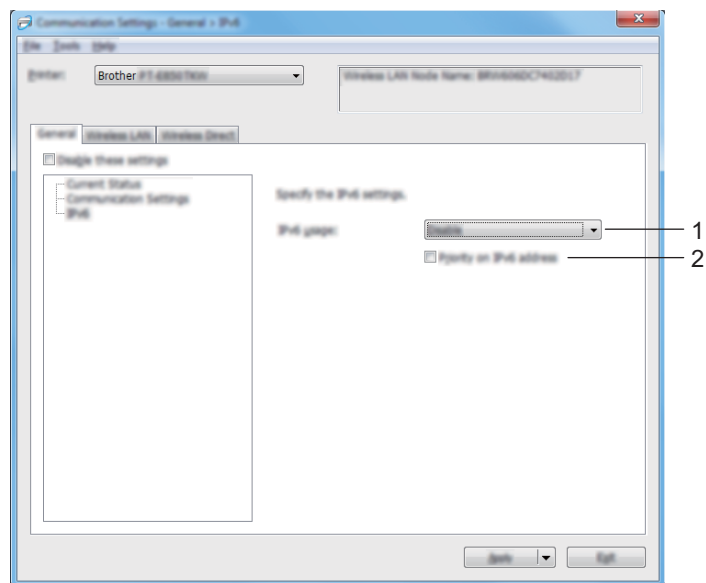

### 1 IPv6 usage

Select **[Enable]** or **[Disable]**.

### 2 Priority on IPv6 address

Select to give priority to an IPv6 address.

## Wireless LAN Tab

### TCP/IP (Wireless)

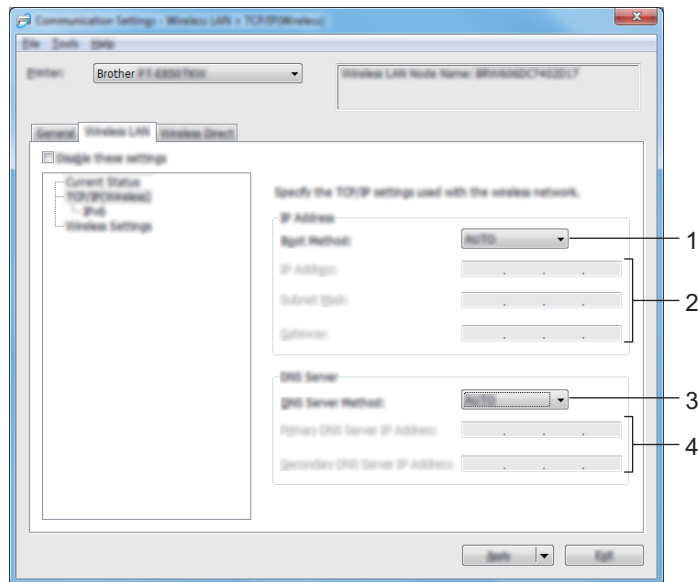

#### 1 Boot Method

Select [AUTO], [BOOTP], [DHCP], [RARP] or [STATIC].

#### 2 IP Address/Subnet Mask/Gateway

Specifies the various networking values.

You can enter these settings only when the IP address is set to [STATIC].

#### 3 DNS Server Method

Select [AUTO] or [STATIC].

#### 4 Primary DNS Server IP Address/Secondary DNS Server IP Address

You can enter these settings only when the DNS server is set to [STATIC].

## IPv6

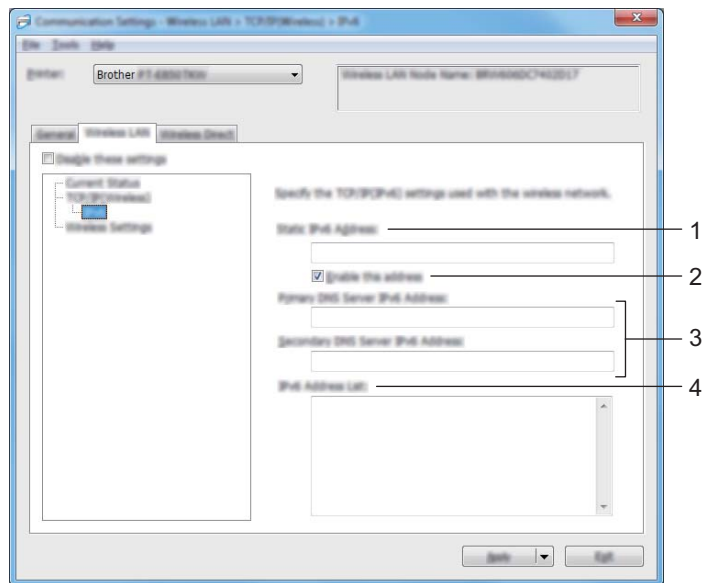

### 1 Static IPv6 Address

Specifies a permanent IPv6 address.

### 2 Enable this address

Enables the specified static IPv6 address.

### 3 Primary DNS Server IPv6 Address/Secondary DNS Server IPv6 Address

Specifies the DNS server IPv6 addresses.

### 4 IPv6 Address List

Displays the list of IPv6 addresses.

## Wireless Settings

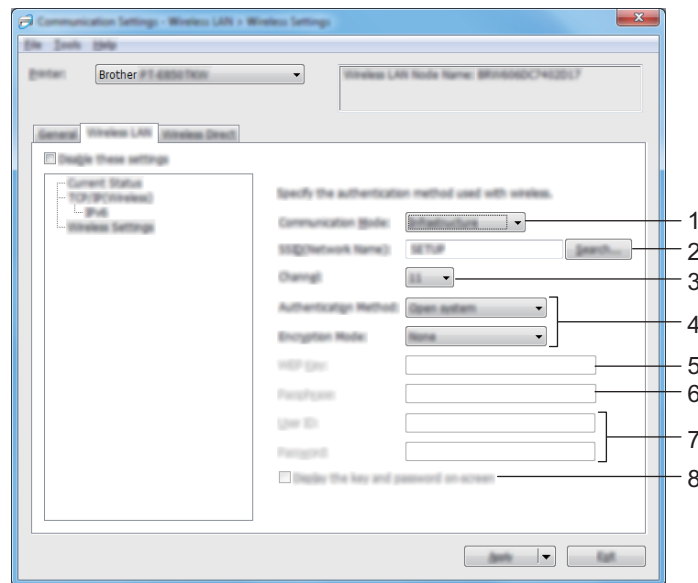

### 1 Communication Mode

Select [**Infrastructure**] or [**Ad-hoc**].

### 2 SSID (Network Name)

Clicking [**Search**] displays the available SSID selections in a separate dialog box.

### 3 Channel

Lists available channels.



### Note

This setting is valid only in Ad-Hoc mode.

### 4 Authentication Method/Encryption Mode

The supported encryption modes for the authentication methods are as shown in *Communication Modes and Authentication Methods/Encryption Modes* on page 93.

### 5 WEP Key

You can specify a setting only when WEP is selected as the encryption mode.

### 6 Passphrase

You can specify a setting only when WPA/WPA2-PSK is selected as the authentication method.

### 7 User ID/Password

You can specify settings only when LEAP, EAP-FAST, PEAP, EAP-TTLS or EAP-TLS is selected as the authentication method. In addition, with EAP-TLS, it is not necessary to register a password, but a client certificate must be registered. To register a certificate, connect to the machine from a web browser, and then specify the certificate. For more information on using a web browser, see *Web Based Management* on page 178.

### 8 Display the key and password on-screen

If this check box is selected, keys and passwords are displayed in plain (non-encrypted) text.

## Communication Modes and Authentication Methods/Encryption Modes

- When [Communication Mode] is set to [Ad-hoc]

Authentication Method	Encryption Mode
Open System	None / WEP

- When [Communication Mode] is set to [Infrastructure]

Authentication Method	Encryption Mode
Open System	None / WEP
Shared Key	WEP
WPA/WPA2-PSK	TKIP+AES / AES
LEAP	CKIP
EAP-FAST/NONE	TKIP+AES / AES
EAP-FAST/MS-CHAPv2	TKIP+AES / AES
EAP-FAST/GTC	TKIP+AES / AES
PEAP/MS-CHAPv2	TKIP+AES / AES
PEAP/GTC	TKIP+AES / AES
EAP-TTLS/CHAP	TKIP+AES / AES
EAP-TTLS/MS-CHAP	TKIP+AES / AES
EAP-TTLS/MS-CHAPv2	TKIP+AES / AES
EAP-TTLS/PAP	TKIP+AES / AES
EAP-TLS	TKIP+AES / AES

### ! Important

To specify higher level security settings:

When performing certificate verification with EAP-FAST, PEAP, EAP-TTLS or EAP-TLS authentication methods, the certificate cannot be specified from the "**Printer Setting Tool**". After the machine is configured to connect to the network, specify the certificate by accessing the machine from a web browser.

For more information on using a web browser, see *Web Based Management* on page 178.

## Wireless Direct Tab

### Wireless Direct Settings

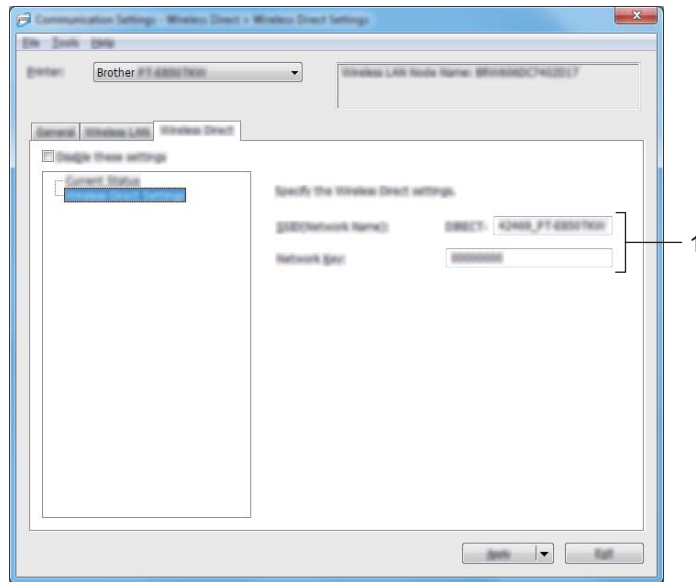

#### 1 SSID (Network Name)/Network Key

Specifies the SSID (25 ASCII characters or fewer) and the network key (63 characters or fewer) you want to use in the Wireless Direct mode.



#### Note

The factory settings for the SSID and password are as follows:

SSID: "PT-D800W" or "DIRECT-\*\*\*\*\*\_PT-D800W". "\*\*\*\*\*" is the last five digits of the product serial number.

Password (Network key): 00000000

## Applying Setting Changes to Multiple Machines

---

- 1 After applying settings to the first machine, disconnect the machine from the computer, and then connect the second machine to the computer.
- 2 Select the newly connected machine from the [**Printer**] drop-down list.

 **Note**

If the [**Automatically detects the connected printer, and retrieves the current settings**] check box in the [**Option Settings**] dialog box is selected, the machine connected with the USB cable is automatically selected.

For more information, see *Communication Settings for Windows*<sup>®</sup> on page 83.

---

- 3 Click [**Apply**].  
The same settings that were applied to the first machine are applied to the second machine.

 **Note**

We recommend selecting the [**Automatically restart the printer after applying new settings**] check box when configuring the first machine so that you can confirm that a connection with the wireless access point/router can be correctly established with the settings. For more information, see *Communication Settings for Windows*<sup>®</sup> on page 83.

---

- 4 Repeat steps 1 – 3 for all machines whose settings you want to change.

 **Important**

If the IP address is set to [**STATIC**], the machine's IP address will also be changed to the same address as the first machine.  
Change the IP address if needed.

---

 **Note**

To save the current settings in a file, click [**File**] - [**Export**].

The same settings can be applied to another machine by clicking [**File**] - [**Import**], then selecting the exported settings file. (See *Communication Settings for Windows*<sup>®</sup> on page 83.)

---

## Device Settings for Windows®

With [Device Settings] in the “Printer Setting Tool”, machine settings can be specified or changed when connecting the machine and computer with a USB cable. Not only can you change the device settings for one machine, but you can also apply the same settings to multiple machines.

When printing from a computer application, various printing settings can be specified from the printer driver; however, by using [Device Settings] in the “Printer Setting Tool”, more advanced settings can be specified.

When [Device Settings] is opened, the machine's current settings are retrieved and displayed. If the current settings could not be retrieved, the previous settings are displayed. If the current settings could not be retrieved and previous settings have not been specified, this tool's factory settings are displayed.

### Settings Dialog Box

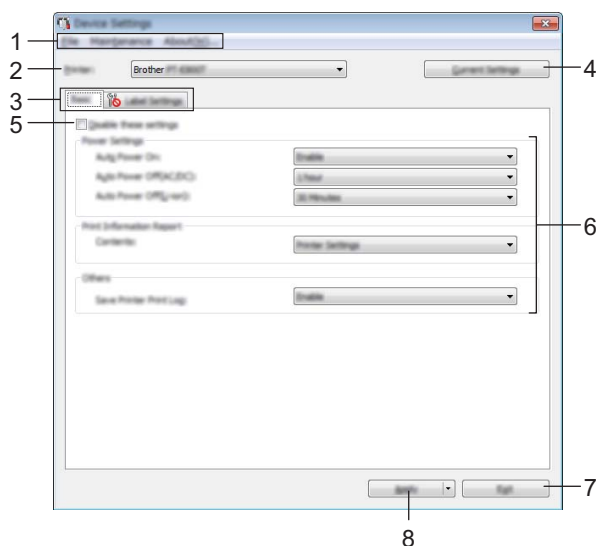

#### 1 Menu Bar

Select a command contained in each menu from the list.

#### 2 Printer

Specifies the machine whose device settings are to be configured.

If only one machine is connected, it is unnecessary to make a selection since only that machine will appear.

#### 3 Settings Tabs

Contains settings that may be specified or changed.



#### Note

If  appears in the tab, the settings in that tab cannot be specified or changed. In addition, the settings in the tab will not be applied to the machine even if [Apply] is clicked. The settings in the tab will also not be saved or exported when the [Save in Command File] or [Export] command is executed.

#### 4 Current Settings

Retrieves the settings from the currently connected machine and displays them in the dialog box. Settings will also be retrieved for parameters on tabs with .

#### 5 Disable these settings

When this check box is selected,  appears in the tab, and the settings can no longer be specified or changed.

Settings in a tab where  appears will not be applied to the machine even if [**Apply**] is clicked. In addition, the settings in the tab will not be saved or exported when the [**Save in Command File**] or [**Export**] command is executed.

#### 6 Parameters

Displays the current settings.

#### 7 Exit

Exits [**Device Settings**], and returns to the main window of the “**Printer Setting Tool**”.

#### 8 Apply

Applies the settings to the machine.

To save the specified settings in a command file, select [**Save in Command File**] from the drop-down list. The saved command file can be used with the mass storage mode to apply the settings to a machine. (See *Mass Storage Mode* on page 117.)

## Menu Bar

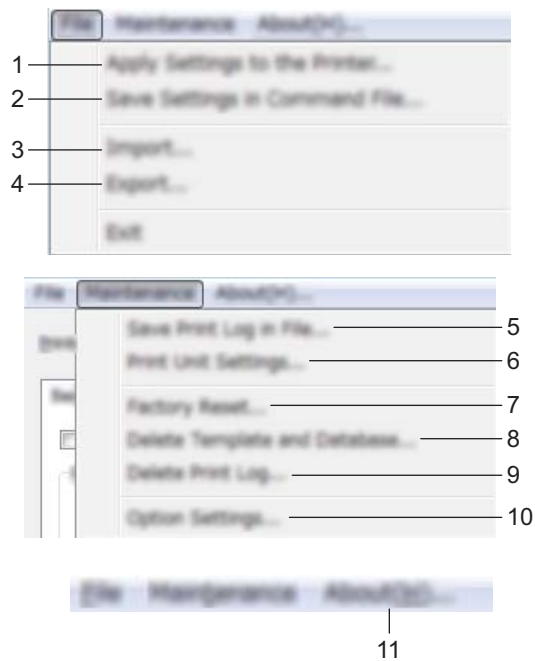

### 1 Apply Settings to the Printer

Applies the settings to the machine.

Performs the same operation as when **[Apply]** is clicked.

### 2 Save Settings in Command File

Saves the specified settings in a command file.

Performs the same operation as when **[Save in Command File]** is selected from the **[Apply]** drop-down list.

### 3 Import

Imports the exported file.

### 4 Export

Saves the current settings in a file.

### 5 Save Print Log in File

Saves the print log in a file in the CSV format.

### 6 Print Unit Settings

Prints a report containing firmware version and device setting information.

You can also print this report using the  (Feed and Cut) button for more than 10 seconds. See *Confirming the P-touch Labelling Machines Settings* on page 110 for more information.



### Note

When you print this report, use 24 mm or 36 mm tape.

## **7 Factory Reset**

Resets all machine settings to factory settings.

## **8 Delete Template and Database**

Deletes the templates and databases stored in the machine.

## **9 Delete Print Log**

Deletes the print log stored in the machine.

## **10 Option Settings**

If the [**Do not display an error message if the current settings cannot be retrieved at startup**] check box is selected, a message will not be displayed next time.

## **11 About**

Displays the version information.

## Basic Tab

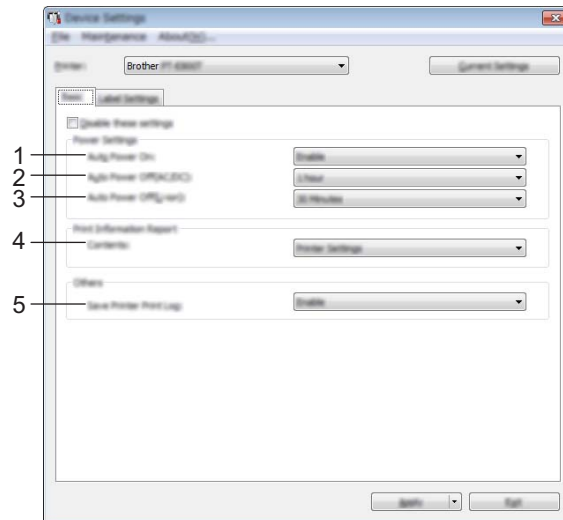

### 1 Auto Power On

Specifies whether or not the machine turns on automatically when the power supply cord is plugged into an electrical socket.

Available settings: **[Disable]**, **[Enable]**

### 2 Auto Power Off (AC/DC)

Specifies the period of time that passes before the machine turns off automatically when connected to an electrical socket.

Available settings: **[None]**, 10/20/30/40/50 Minutes, 1/2/4/8/12 hours

### 3 Auto Power Off (Li-ion)

Specifies the amount of time that passes before the machine turns off automatically when powered by the rechargeable Li-ion battery.

Available settings: **[None]**, 10/20/30/40/50 Minutes, 1 hour

### 4 Contents

Specifies the machine information that will be printed.

Available settings: **[All]**, **[Usage Log]**, **[Printer Settings]**, **[Printer Transfer Data]**

### 5 Save Printer Print Log

Select whether or not to save the machine's print log. If **[Disable]** is applied to the machine, **[Maintenance]** - **[Save Print Log in File]** does not work.

Available settings: **[Enable]**, **[Disable]**

## Label Settings Tab

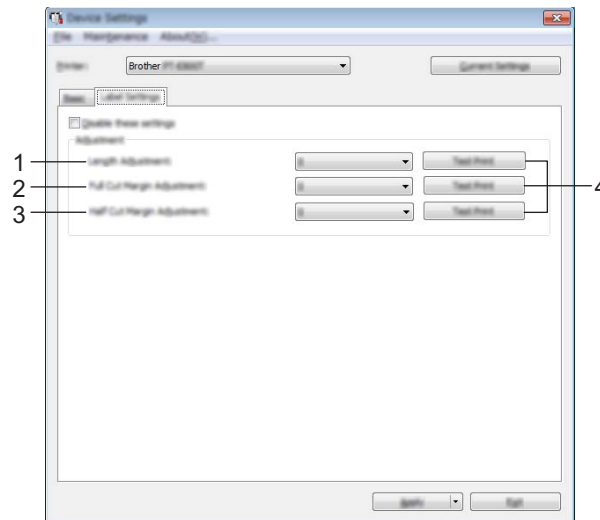

### 1 Length Adjustment

Adjusts the length of the printed label to correspond to the length of the label displayed on the computer.  
Available settings: -4 to +4 (1 increments)

### 2 Full Cut Margin Adjustment

Adjusts the margin length when fully cutting labels.  
Available settings: -2 to +2 (1 increments)

### 3 Half Cut Margin Adjustment

Adjusts the margin length when half-cutting labels.  
Available settings: -2 to +2 (1 increments)

### 4 Test Print

Prints a test label to check the results of each adjustment.

## Applying Setting Changes to Multiple Machines

---

- 1 After applying settings to the first machine, disconnect the machine from the computer, and then connect the second machine to the computer.
- 2 Select the newly connected machine from the **[Printer]** drop-down list.
- 3 Click **[Apply]**.  
The same settings that were applied to the first machine are applied to the second machine.
- 4 Repeat steps 1 – 3 for all machines whose settings you want to change.



### Note

---

To save the current settings in a file, click **[File]** - **[Export]**.

The same settings can be applied to another machine by clicking **[File]** - **[Import]**, and then selecting the exported settings file. (See *Device Settings for Windows*<sup>®</sup> on page 96.)

---

## Printer Setting Tool for Mac

Using the “**Printer Setting Tool**”, you can specify the machine’s communication settings and device settings from a Mac. Not only can you change the device settings for one machine, but you can also apply the same settings to multiple machines.



### Note

The “**Printer Setting Tool**” is installed automatically when you use the initial installer to install the printer driver. For more information, see *Installing the Printer Driver and Software* on page 62.



### Important

The “**Printer Setting Tool**” is available only with compatible Brother machines.

## Before Using the Printer Setting Tool

- Make sure the AC adapter is connected to the machine and to an electrical socket, or a fully-charged battery is installed.
- Make sure the printer driver has been installed correctly and you can print.
- Connect this machine to a computer with a USB cable. Settings can be specified only via USB using this tool.

## Using the Printer Setting Tool for Mac

- 1 Connect the machine you want to configure to the computer.
- 2 Click **[Macintosh HD]** - **[Applications]** - **[Brother]** - **[Printer Setting Tool]** - **[Printer Setting Tool.app]**. The **[Printer Setting Tool]** window appears.
- 3 Check that the machine you want to configure appears next to **[Printer]**. If a different machine appears, select the machine you want from the drop-down list.



### Note

If only one machine is connected, it is unnecessary to make a selection because only that machine will appear.

- 4 Select a setting tab, and then specify or change the settings.
- 5 Click **[Apply Settings to the Printer]** in the setting tab to apply the settings to the machine.
- 6 Click **[Exit]** to finish specifying settings.



### Important

Use the Printer Setting Tool to configure the machine only when the machine is in standby. The machine may malfunction if you try to configure it while it is handling a job.

## Settings Dialog Box

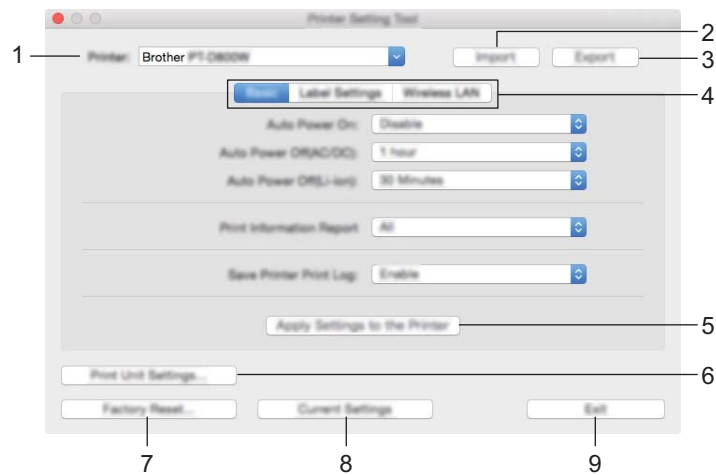

### 1 Printer

Lists the connected machines.

### 2 Import

Imports settings from a file.

### 3 Export

Saves the current settings in a file.

### 4 Setting Tabs

Contain settings that may be specified or changed.

### 5 Apply Settings to the Printer

Applies the settings to the machine.

### 6 Print Unit Settings

Prints a report containing firmware version and configuration information.

You can also print this report using the ⌘ (Feed and Cut) button for more than 10 seconds. See *Confirming the P-touch Labelling Machines Settings* on page 110 for more information.



### Note

When you print this report, use 24 mm or 36 mm tape.

### 7 Factory Reset

Resets machine settings to factory settings.

### 8 Current Settings

Retrieves the settings from the currently connected machine and displays them in the dialog box.

### 9 Exit

Exits the Printer Setting Tool.

## Basic Tab

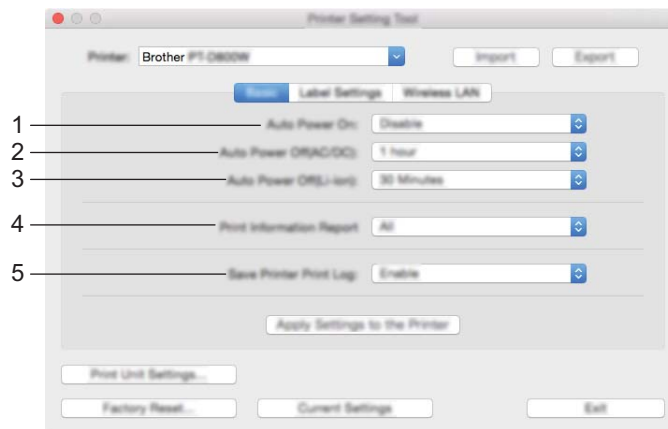

### 1 Auto Power On

Specifies whether the machine turns on automatically when the power supply cord is plugged into an electrical socket.

Available settings: **[Disable]**, **[Enable]**

### 2 Auto Power Off (AC/DC)

Specifies the period of time that passes before the machine turns off automatically when connected to an electrical socket.

Available settings: **[None]**, 10/20/30/40/50 Minutes, 1/2/4/8/12 hours

### 3 Auto Power Off (Li-ion)

Specifies the period of time that passes before the machine turns off automatically when powered by the rechargeable Li-ion battery.

Available settings: **[None]**, 10/20/30/40/50 Minutes, 1 hour

### 4 Print Information Report

Specifies the machine information that will be printed.

Available settings: **[All]**, **[Usage Log]**, **[Printer Settings]**, **[Printer Transfer Data]**

### 5 Save Printer Print Log

Select whether or not to save the machine's print log.

Available settings: **[Enable]**, **[Disable]**

## Label Settings Tab

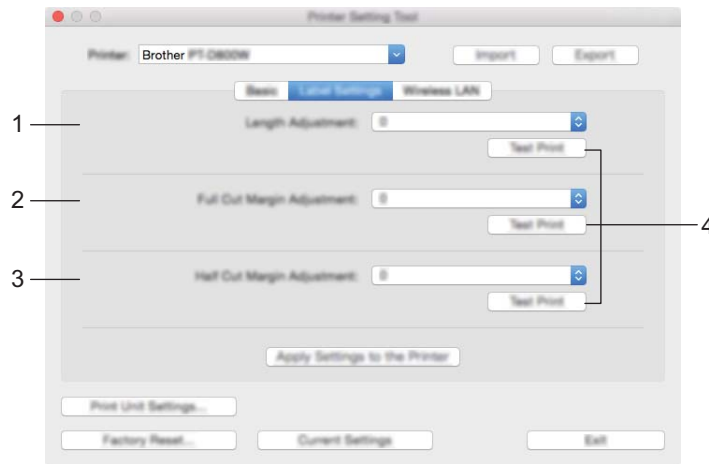

### 1 Length Adjustment

Adjusts the length of the printed label to correspond to the length of the label displayed on the computer.  
Available settings: -4 to +4 (1 increments)

### 2 Full Cut Margin Adjustment

Adjusts the margin length when fully cutting labels.  
Available settings: -2 to +2 (1 increments)

### 3 Half Cut Margin Adjustment

Adjusts the margin length when half-cutting labels.  
Available settings: -2 to +2 (1 increments)

### 4 Test print

Prints a test label to check the results of each adjustment.

## Wireless LAN Tab

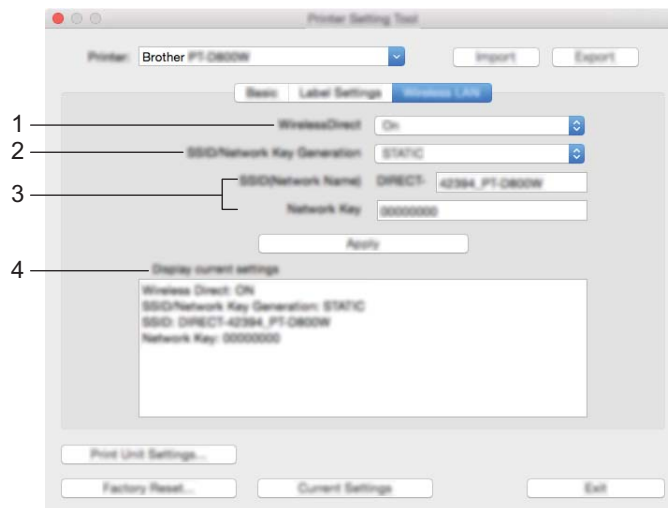

### 1 WirelessDirect

Turns the Wireless Direct function on or off.

### 2 SSID/Network Key Generation

Select [AUTO] or [STATIC].

### 3 SSID (Network Name)/Network Key

Specifies the SSID (3 to 25 ASCII characters) and the network key you want to use in the Wireless Direct mode.

You can specify a setting only when [STATIC] is selected as [SSID/Network Key Generation].

### 4 Display current settings

Displays the current settings for Wireless Direct. Click [Current Settings] to update the displayed settings with the most recent information.

## Applying Setting Changes to Multiple Machines

---

- 1 After applying settings to the first machine, disconnect the machine from the computer, and then connect the second machine to the computer.
- 2 Select the newly connected machine from the [**Printer**] drop-down list.
- 3 Click [**Apply Settings to the Printer**].  
The same settings that were applied to the first machine are applied to the second machine.
- 4 Repeat steps 1 – 3 for all machines whose settings you want to change.



### Note

---

To save the current settings in a file, click [**Export**].

The same settings can be applied to another machine by clicking [**Import**], then selecting the exported settings file. (See *Settings Dialog Box* on page 104.)

---

## Changing Settings When Printing from a Mobile Device

If using a mobile device, change the settings as necessary using the application before printing.

The settings that can be changed vary according to the application.



### Note

---

Before connecting a mobile device, you can specify detailed settings by connecting the machine to a computer via USB and using the Printer Setting Tool (see *Using the Printer Setting Tool for Windows*<sup>®</sup> on page 81).

---

## Confirming the P-touch Labelling Machines Settings

You can print the settings report or display the setting information without connecting the machine to a computer or mobile device.

To print the basic settings report:

**Note**

This report contains the following information: The firmware version, device setting information, Wi-Fi setting information, and transferred data information (templates, databases and transferred symbols).

- 1 Turn the machine on.
- 2 Press and hold the >⌘ (Feed and Cut) button for more than 10 seconds to print the report.

**Note**

- When you print this report, use 24 mm or 36 mm tape.
- This operation can also be performed using the Printer Setting Tool (see *Changing the P-touch Labelling Machine Settings* on page 80).

# Printing Labels Distributed to Multiple Machines (Windows® only)

## Distributed Printing

When printing a large number of labels, printing can be distributed among multiple machines. Because printing is performed at the same time, the total printing time can be reduced.



### Note

- Printing can be distributed to machines connected via a USB or network connection.
- The number of pages is automatically divided among the selected machines. If the specified number of pages cannot be evenly divided among the machines, it will be divided in the order of the machines listed in the **[Distributed Printing Settings]** dialog box when the print settings are specified in step ④.

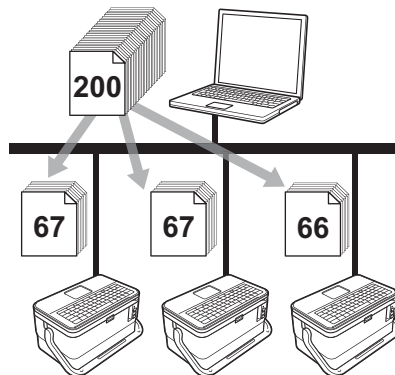

- ① From the **[File]** menu in P-touch Editor, click **[Print]**.
- ② Click **[Properties...]**.

- Click the **[Advanced]** tab, select the **[Distributed Printing]** check box, and then click **[Settings]**.

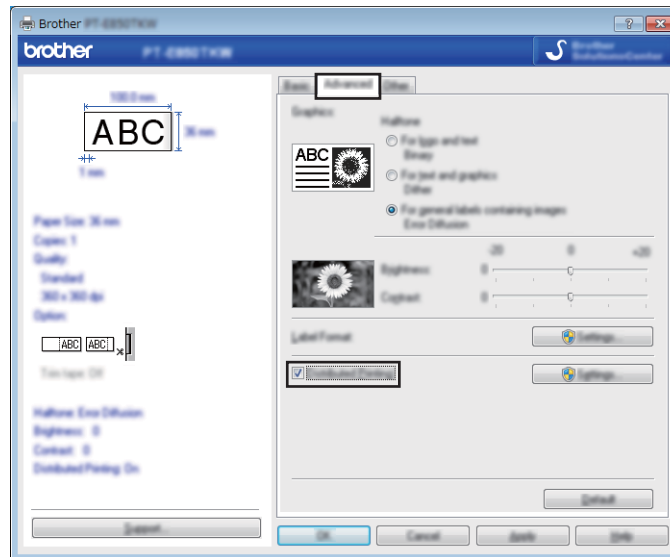

- In the **[Distributed Printing Settings]** dialog box, select the machines you want to use for distributed printing.

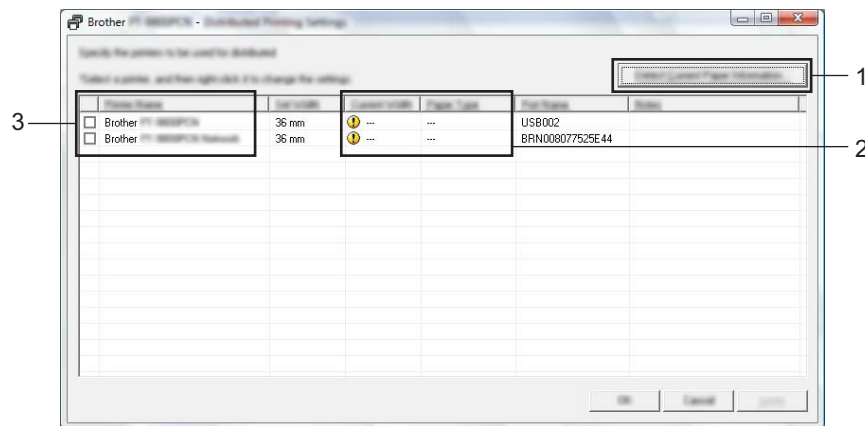

- Click **[Detect Current Paper Information...]**.
- The current printer information that was detected appears below **[Current Width]** and **[Paper Type]**.
- Select the check box next to the **[Printer Name]** you want.

**Note**

If the selected tape width is different from that displayed beside **[Current Width]**,  appears beside the setting below **[Current Width]**. Load the printer with tape of the width specified **[Set Width]**.

5 Specify the tape width.

**A. If only one machine has been selected.**

In the [**Distributed Printing Settings**] dialog box from step 4, select the machine whose setting you want to specify, and then either double-click it, or right-click it and then click [**Settings**]. From the [**Set Width**] drop-down list, select the tape width.



**Note**

Information displayed in the [**Distributed Printing Settings**] dialog box from step 4 can be entered in the [**Notes**] text box.

**B. If multiple machines have been selected.**

In the [**Distributed Printing Settings**] dialog box from step 4, select the machines whose settings you want to specify, right-click them, and then click [**Settings**]. From the [**Set Width**] drop-down list, select the tape width. The same tape width setting is applied to all selected machines.

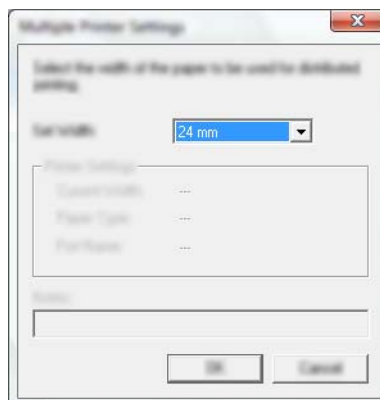

**Note**

The settings below [**Printer Settings**] and [**Notes**] are not available.

6 Click [**OK**] to close the tape width setting window.

7 Click **[OK]** to close the **[Distributed Printing Settings]** window. Setup is completed.

8 Click **[OK]** to start distributed printing.



**Note**

- 
- It may not be possible for information to be detected for a printer connected using a USB hub or print server. Before printing, enter the settings manually, and check if the machine can be used for printing.
  - Depending on whether a router is used and the security features in use, such as a firewall, it may not be possible to use this function.
  - We recommend performing a connection test for your operating environment. Contact your information technology manager or administrator for assistance.
-

## Printing Labels in High Resolution Mode

High resolution printing can be used if you are printing from a computer, the AC adapter is connected, and TZe laminated tape with black ink is installed. Use the printer driver to select the high resolution mode when printing the labels. You cannot use this function for TZe-FX\*\*1 tape.

- 1 From the **[File]** menu in P-touch Editor, click **[Print]**.
- 2 Click **[Properties...]**.
- 3 On the **[Basic]** tab, select **[High resolution]** from the **[Quality]** drop-down list.

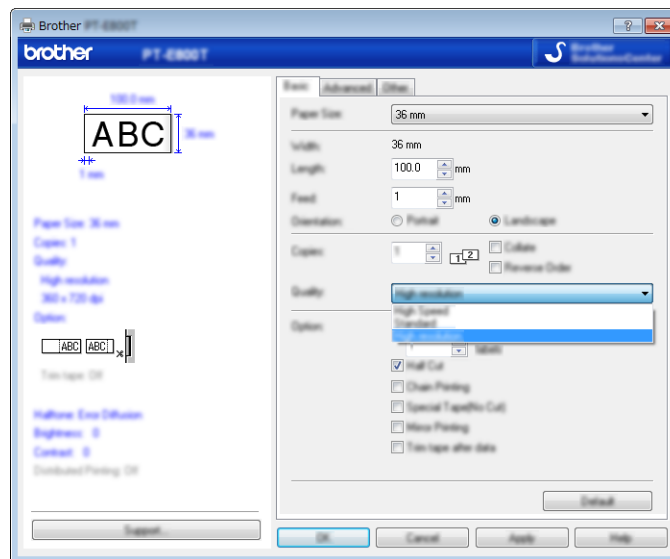

- 4 Click **[OK]**.

## Printing Labels in High Speed Mode

High speed printing can be used if you are printing from a computer, the AC adapter is connected, and TZe laminated tape with black ink is installed. Use the printer driver to select the high speed mode when printing the labels. You cannot use this function for TZe-FX\*\*1 tape.

- 1 From the **[File]** menu in P-touch Editor, click **[Print]**.
- 2 Click **[Properties...]**.
- 3 On the **[Basic]** tab, select **[High Speed]** from the **[Quality]** drop-down list.

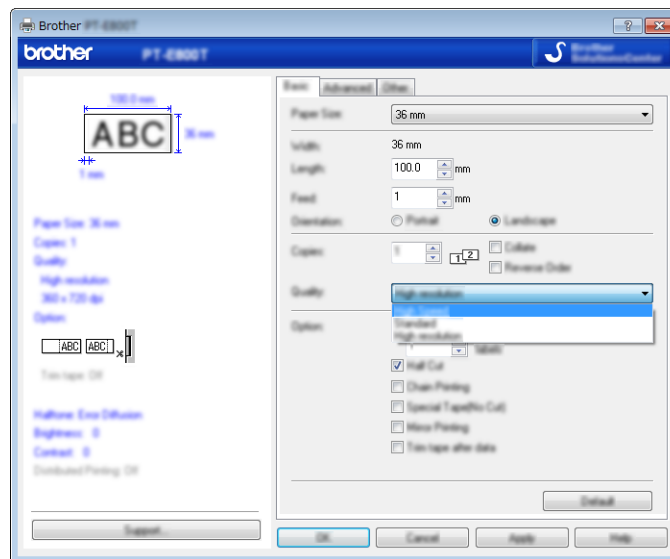

- 4 Click **[OK]**.

# Mass Storage Mode

## Description

---



The mass storage mode feature allows you to communicate with the machine with just a file via the USB interface without loading a printer driver. Files that have been copied to the machine's mass storage area are processed when you press the **Print** key.

This feature is useful for:

- Applying printer settings saved in a command file (.bin file format) or adding templates (.blf file format) into the machine distributed by the administrator without using any software tools.
- Executing commands without installing the printer driver.
- Using a device with an OS (including non-Windows<sup>®</sup> operating systems) that has a USB host feature to print and transmit data.

## Using the Mass Storage Mode

---

- 1 Confirm that the machine is turned off.
- 2 Press and hold the  (Power) button, the **Program** key, and the **Home** key at the same time. The machine starts up in mass storage mode, the  (Power) indicator lights in green and the  (Label) indicator lights in orange.
- 3 Connect the computer or device to the machine via USB. The machine's mass storage area appears as a folder on the computer or device's screen.





### Note

---

If the mass storage area does not appear automatically, refer to the operating instructions for the computer or device's operating system for information about displaying the mass storage area.

---

- 4 Drag and drop the file you want to copy to the mass storage area.
- 5 Press the **Print** key. The commands in the command file are executed, and the  (Label) indicator flashes once in green. When finished, the  (Label) indicator lights in orange.
- 6 To turn mass storage mode off, turn the machine off so that it starts in its normal operating mode.

---

**!** **Important**

- When the machine is turned off, mass storage mode is deactivated and any files in the mass storage area are deleted.
  - This feature supports .bin, and .blf files. Other file formats are not supported.
  - Do not create folders in the mass storage area. If a folder is created, files in the folder cannot be accessed.
  - The capacity of the mass storage area is 2.5 MB. Files larger than 2 MB may not work correctly.
  - If multiple files are copied, the order that the commands will be executed in cannot be guaranteed.
  - Wi-Fi features are not available while the machine is running in mass storage mode.
  - Do not access other files in the mass storage area when executing a copied file.
- 



---

**Note**

For more information on how to create a .blf file, see *Creating a BLF File* on page 144.

---



# Application for Windows<sup>®</sup>

---

<b>Using P-touch Software</b>	120
<b>How to Use Cable Label Tool</b>	121
<b>How to Use P-touch Editor</b>	130
<b>How to Use P-touch Transfer Manager</b>	134
<b>How to Use P-touch Library</b>	145
<b>Transferring Templates with P-touch Transfer Express</b>	151
<b>How to Update P-touch Software</b>	159

## Installing P-touch Software

You must install P-touch software and the printer driver to use your P-touch labelling machine with your computer.

Download the installer from [www.brother.com/inst](http://www.brother.com/inst).

For more information on installing the software and driver, see *Installing the Printer Driver and Software* on page 62.

To download the latest driver and software individually, visit the Brother Solutions Center at [support.brother.com](http://support.brother.com).

[Select your region/country.] - [Downloads] - [Choose your product]

## Starting Cable Label Tool

1 Start the Cable Label Tool.

- **For Windows Vista® / Windows® 7 / Windows Server® 2008 / Windows Server® 2008 R2:**  
From the Start button, click [All Programs] - [Brother P-touch] - [Cable Label Tool 1.0], or double-click [Cable Label Tool 1.0] shortcut icon on the desktop.

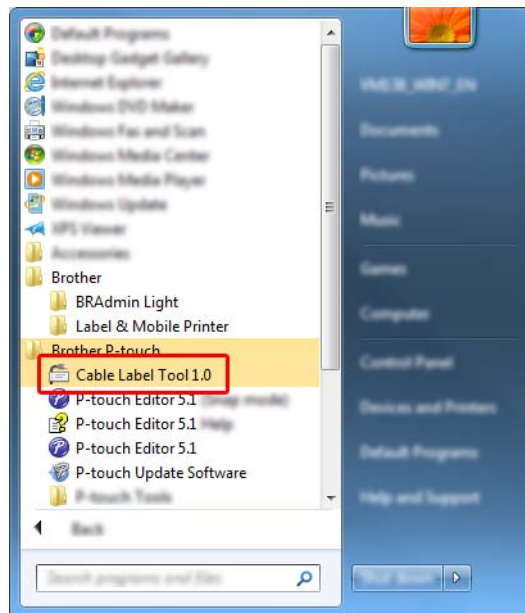

- **For Windows® 8 / Windows® 8.1 / Windows Server® 2012 / Windows Server® 2012 R2:**  
Click [Cable Label Tool 1.0] on the [Apps] screen or double-click [Cable Label Tool 1.0] on the desktop.
- **For Windows® 10:**  
From the Start button, select [All apps] and click [Cable Label Tool 1.0] under [Brother P-touch], or double-click [Cable Label Tool 1.0] on the desktop.

- 2 Click the button for the cable label type you want.

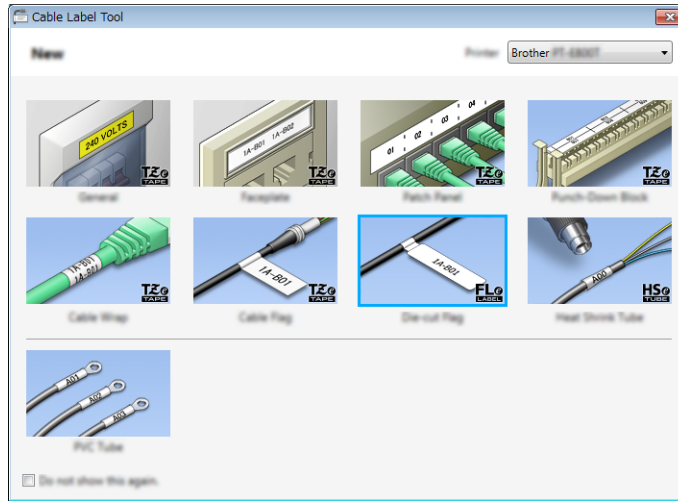

## Creating a Cable Label

### Faceplate

Labels of this type can be used to identify various faceplates. Blocks of text are evenly spaced on each label.

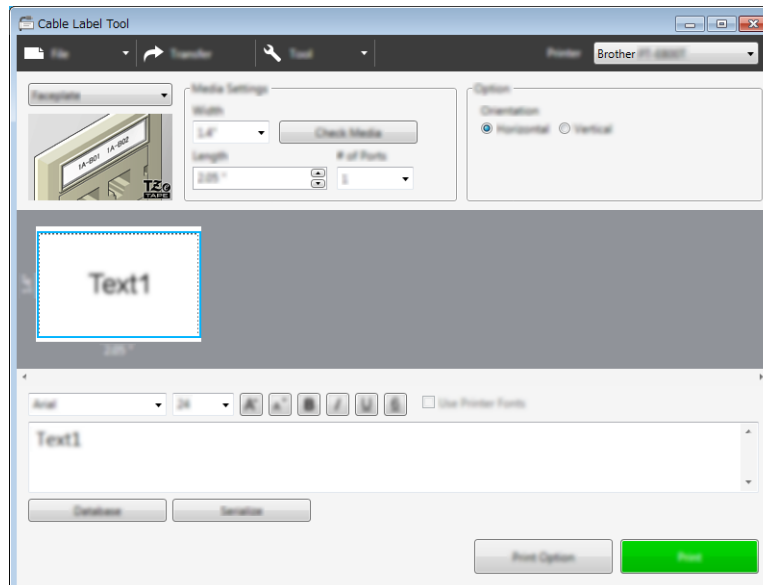

## Cable Wrap

Labels of this type can be wrapped around a cable or wire.

The text is rotated 90° counterclockwise and printed.

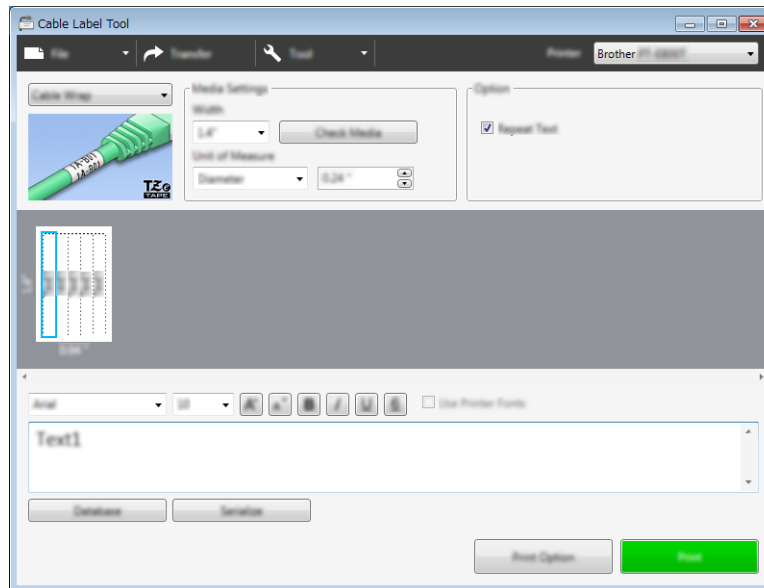

### Note

#### When using Flexible ID Tape:

- We recommend using Flexible ID Tape for the "Cable Wrap" labels.
- Labels made with Flexible ID Tape are not designed for use as electrical insulation.
- When wrapping labels around cylindrical objects, the diameter (1) of the object should be at least 3 mm.
- The overlapping (2) ends of the label should be at least 5 mm.

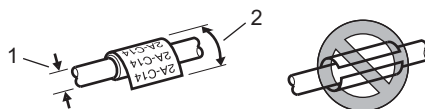

## Cable Flag

Labels of this type can be wrapped around a cable or wire, and both ends of the label stick together to form a flag.

The text on flag labels is printed on both ends of the label, leaving a blank space in the middle that wraps around the cable.

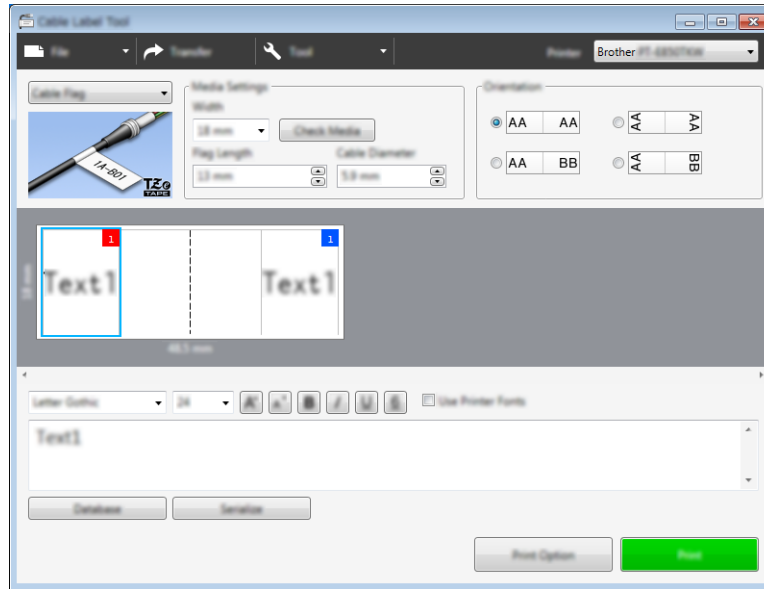

**Note**

- The flag length (1) should be at least 5 mm.

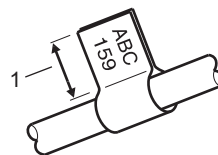

- Orientation

Horizontal



Vertical

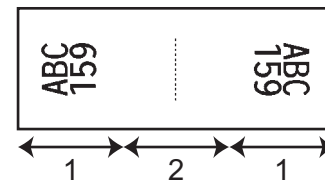

- 1 Flag length
- 2 Cable circumference

- We recommend using Flexible ID Tape for the "Cable Flag" labels.
- Labels made with Flexible ID Tape are not designed for use as electrical insulation.

## Patch Panel

Labels of this type can be used to identify various types of panels.

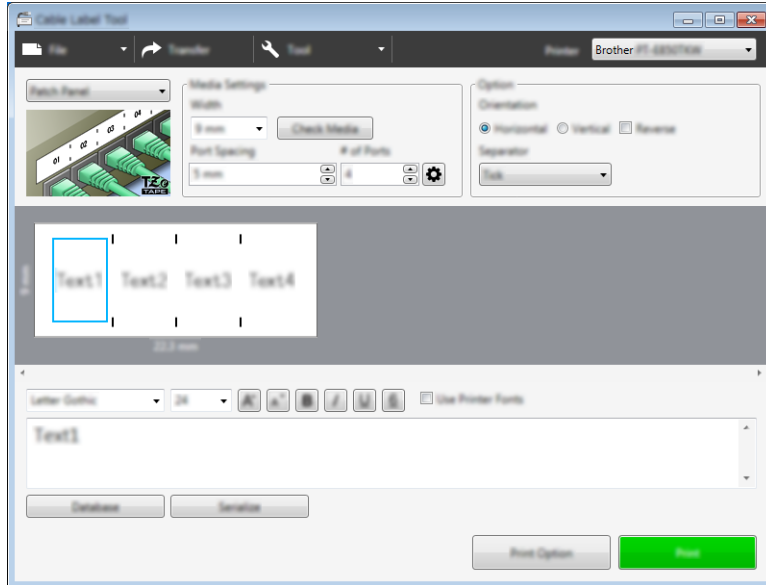

## Punch-Down Block

Labels of this type can be used to identify a type of electrical connection, often used in telecommunications. You can enter up to eight lines for each block on a single label.

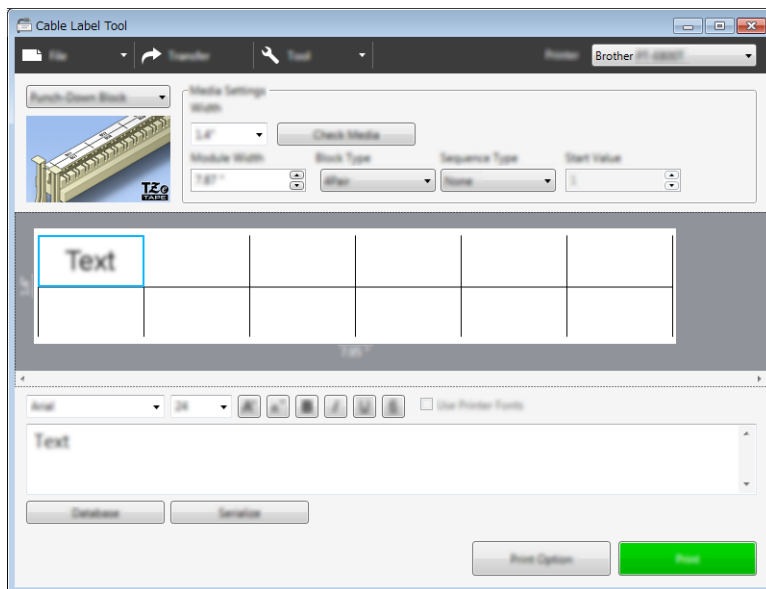

## Die-cut Flag

Labels of this type can be printed on special die-cut flag labels to create flag labels for cables and wires. Use FLe label cassettes for this type of application.

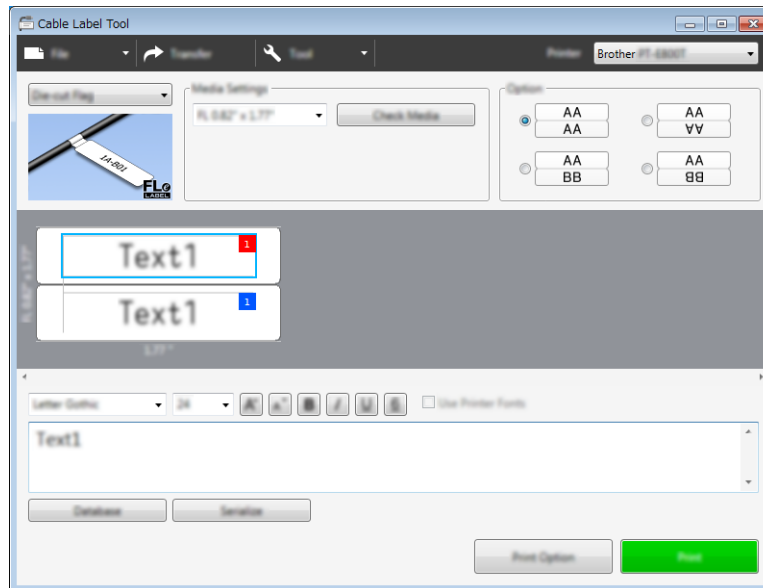

## Heat Shrink Tube

Tubes of this type can be heated to shrink them to fit cables. Use HSe tube cassettes for this type of application.

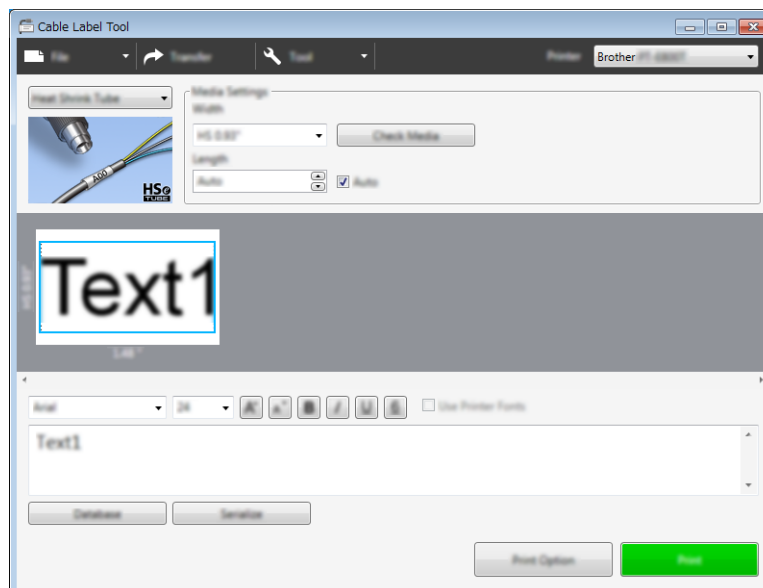

## Linking a Database

You can link databases to templates.

- 1 Click [**Database**].
- 2 Select a database.
- 3 The database linked to the template appears.  
Specify the data to print and the number of copies.

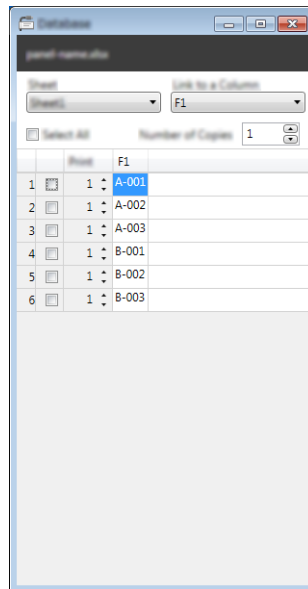

## Numbering Function (Serialised Number) Printing

You can create numerically serialised labels.

- 1 Highlight the text you want to serialise.

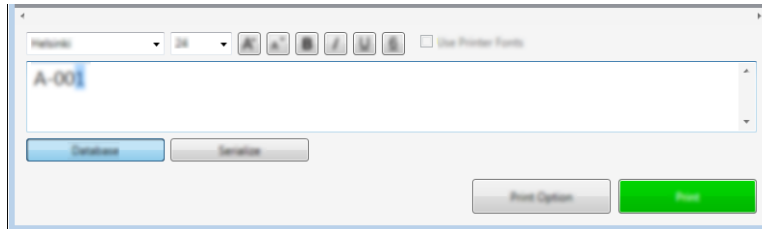

- 2 Click [Serialize].

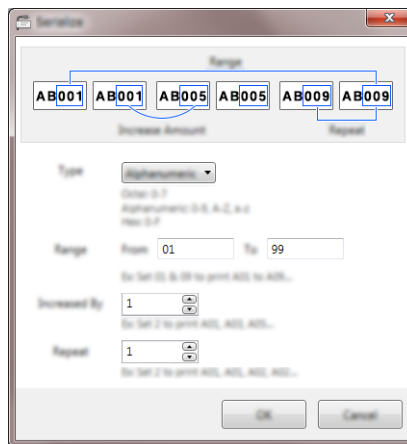

- 3 Specify the settings using the screen image as an example.

## Printing with Cable Label Tool

You can print by selecting [Print] from the [File] menu or by clicking the [Print] button. (Configure the printing settings in the [Print] screen before printing.)

## Transferring Templates from Cable Label Tool to the P-touch Labelling Machine

Using the transfer function, you can transfer a template or a template with a database to the machine without using P-touch Transfer Manager.

- 1 Display the template to transfer in the layout window.
- 2 Click [**Transfer**].  
The [**Transfer Template**] dialog box appears.

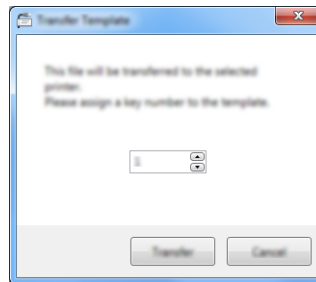

- 3 Select the assignment key.



### Note

If the template or other data transferred to the machine has the same key number as another template already saved in the machine, the new template will overwrite the old one.

- 4 To transfer a template with a connected database, select the [**Transfer with Database**] check box.
- 5 Click [**Transfer**].  
The template or template with database is transferred to the machine.



### Note

- [**Serialize**] settings will not be transferred.
- When transferring a template with a database, if the linked database has multiple sheets, only the sheet currently displayed in the database dialog box is transferred.

## Starting P-touch Editor

1 Start the P-touch Editor.

■ For Windows Vista® / Windows® 7 / Windows Server® 2008 / Windows Server® 2008 R2:

From the Start button, click [All Programs] - [Brother P-touch] - [P-touch Editor 5.1], or double-click [P-touch Editor 5.1] shortcut icon on the desktop.

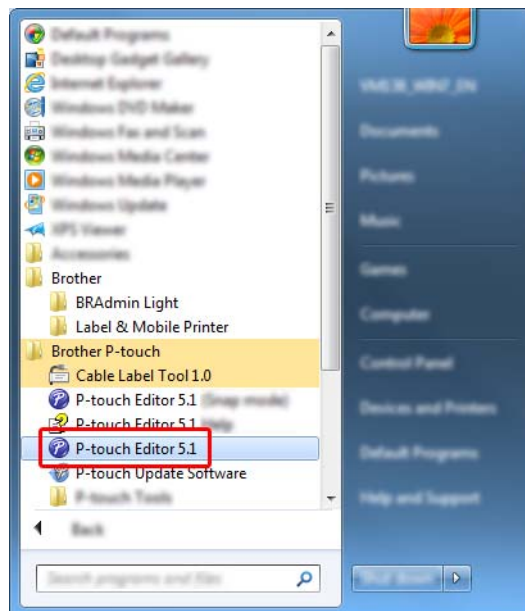

■ For Windows® 8 / Windows® 8.1 / Windows Server® 2012 / Windows Server® 2012 R2:

Click [P-touch Editor 5.1] on the [Apps] screen or double-click [P-touch Editor 5.1] on the desktop.

■ For Windows® 10:

From the Start button, select [All apps] and click [P-touch Editor 5.1] under [Brother P-touch], or double-click [P-touch Editor 5.1] on the desktop.

2 When P-touch Editor starts, select whether you want to create a new layout or open an existing layout.

### Note

To change how P-touch Editor functions when it starts, click [Tools] - [Options] in the P-touch Editor menu bar to display the [Options] dialog box. On the left side, select the [General] heading, and then the setting you want in the [Operations] list box under [Startup Settings]. The factory setting is [Display New View].

3 Select one of the displayed options:

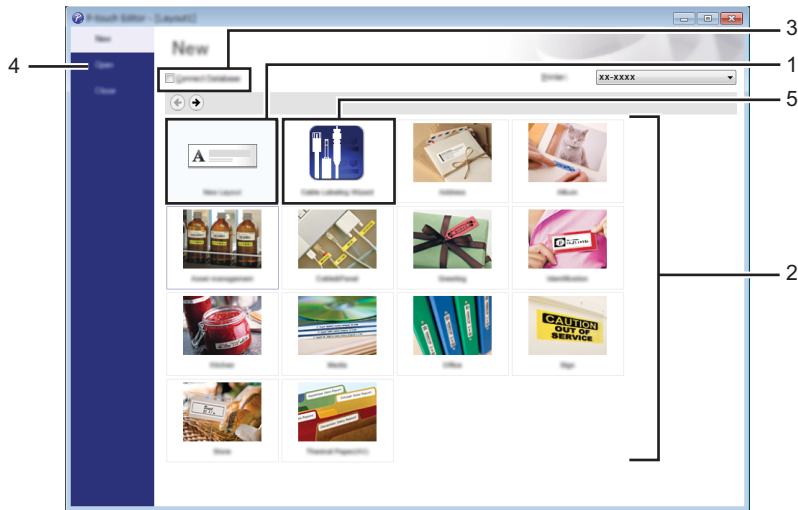

- 1 To create a new layout, double-click **[New Layout]**, or click **[New Layout]** and then click **[→]**.
- 2 To create a new layout using a preset layout, double-click a category button, or select a category button and then click **[→]**.
- 3 To connect a preset layout to a database, select the check box next to **[Connect Database]**.
- 4 To open an existing layout, click **[Open]**.
- 5 To open the application for creating labels for electrical equipment management, double-click **[Cable Labelling Wizard]**, or click **[Cable Labelling Wizard]** and then click **[→]**.

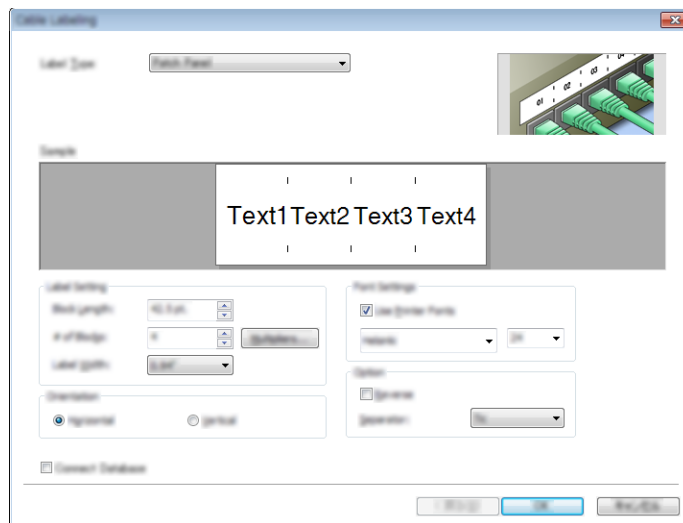

# Printing with P-touch Editor

## Express mode

This mode allows you to quickly create layouts that include text and images.

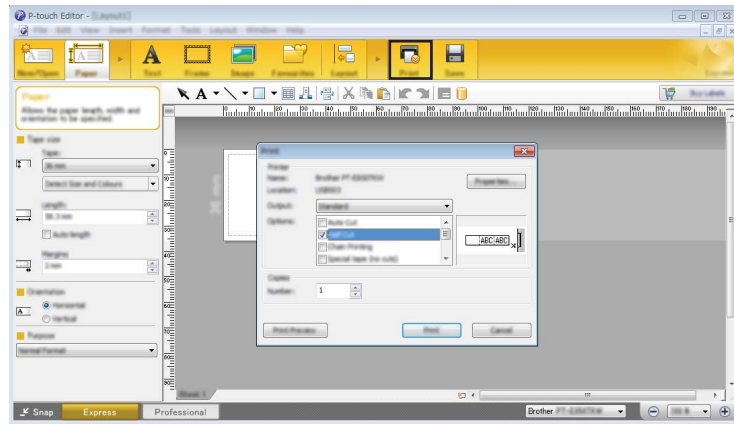

You can print by selecting **[Print]** from **[File]** in the menu bar or by clicking the **[Print]** icon. (Configure the printing settings in the **[Print]** screen before printing.)

## Professional mode

This mode allows you to create layouts using a wide-range of advanced tools and options.

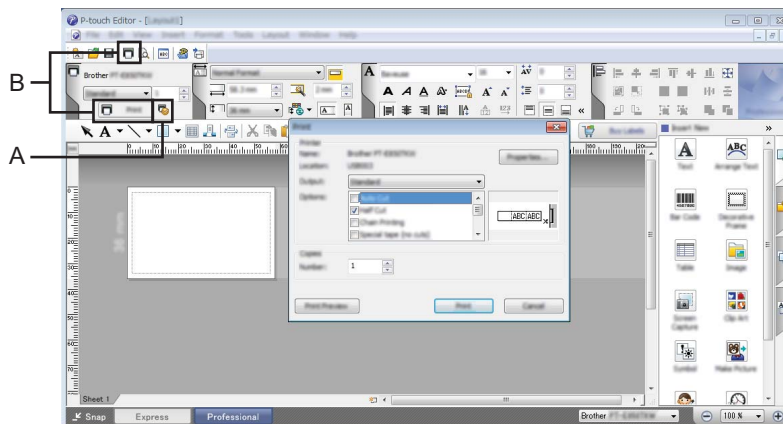

You can print by selecting **[Print]** from **[File]** in the menu bar or by clicking the Print Setting icon (A). Configure the printing settings in the **[Print]** screen before printing.

In addition, you can click the **[Print]** icon “B” to start printing without changing the printing settings.

## Snap mode

This mode allows you to capture all or a portion of your computer screen display, print it as an image, and save it for future use.

- 1 Click the **[Snap]** mode selection button.  
The **[Description of Snap mode]** dialog box appears.

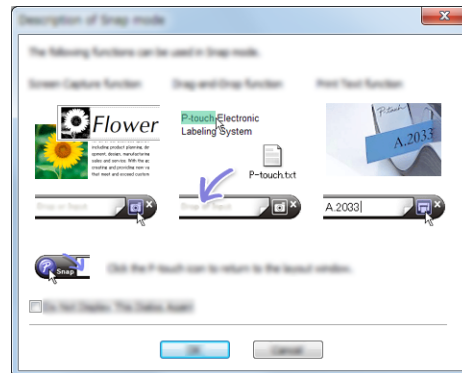

- 2 Click **[OK]**.  
The **[Snap]** mode palette appears.



## Transferring Data to the P-touch Labelling Machine

To transfer data to the machine, you must use P-touch Transfer Manager. For more information, see *How to Use P-touch Transfer Manager* on page 134.

This program allows you to transfer templates and other data to the P-touch labelling machine and save backups of your data on the computer.

## Transferring the Template to P-touch Transfer Manager

To use P-touch Transfer Manager, you must first transfer templates created in P-touch Editor to P-touch Transfer Manager.

- 1 Create the layout you want to use as a template with P-touch Editor, and then select **[File] - [Save As]** to save it as a template file (\*.lbx).
- 2 Click **[File] - [Transfer Template] - [Transfer]**.  
When P-touch Transfer Manager starts, the main window appears.



### Note

---

The following method can also be used to start P-touch Transfer Manager:

- **For Windows Vista® / Windows® 7 / Windows Server® 2008 / Windows Server® 2008 R2:**  
From the Start button, click **[All Programs] - [Brother P-touch] - [P-touch Tools] - [P-touch Transfer Manager 2.2]**.
- **For Windows® 8 / Windows® 8.1 / Windows Server® 2012 / Windows Server® 2012 R2:**  
Click **[P-touch Transfer Manager 2.2]** on the **[Apps]** screen.
- **For Windows® 10:**  
From the Start button, select **[All apps]**, and then click **[P-touch Transfer Manager 2.2]** under **[Brother P-touch]**.

## Main window

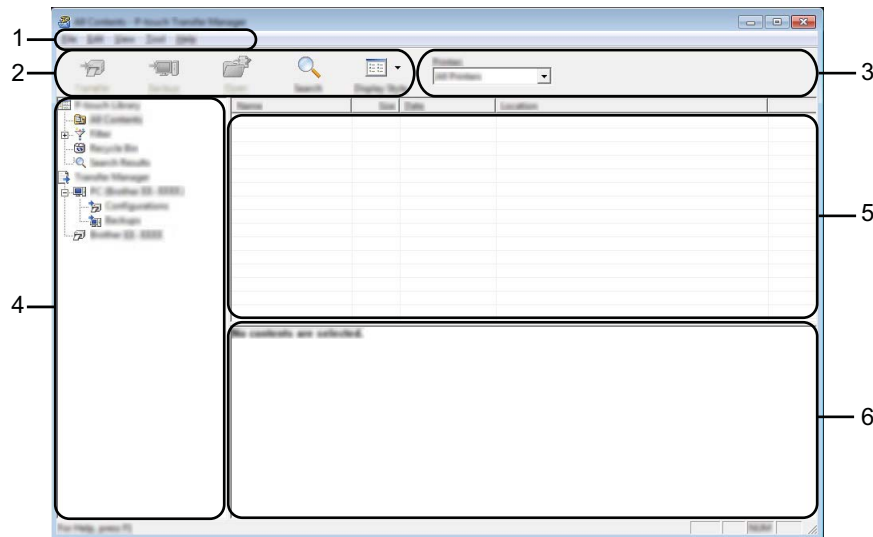

### 1 Menu bar

Provides access to various commands, which are grouped under each menu title ([File], [Edit], [View], [Tool], and [Help]) according to their functions.

### 2 Toolbar

Provides access to frequently used commands.

### 3 Printer selector

Allows you to select which machine the data will be transferred to. When you select a machine, only the data that can be sent to the selected machine appears in the data list.

### 4 Folder view

Displays a list of folders and machines. When you select a folder, the templates in the selected folder appear in the template list.

If you select a machine, the current templates and other data stored in the machine appear.





### 5 Template list

Displays a list of templates in the selected folder.

### 6 Preview

Displays a preview of the templates in the templates list.

### Explanations of the Toolbar Icons

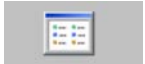
Icon	Button name	Function
	<p><b>Transfer</b> (Only for P-touch Transfer Manager)</p>	<p>Transfers templates and other data from the computer to the machine.</p>
	<p><b>Save Transfer File</b> (When not connected to a machine)</p>	<p>Changes the file type of the data to be transferred to other applications.</p> <p>Select "BLF" for the filename extension when printing the label using Mass Storage Mode (USB), or when transferring the data using BRAdmin Professional (Wi-Fi) or Mobile Transfer Express (Wi-Fi). Select "PDZ" when transferring the data using TransferExpress (USB).</p> <p>The available interfaces differ depending on your model.</p>
	<p><b>Backup</b> (Only for P-touch Transfer Manager)</p>	<p>Retrieves the templates and other data saved in the machine and saves it on the computer.</p>
	<p><b>Open</b></p>	<p>Opens the selected template.</p>
	<p><b>Print</b> (Only for P-touch Library)</p>	<p>Prints the selected template with the machine.</p>
	<p><b>Search</b></p>	<p>Allows you to search for templates or other data registered to P-touch Library.</p>
	<p><b>Display Style</b></p>	<p>Changes the file display style.</p>

## Transferring Templates or Other Data from the Computer to the Machine

Use the following procedure to transfer templates, databases and images from the computer to the machine.

- 1 Connect the computer and the machine via USB and turn the machine on.  
The machine model name appears next to a printer icon in the folder view.  
If you select the machine in the folder view, the current templates and other data stored in the machine appear.



### Note

- If a machine is disconnected or offline, it is not listed in the folder view.
- Before transferring data, check that the computer and the machine are correctly connected using a USB cable or a wireless connection, and that the machine is on.

- 2 Select the machine that you want to transfer the template or other data to.

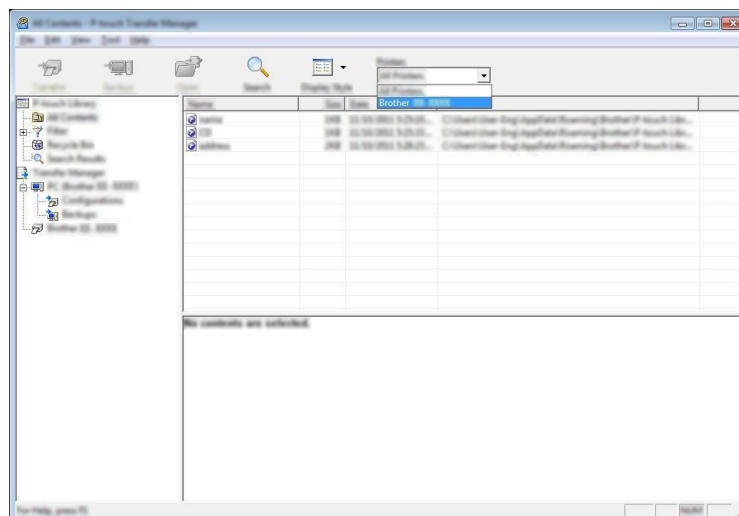

### Note

Before transferring data, check that the computer and the machine are correctly connected with a USB cable or a wireless connection and that the machine is on.

- Right-click the **[Configurations]** folder, select **[New]**, and then create a new folder.

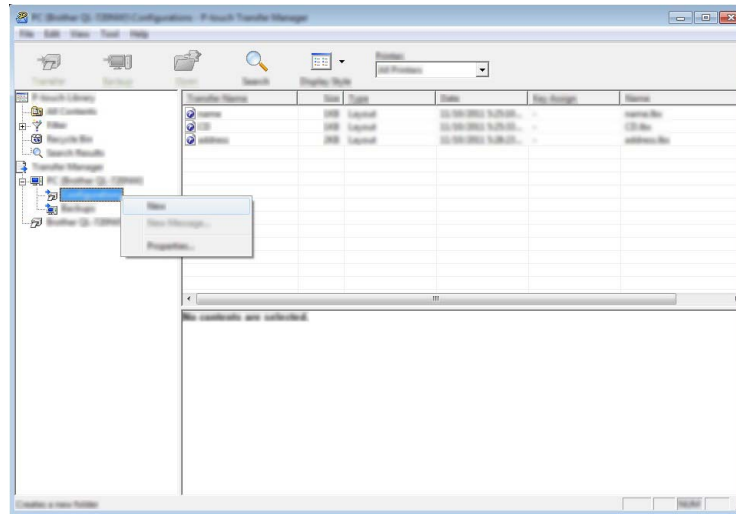

In the example above, the **[Transfer]** folder is created.

- Drag the template or other data that you want to transfer and place it in the new folder.

### Transfer Function Specification

Data type	Maximum number of transferable items	Restriction details
Template	99	<ul style="list-style-type: none"> <li>Each template can contain a maximum of 50 objects.</li> <li>Each object can contain a maximum of 17 lines.</li> </ul>
Database	99	<ul style="list-style-type: none"> <li>Only *.csv files can be transferred.</li> <li>Each *.csv file can contain a maximum of 256 fields and 65000 records.</li> </ul>
Image (transferred symbols)	99	<ul style="list-style-type: none"> <li>Only *.bmp files can be transferred.</li> <li>Monochrome *.bmp files are recommended.</li> <li>The size limit is 2048 × 2048 pixels.</li> <li>Wide images may be cropped.</li> </ul>

 **Note**

The available space <sup>1</sup> in the transfer file memory can be confirmed using the following procedure:  
 Select [Settings] in the Home screen using the ↑, ↓, ← or → key, and then press the **OK** or **Enter** key.  
 Select [Memory Usage] using the ↑ or ↓ key, and then press the **OK** or **Enter** key.  
 Select [Transferred Content] using the ↑ or ↓ key, and then press the **OK** or **Enter** key.

<sup>1</sup> Because the file size may vary depending on the characters input and the type of data, you may not be able to store a file even if the available space that appears in [Available : X.XXMB] indicates there is sufficient space.

You can view the templates and other data by selecting:

- The folder in the [Configurations] folder
- [All Contents]
- One of the categories under [Filter], such as [Layouts].

When transferring multiple templates or other data, drag all files you want to transfer and place them in the new folder.

Each file is assigned a key number (memory location in the machine) when it is placed in the new folder.

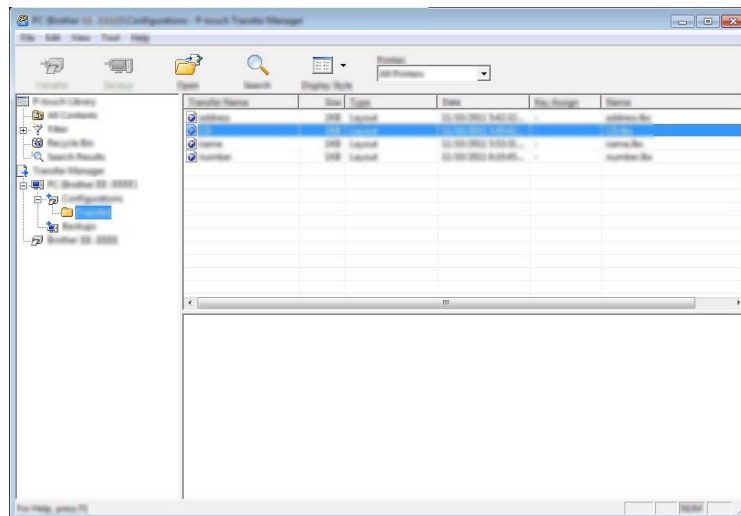

- To change the key number assigned to an item, right-click the item, select **[Key Assign]**, and then select the key number you want.

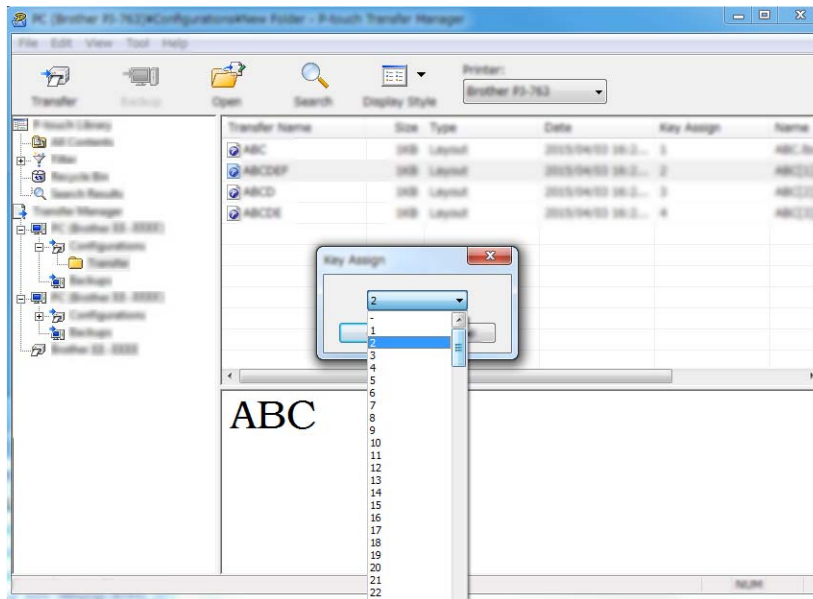

**Note**

- Except for the data in databases, all data transferred to the machine is assigned a key number.
- If the template or other data transferred to the machine has the same key number as another template already saved in the machine, the new template will overwrite the old one. You can confirm the templates key number assignments saved in the machine by backing up the templates or other data (see *Backing up Templates or Other Data Saved in the Machine* on page 142).
- If the machine memory is full, remove one or more templates from the machine memory (see *Backing up Templates or Other Data Saved in the Machine* on page 142).

- To change the names of templates or other data that you want to transfer, click the item you want, and then type the new name. The number of characters used for the template names may be limited depending on your model.

- 7 Select the folder containing the templates or other data that you want to transfer, and then click **[Transfer]**. A confirmation message appears.

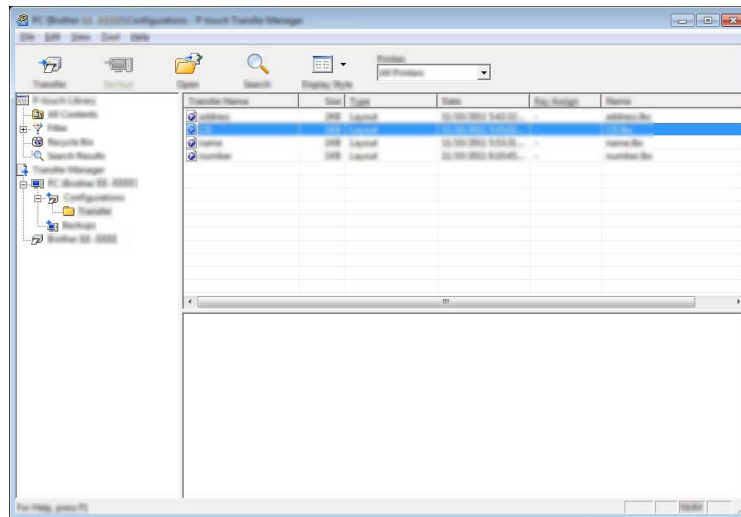

**Note**

- You can also transfer individual items to the machine without adding them to a folder. Select the template or other data that you want to transfer, and then click **[Transfer]**.
- Multiple items and folders can be selected and transferred in one operation.

- 8 Click **[OK]**.



The selected data are transferred to the machine.



**Note**

To print data that was transferred to the machine, the machine must be switched from the transfer mode to the normal mode. Turn the machine off and then on again.

## Backing up Templates or Other Data Saved in the Machine

Use the following procedure to retrieve templates or other data saved in the machine and save it on the computer.

### ! Important

- Backed up templates or other data cannot be edited on the computer.
- Depending on your model, templates or other data backed up from one machine model may not be able to be transferred to another machine model.

- 1 Connect the computer and the machine and turn the machine on.  
The machine model name appears next to a printer icon in the folder view.  
If you select the machine in the folder view, the current templates and other data stored in the machine appear.
- 2 Select the machine to back up from, and then click [**Backup**].  
A confirmation message appears.

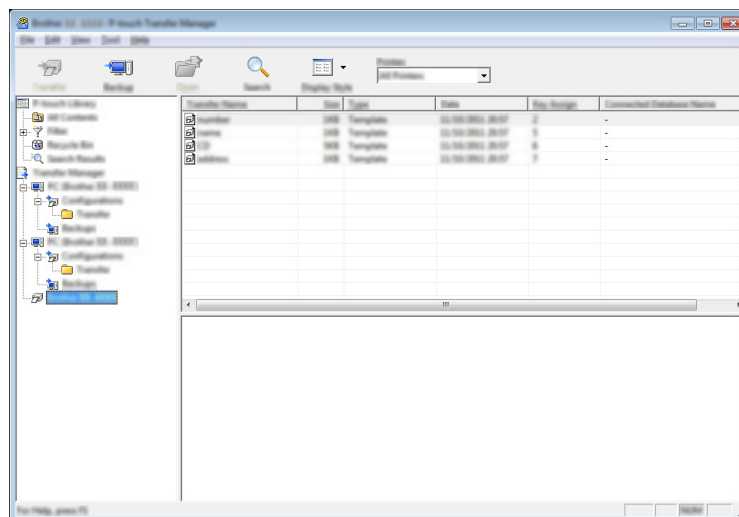

- 3 Click [**OK**].  
A new folder is created under the machine in the folder view. The folder name is based on the date and time of the backup. All of the machine's templates and other data are transferred to the new folder and saved on the computer.



## Deleting All the Machine Data

Use the following procedure to delete all templates or other data saved on the machine.

- 1 Connect the computer and the machine and turn the machine on.  
The machine model name appears next to a printer icon in the folder view.
- 2 Right-click the machine, and then select **[Delete All]**.

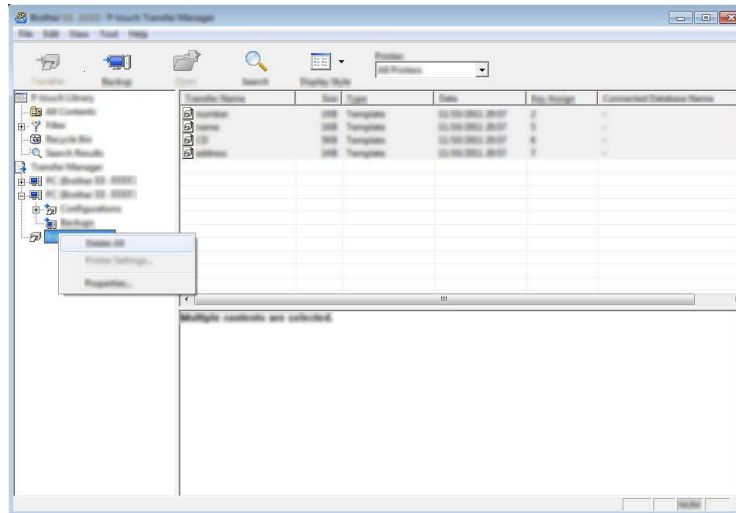

A confirmation message appears.

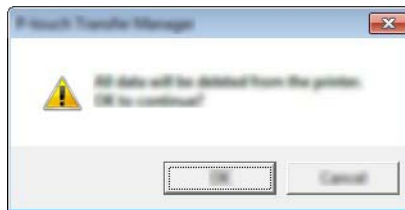

- 3 Click **[OK]**.  
All templates and other data saved in the machine is deleted.

## Creating a BLF File

You can use P-touch Transfer Manager to save template data, which was created using P-touch Editor, in the BLF format. You can transfer these files in this format to a machine over a network, from a computer or mobile device. You can also print files in BLF format from mass storage mode.

- 1 Create the template using P-touch Editor, and then transfer it to P-touch Transfer Manager. For more information, see *Transferring the Template to P-touch Transfer Manager* on page 134.
- 2 Without connecting the machine to the computer, select **[Configurations]** in the P-touch Transfer Manager window, and then select the template to save.



### Note

You can select multiple templates at the same time.

- 3 Click **[File]** - **[Save Transfer File]**.



### Important

The **[Save Transfer File]** button appears only if the machine is disconnected from the computer or offline.



### Note

- If you click **[Save Transfer File]** after selecting **[Configurations]**, all templates in the folder are saved as the Transfer file (.blf).
  - You can combine multiple templates into a single Transfer file (.blf).
- 4 Select the BLF format in **[Save as type]**, and then type in the name and save the template. The templates are saved as a Transfer file (.blf).

This program allows you to use your computer to manage P-touch Template. You can use P-touch Library to print templates.

## Starting P-touch Library

- **For Windows Vista® / Windows® 7 / Windows Server® 2008 / Windows Server® 2008 R2:**  
From the Start button, click [All Programs] - [Brother P-touch] - [P-touch Tools] - [P-touch Library 2.2].
- **For Windows® 8 / Windows® 8.1 / Windows Server® 2012 / Windows Server® 2012 R2:**  
Click [P-touch Library 2.2] on the [Apps] screen.
- **For Windows® 10:**  
From the Start button, select [All apps], and then click [P-touch Library 2.2] under [Brother P-touch].

When P-touch Library starts, the main window appears.

### Main window

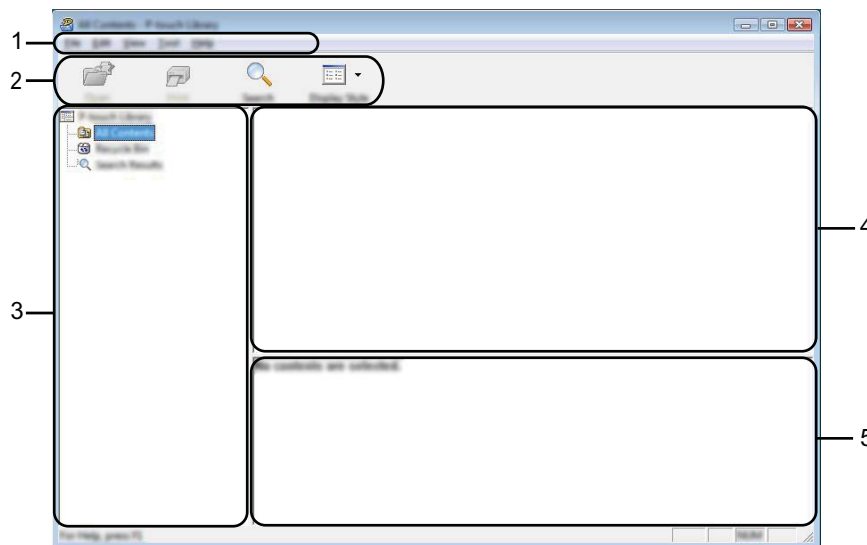

#### 1 Menu bar

Provides access to all available commands, which are grouped under each menu title ([File], [Edit], [View], [Tool], and [Help]) according to their functions.

#### 2 Toolbar

Provides access to frequently used commands.

### 3 Folder list

Displays a list of folders. When you select a folder, the templates in the selected folder appears in the templates list.



### 4 Templates list

Displays a list of the templates in the selected folder.

### 5 Preview

Displays a preview of the templates selected in the templates list.

### Explanations of the Toolbar Icons

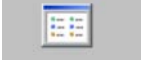
Icon	Button name	Function
	<b>Open</b>	Opens the selected template.
	<b>Print</b> (Only for P-touch Library)	Prints the selected template with the P-touch labelling machine.
	<b>Search</b>	Allows you to search for templates registered to P-touch Library.
	<b>Display Style</b>	Changes the file display style.

## Opening and Editing Templates

Select the template you want to open or edit, and then click **[Open]**.

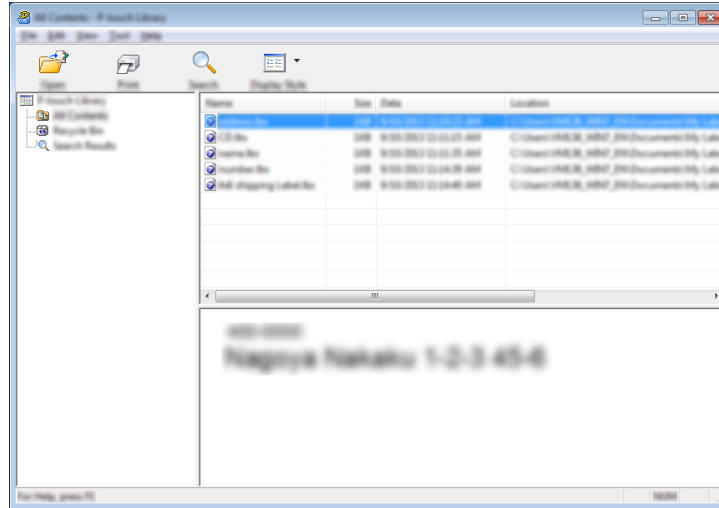

The program associated with the template starts so that you can edit the template.

## Printing Templates

Select the template you want to print, and then click **[Print]**.

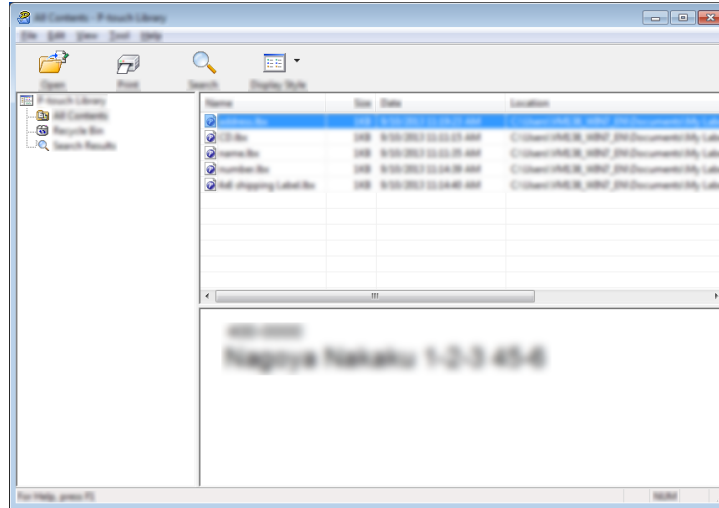

The connected machine prints the template.

## Searching for Templates

You can search for templates registered to P-touch Library.

- 1 Click **[Search]**.  
The **[Search]** dialog box appears.

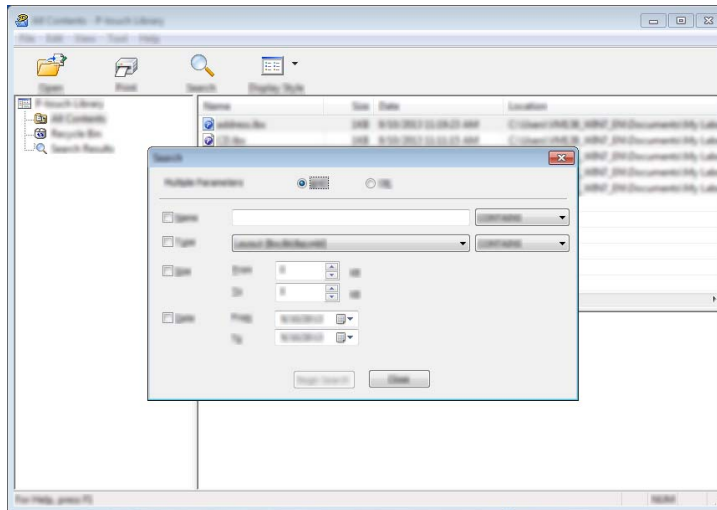

- 2 Specify the search criteria.  
The following search criteria are available:

Settings	Details
<b>Multiple Parameters</b>	Determines how the program searches when multiple criteria are specified. If you select <b>[AND]</b> , the program searches for files that satisfy all of the criteria. If you select <b>[OR]</b> , the program searches for files that satisfy any of the criteria.
<b>Name</b>	Search for a template by specifying the file name.
<b>Type</b>	Search for a template by specifying the file type.
<b>Size</b>	Search for a template by specifying the file size.
<b>Date</b>	Search for a template by specifying the file date.

- 3 Click **[Begin Search]**.  
The search begins.

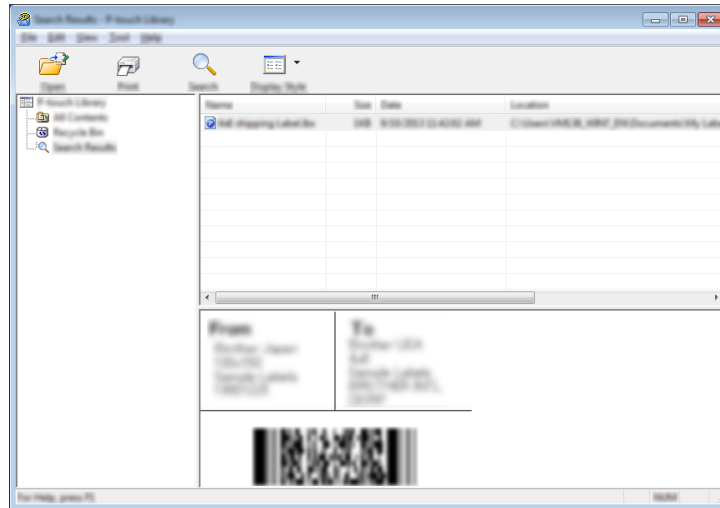

- 4 Close the **[Search]** dialog box.  
To confirm the search results, click **[Search Results]** in the folder view.



**Note**

You can register templates to P-touch Library by dragging and dropping them into the **[All Contents]** folder or to the folder list. You can also configure P-touch Editor to register templates to P-touch Library automatically, using the following procedure:

- 1 From the P-touch Editor menu, select **[Tools] - [Options]**.
- 2 In the **[Options]** dialog box, click **[Registration Settings]** in the **[General]** tab.
- 3 Select the timing for registering templates created with P-touch Editor, and then click **[OK]**.

# Transferring Templates with P-touch Transfer Express

You can transfer templates to the P-touch labelling machine using P-touch Transfer Express. First, the administrator creates a template, and then distributes it together with P-touch Transfer Express. You can then use P-touch Transfer Express to transfer the template directly to your machine.

You can download the latest version of P-touch Transfer Express from the Brother Solutions Center at [support.brother.com](http://support.brother.com)

[Select your region/country.] - [Downloads] - [Choose your product]

## Important

- If the template is to be transferred as a new one, make sure you specify a **[Key Assign]** number (in P-touch Transfer Manager) that is not currently used. If the specified **[Key Assign]** number is already being used, the existing template will be overwritten with the new one.
- This function requires a USB connection.

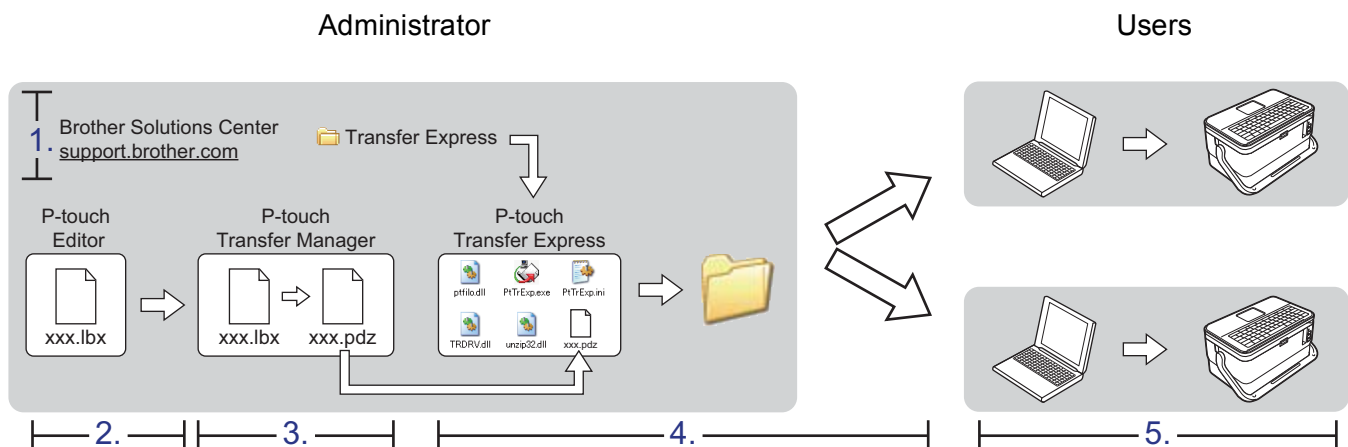

## Preparing P-touch Transfer Express

The user must prepare P-touch Transfer Express for transferring templates to a machine.

## Important

- The printer driver must be installed before using Transfer Express.
- P-touch Transfer Express is available only in English.

- 1 You can download the latest version of P-touch Transfer Express from the Brother Solutions Center at [support.brother.com](http://support.brother.com)  
[Select your region/country.] - [Downloads] - [Choose your product]
- 2 Download Transfer Express to any location on the computer.
- 3 Decompress the downloaded file (.zip).

## Transferring the Template to P-touch Transfer Manager

- 1 Create the layout you want to use as a template with P-touch Editor, and then select **[File] - [Save As]** to save it as a template file (\*.ltx).
- 2 Click **[File] - [Transfer Template] - [Transfer]**.

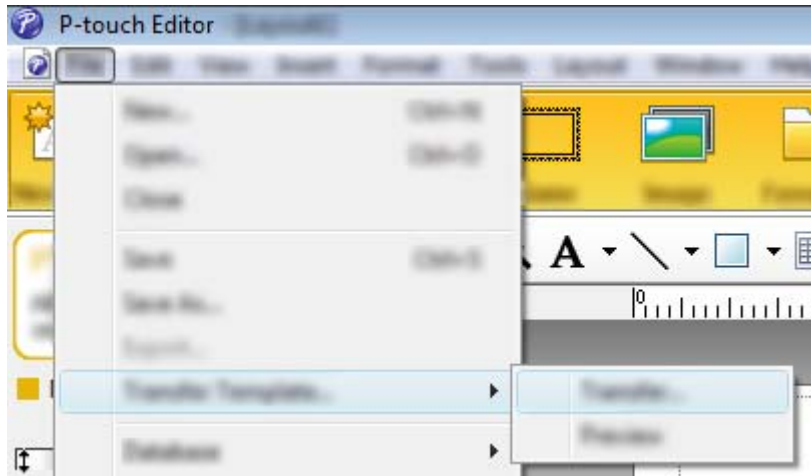

The template is transferred to P-touch Transfer Manager.  
P-touch Transfer Manager automatically starts up.



### Note

- **For Windows Vista® / Windows® 7 / Windows Server® 2008 / Windows Server® 2008 R2:**  
The template can also be transferred to P-touch Transfer Manager by clicking the Start button - **[All Programs] - [Brother P-touch] - [P-touch Tools] - [P-touch Transfer Manager 2.2]** to start P-touch Transfer Manager, and then dragging the .ltx file to the P-touch Transfer Manager window.
- **For Windows® 8 / Windows® 8.1 / Windows Server® 2012 / Windows Server® 2012 R2:**  
The template can also be transferred to P-touch Transfer Manager by clicking **[P-touch Transfer Manager 2.2]** on the **[Apps]** screen to start P-touch Transfer Manager, and then dragging the .ltx file to the P-touch Transfer Manager window.
- **For Windows® 10:**  
The template can also be transferred to P-touch Transfer Manager by clicking the Start button, then selecting **[All apps]** and clicking **[Brother P-touch] - [P-touch Transfer Manager 2.2]** to start P-touch Transfer Manager, and then dragging the .ltx file to the P-touch Transfer Manager window.

## Saving the Template as a Transfer Package File (.pdz)

To create a file in a format that can be used by P-touch Transfer Express, save the template as a Transfer Package file (.pdz).

- 1 In the folder view, select **[Configurations]**.

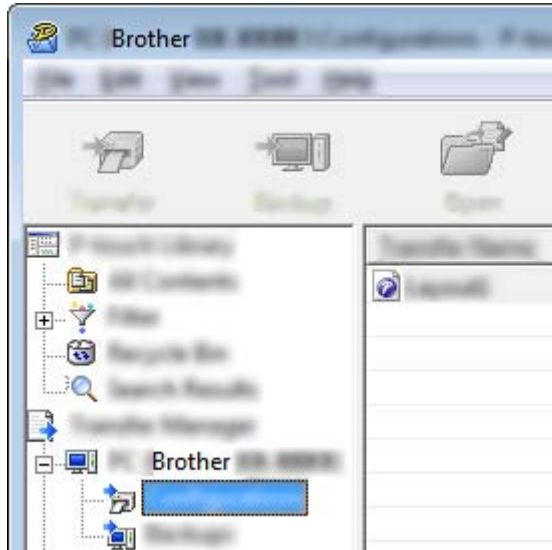

- 2 Select the templates you want to distribute.

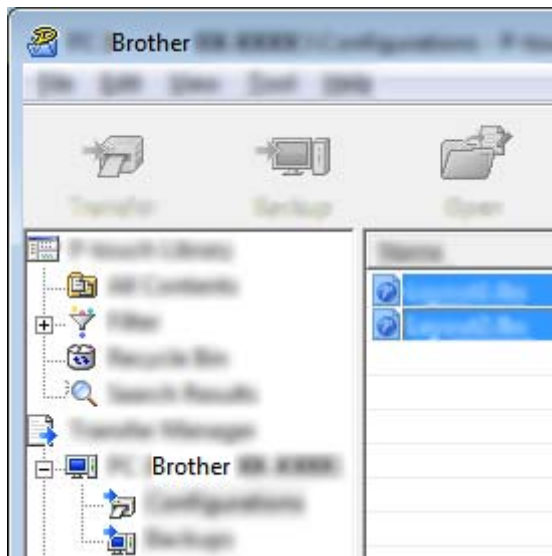

- 3 Click **[File]** - **[Save Transfer File]**.



**! Important**

The **[Save Transfer File]** button appears only if the machine is disconnected from the computer or offline.

**Note**

- If you click **[Save Transfer File]** after selecting **[Configurations]** or a created folder, all templates in the folder are saved as the Transfer Package file (.pdz).
- You can combine multiple templates into a single Transfer Package file (.pdz).

- 4 Type in the name, and then click **[Save]**.

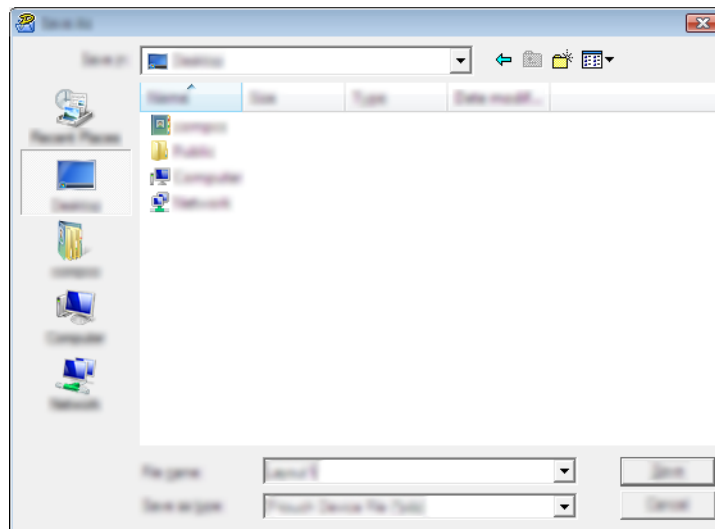

The template is saved as a Transfer Package file (.pdz).

## Distributing the Transfer Package File (.pdz) and P-touch Transfer Express to the User



### Note

If the user has already copied the Transfer Express folder onto their computer, it is not necessary for the administrator to send the Transfer Express folder to the user. In this case, the user can simply move the distributed Transfer Package file to the downloaded folder, and then double-click [PtTrExp.exe].

- 1 Move the Transfer Package file (.pdz) to the downloads folder.

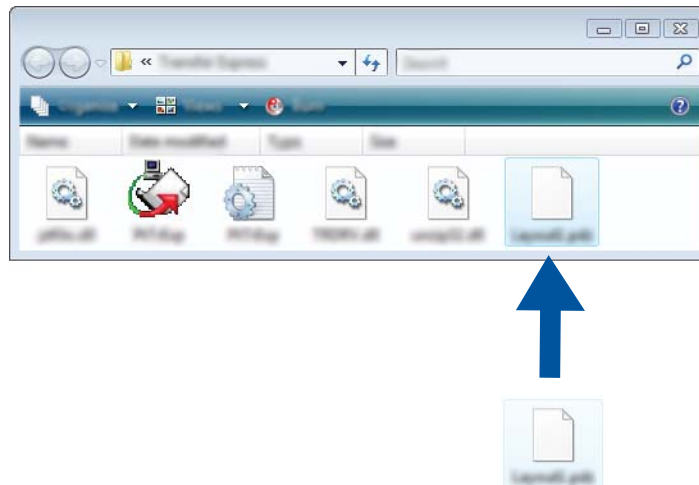

- 2 Distribute all files in the downloads folder to the user.

## Transferring the Transfer Package File (.pdz) to Your Machine

Using the P-touch Transfer Express application received from the administrator, the user can transfer the Transfer Package file (.pdz) to the machine.

### ❗ Important

Do not turn off the power when transferring templates.

- 1 Turn the machine on.
- 2 Using a USB cable, connect the machine to the computer.
- 3 Double-click "PtTrExp.exe", in the [**Transfer Express**] folder, then double-click "PtTrExp.exe", which was received from the administrator.
- 4 1.If there is a single Transfer Package file (.pdz) in the folder containing [**PtTrExp.exe**], click [**Transfer**].

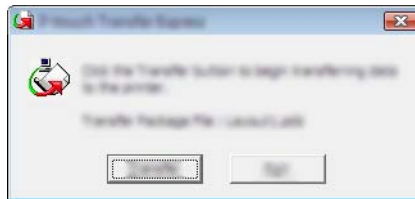

The transfer of the Transfer Package file begins.

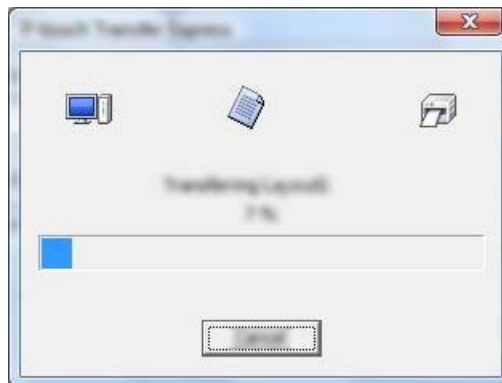

2.If there are either multiple or no Transfer Package files (.pdz) in the folder containing [PtTrExp.exe], click [**Browse**].

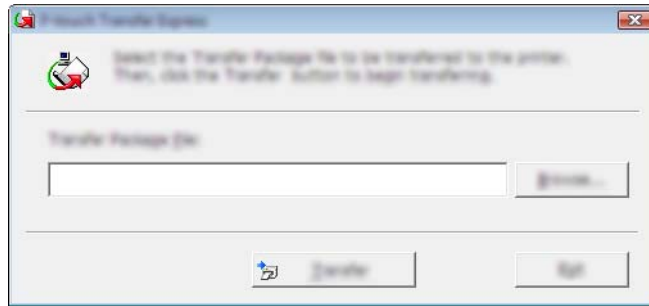

Select the Transfer Package file you want to transfer, and then click [**Open**].

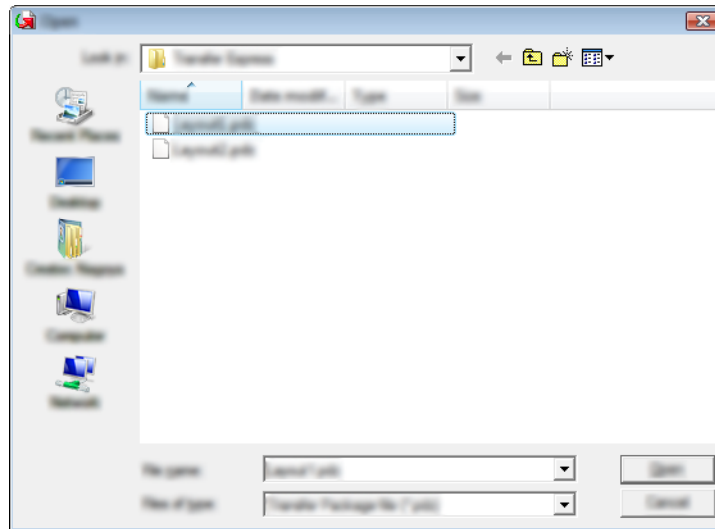

Click [**Transfer**].

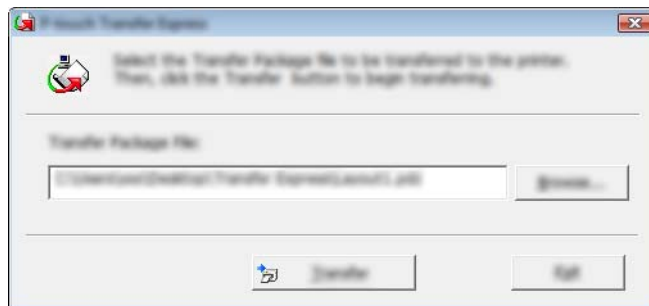

Click **[Yes]**.

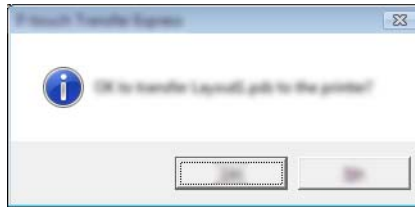

The transfer of the Transfer Package file begins.

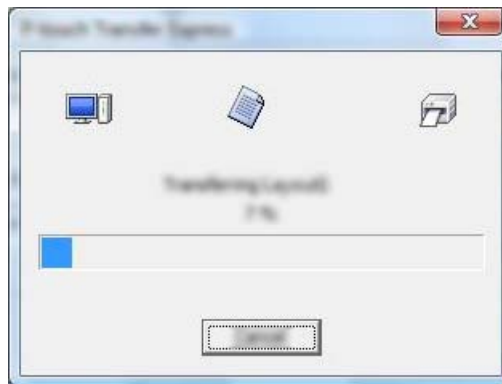

**5** Click **[OK]**.

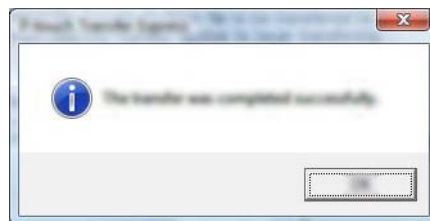

The transfer of the Transfer Package file is completed.

The software can be upgraded to the latest available version using the P-touch Update Software.



## Note

- The actual software and the contents of this manual may differ.
- Do not turn off the power when transferring data or updating firmware.

## Updating Cable Label Tool and P-touch Editor



## Important

The printer driver must be installed before updating Cable Label Tool and P-touch Editor.



1 Start the P-touch Update Software.

- **For Windows® Vista® / Windows® 7 / Windows Server® 2008 / Windows Server® 2008 R2:**  
Double-click the [**P-touch Update Software**] icon.



## Note

The following method can also be used to start P-touch Update Software:

Click the Start button, and then select [**All Programs**] - [**Brother P-touch**] - [**P-touch Update Software**].

- **For Windows® 8 / Windows® 8.1 / Windows Server® 2012 / Windows Server® 2012 R2:**  
Click [**P-touch Update Software**] on the [**Apps**] screen or double-click [**P-touch Update Software**] on the desktop.
- **For Windows® 10:**  
From the Start button, select [**All apps**] and click [**Brother P-touch**] - [**P-touch Update Software**], or double-click [**P-touch Update Software**] on the desktop.



- 2 Click the **[Computer software update]** icon.

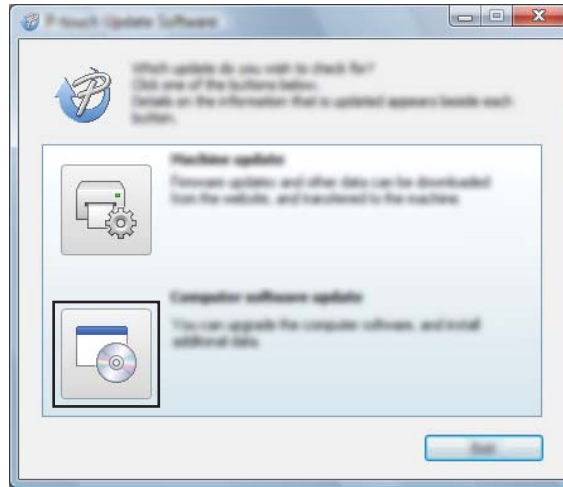

- 3 Select the **[Printer]** and **[Language]** settings, select the check box next to Cable Label Tool and P-touch Editor, and then click **[Install]**.

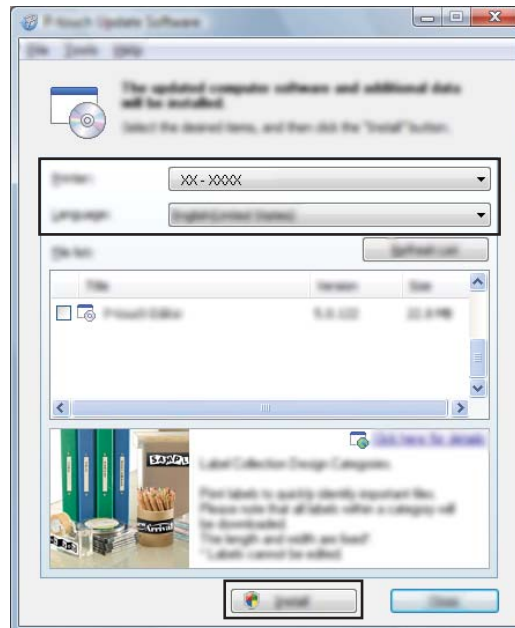

- 4 A message appears indicating that the installation has finished.

## Updating the Firmware

### ❗ Important

- The printer driver must be installed before updating the firmware.
- Do not turn off the power when transferring data or updating firmware.
- If another application is running, exit the application.

1 Turn the P-touch labelling machine on and connect the USB cable.

2 Start the P-touch Update Software.

■ **For Windows Vista® / Windows® 7 / Windows Server® 2008 / Windows Server® 2008 R2:**

Double-click the **[P-touch Update Software]** icon.



### Note

The following method can also be used to start P-touch Update Software:

Click the Start button, and then select **[All Programs] - [Brother P-touch] - [P-touch Update Software]**.

■ **For Windows® 8 / Windows® 8.1 / Windows Server® 2012 / Windows Server® 2012 R2:**

Click **[P-touch Update Software]** on the **[Apps]** screen or double-click **[P-touch Update Software]** on the desktop.

■ **For Windows® 10:**

From the Start button, select **[All apps]** and click **[Brother P-touch] - [P-touch Update Software]**, or double-click **[P-touch Update Software]** on the desktop.



- 3 Click the **[Machine update]** icon.

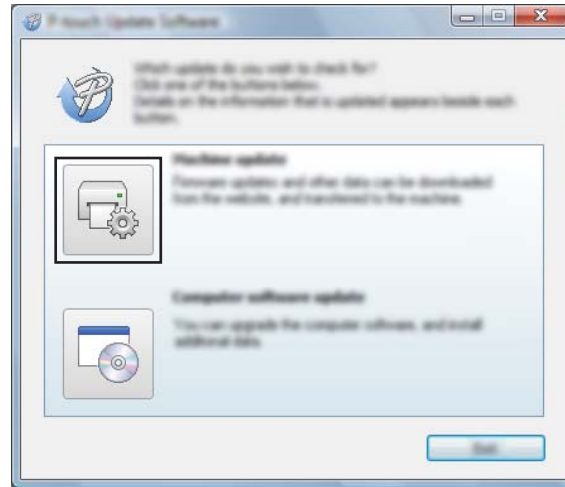

- 4 Select the **[Printer]** settings, ensure that **[The machine is connected correctly.]** appears, and then click **[OK]**.

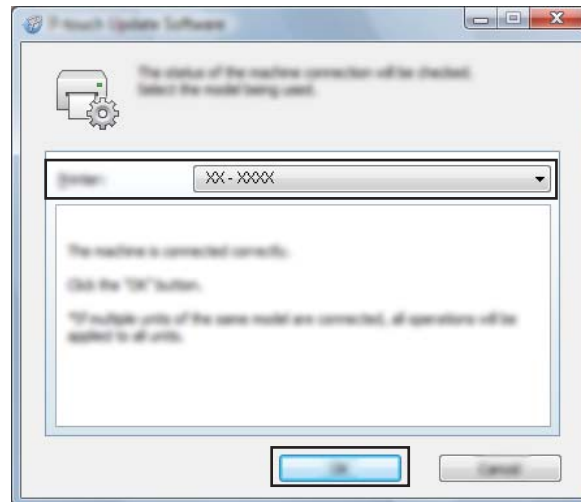

- 5 Select the **[Language]** settings, select the check box next to the firmware you want to update to, and then click **[Transfer]**.

**! Important**

Do not turn the machine off or disconnect the cable during data transfer.

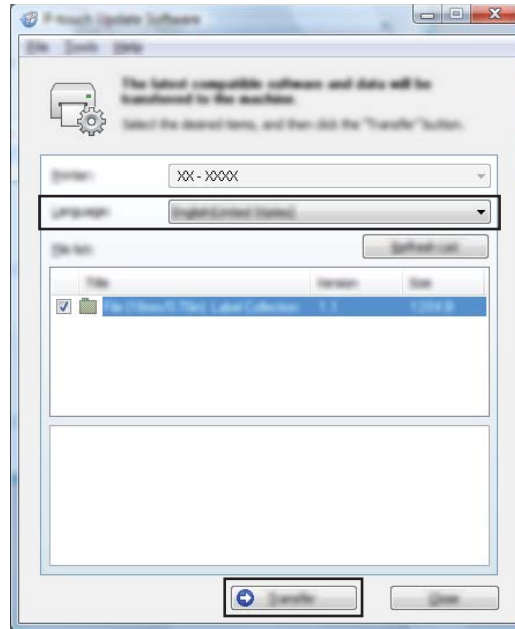

- 6 Check the content to be updated, and then click **[Start]** to begin the update. The firmware update begins.

**! Important**

Do not turn the machine off or disconnect the cable during the update process.



# Application for Mac

---

<b>Using P-touch Software</b>	165
<b>How to Use P-touch Editor</b>	166
<b>How to Update P-touch Software</b>	169

## Installing P-touch Software

You must install P-touch software and the printer driver to use your P-touch labelling machine with your computer.

Download the installer from [www.brother.com/inst](http://www.brother.com/inst).

For more information on installing the software and driver, see *Installing the Printer Driver and Software* on page 62.

To download the latest driver and software individually, visit the Brother Solutions Center at [support.brother.com](http://support.brother.com).

[Select your region/country.] - [Downloads] - [Choose your product]

## Starting P-touch Editor

- 1 Double-click **[P-touch Editor]** icon on the desktop.



### Note

---

- The following method can also be used to start P-touch Editor:  
Double-click **[Macintosh HD]** - **[Applications]** - **[P-touch Editor 5.1]**, and then double-click the **[P-touch Editor]** application icon.
  - When using a Mac computer, you cannot transfer label data created using P-touch Editor to the P-touch labelling machine.
- 

P-touch Editor starts.

# Operation modes

## Standard Mode

This mode allows you to create labels with text and images.

The layout window consists of the following sections:

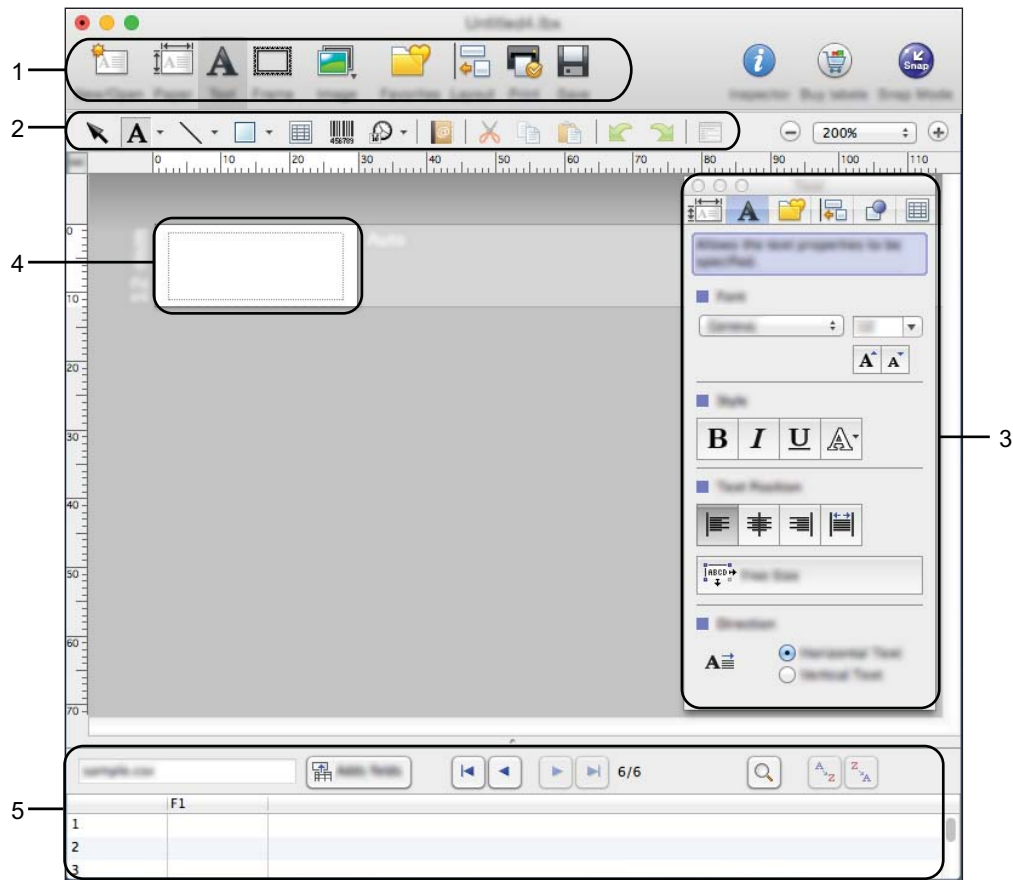

- 1 Command bar
- 2 Draw/Edit toolbar
- 3 Inspector
- 4 Layout window
- 5 Database window

## Snap mode

With this mode, you can capture the screen, print it as an image, and save it for future use.

To start the Snap mode, follow the steps below.

- 1 Click the **[Snap]** mode selection button.  
The **[Description of Snap mode]** dialog box appears.



- 2 Click **[OK]**.  
The **[Snap]** mode palette appears.

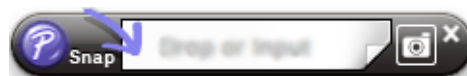

## Transferring Data to the Machine

To transfer data to the machine, you must use a Windows® computer. For more information, see *How to Use P-touch Transfer Manager* on page 134.

The software can be upgraded to the latest available version using the P-touch Update Software.

**Note**

- The actual software and the contents of this manual may differ.
- Do not turn off the power when transferring data or updating firmware.

## Updating P-touch Editor

**Important**

The printer driver must be installed before updating P-touch Editor.



1 Double-click the **[P-touch Update Software]** icon on the desktop.

**Note**

The following method can also be used to start P-touch Update Software:

Double-click **[Macintosh HD] - [Applications] - [P-touch Update Software]**, and then double-click the **[P-touch Update Software]** application icon.



2 Click the **[Computer software update]** icon.

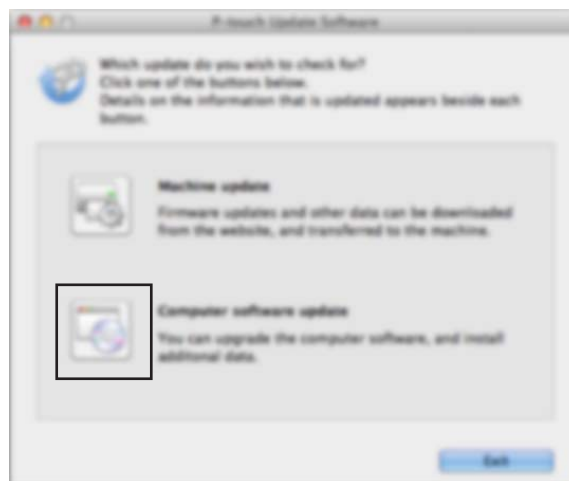

- 3 Select the **[Printer]** and **[Language]** settings, select the check box next to P-touch Editor, and then click **[Install]**.

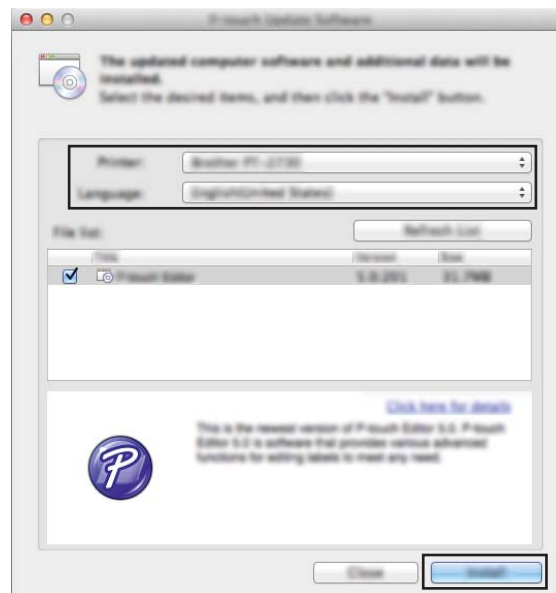

- 4 A message appears indicating that the installation has finished.

# Updating the Firmware

## ! Important

- The printer driver must be installed before updating the firmware.
- Do not turn off the power when transferring data or updating firmware.
- If another application is running, exit the application.

- 1 Turn the P-touch labelling machine on and connect the USB cable.
- 2 Double-click the **[P-touch Update Software]** icon on the desktop.

## 📝 Note

The following method can also be used to start P-touch Update Software:

Double-click **[Macintosh HD] - [Applications] - [P-touch Update Software]**, and then double-click the **[P-touch Update Software]** application icon.



- 3 Click the **[Machine update]** icon.

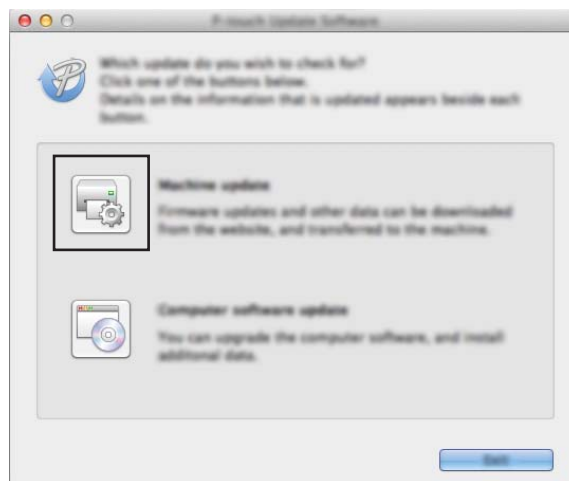

- 4 Select the **[Printer]** settings, ensure that **[The machine is connected correctly.]** appears, and then click **[OK]**.

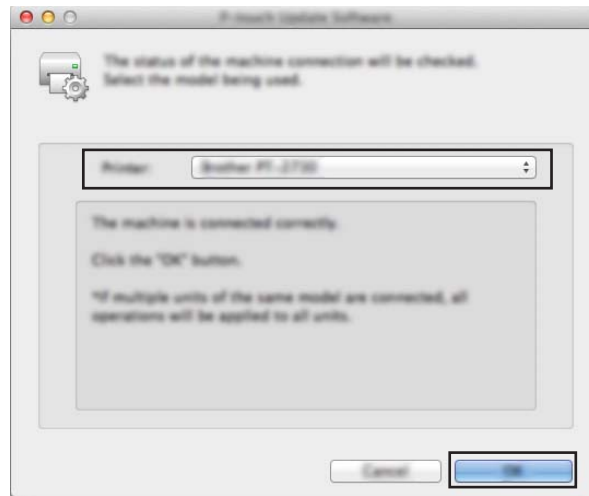

- 5 Select the **[Language]** settings, select the check box next to the firmware you want to update to, and then click **[Transfer]**.

**! Important**

Do not turn the machine off or disconnect the cable during data transfer.

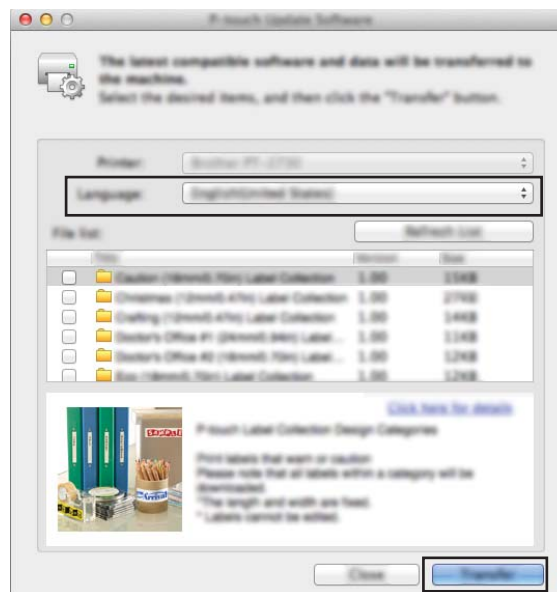

- 6 Check the content to be updated, and then click **[Start]** to begin the update. The firmware update begins.

**! Important**

Do not turn the machine off or disconnect the cable during the update process.



# Wireless Network

---

<b>Introduction</b>	<b>174</b>
<b>Changing Your P-touch Labelling Machine Network Settings</b>	<b>175</b>
<b>Web Based Management</b>	<b>178</b>

# 18 Introduction

## Network Features

Your P-touch labelling machine can be shared on an IEEE 802.11b/g/n wireless network using the internal network print server. The print server supports various functions and methods of connection on a network supporting TCP/IP, depending on the operating system you are running.

## Changing Your Machine's Network Settings (IP Address, Subnet Mask and Gateway) Using Windows®

### Using the BRAdmin Light Utility

The BRAdmin Light utility is designed for the initial setup of Brother network connectable devices. It can also search for Brother products in a TCP/IP environment, display the status, and configure basic network settings, such as the IP address.

### Installing BRAdmin Light

You must install BRAdmin Light to your computer. See *Installing the Printer Driver and Software* on page 62 for more information on the installation.

To download the latest version of BRAdmin Light, visit the Brother Solutions Center at [support.brother.com](http://support.brother.com).



#### Note

- For more advanced machine management, use the latest version of the Brother BRAdmin Professional utility available as a download from the Brother Solutions Center at [support.brother.com](http://support.brother.com).
- If using firewall, anti-spyware, or antivirus software, temporarily disable them. When you are sure that you can print, re-enable them.
- The node name appears in the current BRAdmin Light window. The default node name of the print server in the machine is "BRWxxxxxxxxxxxx". ("xxxxxxxxxxxx" is based on your machine's MAC Address / Ethernet Address.)

### Setting the IP address, Subnet Mask and Gateway using BRAdmin Light

- 1 Start the BRAdmin Light utility.
  - **For Windows Vista® / Windows® 7 / Windows Server® 2008 / Windows Server® 2008 R2:**  
Click [Start] - [All Programs] - [Brother] - [BRAdmin Light] - [BRAdmin Light].
  - **For Windows® 8 / Windows® 8.1 / Windows Server® 2012 / Windows Server® 2012 R2:**  
Click the [BRAdmin Light] icon on the [Apps] screen.
  - **For Windows® 10:**  
From the Start button, select [All apps], and then click [BRAdmin Light] under [Brother].
- 2 BRAdmin Light will search for new devices automatically.

- 3 Double-click the unconfigured device.

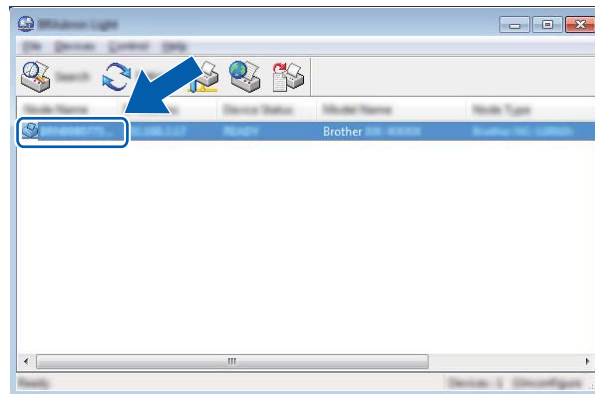

**Note**

If you do not use a DHCP/BOOTP/RARP server, the device appears as **[Unconfigured]** in the BRAdmin Light utility screen.

- 4 Select **[STATIC]** for **[Boot Method]**. Type the **[IP Address]**, **[Subnet Mask]**, and **[Gateway]** settings (if needed) for your print server.

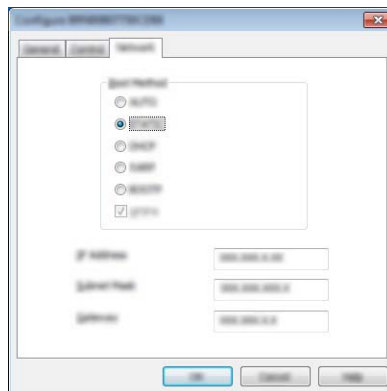

- 5 Click **[OK]**.
- 6 If you have set the IP address up correctly, the Brother print server appears in the device list.

## Other Management Utilities

Your machine can be used with the following management utilities in addition to the BRAdmin Light utility. You can change your network settings using these utilities.

### Using Web Based Management (Web Browser)

---

A standard web browser can be used to change your print server settings using the HTTP (Hyper Text Transfer Protocol). (See *Configuring the Machine Settings Using Web Based Management (Web Browser)* on page 179.)

### Using the BRAdmin Professional Utility (Windows® Only)

---

BRAdmin Professional is a utility for more advanced management of network connected Brother devices. This utility can search for Brother products on your network, and display the device status from an easy to read Explorer style window that changes colour to represent the status of each device. You can configure network and device settings along with the ability to update device firmware from a Windows® computer on your Local Area Network (LAN). BRAdmin Professional can also log activity of Brother devices on your network and export the log data.

For more information and downloads, visit the Brother Solutions Center at [support.brother.com](http://support.brother.com).



#### Note

---

- Use the latest version of the BRAdmin Professional utility available as a download from the Brother Solutions Center at [support.brother.com](http://support.brother.com).
  - If using firewall, anti-spyware, or antivirus software, temporarily disable them. When you are sure that you can print, re-enable them.
  - The node name appears in the current BRAdmin Professional window. The default node name is "BRWxxxxxxxxxxxx". ("xxxxxxxxxxxx" is based on your machine's MAC Address / Ethernet Address.)
-

## Overview

You can use a standard web browser to manage a P-touch labelling machine on your network using HTTP. When using Web Based Management, the following operations are possible:

- Displaying your machine status information
- Changing network settings, such as TCP/IP information
- Displaying software version information of the machine and print server
- Changing network and machine configuration details



### Note

We recommend Microsoft® Internet Explorer® 7.0 or later or Firefox® 25.0.1 or later for Windows®, Safari® 5.0.6 or later or Firefox® 26.0 or later for Mac.

Make sure JavaScript and cookies are always enabled in the browser you use.

To use Web Based Management, your network must use TCP/IP, and the machine and computer must have a valid IP address.

## Configuring the Machine Settings Using Web Based Management (Web Browser)

A standard web browser can be used to change your print server settings using the HTTP (Hyper Text Transfer Protocol).

- 1 In your browser's address bar, type the IP address of your machine (or print server name).  
For example: `http://192.168.1.2`

### Note



If you have edited the hosts file on your computer or are using a Domain Name System, you can also type the DNS name of the print server. As the print server supports TCP/IP and NetBIOS, you can also type the NetBIOS name of the print server. The NetBIOS name can be seen on the machine settings page. The NetBIOS name assigned is the first 15 characters of the node name and by default it appears as "BRWxxxxxxxxxxx" where "xxxxxxxxxxx" is the Ethernet address.

- 2 You can now change the print server settings.

### Note

#### Setting a password

We recommend setting a logon password to prevent unauthorised access to Web Based Management.

- 1 Click [**Administrator**].
  - 2 Type the password you want to use (up to 32 characters).
  - 3 Re-type the password in the [**Confirm new password**] field.
  - 4 Click [**Submit**].  
The next time you access Web Based Management, type a password in the [**Login**] field, and then click .
- After configuring the settings, log off by clicking .

You can also set a password by clicking [**Please configure the password**] on the machine's web page if you are not setting a logon password.



# Appendix

---







<b>Resetting the P-touch Labelling Machine</b>	181
<b>Maintenance</b>	183
<b>Useful Settings</b>	188
<b>Using the Rechargeable Li-ion Battery/Battery Base (Optional: PA-BT-4000LI/PA-BB-003)</b>	191
<b>Troubleshooting</b>	195
<b>Product Specifications</b>	208
<b>Notes on Using P-touch Transfer Manager</b>	211
<b>Network Terms and Information</b>	213
<b>Symbols/Characters/Styles</b>	223

You can reset the internal memory of your machine to clear all saved label files, or if the machine is not operating correctly.

## Resetting All Settings to the Factory Settings Using the Machine Buttons

All text, format settings, option settings and stored label files are cleared when you reset the machine (including language and unit settings).

To reset the machine, perform the following procedure.

- 1 Turn the machine off.
- 2 Press and hold the  (Power) button and the  (Feed and Cut) button for about three seconds until the  (Power) indicator lights in orange and the  (Label) indicator blinks in green.
- 3 While holding the  (Power) button, press the  (Feed and Cut) button as follows:
  - Press two times to reset the customised settings and clear the data except all of the transferred data from the computer, registered programs, and the contents in the file memory. (The settings that you can make using the keyboard LCD unit are reset.)
  - Press four times to clear all of the transferred data from the computer, registered programs, and the contents in the file memory.
  - Press six times to delete all data and reset the machine settings to the factory settings except the Wi-Fi settings.
- 4 Release the  (Power) button.

## Resetting Data Using the Settings in the Home screen

Select [Settings] in the Home screen using the ↑, ↓, ← or → key, and then press the **OK** or **Enter** key. Select [Reset] using the ↑ or ↓ key, and then press the **OK** or **Enter** key.

Value	Details
Reset All Settings	Transferred data (templates, databases, and transferred symbols), registered programs and the contents in the file memory are NOT cleared. Other data is cleared and all settings except the Wi-Fi settings are reset to factory settings.
Erase All Content	Transferred data (templates, databases, and transferred symbols), registered programs and the contents in the file memory are cleared. Other data is NOT cleared and settings are NOT reset.
Factory Default	All data, customised settings, and the Wi-Fi settings are reset to factory settings.
Reset Wi-Fi Settings	All Wi-Fi settings are reset to factory settings.

## Resetting Data Using the Printer Setting Tool

You can use the Printer Setting Tool from a computer to perform the following operations for the machine:

- Deleting the templates and databases
- Deleting the print log
- Resetting Wi-Fi settings
- Resetting machine settings to factory settings

For more information, see *Changing the P-touch Labelling Machine Settings* on page 80.

We recommend cleaning your P-touch labelling machine on a regular basis to maintain its correct performance and life span.

**Note**

Always remove the battery and disconnect the AC adapter before cleaning the machine.

## Cleaning the Unit

Wipe any dust and marks from the main unit using a soft, dry cloth.

Use a slightly dampened cloth on difficult to remove marks.

**Note**

Do not use paint thinner, benzene, alcohol or any other organic solvent. These may deform the case or damage the appearance of your machine.

## Cleaning the Print Head

Streaks or poor quality characters on printed labels generally indicate that the print head is dirty. Clean the print head using a dry cotton swab or the optional print head cleaning cassette (TZe-CL6).

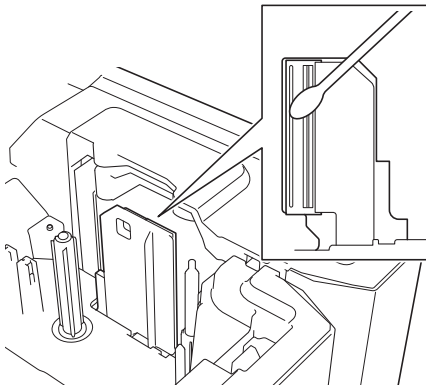

### **⚠ WARNING**

Do not touch the print head directly with your bare hands. The print head may be hot.

**Note**

See the instructions provided with the print head cleaning cassette for directions on how to use it.

## Cleaning the Label Roller

If the quality of the printed characters on the labels is poor even after cleaning the print head, clean the entire label roller with a dry cotton swab by moving the swab up and down while rotating the roller.

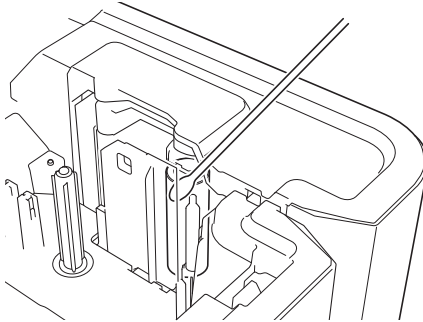

## Cleaning the Tape Cutter Unit

22

Tape adhesive can build up on the cutter blades after repeated use, dulling the blades, which may result in the tape jamming.

About once every year, wipe the cutter blades using a cotton swab.

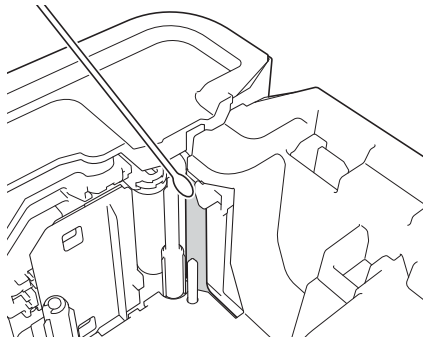

### **!** WARNING

Do not touch the cutter blades directly with your bare hands.

## Cleaning the FLe Sensor

If the FLe sensor is dirty, FLe labels cannot be positioned correctly. Wipe the sensor using a cotton swab moistened with alcohol.

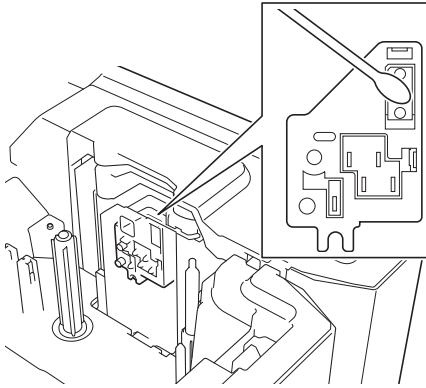

22

## Replacing the Coin Cell Battery

A coin cell battery is used as a backup power supply to maintain the settings for the internal clock of the keyboard LCD unit. The battery will be consumed even if the machine is not used for a long period of time.

### ! Important

- Use only recommended batteries in the machine. Other batteries may cause damage to the machine.
- Dispose of the batteries at an appropriate collection point, not in the general waste stream. In addition, be sure to observe all applicable federal, state, and local regulations.
- When storing or discarding the battery, wrap it (for example with cellophane tape) to prevent it from short-circuiting.

(Battery insulation example)

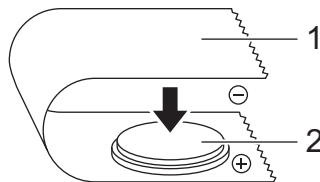

- 1 Cellophane tape
- 2 Coin cell battery

- We recommend replacing the battery every two years.
- If the clock is reset while power is supplied to the machine, replace this battery. When replacing the battery, buy a CR2032 battery (recommended manufacturers: Hitachi Maxell, Ltd., FDK Corporation).

- 1 Press and hold the ⏻ (Power) button to turn the machine off, and then disconnect the machine from the electrical socket. If the rechargeable Li-ion battery is installed, remove the rechargeable battery.
- 2 Press the cover open button to open the top cover.
- 3 Using a coin or similar object, slowly turn the coin cell battery cover in the direction of the arrow on the battery cover until it stops, and then remove the coin cell battery cover.

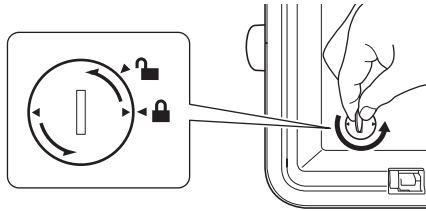

**! Important**

If the coin cell battery cover is forcibly turned past the stop position, it may become damaged.

- 4 Remove the battery.  
As shown below, press part A of the battery so that it can be removed.

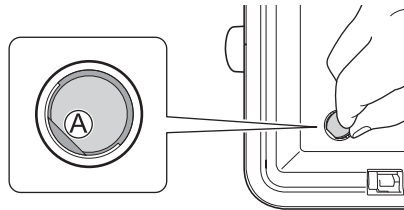

- 5 Install the new battery.

**! Important**

Be sure to insert the new battery with the + and – sides facing the correct direction.

- 6 Return the coin cell battery cover to its original position. To install the coin cell battery cover, use a coin or similar object to slowly turn the coin cell battery cover in the opposite direction of the arrow on the battery cover until it stops.

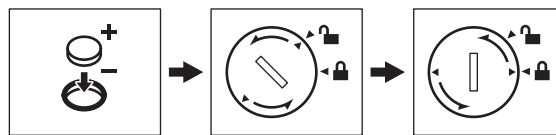

**! Important**

If the coin cell battery cover is forcibly turned past the stop position, it may become damaged.

- 7 Close the top cover.



**Note**

---

You can configure the time and date using [Settings] in the Home screen. For more information, see *Clock Setting* on page 28.

---

## Auto Power-Off Time

Your P-touch labelling machine has a power saving function that automatically turns itself off if no key is pressed within a certain time, under certain operating conditions.

If you use the AC adapter or Li-ion battery, you can change the setting of the auto power-off time.

- 1 Select [Settings] in the Home screen using the ↑, ↓, ← or → key, and then press the **OK** or **Enter** key.
- 2 Select [Auto Power Off] using the ↑ or ↓ key, and then press the **OK** or **Enter** key.
- 3 Select [AC Adapter] or [Li-ion Battery] using the ↑ or ↓ key and set the value using the ← or → key.
- 4 Press the **OK** key.

You can also use the Printer Setting Tool to change the settings. See *Changing the P-touch Labelling Machine Settings* on page 80 for more information.

Setting	Value	Setting	Value
AC Adapter	Off	Li-ion Battery	Off
	10 min		10 min
	20 min		20 min
	30 min		30 min
	40 min		40 min
	50 min		50 min
	1 h		1 h
	2 h		
	4 h		
	8 h		
	12 h		

### ! Important

- If you connect the AC adapter to the machine after you specified "Auto Power Off", the machine uses the "AC Adapter" setting.
- The factory setting is "4h" for the AC adapter and "30 min" for the Li-ion battery.

## Adjusting the LCD Settings

### LCD Contrast

---

You can change the contrast setting of the LCD to one of five levels (+2, +1, 0, -1, or -2) to make the screen easier to read. The factory setting is "0".

- 1 Select [Settings] in the Home screen using the ↑, ↓, ← or → key, and then press the **OK** or **Enter** key.
- 2 Select [LCD Contrast] using the ↑ or ↓ key, and then press the **OK** or **Enter** key.
- 3 Set the value using the ↑ or ↓ key, and then press the **OK** or **Enter** key.



#### Note

- To return to the previous step, press the **Esc** key.
  - Pressing the **Space** key on the contrast setting screen sets the contrast to the factory setting of "0".
- 

### Backlight

---

You can change the backlight setting either to "On" or "Off".

The display is easier to see with the backlight on. The factory setting is "On".

- 1 Select [Settings] in the Home screen using the ↑, ↓, ← or → key, and then press the **OK** or **Enter** key.
- 2 Select [Backlight] using the ↑ or ↓ key, and then press the **OK** or **Enter** key.
- 3 Select [On] or [Off] using the ↑ or ↓ key, and then press the **OK** or **Enter** key.



#### Note

- Power can be saved when the backlight is turned off.
  - The backlight automatically turns off. Press any key to turn the backlight on again.
- 

During printing, the backlight is turned off. The backlight turns on during data transmissions.

## Setting Language and Unit

### Language

---

- 1 Select [Settings] in the Home screen using the ↑, ↓, ← or → key, and then press the **OK** or **Enter** key.
- 2 Select [🗨 Language] using the ↑ or ↓ key, and then press the **OK** or **Enter** key.
- 3 Select a language for menu commands and messages shown on the LCD using the ↑ or ↓ key.  
The following languages are available: [Čeština], [Dansk], [Deutsch], [English], [Español], [Français], [Hrvatski], [Italiano], [Magyar], [Nederlands], [Norsk], [Polski], [Português], [Português (Brasil)], [Română], [Slovenski], [Slovenský], [Suomi], [Svenska], and [Türkçe].
- 4 Press the **OK** or **Enter** key.

**Note**

To return to the previous step, press the **Esc** key.

---

### Setting Unit

---

- 1 Select [Settings] in the Home screen using the ↑, ↓, ← or → key, and then press the **OK** or **Enter** key.
- 2 Select [Unit] using the ↑ or ↓ key, and then press the **OK** or **Enter** key.
- 3 Select a unit for dimensions shown on the LCD using the ↑ or ↓ key.  
Either [inch] or [mm] can be selected.
- 4 Press the **OK** or **Enter** key.

**Note**

The factory setting is [mm].

To return to the previous step, press the **Esc** key.

---

## Using the Rechargeable Li-ion Battery/Battery Base (Optional: PA-BT-4000LI/PA-BB-003)

This P-touch labelling machine can be powered by the AC adapter (included) or the rechargeable Li-ion battery (optional: PA-BT-4000LI). Use the power source appropriate for your intended use.

With the rechargeable Li-ion battery installed, you can use the machine in locations that do not have AC power.

The battery is recharged by the AC adapter when the battery and the battery base are attached to the machine.

### Installing the Rechargeable Li-ion Battery

- 1 Disconnect the AC adapter and then attach the battery base (optional: PA-BB-003) to the machine. For more information about attaching the battery base, see its instruction manual.
- 2 Open the battery cover on the bottom of the machine.
- 3 Insert the battery into the battery compartment.
- 4 Close the battery cover.

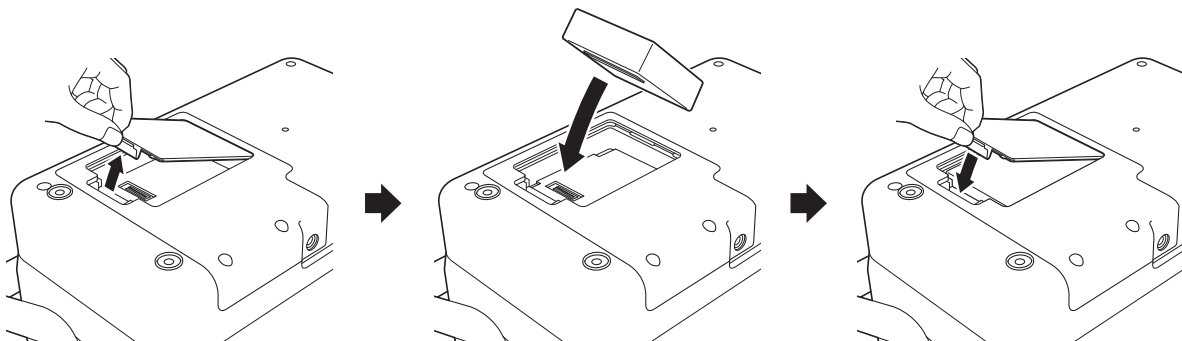

#### Note

The voltage supplied by the rechargeable Li-ion battery fluctuates. The printing speed may also fluctuate depending on the voltage.

## Removing the Rechargeable Li-ion Battery

Press and hold the  (Power) button to turn the machine off.

Remove the battery cover and the battery, and then reattach the battery cover.

### CAUTION

If it is difficult to remove the rechargeable battery, turning the machine over with the battery cover removed may allow the rechargeable battery to fall out.  
Be careful that this does not cause any injuries.

## Charging the Rechargeable Li-ion Battery



### Note

- Before use, fully charge the battery.
- Up to three hours may be needed to fully charge the battery.



1 Make sure the battery is installed in the machine.



2 Use the AC adapter and power supply cord to connect the machine to an electrical socket.

Press the  (Power) button to turn the machine on if it is not on already.

The  (Battery) indicator lights in orange during charging, and it goes off when the battery is fully charged.

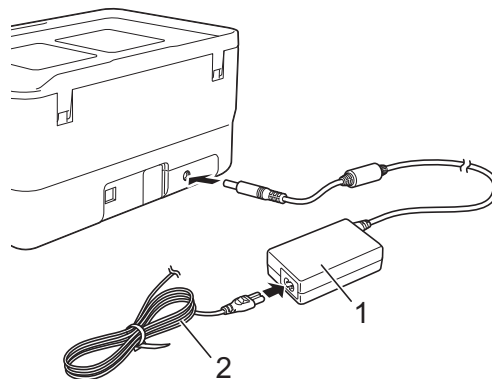

1 AC adapter

2 Power supply cord



### Note



- Even if the machine is turned off during charging, the charging will continue until the battery is fully charged.

- If the machine is turned on with the rechargeable Li-ion battery installed and the AC adapter connected to an electrical socket, the battery will be recharged. However, when the machine is turned on, even after the rechargeable battery has been charged, the battery charge will be used, leaving the battery with less than a full charge the next time the machine is used. We recommend leaving the machine turned off while charging the battery.
- Although the charging stops if the machine is used to print, feed, or perform another operation, the charging will start again automatically after the operation is finished if the charging is not completed.

## Stopping Rechargeable Li-ion Battery Charging

To stop the battery charging, disconnect the AC adapter.

## Notes on Using the Rechargeable Li-ion Battery

- Before use, fully charge the battery. Do not use it until it is fully charged.
- The battery charging must take place in environments between 0°C and 40°C, otherwise the battery will not charge, and the  (Battery) indicator will remain lit. If the charging stops because the environment temperature is too low or too high, place the machine with a temperature between 0°C and 40°C and try charging again.
- If the machine is used to print, feed, or perform another operation when both the battery is installed and the AC adapter is connected, the  (Battery) indicator may turn off and charging may stop even if the battery is not fully charged.

## Rechargeable Li-ion Battery Characteristics

To ensure the highest performance and longest life from the battery:

- Do not use or store the battery in a location exposed to extreme high or low temperatures as it may discharge more quickly. This may happen when using a rechargeable Li-ion battery with a high charge (90% charged or more) in a location exposed to high temperatures.
- Remove the battery when storing the machine for long periods of time.
- Store a battery with less than a 50% charge in a cool dry place out of direct sunlight.
- Recharge the battery every six months if it is stored for long periods of time.
- If you touch a part of the machine while the Li-ion battery is charging, that part of the machine may feel warm. This is normal, and the machine may be used safely. However, if the machine becomes extremely hot, discontinue use.

## Product Specifications

### Rechargeable Li-ion Battery

Size: approx. 74 mm (W) × 86 mm (D) × 32 mm (H)

Weight: approx. 0.240 kg

Voltage: 14.4 V

Capacity: 1800 mAh

Charging/discharging cycle: approx. 300 times

Charging time: approx. 3 hours

### Battery Base

Size: approx. 168 mm (W) × 126 mm (D) × 44 mm (H)

Weight: approx. 0.3 kg

Charging current: 1000 mA

Charging voltage: 16.4 V

## Overview

This chapter explains how to resolve typical problems you may encounter when using the P-touch labelling machine. If you have any problems with the machine, first make sure you have performed the following tasks correctly:

- Connect the machine to an electrical socket or install the battery (see *Connecting the Power Supply* on page 5 or *Installing the Rechargeable Li-ion Battery* on page 191).
- Remove all protective packaging from the machine.
- Install and select the correct printer driver (see *Installing the Printer Driver and Software* on page 62).
- Connect the machine to a computer or mobile device (see *Connecting the Machine to a Computer* on page 62).
- Close the top cover completely.
- Insert a tape cassette correctly (see *Inserting a Tape Cassette* on page 6).

If you still have problems, read the troubleshooting tips in this chapter for help. If, after reading this chapter, you are unable to resolve your problem, visit the Brother Solutions Center at [support.brother.com](http://support.brother.com).

## LCD Problems

Problem	Solution
The screen is locked, or the machine does not respond normally.	See <i>Resetting the P-touch Labelling Machine</i> on page 181 and reset the internal memory to the factory settings. If resetting the machine does not solve the problem, disconnect the AC adapter and remove the battery for more than 10 minutes.
The display remains blank after turning on the power.  The POWER indicator does not light.	The machine is receiving no power. If using AC power, connect the AC adapter correctly to the machine and an electrical socket. If using a rechargeable Li-ion battery, make sure the rechargeable Li-ion battery is firmly installed in the machine and is fully charged.
The LCD messages appear in a foreign language.	See <i>Language</i> on page 190 to select the language you want.

## Printing Problems

Problem	Solution
The label is not printed.	<ul style="list-style-type: none"> <li>■ Check that text has been entered and that the tape cassette is installed correctly with sufficient tape remaining.</li> <li>■ If the tape is bent, cut off the bent section and thread the tape through the exit slot.</li> <li>■ When printing from a computer or mobile device, make sure the computer or mobile device is connected correctly to the machine.</li> </ul>
The label is not printed correctly.	<ul style="list-style-type: none"> <li>■ Remove the tape cassette and reinstall it, pressing it firmly until it locks into place.</li> <li>■ If the print head is dirty, clean it with a dry cotton swab (see <i>Cleaning the Print Head</i> on page 183) or optional print head cleaning cassette (TZe-CL6).</li> </ul> <p>If the quality of the printed characters is poor even after wiping the label print head, wipe the label roller with a dry cotton swab. See <i>Cleaning the Label Roller</i> on page 184.</p>
The tape is jammed.	<ul style="list-style-type: none"> <li>■ If the tape is jammed, remove the tape cassette, and then pull out the jammed tape and cut it. Check that the end of the tape passes through the guide before reinstalling the tape cassette.</li> </ul>

Problem	Solution
<p>The ink ribbon is separated from the ink roller.</p>	<p>If the ink ribbon is broken, replace the tape cassette. If not, leave the tape uncut and remove the tape cassette, then wind the loose ink ribbon onto the spool as shown in the figure.</p> <div data-bbox="976 428 1117 548" style="text-align: center;"> </div> <p><b>1 Spool</b></p>
<p>The machine stops while printing a label.</p>	<ul style="list-style-type: none"> <li>■ Replace the tape cassette if striped tape is visible, as this indicates that you have reached the end of the tape.</li> <li>■ Connect the AC adapter directly to the machine, or charge the rechargeable Li-ion battery.</li> </ul>
<p>The label is not cut automatically.</p>	<p>Check the Cut Option setting. For more information, see <i>Tape Cutting Options</i> on page 40 or <i>Cutting Options</i> on page 70.</p> <p>To cut labels manually, press the  (Feed and Cut) button to feed and cut the tape.</p>
<p>A tape jam error cannot be cleared despite following the troubleshooting steps.</p>	<p>Contact Brother customer service.</p>
<p>I want to make fine adjustments to the print result.</p>	<p>The length and margins can be adjusted in the "<b>Printer Setting Tool</b>". For more information, see <i>Changing the P-touch Labelling Machine Settings</i> on page 80.</p>
<p>I want to print faster.</p>	<p>High speed printing can be used if you are printing from a computer, the AC adapter is connected, and TZe laminated tape with black ink is installed. Use the printer driver to select the high speed mode when printing the labels.</p> <p>You cannot use this function for TZe-FX**1 tape.</p>
<p>I want to print in higher resolution.</p>	<p>High resolution printing can be used if you are printing from a computer, the AC adapter is connected, and TZe laminated tape with black ink is installed. Use the printer driver to select the high resolution mode when printing the labels.</p> <p>You cannot use this function for TZe-FX**1 tape.</p>
<p>The print result is poor.</p>	<p>High resolution printing can be used if you are printing from a computer, the AC adapter is connected, and TZe laminated tape with black ink is installed. Use the printer driver to select the high resolution mode when printing the labels.</p> <p>You cannot use this function for TZe-FX**1 tape.</p> <p>If using the high speed printing setting, print using the standard setting.</p>
<p>The high resolution or high speed printing setting was specified, but an error occurred and printing could not be completed.</p>	<p>As conditions for high resolution or high speed printing, you must print from a computer, the AC adapter must be connected, and TZe laminated tape with black ink must be installed.</p> <p>You cannot use this function for TZe-FX**1 tape.</p> <p>To clear the error, cancel the print job, and then connect the AC adapter or cancel high resolution or high speed printing.</p>



Problem	Solution
<p>Printed barcodes cannot be read.</p>	<ul style="list-style-type: none"> <li>■ Print labels so that barcodes are aligned with the print head as shown below:                             <div data-bbox="889 394 1208 552" style="text-align: center;"> </div> <ol style="list-style-type: none"> <li><b>1 Print head</b></li> <li><b>2 Barcode</b></li> <li><b>3 Printing orientation</b></li> </ol> </li> <li>■ Try using another scanner.</li> <li>■ We recommend printing the barcodes with [Standard] selected from the [Quality] options.                             <ul style="list-style-type: none"> <li>• <b>Windows Vista® / Windows Server® 2008:</b> To display the [Quality] options, open the machine properties by clicking the Start button - [Control Panel] - [Hardware and Sound] - [Printers], right-clicking the machine you want to set up, and then clicking [Printing Preferences].</li> <li>• <b>Windows® 7 / Windows Server® 2008 R2:</b> To display the [Quality] options, open the machine properties by clicking the Start button - [Devices and Printers], right-clicking the machine you want to set up, and then clicking [Printing Preferences].</li> <li>• <b>Windows® 8 / Windows® 8.1 / Windows Server® 2012 / Windows Server® 2012 R2:</b> To display the [Quality] options, open the machine properties by clicking [Control Panel] in the [Apps] screen - [Hardware and Sound] - [Devices and Printers], right-clicking the machine you want to set up, and then clicking [Printing Preferences].</li> <li>• <b>Windows® 10:</b> To display the [Quality] options, open the machine properties by clicking the Start button - [Settings] - [Devices] - [Devices and Printers], right-clicking the machine you want to set up, and then clicking [Printing Preferences].</li> </ul> </li> </ul>
<p>FLe labels cannot be positioned correctly.</p>	<p>If the FLe sensor is dirty, FLe labels cannot be positioned correctly. Wipe the FLe sensor using a cotton swab moistened with alcohol to clean the sensor. See <i>Cleaning the FLe Sensor</i> on page 185.</p>

Problem	Solution
<p>Jams occur when I use TZe-R*** tape cassettes.</p>	<p>Remove the TZe-R*** tape cassette from the machine, and then remove the jammed ribbon.</p> <p>Because the material used for the TZe-R*** ribbon is light and flexible, the ribbon may jam if it contacts the parts of the tape exit slot.</p> <p>When using TZe-R*** tape cassettes, position the machine so that the ribbon exits straight out of the tape exit slot. In addition, make sure the discharged ribbon does not hang down from the machine. The ribbon may jam if it touches the tape exit slot.</p> <p>In addition to these precautions, do not touch the ribbon during printing.</p>

## Version Information

Problem	Solution
<p>I do not know the version number of the firmware of my machine.</p>	<p>The version number and other information for the firmware can be confirmed using the following procedure:</p> <ol style="list-style-type: none"> <li>1 Select [Settings] in the Home screen using the ↑, ↓, ← or → key, and then press the <b>OK</b> or <b>Enter</b> key.</li> <li>2 Select [Version Information] using the ↑ or ↓ key, and then press the <b>OK</b> or <b>Enter</b> key.</li> </ol> <p>In addition, you can also use the following procedure.</p> <ol style="list-style-type: none"> <li>1 Turn the machine on.</li> <li>2 Press and hold the ✂ (Feed and Cut) button for more than 10 seconds to print the report. For more information, see <i>Confirming the P-touch Labelling Machines Settings</i> on page 110. (Use 24 mm or 36 mm tape.)</li> </ol>
<p>I want to confirm whether I am using the latest version of the software.</p>	<p>Use the P-touch Update Software to confirm if you have the latest version.</p> <p>See <i>How to Update P-touch Software</i> on page 159 for more information about the P-touch Update Software.</p>

## Network Setup Problems

Problem	Solution
You are using security software	<ul style="list-style-type: none"> <li>■ Confirm your settings in the installation dialog box.</li> <li>■ Allow access when the security software alert message appears during the machine installation.</li> </ul>
Your security settings (SSID/Network Key) are incorrect	<p>Recheck and select the correct security settings.</p> <ul style="list-style-type: none"> <li>■ The manufacturer's name or model number of the wireless access point/router may be used as the default security settings.</li> <li>■ See the instructions supplied with your wireless access point/router for information on how to find the security settings.</li> <li>■ Ask the manufacturer of your wireless access point/router or ask your Internet provider or network administrator.</li> </ul>
Your machine is placed too far from your mobile device	Move your machine within about one metre of the mobile device when you configure the Wi-Fi network settings.
There are obstructions (walls or furniture, for example) between your machine and the mobile device	Move your machine to an obstruction-free area.
A wireless computer, Bluetooth supported device, microwave oven or digital cordless phone is near the machine or the wireless access point/router	Move other devices away from the machine.
You are using MAC Address filtering	<p>You can confirm the MAC address by printing the machine settings report.</p> <p>See <i>Confirming the P-touch Labelling Machines Settings</i> on page 110 for more information.</p>
Your wireless access point/router is in stealth mode (not broadcasting the SSID)	<ul style="list-style-type: none"> <li>■ You must type the correct SSID name during the installation or when using the Printer Setting Tool.</li> <li>■ Check the SSID name in the instructions supplied with your wireless access point/router and reconfigure the Wi-Fi settings.</li> </ul>
Your machine is not connected correctly to the network	<p>Check the wireless connection indicator on the LCD.</p> <p>  : Connected in Wi-Fi mode.   : Disconnected in Wi-Fi mode, so the wireless settings must be reconfigured.   : Connected or disconnected in Wireless Direct mode.                 </p>
I have checked and tried all of the above, but still cannot complete the Wi-Fi settings	Turn the machine off, and then turn it on again. Then try and configure the Wi-Fi settings again.

## Machine Cannot Print over the Network Machine Is Not Found on the Network Even after Successful Installation

Problem	Solution
You are using security software	See <i>Security Software Problems</i> on page 201.
Your machine is not assigned with an available IP address	<ul style="list-style-type: none"> <li>■ Confirm the IP address and the Subnet Mask. Verify that both the IP addresses and Subnet Masks of your computer and your machine are correct and located on the same network. For more information on how to verify the IP address and the Subnet Mask, ask the network administrator.</li> <li>■ Confirm your IP address, Subnet Mask and other network settings using the Printer Setting Tool. See <i>Changing the P-touch Labelling Machine Settings</i> on page 80.</li> </ul>
Your previous printing job failed	<ul style="list-style-type: none"> <li>■ If the failed printing job is still in your computer's print queue, delete it. For example, when using Windows® 7: The Start button, [<b>Devices and Printers</b>] and select your machine from [<b>Printers and Faxes</b>]. Double-click your machine's icon, and then select [<b>Cancel All Documents</b>] in the [<b>Printer</b>] menu.</li> </ul>
I have checked and tried all of the above, but my machine does not print	Uninstall the printer driver and the software, and then reinstall them.

## Security Software Problems



Problem	Solution
You did not select to allow access when the security alert dialog box appeared during either the standard installation, BRAdmin Light installation, or when printing	If you did not select to allow access when the security alert dialog box appeared, the firewall function of your security software may be blocking access. Some security software may block access without displaying a security alert dialog box. To allow access, see the instructions of your security software or ask the manufacturer.
Incorrect port numbers are being used for the Brother network features	<p>The following port numbers are used for Brother network features:</p> <ul style="list-style-type: none"> <li>■ BRAdmin Light – Port number 161 / Protocol UDP</li> </ul> <p>For more information on how to open the port, see the instructions for the security software or ask the manufacturer.</p>

## Checking the Operation of Network Devices

Problem	Solution
Your machine and wireless access point/router are not turned on	Make sure you have performed all of the tasks on page 195.
I do not know my machine network settings, such as the IP address	Check the Printer Setting Tool (see <i>Changing the P-touch Labelling Machine Settings</i> on page 80).
Can you ping your machine from your computer?	<p>Ping your machine from your computer using the IP address or the node name.</p> <ul style="list-style-type: none"> <li>■ Successful: Your machine is working correctly and connected to the same network as your computer.</li> <li>■ Unsuccessful: Your machine is not connected to the same network as your computer.</li> </ul> <p>Contact the network administrator.</p> <p>You can confirm the IP address or the node name by printing the machine settings report.</p> <p>See <i>Confirming the P-touch Labelling Machines Settings</i> on page 110 for more information.</p>

## Error Messages

When an error message appears on the display, follow the directions provided below.







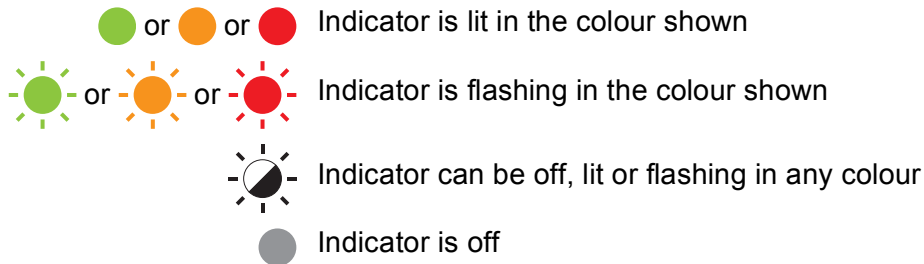















Message	Solution
Tape Removed!	<ul style="list-style-type: none"> <li>Do not remove the tape cassette while printing.</li> </ul>
Text Too Large!	<ul style="list-style-type: none"> <li>Select a smaller font size.</li> <li>The size of transferred symbols has exceeded the label width when the machine is printing the symbols using the vertical orientation. Create the transferred symbol data using a size that fits in the label you are using.</li> </ul>
Unable to use 01!	<ul style="list-style-type: none"> <li>The print head setting is incorrect. Turn the machine off, and then on again.</li> </ul>
Unable to use 02!	<ul style="list-style-type: none"> <li>The motor operation is faulty. Turn the machine off, and then on again.</li> </ul>
High Res/Speed Print Not Available!	<ul style="list-style-type: none"> <li>When using high resolution or high speed printing, you must connect the AC adapter and use only TZe laminated tape with black ink, and print from the computer. Otherwise, print using the standard setting.</li> </ul> <p>You cannot use this function for TZe-FX**1 tape.</p>
Holder Malfunction! (Label)	<ul style="list-style-type: none"> <li>The operation of the label feeding mechanism is faulty. Turn the machine off, and then on again. Check that the tape cassette is installed correctly. If the error continues, contact Brother customer service.</li> </ul>
Adapter Connected or Disconnected!	<ul style="list-style-type: none"> <li>This message appears if you connect or disconnect the AC adapter during printing. To clear the error and print the print job again, press and hold a button other than the  (Power) button. To cancel the print job, press and hold the  (Power) button.</li> </ul>
File Transfer Failed!	<ul style="list-style-type: none"> <li>The model name set for the sent file is incorrect. Create the file using the correct model name.</li> </ul>

## LED Indicators





























The indicators light and flash to indicate the machine status. The symbols used in this section explain the meaning of the different indicator colours and patterns:



















### Label, Power indicator

 (Label)	 (Power)	Condition
		Power is turning off Top cover open
		Idle mode Initialising mode Tape feed and cutting mode
	 (1 time in 1 second)	Transferring data
		Now cooling
		System error 1 System error 2 System error 3
 (1 time in 1 second)		USB host power supply excessive voltage error Mass storage error
 (1 time in 2 seconds)		Label holder error
 (2 times in 1.8 seconds)		Adapter error
		In boot mode
		Reset mode (when the mode is starting)

















**Label, Power indicator**

☐ (Label)	⏻ (Power)	Condition
		Reset mode (when the button is pressed 2/4/6 times)
 (Three times)	 (Three times)	Reset mode (when reset is confirmed)
		Mass storage mode
 (Once)		Mass storage processing mode
		Printing mode
 (1 time in 1 second)		Receiving data
 (2 times in 1.8 seconds)	 (2 times in 1.8 seconds)	Memory full error Communication error
		When blinking alternately: Cutter error  When blinking simultaneously: High temperature error
 (2 times in 1.8 seconds)		Non-compliant tape error
 (1 time in 1 second)		Wrong media error
 (2 times in 1.8 seconds)		No cassette error Media end error
		Top cover open error when printing
 (2 times in 1.8 seconds)	 (2 times in 1.8 seconds)	High resolution/high speed printing error
		Black mark not detected error



### Battery indicator

 (Battery)	 (Power)	Condition
		Rechargeable battery power: full
		Charging
 (1 time in 4 seconds)		Rechargeable battery power: half
 (2 times in 4 seconds)		Rechargeable battery power: low
		Rechargeable battery error
		Rechargeable battery power: empty
		Adapter connection/disconnection error

### Wi-Fi indicator

 (Wi-Fi)	 (Power)	Condition
		No available WPS access point was found
		WPS access point connection error Check the protocol.
 (2 times in 1.8 seconds)		Incorrect security settings
 (2 times in 1.8 seconds)		WPS access point search error
		Wi-Fi on, not connected
		Wi-Fi on, connected
		Wi-Fi off

## Indicator Warnings

Problem	Solution
Received data in buffer	<p>Print data is saved in the buffer. If the machine has not received the complete data, printing will not start.</p> <p>Turn the machine off, and then turn it on again.</p>
Head is cooling down	<p>The thermal head is too hot.</p> <p>The machine stops and resumes printing only after the thermal head has cooled down. The head may become too hot if you are printing a large number of labels.</p> <p>When the thermal head becomes too hot, it may produce imaging on the labels in areas not intended to be printed. To avoid or delay overheating, make sure the machine has adequate ventilation and is not located in an enclosed space.</p> <p>If the machine must cool down because it overheated due to the type of tape cassette you are using or the contents of the label, printing may take longer than usual.</p> <p> <b>Note</b></p> <p>This condition may occur more often when the machine is used at high altitude (more than 10,000 ft (3,048 m)) due to a lower air density available to cool the machine.</p>
Machine is in boot mode	<p>To resolve the issue, contact your Brother dealer or Brother customer service for assistance.</p>
Errors concerning tape cassettes	<p>Check the following:</p> <ul style="list-style-type: none"> <li>■ You are using the correct tape cassette.</li> <li>■ There is enough tape remaining.</li> <li>■ The tape cassette is installed correctly.</li> </ul>
I want to reset an error	<p>I want to reset an error</p> <ol style="list-style-type: none"> <li>1 Open the top cover, and then close it.</li> <li>2 If the error is not reset, press the  (Feed and Cut) button.</li> <li>3 If the error still is not reset, turn the machine off, and then turn it on again.</li> <li>4 If the error still is not reset, contact Brother customer service.</li> </ol>

## P-touch Labelling Machines Specifications

<b>Model Name</b>	<b>PT-D800W</b>
<b>Size</b>	
Dimensions	approx. 338 mm (W) x 188 mm (D) x 173 mm (H) (including keyboard LCD unit)
Weight	approx. 3.4 kg (including keyboard LCD unit)
<b>Printing</b>	
Method	Thermal Transfer
Print head	454 dot/360 dpi High resolution mode: max. 720 dpi × 360 dpi (when connected to a computer) <sup>1</sup>
Print height	32 mm max. (when using 36 mm tape) <sup>2</sup>
Print speed	AC Adapter: max. 60 mm/sec. Battery: 20 mm/sec. - 60 mm/sec. (varies depending on the tape width) Actual print speed varies depending on the conditions.
Cassette	Brother TZe tape cassette (3.5 mm, 6 mm, 9 mm, 12 mm, 18 mm, 24 mm, 36 mm widths) Brother HSe tube cassette (5.8 mm, 8.8 mm, 11.7 mm, 17.7 mm, 23.6 mm widths) Brother FLe label cassette (21 mm x 45 mm)
No. of lines	<ul style="list-style-type: none"> <li>■ TZe tape cassette 36 mm tape: 17 lines; 24 mm tape: 13 lines; 18 mm tape: 10 lines; 12 mm tape: 6 lines; 9 mm tape: 4 lines; 6 mm tape: 3 lines; 3.5 mm tape: 1 line</li> <li>■ HSe tube cassette 23.6 mm tape: 12 lines; 17.7 mm tape: 10 lines; 11.7 mm tape: 6 lines; 8.8 mm tape: 4 lines; 5.8 mm tape: 2 lines</li> </ul>
<b>Memory (local files)</b>	
File storage	max. 99 files
<b>Power Supply</b>	
Adapter	AC adapter (AD9100ESA): 24 V
Battery (Optional)	Li-ion Battery (PA-BT-4000LI): 14.4 V
Auto Power-off	Li-ion Battery (PA-BT-4000LI): 30 min AC adapter (AD9100ESA): 4h (To change the Auto Power-off setting, see <i>Auto Power-Off Time</i> on page 188.)

<b>Model Name</b>	<b>PT-D800W</b>
<b>Interface</b>	
USB	Version 2.0 Full Speed
Wi-Fi	<ul style="list-style-type: none"> <li>■ Wireless Direct: IEEE 802.11n</li> <li>■ Ad-Hoc mode: IEEE 802.11b</li> <li>■ Infrastructure mode: IEEE 802.11b/g/n</li> <li>■ WPS 2.0</li> </ul>
<b>Other</b>	
Operating temperature/humidity	When running: between 10°C and 35°C / between 20% and 80% max. wet bulb temperature: 27°C

- <sup>1</sup> The high resolution mode can be used if the AC adapter is connected and TZe laminated tape with black ink is installed. You cannot use this function for TZe-FX\*\*1 tape.
- <sup>2</sup> Actual character size may be smaller than maximum print height.

## Operating Environment

Item	Specifications	
Operating System	Windows®	Windows Vista® / Windows® 7 / Windows® 8 / Windows® 8.1 / Windows® 10 / Windows Server® 2008 / Windows Server® 2008 R2 / Windows Server® 2012 / Windows Server® 2012 R2
	Mac	OS X v10.9.5 / 10.10.x / 10.11
Hard Disk	Windows®	Disk space: 460 MB or more
	Mac	Disk space: 500 MB or more
Memory	Windows®	Windows Vista® / Windows Server® 2008 / Windows Server® 2008 R2 / Windows Server® 2012 / Windows Server® 2012 R2: 512 MB or more  Windows® 7 / Windows® 8 / Windows® 8.1 / Windows® 10: 1 GB or more (32-bit) or 2 GB or more (64-bit)
	Mac	OS X v10.9.5 / 10.10.x / 10.11: 2 GB or more
Monitor	Windows®	SVGA, high colour or higher graphics card
	Mac	256 colours or more

The compatible operating systems may change. For the latest information, visit our support website at [support.brother.com](http://support.brother.com).

### ■ Brother support website

Please visit our support website at [support.brother.com](http://support.brother.com).

You can find following information:

- Software downloads
- Manuals/Documents
- Frequently Asked Questions (Troubleshooting, Useful tips on using machine)
- Consumable information
- Latest OS compatibility information

The contents of this website are subject to change without notice.

Since some P-touch Editor functions are not available with the P-touch labelling machine, keep the following points in mind when using P-touch Editor to create templates.

You can check a preview of the printed template before the created template is transferred to the machine. See *Transferring the Template to P-touch Transfer Manager* on page 134 for more information.

## Notes on Creating Templates

- The machine is loaded with 14 fonts. Some of the text in the template that is transferred to the machine will be printed using similar fonts and character sizes that are loaded in the machine. As a result, the printed label may differ from the image of the template created in P-touch Editor.
- Depending on the text object setting, the character size may be automatically reduced or some of the text may not be printed. If this occurs, change the text object setting.
- Although character styles can be applied to individual characters with P-touch Editor, styles can be applied to a block of text only with the machine. In addition, some character styles are not available on the machine.
- A numbering field specified with P-touch Editor cannot be transferred.
- Backgrounds specified with P-touch Editor are not compatible with the machine.
- A P-touch Editor layout that uses the split printing function (enlarging the label and printing it on two or more labels) cannot be transferred.
- Only the first 17 lines of text typed in a database field are read by the machine.
- Fields that overflow the print area may not be printed completely.

## Notes on Transferring Templates

- The printed label may differ from the image that appears in the preview area of P-touch Transfer Manager.
- If a barcode not loaded on the machine is transferred to the machine, the barcode will be converted into an image if it is a 2-dimensional barcode. The image of the converted barcode cannot be edited. If the template contains a 1-dimensional barcode that was rotated, an error will occur and the template cannot be transferred.
- All transferred objects that cannot be edited by the machine are converted into images.
- Grouped objects will be converted into a single bitmap, from which the data cannot be edited with the machine keyboard.

## Notes on Transferring Data Other Than Templates

- If the number or order of fields in a database is changed and only the database (\*.csv file) is transferred to update it, the database may not link correctly with the template. In addition, the first line of data in the transferred file must be recognised by the machine as "field names".
- Logos, symbols, and graphics downloaded to the machine will automatically be scaled like the resident font or any of the resident symbol in the library.

## Supported Protocols and Security Features

<b>Interface</b>	Wireless	IEEE 802.11b/g/n (Infrastructure mode) IEEE 802.11b (Ad-Hoc mode) IEEE 802.11n (Wireless Direct mode)
<b>Network (Common)</b>	Protocol (IPv4)	ARP, RARP, BOOTP, DHCP, APIPA (Auto IP), mDNS, WINS, NetBIOS name resolution, DNS Resolver, LPR/LPD, Custom Raw Port/Port9100, FTP Server, TFTP client and server, SNTP client, ICMP, LLMNR responder, SNMPv1/v2c
	Protocol (IPv6)	NDP, RA, DNS Resolver, LPR/LPD, mDNS, Custom Raw Port/Port9100, FTP Server, SNMPv1, TFTP client and server, ICMP, LLMNR responder, SNMPv1/v2c
<b>Network (Security)</b>	Wireless	SSID (32 chr), WEP 64/128 bit, WPA/WPA2-PSK, LEAP, EAP-FAST, PEAP, EAP-TTLS, EAP-TLS

## Types of Network Connections and Protocols

You will find basic information about the advanced network features of the Brother P-touch labelling machine, along with general networking and common terms.

The supported protocols and network features differ depending on the model you are using.

### Types of Network Connections

---

#### Peer-to-Peer printing using TCP/IP

In a Peer-to-Peer environment, each computer directly sends and receives data to each device. There is no central server controlling file access or machine sharing.

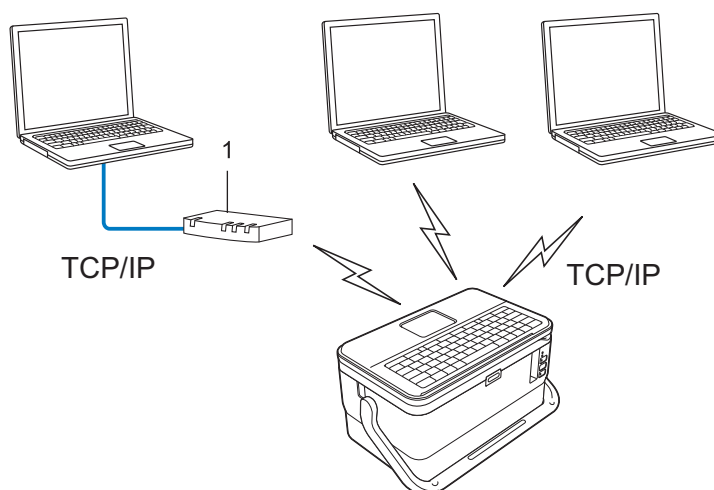

#### 1 Router

- In a smaller network of two or three computers, we recommend the Peer-to-Peer printing method as it is easier to configure than the Network Shared printing method. See *Network Shared printing* on page 215.
- Each computer must use the TCP/IP Protocol.
- Your machine needs an appropriate IP address configuration.
- If using a router, you must configure the Gateway address on the computers and your machine.

## Network Shared printing

In a Network Shared environment, each computer sends data via a centrally controlled computer. This type of computer is often called a “Server” or a “Print Server”. Its job is to control the printing of all print jobs.

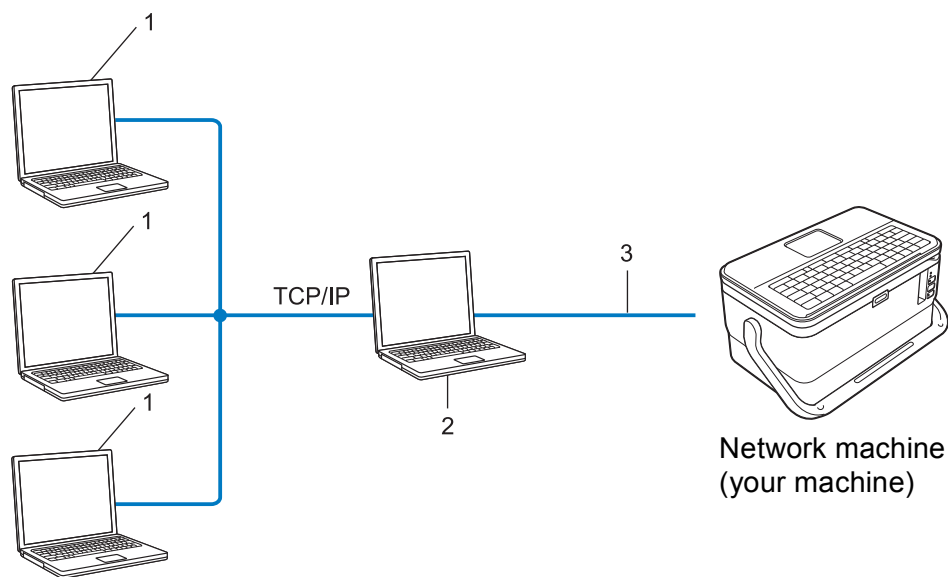

**1 Client computers**

**2 Also known as “Server” or “Print server”**

**3 TCP/IP or USB**

- In a larger network, we recommend using a Network Shared printing environment.
- The “server” or the “print server” must use the TCP/IP print protocol.
- Your machine needs to have an appropriate IP address configuration, except when the machine is connected via the USB interface to the server.

# Configuring Your Machine for a Network

## IP Addresses, Subnet Masks and Gateways

---

To use the machine in a networked TCP/IP environment, you must configure its IP address and subnet mask. The IP address you assign to the print server must be on the same logical network as your host computers. If it is not, you must correctly configure the subnet mask and the gateway address.

### IP address

An IP address is a series of numbers that identifies each device connected to a network. An IP address consists of four numbers separated by dots. Each number is between 0 and 254.

■ For example in a small network, you would normally change the final number:

- 192.168.1.1
- 192.168.1.2
- 192.168.1.3

### How the IP address is assigned to your print server:

If you have a DHCP/BOOTP/RARP server on your network, the print server will automatically obtain its IP address from that server.



#### Note

---

On smaller networks, the DHCP server may also be the router.

---

If you do not have a DHCP/BOOTP/RARP server, the Automatic Private IP Addressing (APIPA) protocol will automatically assign an IP address from the range 169.254.0.1 to 169.254.254.254. The subnet mask is automatically set to 255.255.0.0 and the gateway address is set to 0.0.0.0.

By default, the APIPA protocol is enabled. To disable the APIPA protocol, use BRAdmin Light or Web Based Management (web browser).

## Subnet mask

Subnet masks restrict network communication.

- For example, Computer 1 can communicate with to Computer 2

- Computer 1

IP Address: 192.168.1.2

Subnet Mask: 255.255.255.0

- Computer 2

IP Address: 192.168.1.3

Subnet Mask: 255.255.255.0

The 0 in the Subnet mask signifies that there is no limit to communication at this part of the address. In the example above this means that you can communicate with any device with an IP address that begins with 192.168.1.x. (where x is a number between 0 and 254).

## Gateway (and router)

A gateway is a network point that acts as an entrance to another network and sends data transmitted via the network to an exact destination. The router knows where to direct data that arrives at the gateway. If a destination is located on an external network, the router transmits data to the external network. If your network communicates with other networks, you may need to configure the Gateway IP address. If you do not know the Gateway IP address contact your network administrator.

# Wireless Network Terms and Concepts

## Security Terms

---

### Authentication and encryption

Most wireless networks use some kind of security settings. These security settings define the authentication (how the device identifies itself to the network) and encryption (how the data is encrypted as it is sent on the network). **If you do not correctly specify these options when you are configuring your Brother wireless machine, it will not be able to connect to the wireless network.** Make sure you configure these options carefully.

### Authentication and Encryption methods for a personal wireless network

A personal wireless network is a small network, for example using your machine in a wireless network at home, without IEEE 802.1x support.

To use your machine in an IEEE 802.1x supported wireless network, see *Authentication and Encryption methods for an enterprise wireless network* on page 220.

### Authentication methods

- Open system

Wireless devices are allowed to access the network without any authentication.

- Shared key

A secret pre-determined key is shared by all devices that will access the wireless network.

The Brother wireless machine uses a WEP key as the pre-determined key.

- WPA-PSK

Enables a Wi-Fi Protected Access Pre-shared key (WPA-PSK), which enables the Brother wireless machine to associate with access points using TKIP for WPA-PSK.

- WPA2-PSK

Enables a Wi-Fi Protected Access Pre-shared key (WPA2-PSK), which enables the Brother wireless machine to associate with access points using AES for WPA2-PSK (WPA-Personal).

- WPA/WPA2-PSK

Enables a Wireless Protected Access Pre-shared key (WPA-PSK/WPA2-PSK), which enables the Brother wireless machine to associate with access points using TKIP for WPA-PSK or AES for WPA-PSK and WPA2-PSK (WPA-Personal).

### Encryption methods

- None

No encryption method is used.

- WEP

When using WEP (Wired Equivalent Privacy), the data is transmitted and received with a secure key.

■ TKIP

TKIP (Temporal Key Integrity Protocol) provides per-packet key mixing, a message integrity check and rekeying mechanism.

■ AES

Advanced Encryption Standard (AES) provides stronger data protection using a symmetric-key encryption.

**When [Communication Mode] is set to [Ad-hoc]**

Authentication Method	Encryption Mode
Open System	None
	WEP

**When [Communication Mode] is set to [Infrastructure]**

Authentication Method	Encryption Mode
Open System	None
	WEP
Public Key Authentication	WEP
WPA-PSK	TKIP
WPA2-PSK	AES
WPA/WPA2-PSK	TKIP
	AES

**Network key**

■ Open system/Shared key with WEP

This key is a 64-bit or 128-bit value that must be entered in an ASCII or hexadecimal format.

- 64 (40) bit ASCII:  
Uses five text characters. For example, “WSLAN” (case-sensitive)
- 64 (40) bit hexadecimal:  
Uses 10 digits of hexadecimal data. For example, “71f2234aba”
- 128 (104) bit ASCII:  
Uses 13 text characters. For example, “Wirelesscomms” (case-sensitive)
- 128 (104) bit hexadecimal:  
Uses 26 digits of hexadecimal data. For example, “71f2234ab56cd709e5412aa2ba”

■ WPA-PSK/WPA2-PSK and TKIP or AES, WPA2 with AES

Uses a Pre-Shared Key (PSK) that is eight or more characters in length, up to a maximum of 63 characters.

## Authentication and Encryption methods for an enterprise wireless network

An enterprise wireless network is a large network with IEEE802.1x support. If you configure your machine in an IEEE802.1x supported wireless network, you can use the following authentication and encryption methods:

### Authentication methods

#### ■ LEAP (For wireless network)

Cisco LEAP (Light Extensible Authentication Protocol) has been developed by Cisco Systems, Inc. and uses a user ID and password for authentication.

#### ■ EAP-FAST

EAP-FAST (Extensible Authentication Protocol-Flexible Authentication via Secured Tunnel) has been developed by Cisco Systems, Inc. and uses a user ID and password for authentication, and symmetric key algorithms to achieve a tunnelled authentication process.

The machine supports the following inner authentication methods:

- EAP-FAST/NONE
- EAP-FAST/MS-CHAPv2
- EAP-FAST/GTC

#### ■ PEAP

PEAP (Protected Extensible Authentication Protocol) has been developed by Microsoft Corporation, Cisco Systems and RSA Security. PEAP creates an encrypted SSL (Secure Sockets Layer)/TLS (Transport Layer Security) tunnel between a client and an authentication server, for sending a user ID and password. PEAP provides mutual authentication between the server and the client.

The machine supports the following inner authentication methods:

- PEAP/MS-CHAPv2
- PEAP/GTC

#### ■ EAP-TTLS

EAP-TTLS (Extensible Authentication Protocol Tunnelled Transport Layer Security) has been developed by Funk Software and Certicom. EAP-TTLS creates a similar encrypt SSL tunnel to PEAP, between a client and an authentication server, for sending a user ID and password. EAP-TTLS provides mutual authentication between the server and the client.

The machine supports the following inner authentication methods:

- EAP-TTLS/CHAP
- EAP-TTLS/MS-CHAP
- EAP-TTLS/MS-CHAPv2
- EAP-TTLS/PAP

#### ■ EAP-TLS

EAP-TLS (Extensible Authentication Protocol Transport Layer Security) requires digital certificate authentication both at a client and an authentication server.

## Encryption methods

### ■ TKIP

TKIP (Temporal Key Integrity Protocol) provides a per-packet key mixing a message integrity check and rekeying mechanism.

### ■ AES

Advanced Encryption Standard (AES) provides stronger data protection using a symmetric-key encryption.

### ■ CKIP

The original Key Integrity Protocol for LEAP by Cisco Systems, Inc.

## When [Communication Mode] is set to [Infrastructure]

Authentication Method	Encryption Mode
LEAP	CKIP
EAP-FAST/NONE	TKIP
	AES
EAP-FAST/MS-CHAPv2	TKIP
	AES
EAP-FAST/GTC	TKIP
	AES
PEAP/MS-CHAPv2	TKIP
	AES
PEAP/GTC	TKIP
	AES
EAP-TTLS/CHAP	TKIP
	AES
EAP-TTLS/MS-CHAP	TKIP
	AES
EAP-TTLS/MS-CHAPv2	TKIP
	AES
EAP-TTLS/PAP	TKIP
	AES
EAP-TLS	TKIP
	AES

### **User ID and password**

The following security methods support a user ID less than 64 characters and a password less than 32 characters in length:

- LEAP
- EAP-FAST
- PEAP
- EAP-TTLS
- EAP-TLS (For user ID)

## Symbols

Category	Symbols
Punctuation	. , ? ! " ' : ; - _ \ / & ; i ~ • * @ # %     ^ %o    † ‡
Datacom	
Audio/Visual	
Electrical	
Arrows	
Safety	
Prohibited	
Brackets	( ) [ ] < > « » { }
Mathematics	+ - × ÷ ± = ≥ ≤ ≠ ≥ ≤ > < ∴ ∴ 1/4 1/2 3/4 1/3 2/3 1/5 2/5 3/5 4/5 1/6 5/6 1/8 3/8 5/8 7/8
Greek	α β γ δ φ λ μ Ω Σ
Super/Subscript	° ® © ™ 0 1 2 3 4 5 6 7 8 9 0 1 2 3 4 5 6 7 8 9

Category	Symbols
Bullets	✓ ✔ ● ○ ◎ ■ □ ☒ □ ✕ ★ ☆ ♠ ♡ ♥ ♠ ♦ ◇ ♣ ♣
Currency	\$ ¢ € £ ¥ ₺
Misc.	 



**Note**

The symbols shown in the table may look slightly different on the P-touch labelling machine LCD and when printed.

## Accented Characters

Character	Accented Characters	Character	Accented Characters
a	á à â ä æ ā ą ǎ ā ǎ	n	ñ ñ ń ņ
A	Á Â Ã Ä Å Æ Ā Ą Ą Ā Ą	N	Ñ Ñ ́ ́
c	ç ǰ é	o	ó ò ô ø ö õ œ ö
C	Ç Ć Ć	O	Ó Ò Ô Ø Ö Ö Œ Ó
d	ď ð đ	r	ř ř Ț
D	Ď Ď	R	Ř Ř Ț
e	é è ê ë ę ǽ è ē	s	š š š š ß
E	É È Ê Ë Ę Ě É Ē	S	Š Š Š Š ß
g	ğ ğ	t	ť Ț Ț
G	Ğ Ğ	T	Ť Ť Ț
i	í î ï ï ï ï ï	u	ú û ú ü ı ú ú ú
I	Í Î Ï Ï Ï Ï Ï	U	Ú Û Ü Ü Ț Ú Ú Ú
k	ķ	y	ý ŷ
K	Ķ	Y	Ý ŷ
l	ł ł ł ł	z	ž ž ž
L	Ł Ł Ł Ł	Z	Ž Ž Ž

## Character Attribute

Attribute	Value	Result	Value	Result
Font	Helsinki <sup>1</sup>	ABCabc	Belgium	ȦBCabc
	Brussels	ABCabc	Atlanta	ABCabc
	US	ABCabc	Adams	ABCabc
	Los Angeles	<b>ABCabc</b>	Brunei	<b><i>ABCabc</i></b>
	San Diego	<b>ABCabc</b>	Sofia	<b>ABCabc</b>
	Florida	<b>ABCabc</b>	Germany	ȦBCabc
	Calgary	<i>ABCabc</i>	Letter Gothic <sup>2</sup>	ABCabc

<sup>1</sup> The default font for labels.

<sup>2</sup> The default font for cable labels.

Attribute	Value	Result	Value	Result
Size	<b>Auto</b>	When Auto is selected, the text is automatically adjusted to print in the largest size available for each tape width.	4-90 pt	The character is fixed to the selected size.
Width	x 2	<b>ABCabc</b>	x 2/3	ABCabc
	x 3/2	ABCabc	x 1/2	ABCabc
	x 1	ABCabc		
Style	<b>Normal</b>	ABCabc	I + Bold	<b><i>ABCabc</i></b>
	Bold	<b>ABCabc</b>	I + Outline	<i>ABCabc</i>
	Outline	ABCabc	I + Shadow	<i>ABCabc</i>
	Shadow	ABCabc	I + Solid	<b><i>ABCabc</i></b>
	Solid	<b>ABCabc</b>	Vertical	А м С њ Д С
	Italic	<i>ABCabc</i>	Vertical+ Bold	А м С њ Д С
Line	<b>Off</b>	ABCabc	Underline	<u>ABCabc</u>
	Strike out	<del>ABCabc</del>		

Attribute	Value	Result	Value	Result
Alignment	<b>Left</b>	<b>ABCabc</b>	Right	<b>ABCabc</b>
	Center	<b>ABCabc</b>	Justify	A B C a b c



**Note**

- Factory settings are shown in bold.
- The actual printed font size depends on the tape width, number of characters and number of input lines. When characters reach a minimum size, the selected font will be changed to a default custom font, which is based on the Helsinki style. This allows labels using the smallest text possible on narrow or multi-line labels.
- If 4 point or 5 point is selected for the font size, the text is printed in the Brussels font regardless of the selected font.









# Frames







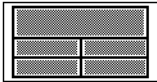
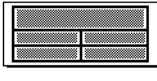



Value	Result	Value	Result	Value	Result
1		2		3	
4		5		6	
7		8		9	
10		11		12	
13		14		15	
16		17		18	
19		20		21	
22		23		24	
25		26		27	
28		29		30	
31		32		33	
34		35		36	
37		38		39	
40		41		42	
43		44		45	
46		47		48	

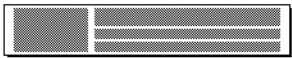



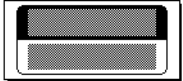
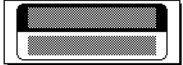

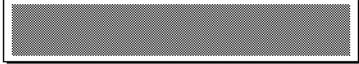
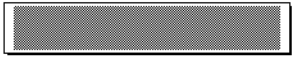
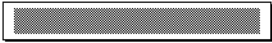
Value	Result	Value	Result	Value	Result
49		50		51	
52		53		54	
55		56		57	
58		59		60	
61		62		63	
64		65		66	
67		68		69	
70		71		72	
73		74		75	
76		77		78	
79		80		81	
82		83		84	
85		86		87	
88		89		90	
91		92		93	
94		95		96	
97		98		99	

# Auto Format



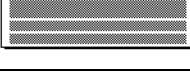
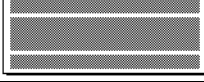
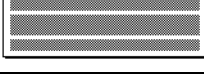
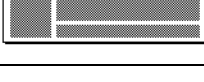
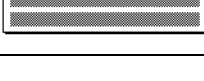







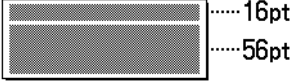
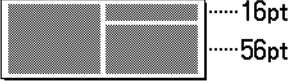
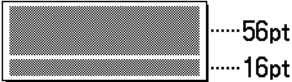
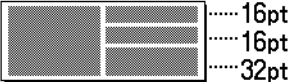
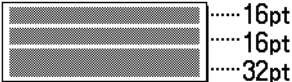

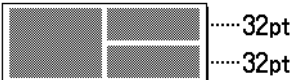
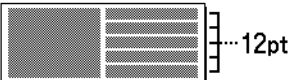

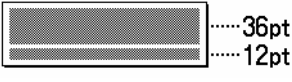
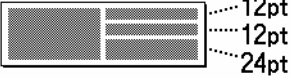
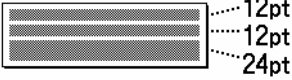

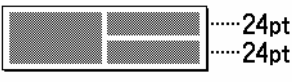
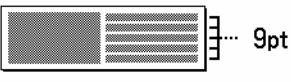

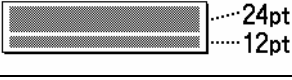
## Template

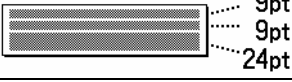

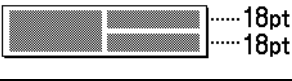
Category	Value	Size	Label layout
Asset Management	Asset Tag 1	36 mm x 70 mm	
	Asset Tag 2	24 mm x 70 mm	
	Asset Tag 3	18 mm x 70 mm	
	Bin Box 1	36 mm x 76 mm	
	Bin Box 2	24 mm x 76 mm	
	Bin Box 3	18 mm x 76 mm	
	Equipment Label 1	36 mm x 58 mm	
	Equipment Label 2	24 mm x 58 mm	
	Equipment Label 3	18 mm x 58 mm	

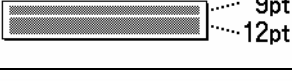
Category	Value	Size	Label layout
Cabinet	Cabinet Label 1	36 mm x 126 mm	
	Cabinet Label 2	24 mm x 126 mm	
	Cabinet Label 3	18 mm x 111 mm	
	Cabinet Label 4	18 mm x 111 mm	
	Cabinet Label 5	36 mm x 160 mm	
	Cabinet Label 6	24 mm x 160 mm	
Signage	Signage 1	36 mm x 126 mm	
	Signage 2	24 mm x 126 mm	
	Signage 3	36 mm x 66 mm	
	Signage 4	24 mm x 66 mm	
File	Binder Spine 1	36 mm x 219 mm	
	Binder Spine 2	24 mm x 219 mm	
	Binder Spine 3	18 mm x 219 mm	
	File Folder Tab	12 mm x 82 mm	
	Divider Tab	12 mm x 42 mm	

Category	Value	Size	Label layout
Address/ID	Address Label 1	36 mm x 70 mm	
	Address Label 2	24 mm x 70 mm	
	Address Label 3	18 mm x 70 mm	
	Name Badge 1	36 mm x 72 mm	
	Name Badge 2	24 mm x 72 mm	
	Name Badge 3	18 mm x 72 mm	
	Name Badge 4	18 mm x 72 mm	
Media	SD Card Label	12 mm x 25 mm	
	USB Flash Memory	9 mm x 25 mm	
	CD Case Spine 1	6 mm x 113 mm	
	CD Case Spine 2	3.5 mm x 113 mm	

## Block Layout

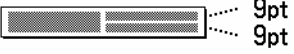
Attribute	Value	Details	Value	Details
36 mm	2LineA	 16pt 56pt	1+2LineB	72pt  16pt 56pt
	2LineB	 56pt 16pt	1+3Line	72pt  16pt 16pt 32pt
	3Line	 16pt 16pt 32pt	1+4Line	72pt  16pt
	1+2LineA	72pt  32pt 32pt	1+5Line	72pt  12pt
24 mm	2LineA	 12pt 36pt	1+2LineB	48pt  12pt 36pt
	2LineB	 36pt 12pt	1+3Line	48pt  12pt 12pt 24pt
	3Line	 12pt 12pt 24pt	1+4Line	48pt  12pt
	1+2LineA	48pt  24pt 24pt	1+5Line	48pt  9pt
18 mm	2LineA	 12pt 24pt	1+2LineB	40pt  12pt 24pt
	2LineB	 24pt 12pt	1+3Line	40pt  12pt
	3Line	 9pt 9pt 24pt	1+4Line	40pt  9pt
	1+2LineA	40pt  18pt 18pt	1+5Line	40pt  9pt
12 mm	2LineA	 9pt 12pt	3Line	 6pt 6pt 12pt
	2LineB	 12pt 9pt	1+2Line	24pt  12pt 12pt

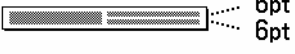
Attribute	Value	Details	Value	Details
9 mm	2LineA	 6pt 12pt	1+2Line	18pt  9pt 9pt
	2LineB	 12pt 6pt		
6 mm	1+2Line	12pt  6pt 6pt		

# Barcodes

## Barcode Settings Table

Attribute	Value
Protocol	<b>CODE39</b> , CODE128, EAN-8, EAN-13, GS1-128 (UCC/EAN-128), UPC-A, UPC-E, I-2/5 (ITF), CODABAR
Width	<b>Small</b>
	Large
Under# (characters printed below barcode)	<b>On</b>
	Off
C.Digit (check digit)	<b>Off</b>
	On (available only for the CODE39, I-2/5, and CODABAR protocols)



**Note**

Factory settings are shown in bold.

## Special Character List

### CODE39

Special Character		
-	\$	+
.	/	%
(SPACE)		

### CODABAR

Special Character		
-	:	.
\$	/	+

**CODE128, GS1-128 (UCC / EAN-128)**

Special Character		
(SPACE)	\	DC3
!	]	DC4
"	^	NAK
#	_	SYN
\$	NUL	ETB
%	.	CAN
&	SOH	EM
,	STX	SUB
(	ETX	ESC
)	EOT	{
*	ENQ	FS
+	ACK	
,	BEL	GS
-	BS	}
.	HT	RS
/	LF	~
:	VT	US
;	FF	DEL
<	CR	FNC3
=	SO	FNC2
>	SI	FNC4
?	DLE	FNC1
@	DC1	
[	DC2	

## Time & Date

### Time & Date Format Options Table

Attribute	Value	
Date	12/31/2099	2099-12-31
	12.31.2099	<b>31/12/2099</b>
	12-31-2099	31.12.2099
	December 31, 2099	31-12-2099
	Dec. 31, 2099	31. December 2099
	2099/12/31	31. Dec. 2099
Time	11:59 PM	<b>23:59</b>



**Note**

Factory settings are shown in bold.

**brother**