



imageRUNNER ADVANCE DX

C3935i / C3930i / C3926i / C3922i

User's Guide

Contents

Introduction	2
Using User's Guide	3
Screen Layout of User's Guide	4
Viewing User's Guide	8
Manuals and Their Contents	10
Notice	11
About the Machine	17
Parts and Their Functions	19
Front Side	20
Back Side	24
Interior	25
2-Sided Single Pass Feeder (Single Pass DADF-C)	26
2-Sided Double Pass Feeder (DADF-BA)	28
Multi-Purpose Tray	30
Paper Drawer	31
Control Panel	33
Turning ON the Machine	35
Turning OFF the Machine	36
Placing Originals and Loading Paper	38
Placing Originals	39
Loading Paper	46
Basic Paper Loading Method	47
Loading Envelopes	53
Loading Preprinted Paper	60
Specifying Paper Size and Type	64
Specifying Paper Size and Type in the Paper Drawer	65
Specifying Paper Size and Type in the Multi-purpose Tray	68
Registering Frequently Used Paper Size and Type for the Multi-purpose Tray	72
Fixing the Paper Size and Type to Use with the Multi-Purpose Tray	75
Registering Free Size Paper (Custom Size Paper)	78
Automatically Selecting the Appropriate Paper Source for a Specific Function	79
Specifying the Output Tray for Preprinted Paper	81
Main Unit Maintenance	83
Regular Cleaning	84
Cleaning the Exterior	85
Cleaning the Platen Glass	86
Cleaning the Feeder	88
Cleaning the Dust-Proof Glass	97
Replacing the Toner Cartridge	99
Replacing the Waste Toner Container	103
Replenishing the Staples (Optional)	106

Replenishing the Staples for the Staple Finisher and Booklet Finisher	107
Replenishing the Staples for the Inner Finisher	112
Replacing the Drum Unit	114
Emptying the Punch Waste (Optional)	118
Emptying the Punch Waste in the Staple Finisher and Booklet Finisher	119
Emptying the Punch Waste in the Inner Finisher	121
Replacement Parts	123
Checking the Remaining Amount of Consumables	128
Clearing Paper Jams	131
Paper Jams in the Feeder	134
Paper Jams in the Main Unit	140
Paper Jams in a Paper Source	145
Paper Jams in a Finisher (Optional)	149
Paper Jams in the Staple Finisher	150
Paper Jams in the Booklet Finisher	153
Paper Jams in the Inner Finisher	157
Clearing Staple Jams (Optional)	161
Staple Jam Has Occurred in the Staple Finisher	162
Staple Jam Has Occurred in the Booklet Finisher	164
Staple Jam Has Occurred in the Inner Finisher	168
Options	171
Optional Equipment	173
Cassette Feeding Unit-AW	177
Media Adjustment kit-A	178
Inner Finisher-L/Inner 2/4 Hole Puncher-D/Inner 4 Hole Puncher-D	179
Staple Finisher-AE/Booklet Finisher-AE/2/4 Hole Puncher Unit-A/4 Hole Puncher Unit-A	191
Inner 2way Tray-M	205
Copy Tray-T	206
Platen Cover-Y	207
Copy Card Reader	208
Numeric Keypad	210
ADF Access Handle-A	212
Optional Equipment Supporting Specific Functions	213
Hardware Specifications	215
Main Unit	216
2-Sided Single Pass Feeder (Single Pass DADF-C)	220
2-Sided Double Pass Feeder (DADF-BA)	222
Available Paper	224
Cassette Feeding Unit-AW	233
Media Adjustment kit-A	234
Inner Finisher-L	235
Staple Finisher-AE / Booklet Finisher-AE	237
Inner 2way Tray-M	240
Copy Tray-T	241
Copy Card Reader	242

Setting Up	245
Preparations Required Before Use	246
Preventing Unauthorized Access	248
Setting up Using the Setup Guide	250
Logging in as an Administrator	259
Setting the Date/Time	261
Setting up the Network Environment	263
Canceling the Network Setting Lock	266
Selecting the Network Connection Method	267
Connecting to a Wired LAN	269
Connecting to a Wireless LAN	270
Setting Up the Connection Using WPS Push Button Mode	272
Setting Up the Connection Using WPS PIN Code Mode	273
Setting Up Connection by Selecting a Wireless Router	274
Setting Up a Connection by Specifying Detailed Settings	275
Checking the SSID and Network Key	277
Setting an IP Address	278
Setting an IPv4 Address	279
Setting an IPv6 Address	281
Setting the IPv4 Address of the Sub Line	284
Adapting to the Network Environment	285
Making Ethernet Settings	286
Setting the Wait Time When Connecting to a Network	288
Making DNS Settings	289
Making SMB Settings	294
Making WINS Settings	297
Making WebDAV Settings	298
Registering the LDAP Server	299
Monitoring and Controlling via SNMP	303
Setting Static Routing	307
Other Network Settings	309
Configuring System Data Communication	311
Installing Drivers	313
Fax Line Settings	314
Setting E-mail/I-Fax Communication	316
Setting the Advanced Space of the Machine	320
Setting Advanced Space to Public	321
Connecting to the Other Devices	326
Basic Operations	329
Using the Touch Panel Display	331
Basic Screens on the Touch Panel Display	332
Items Displayed on the <Home> Screen	335
Timeline Display Specifications	339
Items Displayed in the Timeline	341

Basic Operation of the Touch Panel Display	347
Entering Characters	353
Logging into the Machine	355
List of Items That Can Be Personalized	357
Customizing the Touch Panel Display	360
Customizing the <Home> Screen	363
Creating a Shortcut for a Frequently Used Function	365
Registering a Combination of Frequently Used Functions	367
Customizing the Basic Features Screen	370
Registering Frequently Used Settings and Destinations as Personal Buttons/Shared Buttons on the <Home> Screen	372
Registering Personal Buttons/Shared Buttons	373
Switching the Displayed Language	377
Registering Shortcuts for Frequently Used Settings/Registered Items	379
Customizing the Screen Display Appearance and the Operational Conditions	380
Canceling Send/Print Jobs	383
Setting Sounds	384
Entering Sleep Mode	387
Registering Destinations	389
About the Address Books of the Machine	391
Registering Destinations in the Address Book	394
Registering Multiple Destinations as a Group	405
Editing the Registered Destinations in the Address Book	408
Registering a Destination in a One-Touch Button	410
Registering a Group in a One-Touch Button	412
Editing the Registered Destinations in One-Touch Buttons	413

Copying 416

Copy Basic Features Screen	418
Basic Copy Operations	420
Cancelling Copying	431
Enhancing and Adjusting Copy Quality	433
Selecting the Type of Original for Copying	434
Adjusting Sharpness for Copying (Sharpness)	436
Erasing Dark Borders When Copying (Erase Frame)	437
Inverting Colors (Nega/Posi)	439
Adjusting the Color	440
One Touch Color Mode	443
Copying Efficiently	445
Copying Multiple Originals onto One Sheet (N on 1)	446
Copying a Facing Page Original as Two Separate Pages	448
Copying Different Size Originals Together (Different Size Originals)	451
Copying Separately Scanned Originals Together (Job Build)	453
Checking the Copy Results	455
Copying Immediately by Interrupting Other Jobs	458

Functions Useful for Making and Managing Material	459
Finishing by Collating/Grouping	460
Finishing with the Stapler	462
Other Finishing Functions	464
Attaching Numbers and Symbols to Copies	465
Making Booklets	468
Making Booklets (Booklet Copying)	469
Setting Binding Margins	473
Adding a Cover and Back Cover	475
Useful Copy Functions	477
Copying Free Size Originals	479
Mirroring Images (Mirror Image)	480
Shifting the Image	481
Copying with the Image Repeated (Repeat Images)	483
Inserting Sheets and Chapter Pages (Insert Sheets)	485
Inserting Sheets When Copying Onto Transparencies	488
Combining Jobs with Different Settings Into a Single Job (Merge Job Blocks)	490
Storing Copy Documents in the Machine	493
Notifying You of the Completion of Copying by E-Mail	495
Making ID Card Copies	497
Area Designation	499
Enlarging an Image to Make a Poster	503
Skipping Blank Pages When Printing	507
Restricting Copying of Confidential Documents	509
Embedding the "TOP SECRET" Text (Secure Watermark)	510
Reducing Copying Operations	513
Recalling Previously Used Copy Settings (Previous Settings)	514
Changing the Settings Quickly (Express Copy Screen)	516

Faxing 519

Fax Basic Features Screen	521
Basic Operations for Sending Faxes	524
Canceling Sending Faxes	540
Receiving Faxes	542
Sending Faxes Successfully	544
Checking Scanned Images Before Sending (Preview)	545
Checking the Connection to the Recipient Before Sending (Direct Send)	547
Sending Faxes Manually (Manual Sending)	549
Notifying You by E-Mail of the Completion of Sending	551
Simplifying Sending Operations	553
Sending Different Size Originals Together (Different Size Originals)	554
Sending Separately Scanned Documents Together (Job Build)	555
Recalling Previously Used Settings for Sending (Previous Settings)	557
Useful Functions When Sending	559

Sending at a Specified Time	560
Saving a Copy of a Sent Document	562
Various Receiving Methods	565
Saving Received Documents in the Machine (Memory Reception)	566
Keeping Received Documents Private	569
Forwarding Received Documents Automatically	571
Checking Status and Log for Sent and Received Documents	574
Sending Faxes from Your Computer (PC Fax)	577
Sending PC Faxes	578
Using Internet Faxes (I-Fax)	582
Sending I-Faxes	583
Receiving I-Faxes	591
Using Remote Faxes	592

Printing 595

Printing From a Computer	597
Canceling Printing	600
Checking the Printing Status and History	602
Printing from an External Network (IPP Printing)	604
Advanced Functions for Printing	607
Printing Documents Retained in the Machine (Forced Hold Printing)	608
Printing at a Specified Time (Scheduled Printing)	612
Printing With Settings Disabling Unauthorized Copying	614
Various Printing Methods	616
Directly Printing Files without Opening Them	617
Printing Using a Virtual Printer	619
Printing From Memory Media (Media Print)	622
Copying Files to a Folder for Printing (Hot Folder)	623
Printing Using the Microsoft Cloud Service (Universal Print)	627
Configuring the Universal Print User Settings	631

Scanning 635

Scan Basic Features Screen	637
Basic Operations for Scanning Originals	640
Checking Status and Log for Scanned Documents	656
Scanning Clearly	658
Adjusting Image Quality	659
Adjusting Density	660
Adjusting Sharpness When Scanning (Sharpness)	661
Erasing Dark Borders When Scanning (Erase Frame)	662
Scanning Efficiently	664
Sending/Saving Different Size Originals Together (Different Size Originals)	665
Scanning a Facing Page Original and Storing/Sending it as Two Separate Pages	666
Scanning to Make a Booklet (Booklet Scan)	668

Sending/Saving Separately Scanned Documents Together (Job Build)	670
Useful Scanning Functions	672
Skipping Blank Pages When Scanning	673
Checking Scanned Originals Before Sending/Saving (Preview)	675
Sending/Saving at a Specified Time	677
Notifying You by E-Mail of the Completion of Sending/Saving	679
Scanning with the OCR Function	681
Enhancing the Security of Electronic Files	686
Recalling Previously Used Settings for Sending/Saving (Previous Settings)	691
Setting a File Name	693
Specifying E-Mail Settings	695
Using Your Computer to Scan (Remote Scan) (Windows)	697
Using Color Network ScanGear 2	698
Scanning Originals from an Application	700
Using WSD	702
Scanning Originals Using WSD (WSD Scan)	703

Using Storage Space 706

Using as a Simple File Server	708
Saving Documents in the Advanced Space	709
Accessing the Advanced Space from a Computer	711
Working with Files and Folders in the Advanced Space	713
Creating the Personal Space in the Advanced Space	717
Printing Files in the Advanced Space	718
Working with Other Devices	720
Saving Documents in Other Devices	721
Working with Files and Folders in Other Devices	722
Printing Files in Other Devices	723
Making Simple Edits to Files	724
Saving Documents in the Mail Box	725
Editing Files in the Mail Box	729
Printing Files in the Mail Box	734
Sending Files in the Mail Box	736
Specifying the Mail Box Settings	737
Working with Data in Memory Media	739
Saving Documents in Memory Media	741
Working with Files and Folders in Memory Media	743
Printing Files in Memory Media	747
Setting Screen and Operations for Scanning to Save	749
Setting Screen and Operations for Printing Saved Files	752
Storage Locations and File Formats for Each Mode	761

Linking with Mobile Devices 764

Connecting with Mobile Devices	765
---	-----

Connecting Directly	766
Utilizing the Machine through Applications	770
Using AirPrint	773
Printing with AirPrint	778
Scanning with AirPrint	781
Faxing with AirPrint	783
If AirPrint Cannot Be Used	785
Printing with Default Print Service (Android)	786

Managing the Machine 790

Applying a Security Policy to the Machine	792
Using a Password to Protect the Security Policy Settings	793
Configuring the Security Policy Settings	795
Security Policy Setting Items	797
Managing Users	803
Configuring the Personal Authentication Management Settings	806
Registering User Information in the Local Device	809
Importing/Exporting User Data	813
Adding and Editing User Information in a CSV File	818
Registering Server Information	823
Configuring the Authentication Functions	829
Using Personal Authentication to Manage Printing/Faxing/Remote Scanning via a Computer	837
Using Other Convenient Personal Authentication Management Functions	838
Setting the Department ID Management	839
Changing the System Manager ID and PIN	840
Configuring the Department ID Management Settings	842
Using Department IDs to Manage Printing or Remote Scanning via Computer	845
Configuring Personal Folders	846
Using ACCESS MANAGEMENT SYSTEM	849
Deleting User Setting Information	850
Configuring the Network Security Settings	852
Restricting Communication by Using Firewalls	854
Specifying IP Addresses in Firewall Settings	855
Specifying MAC Addresses in Firewall Settings	858
Configuring the Firewall of the Sub Line	859
Setting a Proxy	862
Configuring the Key and Certificate for TLS	864
Generating the Key and Certificate for Network Communication	867
Configuring the IPSec Settings	869
Configuring the IEEE 802.1X Authentication Settings	874
Restricting the Machine's Functions	877
Restricting Access to Address Book and Sending Functions	878
Restricting Use of the Address Book	879
Limiting Available Destinations	882
Restricting the Fax Sending Functions	884
Restricting Printing from a Computer	886

Restricting the Use of Memory Media	889
Increasing the Security of Documents	890
Printing User Information on Documents	891
Embedding Invisible Text (Forced Secure Watermark)	893
Adding a Digital Signature to Sent Files	895
Generating a Device Signature Certificate	896
Registering a User Signature Certificate	897
Managing the Machine from a Computer (Remote UI)	900
Starting the Remote UI	902
Checking the Status and Logs	906
Turning OFF/Restarting the Machine	911
Registering Destinations via the Remote UI	912
Sharing an Address List with Specific Users	916
Registering User Groups	918
Registering a Key and Certificate for Network Communication	920
Configuring the Expiration Check Method for Received Certificates	924
Generating a Key and Certificate Signing Request (CSR)	926
Retrieving/Updating a Certificate from an SCEP Server	929
Managing Stored Files	935
Managing the Logs	941
Importing/Exporting the Setting Data	946
Importing/Exporting All Settings	950
Importing/Exporting the Settings Individually	954
Address Book Items	960
Backing Up/Restoring Data	965
Updating the Firmware	970
Updating the Firmware (Distribution)	972
Setting Scheduled Updates	975
Displaying Messages from the Administrator	977
Configuring the Visual Message Function	979
Sending E-Mail Notification When an Error Occurs	984
Installing System Options	986
Synchronizing Settings for Multiple Canon Multifunction Printers	988
Starting Setting Synchronization	991
Specifying Detailed Synchronization Settings (Server Machine or Server/Client Machine)	995
Switching the Machines to Synchronize	1000
Distributing the Device Information to Other Canon Multifunction Printers	1005
Registering the Device Information Destinations	1007
Performing User Authentication when Distributing Device Information	1009
Distributing the Device Information	1011
Checking the Results of Device Information Distribution	1014
Managing Storage Device Data	1015
Initializing All Data/Settings	1016
Using TPM	1018

Functions Linked to Cloud Service	1022
Checking the Number of Pages for Copy/Print/Fax/Scan	1025
Printing Reports and Lists	1026
Checking the Options Installed on This Machine	1038
Paper Type Management Settings	1039
Adjusting the Image Position	1044
Adjusting the Secondary Transfer Voltage	1047

Settings/Registration 1054

<Preferences>	1057
<Paper Settings>	1059
<Display Settings>	1063
<Timer/Energy Settings>	1072
<Network>	1080
<TCP/IP Settings>	1092
<IPv4 Settings>	1110
<IPv6 Settings>	1112
<DNS Settings>	1115
<Firewall Settings>	1118
<IPv4 Address Filter>	1120
<IPv6 Address Filter>	1123
<MAC Address Filter>	1126
<Wireless LAN>	1127
<Direct Connection Settings>	1129
<Sub Line Settings>	1134
<Firewall Settings>	1136
<Settings for System Data Communic.>	1139
<External Interface>	1141
<Accessibility>	1143
<Adjustment/Maintenance>	1145
<Adjust Image Quality>	1146
<Adjust Action>	1151
<Maintenance>	1154
<Check Maintenance Method>	1156
<Initialize After Replacing Parts>	1160
<Function Settings>	1161
<Common>	1163
<Paper Feed Settings>	1165
<Paper Output Settings>	1168
<Print Settings>	1172
<Output Report Default Settings>	1178
<Secure Watermark Settings>	1179
<Scan Settings>	1184
<Generate File>	1190
<Set Authentication Method>	1195
<Copy>	1197

<Printer>	1201
Output Report	1205
Custom Settings	1206
UFR II	1212
PCL	1213
PS	1215
Imaging	1217
PDF	1219
XPS	1221
Utility	1223
<Send>	1224
<Output Report>	1225
<Common Settings>	1226
<E-Mail/I-Fax Settings>	1239
<Fax Settings>	1249
<Set Line>	1259
<Remote Fax TX Settings>	1262
<Remote Fax Settings>	1265
<Receive/Forward>	1266
<Output Report>	1267
<Common Settings>	1268
<Set Fax/I-Fax Inbox>	1273
<Fax Settings>	1279
<Store/Access Files>	1282
<Common Settings>	1283
<Scan and Store Settings>	1284
<Access Stored Files Settings>	1286
<Mail Box Settings>	1288
<Settings for All Mail Boxes>	1290
<Box Security Settings>	1291
<Advanced Space Settings>	1292
<Network Settings>	1297
<Memory Media Settings>	1300
<Print>	1301
<Web Access>	1307
<Set Destination>	1310
<Acquire Remote Address Book>	1318
<Make Remote Address Book Open>	1320
<Management Settings>	1321
<User Management>	1322
<Authentication Management>	1325
<Keyboard Authentication>	1330
<Device Management>	1332
<Limited Functions Mode>	1344
<Manage Personal Settings>	1346
<License/Other>	1348
<MEAP Settings>	1353
<Data Management>	1356

<Import/Export>	1358
<Security Settings>	1360
<Authentication/Password Settings>	1363
<Authentication Function Settings>	1364
<Password Settings>	1366
<Encryption Settings>	1371
Volume Settings (Volume Settings)	1373

Adjusting Print and Finish Quality 1376

Adjusting Gradation	1378
Adjusting Density	1381
Correcting Uneven Density	1382
Correcting Color Mismatch	1385
Making Colors More Vivid	1386
Adjusting Image Size	1387
Setting the Dither Pattern	1388
Reducing Toner Used When Color Printing	1389
Adjusting the Saddle Stitch Position	1390
Adjusting the Saddle Stitch Folding Position	1391
Adjusting the Paper Folding Position	1392
Registering a Color Profile for Printing	1393

Troubleshooting 1398

If the Machine Does Not Operate	1400
Cannot Print	1402
Problems with Printing Results	1403
Problems with Faxes	1407
Problems with Scanning	1409
Problems with the Network	1411
Problems with Security	1415
Problems with MEAP	1416
Other Problems	1418
A Message or a Number Starting with "#" (an Error Code) Is Displayed	1421
A Message Saying to Contact a Local Authorized Canon Dealer Is Displayed	1422
Countermeasures for Each Message	1425
Countermeasures for Each Error Code	1469

Implementing Security Measures 1498

Various Security Functions	1499
---	-------------

Appendix 1506

Third Party Software	1507
Feature Highlights	1508
Operability	1509

Utilizing Personalization	1510
Productivity	1518
Image Quality	1519
Manageability	1520
Building a Dual Network Environment	1522
Reliability	1526
Office Compatibility	1528
The List of System Functions and Items	1529
Home	1530
Copy	1532
Fax	1534
Scan and Send	1536
Scan and Store	1538
Access Stored Files	1545
Fax/I-Fax Inbox	1554
Print	1556
MEAP	1557
Installing MEAP Applications	1559
Managing MEAP Applications	1562
Managing MEAP Application Licenses	1567
Changing Login Services	1569
Basic Windows Operations	1574
System Specifications	1577
Fax Function	1578
Send Functions	1580
Printer Functions	1582
Storage Space Functions	1585
Management Functions	1586
System Environment	1593
Network Environment	1595
System Options	1597

Introduction

Introduction	2
Using User's Guide	3
Screen Layout of User's Guide	4
Viewing User's Guide	8
Manuals and Their Contents	10
Notice	11

Introduction

961F-000

This chapter describes the instructions on how to use the User's Guide, disclaimers, copyright information, and other important information for customers. Read this chapter as necessary.

■ Manuals for the Machine

This section describes the different manuals you can refer to for information on how to use the User's Guide (this manual) and the machine's functions and operating procedures.



- ▶ **Using User's Guide(P. 3)**
- ▶ **Manuals and Their Contents(P. 10)**

■ Disclaimers and Copyright

See this section for disclaimers and copyright information.

- ▶ **Notice(P. 11)**

Using User's Guide

961F-001

The User's Guide is a manual that can be viewed on your computer or smartphone, etc. This section describes the screen layout of the User's Guide and how to view the User's Guide. It also describes how to make settings for the display of the User's Guide.

■ Screen Layout of User's Guide

This section explains the User's Guide screen layout and how to use the buttons on the screen. ▶ **Screen Layout of User's Guide(P. 4)**

■ Viewing User's Guide

This section describes what you should be familiar to when viewing the User's Guide, including the meanings of the marks used in the User's Guide and how the buttons on the touch panel display and the computer screen are represented in the User's Guide. ▶ **Viewing User's Guide(P. 8)**

■ Setting the Display of the User's Guide

You can change the character size used in the User's Guide, and switch the screen layout to one that is appropriate to the device on which the User's Guide is displayed.

NOTE

- If you are unable to view the manual in PDF format, download Adobe Acrobat Reader from the Adobe Systems website (<https://get.adobe.com/reader/>).

How to find the topic you are looking for

Search the contents

- You can find the page you are looking for by selecting the topic from the Contents on the left side of the screen.

Search by keyword

- Perform a search by entering a keyword, such as "fax" or "wireless LAN," and the pages containing the keyword are displayed. You can find the page you are looking for from those results. You can also enter phrases such as "connecting to a network." The keyword search also supports the AND Boolean to search for multiple keywords. For the details of the search screen and how to operate the screen, see ▶ **Search(P. 6)** .

Screen Layout of User's Guide

961F-002

The User's Guide is divided into different screens, and the content of each screen varies.

Top Page

Appears when the User's Guide starts.

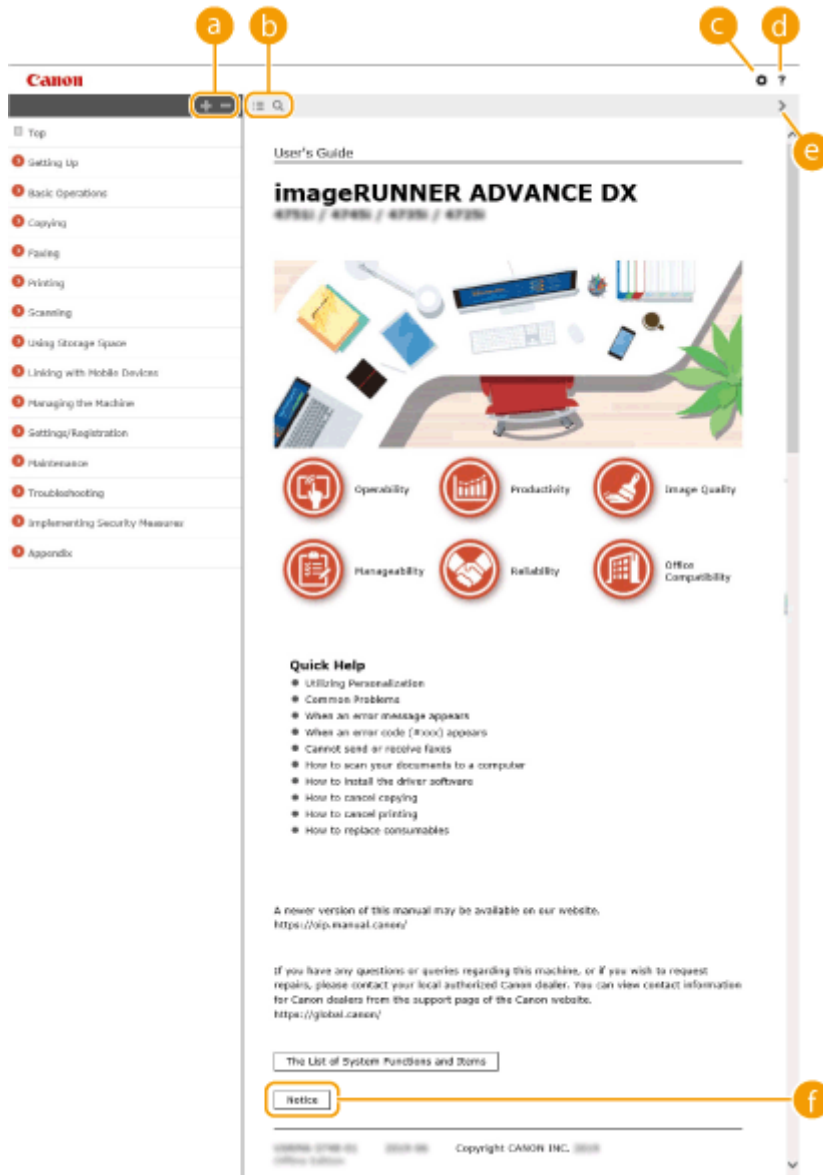

Click to display all items underneath chapters. Click to return to the original list.



Click to switch between the table of contents and the search display. When the table of contents is displayed, each click on switches between hiding and showing the display. When the search display is shown, each click on switches between hiding and showing the display.



Click to specify settings such as text size, layout, and display method for the User's Guide.



Click to display information on how to view the User's Guide, how to perform a search, and other information.



Click to display the previous or following topic.



Click to view important information you should know when using the machine.

Topic Page

Contains information about how to configure and use the machine.

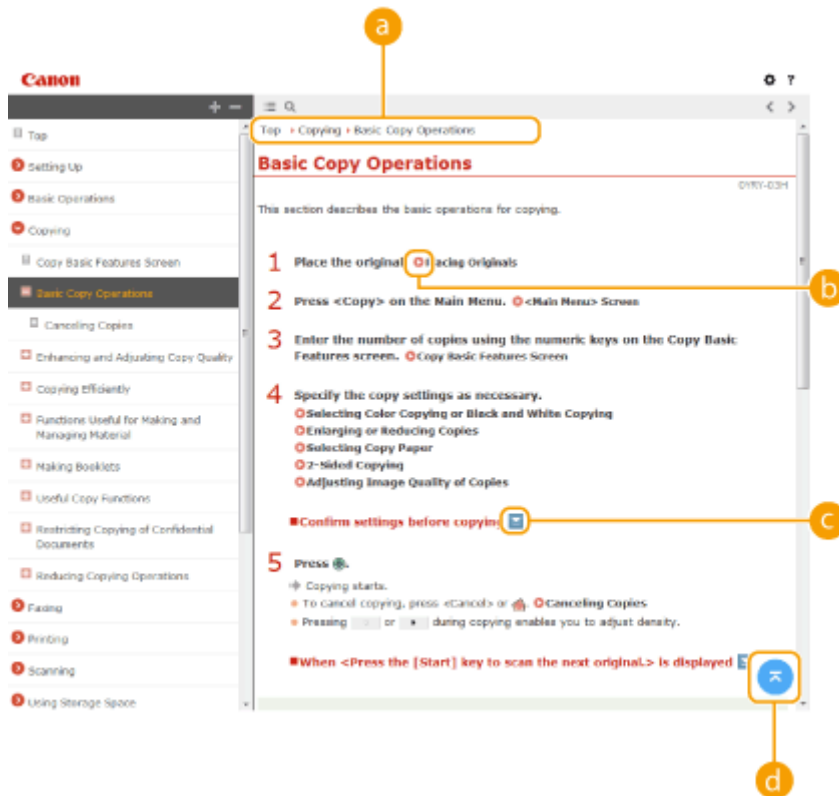

a Navigation

See what chapter topic you are currently viewing.





Click to go to the corresponding page. To return to the previous page, click "Back" on your Web browser.

NOTE:

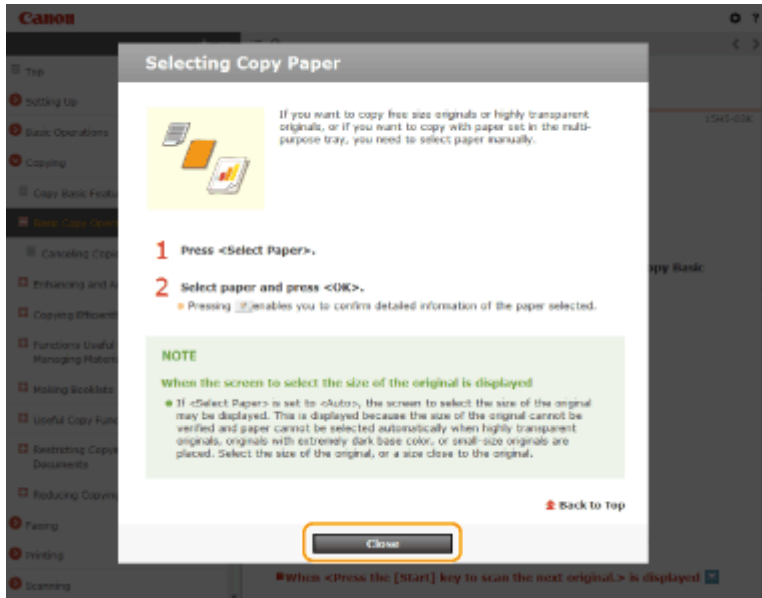
- When you click the icon, the current page may go dark and a pop-up window may appear. To return to the page, click [Close] in the pop-up window.



c  /  Click  to display the hidden detailed descriptions. Click  to close the detailed descriptions.

d  Click to return to the page top.

Search

Click  to display the search screen. Contains a text box to perform a search by keyword and find the page you are looking for.



a [Enter keyword(s) here]

Enter a keyword or keywords and click  to display the search results. You can search for pages containing all the keywords by separating the keywords by a space (blank). Also you can only search for pages containing an exact phrase by enclosing the keywords in double quotation marks.

b Search result

Displays the search results of the pages that contain the specified keywords. From the results, locate the page you are looking for and click the topic title of the page.

NOTE:

- The keywords appear in bold in the pages displayed as search results.

Viewing User's Guide

961F-003

This section describes the marks, buttons, screens, and other items used in the User's Guide. The warnings and cautions are also given in the "Important Safety Instructions" included with the machine. See also these instructions.

Marks

Cautions regarding safety, restrictions and cautions regarding the handling of the machine, useful tips, and other information are indicated using the marks below.



Indicates a warning concerning operations that may lead to death or injury to persons if not performed correctly. To use the machine safely, always pay attention to these warnings.



Indicates a caution concerning operations that may lead to injury to persons if not performed correctly. To use the machine safely, always pay attention to these cautions.



Indicates an operation that must not be performed. Read these items carefully, and make sure not to perform the described operations.



Indicates operational requirements and restrictions. Be sure to read these items carefully to operate the machine correctly, and avoid damage to the machine or property.

NOTE



Indicates a clarification of an operation, or contains additional explanations for a procedure.

TIPS

Indicates useful functions or tips for using the machine.

Keys and buttons

Buttons displayed on the touch panel display and buttons on the computer screen are indicated as follows.

Type	Example
Buttons on the touch panel display*	<Function Settings> <Cancel>   (Start)  (Stop)
Buttons and other text interfaces displayed on the computer display	[Preferences] [OK]

* Operation to touch a button on the touch panel display is indicated as "Press" in the User's Guide.

Screen

Screens used in the User's Guide may differ from the screen display of your machine depending on the model, optional equipment, and version.

NOTE

- Depending on the OS you are using, a portion of the indicated screen content may differ from your computer.

- The screen content for drivers and software may differ due to version upgrades.

Illustrations

Illustrations used in the User's Guide are from "imageRUNNER ADVANCE DX C3935i" with the following options installed unless otherwise specifically noted.

- Single Pass DADF-C
- Cassette Feeding Unit-AW



Function Descriptions











The User's Guide covers the functions of multiple model series. Note that, depending on your model and options, some of the functions described may not apply to your machine.

If your machine is of the model dedicated to printing only

The machine dedicated to printing only cannot be used for any other functions than printing. Although this Guide contains the descriptions of the functions and operations for copying, faxing, and scanning as well as printing, please read only the necessary descriptions to use your machine.

Manuals and Their Contents

The following manuals are included with the machine. Refer to them as necessary.

Important Safety Instructions		The content described in this manual is for the prevention of damage to property and injury to users of the machine and others. 
Setup Guide		This manual outlines the initial settings on the machine required when the machine is turned on for the first time; and describes how to install the software and driver. 
User's Guide (This Manual)		This manual describes all the functions of the machine in a manual that is viewed using a Web browser. You can browse information by category or enter a keyword to search for pages on a specific topic. ▶ Using User's Guide(P. 3)
Setting the Machine (PS/PCL/UFR II Printer)		This manual, viewable using a Web browser, describes how to use the PS/PCL/UFR II printer. It can be viewed from the online manual Web site.
Restrictions on Combinations of Copy Functions		This manual, viewable using a Web browser, describes the combinations of settings that are unavailable when copying and using more than one function at a time. It can be viewed from the online manual Web site.
ACCESS MANAGEMENT SYSTEM		This manual, viewable using a Web browser, describes how to use ACCESS MANAGEMENT SYSTEM. It can be viewed from the online manual Web site.
Web Access		This manual, viewable using a Web browser, describes how to use the Web Access functions of the operation panel. It can be viewed from the online manual Web site. Web Access
Setup for Linking with Mobile Devices Administrator Guide		This is a PDF manual describing combined use of the machine with a mobile device. It can be viewed from the online manual Web site. Setup for Linking with Mobile Devices Administrator Guide

Manuals with the  icon can be found [here](#) .

Notice

961F-006

■ IPv6Ready Logo



The protocol stack included in this machine has obtained the IPv6 Ready Logo Phase-2 established by the IPv6 Forum.

■ Product Information required by COMMISSION REGULATION (EU) No 801/2013 amending Regulation (EC) No 1275/2008

Power consumption of the product in networked standby if wired network ports are connected and all wireless network ports are activated (if they are available at the same time).

Model Name	Power consumption of the product in networked standby
imageRUNNER ADVANCE DX C3935i / C3930i / C3926i / C3922i	3.0 W or less

NOTE

- The above value(s) are the actual values for single machine, chosen arbitrarily, and may therefore vary from the value of the machine in use. Optional network ports are not connected and/or activated in the measurement.

■ EU WEEE and Battery Directives

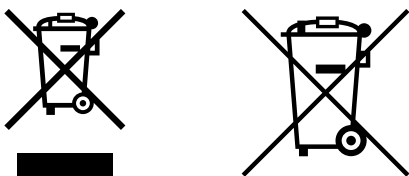

Only for European Union and EEA (Norway, Iceland and Liechtenstein)

These symbols indicate that this product is not to be disposed of with your household waste, according to the WEEE Directive (2012/19/EU), the Battery Directive (2006/66/EC) and/or national legislation implementing those Directives.

If a chemical symbol is printed beneath the symbol shown above, in accordance with the Battery Directive, this indicates that a heavy metal (Hg = Mercury, Cd = Cadmium, Pb = Lead) is present in this battery or accumulator at a concentration above an applicable threshold specified in the Battery Directive.

This product should be handed over to a designated collection point, e.g., on an authorized one-for-one basis when you buy a new similar product or to an authorized collection site for recycling waste electrical and electronic equipment (EEE) and batteries and accumulators. Improper handling of this type of waste could have a possible impact on the environment and human health due to potentially hazardous substances that are generally associated with EEE.

Your cooperation in the correct disposal of this product will contribute to the effective usage of natural resources.

For more information about the recycling of this product, please contact your local city office, waste authority, approved scheme or your household waste disposal service or visit www.canon-europe.com/sustainability/approach/.

■ Environmental Information

Reducing your environmental impact while saving money

Power Consumption and Activation Time

The amount of electricity a device consumes depends on the way the device is used. This product is designed and set in a way to allow you to reduce your electricity costs. After the last print it switches to Ready Mode. In this mode it can print again immediately if required. If the product is not used for a time, the device switches to its Power Save Mode. The devices consume less power (Watt) in these modes.

If you wish to set a longer Activation Time or would like to completely deactivate the Power Save Mode, please consider that this device may then only switch to a lower energy level after a longer period of time or not at all. Canon does not recommend extending the Activation Times from the optimum ones set as default.

Energy Star®

The Energy Star® programme is a voluntary scheme to promote the development and purchase of energy efficient models, which help to minimise environmental impact.

Products which meet the stringent requirements of the Energy Star® programme for both environmental benefits and the amount of energy consumption will carry the Energy Star® logo accordingly.

Paper types

This product can be used to print on both recycled and virgin paper (certified to an environmental stewardship scheme), which complies with EN12281 or a similar quality standard. In addition it can support printing on media down to a weight of 64g/m².

Lighter paper means less resources used and a lower environmental footprint for your printing needs.

Duplex printing (Standard duplex printing products only)

Duplex printing capability enables you to print on both sides automatically, and therefore helps to reduce the use of valuable resources by reducing your paper consumption.

The duplex function has been auto enabled during the set up and driver installation and Canon strongly recommends that you do not disable this function. You should continue to use the duplex function to reduce the environmental impact of your work with this product at all times.

■ When disposing of used toner cartridges

- To protect the environment and make more effective use of resources, Canon promotes the recovery and recycling of used toner cartridges. Please cooperate in the recovery of toner cartridges (resource reuse). For details on resource reuse, see the Canon website:

global.canon/ctc

When disposing of toner cartridges, pack them in their original packaging to prevent toner dispersal and dispose of the cartridges in accordance with your local government instructions.

■ Installation

- If you find the machine's operation to be noisy in some operating modes or due to your surroundings, we recommend setting up the machine in a separate location from your office.
- Water droplets (condensation) may form inside the machine if the room where the machine is installed is heated rapidly, or if the machine is moved from a cool, dry location to a warm, humid location. Using the machine under these conditions may result in problems such as paper jams, poor print quality, or faults. Let the machine adjust to the ambient temperature and humidity for at least two hours before use.
- Machines with storage devices such as hard disks may not operate properly when used at high altitudes (3,000 meters above sea level or higher).

■ Trademarks

"MEAP" is a trademark of CANON Inc., referring to an "application platform" for Canon multifunction and single function printers.

Mopria®, the Mopria® Logo and the Mopria® Alliance logo are registered trademarks and service marks of Mopria Alliance, Inc. in the United States and other countries. Unauthorized use is strictly prohibited.

Adobe, Acrobat and Reader are registered trademarks of Adobe Systems Incorporated in the United States and/or other countries.

This product contains the Universal Font Scaling Technology or UFST® under license from Monotype Imaging, Inc. UFST® is a trademark of Monotype Imaging, Inc. registered in the United States Patent and Trademark Office and may be registered in certain jurisdictions.

UFST: Copyright © 1989 - 1996, 1997, 2003, 2004, 2008, 2014 all rights reserved, by Monotype Imaging Inc.

Apple, Bonjour, iPad, iPhone, iPod touch, Mac, OS X, and Safari are trademarks of Apple Inc.

Google Chrome, Chrome OS, Chromebook and Android are trademarks of Google LLC.

Portions of this software are copyright © 2007 The FreeType Project(www.freetype.org).

All rights reserved.

OCR Technology by I.R.I.S., copyright 1987-2015, All Rights Reserved.

iHQC™ compression technology by I.R.I.S., copyright 2007-2015, All Rights Reserved.

PDF-iHQC™, XPS-iHQC™ technology by I.R.I.S., copyright 2007-2015, All Rights Reserved.



Java is a registered trademark of Oracle and /or its affiliates.



Adobe, PostScript, and the PostScript logo are either registered trademarks or trademarks of Adobe Systems Incorporated in the United States and/or other countries.

Copyright © 2007 -08 Adobe Systems Incorporated. All rights reserved.

Protected by U.S. Patents 5,737,599; 5,781,785; 5,819,301; 5,929,866; 5,943,063; 6,073,148; 6,515,763; 6,639,593; 6,754,382; 7,046,403; 7,213,269; 7,242,415; Patents pending in the U.S. and other countries.

All instances of the name PostScript in the text are references to the PostScript language as defined by Adobe Systems Incorporated unless otherwise stated. The name PostScript also is used as a product trademark for Adobe Systems' implementation of the PostScript language interpreter.

Except as otherwise stated, any reference to a "PostScript printing device," "PostScript display device," or similar item refers to a printing device, display device or item (respectively) that contains PostScript technology created or licensed by Adobe Systems Incorporated and not to devices or items that purport to be merely compatible with the PostScript language.

Adobe, the Adobe logo, PostScript, the PostScript logo, and PostScript 3 are either registered trademarks or trademarks of Adobe Systems Incorporated in the United States and/or other countries.

Linux is a registered trademark of Linus Torvalds. Microsoft and Windows are either registered trademarks or trademarks of Microsoft Corporation in the United States and/or other countries.

All other trademarks are the property of their respective owners.



The PDF logo is a trademark or registered trademark of Adobe Systems Incorporated in the United States and other countries.

Copyright © 2008 Adobe Systems Incorporated. All rights reserved.

Protected by U.S. Patents 6,185,684; 6,205,549; 7,213,269; 7,272,628; 7,278,168; Patents pending in the U.S. and other countries.

All instances of the name PostScript in the text are references to the PostScript language as defined by Adobe Systems Incorporated unless otherwise stated. The name PostScript also is used as a product trademark for Adobe Systems' implementation of the PostScript language interpreter.

Except as otherwise stated, any reference to a "PostScript printing device," "PostScript display device," or similar item refers to a printing device, display device or item (respectively) that contains PostScript technology created or licensed by Adobe Systems Incorporated and not to devices or items that purport to be merely compatible with the PostScript language.

Adobe, the Adobe logo, Adobe LiveCycle® Policy Server, PostScript, the PostScript Logo, and PostScript 3 are either registered trademarks or trademarks of Adobe Systems Incorporated in the United States and/or other countries.

All other trademarks are the property of their respective owners.

McAfee and the McAfee logo are trademarks or registered trademarks of McAfee LLC in the United States and other countries. All other trademarks and registered trademarks are the property of their respective owners. Copyright © 2018 McAfee LLC

All brand names and product names appearing on this document are registered trademarks or trademarks of their respective owners.

All other trademarks are the property of their respective owners.

■ Disclaimers

- The information in this document is subject to change without notice.
- CANON INC. MAKES NO WARRANTY OF ANY KIND WITH REGARD TO THIS MATERIAL, EITHER EXPRESS OR IMPLIED, EXCEPT AS PROVIDED HEREIN, INCLUDING WITHOUT LIMITATION, THEREOF, WARRANTIES AS TO MARKETABILITY, MERCHANTABILITY, FITNESS FOR A PARTICULAR PURPOSE OF USE, OR NON-INFRINGEMENT. CANON INC. SHALL NOT BE LIABLE FOR ANY DIRECT, INCIDENTAL, OR CONSEQUENTIAL DAMAGES OF ANY NATURE, OR LOSSES OR EXPENSES RESULTING FROM THE USE OF THIS MATERIAL.
- If you are unable to view the manual in PDF format, download Adobe Acrobat Reader from the Adobe Systems website (<https://get.adobe.com/reader/>).

■ Copyright

Reproduction of the contents of this document in whole or in part without prior permission is prohibited.

V_221018

About the Machine

- About the Machine** 17
- Parts and Their Functions** 19
 - Front Side 20
 - Back Side 24
 - Interior 25
 - 2-Sided Single Pass Feeder (Single Pass DADF-C) 26
 - 2-Sided Double Pass Feeder (DADF-BA) 28
 - Multi-Purpose Tray 30
 - Paper Drawer 31
 - Control Panel 33
- Turning ON the Machine** 35
 - Turning OFF the Machine 36
- Placing Originals and Loading Paper** 38
 - Placing Originals 39
 - Loading Paper 46
 - Basic Paper Loading Method 47
 - Loading Envelopes 53
 - Loading Preprinted Paper 60
 - Specifying Paper Size and Type 64
 - Specifying Paper Size and Type in the Paper Drawer 65
 - Specifying Paper Size and Type in the Multi-purpose Tray 68
 - Registering Frequently Used Paper Size and Type for the Multi-purpose Tray 72
 - Fixing the Paper Size and Type to Use with the Multi-Purpose Tray 75
 - Registering Free Size Paper (Custom Size Paper) 78
 - Automatically Selecting the Appropriate Paper Source for a Specific Function 79
 - Specifying the Output Tray for Preprinted Paper 81
- Main Unit Maintenance** 83
 - Regular Cleaning 84
 - Cleaning the Exterior 85
 - Cleaning the Platen Glass 86
 - Cleaning the Feeder 88
 - Cleaning the Dust-Proof Glass 97
 - Replacing the Toner Cartridge 99
 - Replacing the Waste Toner Container 103
 - Replenishing the Staples (Optional) 106

Replenishing the Staples for the Staple Finisher and Booklet Finisher	107
Replenishing the Staples for the Inner Finisher	112
Replacing the Drum Unit	114
Emptying the Punch Waste (Optional)	118
Emptying the Punch Waste in the Staple Finisher and Booklet Finisher	119
Emptying the Punch Waste in the Inner Finisher	121
Replacement Parts	123
Checking the Remaining Amount of Consumables	128
Clearing Paper Jams	131
Paper Jams in the Feeder	134
Paper Jams in the Main Unit	140
Paper Jams in a Paper Source	145
Paper Jams in a Finisher (Optional)	149
Paper Jams in the Staple Finisher	150
Paper Jams in the Booklet Finisher	153
Paper Jams in the Inner Finisher	157
Clearing Staple Jams (Optional)	161
Staple Jam Has Occurred in the Staple Finisher	162
Staple Jam Has Occurred in the Booklet Finisher	164
Staple Jam Has Occurred in the Inner Finisher	168
Options	171
Optional Equipment	173
Cassette Feeding Unit-AW	177
Media Adjustment kit-A	178
Inner Finisher-L/Inner 2/4 Hole Puncher-D/Inner 4 Hole Puncher-D	179
Staple Finisher-AE/Booklet Finisher-AE/2/4 Hole Puncher Unit-A/4 Hole Puncher Unit-A	191
Inner 2way Tray-M	205
Copy Tray-T	206
Platen Cover-Y	207
Copy Card Reader	208
Numeric Keypad	210
ADF Access Handle-A	212
Optional Equipment Supporting Specific Functions	213
Hardware Specifications	215
Main Unit	216
2-Sided Single Pass Feeder (Single Pass DADF-C)	220
2-Sided Double Pass Feeder (DADF-BA)	222
Available Paper	224
Cassette Feeding Unit-AW	233
Media Adjustment kit-A	234
Inner Finisher-L	235
Staple Finisher-AE / Booklet Finisher-AE	237
Inner 2way Tray-M	240
Copy Tray-T	241
Copy Card Reader	242

About the Machine

961F-007

This chapter provides essential information for using the machine, such as parts and paper loading methods. You can also refer to this section for information on topics such as maintenance procedures for the main unit, dealing with paper or staple jams, and the machine specifications.

■ Parts and Their Functions

This section describes the exterior and interior parts of the machine and their functions.

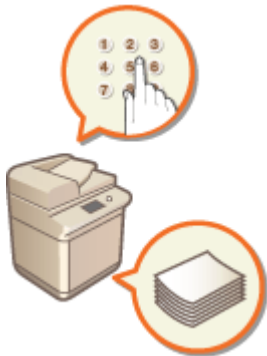

▶ Parts and Their Functions(P. 19)

■ Turning ON the Machine

This section describes how to turn the machine ON or OFF.



▶ Turning ON the Machine(P. 35)

■ Placing Originals and Loading Paper

This section describes how to place originals to be scanned and how to load the paper used for printing.

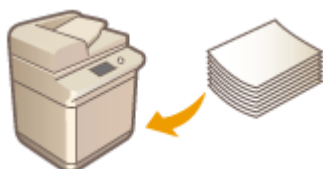

▶ Placing Originals and Loading Paper(P. 38)

■ Main Unit Maintenance

This section describes the maintenance and management of the machine, such as regular cleaning and the replacement of consumables.



▶ **Main Unit Maintenance(P. 83)**

■ **Clearing Paper Jams**

This section describes how to deal with paper jams that occur during machine use.



▶ **Clearing Paper Jams(P. 131)**

■ **Clearing Staple Jams (Optional)**

This section describes how to deal with staple jams that occur during machine use.

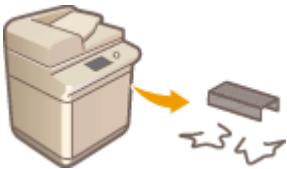

▶ **Clearing Staple Jams (Optional)(P. 161)**

■ **Options**

See this section to check the optional equipment to use the machine more efficiently.

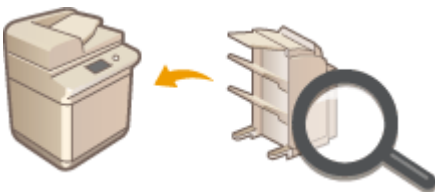

▶ **Options(P. 171)**

■ **Machine Specifications**

See this section for the specifications for the main unit and optional equipment units.



▶ **Hardware Specifications(P. 215)**

Parts and Their Functions

961F-008

This section describes the parts of the machine (front side, back side, and interior) and how they function. Read this section for tips on how to use the machine properly.

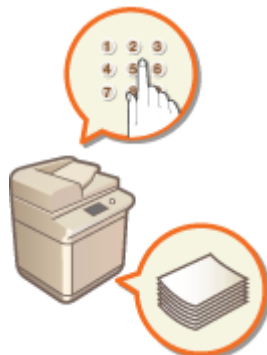

- ▶ **Front Side(P. 20)**
- ▶ **Back Side(P. 24)**
- ▶ **Interior(P. 25)**
- ▶ **2-Sided Single Pass Feeder (Single Pass DADF-C)(P. 26)**
- ▶ **2-Sided Double Pass Feeder (DADF-BA)(P. 28)**
- ▶ **Multi-Purpose Tray(P. 30)**
- ▶ **Paper Drawer(P. 31)**
- ▶ **Control Panel(P. 33)**

Front Side

961F-009

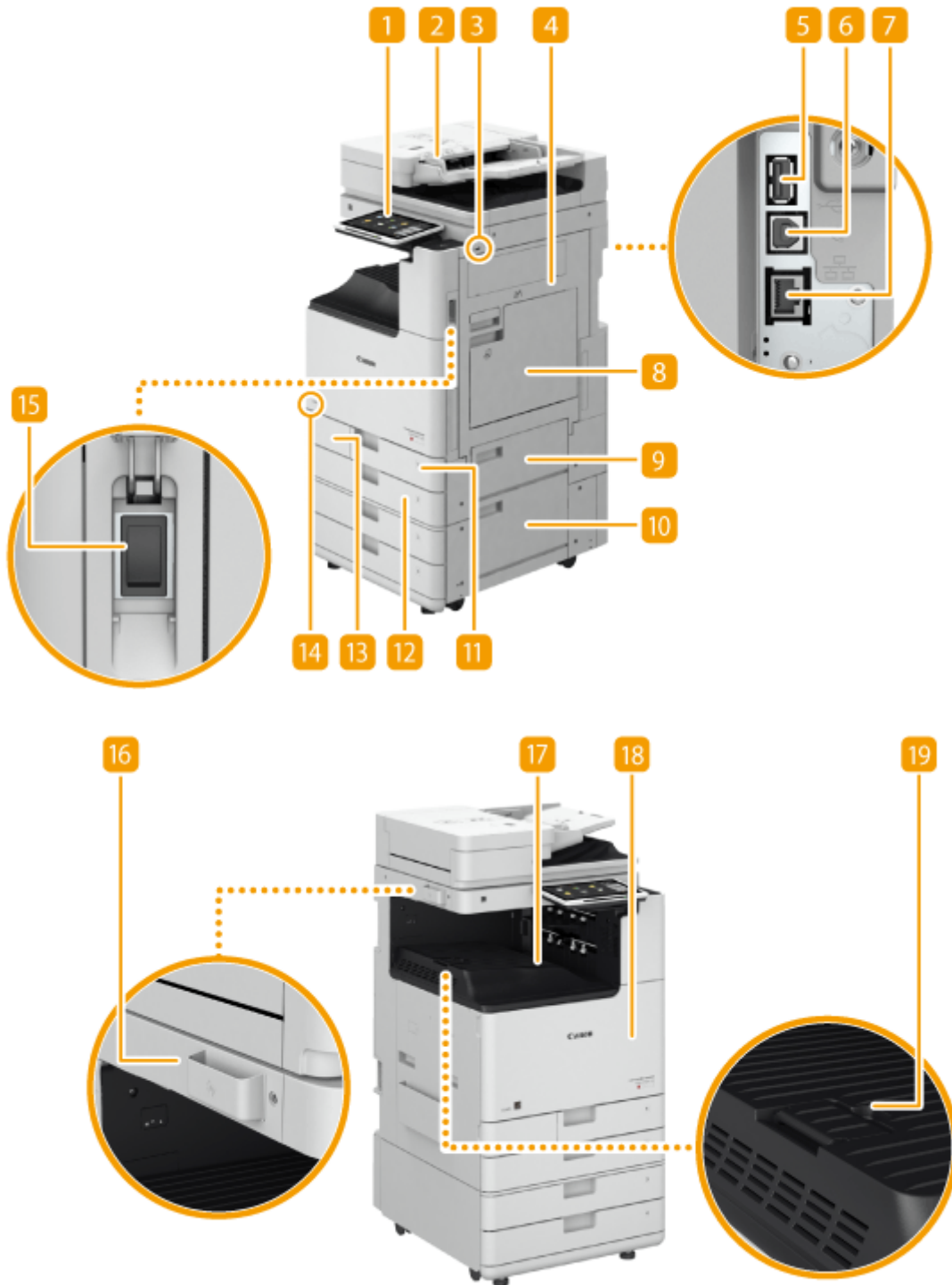

1 Control panel

The control panel consists of the indicators and the touch panel display. You can perform all the operations and specify settings from the control panel.

- ▶ **Control Panel(P. 33)**
- ▶ **Basic Screens on the Touch Panel Display(P. 332)**

2 Feeder

Automatically feeds originals into the machine for scanning. When two or more sheets are loaded in the feeder, originals can be scanned continuously.

▶ **2-Sided Single Pass Feeder (Single Pass DADF-C)(P. 26)**

▶ **2-Sided Double Pass Feeder (DADF-BA)(P. 28)**

3 USB port (Front-right side of the machine)

- You can connect devices such as a USB memory device to the machine. ▶ **Connecting a USB Memory Device(P. 23)**

! IMPORTANT:

- The machine can supply a maximum power of 5 V 500 mA. Connecting a device that requires more power may damage the machine.

NOTE:

- Some types of memory media may not be able to save data correctly.
- The USB port (front-right side of the machine) supports USB 2.0.

4 Right cover of the main unit

Open this cover when clearing a paper jam inside the machine. ▶ **Paper Jams in a Paper Source(P. 145)**

5 USB port (Rear-right side of the machine)

- You can connect devices such as an external storage disk to the machine. ▶ **Backing Up/Restoring Data(P. 965)**
- When you select <Wired LAN + Wired LAN> for <Select Interface>, connect a USB-LAN adapter here. ▶ **Connecting to a Wired LAN for the Sub Line(P. 269)**

! IMPORTANT:

- The machine can supply a maximum power of 5 V 900 mA. Connecting a device that requires more power may damage the machine.

NOTE:

- The USB port (rear-right side of the machine) supports USB 3.0.

6 USB connector

Connect a USB cable when connecting the machine and a computer.

NOTE:

- The USB connector supports USB 2.0.

7 LAN port

Connect a LAN cable when connecting the machine to a wired LAN router, etc. ▶ **Setting up the Network Environment(P. 263)**

8 Multi-purpose tray

Load paper into the multi-purpose tray when you want to use a type of paper different from that which is loaded in the paper drawer.

▶ **Multi-Purpose Tray(P. 30)**

▶ **Loading Paper in the Multi-Purpose Tray(P. 50)**

9 Upper-right cover of the paper drawer

Open this cover when clearing a paper jam inside the machine. ▶ **Paper Jams in a Paper Source(P. 145)**

10 Lower-right cover of the paper drawer

Open this cover when clearing a paper jam inside the machine. ▶ **Paper Jams in a Paper Source(P. 145)**

11 Paper drawer 1

Load the type of paper that you frequently use. ▶ **Paper Drawer(P. 31)**

12 Paper drawer 2

Load the type of paper that you frequently use. You can load paper that cannot be loaded in the paper drawer 1, such as A3 size paper. ▶ **Paper Drawer(P. 31)**

13 Waste toner container cover

Open this cover when replacing the waste toner container. ▶ **Replacing the Waste Toner Container(P. 103)**

14 Toner Code

This code indicates the type of genuine toner that can be used with the machine. Use toner with a code that includes the same letters as the code on the front cover of the machine.

15 Power switch

Press the power switch when turning ON or OFF the machine.

▶ **Turning ON the Machine(P. 35)**

▶ **Turning OFF the Machine(P. 36)**

16 Glass cleaning sheet storage box

Use this box to store sheets for cleaning the platen glass.

17 Output tray

Paper is output here when printing finishes.

18 Front cover of the main unit

Open this cover when replacing the toner cartridge, the drum unit, or cleaning the dust-proof glass.

▶ **Replacing the Toner Cartridge(P. 99)**

▶ **Replacing the Drum Unit(P. 114)**

▶ **Cleaning the Dust-Proof Glass(P. 97)**

19 Output tray paper supporter

Raise this supporter so that printed paper does not fall down.

NOTE

- For more information about the configuration of optional equipment installed on the machine, see [▶ Options\(P. 171\)](#) .

Connecting a USB Memory Device

You can connect a USB memory device to the USB ports located on the right side of the machine, and directly print data from the USB memory device. Originals scanned using the machine can also be saved directly to the USB memory device. [▶Working with Data in Memory Media\(P. 739\)](#)



! IMPORTANT

- Make sure that the USB memory device is oriented properly when connecting it to the machine. If it is not connected properly, it may cause the USB memory device or machine to malfunction.
- Make sure to follow the proper procedure when removing the USB memory device. [▶Removing the memory media\(P. 740\)](#) Failure to do so may cause the USB memory device or machine to malfunction.
- The machine supports FAT32/exFAT format USB memory device.

NOTE

Unsupported devices and usages

- Memory media with security functions
- Memory media that does not meet the USB specification
- Memory card readers connected via USB
- Connecting memory media via an extension cable
- Connecting memory media via a USB hub

Back Side

961F-00A



1 Additional telephone line jack (LINE 2)

Use this port to connect the Super G3 2nd Line Fax Board to the machine. [▶System Options\(P. 1597\)](#)

2 Telephone line jack (LINE 1)

Connect a telephone cable when connecting the machine to a telephone line.

Interior

961F-00C

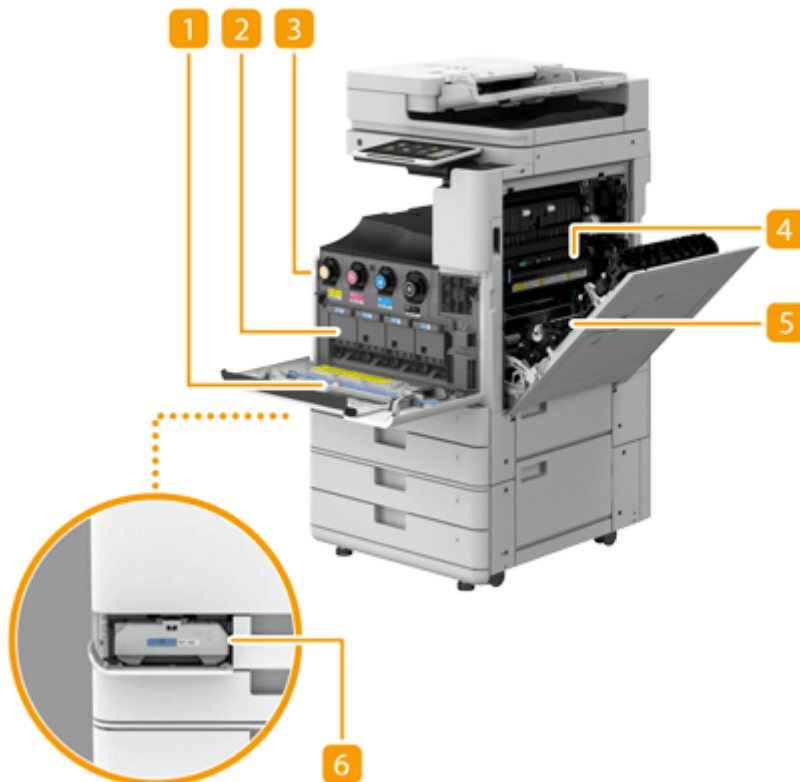

1 Dust Proof Glass Cleaner

Use this cleaner when cleaning the dust proof glass.

2 Drum unit

The unit that sets toner onto paper. ▶ **Replacing the Drum Unit(P. 114)**

3 Toner cartridge

Replace the toner cartridge when the toner runs out. ▶ **Replacing the Toner Cartridge(P. 99)**

4 Fixing assembly

The unit that fixes toner onto paper. Check this when a paper jam has occurred inside the main unit. ▶ **Paper Jams in the Main Unit(P. 140)**

5 Duplexing unit

This is a device to enable printing on both sides of paper. Check this unit when a paper jam has occurred inside the main unit. ▶ **Paper Jams in the Main Unit(P. 140)**

6 Waste toner container

Replace the waste toner container when it is full of waste toner. ▶ **Replacing the Waste Toner Container(P. 103)**

2-Sided Single Pass Feeder (Single Pass DADF-C)

961F-00E

The Single Pass DADF-C is an optional product.

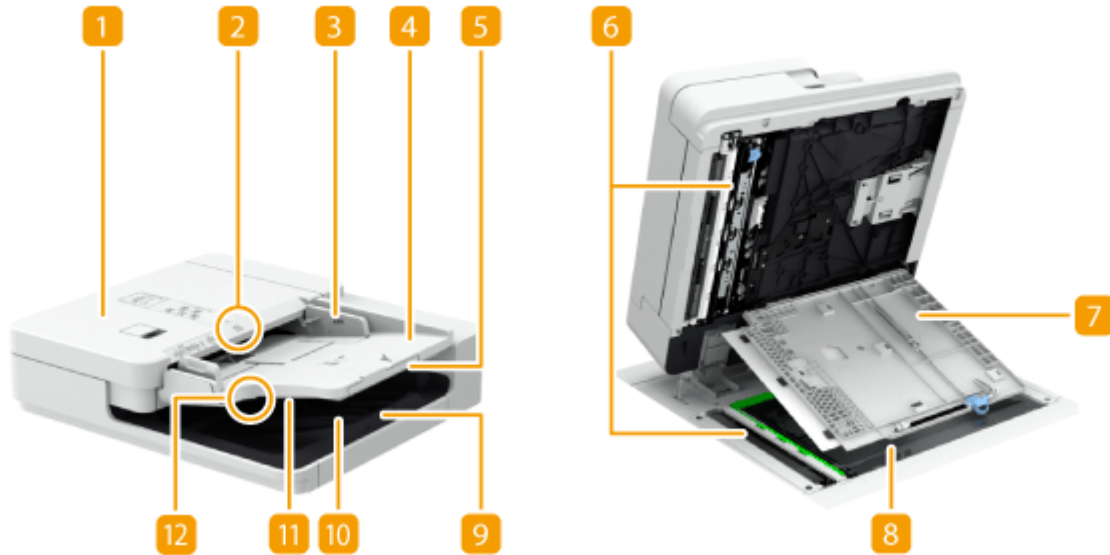

1 Original set indicator

Lights up when originals are placed in the original supply tray.

2 Feeder cover

Open this cover when removing paper jammed in the feeder. ▶ **Paper Jams in the Feeder(P. 134)**

3 Slide guides

Adjust these guides according to the width of an original.

4 Original supply tray

Originals placed here are automatically fed into the feeder. When two or more sheets are loaded, originals can be scanned continuously. ▶ **Placing Originals(P. 39)**

5 Original supply tray extension

Pull out this tray when loading a large-sized original.

6 Document feed scanning area

Originals placed in the feeder are scanned in this area.

7 Document feed scanning area cover

Open this cover when cleaning the document feed scanning area. ▶ **Main Unit Maintenance(P. 83)**

8 Platen glass

When scanning books, thick originals, thin originals, and other originals that cannot be scanned using the feeder, place them on the platen glass. ▶ **Placing Originals(P. 39)**

9 Original output tray extension

Pull out this tray when scanning large-sized originals to prevent them from dropping over the edge of the feeder. The tray can be extended to two different lengths depending on the size of original.

10 Original stopper

Holds down originals to support outputting originals neatly.

11 Original output tray

Scanned originals are output here.

12 Original output indicator

If you place originals in the feeder while originals for another job remain in the original output tray, the indicator blinks to notify the user that originals remain.

IMPORTANT

- If a thick original such as a book or magazine is placed on the platen glass, do not press down hard on the feeder.
- Do not place any objects in the original output area. Doing so may cause damage to the originals.
- Regularly clean the feeder and platen glass in order to obtain proper print results. ▶ **Regular Cleaning(P. 84)**

2-Sided Double Pass Feeder (DADF-BA)

961F-00F

The DADF-BA is an optional product.

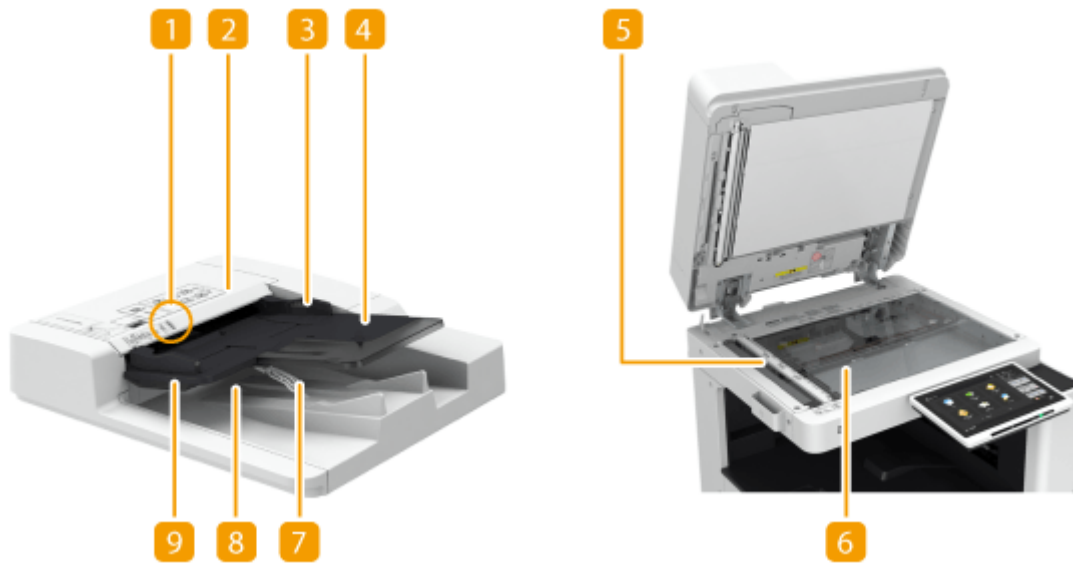

1 Original set indicator

Lights up when originals are placed in the original supply tray.

2 Feeder cover

Open this cover when removing paper jammed in the feeder. ▶ **Paper Jams in the Feeder(P. 134)**

3 Slide guides

Adjust these guides according to the width of an original.

4 Original supply tray

Originals placed here are automatically fed into the feeder. When two or more sheets are loaded, originals can be scanned continuously. ▶ **Placing Originals(P. 39)**

5 Document feed scanning area

Originals placed in the feeder are scanned in this area.

6 Platen glass

When scanning books, thick originals, thin originals, and other originals that cannot be scanned using the feeder, place them on the platen glass. ▶ **Placing Originals(P. 39)**

7 Original stopper

Lightly holds down originals so that they are output neatly. You do not need to manually adjust its position.

8 Original output tray

Scanned originals are output here.

9 Original output indicator

To prevent originals from being left in the original output tray, this indicator lights while the originals are being output, and blinks for a while after all the originals have been output.

IMPORTANT

- If a thick original such as a book or magazine is placed on the platen glass, do not press down hard on the feeder.
- Do not place any objects in the original output area. Doing so may cause damage to the originals.
- Regularly clean the feeder and platen glass in order to obtain proper print results. ▶ **Regular Cleaning(P. 84)**

Multi-Purpose Tray

961F-00H

Use the multi-purpose tray when you want to print on a type of paper that is not loaded in the paper drawer, such as labels.

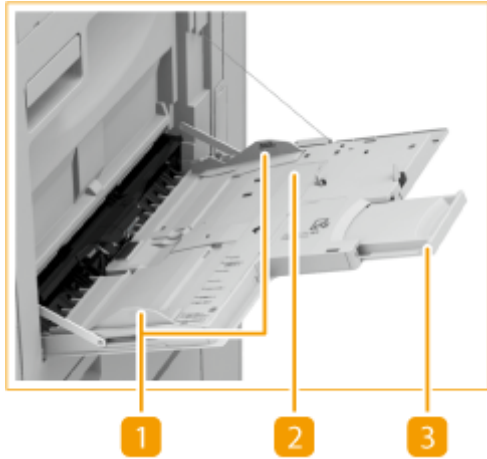

1 Paper guides

Adjust the paper guides to exactly the width of the loaded paper to ensure that paper is fed straight into the machine.

2 Paper tray

Open the paper tray when loading paper.

3 Tray extension

Pull out the tray extension when loading large-sized paper.

LINKS

- ▶ [Loading Paper in the Multi-Purpose Tray\(P. 50\)](#)
- ▶ [Loading Envelopes\(P. 53\)](#)

Paper Drawer

Paper Drawer 1



1 Paper guide (Left guide)

Press the top part of the left guide and slide it.

2 Paper guide (Front guide)

Press the top part of the front guide and slide it.

Paper Drawer 2

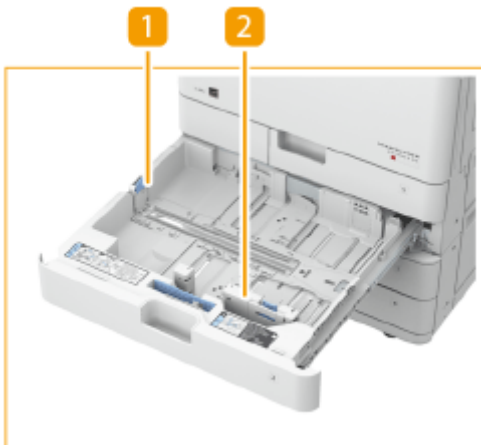

1 Paper guide (Left guide)

Press the top part of the left guide and slide it.

2 Paper guide (Front guide)

Press the top part of the front guide and slide it.

3 Envelope Feeder Attachment A

Use this attachment when loading envelopes in the paper drawer. [▶ Loading Envelopes\(P. 53\)](#)

Attaching the appropriate paper size label

Attach the paper size label at the same height as the cassette number indicator, and approximately 5 mm to the left.



* Approximately 5 mm

IMPORTANT

- Note that the paper size label may include paper sizes which are unavailable on the machine.

LINKS

- ▶ [Loading Paper in the Paper Drawer\(P. 47\)](#)
- ▶ [Loading the Envelopes in the Paper Drawer\(P. 55\)](#)
- ▶ [Optional Equipment\(P. 173\)](#)

Control Panel

This section describes the names and usage of the keys on the control panel.

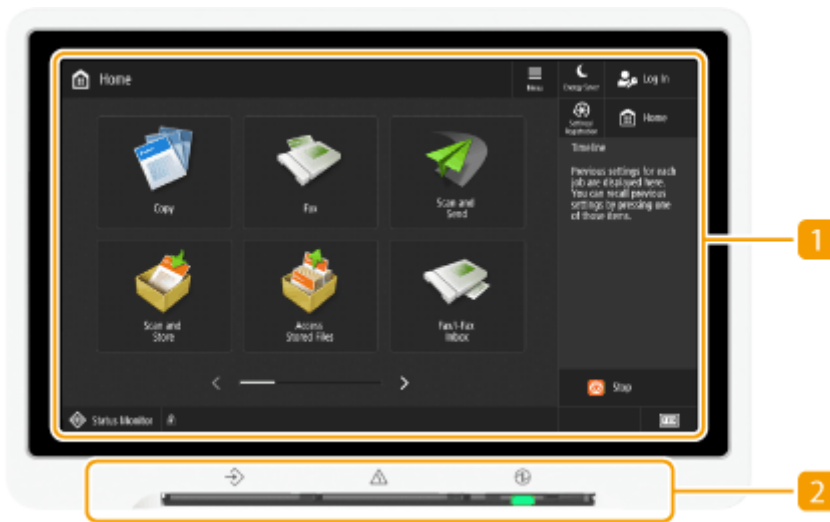

1 Touch panel display

In addition to the settings screen for each function, the error status is also shown on this display. **▶Using the Touch Panel Display(P. 331)**

2 Lamp displays

The display consists of the following three lamps, from left to right.

 : Processing/Data indicator

Blinks while operations such as sending or printing are being performed. Lights up green when there are documents waiting to be processed.

 : Error indicator

Blinks or lights up when an error such as a paper jam occurs.

IMPORTANT:

- If the Error indicator blinks, follow the instructions that appear on the touch panel display.
 - ▶**Clearing Paper Jams(P. 131)**
 - ▶**Clearing Staple Jams (Optional)(P. 161)**
- If the Error indicator maintains a steady red light, contact your dealer or service representative.

 : Main Power indicator

Lights up when the machine is turned ON. **▶Turning ON the Machine(P. 35)**

Adjusting the Angle of the Touch Panel Display

You can adjust the angle of the control panel if the touch panel display cannot be seen clearly.



Turning ON the Machine

961F-00L

This section describes how to turn ON the machine.

- 1** Make sure that the power plug is firmly inserted into the power outlet.
- 2** Open the power switch cover and press the power switch toward " | ".

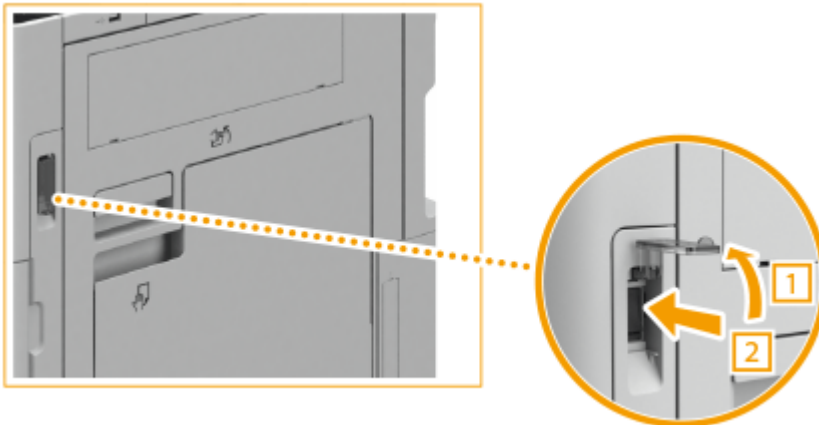

- 3** Close the power switch cover.

⇒ The Main Power indicator on the control panel (**▶Control Panel(P. 33)**) lights up and the startup screen appears on the touch panel display.

NOTE

- You can select the screen displayed immediately after the machine is turned ON. **▶<Use Default Screen After Startup/Restoration>(P. 1347)**
- The response of the touch panel display and keys may not be optimal immediately after the machine is turned ON.
- If the machine is connected to a powered off Mac computer by USB cable, the computer may turn on automatically when this machine does. In this case, disconnect the USB cable from the machine. You may also be able to solve this problem by using a USB hub between the machine and the computer.

LINKS

▶Turning OFF the Machine(P. 36)

Turning OFF the Machine

961F-00R

This section describes how to turn OFF the machine.

IMPORTANT

Check the machine's operation status before turning it OFF

The machine performs a procedure to protect the storage when the machine is shut down. You can turn OFF the machine while a process is active, but the following types of problems may occur, which may cause you to lose or damage data.

- Do not turn OFF the machine while using the Fax/I-fax function. I-fax or fax documents cannot be sent or received when the machine is turned OFF.
- Do not turn OFF the machine if the <Backing up stored data from Remote UI...> message is displayed on the touch panel display. Doing so may cause the machine to fail to back up the stored data.
- Data stored in the machine may be damaged if the Advanced Space (shared storage of the machine) is accessed by another Canon multifunction printer* or a computer immediately before the machine is turned OFF.
- If the machine is turned OFF during scanning or printing, a paper jam may occur.

* Only for Canon multifunction printers supporting Advanced Space

Unplugging the power cord

- The machine may take some time to completely shut down. Wait three seconds after the Main Power lamp ( **Control Panel(P. 33)**) turns off before unplugging the power cord.
- Unplugging the power cord before the machine has shut down may cause a malfunction.

NOTE

- You can shut down the machine from the Remote UI.  **Turning OFF/Restarting the Machine(P. 911)**

- 1 **Open the power switch cover and press the power switch toward "⏻".**

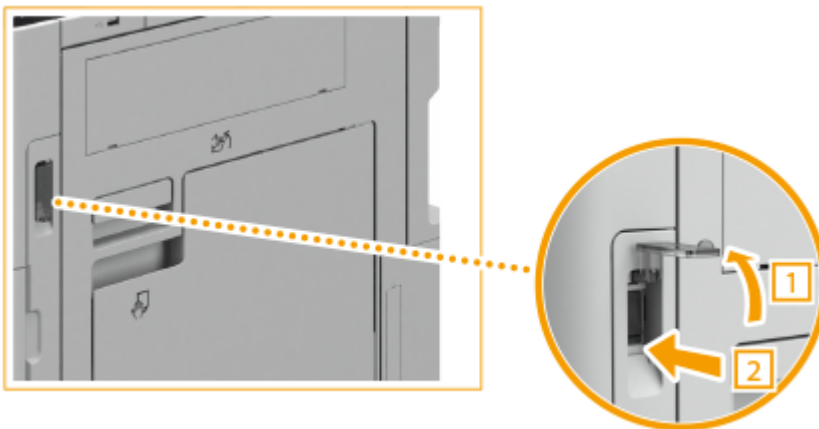

- 2 **Close the power switch cover.**

NOTE

- To restart the machine, wait for at least 10 seconds after the Main Power indicator is turned off, and then turn the machine back ON. When <Quick Startup Settings for Main Power> is enabled, wait for at least 20 seconds to restart the machine. ▶<Quick Startup Settings for Main Power>(P. 1073)

LINKS

▶Turning ON the Machine(P. 35)

Placing Originals and Loading Paper

961F-00S

This section describes how to place originals to be scanned and how to load the paper used for printing. You can check this section also for information on how to specify the paper size and type for loaded paper.

■ Placing Originals

This section describes how to place originals on the platen glass and in the feeder.

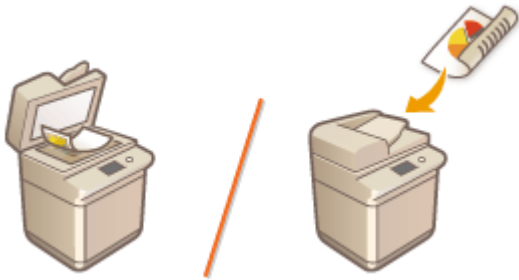

▶ **Placing Originals(P. 39)**

■ Loading Paper

This section describes how to load the paper into the drawer and multi-purpose tray.

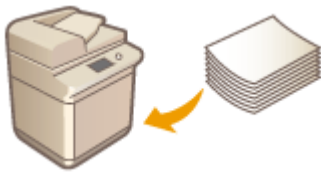

▶ **Loading Paper(P. 46)**

■ Specifying Paper Size and Type

This section describes how to specify the paper size and type for the paper loaded into the paper source.



▶ **Specifying Paper Size and Type(P. 64)**

NOTE

For device configurations with multiple output destinations

- You can specify the paper output destination for each function during printing. ▶ **Specifying the Output Tray for Preprinted Paper(P. 81)**

Placing Originals

Place your originals on the platen glass or in the feeder. For originals such as books and thick/thin paper which cannot be loaded in the feeder, place the original on the platen glass. If you want to scan 2-sided originals or continue to scan several sheets of originals, place them in the feeder. For information on loadable sizes, etc., see **Available Paper(P. 224)** .

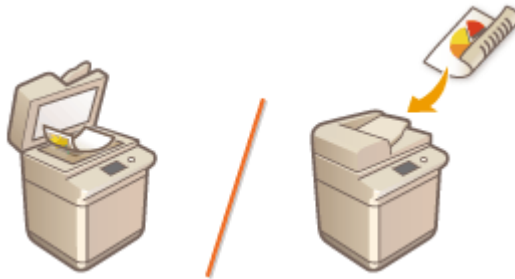

▶ **Placing Originals on the Platen Glass(P. 40)**

▶ **Placing Originals in the Feeder(P. 41)**

! IMPORTANT

Use originals that are completely dry

- When placing originals, make sure that any glue, ink, or correction fluid on the originals has completely dried.

To avoid paper jams

Do not place the following types of originals in the feeder as this may cause paper jams:

- Wrinkled or creased paper
- Carbon paper or carbon-backed paper
- Curled or rolled paper
- Coated paper
- Torn originals
- Originals with large holes
- Onion skin or thin paper
- Stapled or clipped originals
- Paper printed by a thermal transfer printer
- Transparencies
- Originals with notes attached
- Originals pasted together
- Originals placed in a clear file



NOTE

To scan originals more accurately

- Originals placed in the feeder are scanned while being fed into the machine. On the other hand, originals placed on the platen glass remain in a fixed position while they are scanned. To ensure more accurate scanning results, placing originals on the platen glass is recommended.

To scan tracing paper or transparencies

- To scan transparent originals (for example, tracing paper or transparencies), place them on the platen glass and cover them with plain white paper.

Document sizes

- The machine automatically detects the paper size of the placed document prior to scanning. In the case of fax sending, if the size of the recording paper in the recipient's machine is smaller than the scanned document size, the original image may be either reduced in size or divided into smaller parts before it is sent.

Placing Originals on the Platen Glass

1 Open the feeder.



NOTE:

- If you place an original for which the opening of the feeder is insufficient, the size of the original may not be properly detected.

2 Place the original face down on the platen glass.

- Align the corner of the original with the top-left corner of the platen glass.



NOTE:

- When copying 2-sided original, place the original so that the top and the bottom are properly positioned, as shown in the illustration below.



3 Gently close the feeder.

⇒ The original is ready for scanning.

- When scanning is complete, remove the original from the platen glass.

CAUTION

- When closing the feeder, take care that your eyes are not exposed to light emitted through the platen glass.

IMPORTANT

- If a thick original such as a book or magazine is placed on the platen glass, do not press down hard on the feeder.

NOTE

- The marks around the platen glass include sizes that are not detected automatically.

Placing Originals in the Feeder

IMPORTANT

- Do not place items in the original output tray, as doing so may cause damage to your originals.

1 Align the slide guides to fit the size of your originals.



- When placing large-sized originals, pull out the original supply tray extension and original output tray extension to prevent them from dropping over the edge of the feeder (Single Pass DADF-C only).



2 Fan the original stack and align the edges.

- Fan the original stack in small batches, and align the edges by lightly tapping the stack on a flat surface a few times.

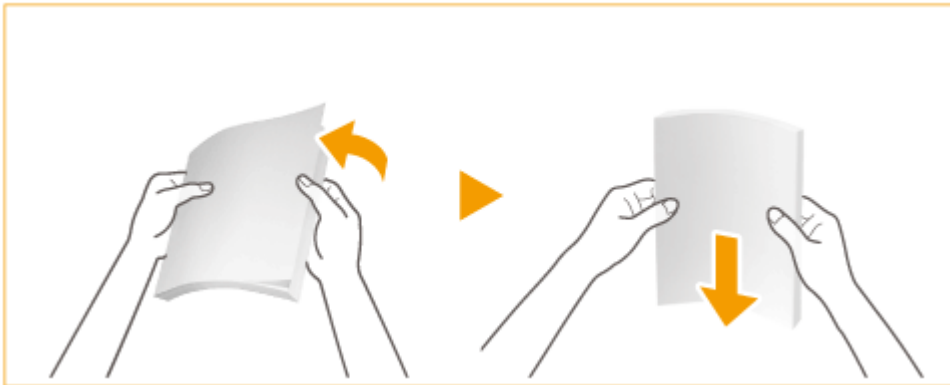

3 Place the originals face up and as far into the feeder as they will go.



⇒ When insertion depth is sufficient, the Original Set Indicator lights up.



Originals are ready for scanning.

! IMPORTANT:

Load limit lines

- Make sure that the original stack does not exceed the load limit lines (). If you place originals that exceed the limit, they may not be scanned or may cause a paper jam.

When placing an original that is folded

- Always smooth out any folds in your originals before placing them into the feeder. If the original is folded, an error screen may be displayed because the size of originals cannot be detected correctly.

Align the slide guides securely against the edges of the original

- Slide guides that are too loose or too tight can cause misfeeds or paper jam.

While originals are being scanned

- Do not add or remove originals.

When scanning is complete

- Remove the scanned originals from the original output tray to prevent paper jams. To prevent originals from being left in the original output tray, the original output indicator lights while the originals are being output, and blinks for a while after all the originals have been output.



- Also when the next original is placed in the feeder with the previous one left in the original output tray, the original output indicator blinks for a while (Single Pass DADF-C only).

When scanning long strip originals

- If you are scanning long originals (up to 630 mm long (up to 990 mm long if the Single Pass DADF-C is used)), support the originals by hand during scanning and paper output.



When placing thin paper originals

- Thin originals may become creased, if used in a high temperature or high humidity environment.
- It may be difficult to place thin paper originals. In this case, lightly bend the paper while placing it (Single Pass DADF-C only).



- Make sure that you do not push too hard when placing the original. The original may not be fed correctly, or may cause a paper jam.
- When you place thin A3 or A4R originals into the feeder, lift up the Original Stopper to prevent scanned originals from creasing (Single Pass DADF-C only).



When repeatedly scanning the same original

- It is recommended that you do not repeatedly scan the same original more than five times (this varies depending on paper quality). The original may fold or become wrinkled, or become difficult to send.

Color original scan range

- When a color original is scanned with a setting made for automatic color discrimination, it may be identified as a black-and-white document if it contains color portions only in the gray areas as shown in the following figure.

Single Pass DADF-C

1-sided originals

2-sided originals

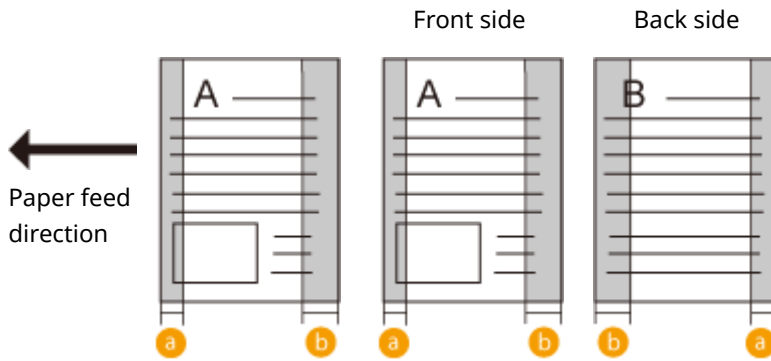

DADF-BA

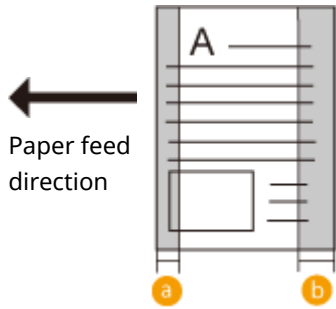

a : 10 mm

b : 17 mm

- To scan originals as color document, set the machine to Full Color mode.

NOTE:

- When copying 2-sided original, place the original so that the top and the bottom are properly positioned, as shown in the illustration below.

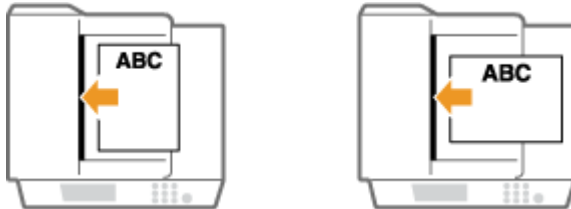

- You can place different sized originals and scan them all at once.
 - ▶ **Copying Different Size Originals Together (Different Size Originals)(P. 451)**
 - ▶ **Sending Different Size Originals Together (Different Size Originals)(P. 554)**
 - ▶ **Sending/Saving Different Size Originals Together (Different Size Originals)(P. 665)**

Loading Paper

961F-00W

The paper source to use and the paper loading method to follow vary depending on the type and size of paper you use. For more information about available paper types and sizes, see [▶Available Paper\(P. 224\)](#) . To obtain the optimum printing results, make sure to correctly specify the size and type of paper that is loaded. [▶Specifying Paper Size and Type\(P. 64\)](#)

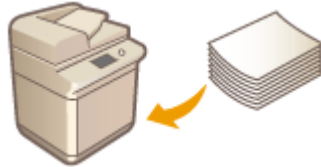

- ▶[Basic Paper Loading Method\(P. 47\)](#)
- ▶[Loading Envelopes\(P. 53\)](#)
- ▶[Loading Preprinted Paper\(P. 60\)](#)

IMPORTANT

- Before using any paper, confirm the precautions regarding paper and the correct way to store it. [▶ Available Paper\(P. 224\)](#)
- Loading paper while stock remains may cause a multiple sheet feed or a paper jam. If there is paper remaining, it is recommended that you wait until all of it has been used before loading more paper.
- Do not load different sizes or types of paper together.

LINKS

- ▶[Registering Free Size Paper \(Custom Size Paper\)\(P. 78\)](#)
- ▶[Cassette Feeding Unit-AW\(P. 233\)](#)

Basic Paper Loading Method

This section describes the method for loading paper that is used relatively frequently such as plain paper or recycled paper. Load the paper you usually use into the paper drawer. Use the multi-purpose tray when you temporarily use a size or type of paper that is not loaded in the paper drawer.

▶ **Loading Paper in the Paper Drawer(P. 47)**

▶ **Loading Paper in the Multi-Purpose Tray(P. 50)**

NOTE

- For the optional Cassette Feeding Unit-AW, follow the procedure of paper drawer to load paper.
- If there are instructions on the paper package about which side of the paper to load, follow those instructions.
- Paper may overlap when it is fed or a paper jam may occur, depending on the cut surface of the paper. Changing the paper orientation and loading it again may reduce the effect of the cut surface.
- If paper runs out and printing is stopped, load a new paper stack. Printing restarts after the new paper stack is loaded.

Loading Paper in the Paper Drawer

1 Hold the handle of the paper drawer and pull it out until it stops.

Paper drawer 1



Paper drawer 2



2 Adjust the position of the paper guides.

- Align the left and front guides with the size indicators for the paper to be loaded by sliding each guide while pressing the top part of that guide.

Paper drawer 1

Paper drawer 2

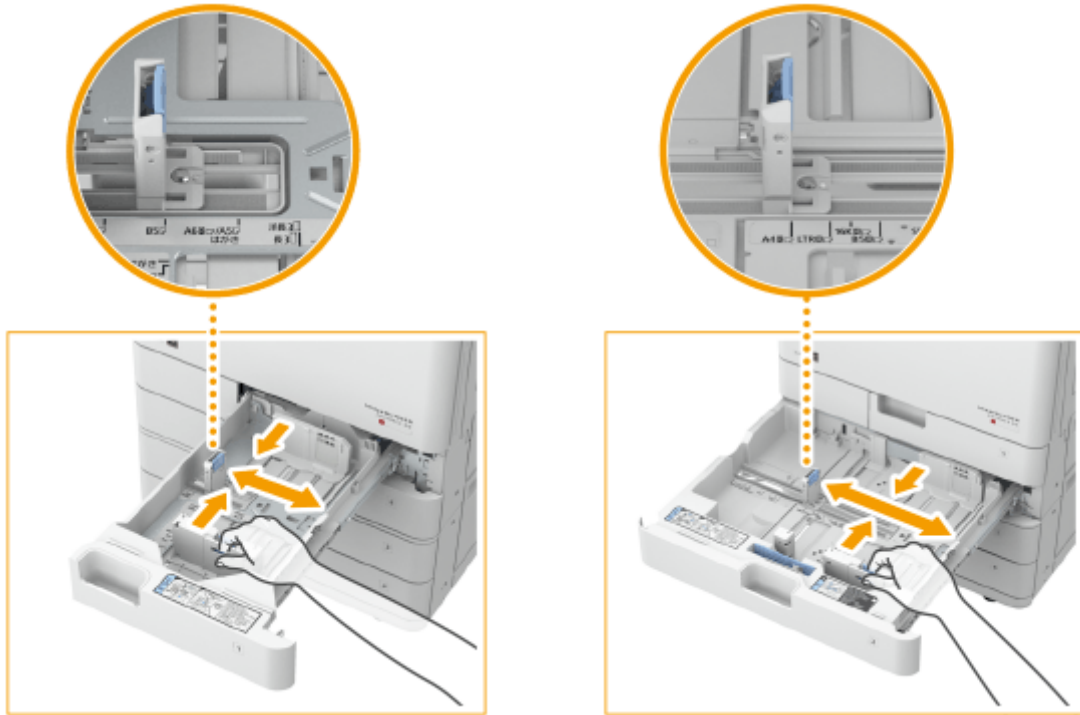

! IMPORTANT:

- Slide the guides until they click into place. If the left guide and front guide are not aligned correctly, the paper size will not correctly appear on the touch panel display. It is also necessary to adjust the guides correctly to avoid causing a paper jam, dirty prints, or making the inside of the machine dirty.

NOTE:

Paper size indicators

- The abbreviations on the paper size indicators in the paper drawer indicate paper sizes as follows:
 - LGL: Legal
 - LTR: Letter
 - EXEC: Executive
 - STMT: Statement
- Note that the paper size indicators may include paper sizes which are unavailable on the machine. For information on available paper sizes, see **Available Paper(P. 224)** .

3 Prepare paper.

- Fan the paper stack well, and tap it on a flat surface to align the edges.

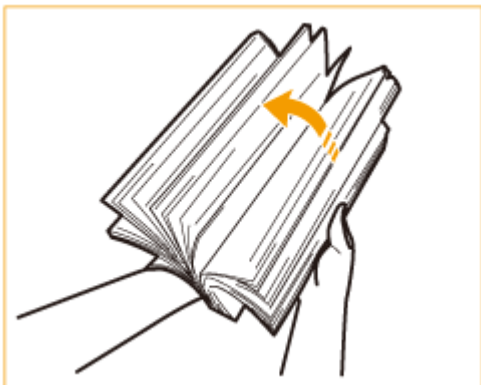

! IMPORTANT:

- Fan all four sides of the paper stack well.
- Make sure that there is enough air between each sheet of paper.

4 Load the paper.

- 1 Make sure that the paper size setting of the paper drawer matches the size of the paper to load in the paper drawer.**
- 2 Load the paper stack with the print side face up, and against the side wall of the paper drawer.**

Paper drawer 1



Paper drawer 2



! IMPORTANT:

Do not exceed the load limit line when loading paper

- Make sure that the paper stack does not exceed the load limit line. Loading too much paper can cause paper jams.

Paper (excluding envelopes):

Envelopes:

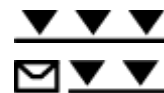

NOTE:

- If you use paper with a logo mark, pay attention to the orientation when loading it in the paper source. ▶ **Loading Preprinted Paper(P. 60)**
- When placing envelopes, pay attention to the orientation and the preparations before placing envelopes. ▶ **Loading Envelopes(P. 53)**
- For paper that can be loaded in each paper drawer, see ▶ **Available Paper(P. 224)** .

5 Gently insert the paper drawer into the machine.

! IMPORTANT

When changing the paper size and type

- If you load a different type of paper into the machine, make sure to change the settings. If you do not change the settings, the machine cannot print properly. ▶ **Specifying Paper Size and Type in the Paper Drawer(P. 65)**

- When changing the paper size, change the paper size label as necessary (▶ **Attaching the appropriate paper size label(P. 32)**). Note that the paper size label may include paper sizes which are unavailable on the machine.

Loading Paper in the Multi-Purpose Tray

1 Open the multi-purpose tray.



- Pull out the tray extension when loading large-sized paper.

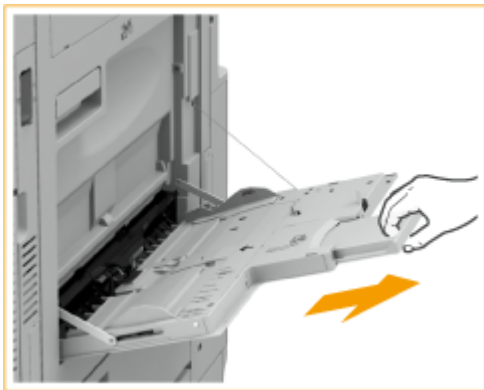

2 Spread the paper guides apart.

- Move the paper guides outward until they are slightly farther apart than the actual width of the paper.



3 Prepare paper.

- Fan the paper stack well, and tap it on a flat surface to align the edges.



! IMPORTANT:

- Fan all four sides of the paper stack well.
- Make sure that there is enough air between each sheet of paper.
- Especially when you use transparencies, completely separate them from each other before loading them.

4 Insert the paper into the multi-purpose tray until the paper stops.



- Load the paper with the print side face down.

! IMPORTANT:

Do not exceed the load limit line when loading paper

- Make sure that the paper stack does not exceed the load limit line (). Loading too much paper can cause paper jams.

NOTE:

- If you use envelopes or paper with a logo mark, pay attention to the orientation when loading them in the paper source.
 - ▶ **Loading Envelopes(P. 53)**
 - ▶ **Loading Preprinted Paper(P. 60)**
- The number of sheets that can be loaded at a time depends on the paper type. For details, see ▶ **Available Paper(P. 224)** .

5 Align the paper guides against the edges of the paper.

- Move the paper guides inward until they are aligned securely against the edges of the paper.

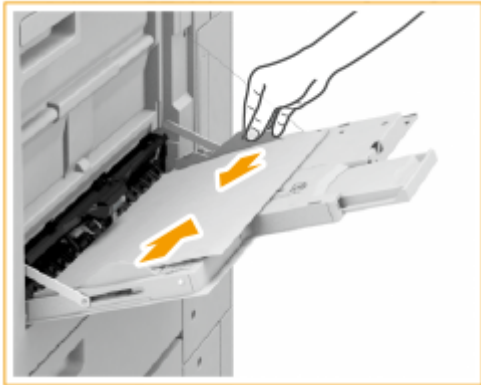

6 Check the paper size and paper type, and press <OK>.



- If you load free size paper, or if the displayed size or type is different from the actual paper that is loaded, see **>Specifying Paper Size and Type in the Multi-purpose Tray(P. 68)** .

TIPS

Printing on the back side of printed paper (2nd Side of 2-Sided Page)

- You can print on the back side of printed paper. Flatten any curls on the printed paper and insert it into the multi-purpose tray, with the side to print face down (previously printed side face up). Then press <2nd Side of 2-Sided Page> on the screen for selecting the paper type.
- Use only the paper printed with this machine.

Loading Transparencies

- If a multiple feed or paper jam occurs, load only one sheet of transparency at a time.
- If you leave transparencies loaded in the paper drawers or in the multi-purpose tray, the sheets may stick together and cause a multiple sheet feed or a paper jam. When printing is complete, return the remaining transparencies to their original package for storage, avoiding locations subject to high temperatures and humidity.

LINKS

- **>Available Paper(P. 224)**
- **><Paper Feed Mode for Printer Driver Jobs with MP Tray>(P. 1203)**

Loading Envelopes

961F-00Y

Load envelopes in the paper drawer or the multi-purpose tray. Make sure to flatten any curls on envelopes before loading them. Also pay attention to the orientation of envelopes and which side should be face up.

- ▶ **Before Loading Envelopes(P. 53)**
- ▶ **Loading the Envelopes in the Paper Drawer(P. 55)**
- ▶ **Loading Envelopes in the Multi-Purpose Tray(P. 58)**

NOTE

- This section describes how to load envelopes with the proper orientation, as well as procedures that you need to complete before loading envelopes. For a description of the general procedure for loading envelopes in the paper drawer or multi-purpose tray, see ▶ **Basic Paper Loading Method(P. 47)** .

Before Loading Envelopes

Follow the procedure below to prepare the envelopes before loading.

! IMPORTANT

- Do not use envelopes that have glue attached to their flaps, as the glue may melt due to the heat and pressure of the fixing unit.
- Envelopes may become creased, depending on the type of envelopes or the conditions in which they are stored.
- Streaks may appear where envelopes overlap.

1 Flatten any curls.

- Pick up about five envelopes. Flatten any curls, and loosen the stiff areas in the four corners.

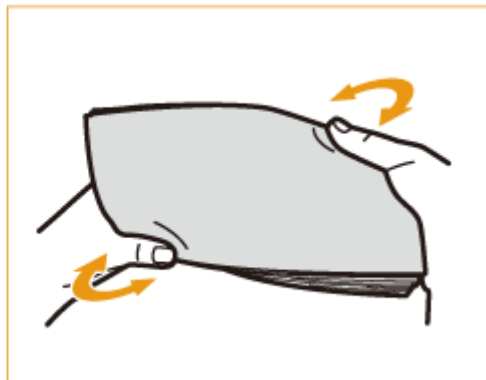

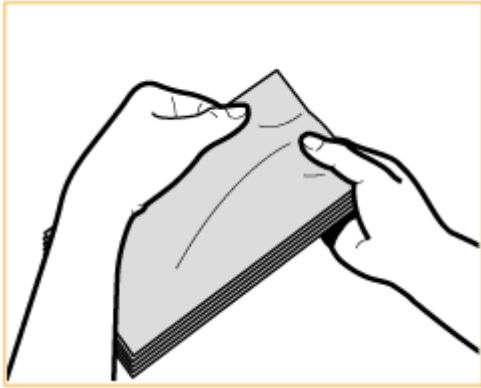

2 Smooth the envelopes out, and remove any air inside them.

- Place the envelopes on a flat surface, and move your hands in the direction of the arrows to remove the air inside the envelopes.

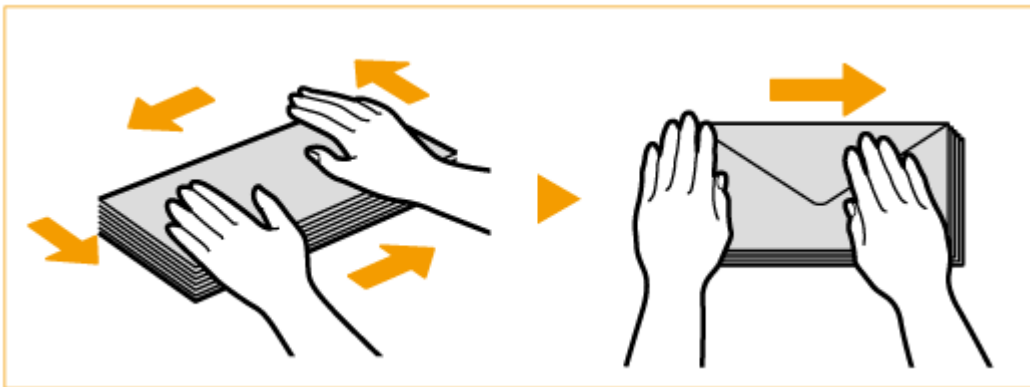

- Repeat this step five times for each set of five envelopes.

3 Press down on the four sides.

- Press down firmly on all four sides. In particular, carefully press down on the side facing the direction in which the envelopes will be fed. Press down firmly so that the flap stays flat.



! IMPORTANT:

- Failure to firmly press down on the flap may result in a paper jam. If this happens, press down firmly on all four sides of each individual envelope.

4 Align the envelopes on a flat surface.

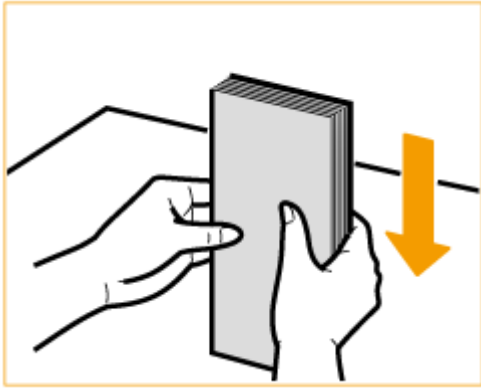

NOTE:

- Check that no envelopes are tucked underneath the flap of the envelope above or below them.

Loading the Envelopes in the Paper Drawer

1 Attach the Envelope Feeder Attachment to the paper drawer.

- 1 Remove the Envelope Feeder Attachment A stored in paper drawer 2.



- 2 Attach the Envelope Feeder Attachment A by aligning the protruding areas of the Envelope Feeder Attachment A with the holes on paper receptor located on the bottom of the paper drawer.

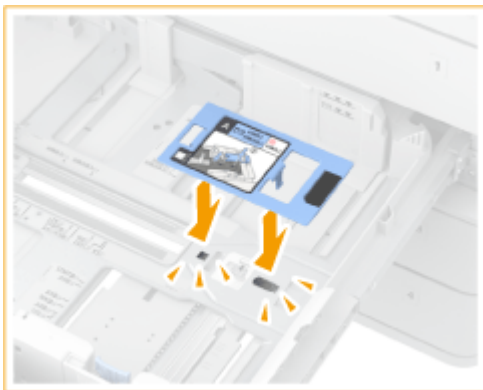

NOTE:

- When loading Kakugata 2, it is not necessary to attach the Envelope Feeder Attachment A.
- When not using the Envelope Feeder Attachment A, store it in the storage area of paper drawer 2.

2 Adjust the position of the paper guides.

Paper drawer 1 (ISO-C5)

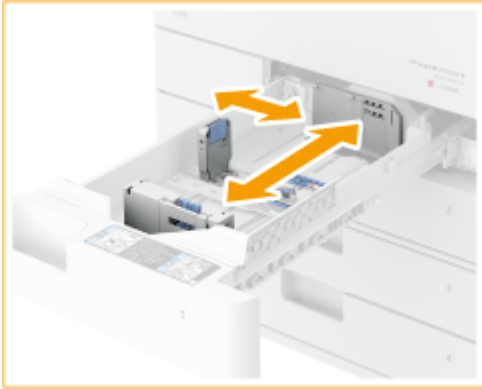

Paper drawer 2

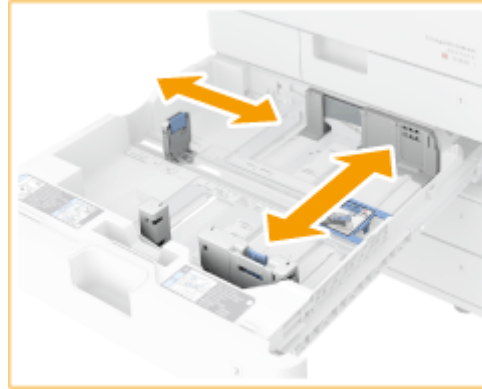

3 Load the envelopes.

Paper Drawer 1

Load the envelopes as indicated below, with the front side of the envelopes (the side without the glued areas) face up.



ISO-C5

Close the flaps, and load the envelopes so that their flaps are on the right side.

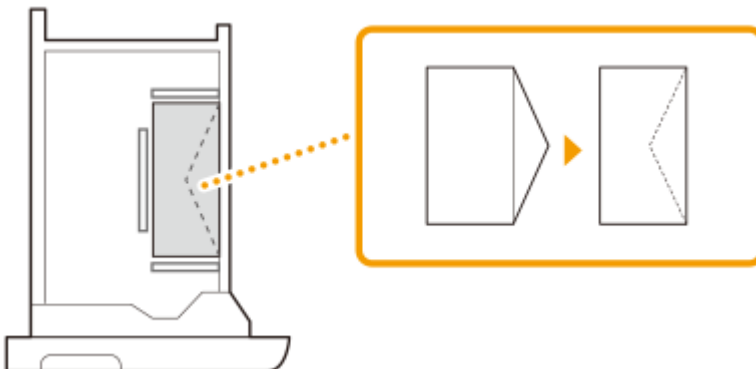

Paper Drawer 2

Load the envelopes as indicated below, with the front side of the envelopes (the side without the glued areas) face up.



Yougatanaga 3

Close the flaps, and load the envelopes so that their flaps are on the far side.

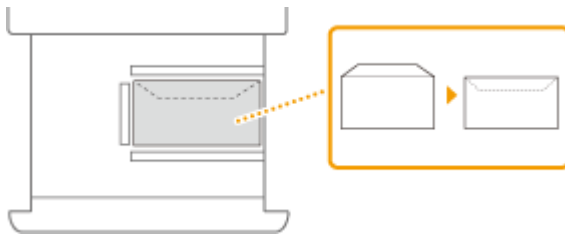

Monarch, COM10 No. 10, DL

Close the flaps, and load the envelopes so that their flaps are on the near side.

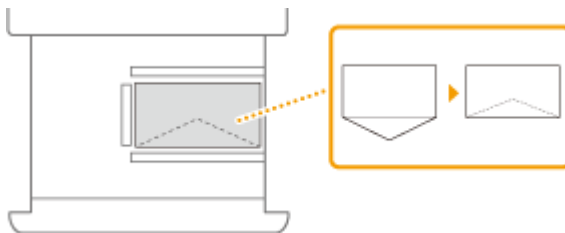

Nagagata 3, Kakugata 2

Load the envelopes so that their flaps are on the left side.

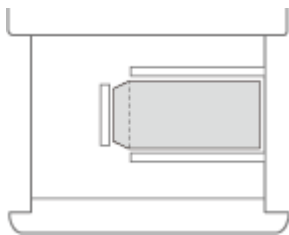

! IMPORTANT:

- Envelopes may not be able to be fed properly if they are loaded at an angle.

4 Register the type of envelope.

5 Change the paper size label of the paper drawer as necessary.

Loading Envelopes in the Multi-Purpose Tray

Load the envelopes as shown in the following illustrations, with the front side of the envelopes (the side without the glued areas) face down (recommended).

Yougatanaga 3

Close the flaps, and load the envelopes so that their flaps are on the far side.

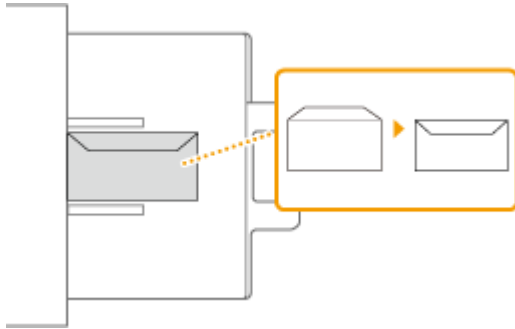

Nagagata 3, Kakugata 2

Load the envelopes so that their flaps are on the right side.

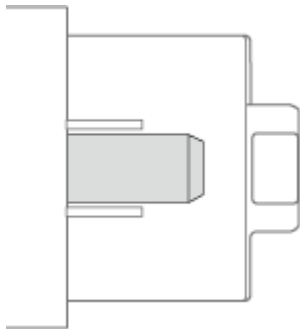

Monarch, COM10 No. 10, DL, ISO-C5

Close the flaps, and load the envelopes so that their flaps are on the left side.

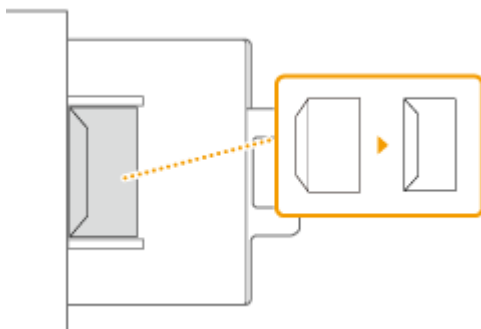

To change the orientation of the envelopes, load them as shown in the figures below.

Yougatanaga 3

lose the flaps, and load the envelopes so that their flaps are on the left side.

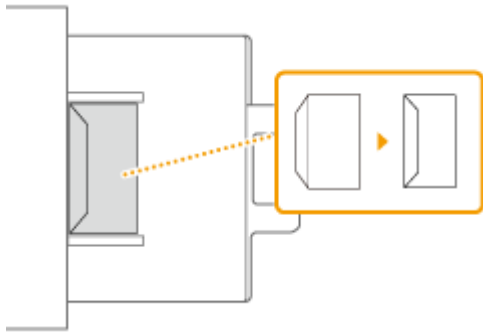

Nagagata 3

Load the envelopes so that their flaps are on the far side.

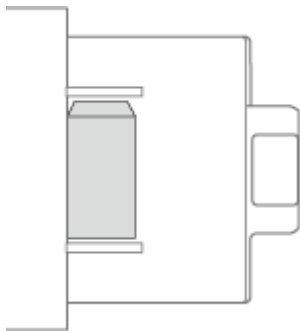

Monarch, COM10 No. 10, DL, ISO-C5

Close the flaps, and load the envelopes so that their flaps are on the near side.

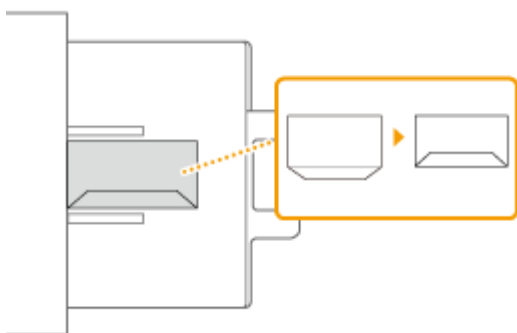

! IMPORTANT

- You can load up to 10 envelopes at the same time. If the envelopes are not fed properly even if they have been prepared according to the procedures, load the envelopes individually in the multi-purpose tray instead of loading several sheets together.
- Do not print on the reverse side of the envelopes (the side with the glued areas).

NOTE

- When you print on envelopes, remove them from the output tray 10 at a time.
- When using Kakugata 2, place it horizontally.
- If envelopes become wrinkled, load the envelopes with the long edge of the envelopes facing the machine.

Loading Preprinted Paper

961F-010

When you use paper that has been preprinted with a logo, pay attention to the orientation of the paper when loading it in the paper source. Load the paper properly so that printing is performed on the same side as the logo.

- ▶ Loading Paper with Logos in Portrait Orientation(P. 61)
- ▶ Loading Paper with Logos in Landscape Orientation(P. 62)

Orientation of the original when copying

When performing a copy operation, pay attention to the orientation of the original to be placed. Place the original in the feeder with the side to copy face up or on the platen glass with the side to copy face down, as shown in the figure below.

- For A4 or A5 portrait layout originals

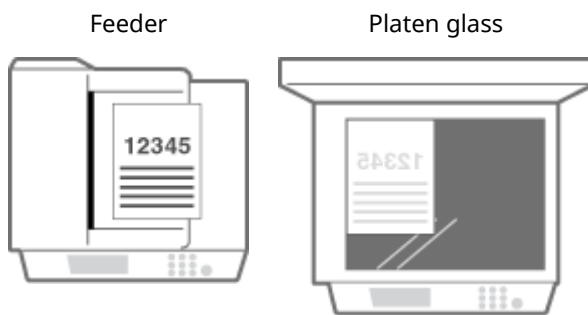

- For A3 portrait layout originals

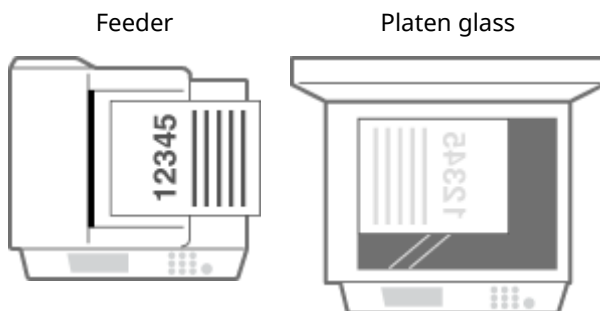

- For A4 or A5 landscape layout originals

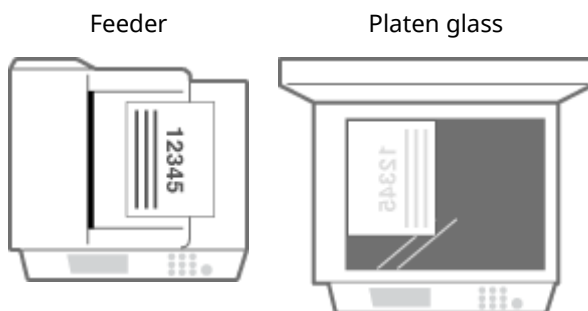

- For A3 landscape layout originals

Feeder Platen glass



NOTE

- This section describes how to load preprinted paper with the proper orientation. For a description of the general procedure for loading paper in the paper drawer or multi-purpose tray, see **Basic Paper Loading Method(P. 47)** .
- This section describes how to load preprinted paper when performing one-sided copying/printing. When performing two-sided copying/printing using preprinted paper, load paper by interpreting that the indications in this section referring to the facing of the paper mean the opposite.
- To ensure that pages are printed on the proper side of preprinted paper irrespective of one-sided or two-sided printing, you can use the following setting methods.
 - By specifying the paper type each time to print: load the paper type registered with "Preprinted Paper" set to <On> in <Paper Type Management Settings>, specify that paper type and then perform the printing.
 - By specifying the paper source each time to print: load paper in the paper source for which <Switch Feed Method> is set to <Print Side Priority>, specify that paper source and then perform the printing.
- Proper manner of loading preprinted paper when "Preprinted Paper" is set to <On> in <Paper Type Management Settings> or when <Switch Feed Method> is set to <Print Side Priority>
 - Paper drawer: the logo side face down
 - Paper source other than the paper drawer: the logo side face up
- Set <Speed Priority for Copying from Feeder> to <Off> in advance.
 - ▶<Speed Priority for Copying from Feeder>(P. 1200)

Loading Paper with Logos in Portrait Orientation

The loading method varies depending on the size of the paper with the logo and the paper source that is used.



When Loading A4-, A5-size Paper with Logos

Load the paper so that the logo faces up in the paper drawer and faces down in the multi-purpose tray, as shown in the illustrations below.

Paper drawer

Multi-purpose tray

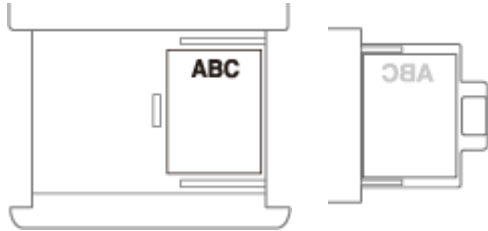

When Loading A3-size Paper with Logos

Load the paper so that the logo faces up in the paper drawer 2 and faces down in the multi-purpose tray, as shown in the illustrations below.

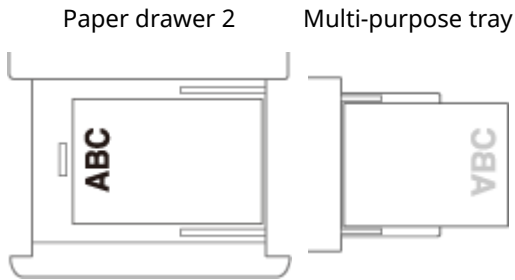

Loading Paper with Logos in Landscape Orientation

The loading method varies depending on the size of the paper with the logo and the paper source that is used.



When Loading A4-, A5-size Paper with Logos

Load the paper so that the logo faces up in the paper drawer and faces down in the multi-purpose tray, as shown in the illustrations below.

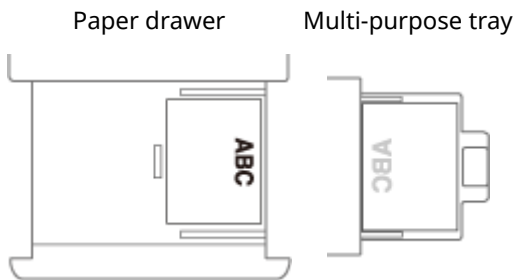

When Loading A3-size Paper with Logos

Load the paper so that the logo faces up in the paper drawer 2 and faces down in the multi-purpose tray, as shown in the illustrations below.

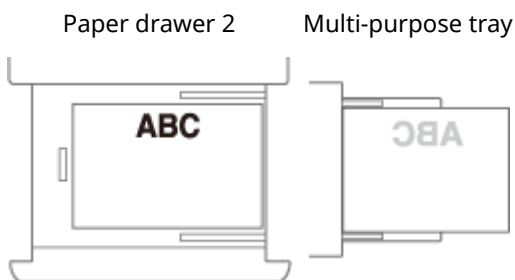

LINKS

▶ **Supported Paper Sizes(P. 224)**

Specifying Paper Size and Type

961F-011

You must specify the paper size and type settings to match the paper that is loaded. Make sure to change the paper settings when you load paper that is different from the previously loaded paper.

- ▶ **Specifying Paper Size and Type in the Paper Drawer(P. 65)**
- ▶ **Specifying Paper Size and Type in the Multi-purpose Tray(P. 68)**
- ▶ **Registering Frequently Used Paper Size and Type for the Multi-purpose Tray(P. 72)**
- ▶ **Fixing the Paper Size and Type to Use with the Multi-Purpose Tray(P. 75)**
- ▶ **Registering Free Size Paper (Custom Size Paper)(P. 78)**
- ▶ **Automatically Selecting the Appropriate Paper Source for a Specific Function (P. 79)**

IMPORTANT

- If the setting does not match the size and type of loaded paper, a paper jam or printing error may occur.

Specifying Paper Size and Type in the Paper Drawer

961F-012

- 1 Load the paper in the paper drawer. **▶Basic Paper Loading Method(P. 47)**
- 2 Press  (Settings/Registration).
- 3 Press <Preferences> ▶ <Paper Settings> ▶ <Paper Settings>.
- 4 Check the paper size that is displayed.

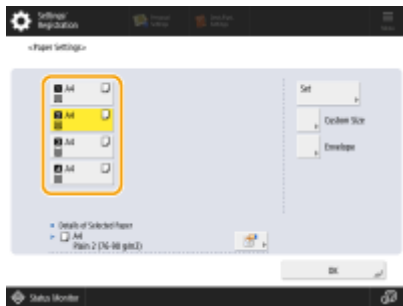

- When loading standard size paper, the paper size is automatically detected.
- The paper sources are represented by the following icons, respectively. Note that the paper source indications differ depending on the options installed.

- 1: The paper drawer 1
- 2: The paper drawer 2
- 3: The paper drawer 3
- 4: The paper drawer 4

NOTE

- If the displayed paper size is different from the loaded paper size, the paper may not be loaded properly. Load the paper again.
- Even when paper is loaded correctly, some small standard sizes may not be detected correctly. In this case, press <Unrecognized Standard Size> and select the paper size. **▶Automatically Detectable Paper Sizes(P. 231)**
- If <Custom> is displayed even though the standard size paper is loaded, press <Custom Size> ▶ <Cancel Settings>. The correct size will be displayed.

■When loading custom size paper

Specify the size of paper loaded in the paper drawer.

- 1 Select the paper drawer in which paper is loaded and press <Custom Size>.
- 2 Specify the length of the <X> side and <Y> side.



- Press <X> or <Y> to enter the length of each side using the numeric keys.

NOTE

- If you register the paper size you use frequently on buttons <S1> to <S5>, you can call them up with one touch. ▶ **Registering Free Size Paper (Custom Size Paper)(P. 78)**

- 3 Press <OK>.

■When loading envelopes

Specify the type of envelopes loaded in the paper drawer.

- 1 Select the paper drawer in which envelopes are loaded and press <Envelope>.
- 2 Select the type of envelopes loaded in the paper drawer.



- If you selected <Nagagata 3> for the paper drawer 1, press <Next>, and specify the flap length.

- 3 Press <OK>.

■When loading paper of the size that is standard but cannot be detected automatically

Specify the paper size that is standard but cannot be detected by the machine automatically.

- 1 Select the paper drawer in which the undetected standard size paper is loaded, and press <Unrecognized Standard Size>.
- 2 Select the size of paper that is loaded in the paper drawer.
- 3 Press <OK>.

- 5 Select the paper source in which paper is loaded and press <Set>.

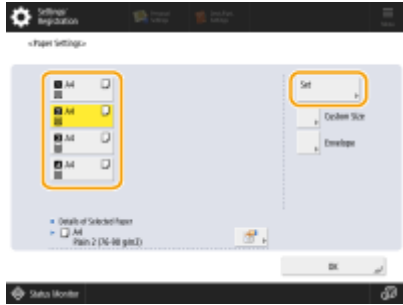

6 Select the paper type and press <OK>.

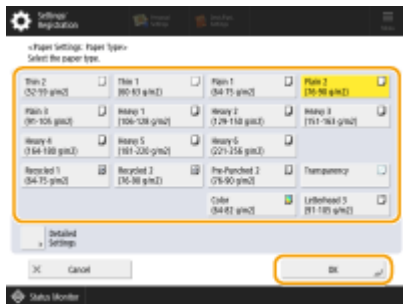

NOTE

- If the paper type loaded is not displayed, press <Detailed Settings> to select from a list.
- If the paper type of the paper that you have loaded is not listed on the detailed setting screen, you can register it in the paper type list. ▶ **Paper Type Management Settings(P. 1039)**

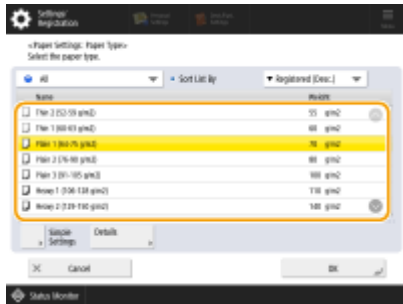

7 Press <OK>.

8 Change the paper size label of the paper drawer as necessary. ▶ **Attaching the appropriate paper size label(P. 32)**

LINKS

▶ **Hardware Specifications(P. 215)**

Specifying Paper Size and Type in the Multi-purpose Tray

961F-013

! IMPORTANT

- If <Paper Feed Mode for Printer Driver Jobs with MP Tray> is set to <Mode A (Prioritize Printer Driver Settings)>, printer driver settings are prioritized when the multi-purpose tray is specified as the paper source for jobs from the printer driver.
- A paper jam or other printing problems may occur if the size and type of paper specified in the printer driver do not match those of the actual paper loaded in the multi-purpose tray.

1 Load the paper in the multi-purpose tray. ▶ Loading Paper in the Multi-Purpose Tray(P. 50)

⇒ The screen for specifying the paper size and type is displayed.

2 Specify the paper size.



- When loading standard size paper, the paper size is automatically detected. The paper sizes for automatic detection can be fixed to A/B size, inch size, or A/K size. ▶ <Paper Size Group for Auto Recognition in Drawer>(P. 1060)

NOTE

- If the displayed paper size is different from the loaded paper size, the paper may not be loaded properly. Load the paper again.
- Even when paper is loaded correctly, some small standard sizes may not be detected correctly. In this case, press <Standard Size> and select the paper size. ▶ <Automatically Detectable Paper Sizes(P. 231)>
- If you press <Favorite Paper> and register the frequently used paper size on buttons, you can call them up with a simple press. ▶ <Registering Frequently Used Paper Size and Type for the Multi-purpose Tray(P. 72)>

■ When loading standard size paper

- 1 Press <Standard Size>.
- 2 Select the paper size and press <OK>.

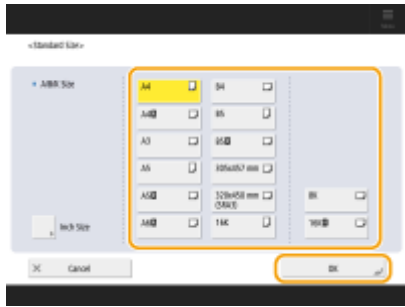

NOTE

- Press <Inch Size> to select an inch paper size.

■When loading custom size paper

- 1 Press <Custom Size>.

NOTE

- You can specify the paper size as <Free Size>, which eliminates the need to enter the paper size setting. Specify <Free Size> when you load paper of unknown size to use for copying or when the paper size is already registered in the printer driver.

- 2 Specify the length of the <X> side and <Y> side.

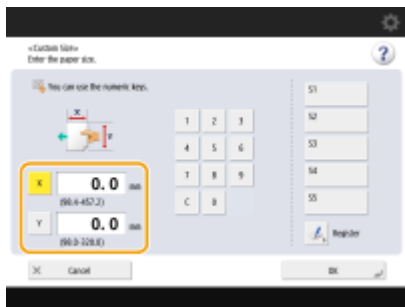

- Press <X> or <Y> to enter the length of each side using the numeric keys.

NOTE

- If you register the paper size you use frequently on buttons <S1> to <S5>, you can call them up with a simple press. ▶ **Registering Free Size Paper (Custom Size Paper)(P. 78)**

- 3 Press <OK>.

■When loading envelopes

- 1 Press <Envelope>.

- The envelope paper type cannot be selected from the details screen of <Paper Type>. To select the envelope paper type, register the paper type in <Register Favorite Paper (Multi-Purpose Tray)>, then press <Favorite Paper> in step 2 ▶ the button to which the envelope paper type has been registered ▶ <OK>. ▶ **Registering Frequently Used Paper Size and Type for the Multi-purpose Tray(P. 72)**

- 2 Select the orientation and type of envelopes.



- If you changed the placement of the envelopes, press <Short Edge Feed> or <Long Edge Feed>, and select the envelope type.
- If you selected vertical placement for Nagagata 3, press <Next>, and specify the flap length.
- To register a custom size envelope, press <Custom> ► <Next> and press <X> or <Y> to specify the side, then use the numeric keys to enter the length of the specified side.
- Press <OK> and proceed to step 5.

! IMPORTANT

- When using Kakugata 2, place it horizontally.

3 Press <Change> in <Paper Type>.

4 Select the paper type and press <OK>.

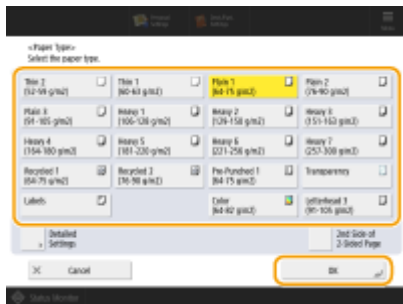

NOTE

- If the paper type loaded is not displayed, press <Detailed Settings> to select from a list.
- If the paper type of the paper that you have loaded is not listed on the detailed setting screen, you can register it in the paper type list. ► **Paper Type Management Settings(P. 1039)**
- The envelope paper type cannot be selected from the details screen of <Paper Type>. To select the envelope paper type, register the paper type in <Register Favorite Paper (Multi-Purpose Tray)>, then press <Favorite Paper> in step 2 ► the button to which the envelope paper type has been registered ► <OK>. ► **Registering Frequently Used Paper Size and Type for the Multi-purpose Tray(P. 72)**

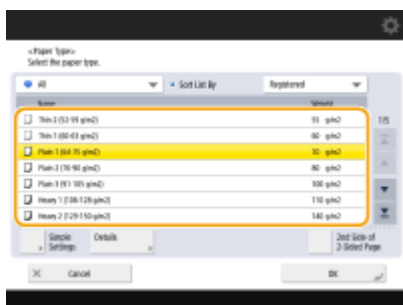

5 Press <OK>.

NOTE

If a screen other than that for specifying the paper size and type is displayed

- If a message prompting you to adjust the paper guide is displayed, adjust the width of the paper guide again and press <OK>.

LINKS

▶ [Hardware Specifications\(P. 215\)](#)

▶ [<Paper Feed Mode for Printer Driver Jobs with MP Tray>\(P. 1203\)](#)

Registering Frequently Used Paper Size and Type for the Multi-purpose Tray

961F-014

If you use a specific size and type of paper by loading in the multi-purpose tray, you can register that paper in advance as "Favorite Paper" for the multi-purpose tray. "Favorite Paper" can easily be called up from the screen which is displayed when you load the paper in the multi-purpose tray, so that you can save the time and labor to make size and type settings each time you use the specific paper.

- 1 Press  (Settings/Registration).
- 2 Press <Preferences> ▶ <Paper Settings> ▶ <Register Favorite Paper (Multi-Purpose Tray)>.
- 3 Select a button to register and press <Register/Edit>.

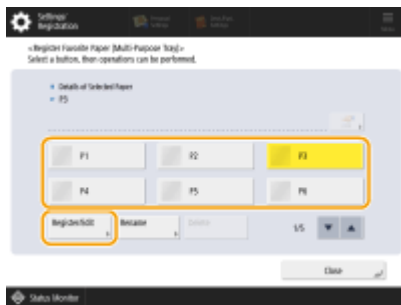

- You can change the registered name by pressing <Rename>.

4 Select the paper size.



■ When registering standard size paper

- 1 Select the standard size paper.
- 2 Press <Next>.

■ When registering custom size paper

- 1 Press <Custom Size>.

NOTE

- You can specify the paper size as <Free Size>, which eliminates the need to enter the paper size setting. Specify <Free Size> when you load paper of unknown size to use for copying or when the paper size is already registered in the printer driver.

2 Specify the length of the <X> side and <Y> side.



- Press <X> or <Y> to enter the length of each side using the numeric keys.

NOTE

- If you register the paper size you use frequently on buttons <S1> to <S5>, you can call them up with one touch. ▶ **Registering Free Size Paper (Custom Size Paper)(P. 78)**

3 Press <OK> ▶ <Next>.

■When registering envelopes

- 1** Press <Envelope>.
- 2** Select the orientation and type of envelopes.



- If you changed the placement of the envelopes, press <Short Edge Feed> or <Long Edge Feed>, and select the envelope type.
- If you selected vertical placement for Nagagata 3, press <Next>, and specify the flap length.
- To register a custom size envelope, press <Custom> ▶ <Next> and press <X> or <Y> to specify the side, then use the numeric keys to enter the length of the specified side.

! IMPORTANT

- When using Kakugata 2, place it horizontally.

3 Press <OK> ▶ <Next>.

5 Select the paper type and press <OK>.

6 Press <Close>.

TIPS

- If <Always Specify> under <Multi-Purpose Tray Defaults> is set to <Favorite Paper>, a screen is displayed to allow you to select your "Favorite Paper" when you load the paper in the multi-purpose tray. ▶<Multi-Purpose Tray Defaults>(P. 1061)

LINKS

- ▶<Loading Paper in the Multi-Purpose Tray>(P. 50)
- ▶<Hardware Specifications>(P. 215)

Fixing the Paper Size and Type to Use with the Multi-Purpose Tray

961F-015

If you always use the same paper size and type with the multi-purpose tray, it is recommended that you fix the paper size and type settings for the multi-purpose tray. This is convenient because you can save the time and labor to make settings each time you load paper in the multi-purpose tray.

- 1 Press  (Settings/Registration).
- 2 Press <Preferences> ▶ <Paper Settings> ▶ <Multi-Purpose Tray Defaults>.
- 3 Press <Use Preset> ▶ <Register>.
- 4 Select the paper size.



■ When registering standard size paper

- 1 Select the standard size paper.
- 2 Press <Next>.

■ When registering custom size paper

- 1 Press <Custom Size>.

NOTE

- You can specify the paper size as <Free Size>, which eliminates the need to enter the paper size setting. Specify <Free Size> when you load paper of unknown size to use for copying or when the paper size is already registered in the printer driver.
- 2 Specify the length of the <X> side and <Y> side.

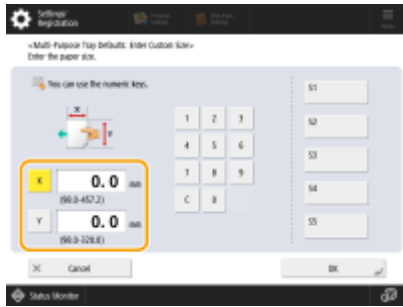

- Press <X> or <Y> to enter the length of each side using the numeric keys.

NOTE

- If you register the paper size you use frequently on buttons <S1> to <S5>, you can call them up with one touch. ▶ **Registering Free Size Paper (Custom Size Paper)(P. 78)**

3 Press <OK> ▶ <Next>.

■When registering envelopes

- 1** Press <Envelope>.
- 2** Select the orientation and type of envelopes.



- If you changed the placement of the envelopes, press <Short Edge Feed> or <Long Edge Feed>, and select the envelope type.
- If you selected vertical placement for Nagagata 3, press <Next>, and specify the flap length.
- To register a custom size envelope, press <Custom> ▶ <Next> and press <X> or <Y> to specify the side, then use the numeric keys to enter the length of the specified side.

! IMPORTANT

- When using Kakugata 2, place it horizontally.

3 Press <OK> ▶ <Next>.

5 Select the paper type and press <OK>.

6 Press <OK>.

7 Press <Close>.

LINKS

- ▶ **Loading Paper in the Multi-Purpose Tray(P. 50)**
- ▶ **Hardware Specifications(P. 215)**
- ▶ **Registering Frequently Used Paper Size and Type for the Multi-purpose Tray(P. 72)**

Registering Free Size Paper (Custom Size Paper)

961F-016

You can register up to five frequently used free sizes of paper. The paper sizes registered here are displayed on the paper size selection screen for the paper drawer and multi-purpose tray ([▶Specifying Paper Size and Type in the Paper Drawer\(P. 65\)](#) or [▶Specifying Paper Size and Type in the Multi-purpose Tray\(P. 68\)](#)).

- 1 Press  (Settings/Registration).
- 2 Press <Preferences> ▶ <Paper Settings> ▶ <Register Custom Size>.
- 3 Select a button from <S1> to <S5> and press <Register/Edit>.



- You can assign an easy to remember name to the button by pressing <Rename>.

- 4 Set the paper size and press <OK>.



- Specify the length of the <X> side and <Y> side. Press <X> or <Y> to enter the length of each side using the numeric keys.

- 5 Press <Close>.

LINKS

- ▶ [Basic Paper Loading Method\(P. 47\)](#)

Automatically Selecting the Appropriate Paper Source for a Specific Function

961F-017

Paper sources in which <Paper Source Auto Selection> are set to <On> will be automatically selected when <Select Paper> is set to <Auto>. Paper sources in which <Paper Source Auto Selection> are set to <Off> will not be selected unless they are selected manually.

NOTE

- To the paper source to be selected automatically, one of the following paper types must be selected for each paper source.
 - If <Consider Paper Type> is set to <On>
 - 1-Sided Printing: Thin^{*1}, Plain, Recycled
 - 2-Sided Printing: Thin^{*1}, Plain, Recycled
 - If <Consider Paper Type> is set to <Off>
 - 1-Sided Printing: Thin^{*1}, Plain, Recycled, Heavy^{*1}, Color^{*1} (in white)
 - 2-Sided Printing: Thin^{*1}, Plain, Recycled, Heavy^{*1}, Color^{*1} (in white)

^{*1} Only paper that can be printed on both sides are available. For more information, see **Paper Available for 2-Sided Copying/2-Sided Printing(P. 230)** .

- When the copy ratio is set to <Auto>, a paper source will not be selected automatically.
- When one of the following modes is set, a paper source will not be selected automatically.
 - Booklet
 - N on 1, Poster, Copy ID Card
 - Repeat Images
 - Rotate Collate, Rotate Group
- It is necessary to select at least one paper source. However, you cannot set only the multi-purpose tray to <On>.

1 Press  (Settings/Registration).

2 Press <Function Settings> ▶ <Common> ▶ <Paper Feed Settings> ▶ <Paper Source Auto Selection>.

3 Select the function.

- <Other> enables you to make settings for a paper source that is used for outputting reports.

4 Select <On> for each paper source that you want to be selected automatically.

If you selected <Copy> in step 3

Set whether to consider paper type.

- If you select the <Consider Paper Type> check box: when the current paper source runs out of paper, copying is halted even if another paper source is loaded with paper of the same size, unless the type of that paper is the same as with the paper in question. Pressing  (Start) again displays the paper selection screen.
- If you deselect the <Consider Paper Type> check box: when the current paper source runs out of paper, automatic paper source switching is performed and copying is continued if another paper source is loaded with paper of the same size, regardless of the paper type.

If you selected <Printer> in step 3

Set whether to put multiple paper sources in a group. If paper source grouping is specified, paper source selection is automatically performed within a group when you print by specifying any paper source belonging to that group. To specify paper source grouping, select the <Use Group> check box, press <Change> to select a group which you want to put each paper source in, and press <OK>.

NOTE:

- When paper runs out during printing and there is paper of the same size placed horizontally (A4R and LTRR) in another source that is set for automatic selection, the operation differs according to the function, as indicated below.
 - <Copy>, <Printer>, and <Access Stored Files>: The machine stops printing without switching to a source of paper placed horizontally.
 - Functions other than the above: The machine switches to a source of paper placed horizontally and continues printing.

5 Press <OK> ► <OK>.

Specifying the Output Tray for Preprinted Paper

961F-018

You can specify which output tray to output preprinted paper to. Specifying the output tray for each function can reduce the time needed to search for the output paper. You can also specify the output tray priority when multiple output trays are specified for the same function. **▶<Output Tray Settings>(P. 1168)**

NOTE

- This setting is available only if your machine has multiple output trays.

Available Functions by Device Configuration and Output Tray

Device Configuration	Available Functions by Output Tray and Default Priority	Tray Location
Inner 2way Tray-M	<Tray A> 1 Copy, 1 Access Stored Files, 1 Printer, 2 Receive, 2 Other, 2 IP Fax, 2 Fax <Tray B> 2 Copy, 2 Access Stored Files, 2 Printer, 1 Receive, 1 Other, 1 IP Fax, 1 Fax	
Inner 2way Tray-M and Copy Tray-T	<Tray A> 1 Copy, 1 Access Stored Files, 1 Printer, Receive, Other, IP Fax, Fax <Tray B> 2 Copy, 2 Access Stored Files, 2 Printer, Receive, Other, IP Fax, Fax <Tray C> Copy, Access Stored Files, Printer, 1 Receive, 1 Other, 1 IP Fax, 1 Fax	
Inner Finisher-L	<Tray A> 1 Copy, 1 Access Stored Files, 1 Printer, 2 Receive, 2 Other, 2 IP Fax, 2 Fax <Tray B> 2 Copy, 2 Access Stored Files, 2 Printer, 1 Receive, 1 Other, 1 IP Fax, 1 Fax	
Inner Finisher-L and Copy Tray-T	<Tray A> 1 Copy, 1 Access Stored Files, 1 Printer, Receive, Other, IP Fax, Fax <Tray B> 2 Copy, 2 Access Stored Files, 2 Printer, Receive, Other, IP Fax, Fax <Tray C> Copy, Access Stored Files, Printer, 1 Receive, 1 Other, 1 IP Fax, 1 Fax	
Staple Finisher-AE or Booklet Finisher-AE	<Tray A> 2 Copy, 2 Access Stored Files, 2 Printer, 1 Receive, Other, 1 IP Fax, 1 Fax <Tray B> 1 Copy, 1 Access Stored Files, 1 Printer, Receive, Other, IP Fax, Fax <Tray C>	

	Copy, Access Stored Files, Printer, Receive, 1 Other, IP Fax, Fax	
Staple Finisher-AE and Copy Tray-T or Booklet Finisher-AE and Copy Tray-T	<p><Tray A> 2 Copy, 2 Access Stored Files, 2 Printer, 1 Receive, Other, 1 IP Fax, 1 Fax</p> <p><Tray B> 1 Copy, 1 Access Stored Files, 1 Printer, Receive, Other, IP Fax, Fax</p> <p><Tray C> Copy, Access Stored Files, Printer, Receive, 1 Other, IP Fax, Fax</p> <p><Tray D> Copy, Access Stored Files, Printer, 2 Receive, Other, 2 IP Fax, 2 Fax</p>	

! IMPORTANT

- If a certain tray reaches its stacking limit, the machine automatically uses another tray that is designated for the same function. However, it is recommended that you only designate one tray for fax/I-fax documents to prevent them from getting lost.

NOTE

- The priority order of the output trays is determined by the order of the selected output trays. The priority is displayed as "1," "2," and "3."
- Select <Other> when printing reports.
- The IP fax function is displayed when the option is enabled.
- The fax function is displayed for device configurations with a fax board installed.
- A number is displayed at the end of the IP fax and fax functions to indicate the number of lines that are enabled.
- Paper may not be output to the output tray specified with this setting, depending on the paper that is used and the finishing functions that are set.
- The paper sizes that can be output to each output tray differ according to the device configuration. For details, see **Optional Equipment(P. 173)** .
- When an output tray that does not support the Offset mode is selected in the output tray setting, the copies will not be output to the output tray according to the specified settings if <Offset> is enabled. Perform one of the procedures below to solve this problem.
 - Disable <Offset at Same Time> in the auto collate settings. **Auto Collate>(P. 1198)**
 - Specify an output tray that supports the Offset mode in the output tray settings.
 - Manually disable <Collate> before executing the job.
- When <Use Optional Output Tray> is set to <Off>, the optional output tray cannot be selected as the output tray. **Use Optional Output Tray> *(P. 1169)**

Main Unit Maintenance

961F-019

This section describes the maintenance and management of the machine, such as regular cleaning and the replacement of consumables. It also describes the maintenance service provided by Canon. For information on precautions to take during maintenance, see the "Important Safety Instructions" included with the machine and **▶ Handling of the Options(P. 172)** .

■ Basic Cleaning



▶ **Regular Cleaning(P. 84)**

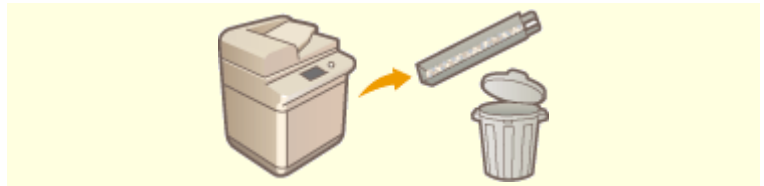

▶ **Emptying the Punch Waste (Optional)(P. 118)**

■ Replacing Consumables

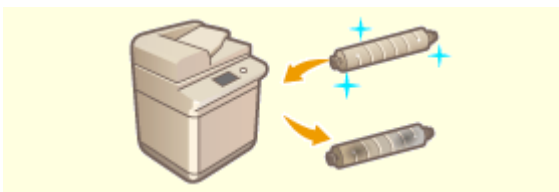

▶ **Replacing the Toner Cartridge(P. 99)**



▶ **Replacing the Waste Toner Container(P. 103)**



▶ **Replenishing the Staples (Optional)(P. 106)**

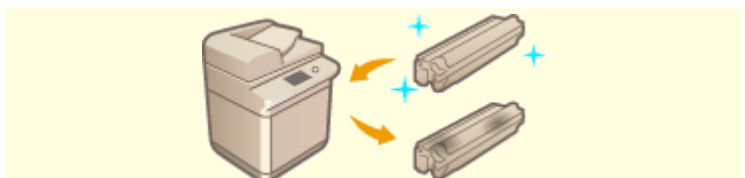

▶ **Replacing the Drum Unit(P. 114)**



▶ **Replacement Parts(P. 123)**



▶ **Checking the Remaining Amount of Consumables(P. 128)**

Regular Cleaning

961F-01A

It is recommended that you periodically clean the machine to prevent loss of print quality and enable you to use the machine comfortably and safely. Clean the locations indicated by **a** to **e** in the following figures.



- a** Exterior ▶ **Cleaning the Exterior(P. 85)**
- b** Platen glass ▶ **Cleaning the Platen Glass(P. 86)**
- c** Feeder ▶ **Cleaning the Feeder(P. 88)**
- d** Interior ▶ **<Clean Inside Main Unit>(P. 1154)**
- e** Dust-proof glass ▶ **Cleaning the Dust-Proof Glass(P. 97)**

Cleaning the Exterior

961F-01C

Periodically wipe the surface of the machine to keep it clean.

1 Turn the power OFF, and remove the power plug from the power outlet.

▶Turning OFF the Machine(P. 36)

! IMPORTANT:

- Check the operation status of the machine before turning the power OFF. You can turn the power OFF even if the machine is executing an operation, but this may cause the operation to be interrupted or data to become damaged.

2 Wipe the surface of the machine.

- Wet a soft cloth with water or diluted mild detergent, wring the cloth out well, and wipe the machine.



- Wait until the moisture has completely dried before proceeding to the next step.

3 Insert the power plug into the power outlet, and turn the power ON.

▶Turning ON the Machine(P. 35)

Cleaning the Platen Glass

961F-01E

If the platen glass is dirty, originals may not be scanned clearly, or the size of the original may not be detected clearly.

1 Turn the power OFF, and remove the power plug from the power outlet.

▶Turning OFF the Machine(P. 36)

! IMPORTANT:

- Check the operation status of the machine before turning the power OFF. You can turn the power OFF even if the machine is executing an operation, but this may cause the operation to be interrupted or data to become damaged.

2 Open the feeder.



3 Wipe the reverse side of the feeder and the platen glass.

1 Wipe the platen glass.

- Wipe the platen glass with the included cleaning cloth.



NOTE:

- If the cleaning sheet is dirty, rinse it in water and dry it before using it.

2 Wipe the reverse side of the feeder.

- If you cannot remove the dirt, wet a soft cloth with water and wring it out well, then wipe the reverse side of the feeder with it. Afterwards, wipe the reverse side of the feeder with a soft

and dry cloth. Wait until the moisture has completely dried before proceeding to the next step.



NOTE:

If you cannot remove the dirt

- Wet a soft cloth with mild detergent and wring it out well, then wipe the machine with it. Afterwards, wipe the machine with a soft and dry cloth.

4 Gently close the feeder.

5 Insert the power plug into the power outlet, and turn the power ON.

- ▶ **Turning ON the Machine(P. 35)**

Cleaning the Feeder

If any of the following problems occurs when the document is scanned from the feeder, then perform feeder cleaning.

- The document cannot be scanned clearly
- The size of the document cannot be detected correctly
- The document gets dirty during scanning
- Paper jam occurs frequently

▶ **When the 2-Sided Single Pass Feeder (Single Pass DADF-C) is attached(P. 88)**

▶ **When the 2-Sided Double Pass Feeder (DADF-BA) is attached(P. 92)**

When the 2-Sided Single Pass Feeder (Single Pass DADF-C) is attached

The Single Pass DADF-C is an optional product.

1 Turn the power OFF, and remove the power plug from the power outlet.

▶ **Turning OFF the Machine(P. 36)**

! IMPORTANT:

- Check the operation status of the machine before turning the power OFF. You can turn the power OFF even if the machine is executing an operation, but this may cause the operation to be interrupted or data to become damaged.

2 Pull the lever, and open the feeder cover.

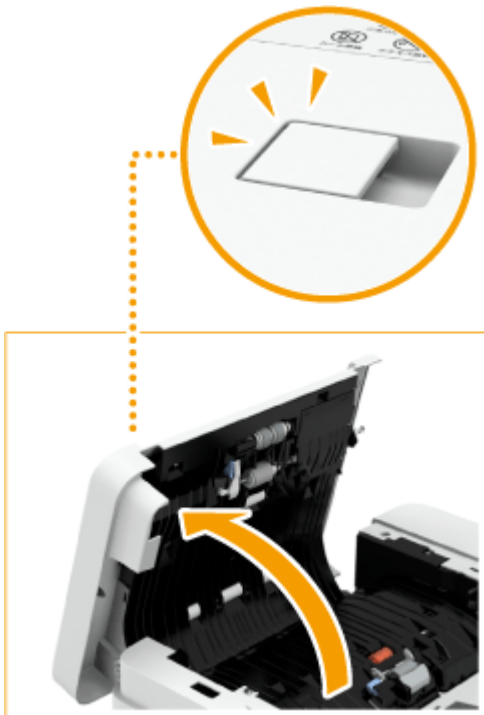

3 Clean the rollers inside the feeder cover.

- Wet a soft cloth with water and wring it out well, then wipe the rollers with it. Afterwards, wipe the rollers with a soft and dry cloth.



! IMPORTANT:

- Make sure that no trash such as pieces of paper gets into the groove of the multiple sheet feed detection sensor. If trash does get in, remove it using a soft cloth.



- If the rollers and surrounding areas are very dirty, clean them out. To do this, wet a cloth with water and wring it out well, then wipe the dirty areas. Afterwards, wipe the areas with a soft and dry cloth.



4 Gently close the feeder cover.

5 Open the feeder.

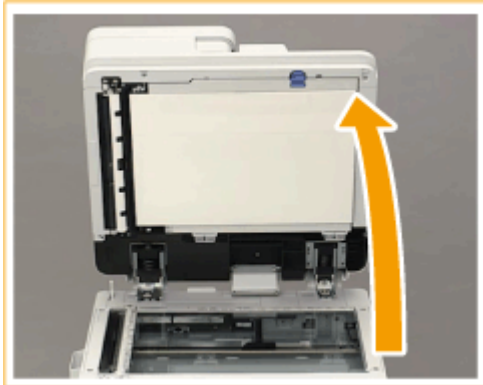

6 Wipe the document feed scanning area on the platen glass side.

- Wipe the thin glass strip (a) and the white plate (b).
- Wipe the area with the included cleaning cloth. If you cannot remove the dirt, wet a soft cloth with water and wring it out well, then wipe the machine with it. Afterwards, wipe the machine with a soft and dry cloth.

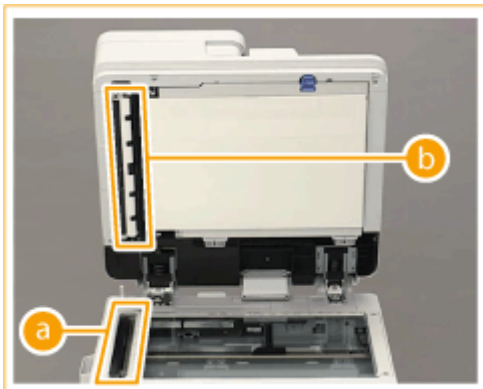

- Wait until the moisture has completely dried before proceeding to the next step.

7 Wipe the document feed scanning area on the feeder side.

- 1** Pull the top lever to open the document feed scanning area cover.
 - Gently open the cover so that you do not damage the platen glass.



- 2** Open the inner cover.

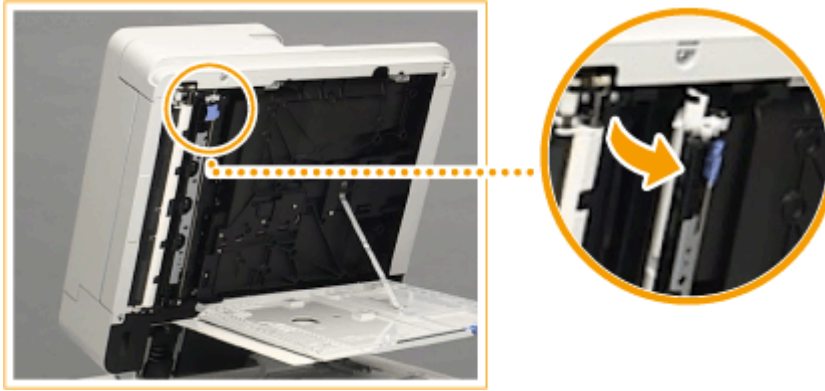

- 3** Wipe the document feed scanning area.

- Wipe the thin glass strip (a) and the white plate (b).
- Wet a soft cloth with water and wring it out well, then wipe the machine with it. Afterwards, wipe the machine with a soft and dry cloth.

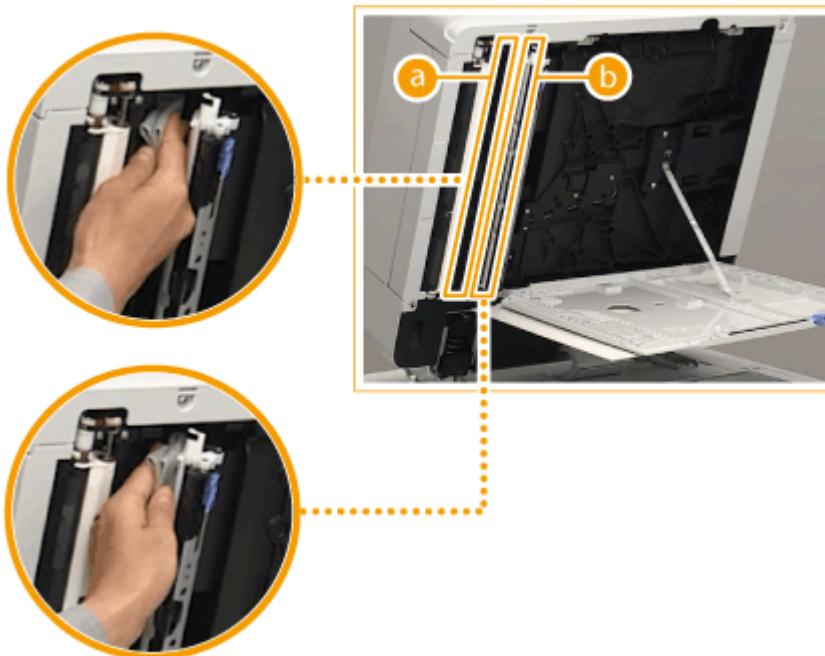

- Wait until the moisture has completely dried before proceeding to the next step.

- 4** Close the inner cover.

- 5** Close the document feed scanning area cover until it clicks into place.

- 8** Gently close the feeder.

- 9** Insert the power plug into the power outlet, and turn the power ON.

- ▶ Turning ON the Machine(P. 35)

NOTE

If streaks still appear on the originals or paper after the feeder cleaning operation

- Load about 10 sheets of A4 size paper in the feeder and perform the following procedure to execute **>Clean Feeder>(P. 1154)** . When a message indicating that cleaning is complete is displayed, try using the feeder to copy an original to check if the problem has been resolved.
- It takes approximately 20 seconds to clean the feeder.

When the 2-Sided Double Pass Feeder (DADF-BA) is attached

The DADF-BA is an optional product.

! IMPORTANT

- Spin the rollers while cleaning them.

1 Turn the power OFF, and remove the power plug from the power outlet.

>Turning OFF the Machine(P. 36)

! IMPORTANT:

- Check the operation status of the machine before turning the power OFF. You can turn the power OFF even if the machine is executing an operation, but this may cause the operation to be interrupted or data to become damaged.

2 Pull the lever, and open the feeder cover.



3 Clean the rollers inside the feeder cover.

- Wet a soft cloth with water and wring it out well, then wipe the rollers with it. Afterwards, wipe the rollers with a soft and dry cloth.

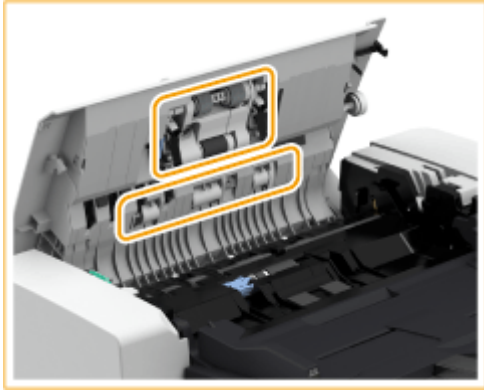

! IMPORTANT:

- If the rollers and surrounding areas are very dirty, clean them out. To do this, wet a cloth with water and wring it out well, then wipe the dirty areas. Afterwards, wipe the areas with a soft and dry cloth.

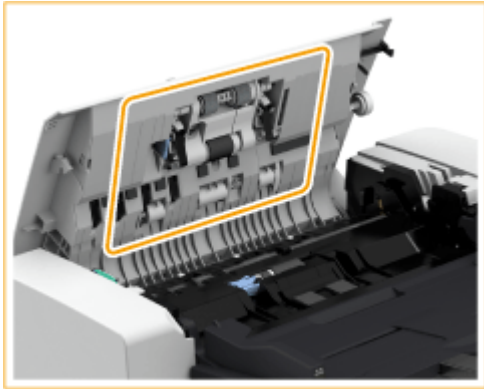

4 Clean the inside of the inner cover of the feeder.

- 1** Open the inner cover of the feeder.

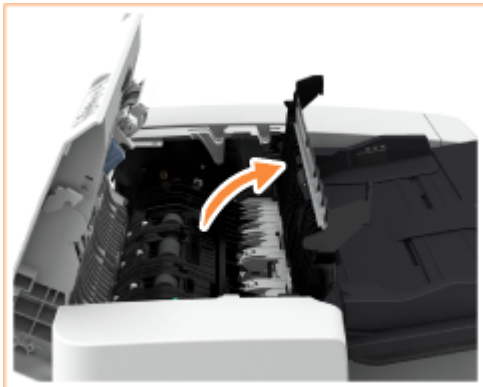

- 2** Wipe the transparent plastic.

- Wet a soft cloth with water and wring it out well, then wipe the plastic with it. Afterwards, wipe the plastic with a soft and dry cloth.

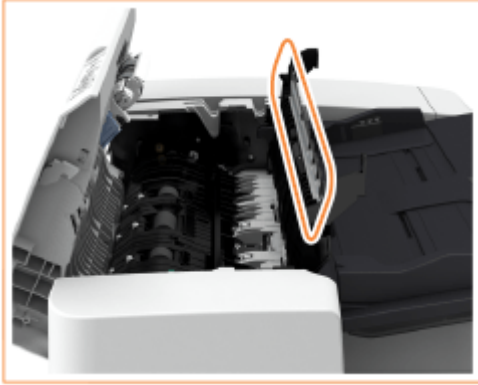

- Wait until the moisture has completely dried before proceeding to the next step.

3 Wipe the rollers (a total of three places) inside the inner cover.

- Wet a soft cloth with water and wring it out well, then wipe the rollers with it. Afterwards, wipe the rollers with a soft and dry cloth.

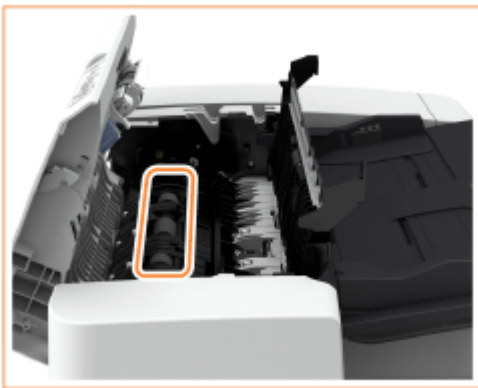

- Wait until the moisture has completely dried before proceeding to the next step.

4 Close the inner cover of the feeder.

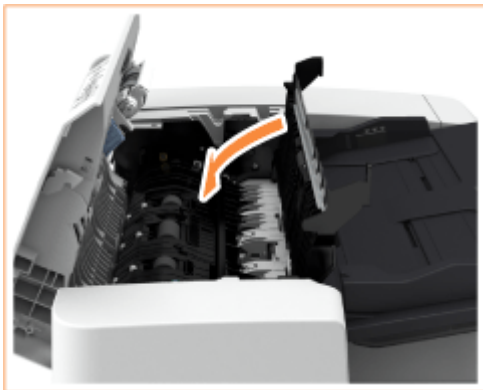

! IMPORTANT:

- When closing the inner cover of the feeder, be careful not to get your fingers caught, as this may result in personal injury.

5 Clean the document feed scanning area (thin glass strip) and the white area (rollers and plate).

1 Open the feeder.



2 Clean the white plate.

- Wet a soft cloth with water and wring it out well, then wipe the plate with it. Afterwards, wipe the plate with a soft and dry cloth.



- Wait until the moisture has completely dried before proceeding to the next step.

3 Clean the document feed scanning area.

- Wet a soft cloth with water and wring it out well, then wipe the area with it. Afterwards, wipe the area with a soft and dry cloth.



- Wait until the moisture has completely dried before proceeding to the next step.

4 Close the feeder.

! IMPORTANT:

- When closing the feeder, be careful not to get your fingers caught, as this may result in personal injury.

6 Gently close the feeder cover.

! IMPORTANT:

- When closing the feeder cover, be careful not to get your fingers caught, as this may result in personal injury.

7 Insert the power plug into the power outlet, and turn the power ON.

▶Turning ON the Machine(P. 35)

NOTE

If streaks still appear on the originals or paper after the feeder cleaning operation

- Load about 10 sheets of A4 size paper in the feeder and perform the following procedure to execute ▶<Clean Feeder>(P. 1154) . When a message indicating that cleaning is complete is displayed, try using the feeder to copy an original to check if the problem has been resolved.
- It takes approximately 15 seconds to clean the feeder.

Cleaning the Dust-Proof Glass

961F-01H

When white streaks or other print defects occur even after cleaning the platen glass, feeder, and main unit, the dust-proof glass may be dirty. In this case, follow the procedure below to clean the dust-proof glass.

1 Turn the power OFF, and remove the power plug from the power outlet.

▶Turning OFF the Machine(P. 36)

! IMPORTANT:

- Check the operation status of the machine before turning the power OFF. You can turn the power OFF even if the machine is executing an operation, but this may cause the operation to be interrupted or data to become damaged.

2 Open the front cover of the main unit.

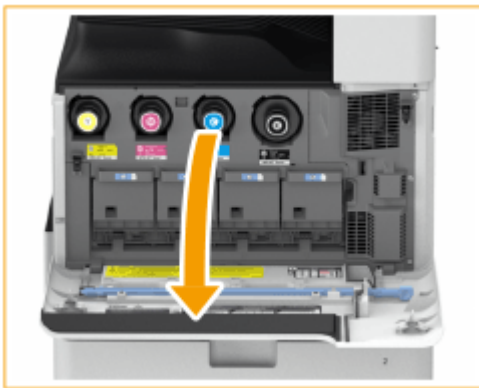

3 Remove the cleaning stick.

- The cleaning stick is stored in the front cover of the main unit.
- Slide the cleaning stick to the right, and then remove it upward.



4 Insert the cleaning stick into the holes to clean them.

- 1 Insert the cleaning stick into the hole with the pad on its tip facing down.

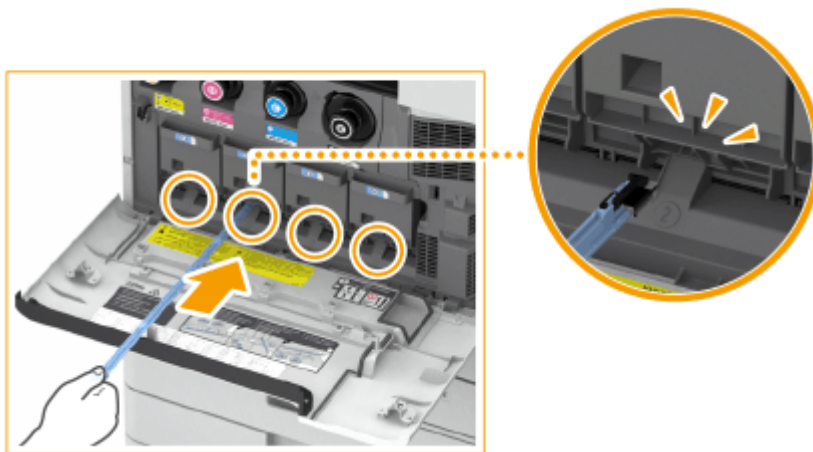

- 2** Insert the cleaning stick in until it hits the bottom of the hole, and gently move it back and forth.
- Insert the cleaning stick into all four holes to clean them.

5 When cleaning is complete, return the cleaning stick to its original position.

- Return the cleaning stick to the front cover of the main unit with its tip on the left side.

6 Close the front cover of the main unit.

7 Insert the power plug into the power outlet, and turn the power ON.

- ▶ Turning ON the Machine(P. 35)

Replacing the Toner Cartridge

961F-01J

When toner starts running low or has run out, a message is displayed prompting you to prepare a new toner cartridge or perform toner cartridge replacement. Prepare a new toner cartridge or perform toner cartridge replacement according to the displayed message.

! IMPORTANT

- Do not replace toner cartridges until the message prompting you to do so appears.

NOTE

- For details about each message, see [▶Countermeasures for Each Message\(P. 1425\)](#) .
- For information on the product numbers for toner cartridges, see [▶Replacement Parts\(P. 123\)](#) .
- You can check the current amount of toner remaining. [▶Checking the Remaining Toner Level\(P. 128\)](#)

Procedure for Replacing the Toner Cartridge

! IMPORTANT

- Do not touch the electrical contacts on the end of the toner cartridge.

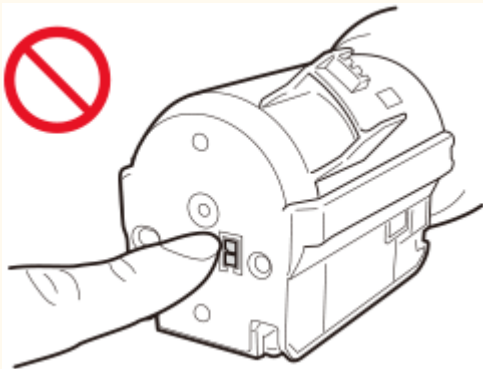

- When replacing multiple toner cartridges at the same time, replace them in the order black, yellow, magenta, cyan.

1 Press .

- This operation is not necessary when black toner or all the toners have run out.

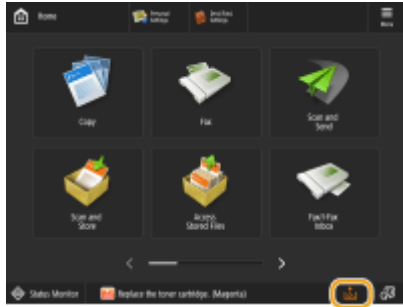

2 Open the front cover of the main unit.

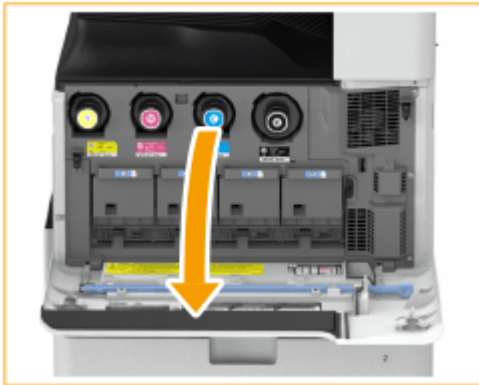

3 Pull out the toner cartridge.

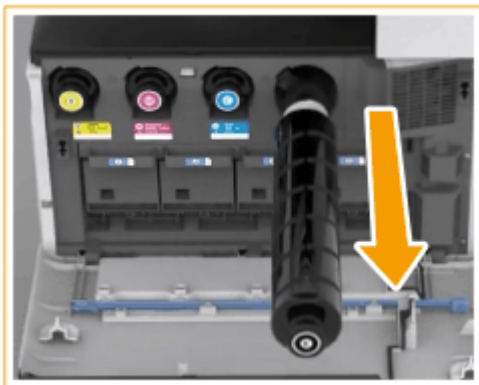

! IMPORTANT

- Make sure to avoid applying shocks to the toner cartridge by hitting it against something, etc. Doing so may cause the toner to leak.

4 Remove the new toner cartridge from its box.



5 With the white part of the new toner cartridge facing up, shake the toner cartridge up and down approximately 10 times.

- Shaking the toner cartridge evens out the toner inside.

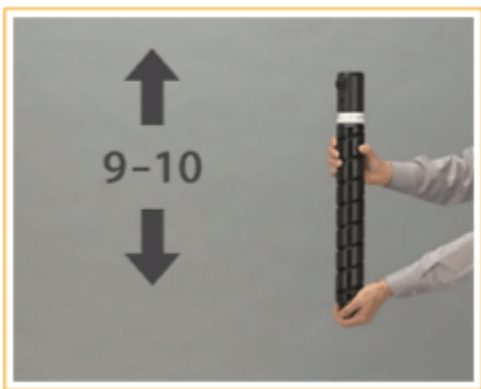

! IMPORTANT:

- Do not have the white part of the toner cartridge face down. Doing so may prevent the toner from being supplied properly.



6 Install the new toner cartridge.

- Holding the toner cartridge with the flat surface of its tip facing down, slide the cartridge into the main unit as far as it will go.



7 Close the front cover of the main unit.

NOTE

- If printing was interrupted because toner ran out, it will automatically resume when you replace the toner cartridge.
- Even if cyan, magenta, or yellow toner runs out, you can continue to print in black-and-white as long as black toner remains, but the printing quality will drop. If you want to continue printing in black-and-white, do not replace the toner cartridge until printing is complete.
- If the gradation and density of printing differ after replacing the toner cartridge, perform adjustment.
 - ▶ **Adjusting Gradation(P. 1378)**
 - ▶ **Adjusting Density(P. 1381)**

Replacing the Waste Toner Container

961F-01K

When the waste toner container is almost full or completely full, a message is displayed prompting you to prepare a new waste toner container or perform waste toner container replacement. Prepare a new waste toner container or perform waste toner container replacement according to the displayed message.

! IMPORTANT

- Do not replace the waste toner container before the message prompting you to replace it appears on the touch panel display.

NOTE

- The waste toner container is a container for collecting unused toner that remains when printing.
- For details about each message, see [Countermeasures for Each Message\(P. 1425\)](#) .
- For information on the model number of the waste toner container, see [Replacement Parts\(P. 123\)](#) .
- You can check the current amount of space remaining in the waste toner container.
 - [Checking the Space Remaining in the Waste Toner Container\(P. 128\)](#)

Procedure for Replacing the Waste Toner Container

1 Open the waste toner cover.

- Hold the left edge of the cover when opening it.



2 Pull out the waste toner container.

- After pulling out the waste toner container half way, hold the handle on the top and pull it out all the way.



! IMPORTANT:

- Do not tilt the waste toner container. Doing so may cause the toner in the container to spill.

3 Remove the new waste toner container from its box.



4 Place the waste toner container you removed into a box.

- Use the bag included in the box for the new waste toner container. Tightly twist the opening of the bag so that the toner does not spill out, and then place the bag in the box.



5 Install the new waste toner container.

- Insert the waste toner container with the Canon logo on top of the container towards the back of the machine, and push it in to load it.



! IMPORTANT:

- Push the waste toner container in as far as it will go. If the waste toner container is not installed correctly, the container shutter may stay open when the waste toner container is removed, which may cause toner to scatter.

6 Close the waster toner cover.

! IMPORTANT

- Used toner cannot be reused. Do not mix new and used toner together.
- The used waste toner container will be collected by your local authorized Canon dealer.

Replenishing the Staples OP

961F-01L

When the staples in the finisher have run out, an icon prompting you to replenish the staples is displayed on the bottom right of the screen. Press the icon, and follow the on-screen instructions to replace the staple cases.

▶ **Replenishing the Staples for the Staple Finisher and Booklet Finisher(P. 107)**

▶ **Replenishing the Staples for the Inner Finisher(P. 112)**

IMPORTANT

- Copies and prints may be output to optional equipment while you are replacing the staple. Take care when handling the optional equipment installed to the machine.

NOTE

- For the product number of the staple case, see ▶ **Replacement Parts(P. 123)** .
- You can check the current amount of staples remaining.
 - ▶ **Checking the Remaining Amount of Staples and Saddle Stitch Staples(P. 128)**

Replenishing the Staples for the Staple Finisher and Booklet Finisher

961F-01R

- ▶ Replacing the Staple Cases in the Stapler Unit(P. 107)
- ▶ Replacing the Staple Cases in the Saddle Stitch Unit(P. 109)

Replacing the Staple Cases in the Stapler Unit

1 Open the front cover of the finisher.

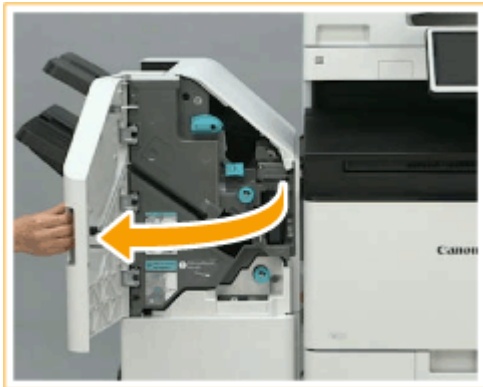

2 Pull out the staple cartridge.

- Hold the green tab on the staple cartridge and pull the cartridge straight out.

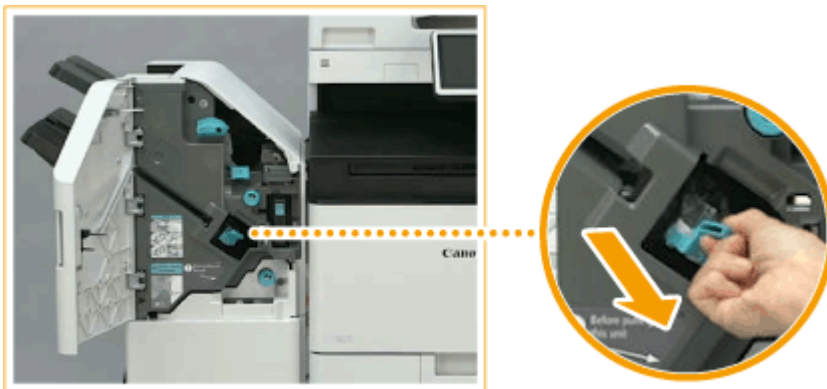

3 Remove the empty staple case from the staple cartridge.

- Hold the staple case around the position of the arrow mark, and remove it in the direction of the arrow.

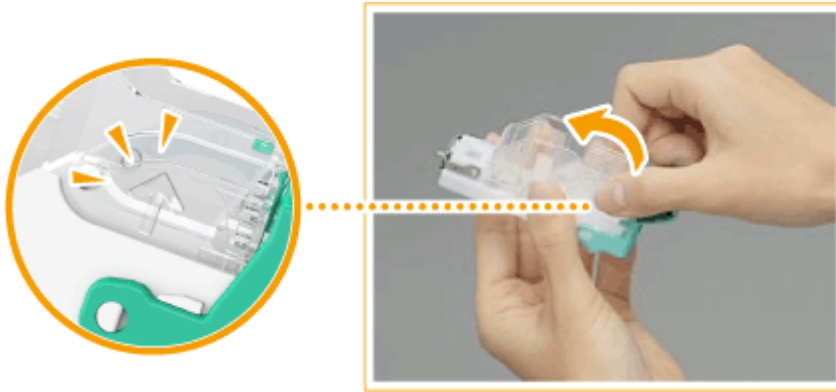

4 Take out a new staple case from its box.



5 Load the new staple case in the staple cartridge.

- Insert the plate protruding from the staple case front end into the staple cartridge, and lower the staple case to place it in the staple cartridge.

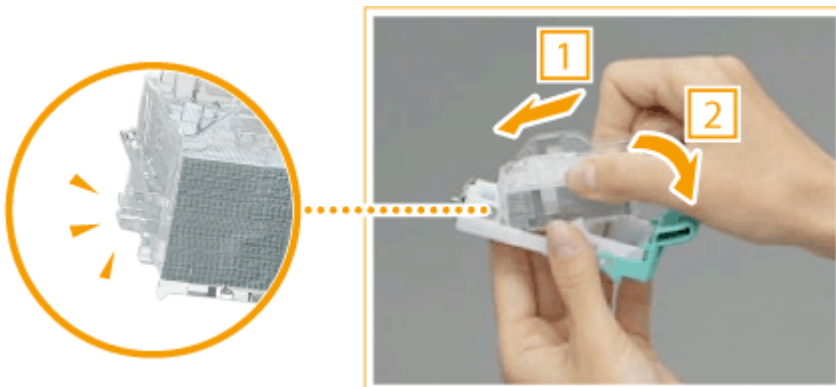

6 Hold the green tab on the staple cartridge and push in the cartridge as far as it will go.



7 Close the front cover of the finisher.

- Dry stapling may be performed automatically for staple repositioning.

Replacing the Staple Cases in the Saddle Stitch Unit

NOTE

Confirm before handling

- If there is any paper in the booklet tray, remove it.

1 Open the front cover of the finisher.



2 Pull out the saddle stitcher unit.



3 Remove the (two) staple cases while pulling down the lever towards yourself.



4 Remove the empty staple case.

- While holding both sides of the top of the empty staple case, lift up the staple case to remove it.



5 Take out a new staple case from its box.

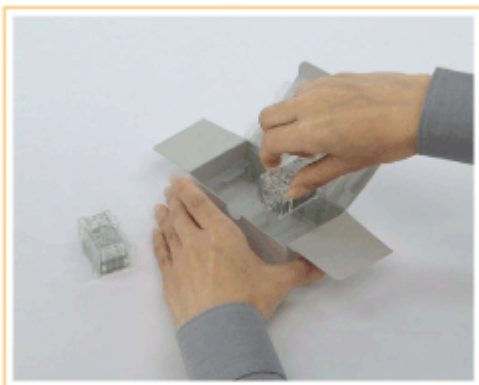

6 Load the new staple case in the staple cartridge.

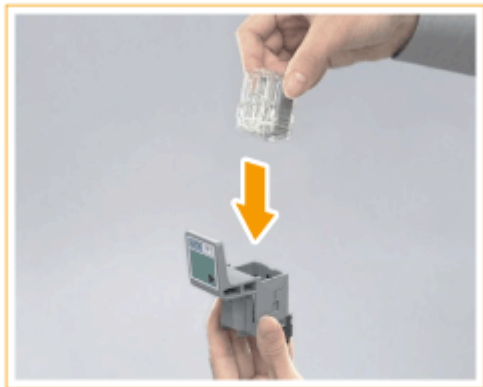

7 Install the (two) staple cases in the saddle stitch unit.



- Push them in as far as they will go.

8 Push in the saddle stitcher unit, and close the front cover of the finisher.

NOTE:

- If stapling dose not work after staples are replenished, perform staple repositioning manually. ▶<Saddle Stitch Staple Repositioning>(P. 1151)

Replenishing the Staples for the Inner Finisher

961F-01S

1 Open the front cover of the finisher.



2 Pull out the staple cartridge.

- Pull the green tab to disengage the lock, and lift the case slightly upwards while pulling it straight out.



3 Remove the empty staple case from the staple cartridge.

- Hold the staple case around the position of the arrow mark, and remove it in the direction of the arrow.

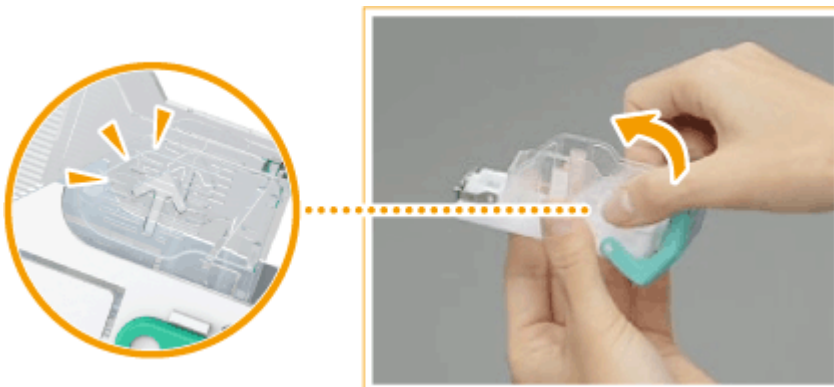

4 Take out a new staple case from its box.



5 Load the new staple case in the staple cartridge.

- Insert the plate protruding from the staple case front end into the staple cartridge, and lower the staple case to place it in the staple cartridge.

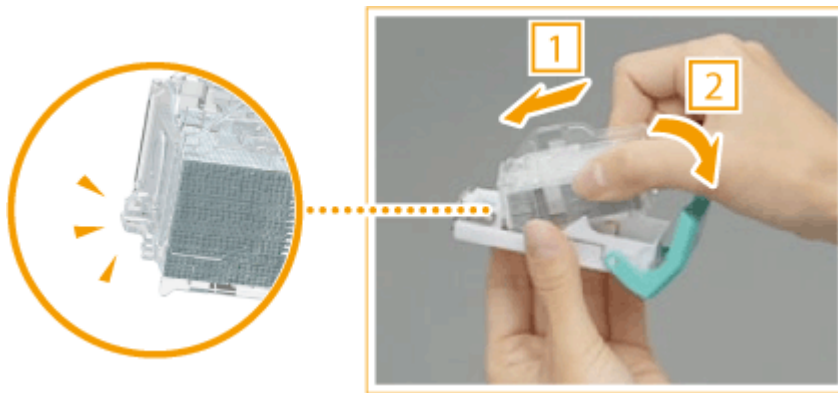

6 Hold the green tab on the staple cartridge and push in the cartridge as far as it will go.



7 Close the front cover of the finisher.

- Dry stapling may be performed automatically for staple repositioning.

Replacing the Drum Unit

961F-01U

When the drum unit is nearing the end of its lifetime, a message prompting you to replace the drum unit is displayed at the bottom of the screen. Press the icon at the right bottom of the screen, and follow the on-screen instructions to replace the drum unit.

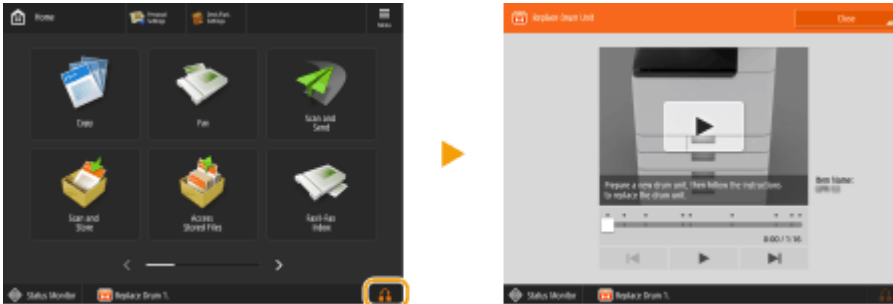

▶ Procedure for Replacing the Drum Unit(P. 114)

! IMPORTANT

- Store drum units in a location away from light sources such as direct sunlight.
- Storing the drum unit in a room that is cold but rapidly heated, or has other rapid temperature changes, causes water droplets (condensation) to form inside it.
- Do not remove the orange-colored protective cover until you are instructed to do so in the following procedure.

NOTE

- For the model number of the drum unit, see ▶ **Replacement Parts(P. 123)** .
- The drum unit replacement message displayed at the bottom of the screen differs depending on your contract.
- Press <Close> when you are finished with drum unit replacement.

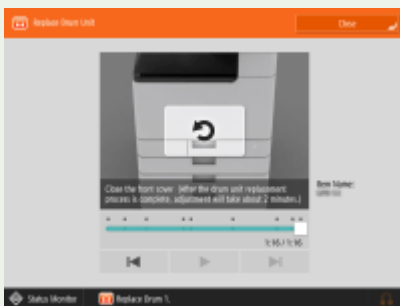

Procedure for Replacing the Drum Unit

- 1 **Open the front cover of the main unit.**

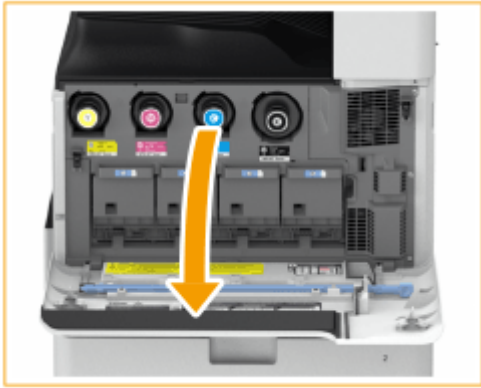

2 Open the cover of the drum unit.

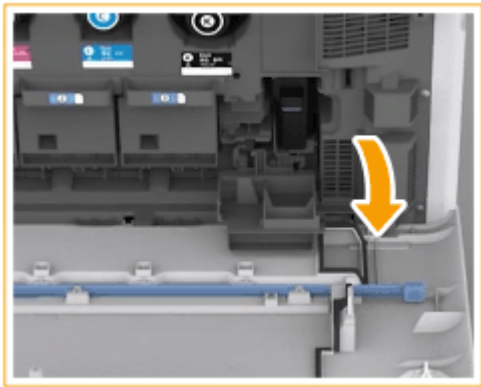

3 Pull out the drum unit.

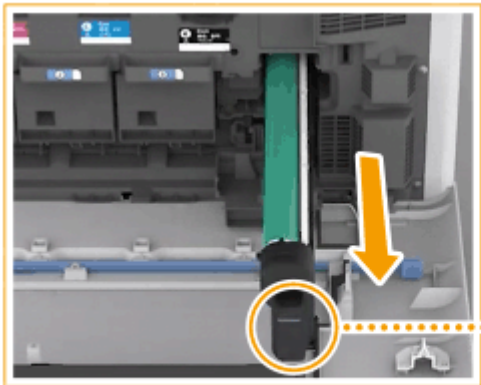

! IMPORTANT:

- Pull out the drum unit while supporting it with your hands as indicated in the diagram.
- Do not tilt the drum unit. Doing so may cause the toner in the drum to spill.

4 Remove the new drum unit from its box.

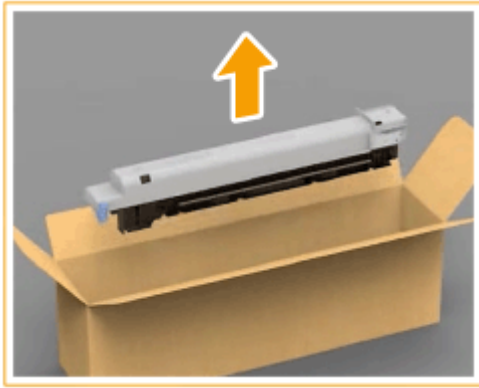

5 Install the new drum unit.

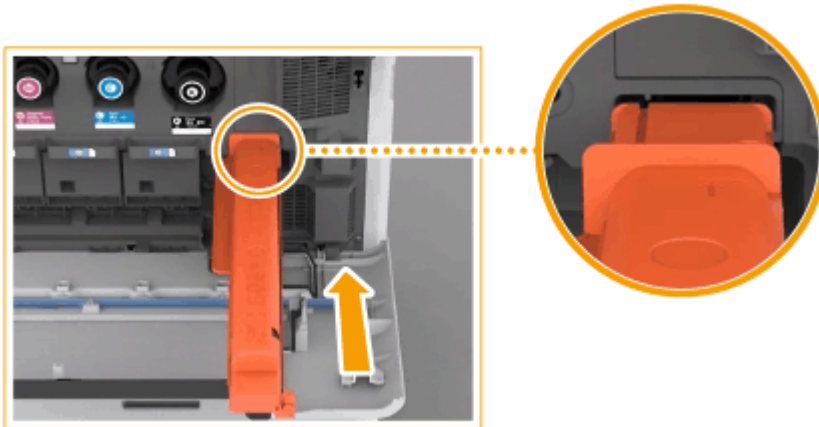

6 Remove the protective cover.

- First push in the slider on the right side of the gray protective cover toward the back of the main unit until it cannot go any further, and then pull out the protective cover.

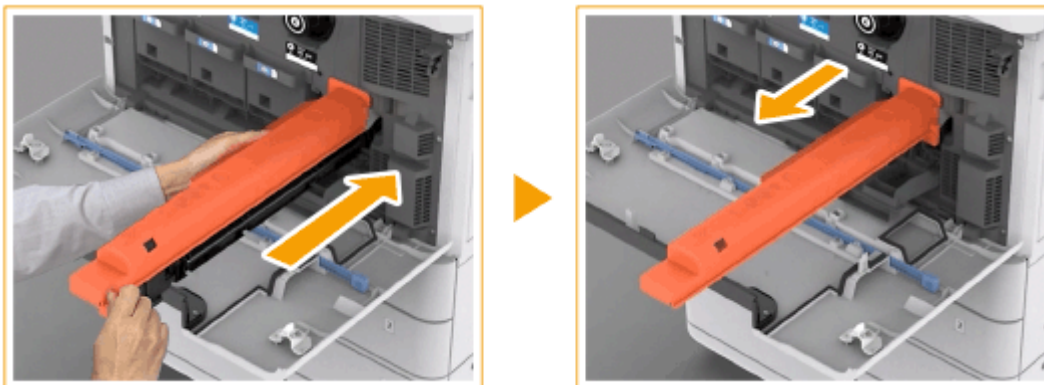

! IMPORTANT:

- After removing the protective cover, check that the drum unit is pushed fully into the main unit. Failing to push the drum unit in fully will cause a malfunction.

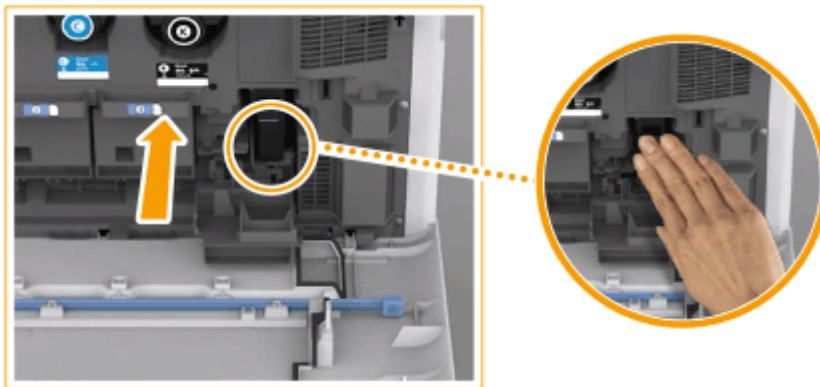

7 Close the cover of the drum unit.

8 Close the front cover of the main unit.

9 Perform the full adjustment by pressing <Full Adjust> in <Auto Adjust Gradation>.

- For information on the full adjustment, see [▶Full Adjustment\(P. 1378\)](#) .

! IMPORTANT

- After the replacement is complete, put the used drum unit in the bag that contained the new drum unit, and store it until the local authorized Canon dealer comes to collect it.

Emptying the Punch Waste OP

961F-01W

When the punch waste in the finisher is full, an icon is displayed on the bottom right of the screen. Press the icon and follow the instructions on the screen to empty the punch waste.

▶ **Emptying the Punch Waste in the Staple Finisher and Booklet Finisher(P. 119)**

▶ **Emptying the Punch Waste in the Inner Finisher(P. 121)**

IMPORTANT

- Copies and prints may be output to optional equipment while you are emptying the punch waste. Take care when handling the optional equipment installed to the machine.

Emptying the Punch Waste in the Staple Finisher and Booklet Finisher

961F-01X

1 Open the front cover of the finisher.

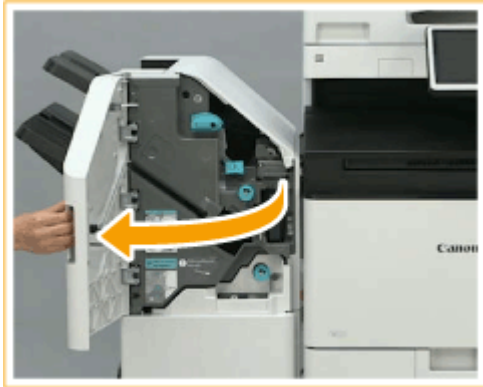

2 Pull out the punch waste tray.

- Hold the handle, and gently pull out the tray towards yourself.
- After pulling out the punch waste tray half way, place your hand underneath it and pull it out all the way.



3 Empty the punch waste.



4 Return the punch waste tray to its original position.



- Push the punch waste tray in as far as it will go.

5 Close the front cover of the finisher.

Emptying the Punch Waste in the Inner Finisher

961F-01Y

- 1 Open the right cover of the finisher.



- 2 Pull out the punch waste tray.

- Hold the handle, and gently pull out the tray towards yourself.
- After pulling out the punch waste tray half way, place your hand underneath it and pull it out all the way.

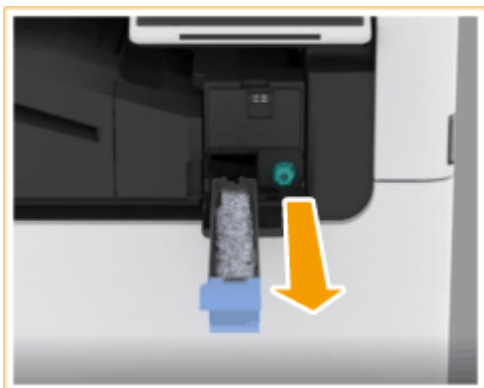

- 3 Empty the punch waste.



- 4 Return the punch waste tray to its original position.



- Push the punch waste tray in as far as it will go.

5 Close the right cover of the finisher.

Replacement Parts

961F-0YX

This section describes the replacement parts (consumables/consumable parts) used by the machine. Purchase the replacement parts from the authorized Canon dealer that you purchased the machine from. Follow the precautions when handling and storing the replacement parts.

Genuine Consumables

Canon continuously develops technology innovations in Canon manufactured Toner, Toner cartridge, and Parts, specifically designed for use in Canon Multi-Functional machines.

Experience the benefits of optimal print performance, print volume and high quality outputs, achieved through Canon's new advanced technologies.

Therefore, the use of Canon genuine consumables is recommended for your Canon Multi-Functional machines.



▶ **Consumables(P. 123)**

▶ **Consumable Parts(P. 126)**

NOTE

- For information on handling and storing the replacement parts, follow the precautions indicated in the Important Safety Instructions included with the machine.
- You can check the current amount of replaceable parts remaining.
 - ▶ **Checking the Remaining Amount of Consumables(P. 128)**

Consumables

■ Toner Cartridge for Replacement



Confirm that the code on the front cover of the machine and the one on the package of the genuine toner are the same.

Model name	Genuine Canon toner
imageRUNNER ADVANCE DX C3935i / C3930i / C3926i / C3922i	<ul style="list-style-type: none"> • Canon C-EXV 64 Toner Black • Canon C-EXV 64 Toner Cyan • Canon C-EXV 64 Toner Magenta • Canon C-EXV 64 Toner Yellow



Store toner cartridge as described below

- Store toner cartridge in the following conditions:
 - Storage temperature range: 10 to 30°C

CAUTION

- Storage humidity range: 20% to 80% RH (relative humidity, condensation-free)*

* Even within the approved storage humidity range, water droplets (condensation) may develop inside the toner container if the temperatures inside and outside the toner container differ. Condensation will adversely affect the print quality.

- Store unopened until immediately prior to use.
- When storing toner cartridge, do not store them upright or upside down.
- Do not store toner cartridge in the following locations:
 - Locations exposed to open flames
 - Locations exposed to direct sunlight
 - Locations exposed to excessively salty air
 - Locations heavily exposed to corrosive gases (e.g. aerosol sprays or ammonia)
 - Very hot and/or humid locations
 - Locations subject to dramatic changes in temperature and humidity likely to cause condensation
 - Very dusty locations
 - Locations within the reach of children
 - Locations close to products that emit magnetism

IMPORTANT

Be careful of counterfeit toners

- Please be aware that there are counterfeit Canon toners in the marketplace. Use of counterfeit toner may result in poor print quality or machine performance. Canon is not responsible for any malfunction, accident or damage caused by the use of counterfeit toner.
For more information, see global.canon/ctc.

NOTE

- For information on the collection of used toner cartridges, see the Important Safety Instructions.

■ Drum Unit

Product Name	Model Number
imageRUNNER ADVANCE DX C3935i / C3930i / C3926i / C3922i	• Canon C-EXV 49 Drum Unit

CAUTION

Store drum unit as described below

- Storing drum unit in an improper location or environment may cause problems such as data loss.
 - Storage temperature range: 10 to 30°C
 - Storage humidity range: 20% to 80% RH (relative humidity, condensation-free)*

CAUTION

* Even within the approved storage humidity range, water droplets (condensation) may develop inside the drum cartridge if the temperatures inside and outside the drum cartridge differ. Condensation will adversely affect the print quality.

- Store unopened until immediately prior to use.
- Store the packaging material safely for future use. It will be needed for situations such as storing the machine with the drum cartridge removed.
- Do not store drum unit upright or upside down.
- Do not store drum unit in the following locations:
 - Locations exposed to open flames
 - Locations exposed to direct sunlight or bright light for five minutes or more
 - Locations heavily exposed to corrosive gases (e.g. aerosol sprays or ammonia)
 - Very hot and/or humid locations
 - Locations subject to dramatic changes in temperature and humidity likely to cause condensation
 - Very dusty locations
 - Locations within the reach of children
 - Locations close to products affected by magnetism (e.g. floppy disks or disk drives)
 - Locations close to products that emit magnetis

■ Staple Cases for Replacement

Always use the dedicated replacement staple cases for this machine. Note that the model number of the staples to use differs according to the finisher.

Finisher name	Genuine Canon staple case
Staple Finisher-AE Booklet Finisher-AE Inner Finisher-L	 <ul style="list-style-type: none"> • Staple-P1

Finisher name	Genuine Canon staple case
Booklet Finisher-AE	 <ul style="list-style-type: none"> • Staple Cartridge-Y1

Consumable Parts

■ Waste Toner Container

Make sure to use the dedicated waste toner container for this machine.



- WT-202

■ Fixing Assembly

Follow the instructions provided to your dealer or service representative.

- FX-503



■ Secondary Transfer Outer Roller

Follow the instructions provided to your local authorized Canon dealer.

- TR-501



■ ITB Unit

Follow the instructions provided to your local authorized Canon dealer.

- TB-501



■ ADF Maintenance Kit (for 2-Sided Double Pass Feeder (DADF-BA))

Follow the instructions provided to your dealer or service representative.

- DR-202



■ ADF Maintenance Kit (for 2-Sided Single Pass Feeder (Single Pass DADF-C))

Follow the instructions provided to your dealer or service representative.

- DR-205



Checking the Remaining Amount of Consumables

961F-021

When you press  (Status Monitor), the Status Monitor screen is displayed, allowing you to check the toner level or other status indications.

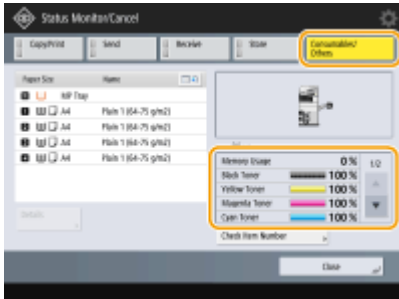

- ▶ **Checking the Remaining Toner Level(P. 128)**
- ▶ **Checking the Space Remaining in the Waste Toner Container(P. 128)**
- ▶ **Checking the Remaining Amount of Staples and Saddle Stitch Staples(P. 128)**
- ▶ **Checking the Amount of Punch Waste(P. 129)**
- ▶ **Checking the Detailed Status of Consumables(P. 129)**

TIPS

- You can check the remaining amount of consumables from the Remote UI. ▶ **Checking the Machine Status(P. 909)**

Checking the Remaining Toner Level

It is recommended that you check the remaining toner level before printing a large job to determine whether or not to prepare a new toner cartridge.



Press  (Status Monitor) ▶ <Consumables/Others> ▶ check the remaining toner level.

Checking the Space Remaining in the Waste Toner Container

It is recommended that you check the space remaining in the waste toner container before performing a large job to determine whether or not to prepare a new waste toner container.



Press  (Status Monitor) ▶ <Consumables/Others> ▶ checking the space remaining in the waste toner container.

Checking the Remaining Amount of Staples and Saddle Stitch Staples

It is recommended that you check the remaining amount of staples and saddle stitch staples before, especially beginning an operation to make a large number of booklets to determine whether you need to prepare a new staple case.



Press (Status Monitor) ▶ <Consumables/Others> ▶ check <Remaining Staples> and <Saddle Staples>.

Checking the Amount of Punch Waste

Check whether the punch waste is full, especially before punching a large number of holes.



Press (Status Monitor) ▶ <Consumables/Others> ▶ <Punch Waste> / <Puncher Unit Waste>

Checking the Detailed Status of Consumables

Check the detailed status of consumables.



Press (Status Monitor) ▶ <Consumables/Others> ▶ <Check Consumables>.

■ <Toner/Waste Toner> Screen

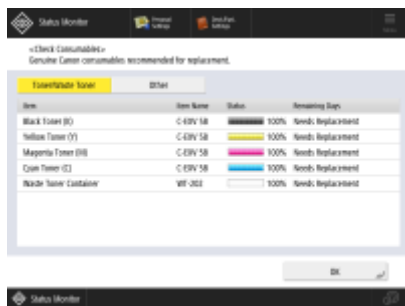

<Item>, <Item Name>, <Status>, and <Remaining Days> are displayed.

■ <Other> Screen

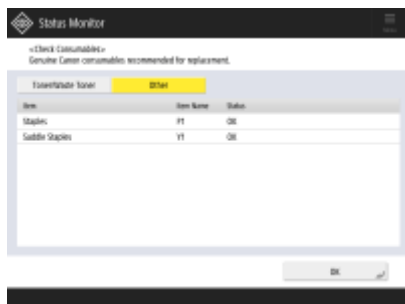

<Item>, <Item Name>, and <Status> are displayed.

NOTE

- <Remaining Days> displays the expected number of days remaining until replacement is required, based on past usage.
- Even if <Needs Replacement> is displayed in <Remaining Days>, do not perform replacement until a message prompting you to replace consumables is displayed in the status display area (at the bottom of the touch panel display).
- The measurement for <Remaining Days> does not complete for a while after the machine starts operation, and <1 year or more> is displayed during this time. The remaining days displayed after this time may be extremely small temporarily.

LINKS

- ▶ **Replacing the Toner Cartridge(P. 99)**
- ▶ **Replacing the Waste Toner Container(P. 103)**
- ▶ **Replenishing the Staples (Optional)(P. 106)**
- ▶ **Emptying the Punch Waste (Optional)(P. 118)**
- ▶ **Countermeasures for Each Message(P. 1425)**

Clearing Paper Jams

961F-022

If a paper jam occurs, a message, the location of the paper jam, and the procedure for clearing it are displayed on the screen. If you do not know how to clear the paper jam from viewing the screen, see **Paper Jam Locations(P. 132)** to clear the paper jam. For information on cautions when clearing paper jams, see the "Important Safety Instructions" included with the machine and **Optional Equipment(P. 173)** .

CAUTION

- Do not forcibly remove the jammed paper from the machine. Forcibly removing the paper may result in personal injury or damage parts of the machine.
 - If you cannot remove the paper, contact your dealer or service representative.
- When all paper jams have been cleared, immediately remove your hands from the machine and optional equipment so that your clothing and hands do not get caught in the rollers.

IMPORTANT

Cautions when clearing paper jams

- When clearing paper jams, do not turn the power OFF. Data being printed is erased when you turn the power OFF.
 - Take particular care when a fax is being received.
- When the paper gets torn, be sure to remove it so that no pieces remain.
- Copies and prints may be output to optional equipment while you are clearing paper jams. Take care when handling optional equipment that is installed.

■ If Paper Jams Frequently Occur

If paper jams frequently occur even though there are no problems with the machine and its optional equipment, check the following.

Are the paper guides misaligned?

- Match the paper guides with the paper loaded in the paper source.

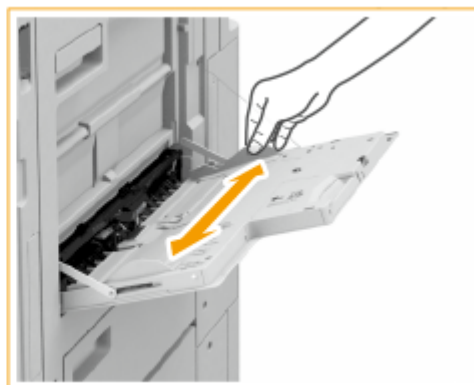

Do sheets of paper overlap when being fed?

- If paper jams occur due to overlapping of sheets of paper when being fed, reload the paper by changing the orientation.

Is the paper type correct?

- On the <Status Monitor> screen, check the paper type. ▶<Status Monitor> Screen(P. 333)
- If the paper loaded in a paper source differs from the paper type setting, see ▶Loading Paper(P. 46) to set the paper type again.
- If you use heavy paper or coated paper by loading it in the multi-purpose tray, paper jams may occur due to the grain direction. In this case, changing the paper orientation (portrait/landscape) may prevent paper jamming.

Do pieces of paper remain in the machine?

- Pieces of paper may remain in the machine after removing a paper jam. Open the location where the paper was jammed, and remove any pieces of paper. (Do not forcibly remove the jammed paper from the machine. Forcibly removing the paper may result in personal injury or damage parts of the machine. If you cannot remove the paper, contact your dealer or service representative.)

Paper Jam Locations

For information on the paper jam locations and the method for clearing paper jams, see the following diagram and references.



- 1 Feeder ▶Paper Jams in the Feeder(P. 134)
- 2 Inside the main unit ▶Paper Jams in the Main Unit(P. 140)
- 3 Paper drawer ▶Paper Jams in a Paper Source(P. 145)
- 4 Staple finisher ▶Paper Jams in the Staple Finisher(P. 150)
Booklet finisher ▶Paper Jams in the Booklet Finisher(P. 153)
- 5 Inner Finisher ▶Paper Jams in the Inner Finisher(P. 157)

NOTE

- Paper may not actually be jammed in the location you check. Even in this case, follow the instructions on the screen to check all the locations.
- The screen indicating that there is a paper jam is repeatedly displayed until you clear the paper jam.
- If you press <Close> on the screen indicating that there is a paper jam, you may be able to continue to perform operations and specify settings without immediately removing the paper jam.
- Do not remove paper from a location other than that displayed as a paper jam location on the screen. This may cause paper jams in other locations or missing pages in output documents.

Paper Jams in the Feeder

961F-0YY

Check the paper jam location on the screen, and follow the procedure below to remove the original.

- ▶ When the 2-Sided Single Pass Feeder (Single Pass DADF-C) is attached (P. 134)
- ▶ When the 2-Sided Double Pass Feeder (DADF-BA) is attached (P. 136)

When the 2-Sided Single Pass Feeder (Single Pass DADF-C) is attached

The Single Pass DADF-C is an optional product.

1 Remove the originals in the original supply tray.



2 Check whether an original is jammed in the feeder cover.

1 Pull the lever to open the cover.



2 Remove the original.



- 3** If an original is jammed, gently pull it out in the direction of the arrow.



- If you cannot remove the jammed original, proceed to the next step without forcibly removing it.

3 Check whether an original is jammed in the original output tray.

- 1** Turn the green knob counterclockwise.



- 2** If an original is jammed, gently pull it out in the direction of the arrow.



4 After removing all jammed originals, close the feeder cover.

5 Lift up the feeder. If an original is jammed, remove it.

1 Lift up the feeder.



2 If an original is jammed, gently pull it out in the direction of the arrow.



6 Return the feeder to its original position.

- Continue following the instructions on the screen to proceed with the interrupted operation or continue clearing paper jams.

CAUTION

- When closing the feeder, take care that your eyes are not exposed to light emitted through the platen glass.

When the 2-Sided Double Pass Feeder (DADF-BA) is attached

The DADF-BA is an optional product.

1 Remove any originals from the original supply tray.



2 Check whether an original is jammed in the feeder cover.

- 1** Pull the lever to open the feeder cover.



- 2** If an original is jammed, gently pull it out in the direction of the arrow.



3 Check whether an original is jammed in the original output tray.

- 1** Turn the green knob counterclockwise.



- 2 If an original is jammed, gently pull it out in the direction of the arrow.



4 Check whether an original is jammed inside the inner cover of the feeder.

- 1 Open the inner cover of the feeder.



- 2 If an original is jammed, gently pull it out in the direction of the arrow.



- 3 Close the inner cover of the feeder.

5 After removing all jammed originals, close the feeder cover.

6 Lift up the feeder, and check whether there is a jammed original.

1 Lift up the feeder, and check the position indicated by **a**.



2 If an original is jammed, gently pull it out in the direction of the arrow.



7 Return the feeder to its original position.

- Continue following the instructions on the screen to proceed with the interrupted operation or continue clearing paper jams.



CAUTION

- When closing the feeder, take care that your eyes are not exposed to light emitted through the platen glass.

Paper Jams in the Main Unit

961F-024

Check the paper jam location on the screen, and follow the procedure below to remove the paper.

NOTE

Confirm before handling

- Before starting the operation to clear paper jams, confirm that the covers and paper drawers of the machine and optional equipment are closed.

1 Open the right cover of the main unit.

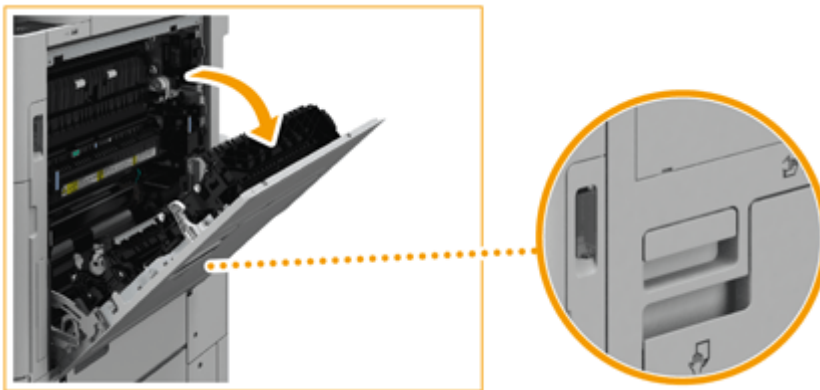

! IMPORTANT:

When Opening the Right Cover of the Main Unit

- Touching the inside of the main unit with an electrostatic charge on your hands may damage the components. Before performing work such as replacing parts or removing paper jams inside the main unit, grip the handle securely and open the right cover of the main unit. A metal plate located behind the handle discharges any static electricity.
- If you interrupt work such as replacing parts or removing paper jams inside the main unit, close the right cover of the main unit. When resuming work, grip the handle securely and open the right cover of the main unit. This ensures that any static electricity on your hands is discharged.

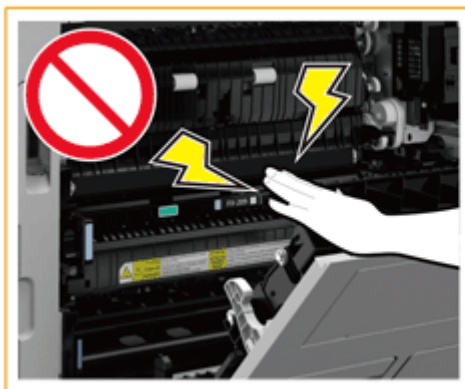

2 Check whether paper is jammed in the output tray of the main unit.

- If paper is jammed, gently pull it out in the direction of the arrow.



3 Check whether paper is jammed in the output area or reversing unit.

- If paper is jammed, gently pull it out in the direction of the arrow.



4 Check whether paper is jammed in the fixing assembly.

- 1 Open the upper cover of the fixing assembly.

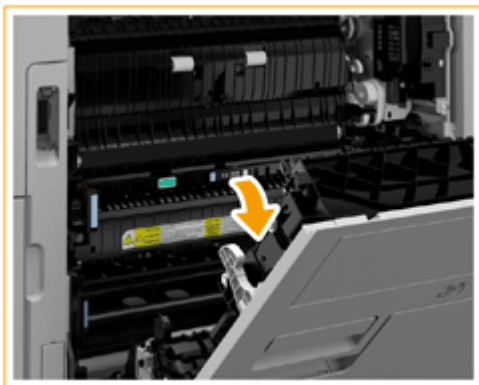

- 2 If paper is jammed, gently pull it out in the direction of the arrow.



NOTE:

- If you cannot remove the paper via the top side of the fixing assembly, gently pull it out via the bottom side of the assembly.



3 Return the upper cover of the fixing assembly back to position.

5 Check whether paper is jammed in the output area on the side of the main unit's right cover.

- If paper is jammed, gently pull it out in the direction of the arrow.



6 Check whether paper is jammed in the duplexing unit.

1 Lift the handle up in the direction of **1** and open the duplex unit in the direction of **2**.



- 2 If paper is jammed in the upper area of the duplexing unit, gently pull it out in the direction of the arrow.

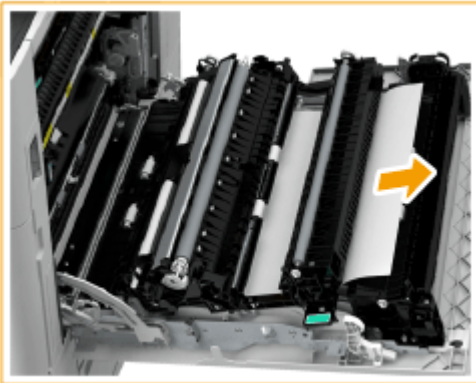

- 3 Return the duplex unit back into position.

- 4 If paper is jammed in the lower area of the duplexing unit, gently pull it out in the direction of the arrow.

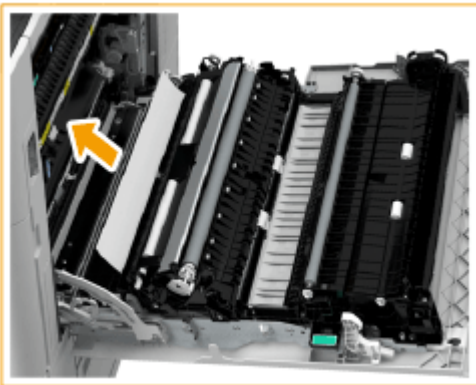

7 Check whether paper is jammed around the paper drawer 1.

- If paper is jammed, gently pull it out in the direction of the arrow.



8 Gently close the right cover of the main unit until they click.

- Continue following the instructions on the screen to proceed with the interrupted operation or continue clearing paper jams.

Paper Jams in a Paper Source

961F-025

Check the paper jam location on the screen, and follow the procedure below to remove the paper.

- ▶ Clearing Paper Jams in Paper Drawers 1(P. 145)
- ▶ Clearing Paper Jams in Paper Drawers 2(P. 145)
- ▶ Clearing Paper Jams in Paper Drawers 3 and 4 (Optional)(P. 147)

NOTE

Confirm before handling

- Before starting the operation to clear paper jams, confirm that the covers and paper drawers of the machine and optional equipment are closed.

Clearing Paper Jams in Paper Drawers 1

1 Check whether paper is jammed in the paper drawer 1.

- 1 Open the paper drawer.
- 2 If paper is jammed, gently pull it out in the direction of the arrow.



- 3 Push the paper drawer in until it clicks.

! IMPORTANT:

- When closing the paper drawer, be careful not to get your fingers caught, as this may result in personal injury.
- Continue following the instructions on the screen to proceed with the interrupted operation or continue clearing paper jams.

Clearing Paper Jams in Paper Drawers 2

1 Check whether paper is jammed in the upper-right cover of the paper drawer.

- 1 Open the upper-right cover of the paper drawer.



- 2 If paper is jammed, gently pull it out in the direction of the arrow.



- 3 Gently close the upper-right cover of the paper drawer until it clicks.

2 Check whether paper is jammed in the paper drawer.

- 1 Open the paper drawer.

- 2 If paper is jammed, gently pull it out in the direction of the arrow.



- 3 Push the paper drawer in until it clicks.

! IMPORTANT:

- When closing the paper drawer, be careful not to get your fingers caught, as this may result in personal injury.
- Continue following the instructions on the screen to proceed with the interrupted operation or continue clearing paper jams.

Clearing Paper Jams in Paper Drawers 3 and 4 OP

1 Check whether paper is jammed in the upper-right cover or lower-right cover of the paper drawer.

- 1 Open the upper-right cover and lower-right cover of the paper drawer.



- 2 If paper is jammed, gently pull it out in the direction of the arrow.



- 3 Gently close the upper-right cover and lower-right cover of the paper drawer until they click.

2 Check whether paper is jammed in the paper drawer.

- 1 Open the paper drawer.
- 2 If paper is jammed, gently pull it out in the direction of the arrow.

When the Cassette Feeding Unit-AW is attached



3 Push the paper drawer in until it clicks.

! IMPORTANT:

- When closing the paper drawer, be careful not to get your fingers caught, as this may result in personal injury.
- Continue following the instructions on the screen to proceed with the interrupted operation or continue clearing paper jams.

Paper Jams in a Finisher OP

961F-026

This section describes the method for clearing paper jams in a finisher. Check the paper jam location on the screen, and follow the procedure in the reference indicated below to remove the paper.

- ▶ **Paper Jams in the Staple Finisher(P. 150)**
- ▶ **Paper Jams in the Booklet Finisher(P. 153)**
- ▶ **Paper Jams in the Inner Finisher(P. 157)**

NOTE

Confirm before handling

- Remove any paper loaded in a tray.
- Before starting the operation to clear paper jams, confirm that the covers and paper drawers of the machine and optional equipment are closed.

Paper Jams in the Staple Finisher

961F-027

1 Check whether paper is jammed in the finisher.

- 1 Open the front cover of the finisher.



- 2 Lift up the output tray paper supporter of the Tray B.

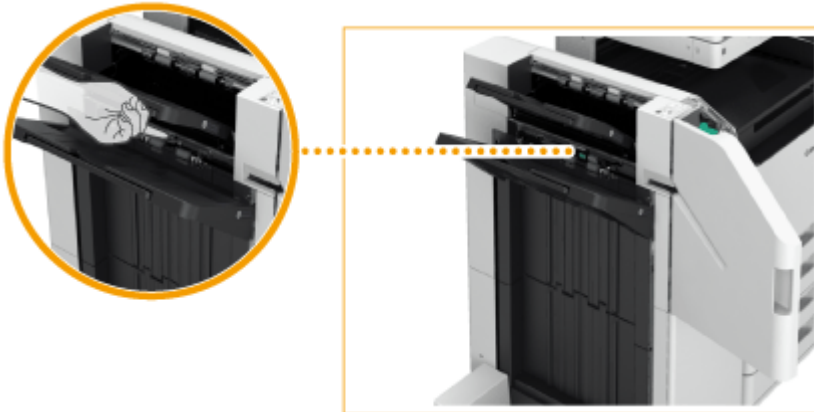

- 3 Turn the green knob to feed the jammed paper to the Tray B side.



- 4 If paper comes out of the outlet of the Tray B, gently pull the paper out in the direction of the arrow.

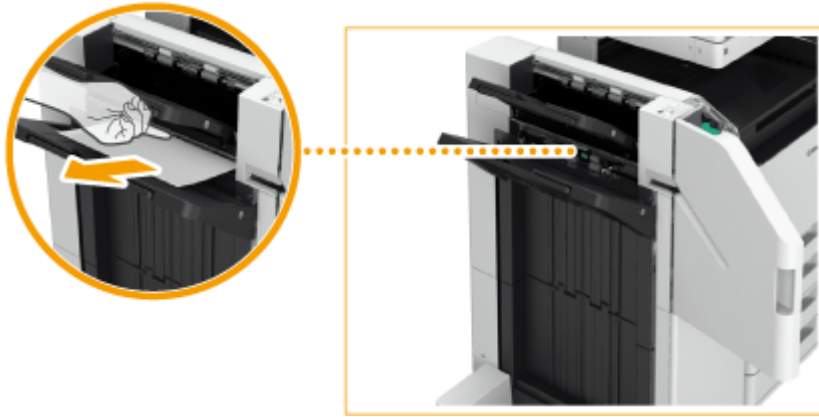

2 Check whether paper is jammed in the delivery unit.

1 Open the escape delivery guide (a).

- If paper is jammed, gently pull it out in the direction of the arrow.



2 Lift up the first flapper (b).

- If paper is jammed, gently pull it out in the direction of the arrow.



3 Return the first flapper (b) to its original position.

4 Return the escape delivery guide (a) to its original position.

3 Close the front cover of the finisher.

4 Open the cover of the buffer pass unit.



5 Check whether paper is jammed.

- If paper is jammed, gently pull it out in the direction of the arrow.



6 Close the cover of the buffer pass unit.

- Continue following the instructions on the screen to proceed with the interrupted operation or continue clearing paper jams.

Paper Jams in the Booklet Finisher

961F-028

NOTE

Confirm before handling

- If there is any paper in the booklet tray, remove it.

1 Check whether paper is jammed in the finisher.

- 1 Open the front cover of the finisher.



- 2 Lift up the output tray paper supporter of the main tray.

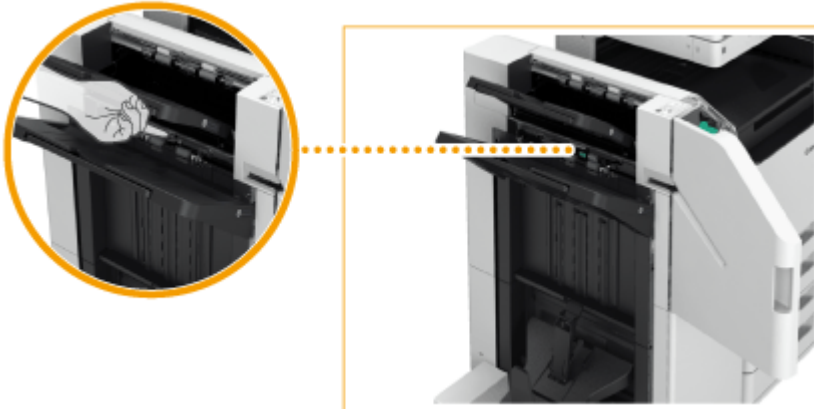

- 3 Turn the green knob to feed the jammed paper to the main tray side.



- 4 If paper comes out of the outlet of the main tray, gently pull the paper out in the direction of the arrow.

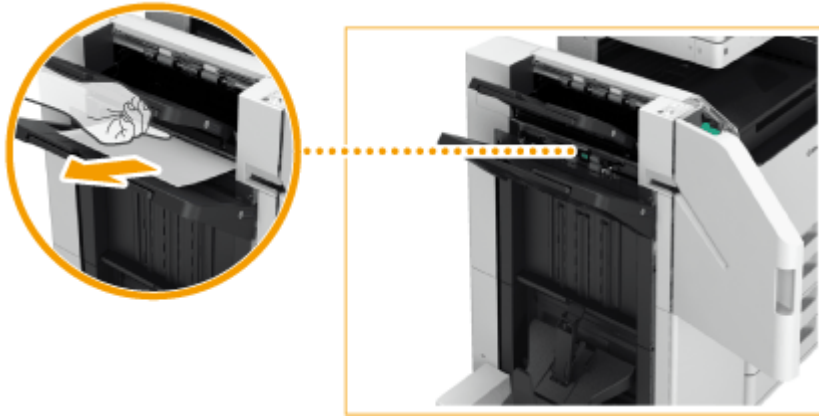

2 Check whether paper is jammed in the delivery unit.

1 Open the escape delivery guide (**a**).

- If paper is jammed, gently pull it out in the direction of the arrow.



2 Lift up the first flapper (**b**).

- If paper is jammed, gently pull it out in the direction of the arrow.



3 Return the first flapper (**b**) to its original position.

4 Return the escape delivery guide (**a**) to its original position.

3 Turn the green knob about 10 times.

- If you do not turn the knob, the jammed paper may tear when the saddle stitcher unit is pulled out.



4 Pull out the saddle stitcher unit.



5 Check whether paper is jammed in the transparent guide.

- 1 Open the transparent guide (**a**).
 - If paper is jammed, gently pull it out in the direction of the arrow.



- 2 Return the transparent guide to its original position.

6 Return the saddle stitcher unit to its original position.

7 Close the front cover of the finisher.

8 Open the cover of the buffer pass unit.



9 Check whether paper is jammed.

- If paper is jammed, gently pull it out in the direction of the arrow.



10 Close the cover of the buffer pass unit.

- Continue following the instructions on the screen to proceed with the interrupted operation or continue clearing paper jams.

Paper Jams in the Inner Finisher

961F-029

- 1 Open the right cover of the main unit.

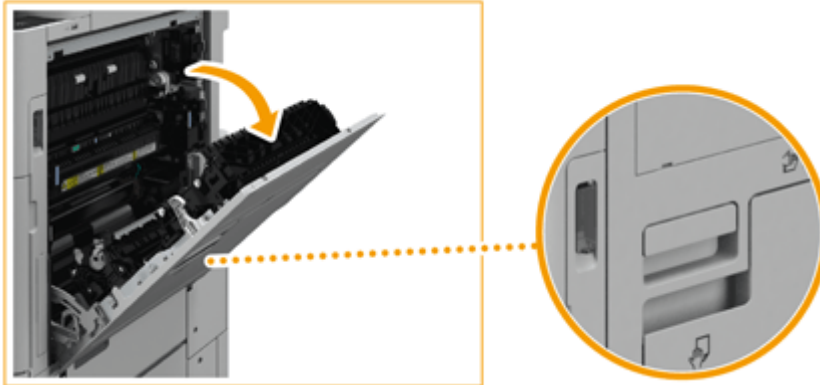

- 2 Check whether paper is jammed in the output area or reversing unit.

- If paper is jammed, gently pull it out in the direction of the arrow.



- 3 Open the left cover of the finisher.

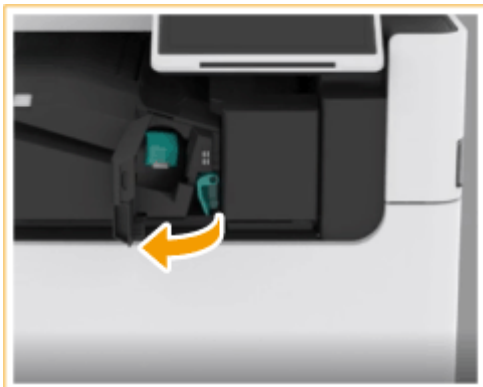

- 4 Hold the lever (a), and slide the inner finisher to the left.

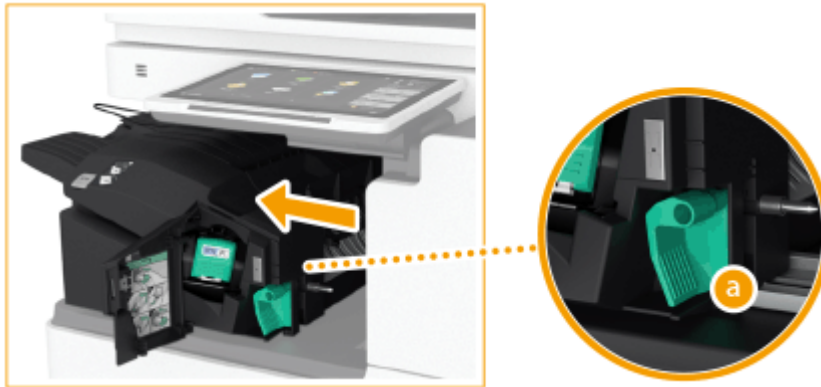

5 Check whether paper is jammed in the inner finisher.

- 1 Lift up the guide at the entrance.

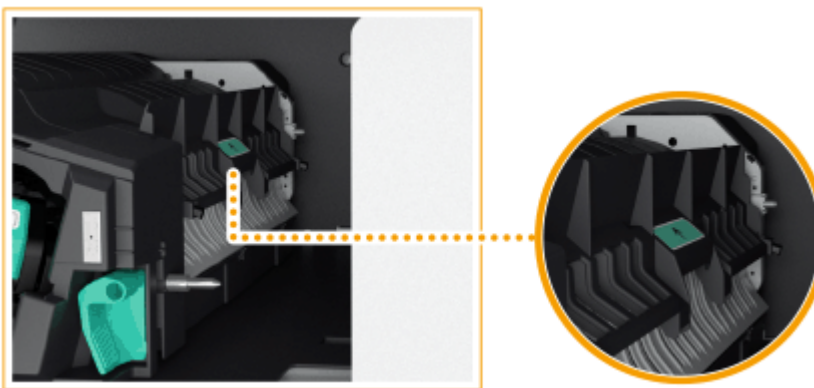

- 2 If paper is jammed, gently pull it out in the direction of the arrow.



- 3 Return the guide to its original position.

When the Puncher Unit is attached:

- 1 Open the front cover of the puncher unit.



- 2** Turn the green knob to feed the jammed paper to the outlet of the puncher unit.



- 3** If paper comes out of the outlet of the puncher unit, gently pull the paper out in the direction of the arrow.



- 4** Close the front cover of the puncher unit.

- 6** Return the inner finisher to its original position.







7 Close the left cover of the finisher.

- Continue following the instructions on the screen to proceed with the interrupted operation or continue clearing paper jams.

Clearing Staple Jams OP

961F-02A

If staple jam occurs, a message, the location of the staple jam, and the procedure for clearing it are displayed on the screen. Check the staple jam location on the screen, and remove the jammed staple by following the procedure described in the reference below. For information on cautions when clearing staple jams, see the "Important Safety Instructions" included with the machine and  **Optional Equipment(P. 173)** .

-  **Staple Jam Has Occurred in the Staple Finisher(P. 162)**
-  **Staple Jam Has Occurred in the Booklet Finisher(P. 164)**
-  **Staple Jam Has Occurred in the Inner Finisher(P. 168)**

IMPORTANT

- Copies and prints may be output to optional equipment while you are clearing staple jams. Take care when handling optional equipment that is installed.

NOTE

Confirm before handling

- Before starting the operation to clear staple jams, confirm that the covers and paper drawers of the machine and optional equipment are closed.

Staple Jam Has Occurred in the Staple Finisher

961F-02C

- 1 Open the front cover of the finisher.



- 2 Pull out the staple cartridge.

- Hold the green tab on the staple cartridge and pull the cartridge straight out.

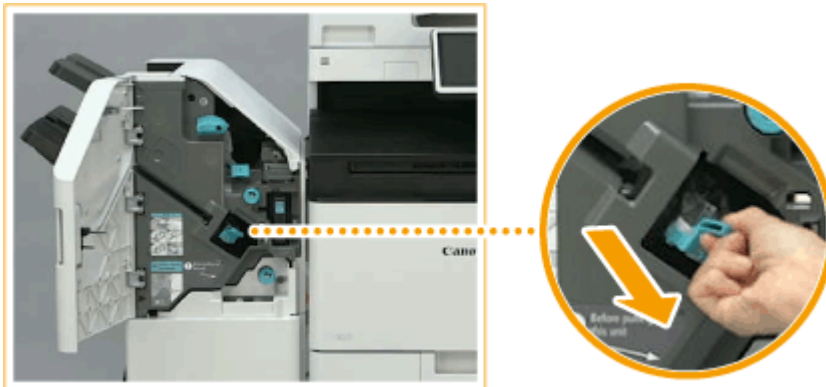

- 3 Remove the jammed staple(s) from the staple cartridge.

- 1 Lift up the knob on the staple cartridge.

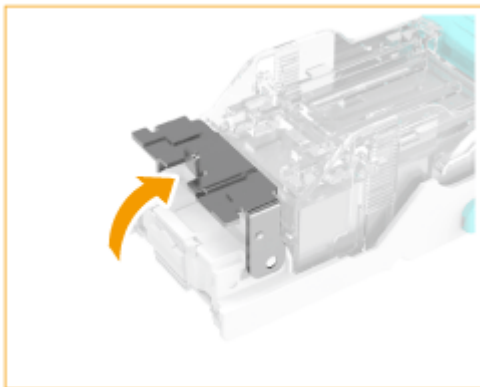

- 2 Remove all jammed staples and exposed staples.

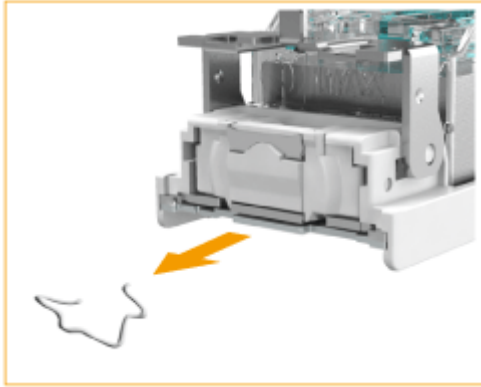

3 Return the knob on the staple cartridge to its original position.

4 Hold the green tab on the staple cartridge and push in the cartridge as far as it will go.



5 Close the front cover of the finisher.

- Dry stapling may be performed automatically for staple repositioning.

Staple Jam Has Occurred in the Booklet Finisher

961F-02E

- ▶ Clearing Staple Jams in the Staple Unit(P. 164)
- ▶ Clearing Staple Jams in the Saddle Stitcher Unit(P. 165)

NOTE

Confirm before handling

- If there is any paper in the booklet tray, remove it.

Clearing Staple Jams in the Staple Unit

1 Open the front cover of the finisher.

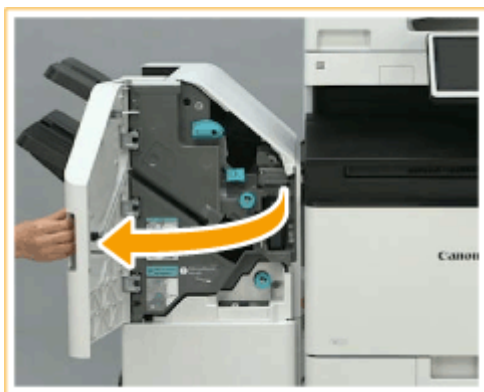

2 Pull out the staple cartridge.

- Hold the green tab on the staple cartridge and pull the cartridge straight out.

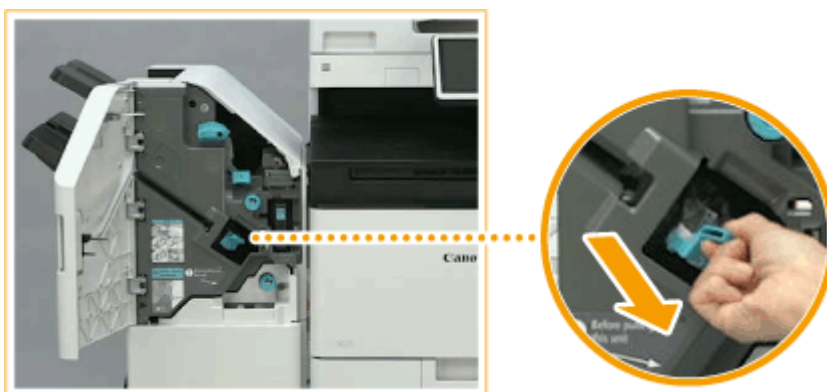

3 Remove the jammed staple(s) from the staple cartridge.

- 1 Lift up the knob on the staple cartridge.

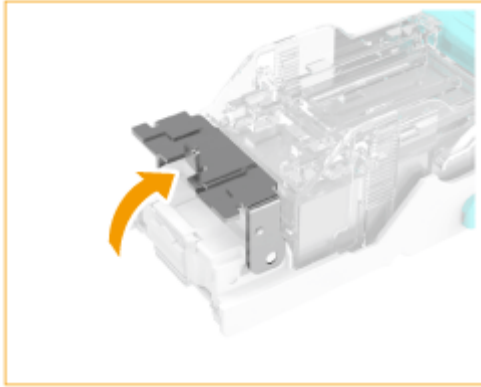

- 2 Remove all jammed staples and exposed staples.

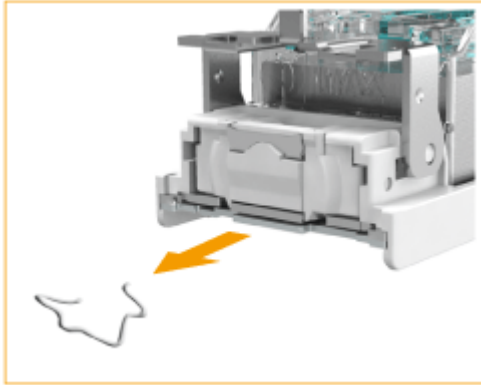

- 3 Return the knob on the staple cartridge to its original position.

- 4 Hold the green tab on the staple cartridge and push in the cartridge as far as it will go.



- 5 Close the front cover of the finisher.

- Dry stapling may be performed automatically for staple repositioning.

Clearing Staple Jams in the Saddle Stitcher Unit

- 1 Open the front cover of the finisher.



2 Pull out the saddle sticher unit.



3 Remove the (two) staple cartridges while pulling down the lever towards you.



4 Remove the jammed staple(s) from the staple cartridge.

1 Lower the knob on the staple cartridge.



- 2** Remove all jammed staples and exposed staples.

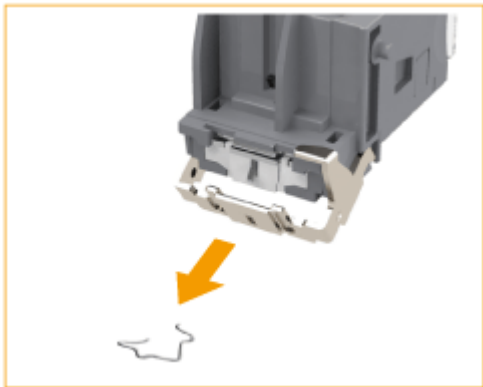

- 3** Return the knob on the staple cartridge to its original position.

- 5** Install the (two) staple cases in the saddle stitch unit.



- 6** Gently return the saddle stitcher unit to its original position.

- 7** Close the front cover of the finisher.

- After clearing a staple jam, make sure to adjust the staple position. ▶<Saddle Stitch Staple Repositioning>(P. 1151)

Staple Jam Has Occurred in the Inner Finisher

961F-02F

1 Check whether paper is jammed in output tray of the finisher.

- If paper is jammed, gently pull it out in the direction of the arrow.



NOTE:

- When you are using the Staple mode, do not remove the current stack of printouts from the output tray before it is stapled. After the paper jam clearing operation is finished, the following printouts will add to the current stack.

2 Open the front cover of the finisher.

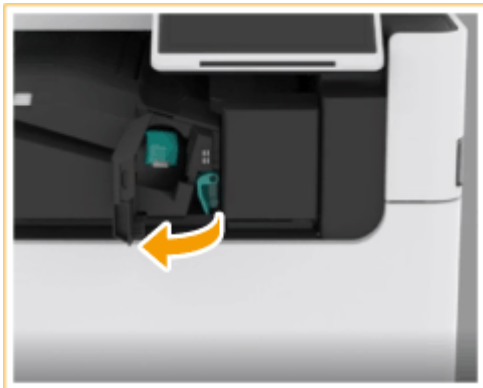

3 Pull out the staple cartridge.

- Pull down the green tab on the staple cartridge to disengage the lock, and lift up the cartridge slightly while pulling it straight out.



4 Remove the jammed staple(s) from the staple cartridge.

- 1** Lift up the knob on the staple cartridge.

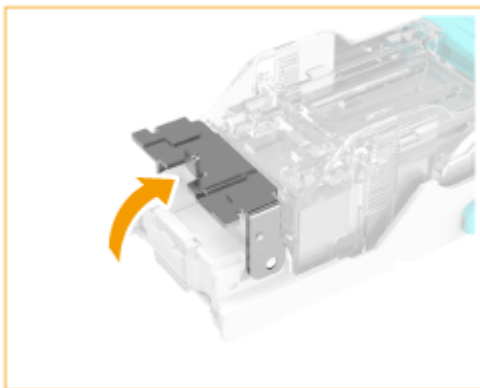

- 2** Remove all jammed staples and exposed staples.

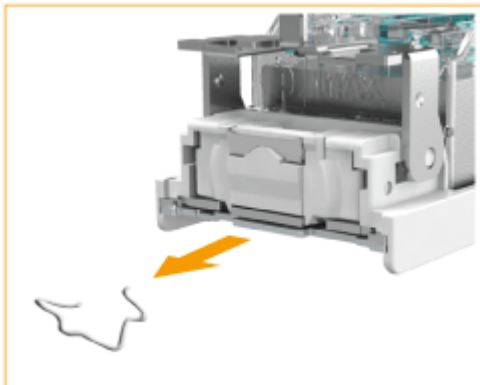

- 3** Return the knob on the staple cartridge to its original position.

- 5** Hold the green tab on the staple cartridge and push in the cartridge as far as it will go.



6 Close the front cover of the finisher.

- Dry stapling may be performed automatically for staple repositioning.

Options

961F-02H

The functionality of the machine can be expanded by installing options to the machine.

NOTE

- For information on system-related optional equipment, see [▶System Options\(P. 1597\)](#) .

■ Available Options

▶Optional Equipment(P. 173)

■ Finding Options According to Your Purposes

- ▶2-Sided Single Pass Feeder (Single Pass DADF-C)(P. 26)
- ▶2-Sided Double Pass Feeder (DADF-BA)(P. 28)

To add paper drawers

- ▶Cassette Feeding Unit-AW(P. 177)

To load heavy coated paper

- ▶Media Adjustment kit-A(P. 178)

To use functions such as folding and stapling, or install an additional output tray

- ▶Inner Finisher-L/Inner 2/4 Hole Puncher-D/Inner 4 Hole Puncher-D(P. 179)
- ▶Staple Finisher-AE/Booklet Finisher-AE/2/4 Hole Puncher Unit-A/4 Hole Puncher Unit-A(P. 191)
- ▶Inner 2way Tray-M(P. 205)
- ▶Copy Tray-T(P. 206)

NOTE:

- For the optional equipment enabling you to use functions such as folding and stapling, see [▶Optional Equipment Supporting Specific Functions\(P. 213\)](#)

To install a cover instead of a feeder

- ▶Platen Cover-Y(P. 207)

To use keys instead of touch panel buttons

- ▶Numeric Keypad(P. 210)

To use the authentication function to manage users by department

- ▶Copy Card Reader(P. 208)

To use a support tool when closing the feeder

➤ ADF Access Handle-A(P. 212)

To make space for placing originals, etc.

Utility Tray-B

■ Handling of the Options

CAUTION

- Do not place your hand in the part of the tray where stapling is performed (near the rollers) if a finisher is attached, as this may result in personal injury.



- Do not place your fingers or hands on the finisher when the finisher is in use. Doing so may result in personal injury or damage to the finisher.
- When removing paper from the tray of the finisher, do not place your hands on the output tray of the finisher. The tray may move upward and your hands may get caught.



IMPORTANT

- The trays of the finisher move during copying or printing. Do not place anything under the trays, as doing so may damage the trays.
- Do not place anything other than output paper in the trays of the finisher, as doing so may damage the trays.

NOTE

- Some of the settings may not be displayed depending on the configuration of optional equipment installed on the machine.

Optional Equipment

961F-02J

By combining options, you can use functions more efficiently.

■ When the Staple Finisher-AE/Booklet Finisher-AE is installed



1 Booklet Finisher-AE

You can perform collating, grouping, offsetting, stapling (Corner/Double/Saddle Stitch), and saddle folding with this option. In addition, you can manually bind with the stapler or bind without the stapler. **▶Staple Finisher-AE/Booklet Finisher-AE/2/4 Hole Puncher Unit-A/4 Hole Puncher Unit-A(P. 191)**

2 Cassette Feeding Unit-AW

Load the type of paper that you frequently use. You can load paper that cannot be loaded in the paper drawer 1, such as A3 and custom size paper. **▶Cassette Feeding Unit-AW(P. 177)**

3 2/4 Hole Puncher Unit-A/4 Hole Puncher Unit-A

If you install the "2/4 Hole Puncher Unit-A" or "4 Hole Puncher Unit-A" in the "Staple Finisher-AE" or "Booklet Finisher-AE," you can punch holes in your printouts. **▶Staple Finisher-AE/Booklet Finisher-AE/2/4 Hole Puncher Unit-A/4 Hole Puncher Unit-A(P. 191)**

4 Staple Finisher-AE

You can perform collating, grouping, offsetting, and stapling (Corner/Double) with this option. In addition, you can manually bind with the stapler or bind without the stapler. **▶Staple Finisher-AE/Booklet Finisher-AE/2/4 Hole Puncher Unit-A/4 Hole Puncher Unit-A(P. 191)**

■ When the Inner Finisher-L is installed



1 Inner Finisher-L

You can perform collating, grouping, offsetting, and stapling (Corner/Double) with this option. In addition, you can manually bind with the stapler or bind without the stapler. **▶Inner Finisher-L/Inner 2/4 Hole Puncher-D/Inner 4 Hole Puncher-D(P. 179)**

2 Inner 2/4 Hole Puncher-D/Inner 4 Hole Puncher-D

If you install the "Inner 2/4 Hole Puncher-D" or "Inner 4 Hole Puncher-D" in the "Inner Finisher-L," you can punch holes in your printouts. **▶Inner Finisher-L/Inner 2/4 Hole Puncher-D/Inner 4 Hole Puncher-D(P. 179)**

■ When Other Options are Installed



1 Inner 2way Tray-M

This option enables paper to be output to two locations. ▶ **Inner 2way Tray-M(P. 205)**

2 DADF-BA

Several sheets of original or 2-sided originals can be scanned continuously. ▶ **2-Sided Double Pass Feeder (DADF-BA)(P. 28)**

3 Copy Tray-T

This option enables paper to be output to two locations. ▶ **Copy Tray-T(P. 206)**

4 Single Pass DADF-C

Several sheets of original or 2-sided originals can be scanned continuously. ▶ **2-Sided Single Pass Feeder (Single Pass DADF-C)(P. 26)**

5 Numeric Keypad

Attaching a Numeric Keypad allows you to use keys on the Numeric Keypad instead of certain buttons on the touch panel display. ▶ **Numeric Keypad(P. 210)**

6 Utility Tray-B

This option provides space for placing originals.

7 Platen Cover-Y

This option holds the original placed on the platen glass in place. [▶Platen Cover-Y\(P. 207\)](#)

8 Copy Card Reader

You can implement Department ID Management using the card reader. [▶Copy Card Reader\(P. 208\)](#)

NOTE

- For information on the combination of options that can be installed on the machine, contact your dealer or service representative.
- Some of the settings may not be displayed depending on the configuration of optional equipment installed on the machine.

Cassette Feeding Unit-AW

961F-02K

Enables you to add two paper drawers. Loading different sized paper in the optional paper drawers enables reduced work for switching paper.

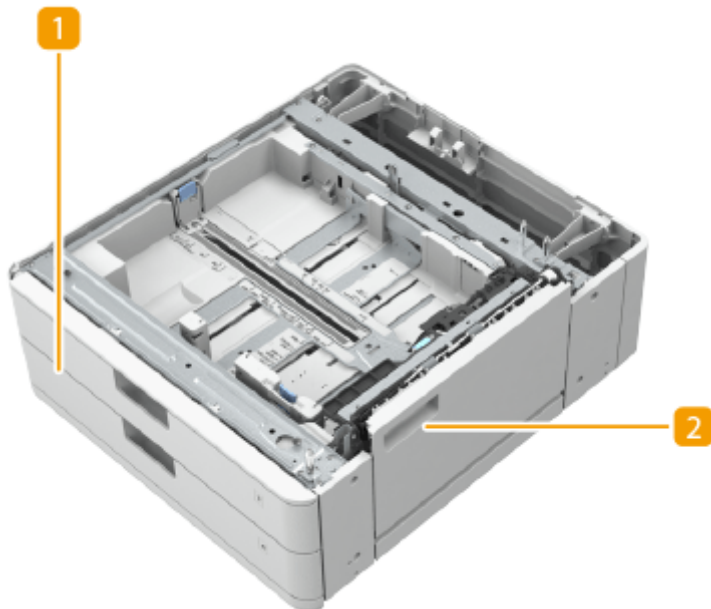

1 Paper drawer

Load Paper. ▶ **Basic Paper Loading Method(P. 47)**

2 Lower-right cover

Open this cover when clearing a paper jam inside the machine. ▶ **Paper Jams in a Paper Source(P. 145)**

NOTE

- When loading paper of a different size into a paper drawer, adjust the guides.
- For information on available paper sizes, see ▶ **Available Paper(P. 224)** .

Media Adjustment kit-A

961F-02R

This kit enables you to load heavy coated paper (300 g/m²) in the multi-purpose tray.



NOTE

- For information on available paper sizes, see [▶ Available Paper\(P. 224\)](#) .

Inner Finisher-L/Inner 2/4 Hole Puncher-D/Inner 4 Hole Puncher-D

961F-02S

Installing "Inner Finisher-L" enables you to use the following finish functions.

Collate

The printouts are collated into sets arranged in page order of the original.

Group

All printouts of the same original page are grouped together into sets.

Offset

Each printout group is shifted in alternating layers.

Staple + Collate

The printouts are collated into sets arranged in page order and stapled (Corner/Double).

Staple + Group

All printouts of the same original page are grouped together into sets and stapled (Corner/Double).

Staple Free

The printouts are crimped and bound without using a staple. You can easily split the paper by pressing the crimped part with your fingers. This function is useful for saving staples and also binding printouts briefly.

NOTE

- For information on the paper sizes that can be used for Staple Free, see [▶Inner Finisher-L\(P. 235\)](#) .
- For information on the functions or paper that cannot be used with Staple Free, see "Restrictions on Combinations of Copy Functions" or [▶Paper Not Available for Finishing\(P. 230\)](#) . The following are unavailable depending on the staple position.
 - Paper not available for two-sided printing
 - Mixed paper sizes
- Depending on the usage environment and paper type, the crimped part may be split easily.

Manual Stapling

You can manually staple printed paper by inserting paper in the slit. As an example of use, you can remove staples bound to the document, copy or scan it, and then staple the document again.

TIPS

- If you install the "Inner 2/4 Hole Puncher-D" or "Inner 4 Hole Puncher-D" in the "Inner Finisher-L," you can punch holes in your printouts.

■ External View



1 Auxiliary Tray

Pull out the auxiliary tray if you are outputting large size paper.

2 Output Tray

Paper is output to the output tray.

3 Staple Button

Press this button when you manually staple paper (Manual Stapling). You can also staple paper without pressing the button. You can specify the time period for the paper to be stapled after inserting the paper. <Adjust Action> ▶ ◀<Time Until Stapling Starts in Stapler Mode>(P. 1152)

4 Slit

Insert paper to manually staple the paper. You can specify the time period for the paper to be stapled after inserting the paper.

5 Right cover (Inner 2/4 Hole Puncher-D/Inner 4 Hole Puncher-D)

Open to discard punch waste.

6 Left cover (Inner Finisher-L)

Open to remove jammed paper, clear a staple jam in the stapler unit, or replace the staple cartridge.

Selecting the Staple Position

To finish with the stapler, you need to select the staple position paying attention to the orientation of original document.

NOTE

- For the procedure to finish with the stapler, see ◀<Finishing with the Stapler>(P. 462)

■ Stapling at One Location in a Corner of the Paper (Corner)

Refer to the following figures to select the staple position.

- Stapling at the top right of paper in portrait orientation



When Placing A4-, A5-size Originals

Feeder



Platen glass



⇒ select <Top Right>

When Placing A3-size Originals

Feeder



Platen glass



⇒ select <Top Left>

- Stapling at the top left of paper in portrait orientation



When Placing A4-, A5-size Originals

Feeder



Platen glass



⇒ select <Top Left>

When Placing A3-size Originals

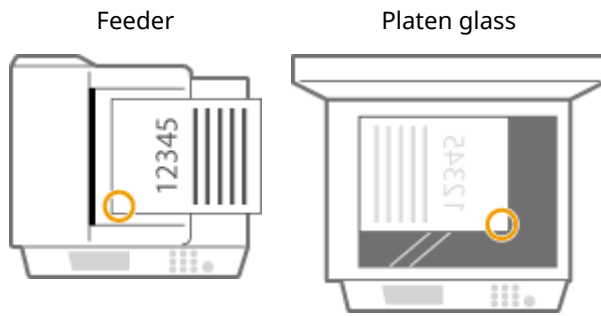

⇒ select <Bottom Left>

- Stapling at the top right of paper in landscape orientation

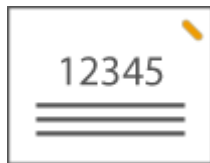

When Placing A4-, A5-size Originals

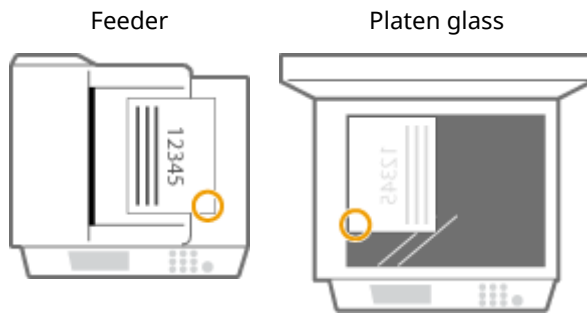

⇒ select <Bottom Right>

When Placing A3-size Originals

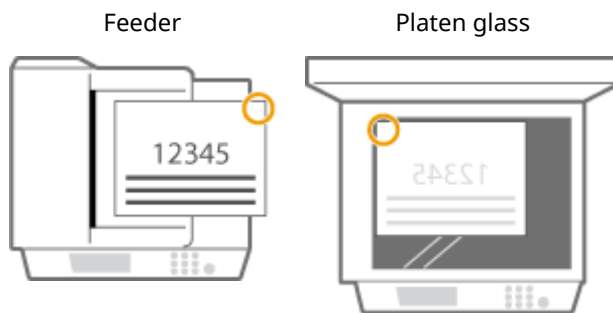

⇒ select <Top Right>

- Stapling at the top left of paper in landscape orientation



When Placing A4-, A5-size Originals

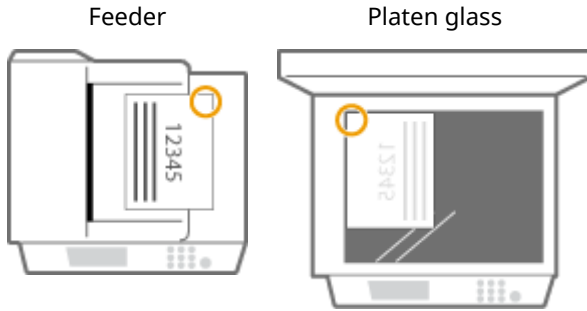

⇒ select <Top Right>

When Placing A3-size Originals

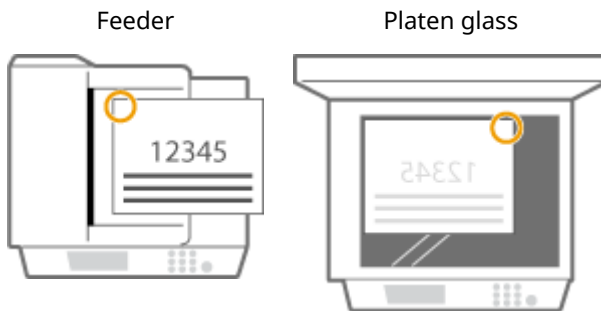

⇒ select <Top Left>

■ Stapling at Two Locations in a Margin Area of the Paper (Double)

Refer to the following figures to select the staple position.

- Stapling in the top margin area of paper in portrait orientation

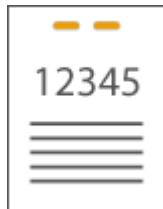

When Placing A3-size Originals

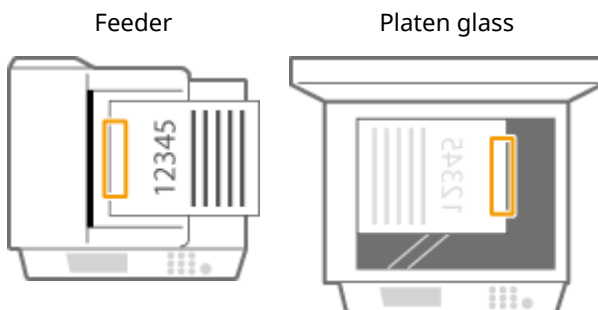

⇒ select <Left>

- Stapling in the left margin area of paper in portrait orientation



When Placing A4-, A5-size Originals

Feeder

Platen glass



⇒ select <Left>

- Stapling in the right margin area of paper in portrait orientation



When Placing A4-, A5-size Originals

Feeder

Platen glass



⇒ select <Right>

- Stapling at the left margin area of paper in landscape orientation

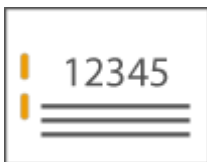

When Placing A3-size Originals

Feeder

Platen glass



⇒ select <Left>

- Stapling in the right margin area of paper in landscape orientation

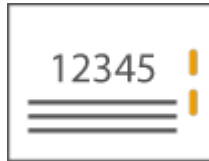

Feeder

Platen glass

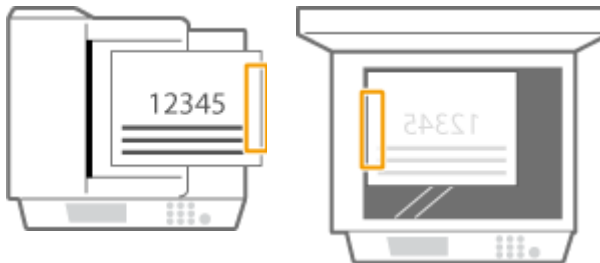

⇒ select <Right>

■ Binding the Paper by Crimping without Using Staples (Corner)

Refer to the following figures to select the crimp position when crimping the paper without using staples.

- Stapling at the top right of paper in portrait orientation



When Placing A4-, A5-size Originals

Feeder

Platen glass

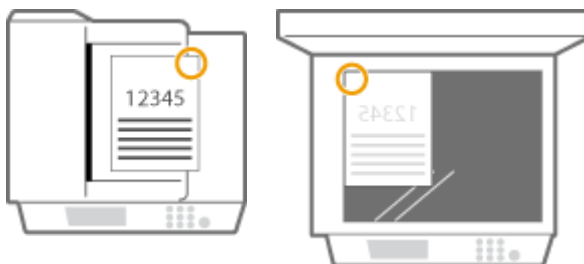

⇒ select <Top Right>

When Placing A3-size Originals

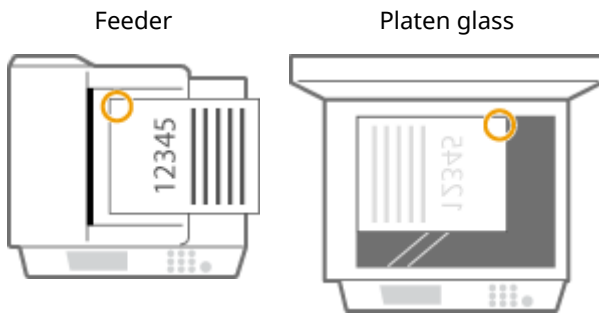

⇒ select <Top Left>

- Stapling at the top left of paper in portrait orientation



When Placing A4-, A5-size Originals

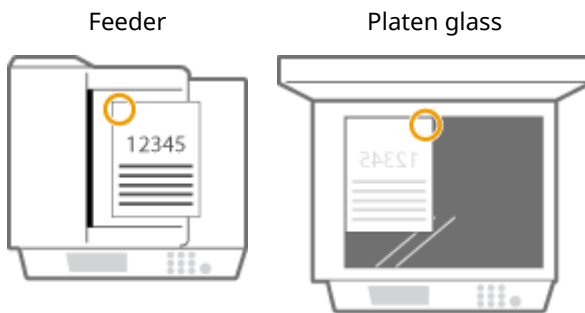

⇒ select <Top Left>

When Placing A3-size Originals

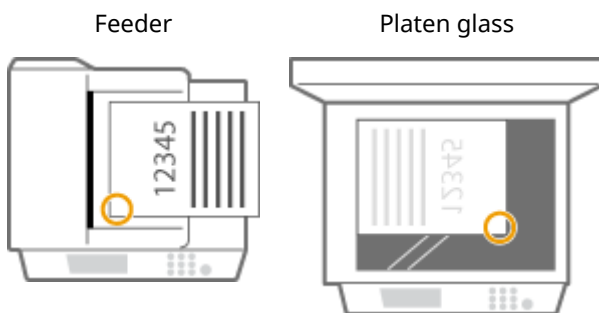

⇒ select <Bottom Left>

- Stapling at the top right of paper in landscape orientation

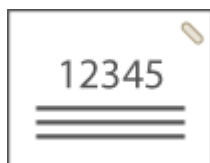

When Placing A4-, A5-size Originals

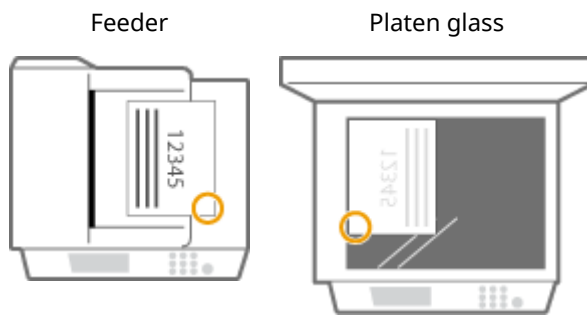

⇒ select <Bottom Right>

When Placing A3-size Originals

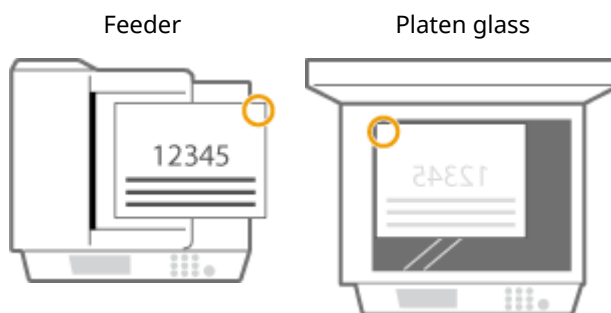

⇒ select <Top Right>

- Stapling at the top left of paper in landscape orientation

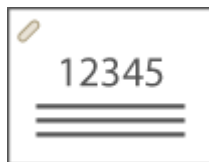

When Placing A4-, A5-size Originals

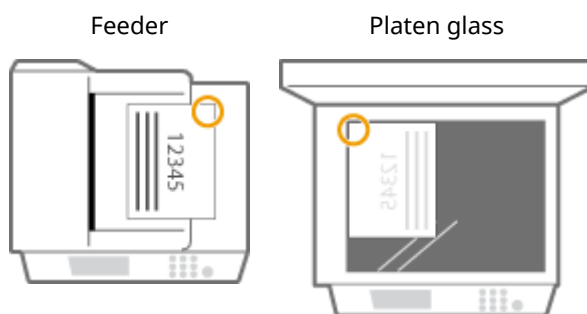

⇒ select <Top Right>

When Placing A3-size Originals

Feeder Platen glass



⇒ select <Top Left>

Manual Stapling

- 1 Place the desired bundle of paper into the slit in the inner finisher.
 - Insert the corner of the paper bundle where you want it stapled straight into the slit, with the front side of the paper facing down.
 - When the paper bundle is sensed, the staple button starts to blink and automatic stapling is performed.



NOTE:

- You can set the time in seconds to elapse before stapling is executed. ◀<Time Until Stapling Starts in Stapler Mode>(P. 1152)
- You can perform stapling without waiting for the specified stapling start time to come. While holding the paper bundle with one of your hands, use the other hand to press the staple button.



- 2 Pull out the paper bundle.
 - Wait for the staple button to turn off, and then pull out the paper bundle.

NOTE

- You cannot perform manual stapling while outputting of printed paper continues.

Making Punch Holes

Refer to the following figures to place the original so that punch holes are made at the desired positions.

- Making punch holes in the left margin area of paper in portrait orientation



When Placing A4-, A5-size Originals

Feeder



Platen glass



- Making punch holes in the top margin area of paper in portrait orientation

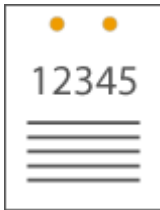

Feeder

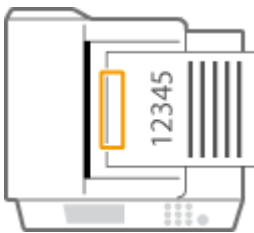

Platen glass

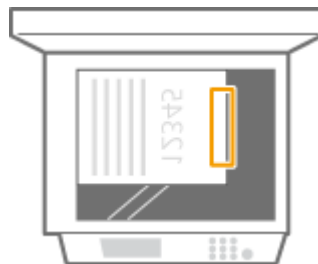

- Making punch holes in the left margin area of paper in landscape orientation

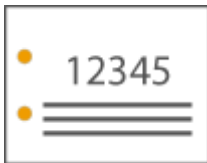

Feeder

Platen glass



- Making punch holes in the top margin area of paper in landscape orientation

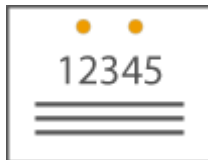

When Placing A4-, A5-size Originals

Feeder



Platen glass



NOTE

- For information on the paper sizes that can be used for Staple, see [▶Inner Finisher-L\(P. 235\)](#) .
- To replace the staple cartridge of the staples, see [▶Replenishing the Staples \(Optional\)\(P. 106\)](#) .
- For how to clear a paper jam or a staple jam, see [▶Clearing Paper Jams\(P. 131\)](#) and [▶Clearing Staple Jams \(Optional\)\(P. 161\)](#) .
- The maximum number of bindable sheets may not be possible, depending on the paper type. In this case, change the paper type, or reduce the number of sheets to bind.

Collate and group

- If you select <Offset> in combination with the collate or group function, each printout group is shifted.

Staplers

- When you are using the Staple mode, do not remove the stack of paper from the output tray during the job. Remove the stack of paper when the job has been completed.
- If the message "Load staples into the stapler unit." appears, staples are running out. To proceed, replace the staple case.
- Output temporarily stops when the tray reaches the lowest position or when 30 sets have been stapled. Printing resumes when you remove all of the paper that has been output.

Staple Finisher-AE/Booklet Finisher-AE/2/4 Hole Puncher Unit-A/4 Hole Puncher Unit-A

961F-02U

Installing "Staple Finisher-AE" or "Booklet Finisher-AE" enables you to use the following finish functions.

Collate

The printouts are collated into sets arranged in page order of the original.

Group

All printouts of the same original page are grouped together into sets.

Offset

Each printout group is shifted in alternating layers.

Staple + Collate

The printouts are collated into sets arranged in page order and stapled (Corner/Double). You can saddle stitch and output the printouts by using the "Booklet Finisher-AE."

Staple + Group

All printouts of the same original page are grouped together into sets and stapled (Corner/Double).

Staple Free

The printouts are crimped and bound without using a staple. You can easily split the paper by pressing the crimped part with your fingers. This function is useful for saving staples and also binding printouts briefly.

NOTE

- For information on the paper sizes that can be used for Staple Free, see [▶Staple Finisher-AE / Booklet Finisher-AE\(P. 237\)](#) .
- For information on the functions or paper that cannot be used with Staple Free, see "Restrictions on Combinations of Copy Functions" or [▶Paper Not Available for Finishing\(P. 230\)](#) . The following are unavailable depending on the staple position.
 - Paper not available for two-sided printing
 - Mixed paper sizes
- Depending on the usage environment and paper type, the crimped part may be split easily.

Manual Stapling

You can manually staple printed paper by inserting paper in the slit. As an example of use, you can remove staples bound to the original, copy or scan it, and then staple the original again.

Saddle Fold (Booklet Finisher-AE only)

The printouts are folded into half its size. Up to three sheets together can be folded.

TIPS

- If you install the "2/4 Hole Puncher Unit-A" or "4 Hole Puncher Unit-A" in the "Staple Finisher-AE" or "Booklet Finisher-AE," you can punch holes in your printouts.

■ External View

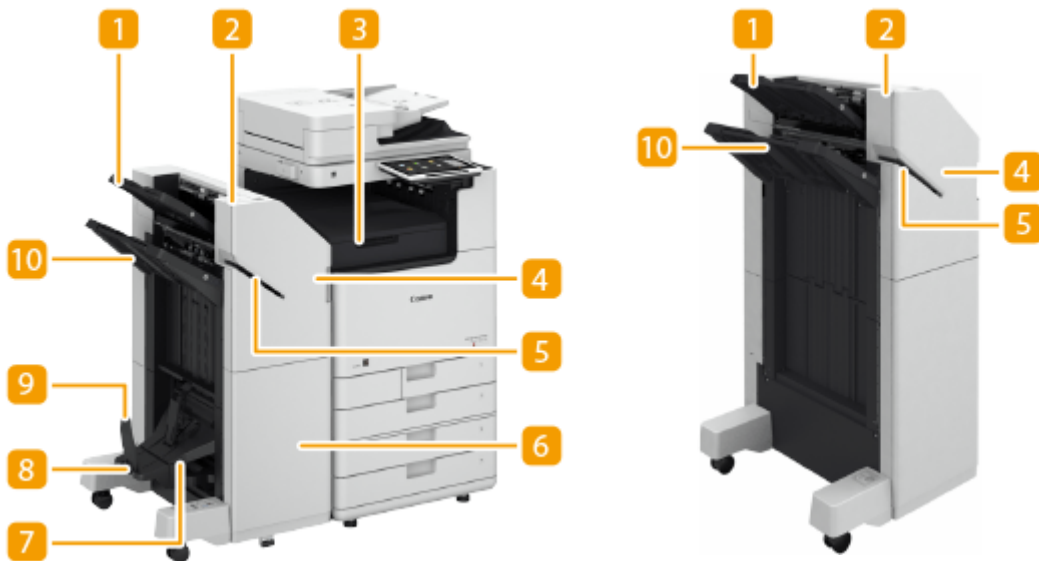

Booklet Finisher-AE

Staple Finisher-AE

1 Tray A

The prints are output to this tray. You can specify functions for which the tray is used by configuring <Output Tray Settings>. ▶<Output Tray Settings>(P. 1168)

2 Staple Button

Press this button when you manually staple paper (Manual Stapling). You can also staple paper without pressing the button. You can specify the time period for the paper to be stapled after inserting the paper. <Adjust Action> ▶▶<Time Until Stapling Starts in Stapler Mode>(P. 1152)

3 Buffer Pass Unit

Open to remove jammed paper.

4 Front cover (upper)

Open to remove jammed paper, clear a staple jam in the stapler unit and saddle stitcher unit, or replace the staple cartridge. If the "2/4 Hole Puncher Unit-A" or "4 Hole Puncher Unit-A" is installed, open to discard punch waste.

5 Slit

Insert paper to manually staple the paper. You can specify the time period for the paper to be stapled after inserting the paper.

6 Front cover (lower) (Booklet Finisher-AE only)

Open to remove jammed paper, clear a staple jam, or replace the staple cartridge in the saddle stitcher unit.

7 Booklet tray (Booklet Finisher-AE only)

The printouts that are saddle stitched are output to this tray.

8 Lock Release Lever (Booklet Finisher-AE only)

Pull down the lever to unlock the paper stopper.

9 Paper Stopper (Booklet Finisher-AE only)

! IMPORTANT:

- When you lower the paper stopper, pull down the lock release lever. If you lower the paper stopper without pulling down the lock release lever, the paper stopper may be damaged.

NOTE:

- Lower the paper stopper to cancel the restriction on the number of book binding copies and print continuously. This is useful when you print often in large quantities. However, make sure that you prepare a receiving box to prevent the output paper from scattering on the floor.

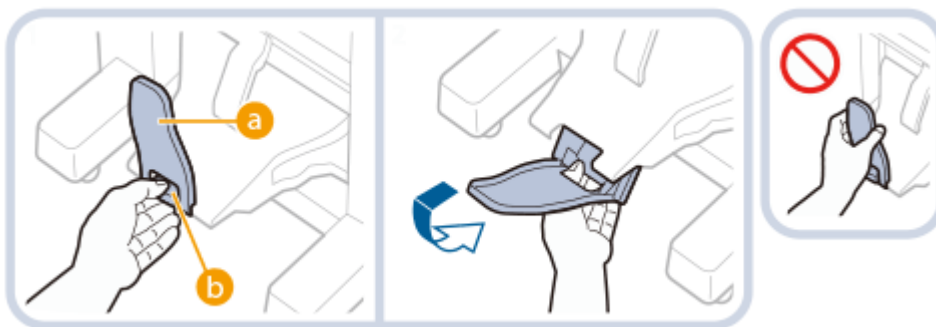

a : Paper Stopper

b : Lock Release Lever

10 Tray B

The prints are output to this tray. You can specify functions for which the tray is used by configuring <Output Tray Settings>. ▶<Output Tray Settings>(P. 1168)

■ Internal View



Booklet Finisher-AE

Staple Finisher-AE

1 Saddle stitcher unit (Booklet Finisher-AE only)

Pull out to remove jammed paper or clear a staple jam in the saddle stitcher unit, or to replace the staple cartridge.

2 Punch waste tray (2/4 Hole Puncher Unit-A/4 Hole Puncher Unit-A)

Pull out to discard punch waste. **▶Emptying the Punch Waste (Optional)(P. 118)**

Selecting the Staple Position

To finish with the stapler, you need to select the staple position paying attention to the orientation of original document.

NOTE

- For the procedure to finish with the stapler, see **▶Finishing with the Stapler(P. 462)**

■Stapling at One Location in a Corner of the Paper (Corner)

Refer to the following figures to select the staple position.

- Stapling at the top right of paper in portrait orientation



When Placing A4-, A5-size Originals

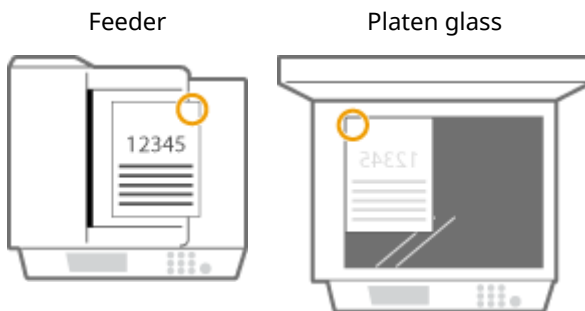

⇒ select <Top Right>

When Placing A3-size Originals

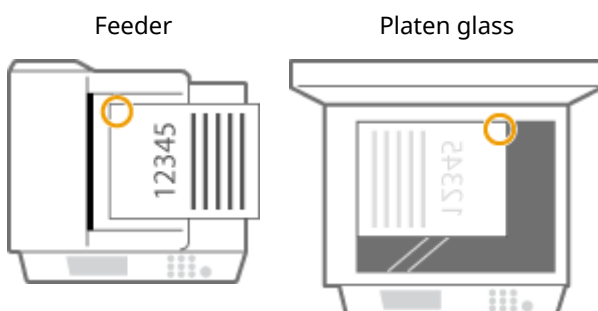

⇒ select <Top Left>

- Stapling at the top left of paper in portrait orientation



When Placing A4-, A5-size Originals

Feeder



Platen glass



⇒ select <Top Left>

When Placing A3-size Originals

Feeder

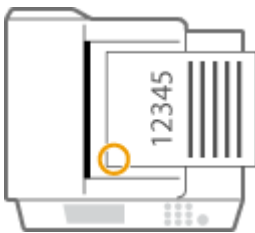

Platen glass

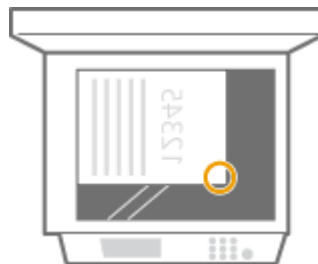

⇒ select <Bottom Left>

- Stapling at the top right of paper in landscape orientation

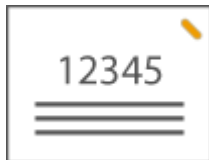

When Placing A4-, A5-size Originals

Feeder



Platen glass



⇒ select <Bottom Right>

When Placing A3-size Originals

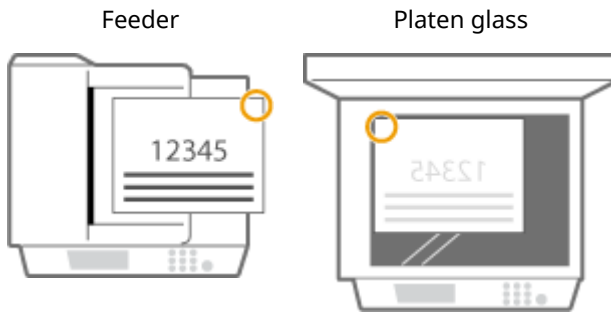

⇒ select <Top Right>

- Stapling at the top left of paper in landscape orientation



When Placing A4-, A5-size Originals

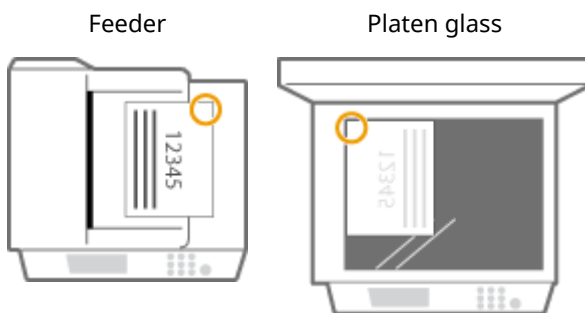

⇒ select <Top Right>

When Placing A3-size Originals

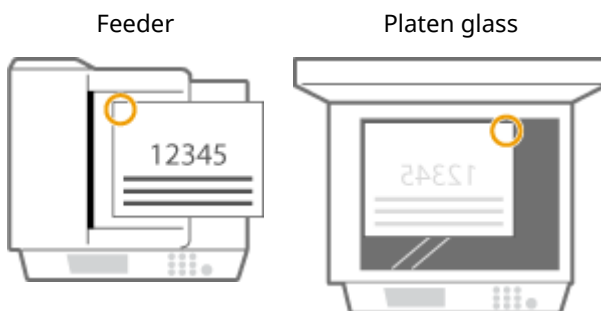

⇒ select <Top Left>

■ Stapling at Two Locations in a Margin Area of the Paper (Double)

Refer to the following figures to select the staple position.

- Stapling in the top margin area of paper in portrait orientation

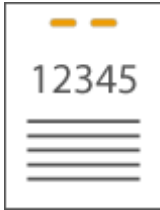

When Placing A3-size Originals

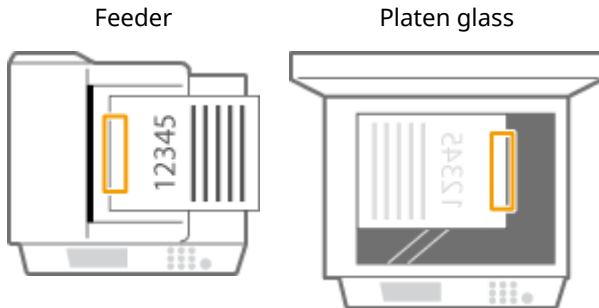

⇒ select <Left>

- Stapling in the left margin area of paper in portrait orientation



When Placing A4-, A5-size Originals

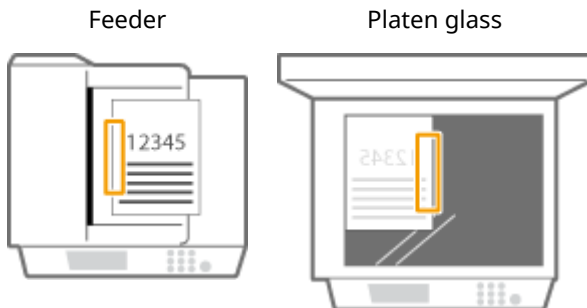

⇒ select <Left>

- Stapling in the right margin area of paper in portrait orientation



When Placing A4-, A5-size Originals

Feeder Platen glass



⇒ select <Right>

- Stapling at the left margin area of paper in landscape orientation

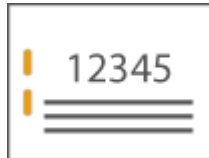

When Placing A3-size Originals

Feeder

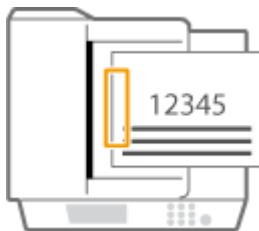

Platen glass



⇒ select <Left>

- Stapling in the right margin area of paper in landscape orientation

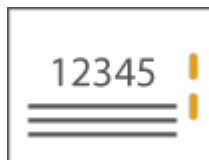

Feeder



Platen glass



⇒ select <Right>

■ Binding the Paper by Crimping without Using Staples (Corner)

Refer to the following figures to select the crimp position when crimping the paper without using staples.

- Stapling at the top right of paper in portrait orientation



When Placing A4-, A5-size Originals

Feeder



Platen glass



⇒ select <Top Right>

When Placing A3-size Originals

Feeder



Platen glass



⇒ select <Top Left>

- Stapling at the top left of paper in portrait orientation



When Placing A4-, A5-size Originals

Feeder



Platen glass



⇒ select <Top Left>

When Placing A3-size Originals

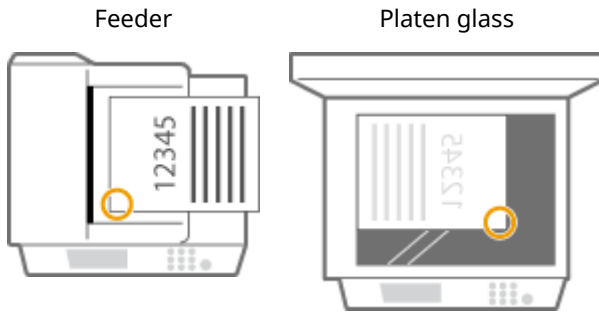

⇒ select <Bottom Left>

- Stapling at the top right of paper in landscape orientation

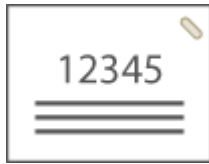

When Placing A4-, A5-size Originals

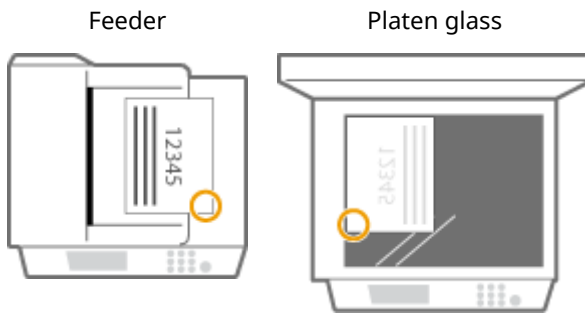

⇒ select <Bottom Right>

When Placing A3-size Originals

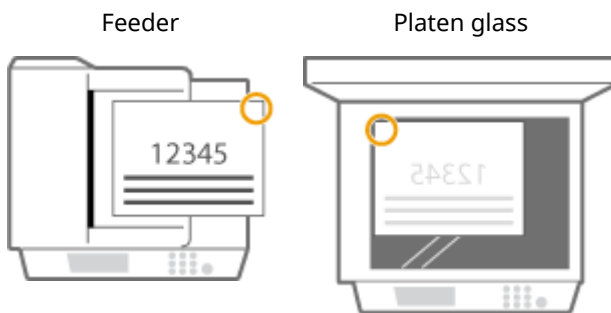

⇒ select <Top Right>

- Stapling at the top left of paper in landscape orientation

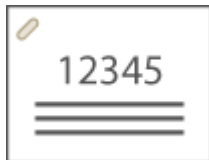

When Placing A4-, A5-size Originals

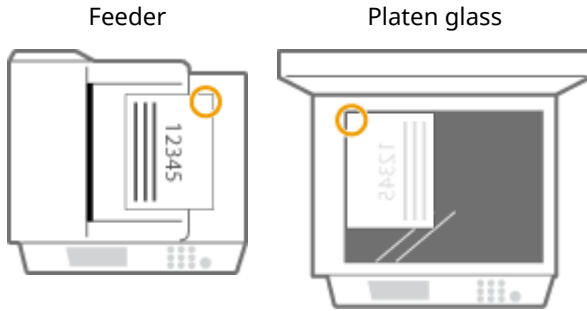

⇒ select <Top Right>

When Placing A3-size Originals

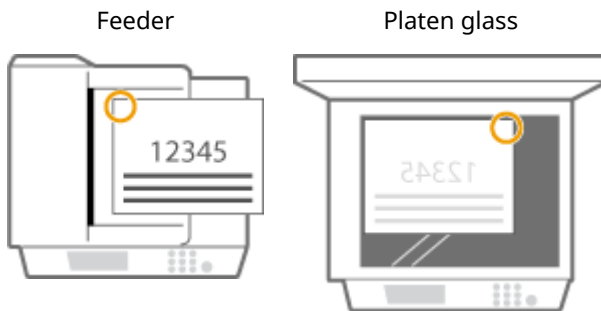

⇒ select <Top Left>

Manual Stapling

- 1 Place the desired bundle of paper into the slit in the stapler finisher or booklet finisher.
 - Insert the corner of the paper bundle where you want it stapled straight into the slit, with the front side of the paper facing down.
 - When the paper bundle is sensed, the staple button starts to blink and automatic stapling is performed.



NOTE:

- You can set the time in seconds to elapse before stapling is executed. ▶<Time Until Stapling Starts in Stapler Mode>(P. 1152)
- You can perform stapling without waiting for the specified stapling start time to come. While holding the paper bundle with one of your hands, use the other hand to press the staple button.



- 2 Pull out the paper bundle.
 - Wait for the staple button to turn off, and then pull out the paper bundle.

NOTE

- You cannot perform manual stapling while outputting of printed paper continues.

Making Punch Holes

Refer to the following figures to place the original so that punch holes are made at the desired positions.

- Making punch holes in the left margin area of paper in portrait orientation



When Placing A4-, A5-size Originals

Feeder



Platen glass



- Making punch holes in the top margin area of paper in portrait orientation



Feeder

Platen glass

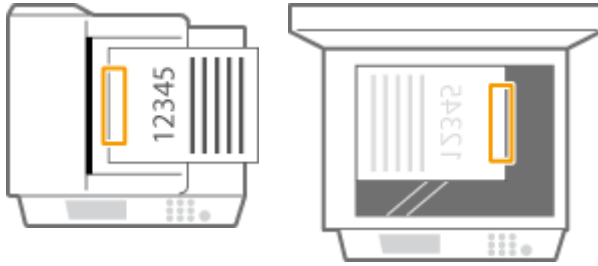

- Making punch holes in the left margin area of paper in landscape orientation

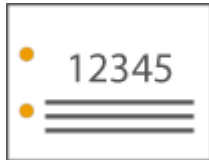

Feeder

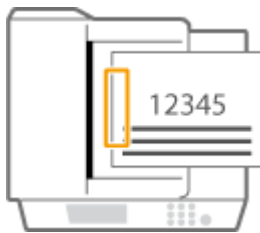

Platen glass



- Making punch holes in the top margin area of paper in landscape orientation



When Placing A4-, A5-size Originals

Feeder



Platen glass



NOTE

- For information on the paper sizes that can be used for Staple, Saddle Stitch, Hole Punch, and Saddle Fold, see **▶Staple Finisher-AE / Booklet Finisher-AE(P. 237)** .
- To replace the staple cartridge of the stapler unit or saddle stitcher unit, see **▶Replenishing the Staples (Optional)(P. 106)** .
- For how to clear a paper jam or a staple jam, see **▶Clearing Paper Jams(P. 131)** and **▶Clearing Staple Jams (Optional)(P. 161)** .
- The maximum number of bindable sheets may not be possible, depending on the paper type. In this case, change the paper type, or reduce the number of sheets to bind.

Collate and group

- If you select <Offset> in combination with the collate or group function, each printout group is shifted.
- Once an output tray has reached its stacking limit, subsequent prints are automatically delivered to the next available tray. If all of the available trays have reached their stacking limits, printing stops. Remove all of the output paper from the trays to resume printing.

Staplers

- When you are using the Staple mode, do not remove the stack of paper from the output tray during the job. Remove the stack of paper when the job has been completed.
- If the message "Load staples into the stapler unit." appears, staples are running out. To proceed, replace the staple case.
- If a tray reaches the lowest position limit, printing stops temporarily. Remove all of the output paper from the tray to resume printing.

Saddle stitch

- The accuracy of folds may vary depending on the paper type and the number of sheets.

Inner 2way Tray-M

961F-02W

You can use the following finish functions.

Collate

The printouts are collated into sets arranged in page order of the document.

Group

All printouts of the same original page are grouped together into sets.

Rotate 90 Degrees

Each printout group is rotated alternately in different directions.

TIPS

- You can install both the Inner 2way Tray-M and Copy Tray-T to add an extra output tray. This is convenient for using a different output tray for each function, including the Copy, Print, and Fax functions.



1 Output Paper Tray Guide

Tilt up the output paper tray guide to catch the printouts.

2 Inner Tray

Paper is output to the output tray.

3 Main Unit's Right Cover

Open this cover when clearing a paper jam inside the main unit.

Copy Tray-T

961F-02X

You can use the following finish functions.

Collate

The printouts are collated into sets arranged in page order of the document.

Group

All printouts of the same original page are grouped together into sets.

Rotate 90 Degrees

Each printout group is rotated alternately in different directions.

NOTE

- You can use the Rotate 90 Degrees function only if both the Inner 2way Tray-M and the Copy Tray-T are attached to the machine.

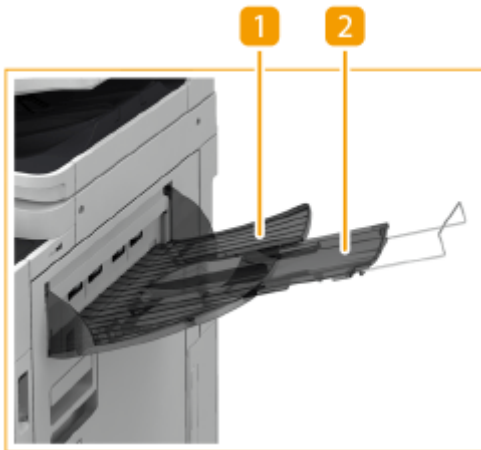

1 Output Tray

The prints are output to this tray.

2 Auxiliary tray

Pull out the auxiliary tray if you are printing on large size paper.

Platen Cover-Y

961F-02Y

If you do not want to use the feeder, install the Platen Cover-Y. The cover enables originals placed on the platen glass to be held in place. For more information, contact your local authorized Canon dealer.



1 Platen cover

Place the original on the platen glass, and close the cover.

Copy Card Reader

961F-030

If you install the "Copy Card Reader" to the machine, you can perform Department ID Management using the control card. Users are required to authenticate themselves before starting an operation such as copying or faxing ([▶ Configuring the Department ID Management Settings\(P. 842\)](#)). For the maximum registerable number of Department IDs, see [▶Management Functions\(P. 1586\)](#) .



1 Card slot

Insert a control card.

2 Control card

Control cards used with the "Copy Card Reader."

Inserting a card

- 1 Confirm that the screen to insert a control card is displayed.
- 2 Confirm the direction of the control card and insert it into the card slot.



- 3 Confirm that the <Home> screen is displayed. [▶<Home> Screen\(P. 332\)](#)

Removing the card

- 1 Remove the control card from the card slot.



- 2 Confirm that the screen to set a control card is displayed.

IMPORTANT

- If you set the Server Authentication user authentication system of User Authentication as the login service (including when performing Server Authentication with the 'Server Authentication + Local Device Authentication' user authentication system), you cannot use the Copy Card Reader.  **Managing Users(P. 803)**

NOTE

- If the <Home> screen does not appear when the control card is inserted, check if the control card is inserted in the correct direction and that the control card is not damaged or prohibited from use.

Numeric Keypad

961F-031

Attaching a Numeric Keypad to the machine allows you to use the keypad keys instead of certain buttons on the touch panel display. Note that when you are using Voice Navigation, you must attach the Numeric Keypad to the machine beforehand.



1 Home key

Press to display the <Home> screen on which buttons for the basic functions are placed. [▶Using the Touch Panel Display\(P. 331\)](#)

2 Volume Settings key

Press to display the screen when you want to adjust the sound volume for the fax communication or to set the alarm sound when an error occurs. [▶Setting Sounds\(P. 384\)](#)

3 Voice Navigation key

Press to start or end Voice Navigation. This key lights up when Voice Navigation is in use. To use Voice Navigation, you must attach the option Voice Operation Kit or Voice Guidance Kit. For information on operating the machine using Voice Navigation, refer to the optional guide.

4 Numeric keys ([0] to [9])

Press to enter numerical values. [▶Entering Characters\(P. 353\)](#)

5 Clear key

Press to clear entered values or characters.

6 Reset key

Press to cancel the settings and restore the previously specified settings.

7 Stop key

Stops a send job or a print job. ▶ **Canceling Send/Print Jobs(P. 383)**

8 Start key

Press to start copying or scanning documents.

9 Log In/Out key

Press this key to log in when personal authentication is necessary. After you finish using the machine, press this key again to log out. ▶ **Logging into the Machine(P. 355)**

ADF Access Handle-A

961F-032

This option helps you to close the feeder.



1 ADF access handle

Hook the edge of the handle to the tip of the feeder to gently close it.

Optional Equipment Supporting Specific Functions

961F-033

The optional equipment enabling you to use the finishing functions of the machine are as follows. Install items of optional equipment that are relevant to the functions you want to use.

- ▶ Using the Sorting Functions(P. 213)
- ▶ Using the Stapling Function(P. 213)
- ▶ Using the Folding Function(P. 213)
- ▶ Using the Hole Punching Function(P. 214)

Using the Sorting Functions

Function	Inner Finisher-L	Staple Finisher-AE	Booklet Finisher-AE	Inner 2way Tray-M	Copy Tray-T
Collate ^{*1}	✓	✓	✓	✓	✓
Group ^{*1}	✓	✓	✓	✓	✓
Offset	✓	✓	✓	–	–
Rotate 90 Degrees ^{*1}	–	–	–	✓	✓

*1 This is a standard function of the main unit.

Using the Stapling Function

Function	Inner Finisher-L	Staple Finisher-AE	Booklet Finisher-AE	Inner 2way Tray-M	Copy Tray-T
Staple + Collate (Corner/Double)	✓	✓	✓	–	–
Staple + Collate (Saddle Stitch)	–	–	✓	–	–
Staple + Group (Corner/Double)	✓	✓	✓	–	–
Staple-Free (Corner)	✓	✓	✓	–	–
Manual Staple (Corner)	✓	✓	✓	–	–

Using the Folding Function

Function	Inner Finisher-L	Staple Finisher-AE	Booklet Finisher-AE	Inner 2way Tray-M	Copy Tray-T
Saddle Fold	–	✓	✓	–	–

Using the Hole Punching Function

Function	Inner Finisher-L	Staple Finisher-AE	Booklet Finisher-AE	Inner 2way Tray-M	Copy Tray-T
Hole Punch	✓*1	✓*2	✓*2	—	—

*1 Can be used only when "Inner 2/4 Hole Puncher-D" or "Inner 4 Hole Puncher-D" is installed.

*2 Can be used only when "2/4 Hole Puncher Unit-A" or "4 Hole Puncher Unit-A" is installed.

NOTE

- For details on these functions, see [▶Functions Useful for Making and Managing Material\(P. 459\)](#) .
- Finishing functions may not be available depending the paper type. [▶Available Paper\(P. 224\)](#)

Hardware Specifications

961F-034

This section presents the specifications of the main unit and optional equipment of this product. Note that the specifications are subject to change without notice for product improvement or future release.

NOTE

- To check the system specifications for this product, see [System Specifications\(P. 1577\)](#) .

■ Machine Specifications

- ▶ [Main Unit\(P. 216\)](#)
- ▶ [2-Sided Single Pass Feeder \(Single Pass DADF-C\)\(P. 220\)](#)
- ▶ [2-Sided Double Pass Feeder \(DADF-BA\)\(P. 222\)](#)
- ▶ [Available Paper\(P. 224\)](#)

■ Specifications of Optional Equipment

- ▶ [Cassette Feeding Unit-AW\(P. 233\)](#)
- ▶ [Media Adjustment kit-A\(P. 234\)](#)
- ▶ [Inner Finisher-L\(P. 235\)](#)
- ▶ [Staple Finisher-AE / Booklet Finisher-AE\(P. 237\)](#)
- ▶ [Inner 2way Tray-M\(P. 240\)](#)
- ▶ [Copy Tray-T\(P. 241\)](#)
- ▶ [Copy Card Reader\(P. 242\)](#)

Main Unit

961F-0YL

Name	Canon imageRUNNER ADVANCE DX C3935i / C3930i / C3926i / C3922i
Type	Desktop
Color Supported	Full Color
Resolution for Reading	<ul style="list-style-type: none"> • 600 dpi x 600 dpi • 600 dpi x 300 dpi • 300 dpi x 300 dpi
Resolution for Writing	<ul style="list-style-type: none"> • 1,200 dpi x 600 dpi • 1,200 dpi x 1,200 dpi (at half speed)
Number of Tones	256
Acceptable Originals	<p>Sizes of Original</p> <p>Up to 297.0 mm x 431.8 mm*1</p> <p>Types of Original</p> <p>Sheet, book, and three dimensional objects</p> <p>Automatically Detectable Sizes of Original</p> <p>A3, A4, B4, B5, A4R, A5, B5R, B6, A5R, A6R</p>
Copy Size/Copy Paper	<p>Paper Sizes</p> <p>▶ Available Paper(P. 224)</p> <p>Margin</p> <ul style="list-style-type: none"> • Top: 4.0 mm • Left: 2.5 mm • Right: 0.0 mm or up • Bottom: 2.5 mm <p>Paper Weight</p> <ul style="list-style-type: none"> • Paper Drawer: 52 g/m² to 256 g/m² • Multi-Purpose Tray: 52 g/m² to 300 g/m²
Paper Type	▶ Available Paper(P. 224)
Warm-Up Time *2	<p>After Powering ON</p> <ul style="list-style-type: none"> • When <Quick Startup Settings for Main Power> is set to <On>: 10 seconds*3 • When <Quick Startup Settings for Main Power> is set to <Off>: 30 seconds <p>Returning from the Sleep mode</p> <p>10 seconds or less</p>

About the Machine

<p>First Copy Time</p>	<p>imageRUNNER ADVANCE DX C3935i</p> <p>Full Color: 7.4 seconds</p> <p>Black-and-White: 5.5 seconds</p> <p>imageRUNNER ADVANCE DX C3930i / C3926i / C3922i</p> <p>Full Color: 8.4 seconds</p> <p>Black-and-White: 6.1 seconds</p>
<p>Copy Speed ^{*4}</p>	<p>imageRUNNER ADVANCE DX C3935i</p> <p>Full Color: 35 sheets/minute</p> <p>Black-and-White: 35 sheets/minute</p> <p>imageRUNNER ADVANCE DX C3930i</p> <p>Full Color: 30 sheets/minute</p> <p>Black-and-White: 30 sheets/minute</p> <p>imageRUNNER ADVANCE DX C3926i</p> <p>Full Color: 26 sheets/minute</p> <p>Black-and-White: 26 sheets/minute</p> <p>imageRUNNER ADVANCE DX C3922i</p> <p>Full Color: 22 sheets/minute</p> <p>Black-and-White: 22 sheets/minute</p>
<p>Magnification</p>	<p>Regular Paper Size</p> <p>400%, 200%, 141.4%, 100%, 70.7%, 50%, 25%</p> <p>Magnification error of Direct (100%)</p> <ul style="list-style-type: none"> • Vertical: ±0.80% • Horizontal: ±0.90% <p>Zoom</p> <p>25% to 400% (in 1% increments)</p>
<p>Paper Feeding System/Capacity</p>	<p>Paper Drawer 1 / Paper Drawer 2</p> <p>550 sheets (80 g/m² / 75 g/m²)/640 sheets (64 g/m²)*⁵</p> <p>Multi-Purpose Tray</p> <p>100 sheets (80 g/m² / 75 g/m²)/120 sheets (64 g/m²)*⁶</p>
<p>Inner Tray Output Capacity</p>	<p>1-Sided Printing</p> <ul style="list-style-type: none"> • A4, B5, B5R, A5, A5R, A6R, LTR, STMT, STMT, and 16K: 250 sheets (80 g/m² / 75 g/m² / 64 g/m²) • 305 mm x 457 mm, 320 mm x 450 mm (SRA3), A3, B4, A4R, 11" x 17", LGL, LTRR, EXEC, 8K, and 16KR: 100 sheets (80 g/m² / 75 g/m² / 64 g/m²) <p>2-Sided Printing</p>

About the Machine

	<ul style="list-style-type: none"> • A4, B5, B5R, A5, A5R, A6R, LTR, STMT, STMT, and 16K: 200 sheets (80 g/m² / 75 g/m² / 64 g/m²) • 305 mm x 457 mm, 320 mm x 450 mm (SRA3), A3, B4, A4R, 11" x 17", LGL, LTRR, EXEC, 8K, and 16KR: 100 sheets (80 g/m² / 75 g/m² / 64 g/m²)
Multiple Copies	999 sheets
Power Source	220 V - 240 V AC, 50/60 Hz, 5 A
Power Consumption	<p>Maximum Power Consumption</p> <p>1,500 W</p> <p>When the machine is in the Sleep mode</p> <p>0.8 W (When <Sleep Mode Energy Use> is set to <Low>)</p> <p>When the main power switch is turned OFF</p> <ul style="list-style-type: none"> • When <Quick Startup Settings for Main Power> is set to <Off>: 0.3 W • When <Quick Startup Settings for Main Power> is set to <On>: 0.4 W
Dimensions (W x D x H)	<p>When the Single Pass DADF-C is attached:</p> <p>565 mm x 722 mm x 897 mm</p> <p>When the DADF-BA is attached:</p> <p>565 mm x 719 mm x 891 mm</p> <p>When the Platen Cover-Y is attached:</p> <p>565 mm x 692 mm x 788 mm</p>
Weight (Toner bottle excluded)	<p>When the Single Pass DADF-C is attached:</p> <p>Approximately 81.6 kg</p> <p>When the DADF-BA is attached:</p> <p>Approximately 75.1 kg</p> <p>When the Platen Cover-Y is attached:</p> <p>Approximately 68.7 kg</p>
Maximum Occupancy Space (W x D)	<p>When the Single Pass DADF-C is attached:</p> <p>894 mm x 722 mm</p> <p>When the DADF-BA is attached:</p> <p>894 mm x 719 mm</p> <p>When the Platen Cover-Y is attached:</p> <p>894 mm x 692 mm</p> <p>* When the multi-purpose tray is extended.</p>
Memory Capacity	<p>RAM</p> <p>3.5 GB (Main CPU: 2 GB, Image processing CPU: 1 GB + 0.5 GB (reserved for image processing))</p> <p>Storage Disk</p> <ul style="list-style-type: none"> • Standard: 256 GB • Maximum: 1 TB*7
Environmental Conditions	<p>Temperature: 10 °C to 30 °C</p> <p>Humidity: 20 % to 80 % RH (no condensation)</p>

About the Machine

*1 When using the <Fax>, <Scan and Send>, or <Scan and Store> function, you can scan the originals up to 301 mm x 424 mm (A3+) or 283.4 mm x 435.8 mm (11x17+).

*2 Activation time may vary, depending on the environment and conditions under which the machine is being used.

*3 It takes 4 seconds until the key operation on the touch panel display is available. Depending on the situations, the machine does not startup quickly.

*4 The speed on A4 size plain paper on one-side printing is measured during continuous copying. The speed vary depending on the output resolution, and the paper type and size. The speed on smaller paper sizes may be slower. Plus, the machine may experience downtime or decrease the speed in the middle of a continuous copy run to adjust the temperature inside the machine or maintain the optimal print quality.

*5 Transparencies: Up to 100 sheets

Vertically placed envelopes: Up to 25 envelopes in paper drawer 1 or up to 45 mm in height in paper drawer 2

*6 One sheet for coated paper (106 g/m² to 300 g/m²). Up to 10 envelopes. The height for thin paper, heavy paper, bond paper, tracing paper, labels, postcards and transparencies is 11 mm or less.

*7 Optional

2-Sided Single Pass Feeder (Single Pass DADF-C)

961F-0YR

The Single Pass DADF-C is an optional product.

Original Feeding Mechanism	Automatic Document Feeder
Original Size/Type	<p>Size of Originals</p> <ul style="list-style-type: none"> • Max: 304.8 mm x 431.8 mm*¹ • Min: 69.9 mm x 139.7 mm <p>Weight of Originals</p> <ul style="list-style-type: none"> • A/B Series: 38 g/m² to 220 g/m²*²*³ • Inch Series: 50 g/m² to 220 g/m²*³ <p>Automatically Detectable Sizes of Original</p> <p>A3, A4, B4, B5, A4R, A5, B5R, B6R, A5R, A6R</p> <p>The combinations of document sizes that you can copy/scan *⁴</p> <ul style="list-style-type: none"> • Documents with the same width: A3 and A4, A4R and A5
Original Tray Capacity	<ul style="list-style-type: none"> • 250 sheets (64 g/m²) (height 22.0 mm or less)*⁵ • 200 sheets (80 g/m² / 75 g/m²) (height 22.0 mm or less)*⁵
Original Scanning Speed (A4)	<p>1-sided Scanning</p> <p>Scanning (300 dpi x 300 dpi) *⁶</p> <ul style="list-style-type: none"> • Full Color: 135 pages/minute • Black-and-White: 135 pages/minute <p>Copying (600 dpi x 600 dpi)</p> <ul style="list-style-type: none"> • Full Color: 80 pages/minute • Black-and-White: 80 pages/minute <p>2-sided Scanning</p> <p>Scanning (300 dpi x 300 dpi) *⁶</p> <ul style="list-style-type: none"> • Full Color: 270 pages/minute • Black-and-White: 270 pages/minute <p>Copying (600 dpi x 600 dpi)</p> <ul style="list-style-type: none"> • Full Color: 90 pages/minute • Black-and-White: 160 pages/minute
Dimensions (W x D x H)	565 mm x 544 mm x 145 mm
Weight	Approximately 14.7 kg

*1 Long Original: 431.8 mm to 990 mm (only one original for one-sided scanning)

*2 The weights for A6R size or smaller originals are 50 g/m² to 220 g/m².

*3 The same also applies when color and black and white are both used.

About the Machine

*4 Copying/scanning with a combination other than described above may cause damage to the documents or paper jams.

*5 Up to 100 sheets for A6R size or smaller

*6 The scanning speed may vary, depending on the scanning mode and original type.

2-Sided Double Pass Feeder (DADF-BA)

961F-OYS

The DADF-BA is an optional product.

Original Feeding Mechanism	Automatic Document Feeder
Original Size/Type	<p>Size of Originals</p> <ul style="list-style-type: none"> • Max: 297.0 mm x 431.8 mm*¹ • Min: 139.7 mm x 128.0 mm <p>Weight of Originals</p> <p>Full Color:</p> <ul style="list-style-type: none"> • 1-sided/2-sided Scanning: 64 g/m² to 128 g/m² <p>Black-and-White:</p> <ul style="list-style-type: none"> • 1-sided Scanning (A/B Series): 42 g/m² to 128 g/m²*² • 1-sided Scanning (Inch Series): 50 g/m² to 128 g/m² • 2-sided Scanning: 50 g/m² to 128 g/m² <p>Long Original:</p> <ul style="list-style-type: none"> • 1-sided Scanning: 60 g/m² to 90 g/m²*³ <p>Automatically Detectable Sizes of Original</p> <p>A3, A4, B4, B5, A4R, A5, B5R, B6, A5R</p> <p>The combinations of document sizes that you can copy/scan *⁴</p> <ul style="list-style-type: none"> • Documents with the same width: A3 and A4, A4R and A5
Original Tray Capacity	<ul style="list-style-type: none"> • 100 sheets (80 g/m² / 75 g/m² / 64 g/m²) (height 10 mm or less) • 10 sheets (39 g/m² to 49 g/m²) • 1 sheet (38 g/m²)
Original Scanning Speed (A4)	<p>1-sided Scanning</p> <p>Scanning (300 dpi x 300 dpi) *⁵</p> <ul style="list-style-type: none"> • Full Color: 70 pages/minute • Black-and-White: 70 pages/minute <p>Copying (600 dpi x 600 dpi)</p> <ul style="list-style-type: none"> • Full Color: 51 pages/minute • Black-and-White: 51 pages/minute <p>2-sided Scanning</p> <p>Scanning (300 dpi x 300 dpi) *⁵</p> <ul style="list-style-type: none"> • Full Color: 35 pages/minute • Black-and-White: 35 pages/minute <p>Copying (600 dpi x 600 dpi)</p> <ul style="list-style-type: none"> • Full Color: 25.5 pages/minute • Black-and-White: 25.5 pages/minute
Dimensions	565 mm x 540 mm x 139 mm

About the Machine

(W x D x H)	
Weight	Approximately 8.2 kg

*1 Long Original: 431.8 mm to 630.0 mm (only one original for one-sided scanning)

*2 Originals weighing from 38 g/m² to 128 g/m² are supported when scanning a single original.

*3 Place only one original at a time.

*4 Copying/scanning with a combination other than described above may cause damage to the documents or paper jams.

*5 The scanning speed may vary, depending on the scanning mode and original type.

Available Paper

961F-0YU

The paper types that can be used with this machine are shown in the following table. For available paper with options attached, see the specifications of respective options. Also, confirm the precautions regarding paper use.

- ▶ Supported Paper Sizes(P. 224)
- ▶ Supported Paper Types(P. 228)
- ▶ Precautions Regarding Paper(P. 231)
- ▶ Unusable Paper(P. 231)
- ▶ Storing Paper Printed With the Machine(P. 231)

Supported Paper Sizes

Paper Sizes	Paper Source (Standard)			Paper Source (Optional)
	Paper Drawer 1	Paper Drawer 2	Multi-Purpose Tray	Cassette Feeding Unit-AW
A4	✓	✓	✓	✓
A4R	-	✓	✓	✓
A3	-	✓	✓	✓
A5	✓	✓	✓	✓
A5R	✓	✓	✓	✓
A6R	✓	✓	✓	✓
B4	-	✓	✓	✓
B5	✓	✓	✓	✓
B5R	-	✓	✓	✓
305x457 mm	-	✓	✓	✓
320x450 mm (SRA3)	-	-	✓	-
16K	✓	✓	✓	✓
16KR	-	✓	✓	✓
8K	-	✓	✓	✓

About the Machine

Paper Sizes	Paper Source (Standard)			Paper Source (Optional)
	Paper Drawer 1	Paper Drawer 2	Multi-Purpose Tray	Cassette Feeding Unit-AW
LTR	✓	✓	✓	✓
LTRR	-	✓	✓	✓
LGL	-	✓	✓	✓
11x17	-	✓	✓	✓
STMT	-	-	✓	-
STMTR	✓	✓	✓	✓
EXEC	✓	✓	✓	✓
Free Size (98.4 mm x 139.7 mm to 320 mm x 457.2 mm)	-	-	✓	-
Custom Size (98.4 mm x 139.7 mm to 320 mm x 457.2 mm)	✓*1	✓*2	✓	✓*2
No.10 (COM10)	-	✓	✓	-
ISO-C5	✓	-	✓	-
DL	-	✓	✓	-
Monarch	-	✓	✓	-
Nagagata 3	✓	✓	✓	-
Yougatanaga 3	✓	✓	✓	-
Kakugata 2	-	✓	✓	-
Custom Size (Envelope)	-	-	✓*3	-

*1 You can use custom size settings ranging from 105.0 mm x 148.0 mm to 297.0 mm x 215.9 mm.

*2 You can use custom size settings ranging from 105.0 mm x 148.0 mm to 304.8 mm x 457.2 mm.

*3 You can use custom size settings ranging from 98.0 mm x 98.0 mm to 320.0 mm x 457.2 mm.

NOTE

Paper sizes supported by this machine

- The following table shows most of the sizes of paper and envelope that can be used with the machine.

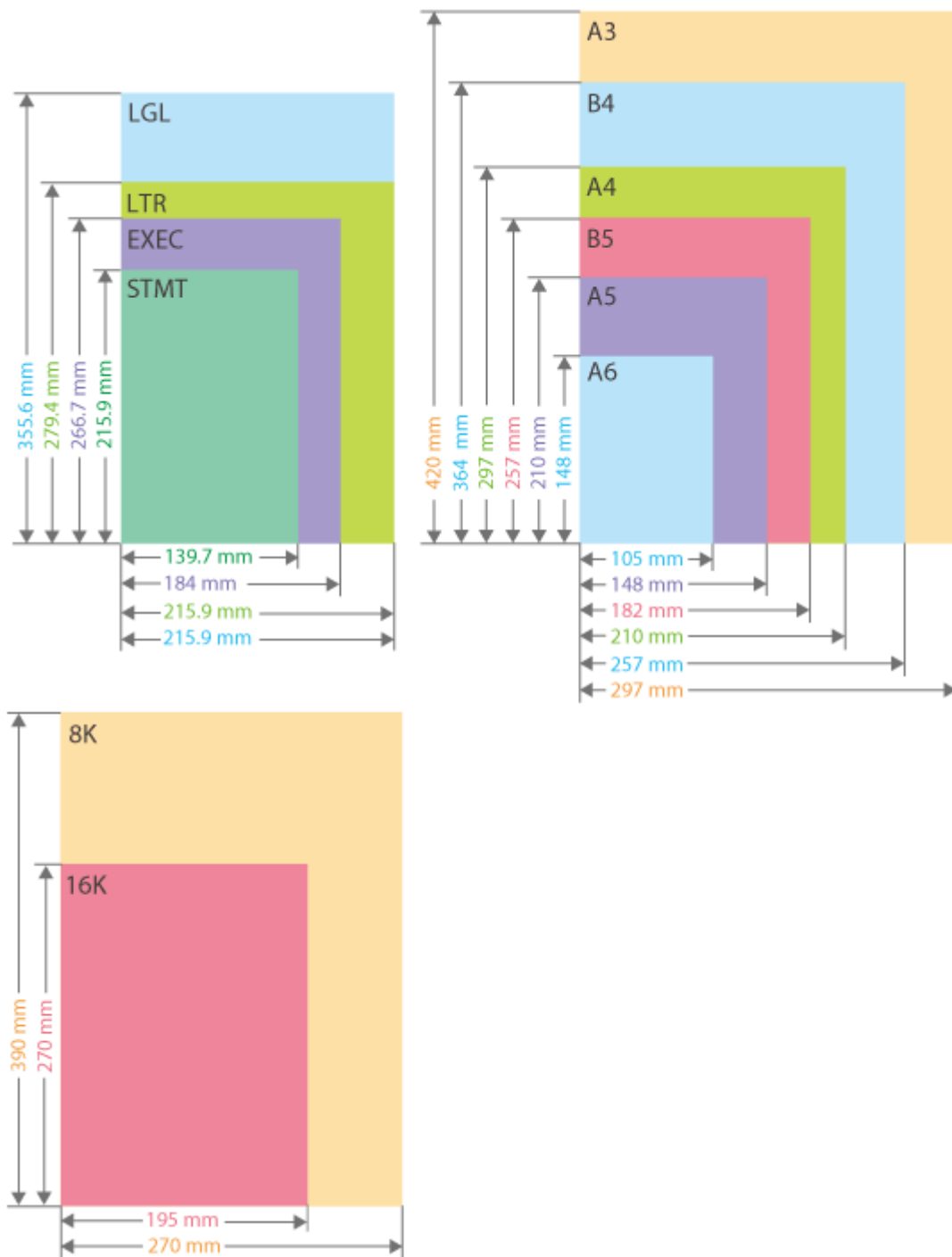

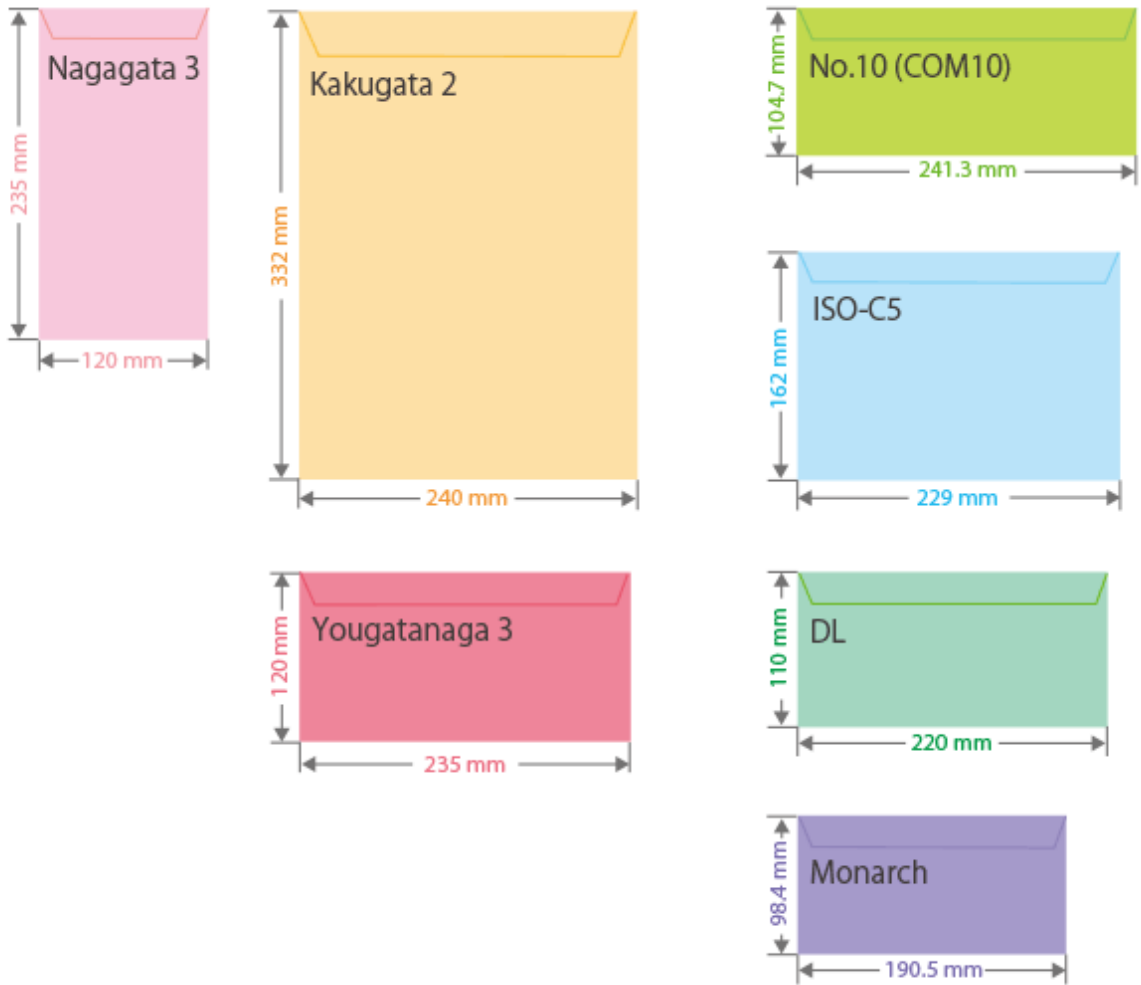

- Other supported paper sizes are as follows.

305 mm x 457 mm

320 mm x 450 mm (SRA3)

11" x 17" (279.4 mm x 431.8 mm)

"Vertical" side and "Horizontal" side of paper

- In the User's Guide, regardless of the paper orientation, the side of paper perpendicular (a) to the front of the machine is referred to as the "vertical" side while the side parallel (b) to the front of the machine is referred to as the "horizontal" side.

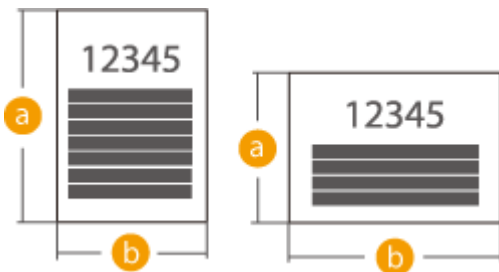

- In the User's Guide, loading paper with the longer side perpendicular to the front of the machine is referred to as placing in "portrait orientation" while loading paper with the longer side horizontal to the front of the machine is referred to as placing in "landscape orientation."

Portrait orientation

Landscape orientation



- "A4R," "A5R," "B5R," "LTRR," and "STMTR" refer to A4 / A5 / B5 / LTR / STMT size paper placed in landscape orientation, respectively.

Supported Paper Types

Chlorine-free paper can be used with this machine.

Paper Type	Paper Weight	Paper Source (Standard)			Paper Source (Optional)
		Paper Drawer 1	Paper Drawer 2	Multi-Purpose Tray	Cassette Feeding Unit-AW
Thin 2	52 to 59 g/m ²	✓	✓	✓ ^{*1}	✓
Thin 1	60 to 63 g/m ²	✓	✓	✓	✓
Plain 1	64 to 75 g/m ²	✓	✓	✓	✓
Plain 2	76 to 90 g/m ²	✓	✓	✓	✓
Plain 3	91 to 105 g/m ²	✓	✓	✓	✓
Heavy 1	106 to 128 g/m ²	✓	✓	✓	✓
Heavy 2	129 to 150 g/m ²	✓	✓	✓	✓
Heavy 3	151 to 163 g/m ²	✓	✓	✓	✓
Heavy 4	164 to 180 g/m ²	✓	✓	✓	✓
Heavy 5	181 to 220 g/m ²	✓	✓	✓	✓
Heavy 6	221 to 256 g/m ²	✓	✓	✓	✓
Heavy 7	257 to 300 g/m ²	-	-	✓	-
Recycled 1 ^{*2}	64 to 75 g/m ²	✓	✓	✓	✓
Recycled 2 ^{*2}	76 to 90 g/m ²	✓	✓	✓	✓

About the Machine

Paper Type	Paper Weight	Paper Source (Standard)			Paper Source (Optional)
		Paper Drawer 1	Paper Drawer 2	Multi-Purpose Tray	Cassette Feeding Unit-AW
Recycled 3 ^{*2}	91 to 105 g/m ²	✓	✓	✓	✓
Pre-punched 1	64 to 75 g/m ²	✓	✓	✓	✓
Pre-punched 2	76 to 90 g/m ²	✓	✓	✓	✓
Transparency ^{*3}	121 to 220 g/m ²	✓	✓	✓	✓
Labels	118 to 185 g/m ²	-	-	✓	-
Color	64 to 82 g/m ²	✓	✓	✓	✓
Bond	83 to 99 g/m ²	✓	✓	✓	✓
Tracing ^{*4}	64 to 99 g/m ²	-	-	✓	-
1-Sided Coated 1 ^{*4}	106 to 128 g/m ²	-	-	✓	-
1-Sided Coated 2 ^{*4}	129 to 163 g/m ²	-	-	✓	-
1-Sided Coated 3 ^{*4}	164 to 220 g/m ²	-	-	✓	-
1-Sided Coated 4 ^{*4}	221 to 256 g/m ²	-	-	✓	-
1-Sided Coated 5 ^{*4}	257 to 300 g/m ²	-	-	✓ ^{*5}	-
2-Sided Coated 1 ^{*4}	106 to 128 g/m ²	-	-	✓	-
2-Sided Coated 2 ^{*4}	129 to 163 g/m ²	-	-	✓	-
2-Sided Coated 3 ^{*4}	164 to 220 g/m ²	-	-	✓	-
2-Sided Coated 4 ^{*4}	221 to 256 g/m ²	-	-	✓	-
2-Sided Coated 5 ^{*4}	257 to 300 g/m ²	-	-	✓ ^{*5}	-
Letterhead 1	64 to 75 g/m ²	✓	✓	✓	✓
Letterhead 2	76 to 90 g/m ²	✓	✓	✓	✓
Letterhead 3	91 to 105 g/m ²	✓	✓	✓	✓

Paper Type	Paper Weight	Paper Source (Standard)			Paper Source (Optional)
		Paper Drawer 1	Paper Drawer 2	Multi-Purpose Tray	Cassette Feeding Unit-AW
Letterhead 4	106 to 128 g/m ²	✓	✓	✓	✓
Letterhead 5	129 to 150 g/m ²	✓	✓	✓	✓
Letterhead 6	151 to 163 g/m ²	✓	✓	✓	✓
Letterhead 7	164 to 180 g/m ²	✓	✓	✓	✓
Envelope	75 to 105 g/m ²	✓	✓	✓	-
Postcard	164 to 220 g/m ²	✓	✓	✓	✓

*1 Not available when the optional Media Adjustment kit-A is attached.

*2 You can use 100% recycled paper.

*3 You can use A4 or LTR transparencies.

*4 When loading this type of paper in the multi-purpose tray, load only one sheet at a time.

*5 The optional Media Adjustment kit-A is required.

■ Paper Available for 2-Sided Copying/2-Sided Printing

- When performing 2-sided copying or 2-sided printing, use paper that meets the following requirements.

Paper size: 305 mm x 457 mm, A3, B4, A4, A4R, B5, B5R, A5R, 11" x 17", LGL, LTR, LTRR, STMT, EXEC, 8K, 16KR, 16K, and Custom Size (139.7 mm x 182 mm to 304.8 mm x 457.2 mm)

Paper type: Thin 1 to Thin 2, Plain 1 to Plain 3, Heavy 1 to Heavy 5, Color, Recycled 1 to Recycled 3, Pre-Punched 1 to Pre-Punched 2, Bond, and Letterhead 1 to Letterhead 7

Paper weight: 52 g/m² to 220 g/m²

If using other paper, use <2nd Side of 2-Sided Page> to copy/print on the back side of printed paper.

■ Paper Not Available for Finishing

- Finishing functions are not available when making copies or printing on A5R-, A6R-, STMT-, STMT-, 305 mm x 457 mm, 320.0 mm x 450.0 mm (SRA3), free size paper, transparencies, tracing paper, labels, envelope or postcards.

■ Using Heavy Paper for the Booklet Mode

- If you set Heavy 6 for cover on <Booklet>, you cannot use the settings other than <Front Inside Cover> and <Back Inside Cover> to make copies or print.

■ Automatically Detectable Paper Sizes

- Paper drawers 1: A4, B5, A5, A5R, LTR, STMTR, EXEC, 16K
- Paper drawers 2: 305 mm x 457 mm, A3, B4, A4R, A4, B5R, B5, A5, A5R, A6R, 11" x 17", LGL, LTR, LTRR, STMTR, EXEC, 8K, 16KR, 16K
- Cassette Feeding Unit-AW: 305 mm x 457 mm, A3, B4, A4R, A4, B5R, B5, A5, A5R, A6R, 11" x 17", LGL, LTR, LTRR, STMTR, EXEC, 8K, 16KR, 16K

Unusable Paper

- Before printing, check whether the paper to use is suitable. Do not use the following types of paper, as they can cause paper jams or printing errors:
- Wrinkled, creased, curled, torn, or damp paper*¹
- Thin straw paper, very thin paper, coarse paper, glossy paper
- Paper with glue or other adhesive sticking out or label paper whose back side can be easily peeled off
- Paper printed by a thermal transfer printer, back side of paper printed by a thermal transfer printer

*¹ Printing on damp paper may cause steam to be emitted from the output area or water droplets to adhere to the output part, but this does not indicate a malfunction. This is because the water contained in the paper evaporates due to the heat generated when the toner fixes to the paper. This is more likely to occur when the room temperature is low.

Precautions Regarding Paper

IMPORTANT

When using paper

- Only use paper that has fully acclimatized to the environment in which this machine is installed. Using paper that has been stored under different temperature or humidity may cause paper jams or result in poor print quality.

Paper handling and storage

- We recommend using the paper immediately after opening the package. Rewrap any remaining paper in its original package, and store it on a flat surface.
- Keep the paper wrapped in its original package to protect the paper from moisture or dryness.
- Do not store the paper in such a way that may cause it to curl or fold.
- Do not store the paper vertically or stack too much paper.
- Do not store the paper in direct sunlight, or in a place subject to high humidity, dryness, or drastic changes in temperature or humidity.

NOTE

When printing on paper that has absorbed moisture

- Steam may emit from the paper output area, or water droplets may form around the paper output area. There is nothing unusual about any of these occurrences, which occur when the heat generated from fixing toner on the paper causes moisture in the paper to evaporate (most likely to occur at low room temperatures).

Storing Paper Printed With the Machine

Be aware of the following precautions when handling and storing paper printed using the machine.

■ Storing Printed Paper

- Store the paper on a flat surface.
- Do not store paper together with items made from PVC (polyvinyl chloride), such as clear folders. The toner may melt, causing paper to become stuck to PVC-based material.
- Store paper so that it does not become folded or wrinkled. Doing so may cause the toner to come off.
- If you intend to store paper for long periods (two or more years), preserve them in a binder, etc.
- Long-term storage may cause paper to discolor, which in turn may cause print to appear discolored.
- Do not store paper in places with high temperatures.

■ Precautions when sticking printouts with adhesive

- Be sure to use insoluble adhesive.
- Test the adhesive on an unneeded printout before using.
- Before stacking printouts that stuck with adhesive, check that the adhesive completely dried.

Cassette Feeding Unit-AW

961F-039

Paper Size/Weight/Type	🔴 Available Paper(P. 224)
Paper Drawers Capacity	550 sheets (80 g/m ² / 75 g/m ²)/640 sheets (64 g/m ²)* x 2
Dimensions (W x D x H)	565 mm x 635 mm x 248 mm
Weight	Approximately 16.0 kg

* Up to 100 sheets for transparencies.



Media Adjustment kit-A

961F-03C

Paper Sizes	Max: 320 mm x 457.2 mm Min: 210 mm x 139.7 mm
Paper Weight	60 g/m ² to 300 g/m ²
Paper Type	Thin 1, Plain, Heavy, Recycled, 1-Sided Coated, 2-Sided Coated, Color, Pre-punched, Labels, Bond and Letterhead
Capacity	1 sheet

Inner Finisher-L

961F-03E

<p>Paper Sizes</p>	<p>Paper available for the Main Unit ( Supported Paper Sizes(P. 224))</p>
<p>Paper Weight</p>	<p>52 g/m² to 300 g/m²</p>
<p>Paper Type</p>	<p>Paper available for the Main Unit ( Supported Paper Types(P. 228))^{*1}</p>
<p>Capacity Per Tray ^{*2}</p>	<p>Upper Tray (Tray B)</p> <ul style="list-style-type: none"> ● 50 sheets (75 g/m² / 64 g/m²) (or 5.2 mm in height) ● 45 sheets (80 g/m²) (or 5.2 mm in height) <p>Lower Tray (Tray A)</p> <p>No Collating/Collate/Group mode:</p> <ul style="list-style-type: none"> ● A6R: 30 sheets ● A4, B5, A5, A5R, LTR, STMT, STMT, EXEC, and 16K: 500 sheets (or 52 mm in height) ● 320 mm x 450 mm (SRA3), 305 mm x 457 mm, A3, B4, A4R, B5R, 11" x 17", LGL, LTRR, 8K, and 16KR: 250 sheets or height 26 mm ● Envelopes: 10 sheets <p>No Collating/Collate/Group mode with different paper sizes:</p> <ul style="list-style-type: none"> ● Combination of A4, B5, and LTR: 500 sheets (or 52 mm in height) ● All other combinations: 250 sheets or height 26 mm <p>Collate + Offset and Group + Offset mode:</p> <ul style="list-style-type: none"> ● A4, B5, LTR, EXEC, and 16K: 500 sheets (or 52 mm in height) ● A3, B4, A4R, 11" x 17", LGL, LTRR, and 8K: 250 sheets or height 26 mm <p>Staple (Corner/Double) mode:</p> <ul style="list-style-type: none"> ● A4, B5, LTR, EXEC, and 16K: 30 sets or height 52 mm ● A3, B4, A4R, 11" x 17", LGL, LTRR, and 8K: 30 sets or height 26 mm <p>Staple (Eco) mode:</p> <ul style="list-style-type: none"> ● A4, B5, LTR, and 16K: 30 sets or height 52 mm ● A3, B4, 11" x 17", and 8K: 30 sets or height 26 mm
<p>Staple</p>	<p>Paper Weight</p> <p>52 g/m² to 256 g/m²</p> <p>Max. Stapling Capacity ^{*3}</p> <p>Staple (Corner/Double) ^{*4}:</p> <ul style="list-style-type: none"> ● A4, B5, LTR, EXEC, and 16K: 50 sheets (52 g/m² to 90 g/m²) 30 sheets (91 g/m² to 105 g/m²) 2 sheets (106 g/m² to 256 g/m²) ● A4R and LTRR: 40 sheets (52 g/m² to 90 g/m²) 30 sheets (91 g/m² to 105 g/m²) 2 sheets (106 g/m² to 256 g/m²) ● A3, B4, 11" x 17", LGL, and 8K:

About the Machine

	<p>30 sheets (52 g/m² to 90 g/m²) 20 sheets (91 g/m² to 105 g/m²) 2 sheets (106 g/m² to 256 g/m²)</p> <p>Staple (Eco):</p> <ul style="list-style-type: none"> • All sizes: 10 sheets (52 g/m² to 64 g/m²) 8 sheets (65 g/m² to 81.4 g/m²) 6 sheets (82 g/m² to 105 g/m²) <p>Manual Staple *5:</p> <ul style="list-style-type: none"> • All sizes: About 50 sheets (52 g/m²) About 45 sheets (64 g/m²) About 40 sheets (80 g/m² / 75 g/m²)
Punching (When the inner puncher unit is attached)	<p>Paper Sizes</p> <p>Two/Four Holes:</p> <ul style="list-style-type: none"> • Two Holes: A3, B4, A4, A4R, B5, B5R, A5, 11" x 17", LGL, LTR, LTRR, EXEC, 8K, 16K, and 16KR • Four Holes: A3, A4, 11" x 17", LTR, EXEC, 8K, and 16K <p>Four Holes:</p> <ul style="list-style-type: none"> • Four Holes: A3, B4, A4, A4R, B5, B5R, A5, 11" x 17", LGL, LTR, LTRR, EXEC, 8K, 16K, and 16KR <p>Paper Weight</p> <p>52 g/m² to 300 g/m²</p> <p>Punch Hole</p> <p>Two/Four Holes or Four Holes</p>
Dimensions (W x D x H)	469 mm x 525 mm x 225 mm
Weight	Approximately 9.1 kg (Approximately 13.3 kg (when the inner puncher unit is attached))

*1 Lower tray (Tray A): Excluding Thin 2 (two-sided printed), Heavy 7 (with width of 216 mm or more), 1-Sided Coated 5 (with width of 216 mm or more), and 2-Sided Coated 5 (with width of 216 mm or more)

*2 For 80 g/m² / 75 g/m² / 64 g/m² paper only. Capacity varies in other cases.



*3 When the standard staple cartridge is attached. (The maximum stapling capacity may vary, depending on the paper type and weight.)

*4 Up to 2 sheets for coated paper

*5 The thickness of the paper is 4.0 mm or less.

Staple Finisher-AE / Booklet Finisher-AE

961F-03F

Paper Sizes	Paper available for the Main Unit ( Supported Paper Sizes(P. 224))
Paper Weight	52 g/m ² to 300 g/m ²
Paper Type	Paper available for the Main Unit ( Supported Paper Types(P. 228)) ^{*1}
Capacity Per Tray ^{*2}	<p>Upper Tray (Tray A)</p> <p>No Collating/Collate/Group mode:</p> <ul style="list-style-type: none"> ● A4, B5, A5, A5R, A6R, LTR, STMT, STMTR, EXEC, and 16K: 250 sheets (or 47 mm in height) ● A3, B4, A4R, B5R, 320 mm x 450 mm (SRA3), 11" x 17", 305 mm x 457 mm, LGL, LTRR, 8K, and 16KR: 125 sheets (or 24 mm in height)^{*3} <p>No Collating/Collate/Group mode with different paper sizes:</p> <ul style="list-style-type: none"> ● Combination of A4, and B5, LTR: 250 sheets (or 47 mm in height) ● All other combinations: 125 sheets (or 24 mm in height)^{*4} <p>Collate + Offset, Group + Offset mode:</p> <ul style="list-style-type: none"> ● A4, B5, LTR, EXEC, and 16K: 250 sheets (or 47 mm in height) ● A3, B4, 11" x 17", and 8K: 125 sheets (or 24 mm in height) <p>Lower Tray (Tray B)</p> <p>No Collating/Collate/Group mode:</p> <ul style="list-style-type: none"> ● A6R : 250 sheets (52 g/m² to 105 g/m²)/50 sheets (106 g/m² to 300 g/m²) ● A4, B5, A5, A5R, LTR, STMT, STMTR, EXEC and 16K: 3,000 sheets or height 423 mm^{*5} ● A3, B4, A4R, B5R, 320 mm x 450 mm (SRA3), 305 mm x 457 mm, 11" x 17", LGL, LTRR, 8K, and 16KR: 1,500 sheets or height 216 mm ● Envelopes: 100 sheets^{*6} <p>No Collating/Collate/Group mode with different paper sizes:</p> <ul style="list-style-type: none"> ● Combinations including A6R : 250 sheets (52 g/m² to 105 g/m²)/50 sheets (106 g/m² to 300 g/m²) ● Combination of A4, B5, and LTR: 3,000 sheets (or 423 mm in height) ● All other combinations: 1,500 sheets (or 216 mm in height) <p>Collate + Offset and Group + Offset mode:</p> <ul style="list-style-type: none"> ● A4, B5, LTR, EXEC, and 16K: 3,000 sheets or height 423 mm^{*5} ● A3, B4, A4R, 11" x 17", LGL, LTRR, and 8K: 1,500 sheets or height 216 mm <p>Staple (Corner/Double):</p> <ul style="list-style-type: none"> ● A4, B5, LTR, EXEC, and 16K: 200 sets/total 3,000 sheets (or 423 mm in height)^{*4} ● A3, B4, A4R, 11" x 17", LGL, LTRR and 8K: 100 sets/total 1,500 sheets (or 216 mm in height) <p>Staple-Free (Eco):</p> <ul style="list-style-type: none"> ● A4, LTR, and 16K: 200 sets ● A3, 11" x 17", and 8K: 100 sets

<p>Booklet Tray Capacity (Booklet Finisher-AE only)*7</p>	<ul style="list-style-type: none"> ● Paper from 52 g/m² to 81.4 g/m² in weight: 25 sets (2 sheets to 5 sheets) 15 sets (6 sheets to 10 sheets) 10 sets (11 sheets to 20 sheets) ● Paper from 82 g/m² to 105 g/m² in weight: 25 sets (2 sheets to 5 sheets) 15 sets (6 sheets to 10 sheets) ● Paper from 106 g/m² to 220 g/m² in weight: 10 sets (2 sheets to 5 sheets)
<p>Staple</p>	<p>Paper Weight 52 g/m² to 256 g/m²</p> <p>Max. Stapling Capacity *8</p> <p>Staple (Corner/Double) *9:</p> <ul style="list-style-type: none"> ● A4, B5, LTR, EXEC, and 16K: 50 sheets (52 g/m² to 90 g/m²) 30 sheets (91 g/m² to 105 g/m²) 2 sheets (106 g/m² to 256 g/m²) ● A4R and LTRR: 40 sheets (52 g/m² to 90 g/m²) 30 sheets (91 g/m² to 105 g/m²) 2 sheets (106 g/m² to 256g /m²) ● A3, B4, 11" x 17", LGL, and 8K: 30 sheets (52 g/m² to 90 g/m²) 25 sheets (91 g/m² to 105 g/m²) 2 sheets (106 g/m² to 256 g/m²) <p>Staple (Eco): 10 sheets (52 g/m² to 64 g/m²) 8 sheets (65 g/m² to 81.4 g/m²) 6 sheets (82 g/m² to 105 g/m²)</p> <p>Manual Staple: 50 sheets*¹⁰</p>
<p>Punch (When the puncher unit is attached)</p>	<p>Paper Sizes</p> <p>Two/Four Holes:</p> <ul style="list-style-type: none"> ● Two Holes: A3, B4, A4, A4R, B5, B5R, A5, 11" x 17", LGL, LTR, LTRR, EXEC, 8K, 16K, and 16KR ● Four Holes: A3, A4, 11" x 17", LTR, EXEC, 8K, and 16K <p>Four Holes: A3, B4, A4, A4R, B5, B5R, A5, 11" x 17", LGL, LTR, LTRR, EXEC, 8K, 16K, and 16KR</p> <p>Paper Weight 52 g/m² to 300 g/m²</p> <p>Punch Hole Two/Four Holes or Four Holes</p>
<p>Saddle Stitch/Fold (Booklet Finisher-AE only)</p>	<p>Paper Sizes A3, B4, A4R, 305 mm x 457 mm, 11" x 17", LGL, LTRR</p> <p>Paper Weight</p>

About the Machine

	<p>Text Weight: 52 g/m² to 220 g/m²</p> <p>Cover Weight: 52 g/m² to 256 g/m²*11</p> <p>Max. Saddle Stitching Capacity (excluding coated paper) *12</p> <ul style="list-style-type: none"> ● 20 sheets (52 g/m² to 81.4 g/m²) ● 10 sheets (82 g/m² to 105 g/m²) ● 5 sheets (106 g/m² to 150 g/m²) ● 4 sheets (151 g/m² to 209 g/m²) ● 3 sheets (210 g/m² to 220 g/m²) <p>Max. Saddle Folding Capacity *13</p> <ul style="list-style-type: none"> ● 3 sheets (52 g/m² to 105 g/m²) ● 1 sheet (106 g/m² to 256 g/m²)
Dimensions (W x D x H)	537 mm x 623 mm x 974 mm *14
Weight	<p>Staple Finisher-AE</p> <p>Approximately 30.0 kg</p> <p>Booklet Finisher-AE</p> <p>Approximately 53.0 kg</p>

*1 Upper tray (Tray A): Excluding Thin 2 (two-sided printed) and paper with a weight of 257 g/m² or more
 Lower tray (Tray B): Excluding Thin 2 (two-sided printed)

*2 For 80 g/m² / 75 g/m² / 64 g/m² paper only. Capacity varies in other cases.

*3 Thin paper (52 g/m² to 63 g/m²): 30 sheets (320 x 450 mm (SRA3) and 305 x 457 mm only)

*4 30 sheets (320 x 450 mm (SRA3) and 305 x 457 mm only)

*5 Thin paper (52 g/m² to 63 g/m²): 1,500 sheets (or 216 mm in height)

*6 Monarch: 30 sheets

*7 Up to 10 sets if the setting is for the cover

*8 When the standard staple cartridge is attached. (The maximum stapling capacity may vary, depending on the paper type and weight.)

*9 Up to 2 sheets for coated paper

*10 The thickness of the paper is 5.7 mm or less.

*11 For the cover, use a paper that is at least as heavy as the paper used for the text.

*12 Including 1 cover sheet up to 256 g/m²

*13 Up to 1 sheet for coated paper

*14 When this optional equipment is attached to the main unit or another optional equipment, there will be a gap of +5 mm in the horizontal direction.

Inner 2way Tray-M

961F-03H

Paper Sizes	Paper available for the Main Unit (Supported Paper Sizes(P. 224))
Paper Weight	52 g/m ² to 300 g/m ²
Paper Type	Paper available for the Main Unit (Supported Paper Types(P. 228))
Capacity	<p>A4, B5, B5R, A5, A5R, A6R, LTR, STMT, STMTR, and 16K: 100 sheets (80 g/m² / 75 g/m² / 64 g/m²)</p> <p>305 x 457 mm, 320 x 450 mm (SRA3), A3, B4, A4R, 11" x 17", LGL, LTRR, EXEC, 8K, and 16KR: 50 sheets (80 g/m² / 75 g/m² / 64 g/m²)</p>
Dimensions (W x D x H)	428 mm x 405 mm x 88 mm
Weight	Approximately 0.7 kg

Copy Tray-T

961F-03J

Paper Sizes	Max: 297.0 mm x 431.8 mm Min: 98.0 mm x 182.0 mm
Paper Weight	52 g/m ² to 220 g/m ²
Paper Type	Thin, Plain, Recycled, Color, Pre-Punched, Heavy 1 to 5, Bond, and Letterhead
Capacity	A4, B5, B5R, A5R, LTR, STMTR, and 16K: 100 sheets (80 g/m ² / 75 g/m ² / 64 g/m ²) A3, B4, A4R, 11" x 17", LGL, LTRR, EXEC, 8K, and 16KR: 75 sheets (80 g/m ² / 75 g/m ² / 64 g/m ²)
Dimensions (W x D x H)	258 mm x 373 mm x 103 mm ^{*1}
Weight	Approximately 0.5 kg

*1 When this optional equipment is attached to the main unit or another optional equipment, there will be a gap of +5 mm in the horizontal direction.

Copy Card Reader

961F-03K

Available Cards	Magnetic
Card Readout Method	Magnetic readout
Magnetic Card Reading Direction	Insertion direction
Store/Replay	Replay
Dimensions (W x D x H)	88 mm x 96 mm x 40 mm (excluding the attachment kit and cable)
Weight	Approximately 200 g (including the attachment kit and cable)

Setting Up

Setting Up	245
Preparations Required Before Use	246
Preventing Unauthorized Access	248
Setting up Using the Setup Guide	250
Logging in as an Administrator	259
Setting the Date/Time	261
Setting up the Network Environment	263
Canceling the Network Setting Lock	266
Selecting the Network Connection Method	267
Connecting to a Wired LAN	269
Connecting to a Wireless LAN	270
Setting Up the Connection Using WPS Push Button Mode	272
Setting Up the Connection Using WPS PIN Code Mode	273
Setting Up Connection by Selecting a Wireless Router	274
Setting Up a Connection by Specifying Detailed Settings	275
Checking the SSID and Network Key	277
Setting an IP Address	278
Setting an IPv4 Address	279
Setting an IPv6 Address	281
Setting the IPv4 Address of the Sub Line	284
Adapting to the Network Environment	285
Making Ethernet Settings	286
Setting the Wait Time When Connecting to a Network	288
Making DNS Settings	289
Making SMB Settings	294
Making WINS Settings	297
Making WebDAV Settings	298
Registering the LDAP Server	299
Monitoring and Controlling via SNMP	303
Setting Static Routing	307
Other Network Settings	309
Configuring System Data Communication	311
Installing Drivers	313
Fax Line Settings	314
Setting E-mail/I-Fax Communication	316
Setting the Advanced Space of the Machine	320

Setting Advanced Space to Public	321
Connecting to the Other Devices	326

Setting Up

961F-03L

Setting up the usage environment is required before using each function of the machine. First, confirm the processes to complete "setting up" prior to actual setup. ▶ **Preparations Required Before Use(P. 246)**

■ Administrators and General Users

To manage the machine, it is recommended to construct a system in which someone is appointed as an administrator and general users operate the machine under the management of an administrator. Administrators decide the rules for using the machine and operate important setups such as networks and security. Administrators set the access for each user when necessary.

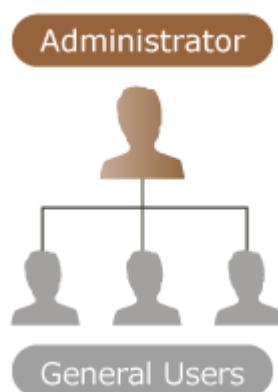

TIPS

Carrying out the initial setup of the machine (Setup Guide)

- You can easily set up to start using the machine, such as setting the date and time and networks, by following the on-screen instructions. ▶ **Setting up Using the Setup Guide(P. 250)**

Preparations Required Before Use

961F-03R

Set up the machine in order from steps 1 through 5. For details, click a link to display the corresponding pages. To use the machine safely, at the same time, confirm **Preventing Unauthorized Access(P. 248)** .

Step 1 [▶Setting up Using the Setup Guide\(P. 250\)](#)



Step 2 [▶Setting up the Network Environment\(P. 263\)](#)

- Set up the network environment not included on the Setup Guide. If you do not start the Setup Guide, start setting up from this procedure.



Step 3 [▶Installing Drivers\(P. 313\)](#)



Step 4 [▶Setting E-mail/I-Fax Communication\(P. 316\)](#)



Step 5 [▶Setting the Advanced Space of the Machine\(P. 320\)](#)



TIPS

Setting from the Remote UI

- When you complete setup for the network environment, you can set up the machine from Remote UI efficiently. [▶Starting the Remote UI\(P. 902\)](#)

Saving setup time by importing data from other machines

- If you have any other Canon multifunction printer and save (export) its registered setup data to a computer beforehand, setup contents such as address book and paper type setting can be immediately used by importing them to the machine.  **Importing/Exporting the Setting Data(P. 946)**

Preventing Unauthorized Access

961F-03S

This section describes preventive measures against unauthorized access from external networks. For administrators and users that are using the machine in a network environment, make sure to read this section before use. Connecting to networks enables you to use various functions such as printing, remote operation from a computer, sending scanned documents through the Internet, etc. However, for protection against unauthorized access from an external network, security measures are essential. This section describes some countermeasures against unauthorized access, which must be implemented before using the machine with a network environment.

- ▶ **Implementing Private IP Addresses(P. 248)**
- ▶ **Limiting Communication via a Firewall(P. 249)**
- ▶ **Setting up TLS Encryption Communication(P. 249)**
- ▶ **Managing the Machine's Information via Passwords(P. 249)**

Implementing Private IP Addresses

An IP address is a number that is assigned to a computer on a network. A "global IP address" is used for Internet connections. A "private IP address" is used for local area networks such as an office LAN. If your IP address is a global IP address, unauthorized users on the Internet can attempt to access your local network and risks such as information leakage become larger. If your address is a private address, only users on a local area network such as the office LAN have access.

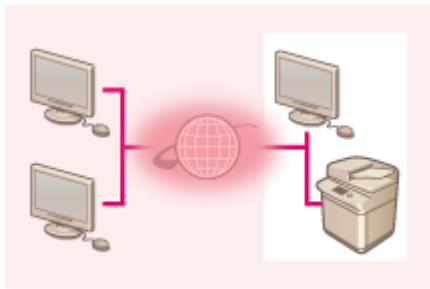

【Global IP address】

Accessible from outside your network

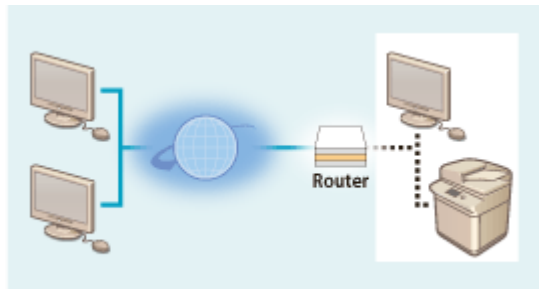

【Private IP address】

Accessible only from within a local area network

Generally, when setting up an IP address, use a private IP address. For a private IP address, any addresses in the following ranges can be used. Confirm if the IP address that is currently set is a private IP address.

■ Ranges of Private IP Addresses

- 10.0.0.0 to 10.255.255.255
- 172.16.0.0 to 172.31.255.255
- 192.168.0.0 to 192.168.255.255

For information on how to confirm IP addresses, see ▶ **Setting an IPv4 Address(P. 279)** .

NOTE

- Even if a global IP address is set for the machine, risk of unauthorized access can be reduced by using a firewall. Consult your network administrator when you want to operate the machine using a global IP address.

Limiting Communication via a Firewall

A firewall is a system that prevents unauthorized access from external networks in order to prevent attacks or invasion into the local area network. Access from outside your local network that has potential to be a risk can be shut out beforehand by limiting communication from a specific external IP address in your network environment. [▶Restricting Communication by Using Firewalls\(P. 854\)](#)

Setting up TLS Encryption Communication

For TLS communication, see [▶Starting the Remote UI\(P. 902\)](#) .

Managing the Machine's Information via Passwords

Even if the machine receives unauthorized access from a malicious third party, risk of information leakage can be greatly reduced when various information resources in the machine are protected by passwords.

Password for each function / PIN code setting

- Personal authentication management using User Authentication [▶Configuring the Personal Authentication Management Settings\(P. 806\)](#)
- PIN code setting for system management contents [▶Changing the System Manager ID and PIN\(P. 840\)](#)
- PIN code settings for accessing Address Book [▶Restricting Use of the Address Book\(P. 879\)](#)
- Authentication management for Advanced Space [▶Setting Advanced Space to Public\(P. 321\)](#)

These are examples of preventing unauthorized access. For other details, see [▶Managing the Machine\(P. 790\)](#) and carry out necessary settings according to your environment.

Setting up Using the Setup Guide

961F-03U

When the machine is turned ON for the first time (**Turning ON the Machine(P. 35)**), the initial setup of the machine begins automatically. You can adjust the basic setup necessary to use the machine. Configure the basic setup in accordance with each screen, or click a link to display the corresponding page and see details.

Step 1 Specify the language and keyboard layout.

Select the language to be displayed on the screens. Depending on the language, you can change the layout of the keyboard that is displayed to enter characters.

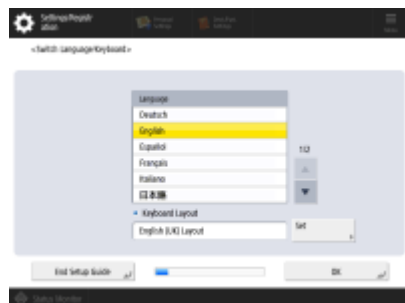

- Select the language, and press <OK>.
- To change the keyboard layout, press <Set>, select the keyboard layout, and press <OK>.
- Displaying the button for switching languages will be convenient for frequent language switching. **Switching the Displayed Language(P. 377)**

Step 2 Check the paper settings.

Check that the paper loaded in the drawers is correctly specified.



- If the paper sizes are correct, press <OK>.
- For information on the screen and the instructions on how to change the settings, see **Specifying Paper Size and Type in the Paper Drawer(P. 65)** .
- If you are not logged in as an administrator, proceed to Step 11.

Step 3 Log in as the Administrator.

Make an authenticated login to configure the settings that require Administrator privileges.

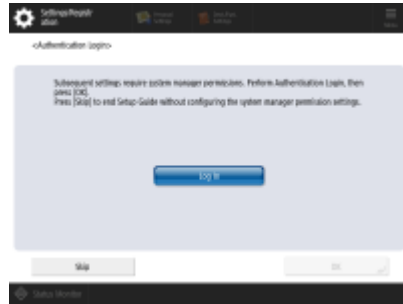

- Press <Log In>, and enter the user name and password of a user with administrator privileges. The default user name for the administrator is "Administrator" and the default password is "7654321". Press <Log In> again, and press <OK>.
- If you enter the factory default password, the screen prompting you to change the password is displayed. You can also change the password later. **Logging in as an Administrator(P. 259)**
- You can skip the settings that require Administrator privileges and proceed to the next step by pressing <Skip>. In this case, proceed to Step 11.

Step 4 Specify the user authentication settings.

To enhance the security of the machine, use the machine under a system that uses user authentication.

- This machine is set to use the user authentication as the login service. For more information, see **Configuring the Personal Authentication Management Settings(P. 806)** .



- Press <On> for <Use User Authentication>, press <On> for the login method to use, and press <Next>.
- If you do not use user authentication, press <Off> for <Use User Authentication>, press <OK>, and proceed to Step 5.



Specify the following settings if there are no administrators besides the "Administrator" user registered in the machine.



- To enhance the security of the machine by disabling the "Administrator" user and registering a new administrator, press <Yes>. In <Register Administrator>, enter <User Name> and <Password>, and press <OK>. Specify <E-Mail Address>.

<Department ID>, and <Display Name> as necessary. For more information, see [▶ Registering User Information in the Local Device\(P. 809\)](#) . The "Administrator" user will be disabled the next time you log in.

- To operate as "Administrator," press <No>.



- Select the timing for displaying the login screen. If you select <Display When Func Is Selected>, press <Functions> and <Color Copy/Print>, select the function to display the login screen for, and press <OK>. Also, select the setting items on the <Settings/Registration> screen to display the login screen for.
- If you select <Off> for <Keyboard Authentication>, press <OK>. Proceed to step 5.
- If you select <On> for <Keyboard Authentication>, press <Next>.



- To use authentication via numeric key entry only on the login screen, press <On>, and press <OK>.

Step 5 Specify settings for optional output trays.

If the <Use Optional Output Tray> screen appears, specify whether you will be using any additional output trays.

- If the <Date/Time Settings> screen appears, proceed to Step 6.



- Press <On> to enable the output tray or press <Off> to disable it, and press <OK>.
- The displayed items vary depending on the options installed.

Step 6 Set the date and time.

Specify the date and time of the machine.

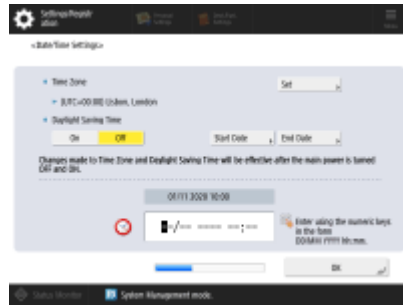

- Enter the date and time, and press <OK>.
- Set <Time Zone> and <Daylight Saving Time> as necessary. For more information, see **▶Setting the Date/Time(P. 261)** .

Step 7 Set the IP address.

Specify the settings for network connection.

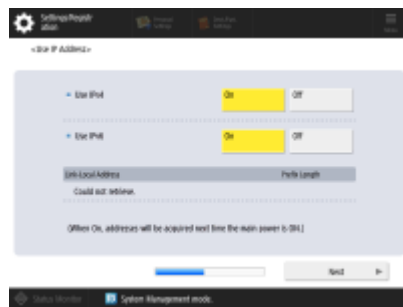

- Press <On> for <Use IPv4> or <Use IPv6>, and press <Next>. You can also use both IPv4 and IPv6.
- If you press <Off> for <Use IPv4> and <Use IPv6>, and press <OK>, skip the network settings and proceed to Step 10.



If you press <On> for <Use IPv4>, specify the following settings.



- To obtain the IP address automatically, press <DHCP> or <Auto IP>, and press <Next> or <OK>.
- To set the IP address manually, clear the selection for <DHCP> or <Auto IP>, press <IP Address>, <Subnet Mask>, and <Gateway Address> to enter each value, and press <Next> or <OK>.
- For information on the IPV4 address settings, see **▶Setting an IPv4 Address(P. 279)** .



If you press <On> for <Use IPv6>, specify the following settings.

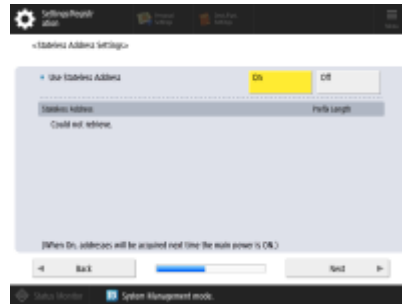

- Press <On> to use the stateless address or <Off> to not use the stateless address, and press <Next>.
- For information on the IPv6 address, see [▶Setting an IPv6 Address\(P. 281\)](#) .



After specifying the stateless address, specify the following settings.

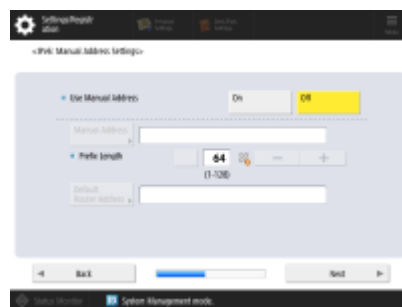

- Press <On> to use the manual address or <Off> to not use the manual address, and press <Next>.
- To use the manual address, press <Manual Address>, <Prefix Length>, and <Default Router Address> to enter each value.



After specifying the manual address, specify the following settings.

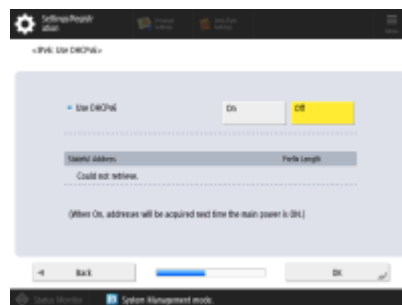

- Press <On> to use DHCPv6 or <Off> to not use DHCPv6, and press <OK>.

Step 8

Specify the DNS settings.

Specify the DNS server address, DNS host name, and DNS domain name.

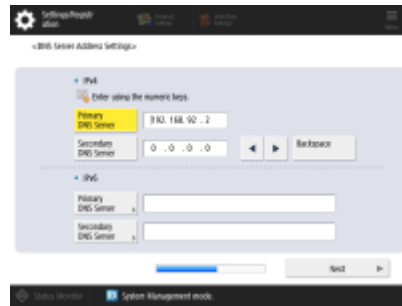

- Press <Primary DNS Server> and <Secondary DNS Server>, enter IPV4/IPv6 address for the DNS server, and press <Next>.
- For information on the settings of the DNS server address, see **▶Making DNS Settings(P. 289)** .

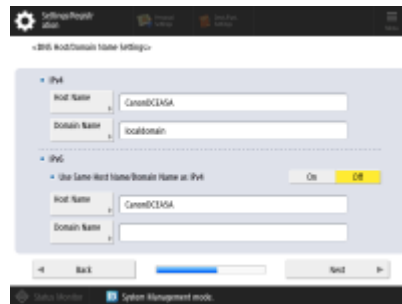

- Press <Host Name> to enter the name of the machine (host name). Press <Domain Name> to enter the domain name that the machine belongs to, and press <Next>.
- If the settings of IPv4 and IPv6 are the same, press <On> for <Use Same Host Name/Domain Name as IPv4>.

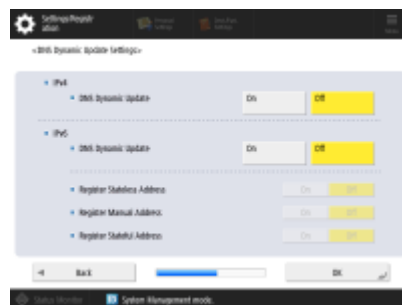

- To update automatically using the DNS Dynamic Update Settings, press <On> for <DNS Dynamic Update>, and press <OK>.
- If you set <DNS Dynamic Update> for <IPv6> to <On>, select <On> for the items to register automatically.

Step 9 Specify the Proxy settings.

Specify the necessary settings to use the Proxy.

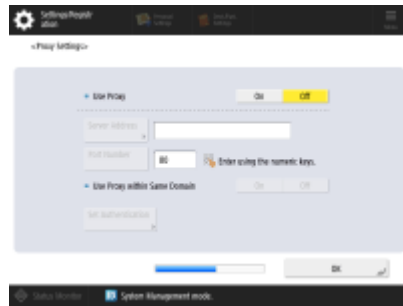

- To use the Proxy, press <On>, press <Server Address> and <Port Number> to enter each value, and press <OK>.
- If you set <Use Proxy within Same Domain> to <On>, press <Set Authentication> to specify the Proxy authentication settings.
- For information on the Proxy settings, see **▶Setting a Proxy(P. 862)** .

Step 10 Specify the fax settings.

Specify the necessary settings to use the fax function.

- If your machine does not have a fax function, proceed to Step 11.
- Select the country/region if the selection screen appears, and press <Next>.

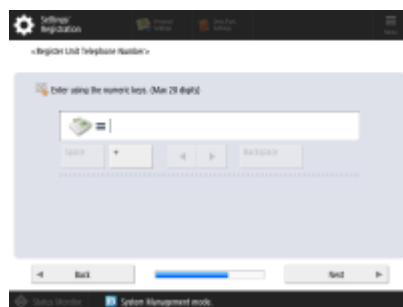

- Enter the fax number, and press <Next>.
- For information on the fax settings, see **▶Fax Line Settings(P. 314)** .



- Press <Set>, enter the user name, and press <Next>.





- Select the line type, and press <OK>.

Step 11 Perform the automatic gradation adjustment.

Adjust the gradation to print clearly.

- Depending on the machine, the procedure differs. For information on the automatic gradation adjustment, see **▶Adjusting Gradation(P. 1378)** .

Step 12 Print a report.

You can print the network user list, fax user data list, and adjusted value list.

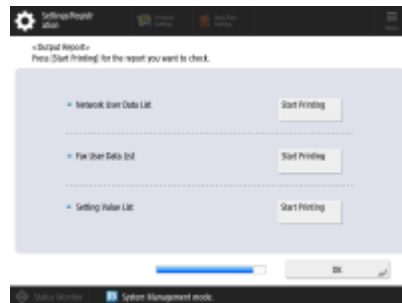

- Press <Start Printing> for the report you want to print.
- When printing is complete, or if you do not print a list, press <OK>.

Step 13 Complete the Setup Guide.

When finishing the Setup Guide, restart the machine to apply the specified settings.



- Press <OK> to restart the machine.

NOTE

- If you do not use the Setup Guide, press <End Setup Guide> in Step 1.
- You can press  (Settings/Registration) to individually specify settings configured during the Setup Guide at a later time.

■ Starting the Setup Guide later

IMPORTANT

The Setup Guide cannot be started in the following cases.

- If the user authentication or department ID authentication is set.
- If the DepartmentID Authentication is set.
- If the authentication with a card is performed.



 (Settings/Registration) ▶ <Management Settings> ▶ <License/Other> ▶ <Start Setup Guide> ▶
<Start>

NOTE

- If you start the Setup Guide later and log in as an administrator, Step 3 will not be displayed. Proceed to Step 4.

Logging in as an Administrator

961F-03W

Log in as an administrator, otherwise important items regarding the network and security cannot be set. To set up the user management after the setup is complete, you need to log in as an administrator. The default user name for the administrator is "Administrator" and the default password is "7654321". When you are going to operate the machine as "Administrator," change the current password to improve the security. The changed password should be known by the administrator only.

NOTE

- You can disable "Administrator" and make a setting to grant administrator privilege to specific users.

Initializing the administrator password

If you have forgotten the password for "Administrator," it can be returned to the default password. Press  (Counter/Device Information) or the [Counter/Device Information] key (models with an upright control panel) ► <Device Info./Other> ► <Initialize Admin. Password> ► enter the license key ► press <Start> ► <OK>.

- If "Administrator" is disabled, it is enabled when initializing the password. [▶ Registering User Information in the Local Device\(P. 809\)](#)
- You can prohibit initialization of the administrator password. [▶ <Prohibit Initialization of Administrator Password>\(P. 1343\)](#)

1 Press  (Settings/Registration).

2 Press <Log In>.

3 Log in with the procedure.

■ Keyboard authentication

1 Set the user name and password.

- Enter the name of a user with administrator privilege, and press <Next>.
- Set the password and press <OK>.

2 Press <Log In>.

- If you have not changed the administrator password, the message prompting you to change to a new password is displayed. Press <Yes> and set a new password. You need to enter the new password twice to confirm it.
- If you have already changed the administrator password, the functions will be available after you successfully log in.

NOTE

- Log out after use.

■ When logged in as an administrator

After pressing  (Settings/Registration), the following screen is displayed.

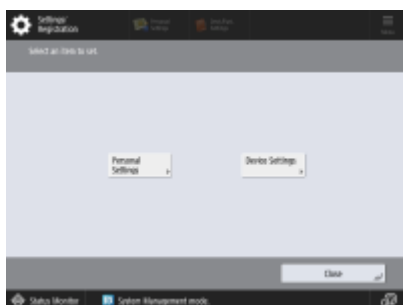

- If you set to <Personal Settings> and change the items that can be personalized, settings are registered as the personal settings for the users who log into the machine.
- If you set to <Device Settings>, settings are registered as the machine's settings.
- <Personal Settings> and <Device Settings> are only displayed on the <Settings/Registration> screen if you log in with administrator privileges.

LINKS

▶ **Logging into the Machine(P. 355)**

▶ **Starting the Remote UI(P. 902)**

Setting the Date/Time

961F-03X

Adjust the machine's date/time. These settings should be made properly as the date/time is used in cases such as sending an e-mail automatically at a specified time.

- 1 Press  (Settings/Registration).
- 2 Press <Preferences> ▶ <Timer/Energy Settings> ▶ <Date/Time Settings>.
- 3 Enter the date/time.



a <Time Zone>

Select the time zone for your area.

NOTE

- UTC is an acronym for Universal Coordinated Time. The standard (time zone) for each country is determined on the basis of UTC. For communication via the Internet, precise time zone setting is essential.

b <Daylight Saving Time>

To set daylight saving time, press <On> and set the date/time for <Start Date> and <End Date>. To set the date, specify the day of the week and the week of the month.

NOTE

- If daylight saving time is set, the time can be put forward an hour compared to the time zone or time during a specified period in the summer.

c Date and time

Enter 4 digits for the year, 4 digits for the month and day, and 4 digits for the time in the same way that the current time appears on the display.

NOTE

- The order of the date and time may differ, depending on the country/region.
- Time is entered in 24-hour notation.
- If you make a mistake, press  (Clear) and enter again from the year.

- 4 Press <OK>.

 **IMPORTANT**

- If you changed the setting of <Time Zone> or <Daylight Saving Time>, you need to restart the machine by turning the power OFF. Press the power switch to turn OFF the machine (▶ **Turning OFF the Machine(P. 36)**). When 10 or more seconds have elapsed after the main power indicator turned off, turn ON the machine again (▶ **Turning ON the Machine(P. 35)**).

NOTE

- Adjust the time regularly when the clock is noticeably incorrect.
- You can also specify to automatically synchronize the date and time with a server on the network using SNTP. ▶ **Making SNTP Settings(P. 309)**

Setting up the Network Environment

961F-03Y

To connect the machine to a network, connect the machine to a router using a LAN cable or Wi-Fi and specify a unique IP address in the network. To specify an IP address, there are two methods: automatic setting and manual setting. Select one of the methods that is suitable for your communication environment and devices. The machine adopts not only basic network functions, but also advanced technologies in order to flexibly cope with various environments. Carry out the necessary setup required for your environment.

IMPORTANT

For safe use

- If you connect the machine to a network without appropriate security measures, there are risks that the machine might receive unauthorized access from third parties. Set up network security to secure important data and information. [▶Configuring the Network Security Settings\(P. 852\)](#)

NOTE

- To use Wireless LAN, the required wireless LAN connection must be installed. [▶System Options\(P. 1597\)](#)
- You can connect the machine to a computer using a USB cable ([▶Parts and Their Functions\(P. 19\)](#)). However, if you only connect the machine to a computer using a USB cable without connecting to a network, operations such as using as a scanner or sending/transferring data from the machine to a computer are not possible.
- You can establish a wireless direct connection between the machine and mobile devices. [▶Connecting Directly\(P. 766\)](#)

■ Confirm before handling

Follow the procedure below to make a connection to a network.



Confirm first.

- Are a computer and a router properly connected using a LAN cable? For details, see the instruction manual for each device or contact the manufacturers.
- Is setup of the computer network completed? If the setup is not completed, you cannot use the devices on a network even after completing the following steps.

NOTE

- Depending on your environment, you may need to change the settings of the network communication system (half-duplex/full-duplex) and Ethernet type (1000BASE-T/100BASE-TX/10BASE-T) ([▶Making Ethernet Settings\(P. 286\)](#)). For details, contact the network administrator.
- To confirm the MAC address, see [▶<Network>\(P. 1080\)](#) .
- To connect to a network employing IEEE802.1X, see [▶Configuring the IEEE 802.1X Authentication Settings\(P. 874\)](#) .





Enable the network settings of the machine.
 ▶ **Canceling the Network Setting Lock(P. 266)**

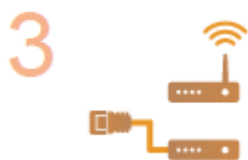

Select a wired LAN or wireless LAN for connection.
 ▶ **Selecting the Network Connection Method(P. 267)**



Connect the machine to a router.

- Is the LAN cable connector plugged into the proper place securely? Insert the connector until it clicks.
- For a wireless LAN connection, check the connection between the machine and the router.

▶ **Connecting to a Wired LAN(P. 269)**
 ▶ **Connecting to a Wireless LAN(P. 270)**



Set an IP address as necessary.

- Normally, an IP address is automatically allocated by DHCP, so this setting is not necessary. If you want to use a specific IP address or change the protocol of the automatic setting of an IP address from DHCP (initial setting) to another, this setting is necessary.

▶ **Setting an IP Address(P. 278)**



Confirm that proper connection is completed.

- Start the Remote UI from a computer (▶ **Starting the Remote UI(P. 902)**). If the Remote UI screen is displayed, the connection is completed.

NOTE

When <Sleep Mode Energy Use> is set to <Low>

- Depending on the utility software, communication may fail if the machine is in sleep mode. Return the machine from sleep mode before setting up the network environment. ▶ **Entering Sleep Mode(P. 387)**

LINKS

▶ **Adapting to the Network Environment(P. 285)**

Canceling the Network Setting Lock

961F-040

By default, a security lock is applied to the network settings in order to prevent unintended changes. Unlock the security lock to change them.



 (Settings/Registration) ▶ <Preferences> ▶ <Network> ▶ <Confirm Network Connection Setting Changes> ▶ <On> ▶ <OK>

NOTE

- If <Off> is selected, you cannot view or change the network settings. Also, error messages related to the network are not displayed.

Selecting the Network Connection Method

You can select the method for connecting the machine to computers, etc. The following connection methods are available.

- Wired LAN only
- Wireless LAN only
- Simultaneous wired LAN and wireless LAN
- Simultaneous wired LAN and another wired LAN

When using simultaneous wired LAN and wireless LAN or simultaneous wired LAN and another wired LAN, the line connected from the LAN port of the machine is called the "main line" and the line connected from wireless LAN or another wired LAN is called the "sub line."

NOTE

- To use Wireless LAN, the required wireless LAN connection must be installed. **System Options(P. 1597)**

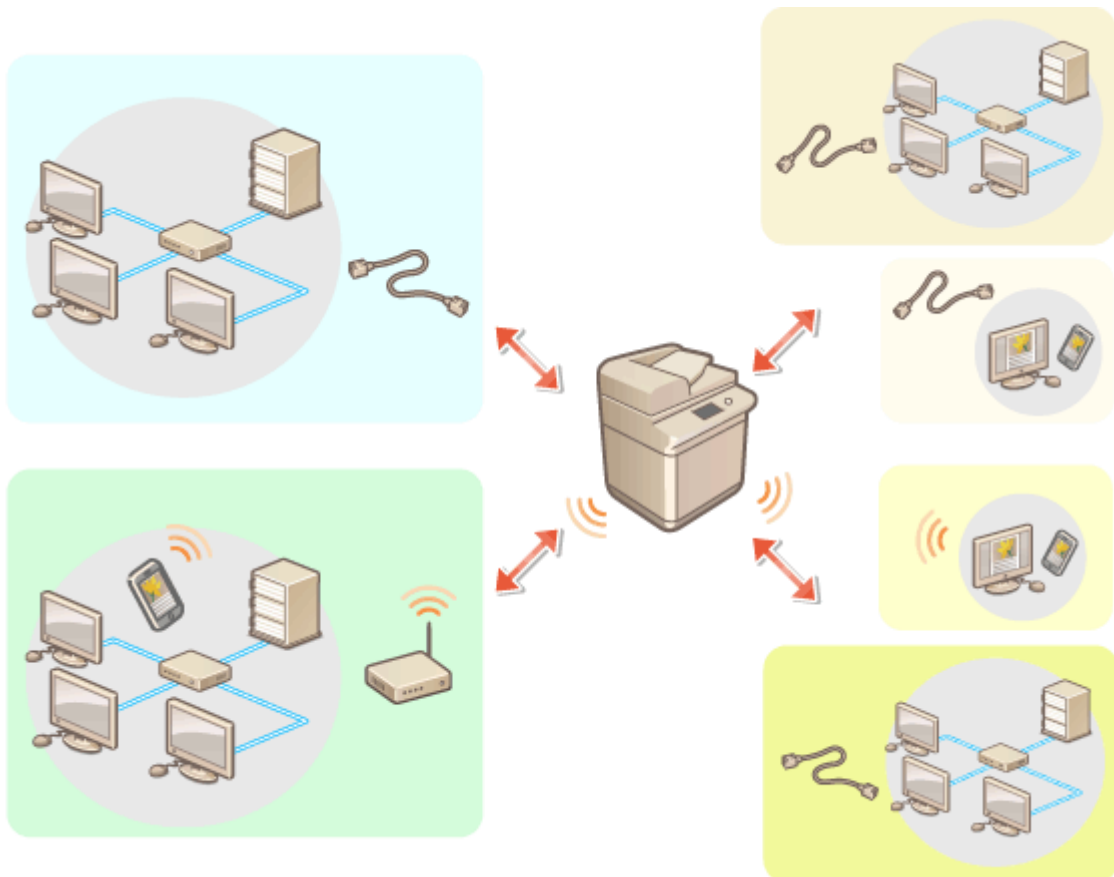

⚙️ (Settings/Registration) ▶ <Preferences> ▶ <Network> ▶ <Select Interface> ▶ select the interface ▶ <OK>

! IMPORTANT

- When using a sub line, see **▶Cautions When Using the Sub Line(P. 1524)** .

If you selected <Wireless LAN> or <Wired LAN + Wireless LAN>

- Set <Sleep Mode Energy Use> to <High>. **▶<Sleep Mode Energy Use>(P. 1077)**
- The settings of <Wireless LAN Settings> are cleared.
- You cannot set wireless LAN as the main line and wired LAN as the sub line.

Cautions When Using Wired LAN (Sub Line)

- Set <Sleep Mode Energy Use> to <High>. **▶<Sleep Mode Energy Use>(P. 1077)**

LINK

▶Connecting to a Wired LAN(P. 269)

▶Connecting to a Wireless LAN(P. 270)

Connecting to a Wired LAN

961F-042

Connect the machine to a computer via a router using a LAN cable.

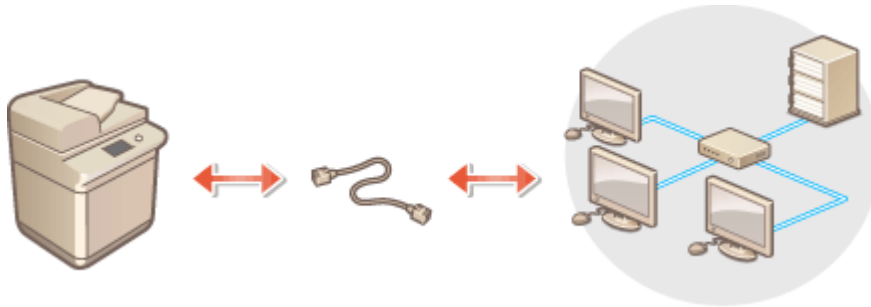

NOTE

- A router and LAN cable are not included with the machine, so please prepare them separately.
- The machine supports 1000BASE-T/100BASE-TX/10BASE-T Ethernet.
- To make a connection using 100BASE-TX/10BASE-T, use a category 5 twisted pair cable. It is recommended to use an enhanced category 5 twisted pair cable to make a connection using 1000BASE-T.
- If devices supporting 1000BASE-T, 100BASE-TX and 10BASE-T are used together, a device (such as a switching hub) supporting all of the Ethernet types you use is necessary. For more information, contact your dealer or service representative.

1 Connect the machine to a router using a LAN cable.

- Push the connector in until it clicks into place.

■ Connecting to a Wired LAN for the Sub Line

When <Wired LAN + Wired LAN> is selected in <Select Interface>, connect the wired LAN for the sub line. (P. 1089)

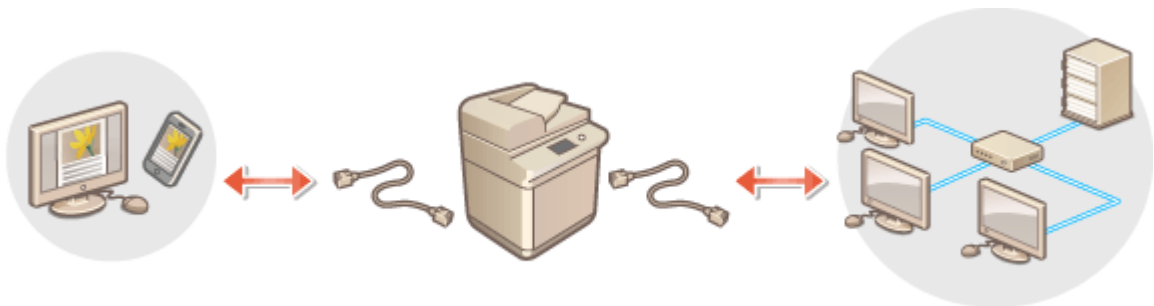

- 1 Connect the USB-LAN adapter to the USB port of the machine (located towards the back on the right side of the machine). (P. 19)

! IMPORTANT

- Multiple USB-LAN adapters cannot be connected.

NOTE

- For information on the USB-LAN adapters that can be used, contact your dealer or service representative.

Connecting to a Wireless LAN

961F-043

Wirelessly connect the machine to a computer or mobile device via a wireless LAN router (access point). If the wireless router is equipped with Wi-Fi Protected Setup (WPS), configuring your network is automatic and easy. If the wireless router does not support with WPS, or if you want to specify authentication and encryption settings in detail, you need to manually set up the connection. Configure connection on the computer or mobile device side in advance.

NOTE

- To use Wireless LAN, the required wireless LAN connection must be installed. [▶System Options\(P. 1597\)](#)

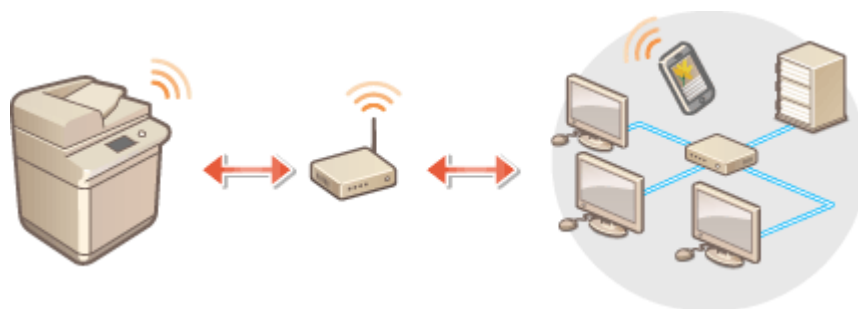

■ Setting Up the Connection Using WPS

If your wireless LAN router supports WPS, two setting modes are available: push button mode and PIN code mode.

- [▶Setting Up the Connection Using WPS Push Button Mode\(P. 272\)](#)
- [▶Setting Up the Connection Using WPS PIN Code Mode\(P. 273\)](#)

■ Setting Up the Connection Manually

There are two manual setting methods: manually configure the setting with a wireless LAN router selected, or manually enter all the required information for wireless LAN connection. Regardless of the method, make sure that you have the required setup information, including the SSID and network key.

- [▶Setting Up Connection by Selecting a Wireless Router\(P. 274\)](#)
- [▶Setting Up a Connection by Specifying Detailed Settings\(P. 275\)](#)
- [▶Checking the SSID and Network Key\(P. 277\)](#)

! IMPORTANT

- Use wireless LAN connection at your own discretion and at your own risk. If the machine is connected to an unsecured network, your personal information might be leaked to a third party because radio waves used in wireless communication can go anywhere nearby, even beyond walls.
- The wireless LAN security that is supported by the machine is listed below. For the wireless security compatibility of your wireless router, see the instruction manuals for your networking devices or contact your manufacturer.
 - 128 (104)/64 (40) bit WEP
 - WPA-PSK (TKIP/AES-CCMP)
 - WPA2-PSK (TKIP/AES-CCMP)
 - WPA3-SAE (AES-CCMP)
 - WPA-EAP (AES-CCMP)

WPA2-EAP (AES-CCMP)

WPA3-EAP (AES-CCMP)

However, WPA-EAP and WPA2-EAP cannot be used if <Wired LAN + Wireless LAN> is selected in <Select Interface>.

- Depending on the network device, the operation of the wireless LAN router differs. See the instruction manuals for your networking device for help.
- When <Prohibit Use of Weak Encryption> is set to <On> (▶<Prohibit Use of Weak Encryption>(P. 1371)), the machine cannot be connected to the wireless LAN router without the security settings, or either WEP or TKIP is specified.

NOTE

- This machine does not come with a wireless router. Have the router ready.
- The wireless router must conform to IEEE 802.11b/g/n and be able to communication in 2.4 GHz bandwidth. For more information, see the instruction manuals for your networking devices or contact your manufacturer.

■ Check the settings and information of the wireless LAN

Check the information you set.



 (Settings/Registration) ▶ <Preferences> ▶ <Network> ▶ <Wireless LAN> ▶ <Wireless LAN Information>

TIPS

Connecting directly

- You can establish a direct wireless connection between a mobile device and the machine without using a wireless LAN router. ▶<Connecting Directly>(P. 766)



Reducing the power consumption

- If you set <Power Save Mode> to <On>, you can regularly set the machine to the power saving mode to match the signal that the wireless LAN router sends. ▶<Power Save Mode>(P. 1128)

Setting Up the Connection Using WPS Push Button Mode

961F-044

If your wireless router supports the WPS (Wi-Fi Protected Setup) Push Button mode, you can easily set up a connection with the WPS button on the router.



 (Settings/Registration) ▶ <Preferences> ▶ <Network> ▶ <Wireless LAN> ▶ <Wireless LAN Settings> ▶ <WPS Push Button Mode> ▶ press and hold the WPS button on the wireless router

⇒ When the wireless LAN router is detected and the configuration is complete, the screen <Connected.> will be displayed.

NOTE

- Depending on the networking device, you may need to press and hold the WPS button for 2 seconds or longer. See the instruction manuals for your networking device for help.
- If the wireless router is set to use WEP authentication, you may not be able to set up connection using WPS.

Setting Up the Connection Using WPS PIN Code Mode

961F-045

Some WPS (Wi-Fi Protected Setup) routers do not support the Push Button mode. In this case, register the PIN code generated on the machine to the networking device.



Generating a PIN code on the machine

- 1 Press  (Settings/Registration).**
- 2 Press <Preferences> ▶ <Network> ▶ <Wireless LAN> ▶ <Wireless LAN Settings> ▶ <WPS PIN Code Mode>.**
 - ⇒ A PIN code is generated.



Registering the PIN code to the wireless router

Register the PIN code within two minutes after the PIN code is generated. For details, see the instruction manual for your networking device.

- 1 Access a wireless router from a computer.**
- 2 Display the screen for entering a WPS PIN code.**
- 3 Register the generated PIN code to the wireless router.**
 - ⇒ When the wireless LAN router is detected and the configuration is complete, the screen <Connected.> will be displayed.

NOTE

- If the wireless router is set to use WEP authentication, you may not be able to set up connection using WPS.

Setting Up Connection by Selecting a Wireless Router

961F-046

You can search the wireless routers available for connection and select one from the display of the machine. If the security standard for your wireless LAN router is WEP, WPA/WPA2-PSK or WPA3-SAE, enter a WEP key or PSK for the network key. Confirm and write down in advance information regarding your SSID, network key, security standard, or authentication/encryption method, etc. [▶Checking the SSID and Network Key\(P. 277\)](#)

NOTE

Security settings

- If the wireless connection is set up by selecting a wireless router, the WEP authentication method is set to <Open System> or the WPA/WPA2-PSK and WPA3-SAE encryption method is set to <Auto> (AES-CCMP or TKIP). If you want to select <Shared Key> for WEP authentication or <AES-CCMP> for WPA/WPA2-PSK and WPA3-SAE encryption, set up the connection in <Enter Manually>. [▶Setting Up a Connection by Specifying Detailed Settings\(P. 275\)](#)
- If the security standard for your wireless LAN router is WPA/WPA2-EAP/WPA3-EAP, the encryption method is set to AES-CCMP. Also, specify the IEEE 802.1X authentication settings for the machine before connecting to the wireless LAN. [▶Configuring the IEEE 802.1X Authentication Settings\(P. 874\)](#)

1 Press  (Settings/Registration).

2 Press <Preferences> ▶ <Network> ▶ <Wireless LAN> ▶ <Wireless LAN Settings>
▶ <Other (Set Manually)>.

3 Press <Select Access Point>.

- The machine starts searching for available wireless routers.

4 Select a wireless router, and connect to it.

■If the security setting of your wireless LAN router is WEP, WPA/WPA2-PSK or WPA3-SAE

- 1 Select the wireless LAN router to use, and press <OK>.
- 2 Press <WEP Key> or <Encryption Key>, and enter the network key.
- 3 Press <OK>.

⇒ When the configuration is complete, the screen <Connected.> will be displayed.

■If the security setting of your wireless LAN router is other than WEP, WPA/WPA2-PSK or WPA3-SAE

- 1 Select the wireless LAN router to use, and press <OK>.

⇒ When the configuration is complete, the screen <Connected.> will be displayed.

Setting Up a Connection by Specifying Detailed Settings

961F-047

If you want to specify the security settings in detail or cannot establish the wireless connection using the other procedures, manually enter all the required information for the wireless LAN connection. Confirm and write down in advance information regarding your SSID, network key, security standard, or authentication/encryption method, etc.

🔍 Checking the SSID and Network Key (P. 277)

- 1 Press  (Settings/Registration).
- 2 Press <Preferences> ▶ <Network> ▶ <Wireless LAN> ▶ <Wireless LAN Settings> ▶ <Other (Set Manually)>.
- 3 Press <Enter Manually>.
- 4 Press <SSID>, and enter the SSID that you have checked.
- 5 Specify the security settings in <Security Settings>.

■ Using WEP

- 1 Press <WEP>.
- 2 Select an authentication method.
 - To use the WEP key as a password, press <Shared Key>.
 - If you press <Open System>, the machine experiences an authentication is set on the wireless router. If this happens, the machine automatically changes the setting to <Shared Key> and retries the connection.
- 3 Select the WEP key that you want to edit.
 - Press any of <WEP Key 1> to <WEP Key 4>.
- 4 Enter the network key that you have checked.
- 5 Select the WEP key to use.
- 6 Press <OK>.

■ Using WPA-PSK, WPA2-PSK or WPA3-SAE

- 1 Press <WPA/WPA2-PSK>.
- 2 Select an encryption method.
 - To set the machine to automatically select AES-CCMP or TKIP to match the setting of the wireless router, press <Auto>.
- 3 Press <Encryption Key>, and enter the network key that you have checked.
- 4 Press <OK>.

■ **Using WPA-EAP, WPA2-EAP or WPA3-EAP**

1 Press <WPA/WPA2-EAP>.

2 Press <OK>.

6 Press <OK>.

▣▣▣▣ When the wireless LAN router is detected and the configuration is complete, the screen <Connected.> will be displayed.

Checking the SSID and Network Key

961F-048

When manually setting up a wireless LAN router connection, it is necessary to specify the SSID, network key, and security standard, etc., of the wireless LAN router. The SSID and network key may be indicated on these networking devices. Check your devices before setting up the connection. If the security standard for your wireless LAN router is WPA/WPA2-EAP, specify the IEEE 802.1X authentication settings for the machine in advance ( **Configuring the IEEE 802.1X Authentication Settings(P. 874)**). For more information, see the instruction manuals for your networking devices or contact your manufacturer.

SSID	A name given for identifying a specific wireless LAN. Some other terms used for SSID include "access point name" and "network name."
Network Key	A keyword or password used for encrypting data or authenticating a network. Some other terms used for network key include "encryption key," "WEP key," "WPA/WPA2 passphrase," "preshared key (PSK)."
Wireless Security Protocols (Authentication / Encryption)	<ul style="list-style-type: none"> • Security types (WEP/WPA-PSK/WPA2-PSK/WPA-EAP/WPA2-EAP/WPA3-SAE) • Authentication method (Open System/Shared Key/IEEE 802.1X authentication) • Encryption method (TKIP/AES-CCMP)

IMPORTANT

- <WPA/WPA2-EAP> cannot be used if <Wired LAN + Wireless LAN> is selected in <Select Interface>.

Setting an IP Address

961F-049

To connect the machine to a network, a unique IP address on the network is required. The machine supports two versions of IP addresses: "IPv4" and "IPv6." Set and use them according to your environment. You can use either IPv4 or IPv6. You can also use both of them at the same time.

When a connection method with a main line and sub line is selected in <Select Interface>, specify the IP address of the sub line in <IP Address Settings> in <Sub Line Settings>.

- ▶ **Setting an IPv4 Address(P. 279)**
- ▶ **Setting an IPv6 Address(P. 281)**
- ▶ **Setting the IPv4 Address of the Sub Line(P. 284)**

Setting an IPv4 Address

961F-04A

There are two methods to set an IPv4 address: allocating automatically using DHCP and entering manually. Select either of the two according to your environment. Conduct a connection test as necessary.

🔗 [Setting an IPv4 Address\(P. 279\)](#)

🔗 [Conducting a Connection Test for an IPv4 Address\(P. 280\)](#)

Setting an IPv4 Address

1 Press  (Settings/Registration).

2 Press <Preferences> ▶ <Network> ▶ <TCP/IP Settings> ▶ <IPv4 Settings>.

3 Press <Use IPv4> ▶ <On> ▶ <OK> to enable IPv4 settings.

4 Press <IP Address Settings> and set an IP address.

- You can set both automatic allocation and manual allocation. If you set both and set <Release Address Last Acquired from DHCP Server When Address Cannot Be Acquired> to <Off>, the manually entered IP address is used when automatic IP address retrieval fails.

■ Automatic allocation using DHCP

Press <DHCP> or <Auto IP>. Select one of them according to your network environment. If you select both <DHCP> and <Auto IP>, automatic allocation using DHCP takes priority.

NOTE

- If you press <Auto IP>, the available IP address is automatically searched in the network (LAN) and the value for each item is allocated. This function allocates the IP address without using a DHCP server. However, communication outside of the router range is not available.
- In an environment where both <DHCP> and <Auto IP> cannot be used, if either of the two is selected, useless communication occurs because the machine tries to check if the service is provided on the network.

■ Setting by manual entry

- 1 Confirm that both <DHCP> and <Auto IP> are canceled.
 - If either of the two is selected, press the button to cancel.
- 2 Enter the IP address, the subnet mask, and the gateway address.
 - Press the button corresponding to each and enter values.

5 Press <OK>.

6 Press  (Settings/Registration) ▶ <Yes>.

Conducting a Connection Test for an IPv4 Address

When the machine is connected properly, the Remote UI login screen can be displayed from the computer ([▶Starting the Remote UI\(P. 902\)](#)). You can conduct a connection test on the control panel of the machine.

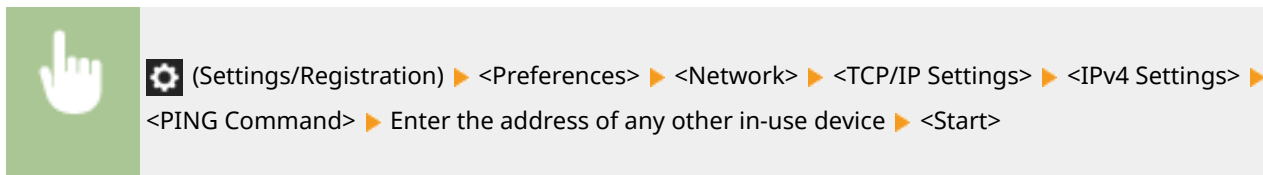

⇒ When the machine is connected correctly, the <Response from the host.> message is displayed.

IMPORTANT

- Even though IP addresses are properly set, if the machine is connected to a switching hub, the machine might not be connected to the network. In this case, delay the timing of the machine's communication start and try to connect again. [▶Setting the Wait Time When Connecting to a Network\(P. 288\)](#)

LINKS

- [▶Setting an IPv6 Address\(P. 281\)](#)
- [▶Making WINS Settings\(P. 297\)](#)

Setting an IPv6 Address

961F-04C

The following are the types of IPv6 addresses. Register as necessary. Up to four stateless addresses can be registered. Conduct a connection test as necessary.

Type	Explanation
Link local address	Addresses that can be used only in the same link and that are automatically created without setting anything. Cannot be used out of the router range.
Stateless address	Addresses that are created automatically on the basis of the prefix notified by a router and the MAC address of the machine, even in an environment without a DHCP server.
Manual address	Addresses that are manually entered. Prefix length and a default router address are specified.
Stateful address	Addresses that are acquired from the DHCP server.

▶ **Setting an IPv6 Address(P. 281)**

▶ **Conducting a Connection Test for an IPv6 Address(P. 282)**

Setting an IPv6 Address

- 1** Press  (Settings/Registration).
- 2** Press <Preferences> ▶ <Network> ▶ <TCP/IP Settings> ▶ <IPv6 Settings>.
- 3** Press <Use IPv6> ▶ <On> ▶ <OK> to enable IPv6 settings.
- 4** Set an IP address.
 - Set an IPv6 address according to your environment and purposes.

■ Setting a stateless address

- 1** Press <Stateless Address Settings>.
- 2** Press <On> ▶ <OK>.

■ Setting a manual address

- 1** Press <Manual Address Settings>.
- 2** Press <On> in <Use Manual Address> and carry out the necessary settings.



a <Use Manual Address>

Press <On>.

b <Manual Address>

Press the <Manual Address> button and enter an address. The following addresses cannot be used.

- Addresses that begin with "ff" (multicast address)
- Addresses that consist only of "0"
- IPv4-compatible addresses (IPv6 addresses in which the upper 96 bits are "0" with an IPv4 address contained in the lower 32 bits)
- IPv4-mapped addresses (IPv6 addresses in which the upper 96 bits are "0:0:0:0:ffff:" with an IPv4 address contained in the lower 32 bits)

c <Prefix Length>

The length of the network address section can be changed.

d <Default Router Address>

Press <Default Router Address> and enter an address. The following addresses cannot be used.

- Addresses that begin with "ff" (multicast address).
- Addresses that consist only of "0"

If you don't specify an address, leave the column blank.

■ Setting a stateful address

1 Press <Use DHCPv6>.

2 Press <On> ► <OK>.

NOTE

- Press <On> for <Only Retrieve Stateful Address Prefix> to only retrieve the first half of the stateful address from the DHCP server using DHCPv6. ► <Only Retrieve Stateful Address Prefix>(P. 1113)

5 Press  (Settings/Registration) ► <Yes>.

Conducting a Connection Test for an IPv6 Address

When the machine is connected properly, the Remote UI login screen can be displayed from a computer (► **Starting the Remote UI(P. 902)**). If you don't have a computer to check it, confirm if a proper connection is completed with following the steps.



 (Settings/Registration) ▶ <Preferences> ▶ <Network> ▶ <TCP/IP Settings> ▶ <IPv6 Settings> ▶ <PING Command> ▶ Enter the address of any other in-use device or the host name ▶ <Start>

⇒ When the machine is connected correctly, the <Response from the host.> message is displayed.

IMPORTANT

- Even though IP addresses are properly set, if the machine is connected to a switching hub, the machine might not be connected to the network. In this case, delay the timing of the machine's communication start and try to make a connection again.  **Setting the Wait Time When Connecting to a Network(P. 288)**

LINKS

 **Setting an IPv4 Address(P. 279)**

Setting the IPv4 Address of the Sub Line

961F-04E

Specify the IPv4 address to use for the sub line.

NOTE

- Only IPv4 addresses can be used with the sub line.

Setting an IP Address(P. 284)

Setting an IP Address

1 Press  (Settings/Registration).

2 Press <Preferences> ▶ <Network> ▶ <Sub Line Settings>.

3 Press <IP Address Settings> and set the IP address of the sub line.

- You can also set both automatic assignment and manual entry. If you set both and set <Release Address Last Acquired from DHCP Server When Address Cannot Be Acquired> to <Off>, the manually entered IP address is used when automatic IP address retrieval fails.

■ Automatically Assigning the IP Address with DHCP

Press <DHCP>. Select this item according to the network environment of your wireless LAN.

NOTE

- If <DHCP> is selected, communication is performed to check whether network services are being provided, regardless of whether the environment can use DHCP. It is recommended that you deselect this item if you are not using DHCP.

■ Manually Entering the IP Address

- 1 Confirm that <DHCP> is deselected.
 - If it is selected, press the button to deselect it.
- 2 Enter the IP address, subnet mask, and gateway address.
 - Press each button and enter the required setting.

NOTE

- When connecting to another network via a router, enter the gateway address and also configure <Static Routing Settings>. [Setting Static Routing\(P. 307\)](#)

4 Press <OK>.

5 Press  (Settings/Registration) ▶ <Yes>.

Adapting to the Network Environment

961F-04F

The scale and form of a network varies depending on the purpose and use. The machine adopts various technologies for adapting to as many environments as possible. Consult your network administrator and carry out necessary settings according to your environment.

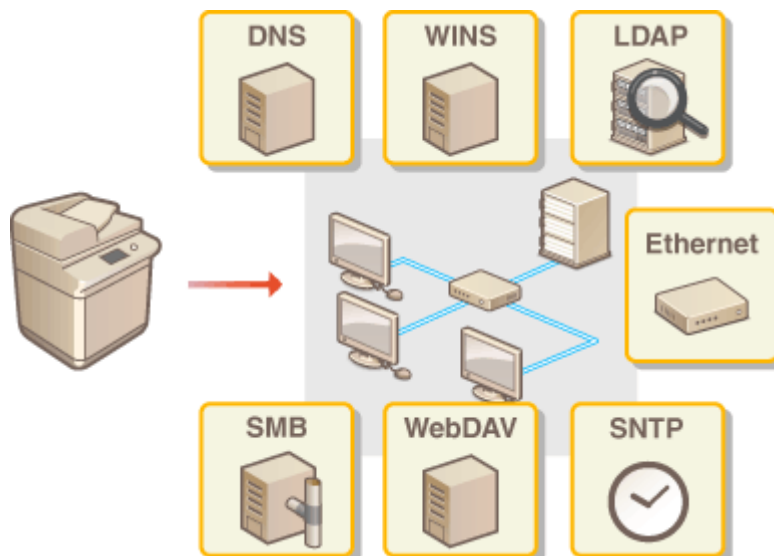

- ▶ Making Ethernet Settings(P. 286)
- ▶ Setting the Wait Time When Connecting to a Network(P. 288)
- ▶ Making DNS Settings(P. 289)
- ▶ Making SMB Settings(P. 294)
- ▶ Making WINS Settings(P. 297)
- ▶ Making WebDAV Settings(P. 298)
- ▶ Registering the LDAP Server(P. 299)
- ▶ Monitoring and Controlling via SNMP(P. 303)
- ▶ Setting Static Routing(P. 307)
- ▶ Other Network Settings(P. 309)
- ▶ Configuring System Data Communication(P. 311)

Making Ethernet Settings

961F-04H

Ethernet is a standard that stipulates communication methods within a LAN. Normally, the communication system (half-duplex/full-duplex) and Ethernet type (1000BASE-T/100BASE-TX/10BASE-T) can be set automatically. You can set them separately by switching the setting to manual operation.

<Ethernet Driver Settings> exists for both the main line and sub line. Register the settings as necessary.

1 Press  (Settings/Registration).

2 Press <Preferences> ▶ <Network> ▶ <Ethernet Driver Settings>.

- To specify the Ethernet settings for the sub line, press <Preferences> ▶ <Network> ▶ <Sub Line Settings> ▶ <Ethernet Driver Settings>.

3 Make Ethernet settings.



- Normally, press <On> in <Auto Detect>. The communication system and Ethernet type are detected and automatically configured.

■ Making Ethernet settings manually

1 Press <Off> in <Auto Detect>.

2 Select the communication system.



a <Half Duplex>

Carry out send/receive functions alternately. Select this when the connected router is set for half-duplex communication.

b <Full Duplex>

Carry out send/receive functions at the same time. Select this as a general rule.

3 Select the Ethernet type.

- Select <10BASE-T>, <100BASE-TX>, or <1000BASE-T> in <Ethernet Type>.

4 Press <OK>.

5 Press  (Settings/Registration) ▶ <Yes>.

LINKS

▶ [Setting the Wait Time When Connecting to a Network\(P. 288\)](#)

Setting the Wait Time When Connecting to a Network

961F-04J

If you intend to implement network redundancy by connecting several switching hubs, a mechanism is necessary to avoid packet looping. In this case, it is effective to determine the roles of the switching ports, but communication may not be properly transmitted in cases just after changes such as adding a new device to the network. To connect the machine to such a network, set the waiting time which is the time until the communication starts.

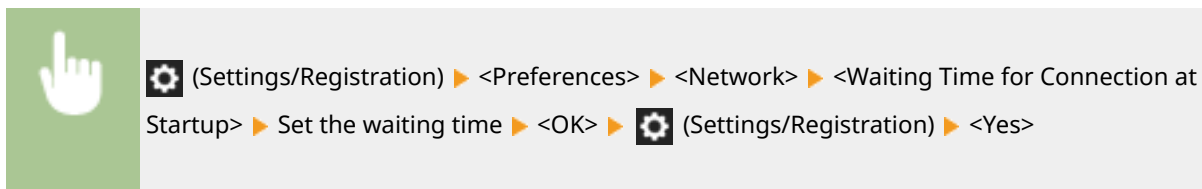

LINKS

🔗 **Making Ethernet Settings(P. 286)**

Making DNS Settings

961F-04K

The DNS server is a computer which converts the names of devices (domain names) on the Internet into IP addresses. There are many DNS servers on the Internet worldwide. They cooperate with each other to make correspondence between domain names and IP addresses. This section describes the steps for setting the machine's DNS server address, host name, and domain name. You can also set the machine so that an automatic update is carried out if correspondence between the host name and the IP address is changed. If you set DNS under an IPv6 environment, confirm if IPv6 addresses can be used ([▶Setting an IPv6 Address\(P. 281\)](#)). In addition, you can make correspondence with an IP address by acquiring the host name through a DHCP server without manually entering the host name of the machine.

▶[Making DNS Settings\(P. 289\)](#)

▶[Using a DHCP Server\(P. 292\)](#)

Making DNS Settings

1 Press  (Settings/Registration).

2 Press <Preferences> ▶ <Network> ▶ <TCP/IP Settings> ▶ <DNS Settings>.

3 Specify a DNS server address.

1 Press <DNS Server Address Settings>.

2 Carry out the necessary settings.

- According to your environment, enter an IP address of the DNS server.

NOTE

- For more information on the settings, consult your provider or network administrator.



a <IPv4>

- Press <Primary DNS Server>, and enter an IPv4 address of the DNS server.
- If there is a secondary DNS server, enter its IP address. If you don't set a secondary DNS server, enter "0.0.0.0".

b <IPv6>

- Press <Primary DNS Server>, and enter an IPv6 address of the DNS server. You cannot enter addresses that begin with "ff" (multicast address), addresses that consist of only "0," or local link addresses.
- If there is a secondary DNS server, enter its IP address. You cannot enter addresses that begin with "ff" (multicast address), addresses that consist of only "0," or local link addresses. This column can be left blank.

3 Press <OK>.

4 Specify the machine's host name and domain name.

1 Press <DNS Host Name/Domain Name Settings>.

2 Carry out the necessary settings.



a <IPv4>

- Press <Host Name>, and enter the host name of the machine to register on the DNS server using alphanumeric characters.
- Press <Domain Name>, and enter the domain name which the machine belongs to using alphanumeric characters (**Example:** "example.com").

b <IPv6>

- To set the host name and domain name to be the same as IPv4, press <On> in <Use Same Host Name/Domain Name as IPv4>. To set to be different from those of IPv4, press <Off>.
- To set the host name to be different from IPv4, press <Host Name> and enter the host name of the machine to register on the DNS server using alphanumeric characters.
- To set the domain name to be different from IPv4, press <Domain Name> and enter the domain name that the machine belongs to using alphanumeric characters. (**Example:** "example.com").

NOTE

- If you set <Use DHCPv6> to <On> for the stateful address settings (**▶Setting an IPv6 Address(P. 281)**), the manually configured domain name is overwritten. If you set <Use Same Host Name/Domain Name as IPv4> to <On>, the domain name that is retrieved from DHCPv6 server is used.

3 Press <OK>.

5 Set automatic correspondence updates.

1 Press <DNS Dynamic Update Settings>.

2 Carry out the necessary settings.



a <IPv4>

- To automatically update the information when correspondence between the host name and the IP address is changed in an environment such as DHCP, press <On> in <DNS Dynamic Update>.

b <IPv6>

- To automatically update the information when correspondence between the host name and the IP address is changed in an environment such as DHCP, press <On> in <DNS Dynamic Update>.
- Turn <On> the address you want to register as a DNS server in <Register Stateless Address>/<Register Manual Address>/<Register Stateful Address>. Please note that automatic update cannot be carried out if all are set to <Off>.

3 Press <OK>.

6 Specify the mDNS settings.

1 Press <mDNS Settings>.

2 Carry out the necessary settings.

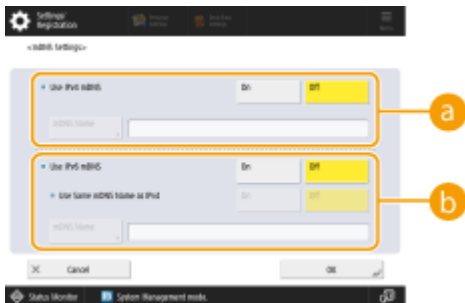

a <Use IPv4 mDNS>

- To enable the DNS function in an environment without a DNS server, press <On>.
- Press <mDNS Name>, and enter an mDNS name of your choice using alphanumeric characters.

b <Use IPv6 mDNS>

- To enable the DNS function in an environment without a DNS server, press <On>.
- To set the same settings as IPv4 for the mDNS name, press <On> for <Use Same mDNS Name as IPv4>. To use different settings, press <mDNS Name> and enter an mDNS name of your choice using alphanumeric characters.

! IMPORTANT

- If you set <Use IPv4 mDNS> to <On>, the machine will not completely enter the Sleep mode.
- If you set <Use IPv6 mDNS> to <On>, the machine will not completely enter the Sleep mode.

3 Press <OK>.

7 Press  (Settings/Registration) ▶ <Yes>.

Using a DHCP Server

You can acquire a host name by using the DHCP server.

NOTE

- The DHCP optional setting only applies to the main line.

1 Press  (Settings/Registration).

2 Press <Preferences> ▶ <Network> ▶ <TCP/IP Settings> ▶ <IPv4 Settings> or <IPv6 Settings> ▶ <DHCP Option Settings>.

3 Carry out the necessary setup.



- Some items may not be displayed in <IPv6 Settings>.

a <Acquire Host Name>

To acquire a host name through the DHCP server, press <On>.

b <DNS Dynamic Update>

To make the DHCP server automatically update information regarding correspondence between the IP addresses and the host names without using the machine, press <On>.

c <Acquire DNS Server Address>

To acquire the DHCP server IP address, press <On>.

d <Acquire Domain Name>

To acquire a domain name through the DHCP server, press <On>.

e <Acquire WINS Server Address>

To acquire a domain name through the WINS server, press <On>.

f <Acquire SMTP Server Address>

To acquire a domain name through the SMTP server, press <On>.

g <Acquire POP Server Address>

To acquire a domain name through the POP server, press <On>.

4 Press <OK>.

5 Press  (Settings/Registration) ▶ <Yes>.

Making SMB Settings

961F-04L

This section describes setup steps to share files and printers among multiple devices on the network utilizing the SMB protocol.

▶ **Setting the SMB Server(P. 294)**

▶ **Setting the SMB Client(P. 295)**

Setting the SMB Server

Enabling the SMB server functions makes it possible for the Advanced Space to be used as a SMB file server.

- 1** Press  (Settings/Registration).
- 2** Press <Preferences> ▶ <Network> ▶ <TCP/IP Settings> ▶ <SMB Server Settings>.
- 3** Select <On> in <Use SMB Server> and carry out the necessary setup.

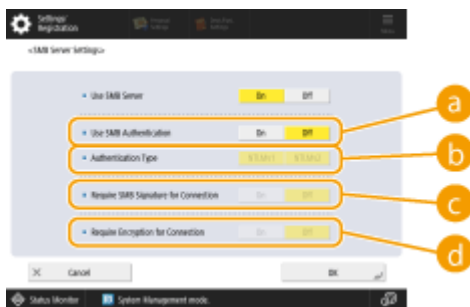

a <Use SMB Authentication>

User authentication is conducted by using user information in the Advanced Space. To conduct user authentication, press <On>.

b <Authentication Type>

Select the version of the authentication protocol. Select <NTLMv1> or <NTLMv2>, according to your operating system. You can also select both.

c <Require SMB Signature for Connection>

To set so that an SMB packet signature is requested when connecting to the SMB server, press <On>.

d <Require Encryption for Connection>

To request a connection with SMB 3.0/3.1 encrypted communication when connecting to an SMB server, press <On>.

- 4** Press <OK>.
- 5** Press <Specify SMB Server Version>, and select the version of SMB to use with the SMB server.

6 Press <OK>.

7 Press  (Settings/Registration) ▶ <Yes>.

IMPORTANT

- Use the same version of SMB with the SMB server and SMB client. SMB cannot be used if the versions differ.

NOTE

- If you set <Require Encryption for Connection> to <On>, you will become unable to connect to the machine from client operating systems that do not support SMB 3.0/3.1 encrypted communication.

Setting the SMB Client

This section describes how to specify the settings to use when the machine connects to a network as an SMB client.

1 Press  (Settings/Registration).

2 Press <Preferences> ▶ <Network> ▶ <TCP/IP Settings> ▶ <SMB Client Settings>.

3 Specify the required settings.



a <Authentication Type>

Select the authentication protocol version. Select either <NTLMv1> or <NTLMv2>, according to the destination SMB server. You can also select both.

b <Require SMB Signature for Connection>

To request an SMB packet signature when connecting to an SMB server, press <On>.

c <Require Encryption for Connection>

To request a connection with SMB 3.0/3.1 encrypted communication when connecting to an SMB server, press <On>.

d <Timeout>

Set the time until the SMB connection destination responds.

- When sending to an SMB server, the network connection was lost or the response on the server side was slow, causing a wait time timeout on the machine side before the data could be sent or forwarding could be completed. If this happens, you may be able to avoid a timeout by increasing the wait time.

4 Press <OK>.

5 Press <Specify SMB Client Version>, and select the SMB version used by the SMB client.

6 Press <OK>.

7 Press  (Settings/Registration) ▶ <Yes>.

IMPORTANT

- When <Require Encryption for Connection> is set to <On>, the machine can only connect to SMB servers that support SMB 3.0/3.1 encrypted communication. When <1.0> and <2.0> are set to <On> for <Specify SMB Client Version> but <3.0> or <3.1> is not set to <On>, the machine cannot connect to SMB servers that do not support SMB 3.0/3.1 encrypted communication.
- Use the same version of SMB with the SMB server and SMB client. SMB cannot be used if the versions differ.

NOTE

- Depending on the network settings, an error may be displayed when sending to the SMB server. In this case, adjust the time in <Timeout>.

LINKS

 [Making WINS Settings\(P. 297\)](#)

 [Setting the Advanced Space of the Machine\(P. 320\)](#)

Making WINS Settings

961F-04R

WINS is the name of a solution service that converts a NetBIOS name (a computer name and a printer name on an SMB network) into an IP address. To use WINS, you need a specified WINS server.

IMPORTANT

- To register the WINS server on the machine, set <Computer Name/Workgroup Name Settings> for <TCP/IP Settings>.  <Computer Name/Workgroup Name Settings>(P. 1093)
- If you set <Use NetBIOS> to <Off> in <Computer Name/Workgroup Name Settings>, the WINS setting is disabled. Make sure to set <Use NetBIOS> to <On> when using WINS.

1 Press  (Settings/Registration).

2 Press <Preferences> ▶ <Network> ▶ <TCP/IP Settings> ▶ <WINS Settings>.

3 Press <On> in <WINS Resolution>, and enter the IP address of the WINS server in <WINS Server Address>.

IMPORTANT

- If the WINS server IP address is acquired from the DHCP server, the IP address acquired from the DHCP server has priority.

4 Press <OK>.

5 Press  (Settings/Registration) ▶ <Yes>.

LINKS

 [Setting an IPv4 Address\(P. 279\)](#)

Making WebDAV Settings

961F-04S

This section describes steps to enable the WebDAV server functions. WebDAV is a protocol that is expanded from HTTP and is utilized to manage files and folders on a web server. Because WebDAV also supports TLS encryption, you can construct a file sharing system which is highly secure through user management. Enabling the WebDAV server functions makes it possible for the Advanced Space to be used as a WebDAV file server.

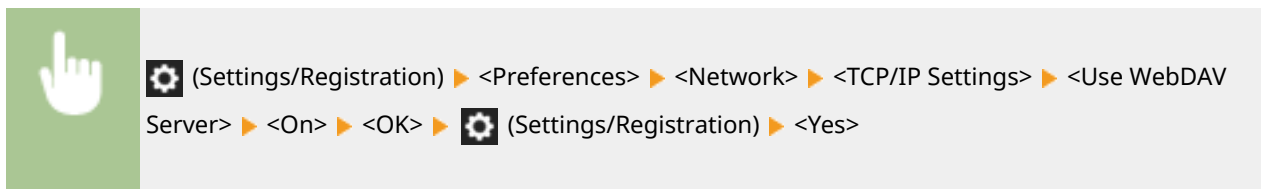

LINKS

▶ [Setting the Advanced Space of the Machine\(P. 320\)](#)

Registering the LDAP Server

961F-04U

In environments where an LDAP sever is employed, fax numbers and e-mail addresses can be searched, specified as destinations from the machine, and registered in the machine's Address Book.

NOTE

- You can register up to five LDAP servers.

- 1 Press  (Settings/Registration).
- 2 Press <Set Destination> ▶ <Register LDAP Server>.
- 3 Register the LDAP server.

- 1 Press <Register>.
- 2 Enter the necessary information.



a <Server Name>

Enter a name for the LDAP server.

b <Server Address>

Enter the IP address or host name of the LDAP server using alphanumeric characters (**Example:** "ldap.example.com").

IMPORTANT

<Server Address> and DNS

To prevent errors, pay attention to the following when a destination search is carried out from the machine to the LDAP server.

- When entering the IP address, check if the usable DNS server supports only forward lookup. When the DNS server supports forward lookup only, press <Do Not Use> or <Use> in <Authentication Information> in step 4. When selecting <Use (Security Auth.)>, confirm that the DNS server supports reverse lookup.

c <Position to Start Search>

Specify where to start searching in the directory tree of the LDAP server.

- For LDAPv3, you can skip the setting because the machine retrieves automatically the server's setting. For LDAPv2, always specify the point.

NOTE

Entering the format of <Position to Start Search>

- When you use Windows Server, enter the domain name of the Active Directory in units of strings divided by a dot ".". Add "DC=" for each unit and separate them with commas ",".
Example: When the domain name is "john.example.com", enter "DC=john,DC=example,DC=com".
- When you use Lotus Notes Domino, enter the directory tree node identification name (dn) like "cn=user1,ou=team1,ou=salesdept,o=canon".

d <Use TLS>

To encode the communication to/from the LDAP server using TLS, press <On>.

e <Search Timeout>

Specify in seconds how long the search can continue.

f <Max Addresses to Search>

Specify how many destinations can be searched.

g <Port Number>

Enter the port number used when communicating to/from the LDAP server.

3 Press <Next>.

4 Set authentication information.

- Specify authentication methods according to the settings of the LDAP server.
- You can check the connection by pressing <Check Connection> after specifying the settings.

■ When authenticating using login information

Enter the user name and the password used as authentication information.

1 Press <Use> in <Authentication Information>.

2 Enter the user name and the password and carry out the necessary settings.

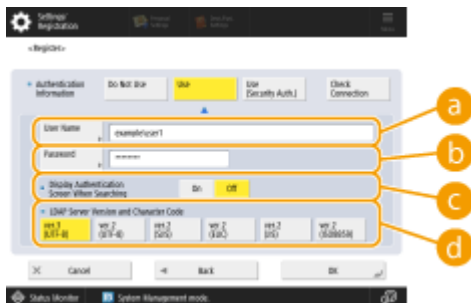

a <User Name>

Enter the user name of the machine registered on the LDAP server.

NOTE

Entering the format of the user name

- When you use Windows Server, enter in the format of "(Windows domain name)\(Windows user name)".

Example: When the Windows domain name is "example" and Windows user name is "user1", enter "example\user1".

- When you use Lotus Notes Domino, enter the authenticated user identification name (dn) like "cn=user1,ou=team1,ou=salesdept,o=canon".

b <Password>

Enter the password registered on the LDAP server. When the password is entered, <Confirm> is displayed for confirmation. Enter the password again.

c <Display Authentication Screen When Searching>

When searching destinations, to display the user name and password entry screen, press <On>.

d <LDAP Server Version and Character Code>

Select a combination of the LDAP version of the server and character code.

- 3 Press <OK>.

■ When authenticating using encoded data

Authentication can be done more safely by encoding the data exchange. When this measure is employed, the LDAP version and character code information are set to <ver.3 (UTF-8)>. The time of the machine and LDAP server need to be synchronized.

- 1 Press <Use (Security Auth.)> in <Authentication Information>.
- 2 Enter the user name and the password and carry out the necessary settings.

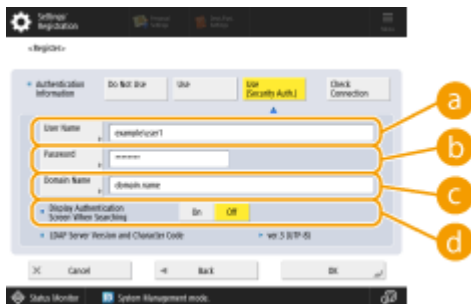

a <User Name>

Enter the username of the machine registered in the LDAP server (**Example:**"user1").

b <Password>

Enter the password registered on the LDAP server. When the password is entered, <Confirm> is displayed for confirmation. Enter the password again.

c <Domain Name>

Enter the domain name of the machine.

d <Display Authentication Screen When Searching>

When searching destinations, to display the user name and password entry screen, press <On>.

- 3 Press <OK>.

■ When authenticating anonymously without using login information

- 1 Press <Do Not Use> in <Authentication Information>.
- 2 Select the combination of the LDAP version and the character code of the server.



- 3 Press <OK>.

LINKS

- ▶ Performing User Authentication when Distributing Device Information(P. 1009)
- ▶ Registering Server Information(P. 823)
- ▶ <Set Destination>(P. 1310)
- ▶ Making SNTP Settings(P. 309)

Monitoring and Controlling via SNMP

961F-04W

SNMP is a protocol for monitoring and controlling communication devices on a network on the basis of a management information database called MIB. You can check the machine's error information and the number of prints through a computer. The machine supports SNMPv1 and SNMPv3 in which security functions are enhanced. You can use either of the two or both. Set each function according to your environment and purposes.

SNMPv1

SNMPv1 determines the communication range on the basis of information called community name. However, as community names are sent to networks as plain text, they may be vulnerable to security issues. To ensure safety, invalidate SNMPv1 and use SNMPv3.

SNMPv3

SNMPv3 enables you to implement network device management with strong security functions.

NOTE

- When SNMP management software is usable, you can set, monitor, and control the machine through a computer. For details, see your software's instruction manuals.

Setting SNMPv1/SNMPv3

1 Press  (Settings/Registration).

2 Press <Preferences> ▶ <Network> ▶ <SNMP Settings>.

3 Set SNMPv1.

- 1 Press <On> in <Use SNMPv1>.
 - If you don't use SNMPv1, press <Off>.
- 2 Press <Set Dedicated Community>, <Set Community Name 1> or <Set Community Name 2>.
 - Dedicated Community is a preset community for Canon Device Management software. To use the Dedicated Community, press <Set Dedicated Community>. To specify a general community, press <Set Community Name 1> or <Set Community Name 2>. For details, see the manual of the software you are using.
- 3 Set the community.



a <Dedicated Community>/<Community Name 1>/<Community Name 2>

To use the selected community, press <On>. When you don't want to use the community, press <Off>.

b <MIB Access Permission>

For each community, select MIB access privileges from <Read/Write> or <Read Only>.

c <Community Name>

Enter a community name that you belong to using alphanumeric characters. If you select <Set Dedicated Community>, you cannot set an exclusive community name.

4 Press <OK>.

4 Set SNMPv3.

1 Press <On> in <Use SNMPv3>.

- If you don't use SNMPv3, press <Off>.

2 Press <Administrator Settings>.

3 Specify the necessary settings, and press <OK>.



a <Use Administrator>

If you use Administrator, set to <On>.

b <Encryption Password>

If you use a password which is different from the authentication, deselect <Use Same Password as for Authentication>, press <Encryption Password>, and enter the password.

NOTE

- If "Administrator" is disabled, you cannot set <Administrator Settings> (the setting of <Use Administrator> is fixed to <Off>).

4 Press <User Settings> ► <Register>.

5 Enter the necessary information.



a <User Name>

Enter a user name using alphanumeric characters.

NOTE

- You cannot use the characters "Administrator" for a user name to register. If you want to use the characters "Administrator," you need to set <Use Administrator> to <Off> under <Administrator Settings>.

b <MIB Access Permission>

Select MIB access privileges from <Read/Write> or <Read Only>.

c <Security Settings>

Set a combination of authentication and encoding. Select <Auth. Yes/Encrypt. Yes>, <Auth. Yes/Encrypt. No>, or <Auth. No/Encrypt. No>.

d <Authentication Algorithm>

Select MD5, SHA1, or SHA2 according to your environment. For SHA2, select from four hash lengths (224 bit, 256 bit, 384 bit, or 512 bit).

e <Authentication Password>

Enter a password to use for authentication. When the password is entered, <Confirm> is displayed for confirmation. Enter the password again.

f <Encryption Algorithm>

Select <DES> or <AES> according to your environment.

g <Encryption Password>

Enter a password to use for encoding. When the password is entered, <Confirm> is displayed for confirmation. Enter the password again.

6 Press <OK> ► <OK>.

7 Press <OK>.

5 Configure settings in <Retrieve Printer Mngt. Information from Host>.

- If you set to <On>, you can periodically acquire printer management information such as printing protocol from a computer on the network by using SNMP.

6 Press <Next>.

7 Configure settings in <Reject SNMP Packets While in Sleep Mode>.

- SNMP data cannot be received while in sleep mode.

NOTE

- If you set to <On>, you may not be able to access the machine from Canon Software (iW series) or applications using the SNMP protocol.

8 Press <OK>.

9 Press  (Settings/Registration) ▶ <Yes>.

NOTE

- When using SNMPv1 and SNMPv3 in combination, it is recommended to set MIB access privileges for SNMPv1 to <Read Only>. If you set <Read/Write>, almost all of the machine's operations become practicable and the strong security functions of SNMPv3 will not be effective. Access privileges to MIB can be set in either SNMPv1 or SNMPv3. In SNMPv3, you can set them for each user.

Setting Static Routing

961F-04X

You can set static routing to manually specify the network route.

For example, when sending data from a machine connected to other networks via a router with both the main line and sub line, the data can be sent via the gateway of the sub line instead of the gateway of the main line that is normally used.

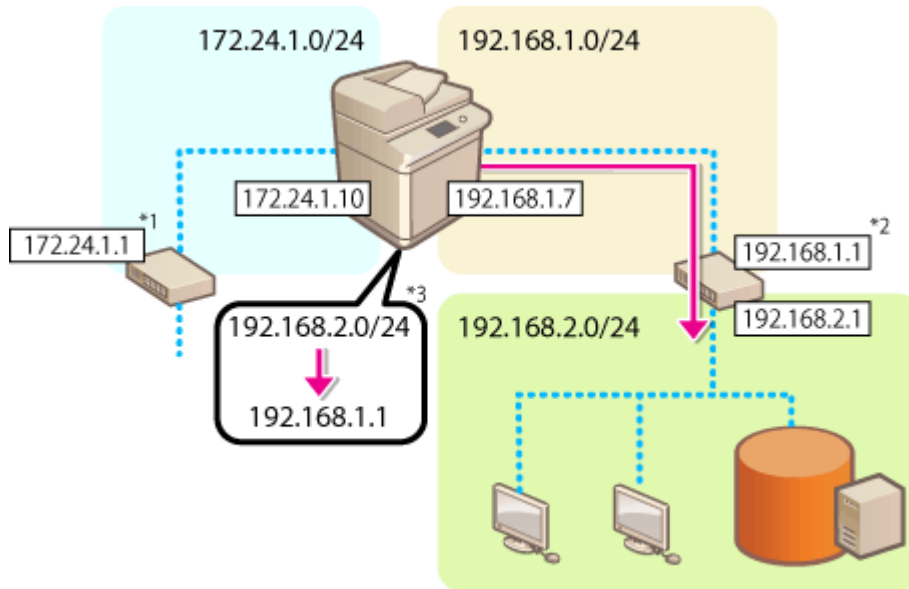

*1 Main line gateway

*2 Sub line gateway

*3 Static routing settings

NOTE

- When connecting to another network via a router, enter the gateway address in <IP Address Settings> in advance. [▶Setting an IPv4 Address\(P. 279\)](#) [▶Setting the IPv4 Address of the Sub Line\(P. 284\)](#)

- 1 Press  (Settings/Registration).
- 2 Press <Preferences> ▶<Network> ▶<Static Routing Settings>.
- 3 Press <On> for <Static Routing Settings>.
- 4 Select the line to register the static routing information from the list ▶ press <Edit>.
- 5 Enter <Address> and <Prefix Length> ▶ press <Next>.
 - Press each button and enter the required setting.

6 Enter the gateway address ► press <OK> ► <OK>.

7 Press  (Settings/Registration) ► <Yes>.

NOTE

- The route order is displayed in <Order> on the static routing settings screen.
- You can register up to 16 devices that can be connected.
- The success/failure of the static routing settings is displayed in <Routing Regist.>. An error message is also displayed on the bottom of the screen.
- When failure is indicated in <Routing Regist.>, select the static routing settings that failed and set the address and gateway address again.

Other Network Settings

961F-04Y

Set the following according to your network environment.

- ▶ **Setting the PASV Mode of FTP(P. 309)**
- ▶ **Making SNTP Settings(P. 309)**
- ▶ **Monitoring the Machine From Device Management Systems(P. 310)**

Setting the PASV Mode of FTP

PASV is an FTP communication mode that is used during file transfer. Press <On> for this setting to enable the machine to connect to an FTP server even if the machine is within a firewall. Confirm beforehand that the PASV mode is set on the FTP server side.



Making SNTP Settings

SNTP is a protocol to adjust time using a time server on the network. SNTP is used when time needs to be adjusted between the machine and the server in cases when security authentication is done at the time of accessing an LDAP server. Set the time difference (time zone) beforehand because actions are based on Coordinated Universal Time (UTC). ▶ **Setting the Date/Time(P. 261)**

- 1** Press (Settings/Registration).
- 2** Press <Preferences> ▶ <Network> ▶ <TCP/IP Settings> ▶ <SNTP Settings>.
- 3** Press <On> in <Use SNTP> and carry out the necessary settings.



a <Polling Interval>

Specify the prescribed interval in minutes to adjust the time.

b <NTP Server Address>

Enter the IP address of the NTP server. When the DNS server is used, instead of an IP address, you can enter "host name.domain name" (FQDN) using alphanumeric characters. (Example: "ntp.example.com").

c <Check NTP Server>

You can check the communication status between a registered server and the SNTP. When a connection is made properly, "OK" is displayed. However, only the communication status is confirmed and time adjustment is not carried out.

NOTE

- To perform time synchronization via SNTP with the NTP server, setting the time zone where the machine is used is required in advance. [▶Setting the Date/Time\(P. 261\)](#)
- If SNTP is not set, the machine may access an external SNTP server to synchronize the clock when certain services are used.

4 Press <OK>.

5 Press (Settings/Registration) ▶ <Yes>.

Monitoring the Machine From Device Management Systems

When device management software is employed, you can collect/manage various information such as setting information, address information, and device failure information on the network through the server.

1 Press (Settings/Registration).

2 Press <Preferences> ▶ <Network> ▶ <TCP/IP Settings> ▶ <Multicast Discovery Settings>.

3 Set <Response> to <On>, press <Scope Name> and enter a scope name.

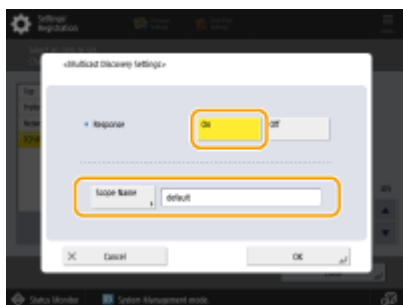

- Enter a scope name specified using Multicast Discovery Settings in <Scope Name>.

4 Press <OK>.

5 Press (Settings/Registration) ▶ <Yes>.

LINKS

[▶<Network>\(P. 1080\)](#)

Configuring System Data Communication

961F-050

The settings described in this section are required to use the sub line for performing DNS name resolution and data communication via a proxy. Administrator or NetworkAdmin privileges are required to specify these settings.

NOTE

- The DNS server address setting and proxy settings for the sub line can only be used for specific system data communication, such as using the sub line to access a firmware distribution server. They cannot be used for a regular internet connection. When using a DNS server or proxy server for the sub line for applications other than system data communication, register the addresses and port numbers to use with the sub line in the settings of the main line.

- ▶ **Setting the DNS of the Sub Line(P. 311)**
- ▶ **Proxy Settings of the Sub Line(P. 312)**

Setting the DNS of the Sub Line

- Press  (Settings/Registration).
- Press <Preferences> ▶ <Network> ▶ <Sub Line Settings> ▶ <Settings for System Data Communic.> ▶ <DNS Server Address Settings>.
- Specify the required settings.
 - Enter the IP address of the DNS server, according to your environment.



- Press <OK>.
- Press  (Settings/Registration) ▶ <Yes>.

Proxy Settings of the Sub Line

- 1 Press  (Settings/Registration).
- 2 Press <Preferences> ▶ <Network> ▶ <Sub Line Settings> ▶ <Settings for System Data Communic.> ▶ <Proxy Settings>.
- 3 Press <On> for <Use Proxy> ▶ configure the required settings ▶ press <OK>.



a <Server Address>

Enter the address of the proxy server to use. Specify the settings, such as the IP address and host name, according to your environment.

b <Port Number>

Enter the port number of the proxy server.

c <Set Authentication>

Press this to set the authentication information when using the authentication function of a proxy server. Press <On> on the displayed screen, enter the user name and password for proxy authentication, and press <OK>.

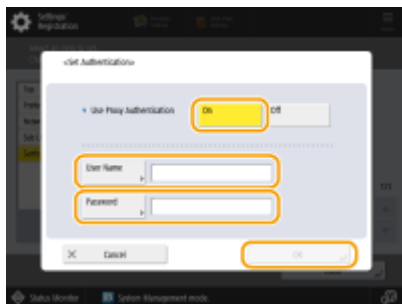

- 4 Press  (Settings/Registration) ▶ <Yes>.

LINKS

- ▶ Selecting the Network Connection Method(P. 267)
- ▶ Making DNS Settings(P. 289)
- ▶ Setting a Proxy(P. 862)

Installing Drivers

961F-051

Install the printer driver, fax driver, and drivers for other system options as well as related software on your computer.

1 Make preparations before installation.

- Equip the main unit with optional equipment ( **Optional Equipment(P. 173)**).
- Install the drivers and software to use by downloading them from the Canon website for your country/region, accessed via the URL (<https://global.canon/en/support/>).
- To install drivers and/or software for a system option with a CD-ROM included, insert the CD-ROM into the computer's CD-ROM drive.

NOTE

- The latest versions of drivers and software are uploaded to the Canon website when they become available. Download them as needed after checking the operating environment for your machine.
- Some functions of drivers and software may not be available depending on the model of the machine or operating environment.
- Some drivers may not be fully compatible with the operating system you are using. Check the driver compatibility with latest versions of operating systems on the Canon website.

2 Carry out installation of the drivers.

- For details on the installation, see the manuals for the drivers and software you want to use.

IMPORTANT

- If communication via the relevant IP address is not permitted in <Firewall Settings>, you cannot install the driver. For more information, see Specifying IP Addresses in Firewall Settings.
- After you have installed the driver, if communication via the IP address of the computer you have installed it on is not permitted in <Firewall Settings>, you cannot print or send a fax from that computer.

Fax Line Settings

961F-052

To use the fax on the machine, register the fax number and company or department name to be displayed/printed at the receiving party's fax machine when sending a fax. Also, set the communication channel type.

NOTE

Models with an optional fax function

- To use the fax function, the required fax options must be installed. **▶System Options(P. 1597)**
- If you want to use the machine as a Remote Fax client machine, the <Register Unit Name> and <Select Line Type> settings in the procedure below are not required.

1 Press  (Settings/Registration).

2 Press <Function Settings> ▶ <Send> ▶ <Fax Settings> ▶ <Set Line>.

3 Press <Line 1> ▶ <Register Unit Telephone Number>.

4 Enter a fax number and press <OK>.

- The fax number you registered will be notified to the recipient.

5 Enter a name in <Register Unit Name> and press <OK>.

- The name you registered will be notified to the recipient.

NOTE

- Instead of the unit name you specified, you can show or print the sender's name. **▶Basic Operations for Sending Faxes(P. 524)**

6 Select a line type in <Select Line Type>, press <OK>.

- If you are not sure what kind of line type you are using, please contact your dealer or the sales office of your telephone company.

NOTE

Configure the setting according to the fax option.

- You can edit the line name that is displayed in the line selection screen using <Edit Line Name for Select Line Screen>*1. **▶<Edit Line Name for Select Line Screen>(P. 1260)**
- You can change the display of the address list according to the selected line in <Default Address List When Selecting Line>*1. **▶<Default Address List When Selecting Line>(P. 1260)**

*1 Indicates items that may not be displayed on the Settings/Registration screen, depending on the model of your machine or the region.

LINKS

- ▶ **Faxing(P. 519)**
- ▶ **Options(P. 171)**

Setting E-mail/I-Fax Communication

961F-053

To directly send scanned documents via e-mail/I-fax without going through a computer, you need to configure communication settings such as a mail server, authentication methods, etc. Generally, an SMTP server is used for sending, and an SMTP server or a POP3 sever is used for receiving. You can set encoding and other parameters. For details about necessary settings, contact the Internet service provider or network administrators.

1 Press  (Settings/Registration).

2 Press <Function Settings> ▶ <Send> ▶ <E-Mail/I-Fax Settings> ▶ <Communication Settings>.

3 Set communication.



a <SMTP RX>

Press <On> when you want to make the machine an SMTP server to receive e-mails and I-faxes. Be aware that you cannot receive via SMTP if you don't register the host name of the machine on the DNS server.

b <SMTP Server>

Enter an SMTP server name (or an IP address).

c <E-Mail Address>

Enter the machine's e-mail address.

- You can specify any name as the user name (part at the left of @ mark). Enter the registered host name at the right of the @ mark.

d <POP Server>

Enter a POP3 server name (or an IP address).

e <POP Login Name>

To use a POP3 server, enter the user name of the specified mail account using alphanumeric characters.

f <POP Password>

To use a POP3 server, enter the password of the specified mail account.

g <POP Interval>

You can set the interval to automatically issue POP in minutes.

h <Authent./Encryption>

Display the screen to set authentication and encryption.

i <Check Connection>

Press this button to check the connection for <SMTP Server> and <POP Server> after specifying the settings.

j <POP>

Press <On> when you want to receive e-mails and I-faxes using a POP3 server.

■ Setting POP authentication before sending and encryption communication to/from the POP server

POP authentication before sending (POP before SMTP) is a confirmation of users by the POP server (reception mail server) before sending, which is a function to block unauthorized e-mails sent by third parties. When the POP server supports TLS, communication can be encoded.

- 1 Press <Authent./Encryption>.
- 2 Specify each item.

**a <POP Auth. Method>**

Set the authentication methods of the POP3 server. To encode the password during authentication, select <APOP>. To authenticate users when receiving mail (POP), select <POP AUTH>.

b <POP Authentication Before Sending>

To perform authentication using the POP3 server, press <On>.

c <Allow TLS (POP)>

To encode the communication to/from the POP3 server using TLS, press <On>. When <On> is set, you can confirm the TLS server certificate during communication with the server and add CN to the verification items. ▶<Confirm TLS Certificate for POP RX>(P. 1243)

- 3 Press <OK>.

■ Setting SMTP authentication and encryption communication to/from the SMTP server

SMTP authentication (SMTP AUTH) verifies users by checking user names and passwords when e-mails are sent. It can also encode SMTP communication (sent and received). To encode SMTP reception using TLS, prepare key pairs beforehand. ▶<Configuring the Key and Certificate for TLS>(P. 864)

- 1 Press <Authent./Encryption>.
- 2 Specify each item.



a <SMTP Authentication (SMTP AUTH)>

To use SMTP authentication, press <On>, enter the user name and password of the specified mail accounts in <User Name> and <Password>.

NOTE

User name and password

- <User Name> and <Password> for <SMTP Authentication> are also used when forwarding received documents.
- Forwarding is performed as "Fixed Device Authentication" regardless of the <Information Used for SMTP Server Authentication> settings. (▶<Information Used for SMTP Server Authentication>(P. 1195))

b <Allow TLS (SMTP RX)>

To encode communication using TLS when receiving e-mails and I-faxes using the SMTP server, press <Always TLS> or <On>. When you don't want to receive data other than encoded data, select <Always TLS>.

c <Display Auth. Screen When Sending>

When sending e-mails and I-faxes, to display the user name and password entry screen, press <On>.

d <Allow TLS (SMTP TX)>

To encode the communication to/from the SMTP server using TLS, press <On>. When <On> is set, you can confirm the TLS server certificate during communication with the server and add CN to the verification items. ▶<Confirm TLS Certificate for SMTP TX>(P. 1242)

NOTE

When setting SMTP authentication

- Specify the authentication method using one of the following three methods.
 - Fixed Device Authentication
 - Entering the authentication information when sending
 - Registering information for each user

Fixed Device Authentication: When <User Name> and <Password> entered into <SMTP Authentication (SMTP AUTH)> are used and the authentication screen (<Log in to SMTP Server>) is not displayed when sending

- Specify the settings as follows.
 - <SMTP Authentication (SMTP AUTH)>: <On>
 - <User Name>: Enter the user name.
 - <Password>: Enter the password.
 - <Display Auth. Screen When Sending>: <Off>
 - ▶<Information Used for SMTP Server Authentication>(P. 1195) : <Device Settings>

Entering the authentication information when sending: When <User Name> and <Password> entered into <SMTP Authentication (SMTP AUTH)> are used and the authentication screen (<Log in to SMTP Server>) is displayed when sending

- <User Name> and <Password> entered into <SMTP Authentication (SMTP AUTH)> are entered as the authentication information when sending.
- When <User Name> and <Password> for <SMTP Authentication (SMTP AUTH)> are not entered (blank), the authentication information when sending is also blank.
- Specify the settings as follows.
 - <SMTP Authentication (SMTP AUTH)>: <On>
 - <User Name>: Enter the user name.
 - <Password>: Enter the password.
 - <Display Auth. Screen When Sending>: <On>
 -  **<Information Used for SMTP Server Authentication>(P. 1195)** : <Device Settings>

Registering information for each user: When <Register Info. for Each User> is used and the authentication screen (<Log in to SMTP Server>) is not displayed when sending

- SMTP authentication is performed using the user name and password registered in the local device.
- Specify the settings as follows.
 - <SMTP Authentication (SMTP AUTH)>: <On>
 - <Display Auth. Screen When Sending>: <Off>
 -  **<Information Used for SMTP Server Authentication>(P. 1195)** : <Register Info. for Each User>

3 Press <OK>.

4 Press <OK>.

IMPORTANT

- Depending on your environment, you might need to specify the SMTP/POP3 port number. For details, contact the Internet service provider or the network administrators.  **<Specify Port Number for SMTP TX/POP RX>(P. 1241)**

LINKS

-  **Specifying E-Mail Settings(P. 695)**
-  **Using Internet Faxes (I-Fax)(P. 582)**

Setting the Advanced Space of the Machine

961F-054

The storage device installed in the machine has a public space called "Advanced Space." It can be made available on the same network using the SMB or WebDAV protocol. Accordingly, you can easily implement file sharing with computers and other Canon multifunction printers* without introducing a server. In addition, you can increase the storage capacity by connecting the machine to the Advanced Space of other multifunction printers. To utilize such functions, adjust settings for sharing files beforehand. Here, the procedures are described as follows.

* Available only for imageRUNNER ADVANCE series machines connected to a network

▶ **Setting Advanced Space to Public(P. 321)**

Setting Advanced Space to Public

961F-055

Open the storage space (Advanced Space) on the network to share files. Specify information such as file types to be saved. You can create an exclusive space for personal use in the Advanced Space. To make the Advanced Space available on a network, you need to set the machine to be used as the SMB server or WebDAV server ([▶Making SMB Settings\(P. 294\)](#) or [▶Making WebDAV Settings\(P. 298\)](#)).

- ▶[Advanced Space Batch Settings\(P. 321\)](#)
- ▶[Sending E-Mail Notification When Saving Is Complete\(P. 323\)](#)

Advanced Space Batch Settings

1 Press  (Settings/Registration).

2 Press **<Function Settings>** ▶ **<Store/Access Files>** ▶ **<Advanced Space Settings>** ▶ **<Unified Advanced Space Settings>** ▶ **<Next>**.

3 Set the method to make the Advanced Space available to the network and press **<Next>**.

- If you want to make the Advanced Space available to the outside as a WebDAV server, press **<By WebDAV>**.
- If you want to make the Advanced Space available to the outside as an SMB server, press **<By SMB>**.

IMPORTANT

- If you set to **<WebDAV>**, the **<Use WebDAV Server>** is set to **<On>**. If you set to **<By SMB>**, the **<Use WebDAV Server>** setting in **<SMB Server Settings>** is set to **<On>**.
 - ▶[Making WebDAV Settings\(P. 298\)](#)
 - ▶[Making SMB Settings\(P. 294\)](#)

4 Set the Advanced Space.

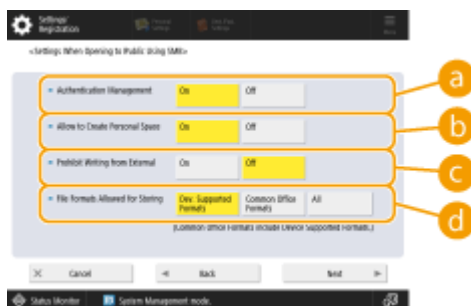

a **<Authentication Management>**

To manage authentication, press **<On>**.

b **<Allow to Create Personal Space>**

To create an exclusive folder for personal use in the Advanced Space, press **<On>**. If **<Authentication Management>** is not set to **<On>**, setting is not possible.

c **<Prohibit Writing from External>**

To create an exclusive folder for personal use in the Advanced Space, press <On>.

d <File Formats Allowed for Storing>

Select one of the file formats to be saved in the Advanced Space.

<Dev. Supported Formats>	pdf, jpg, jpe, jpeg, tif, tiff, xps, pptx, oxps format files
<Common Office Formats>	In addition to the files in <Dev. Supported Formats>, doc, xls, csv, ppt, txt format and general-purpose files.
<All>	All file formats.

5 Press <Next> and carry out the necessary settings.

■ If you set to <By WebDAV>

Set whether to use TLS and press <Next>.

- If you use TLS, press <On>. Configure the setting of the keys and certificates. **▶ <Configuring the Key and Certificate for TLS>(P. 864)**
- If you set the <Authentication Management> and TLS setting to <On>, the setting of <Authentication Type> in <WebDAV Server Settings> is set to <Basic>. **▶ <WebDAV Server Settings>(P. 1293)**

■ If you set to <By SMB> and set the <Authentication Management> setting to <On>

1 Select the authentication type.



a <Require SMB Signature for Connection>

To request an SMB packet signature when connecting to an SMB server, press <On>.

b <Require Encryption for Connection>

To request a connection with SMB 3.0/3.1 encrypted communication when connecting to an SMB server, press <On>.

c <Authentication Type>

If you set the authentication type, <Use SMB Authentication> in <SMB Server Settings> is set to <On>. **▶ <SMB Server Settings>(P. 1093)**

2 Press <Next>.

■ If you set to <By SMB> and set the <Authentication Management> setting to <Off>

You don't need to configure the setting. Proceed to Step 6.

6 Press <OK>.

7 Press  (Settings/Registration) ▶ <Yes>.

NOTE



- Even if <Prohibit Writing from External> is set to <On>, users with the Administrator privileges can perform the following operations.
 - Operate folders/edit files by directly connecting to the Advanced Space from Windows Explorer on a computer.
 - Operate folders/edit files from <Network> in <Scan and Store> or <Access Stored Files> on the touch panel display.

Sending E-Mail Notification When Saving Is Complete

You can notify a user via e-mail that a file has been saved in the Advanced Space of the machine. The notification e-mail contains the path (URI: Uniform Resource Identifier) to the folder that includes the file.

NOTE

- A maximum of 16 URI TX Settings can be registered.

- 1** Start the Remote UI.  Starting the Remote UI(P. 902)
- 2** Click [Settings/Registration] on the portal page.  Remote UI Screen(P. 904)
- 3** Click [Store/Access Files] ▶ [Advanced Space Settings].
- 4** Click [URI TX Settings].
- 5** Click [Enable].
 - The notification status changes to <Enabled>, and all the registered URI TX Settings are enabled.
- 6** Click [Register New...].
- 7** Carry out the necessary settings.

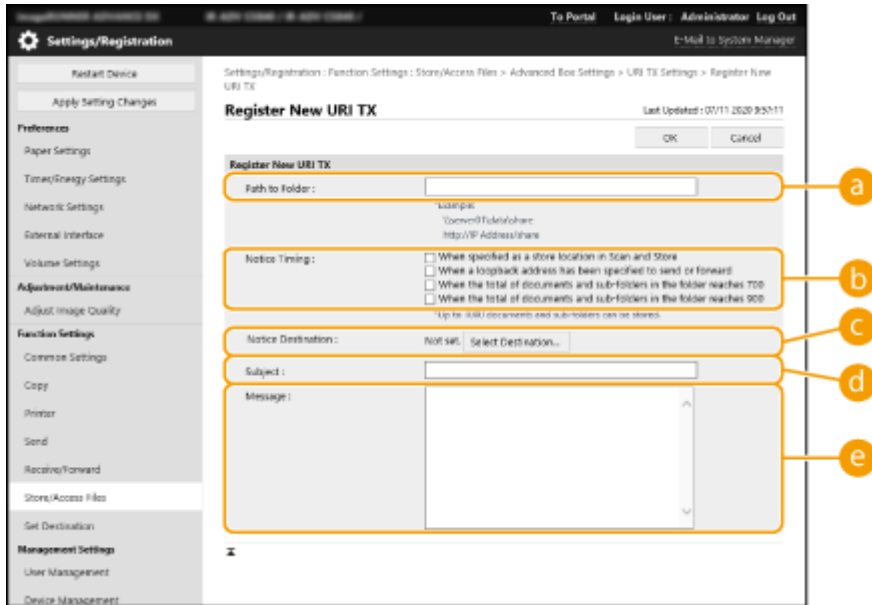

a [Path to Folder]

Enter the path of the folder to notify.

■ When the Advanced Space Is Opened as an SMB Server

Enter the IP address or host name of the machine plus "\share" or "\users", followed by "\folder_name".

- Input example (to specify the "documents" folder in the Shared Space)
\\192.168.1.21\share\documents
- Input example (to specify the "suzuki" folder in the Personal Space)
\\192.168.1.21\users\suzuki

■ When the Advanced Space Is Opened to Public as a WebDAV Server

Enter the URL in the format "http(s)://<IP address or host name of the machine>/<share or users>/<folder name>".

- Input example (to specify the "documents" folder in the Shared Space when SSL is disabled)
http://192.168.1.21/share/documents
- Input example (to specify the "suzuki" folder in the Personal Space when SSL is enabled)
https://192.168.1.21/users/suzuki

b [Notice Timing]

Select the timing for sending the URI TX.

<p>[When specified as a store location in Scan and Store]</p>	<p>Notification is sent each time a file is saved in the specified folder inside the Advanced Space from <Scan and Store> on the touch panel display. However, notification is not sent when a file is saved in or a folder is added to a subfolder.</p>
<p>[When a loopback address has been specified to send or forward]</p>	<p>Notification is sent each time a file is saved in the specified folder inside the Advanced Space from a loopback address (an address that indicates this machine on a network) using the Sending or Forwarding function. However, notification is not sent when a file is saved in or a folder is added to a subfolder. Specify a loopback address when using the Advanced Space of the machine as the destination for <Scan and Send> or <Forwarding Settings>. ▶ Registering Destinations in the Address Book(P. 394)</p>

[When the total of documents and sub-folders in the folder reaches 700]	Notification is sent when the total number of files and subfolders in the folder specified for notification in a reaches 700. Files and folders inside subfolders are not counted.
[When the total of documents and sub-folders in the folder reaches 900]	Notification is sent when the total number of files and subfolders in the folder specified for notification in a reaches 900. Files and folders inside subfolders are not counted.

NOTE

- You can save a maximum of 1,000 files or sub-folders inside the specified folder.

c [Notice Destination]

Specify the destination e-mail address in [Select Destination].

NOTE

- You can set a single e-mail address registered in the address book or a single e-mail address group as the destination to notify.

d [Subject]

Enter the subject for the e-mail (up to 40 characters).

e [Message]

Enter the message for the e-mail (up to 140 characters).

NOTE

- In addition to the text entered here, the path to the folder specified in **a** and the file name are also added to the e-mail message.

8 Click [OK].

LINKS

- ▶ **Using as a Simple File Server(P. 708)**

Connecting to the Other Devices

961F-056

The machine can be connected to a computer (Windows server) or Advanced Space of other Canon multifunction printers on a network. The machine can print/send data saved in the connected Windows server or Advanced Space. Conversely, other multifunction printers can retrieve data from the Advanced Space of the machine.

NOTE

- To connect the machine to the storage spaces on other multifunction printers, settings of the other printers are also necessary. **▶Setting Advanced Space to Public(P. 321)**

1 Press  (Settings/Registration).

2 Press <Function Settings> ▶ <Store/Access Files> ▶ <Network Settings>.

3 Specify each item.

■Registering multifunction printers to connect to

Register the Windows server or Advanced Space of other multifunction printers to connect to.

- Press <Network Place Settings> ▶ <Register>.
- Enter the necessary information and press <OK>.



a <Name>

Enter the name of the Advanced Space to connect to. As a name entered here is displayed on the list at the time of access, enter a name that is easy to read.

b <Protocol>

Select <SMB> or <WebDAV>, depending on whether the Windows server or Advanced Space of destination is made available as an SMB server or WebDAV.

c <Location>/<Host Name>

<Location> is displayed when you select <SMB>, and <Host Name> is displayed when you select <WebDAV> in the protocol setting.

- Enter the address in <Location> as "\\ (host name or IP address) \share" to connect to a shared space, or "\\ (host name or IP address) \users" to connect to personal space.
- Enter the address in <Host Name> as "https:// (host name or IP address)", and press <Next>. Then, enter "/share" for the shared space or "/users" for the personal space in <Folder Path>.

IMPORTANT

- Do not register something other than the Advanced Space of another imageRUNNER ADVANCE series machine or a Windows server which is opened externally, as this may cause the machine to malfunction.

■ Controlling communication protocols

Select the communication protocol to use when making an external reference to a Windows server or Advanced Space of other Canon multifunction printers on a network. However, if only one of them is used, you can increase the security by disabling unnecessary settings.

- 1 Press <Protocol for External Reference>.
- 2 Press <On> of the protocol you use, then press <OK>.

IMPORTANT

- When connection via SMB is not used, set the <SMB> setting to <Off>. When connection via WebDAV is not used, set the <WebDAV> setting to <Off>.

■ Verifying the certificate when connecting

When the Windows server or Advanced Space to connect to is set to use TLS, you can verify the TLS server certificate sent from the connected device when connecting. Because a connection will be canceled if an error occurs, attacks such as identity theft by third parties can be prevented.

- 1 Press <Confirm TLS Certificate for Network Access>.
- 2 Press <On> ► <OK>.
 - When you press <On>, the screen for adding the verification items is displayed. If you need to verify the CN (Common Name), add a check mark.

IMPORTANT

- If you do not verify the certificate, TLS communication is performed, even with an invalid certificate.

LINKS

- ▶ [Working with Other Devices\(P. 720\)](#)
- ▶ [<Store/Access Files>\(P. 1282\)](#)
- ▶ [Configuring the Key and Certificate for TLS\(P. 864\)](#)
- ▶ [Accessing the Advanced Space from a Computer\(P. 711\)](#)

Basic Operations

Basic Operations	329
Using the Touch Panel Display	331
Basic Screens on the Touch Panel Display	332
Items Displayed on the <Home> Screen	335
Timeline Display Specifications	339
Items Displayed in the Timeline	341
Basic Operation of the Touch Panel Display	347
Entering Characters	353
Logging into the Machine	355
List of Items That Can Be Personalized	357
Customizing the Touch Panel Display	360
Customizing the <Home> Screen	363
Creating a Shortcut for a Frequently Used Function	365
Registering a Combination of Frequently Used Functions	367
Customizing the Basic Features Screen	370
Registering Frequently Used Settings and Destinations as Personal Buttons/Shared Buttons on the <Home> Screen	372
Registering Personal Buttons/Shared Buttons	373
Switching the Displayed Language	377
Registering Shortcuts for Frequently Used Settings/Registered Items	379
Customizing the Screen Display Appearance and the Operational Conditions	380
Canceling Send/Print Jobs	383
Setting Sounds	384
Entering Sleep Mode	387
Registering Destinations	389
About the Address Books of the Machine	391
Registering Destinations in the Address Book	394
Registering Multiple Destinations as a Group	405
Editing the Registered Destinations in the Address Book	408
Registering a Destination in a One-Touch Button	410
Registering a Group in a One-Touch Button	412
Editing the Registered Destinations in One-Touch Buttons	413

Basic Operations

961F-057

This chapter describes basic operations that are common to the use of all functions, such as how to use the control panel. This chapter also provides information on how to read and use the touch panel display, which is the main way of controlling operations from the main unit.

■ Using the Touch Panel Display

This section describes how to use the buttons on the touch panel display to perform various operations, such as adjusting and checking the settings. This section also describes how to enter text and numbers, which are necessary for operations such as registering information in the Address Book and sending faxes.

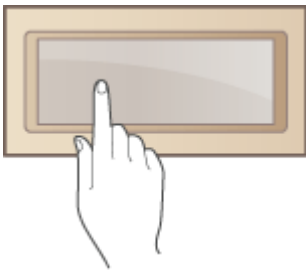

▶ **Using the Touch Panel Display(P. 331)**

■ Logging into the Machine

This section describes how to log in when a login screen is displayed.



▶ **Logging into the Machine(P. 355)**

■ Customizing the Touch Panel Display

This section describes how to arrange buttons and customize menus, making it easier to use the screens displayed on the touch panel.



▶ **Customizing the Touch Panel Display(P. 360)**

■ Canceling Jobs

This section describes how to cancel active send or print jobs.



▶ **Canceling Send/Print Jobs(P. 383)**

■ Specifying the Sound Settings

This section describes how to specify the settings for sounds, such as those produced when fax sending is complete or when an error occurs.



▶ **Setting Sounds(P. 384)**

■ Entering Sleep Mode

This section describes how to set sleep mode.



▶ **Entering Sleep Mode(P. 387)**

■ Registering Destinations

This section describes how to register destinations in the Address Book or one-touch buttons for sending faxes or scanned documents.

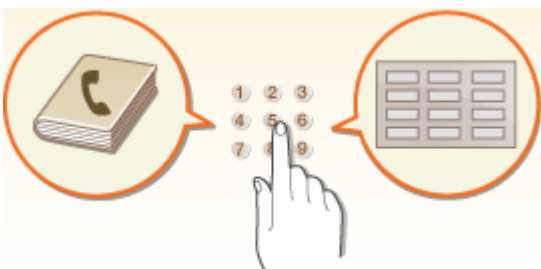

▶ **Registering Destinations(P. 389)**

Using the Touch Panel Display

961F-058

The display of the machine is a touch panel that can be operated by touching directly with your fingers. The screen is used not only for basic functions such as copying and scanning, but also to display various settings, text input, communication status and error messages. In this manual, however, "touch" is indicated as "press."



- ▶ **Basic Screens on the Touch Panel Display(P. 332)**
- ▶ **Basic Operation of the Touch Panel Display(P. 347)**
- ▶ **Entering Characters(P. 353)**

! IMPORTANT

Note the following when handling the touch panel display.

- Do not press too hard on the display. Doing so may break the display.
- Do not use a sharp object, such as a mechanical pencil or ballpoint pen. Doing so may break or scratch the surface of the touch panel display.
- Do not place objects on the display or wipe the display. Doing so may cause the touch panel to react and result in a malfunction.

NOTE

- Peel off the protective film from the touch panel display before use.
- You can customize menus and rearrange frequently used buttons for easier access. You can also combine multiple settings into one button to simplify operations. ▶ **Customizing the Touch Panel Display(P. 360)**

Adjust the brightness of the touch panel display

If it is hard to see the content of the touch panel display, perform the following operation on the <Home> screen to adjust the brightness.



<Adjust Brightness> ▶ adjust the brightness with <+> or <-> ▶ <Close>

LINKS

- ▶ **Control Panel(P. 33)**

Basic Screens on the Touch Panel Display

961F-059

This section describes the various screens displayed on the touch panel display.

<Home> Screen

The <Home> screen is displayed when you press . The <Home> screen displays a list of function buttons and acts as the entrance to various functions. **▶Items Displayed on the <Home> Screen(P. 335)**

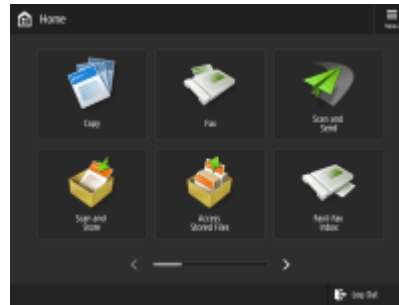
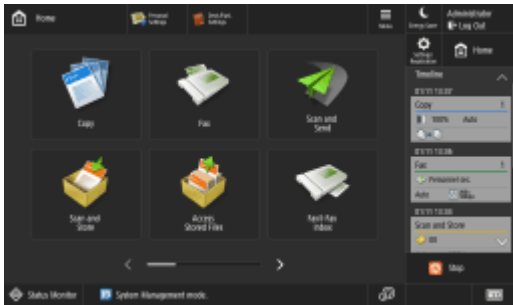

(Models with an upright control panel)

Basic Features Screen of Each Function

On the <Home> screen, press the function buttons to display the Basic Features screen where you can access basic functions such as copying, faxing and scanning. Though the display and setting items on the Basic Features screen differ depending on functions, you can change the settings to suit your needs. **▶Customizing the Basic Features Screen(P. 370)**

Example: Copy Basic Features screen

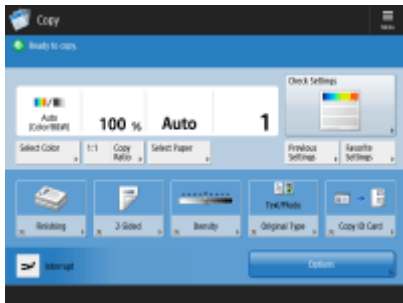

Items displayed differ depending on functions.

- ▶Copy Basic Features Screen(P. 418)
- ▶Fax Basic Features Screen(P. 521)
- ▶Scan Basic Features Screen(P. 637)

<Settings/Registration> Screen

Press  (Settings/Registration) to display the <Settings/Registration> screen. Press this key first to make changes for each setting, such as paper settings, display settings, and network settings. On this screen, you can also register destinations, such as e-mail addresses and fax numbers.

- ▶Settings/Registration(P. 1054)
- ▶Registering Destinations(P. 389)

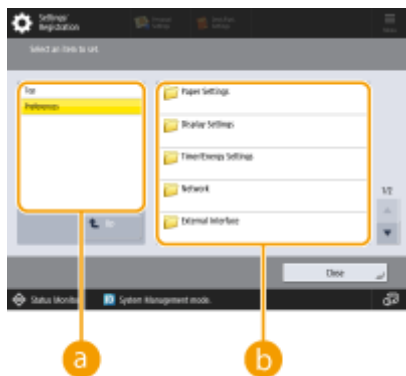

a Current menu level

You can check which level is being displayed for the entire Settings/Registration menu.

b Setting item list

Setting items that belong to the current menu level are displayed in a list.

NOTE

- When there is no menu under the lower level, the setting screen is displayed.

<Status Monitor> Screen

When you press  (Status Monitor), the <Status Monitor> screen is displayed. On this screen, you can check the printing status and transmission status, as well as the remaining amount of toner and memory level.

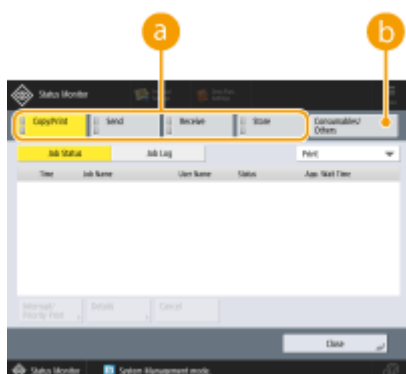

a Status and logs of copy/print/transmission/saved documents

The current status or log of the selected item is displayed. You can cancel copying, printing, and fax transmission on this screen.

- ▶ **Cancelling Copying(P. 431)**
- ▶ **Canceling Sending Faxes(P. 540)**
- ▶ **Scan Basic Features Screen(P. 637)**
- ▶ **Canceling Printing(P. 600)**
- ▶ **Checking the Printing Status and History(P. 602)**

b Consumables

You can check the status of the machine, such as the amount of toner or paper remaining and memory levels.

- ▶ **Hardware Specifications(P. 215)**
- ▶ **Checking the Remaining Amount of Consumables(P. 128)**

Error Screen

In some cases when an error occurs, instructions on how to respond to the error are displayed. Follow the on-screen instructions to solve the problem. ▶ **Countermeasures for Each Message(P. 1425)**

Example: When a paper jam occurs



(Items shown on the screen may differ depending on your model and options.)

TIPS

- Press  displayed on the <Home> screen and the Basic Features screen to customize the screen such as rearranging buttons or creating a shortcut key. ▶ **Customizing the Touch Panel Display(P. 360)**

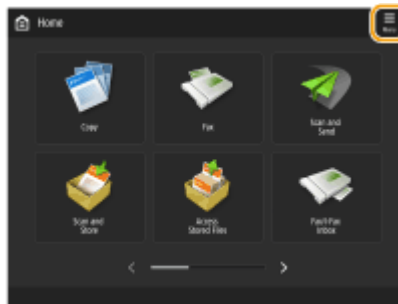

- You can change settings regarding the screen display, such as which screen appears immediately after turning ON the machine, and whether the message appears for remaining paper and toner. ▶ **<Display Settings>(P. 1063)**
- You can set the screen to be displayed when a certain amount of time has passed without operation. ▶ **<Function After Auto Reset>(P. 1075)**

NOTE

-  indicates that data on the storage device is encrypted. ▶ **Managing Storage Device Data(P. 1015)**

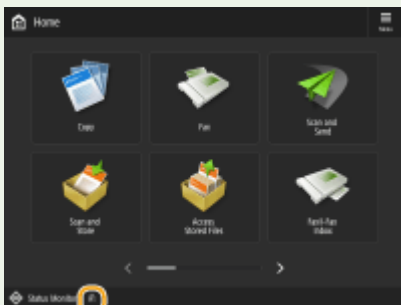

LINKS

- ▶ **Control Panel(P. 33)**

Items Displayed on the <Home> Screen

961F-05A

This section describes the items displayed on the <Home> screen.

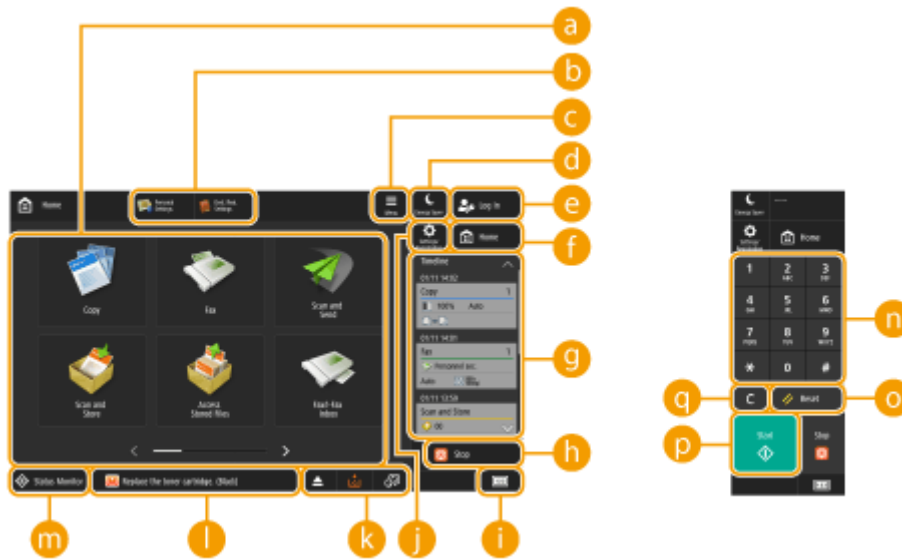

a Function buttons

These buttons enable you to open the basic function screens, such as "Copy" and "Scan and Send".

When frequently used settings and destinations are registered as <Personal>/<Shared>, they are added as buttons.

NOTE

- When you press and hold a button, the settings related to the button appear.

b Shortcuts

You can assign shortcuts to frequently used function buttons. ▶ **Creating a Shortcut for a Frequently Used Function(P. 365)**

c <Menu>

This button enables you to customize and manage the <Home> screen. You can also display the menu by pressing and holding the background.

Customizing the <Home> screen enables you to change the background and button size. Management settings enable you to display/hide the timeline, etc. ▶ **Customizing the <Home> Screen(P. 363)**

NOTE

- You can also display <Menu> by pressing and holding the background of the <Home> screen.

d <Energy Saver>

Press to put the machine into sleep mode. ▶ **Entering Sleep Mode(P. 387)**

e <Log In>/<Log Out>

You can log in/log out by pressing this button. ▶ **Logging into the Machine(P. 355)**

f <Home>

You can display the <Home> screen by pressing this button.

g <Timeline>

You can display the setting history and notices for some functions. For details, see **▶Timeline Display Specifications(P. 339)** .

h <Stop>

Stops a send job or a print job. **▶Canceling Send/Print Jobs(P. 383)**

i Counter/Device Information

Press to display the total number of pages used for operations such as copying or printing on the touch panel display. You can also check the serial number and IP address of the machine, and the device information of optional products. You can also use this item to check the version information of the security chip used for encryption of data in storage.

▶Checking the Number of Pages for Copy/Print/Fax/Scan(P. 1025)

▶Checking the Options Installed on This Machine(P. 1038)

j <Settings/Registration>

Press to start specifying many of the settings for the machine, such as <Preferences> or <Set Destination>. **▶Settings/Registration(P. 1054)**

k Button display area

Depending on the mode and usage status of the machine, the following three types of buttons appear from left to right. Note that the buttons displayed differ depending on your model and the installed options.

- Button for removing USB memory

 : Memory media removal confirmation screen

- Button to the procedure for recovery/replacement/supply

 : Paper jam recovery procedure screen

 : Staple jam recovery procedure screen or staple cartridge replacement procedure screen

 : Toner cartridge replacement procedure screen

 : Waste toner container replacement procedure screen

 : Staple waste/punch waste/trim waste removal procedure screen

 : Replacement part replacement procedure screen

- <Switch Language/Keyboard> button

 : Display language/keyboard switching screen

l Status display area

The status of the machine, processes that are executing, errors, etc. are displayed via messages and icons. **▶Countermeasures for Each Message(P. 1425)**

m <Status Monitor>

You can check the print status, fax sending/receiving status, usage history, etc. It also enables you to check the amount of remaining paper and toner, the error status, etc. ▶ **Using the Touch Panel Display(P. 331)**

n Numeric keys ([0] to [9], [*], [#])

Press to enter numerical values, *, and #. ▶ **Entering Characters(P. 353)**

o <Reset>

Press to cancel the settings and restore the previously specified settings.

p <Start>

Press to start copying or scanning originals. You can adjust the touch time required to begin startup processing. ▶ **<Start Key Touch Recognition Delay>(P. 1153)**

q <C>

Press to clear entered values or characters.

NOTE

- **n** to **q** are displayed on screens other than the <Home> screen.

■ Models with an upright control panel

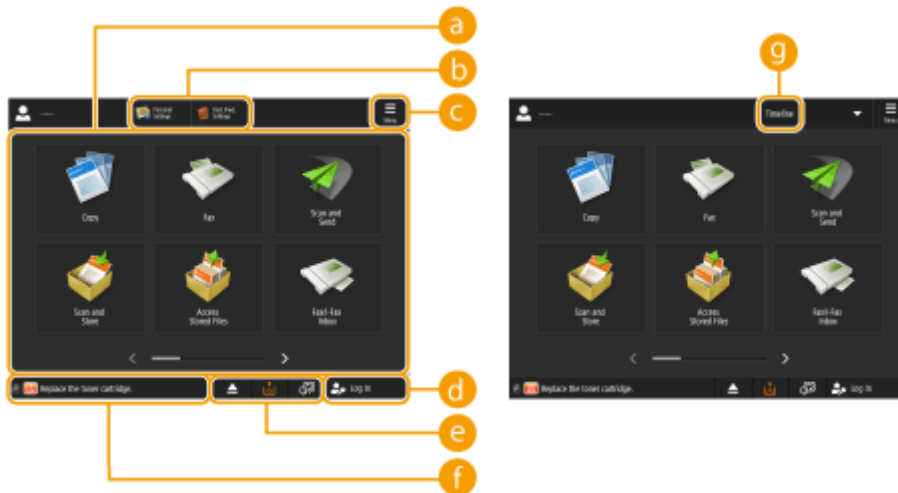

a Function buttons

These buttons enable you to open the basic function screens, such as "Copy" and "Scan and Send". When frequently used settings and destinations are registered as <Personal>/<Shared>, they are added as buttons.

NOTE

- When you press and hold a button, the settings related to the button appear.

b Shortcuts

You can assign shortcuts to frequently used function buttons. ▶ **Creating a Shortcut for a Frequently Used Function(P. 365)**

NOTE

- In the <Home> screen, shortcuts do not appear when  <Timeline> is displayed.

c <Menu>

This button enables you to customize and manage the <Home> screen. You can also display the menu by pressing and holding the background.

Customizing the <Home> screen enables you to change the background and button size. Management settings enable you to display/hide the timeline, etc. ▶ **Customizing the <Home> Screen(P. 363)**

NOTE

- You can also display <Menu> by pressing and holding the background of the <Home> screen.

d <Log In>/<Log Out>

You can log in/log out by pressing this button. ▶ **Logging into the Machine(P. 355)**

e Button display area

Depending on the mode and usage status of the machine, the following three types of buttons appear from left to right. Note that the buttons displayed differ depending on your model and the installed options.

- Button for removing USB memory



: Memory media removal confirmation screen

- Button to the procedure for recovery/replacement/supply



: Paper jam recovery procedure screen



: Staple jam recovery procedure screen or staple cartridge replacement procedure screen



: Toner cartridge replacement procedure screen



: Waste toner container replacement procedure screen



: Staple waste/punch waste/trim waste removal procedure screen



: Replacement part replacement procedure screen

- <Switch Language/Keyboard> button



: Display language/keyboard switching screen

f Status display area

The status of the machine, processes that are executing, errors, etc. are displayed via messages and icons. ▶ **Countermeasures for Each Message(P. 1425)**

g <Timeline>

You can display the setting history and notices for some functions. For details, see ▶ **Timeline Display Specifications(P. 339)** .

Timeline Display Specifications

961F-05C

The following two types of information are displayed in the timeline.

▶ **Setting History(P. 339)**

▶ **Notices(P. 340)**

NOTE

- For information on the icons and items displayed in the timeline, see ▶ **Items Displayed in the Timeline(P. 341)** .
- A timeline can be displayed for each login user. If not logged in, a shared timeline can be displayed for users who do not use authentication, such as unauthenticated users and guest users. Change the settings for <Allow Non-Authentication Users to Use Timeline> and <Allow Each Login User to Use Timeline> according to your needs. ▶ **Customizing the <Home> Screen(P. 363)**
- The timeline for users that do not use authentication, such as unauthenticated users and guest users, is retained when ▶ **<Quick Startup Settings for Main Power>(P. 1073)** is set to <On> and quick startup is performed. When the power is turned OFF with ▶ **<Quick Startup Settings for Main Power>(P. 1073)** set to <Off> or quick startup could not be performed, the timeline for users that do not use authentication, such as unauthenticated users and guest users, is deleted.
- The timeline cannot be imported/exported. ▶ **Importing/Exporting the Setting Data(P. 946)**

Setting History

The timeline is convenient for users who repeatedly use the same settings and destinations for a function such as "Copy" and "Scan and Send". The history of settings used are automatically added to the timeline and can be pressed to recall the same settings.

The timeline displays the settings of the following functions.

- Copy
- Fax
- Scan and Send
- Scan and Store (except when saving to memory media)
- Access Stored Files (printing Mail Box documents, printing Advanced Space files, printing Network files)

NOTE

- The latest 10 items of history are retained as the timeline in chronological order. The history of earlier jobs is deleted from the timeline. When the job before last is used again, the order of the top two jobs is switched but the number of jobs in the timeline does not change. However, if the settings are changed after being recalled, they are deemed to be new settings.

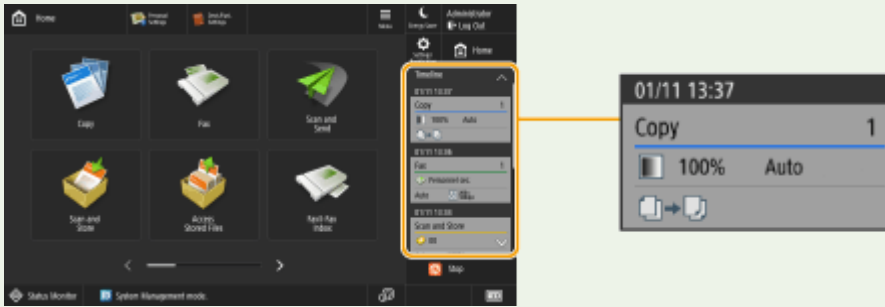

- To delete history that has been automatically added or store the settings of that history to the <Home> screen as a Personal button/Shared button, press and hold the history. However, <Display Confirmation Screen When Recalling> and <Start Operation for Recall (Operation starts when button is pressed.)> cannot be set when registering a Personal button/Shared button from the timeline. **▶Registering Personal Buttons/Shared Buttons(P. 373)**
- When <Restrict Resending from Log> is set to <On>, the history of "Fax" and "Scan and Send" is not retained in the timeline.
- The following passwords can be included in the timeline for each login user.
 - Login passwords to destination file servers for Scan and Send
 - Login passwords to Rights Management servers for Scan and Send
 - Login passwords to Rights Management servers for Scan and Store
 - Encryption passwords for Scan and Store (<Password Required to Open Document> and <Password Required to Change Permission>)
- Whether to include the password in the timeline of the logged in user can be changed in **▶<Prohibit Caching of Authentication Password>(P. 1366)** . However, the password in <Password> for the fax function is retained in the timeline, regardless of the **▶<Prohibit Caching of Authentication Password>(P. 1366)** setting.
- The password is not retained in the timeline for unauthenticated users or guest users regardless of the **▶<Prohibit Caching of Authentication Password>(P. 1366)** setting. However, if the password in <Password> for the fax function is set, it is not displayed in the timeline.
- If **▶<Manage Address Book Access Numbers>(P. 1312)** is set to <On>, the send job log ("Fax" and "Scan and Send") for unauthenticated users and guest users is not displayed in the timeline.
- The setting history of the user that is logged in can be shared with multiple machines as personalization data using setting synchronization. **▶List of Items That Can Be Personalized(P. 357)**
- With Access Stored Files, files are saved to the timeline together with the settings they are printed with. You cannot select another file and reuse the settings only. The corresponding timeline settings also cannot be used if a file has been deleted or moved.

Notices

Notices are displayed when the user that is logged in has unprinted jobs. Printing can be executed by displaying the print screen from the displayed timeline.

NOTE

- Notices are not displayed in the timeline if <Personal> is set to <Off> in **▶<Job List Display Settings>(P. 1303)** .
- If **▶<Display Other User Jobs>(P. 1302)** is set to <On>, the total number of unprinted jobs for the user that is logged in and unprinted jobs for other users is displayed in the notices.

Items Displayed in the Timeline

961F-05E

The items displayed in the timeline differ according to the function. The items for each function are described here.

- ▶ Copy(P. 341)
- ▶ Fax(P. 342)
- ▶ Scan and Send(P. 343)
- ▶ Scan and Store (Mail Box)(P. 343)
- ▶ Scan and Store (Advanced Space/Network)(P. 344)
- ▶ Access Stored Files (Mail Box/Advanced Space/Network)(P. 345)
- ▶ Print(P. 345)

Copy

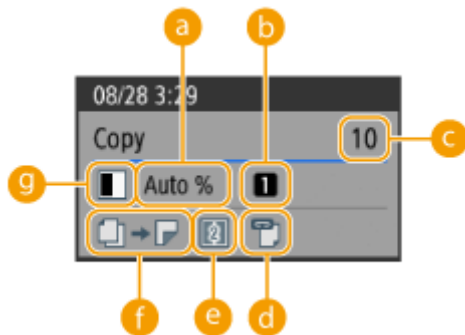







- a** Zoom ratio
- b** Paper source
- c** Number of copies
- d** Staple (blank if not set)
- e** N on 1 (blank if not set)
- f** Two-sided/booklet setting
- g** Color mode

NOTE

- The icons for the two-sided/booklet setting indicate the following.



Not set

-  One-sided to two-sided
-  Two-sided to one-sided
-  Two-sided to two-sided
-  Facing pages to two-sided
-  Booklet (Booklet Scan/Do Not Booklet Scan) set
-  Booklet (Booklet Scan/Do Not Booklet Scan) and two-sided original set

Fax

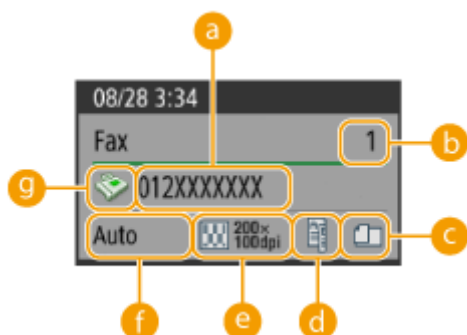

- a Destination**
- b Number of broadcast destinations**
- c Different size originals (blank if not set)**
- d Two-sided (blank if not set)**
- e Resolution**
- f Scan size**
- g Destination type**

NOTE

- The icons for the two-sided setting indicate the following.

 Book type

 Calendar type

Scan and Send

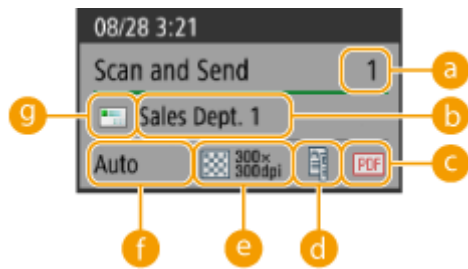

a Number of broadcast destinations

b First destination

c File format

d Two-sided (blank if not set)

e Resolution

f Scan size

g Destination type of the first destination

NOTE

- The icons for the two-sided setting indicate the following.

 Book type

 Calendar type

Scan and Store (Mail Box)

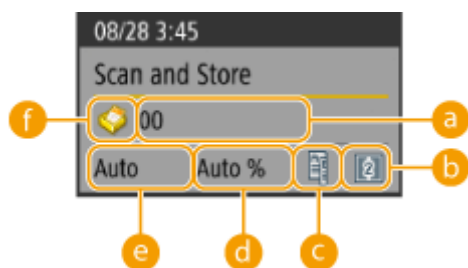

- a Mail Box number/name
- b N on 1 setting
- c Two-sided (blank if not set)
- d Zoom ratio
- e Scan size
- f Mail Box icon (fixed)

NOTE

- The icons for the two-sided setting indicate the following.

 Book type

 Calendar type

Scan and Store (Advanced Space/Network)

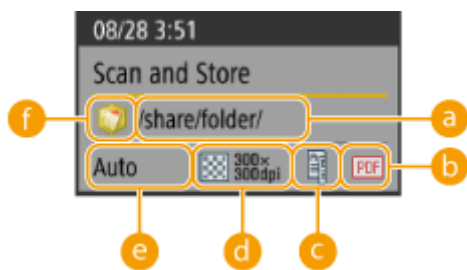

a Folder name

b File format

c Two-sided (blank if not set)

d Resolution

e Scan size

f Mail Box icon

NOTE

- The icons for the two-sided setting indicate the following.

 Book type

 Calendar type

Access Stored Files (Mail Box/Advanced Space/Network)

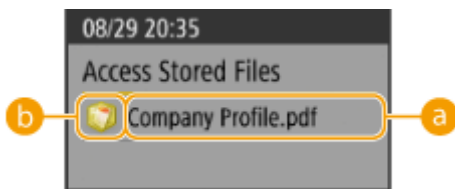

a File name

b Mail Box type

NOTE

- When multiple files are selected, the name of the file selected first is displayed.

Print

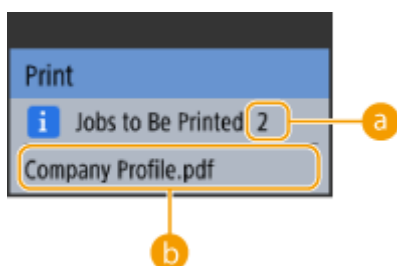

a Number of jobs waiting to be printed

b Job name

NOTE

- Among the jobs waiting to be printed, the name of the job that is received last is displayed as the job name.

Basic Operation of the Touch Panel Display

961F-05F

Even though functions and settings are different, the operation methods for buttons displayed on the screen and the procedure to select items are the same. This section describes the operation methods for buttons frequently displayed on the screen as well as how to select items.

- ▶ **Selecting a Button(P. 347)**
- ▶ **Selecting an Item from Drop-down List(P. 348)**
- ▶ **Adjusting a Value to Increase or Decrease(P. 348)**
- ▶ **Applying/Canceling Settings(P. 348)**
- ▶ **Switching Pages(P. 349)**
- ▶ **Changing the Display Order in the List(P. 349)**

Selecting a Button

When you press a button, the button color may change or a check mark may be added to indicate that it has been selected.

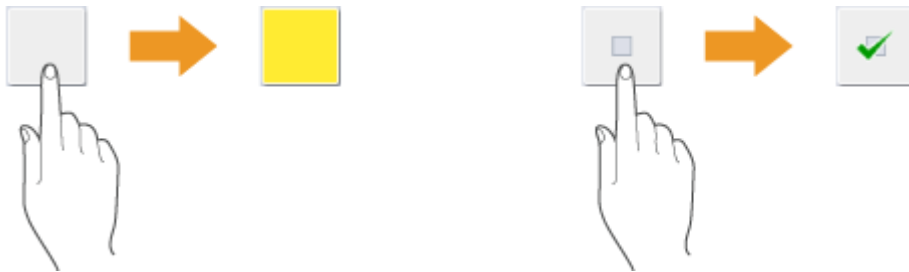

- Press the function setting button to display the setting status in the upper section of a button and the color of the lower section is changed.

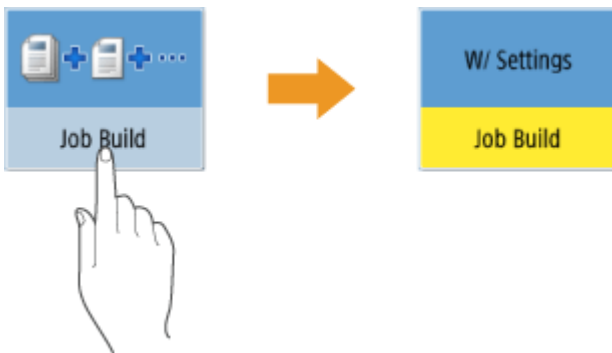

- Press a button in which ▶ is located in the lower-right to display the setting screen. When the setting is made, the setting status is displayed in the upper section of the button and the color of lower section is changed.

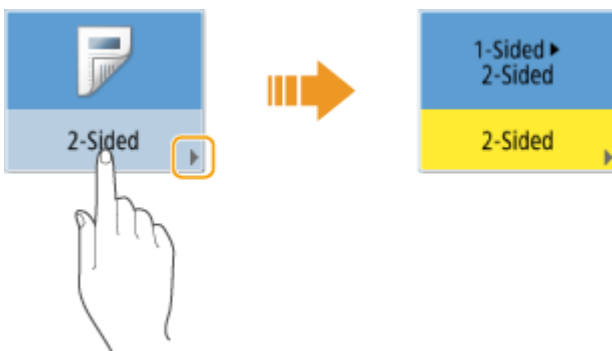

- When a button is displayed in a lighter color, you cannot select that button. Such displays appear depending on login status or because its related function cannot be used as another function has been set.

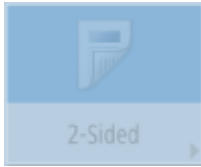

Selecting an Item from Drop-down List

Press a button in which ▼ is located in the right to display the drop-down list. Press the item on a list to select an item.

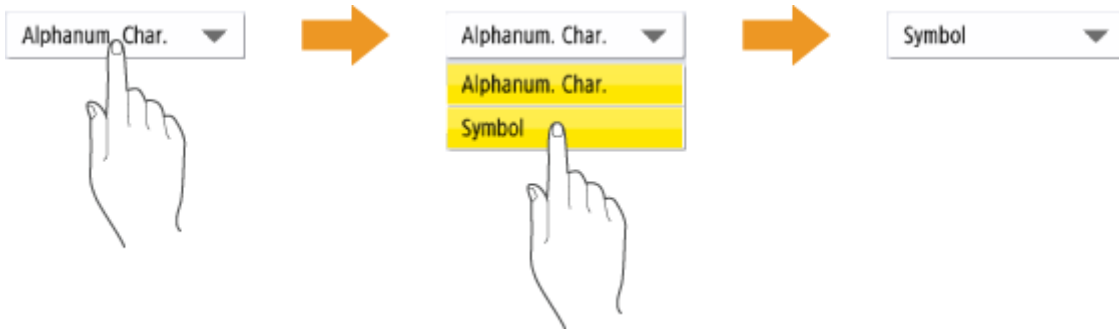

Adjusting a Value to Increase or Decrease

Press the <-> or <+> buttons to decrease or increase values, such as when adjusting the density. Each time you press the button, the slider (a) moves to increase or decrease the numerical value. By holding down the button, you can change the value quickly.



Applying/Canceling Settings

Press <OK> to apply settings and press <Cancel Settings> to discard the changes and restore the previous settings.



- In addition, buttons such as <Cancel> which cancels the setting and returns to the previous screen, <Next> which applies the setting to proceed to the next screen, <Back> which returns to the previous setting screen and <Close> which closes the screen currently open are displayed.



Switching Pages

When a list display is two pages or more, press ▲/▼ or ◀/▶ to switch the page. Press ▲ to jump to the first page, press ▼ to jump to the last page.

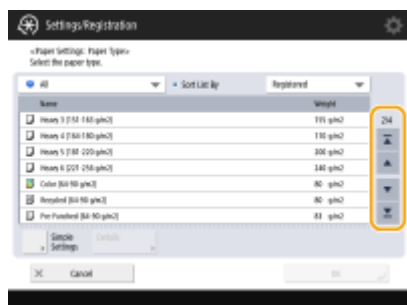

Changing the Display Order in the List

When there are multiple jobs/files in a list, you can press <Name> or <Date/Time> to sort the list of items. When ▲ is displayed, items are displayed in ascending order, or when ▼ is displayed, items are displayed in descending order.

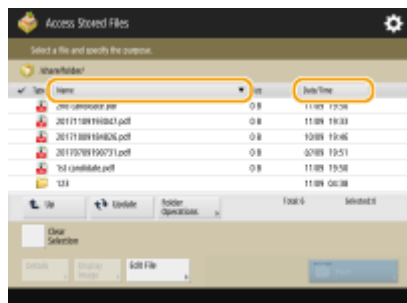

NOTE

- Sorting conditions differ depending on the function you are using.
- If you log in with personal authentication management, the sorting condition that was last used is retained. ▶ **List of Items That Can Be Personalized(P. 357)**

TIPS

View the function guide and FAQ page

Press <Tutorial/FAQ> to display a screen that introduces what you can do with the functions of the machine as well as tips for using copy, scan, etc. View this screen when you want to learn more about what functions are available and how to use them. You can also access the FAQ page from a mobile device.

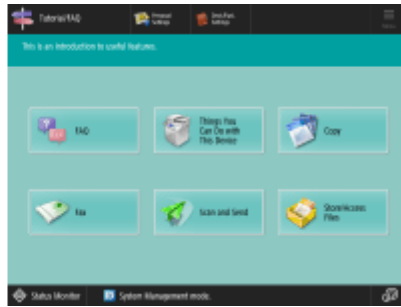
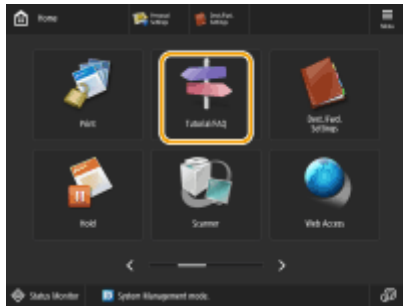

Example 1: Tutorial for Copy functions

- When you select an item from the list, the tutorial screen is displayed.

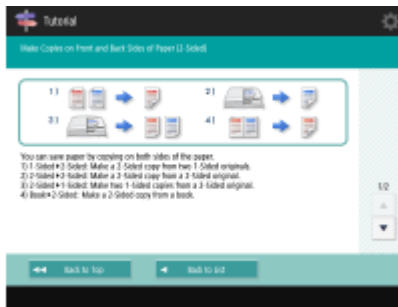
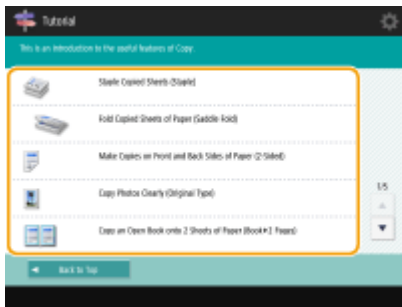

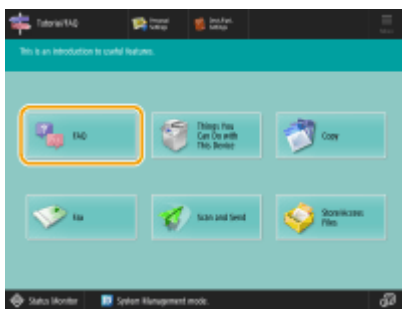

Example 2: Display the FAQ page

- Pressing <FAQ> displays a QR code. You can then display the FAQ page for the machine by scanning this QR code on a mobile device such as a smartphone or tablet.



Use the Help function

Depending on the function being displayed,  is sometimes displayed on the upper-right of the screen. Press  to check the description and operation method of the function.



- Press <End> to return to the previous screen.

Operate in the same manner as with a smartphone (flick/pinch/drag-and-drop)

On some screens, you can switch the page or scroll by flicking your finger up/down or left/right on the screen as you would with a smartphone.

Basic Operations

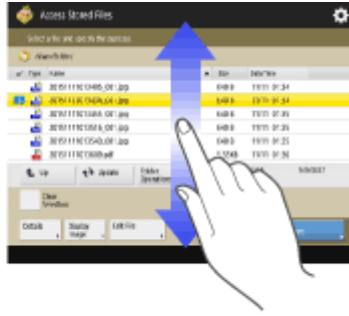

You can also zoom in or out on the screen by using two fingers to pinch out or pinch in. You can drag the enlarged screen with your finger. **▶Customizing the Screen Display Appearance and the Operational Conditions(P. 380)**

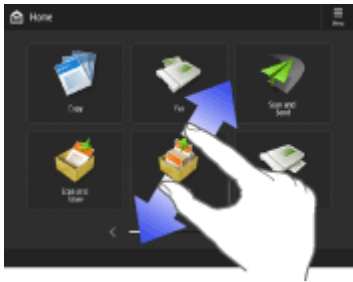

If <Enable Screen Magnification> is set to <On>, the entire screen is zoomed in/out when performing pinch operations on the preview screen. If <Enable Screen Magnification> is set to <Off>, only the preview image is zoomed in/out.



Preview screen

Preview screen

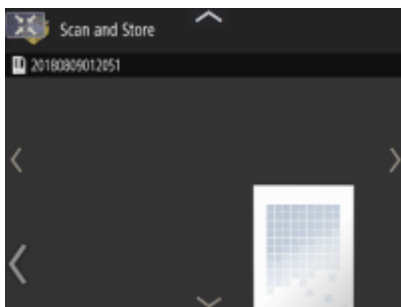

or



If <Enable Screen Magnification> is set to <On>

If <Enable Screen Magnification> is set to <Off>

NOTE

- You can also disable flick and pinch operations. **▶<Use Flick/Pinch Function>(P. 1144)**

On screens with movable buttons, the buttons can be dragged and dropped to move them.

Basic Operations



LINKS

- ▶ **Control Panel(P. 33)**
- ▶ **Entering Characters(P. 353)**

Entering Characters

For screens that require alphanumeric entries, enter characters using the keys on the touch panel display. To enter numbers, you can also use the numeric keys.

Example: <Alphanum. Char.> mode

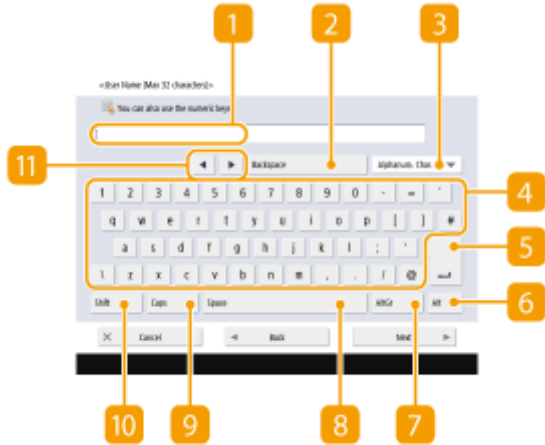

1 Character input field

Characters entered are displayed.

2 <Backspace> button

Each time you press the button, you can delete a character to the left of the cursor one by one.

NOTE

- If a character you want to delete is not to the left of the cursor, press ◀ or ▶ (11) to move the cursor.
- Press **C** (Clear) on the control panel if you want to delete all the characters you entered.

3 Entry mode button

Select the entry mode from the drop-down list.

<Alphanum. Char.>	Alphanumeric character entry mode
<Symbol>	Symbol entry mode

NOTE

- You may not be able to select the entry mode because the type of characters that you can enter is predetermined for some screens.

4 Character input button

The same keyboard layout as that of a computer.

5 Enter button

Press to start a new line.

6 <Alt> button

Press to display only the numeric keys.

7 <AltGr> button

Press to display characters with accent marks.

8 <Space> button

Press to enter a space.

9 <Caps> button

Press to enter uppercase characters.

10 <Shift> button

Press to enter uppercase characters or symbols.

11 Cursor button

Move the cursor in the input field.

NOTE

When displaying the numeric keys icon

- When <  You can use numeric keys.> is displayed, you can enter numerical values using the numeric keys on the control panel.



Example: <Copy Ratio> setting screen



- When <  Enter using the numeric keys.> is displayed, only the numeric keys on the control panel can be used for entering numbers.

Enter characters from the USB keyboard

To enter characters, you can also use a USB keyboard by connecting it to the USB port ( **Front Side(P. 20)**). Note the following points when entering from a USB keyboard.

- Set <Use MEAP Driver for USB Input Device> in <USB Settings> to <Off>.  **<Use MEAP Driver for USB Input Device>(P. 1141)**
- You can only enter ASCII characters from a USB keyboard.
- Keys that are not displayed on the keyboard screen of the touch panel display, such as Delete, End, Tab, Esc, and function keys, cannot be used on a USB keyboard.
- The entering sound of a USB keyboard is produced based on the <Entry Tone> and <Invalid Entry Tone> settings on the sound setting screen.  **Setting Sounds(P. 384)**

Logging into the Machine

961F-05J

When the login screen is displayed, registered authorized users are required to log in to continue operating the machine. To log in, each user must enter his or her own user name and password. This ensures the security of the machine. Also, the users can use the machine as conveniently as possible by customizing (personalizing) the display and the settings according to their preferences. The items displayed on the login screen vary depending on the user management settings. Perform the login operation based on the items that are displayed.

▶When the User Name and Password Input Screen Is Displayed(P. 355)

NOTE

- For the functions and settings that can be personalized, see ▶**List of Items That Can Be Personalized(P. 357)** .
- If you are not using the Personalization function, set <Enable Use of Personal Settings> (▶<**Enable Use of Personal Settings>(P. 1346)**) to <Off>.
- If <Auto Reset Time> is set, the user is automatically logged out when no operations are performed for a specified period. ▶<**Auto Reset Time>(P. 1074)**
- Depending on the Visual Message settings, the Visual Message screen may appear prior to login. To log in, first close the Visual Message screen. ▶<**Configuring the Visual Message Function(P. 979)**

When the User Name and Password Input Screen Is Displayed

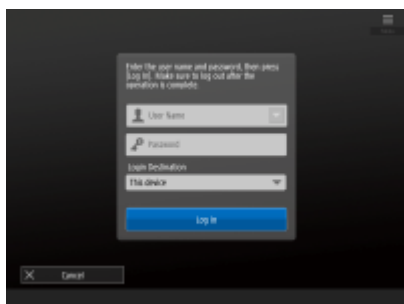

Use the on-screen keyboard to enter the user name and password.

1 Press <User Name>.

- If the login user's cache is remaining, you can also select the user name from the login history drop-down list. When a user name is selected, press <Password> and proceed to step 3.

2 Enter the user name and press <Next>.

3 Enter the password and press <OK>.

4 Select the login destination from the <Login Destination> drop-down list, and press <Log In>.

▢ When login is successful, the machine functions become available.

- Log out after use.

NOTE

- You can log into the machine using the copy card. For details about the copy card, see [▶Copy Card Reader\(P. 208\)](#) .
- You can specify whether to save passwords entered during login in the cache. [▶<Prohibit Caching of Authentication Password>\(P. 1366\)](#)
- If you set <Display Button to Change Password on Settings Menu> to <On>, the password can be changed from  on the top right of the login screen. [▶<Display Button to Change Password on Settings Menu>\(P. 1330\)](#)
- You can specify whether to save or delete the login user's cache. [▶<Number of Caches for Login Users>\(P. 1330\)](#)

LINKS

- [▶Using the Touch Panel Display\(P. 331\)](#)
- [▶Customizing the Touch Panel Display\(P. 360\)](#)
- [▶Managing Users\(P. 803\)](#)
- [▶Starting the Remote UI\(P. 902\)](#)

List of Items That Can Be Personalized

961F-05K

The following items can be personalized for each login user.

Category	Setting Value	Corresponding Settings
Display language ^{*1*2}	Display language and keyboard layout	▶<Switch Language/Keyboard>(P. 1066)
Accessibility ^{*1*2}	Key Repetition Settings	▶<Key Repetition Settings>(P. 1143)
	Reversed Display (Color)	▶<Reversed Display (Color)>(P. 1143)
	Voice Navigation Settings	Voice Navigation Settings (see Option Guide.)
	Enable Screen Magnification (pinch)	▶<Enable Screen Magnification>(P. 1143)
Initial screen ^{*1*2}	Screen displayed after logging in	▶<Default Screen after Startup/Restoration>(P. 1063)
Home ^{*1*2}	Personal buttons	Personal buttons (▶<Registering Personal Buttons/ Shared Buttons>(P. 373))
	Timeline ^{*3*5}	Timeline (▶<Items Displayed on the <Home> Screen>(P. 335))
	Home settings	▶<Customizing the <Home> Screen>(P. 363)
Network	SSID, Network key, Automatically Enable/ Disable Direct Connection at Login/Logout	▶<Personal SSID and Network Key Settings>(P. 1132) , ▶<Access Point Mode Settings>(P. 1130)
Default job settings ^{*1*2*3}	Copy	▶<Change Default Settings>(P. 1197)
	Fax	▶<Change Default Settings>(P. 1251)
	Scan and Send ^{*4}	▶<Change Default Settings>(P. 1228)
	Scan and Store ^{*4}	▶<Change Default Settings>(P. 1284)
	Access Stored Files	▶<Change Default Settings>(P. 1286)
Shortcuts ^{*1*2}	Copy	▶<Register Options Shortcuts>(P. 1198)
	Fax	▶<Register Options Shortcuts>(P. 1251)
	Scan and Send	▶<Register Options Shortcuts>(P. 1228)
Previous Settings ^{*1*3*5}	Copy	▶<Recalling Previously Used Copy Settings (Previous Settings)>(P. 514)
	Fax	▶<Recalling Previously Used Settings for Sending (Previous Settings)>(P. 557)
	Scan and Send ^{*4}	▶<Recalling Previously Used Settings for Sending/Saving (Previous Settings)>(P. 691)
Address Book	Personal address lists ^{*1}	▶<Registering Destinations via the Remote UI>(P. 912) , ▶<Registering Destinations in the Address Book>(P. 394)

Category	Setting Value	Corresponding Settings
	Group address books*1*6 (user group address list 01 to user group address list 50)	
Conditions for changing the list order *5	Copy	<Add from Mail Box> ▶Combining Jobs with Different Settings Into a Single Job (Merge Job Blocks)(P. 490)
	Scan and Store	▶Saving Documents in the Mail Box(P. 725) , ▶Saving Documents in the Advanced Space(P. 709) , ▶Saving Documents in Other Devices(P. 721) , ▶Saving Documents in Memory Media(P. 741)
	Access Stored Files	▶Editing Files in the Mail Box(P. 729) , ▶Working with Files and Folders in the Advanced Space(P. 713) , ▶Working with Files and Folders in Other Devices(P. 722) , ▶Working with Files and Folders in Memory Media(P. 743)
	Print	▶Printing Documents Retained in the Machine (Forced Hold Printing)(P. 608)
Automatic print after login settings	Auto Print User Jobs When Logging In	▶<Auto Print User Jobs When Logging In>(P. 1306)
Other	Keychain*1	-
Web Access *7	Cookie	For details, see "Web Access" via the online manual Web site. ▶Manuals and Their Contents(P. 10)

*1 Deleted when <Delete Oldest User Settings> is specified. **▶<Action When Maximum Number of Users Exceeded>(P. 1346)**

*2 When a client machine synchronizes custom settings for the first time, the synchronization of this item may not finish before the machine starts up.

*3 When synchronizing custom settings, this item can be specified for individual machines within the scope of data sharing. **▶Specifying Detailed Synchronization Settings (Server Machine or Server/Client Machine)(P. 995)**

*4 Even if this item is set to be shared, destinations are left blank and not synchronized.

*5 This item cannot be imported from another machine or exported to another machine. **▶Importing/Exporting the Setting Data(P. 946)**

*6 It is necessary to use the login service that supports the group function (User Authentication supports the group function).

*7 This item does not support custom setting synchronization.

■ Items That Cannot Be Personalized but Can Be Synchronized by Synchronizing Custom Settings

The following items cannot be personalized but can be shared between multiple Canon multifunction printers by synchronizing custom settings.

- Destination for sharing user group address lists **▶Registering Destinations via the Remote UI(P. 912)**
- Home settings (when not logged in) **▶Customizing the <Home> Screen(P. 363)**

NOTE

- Set <Shared across All Devices> to share the <Shared> and <Wallpaper Settings> (when not logged in) settings of the <Home> screen with all client machines using synchronization of custom settings. If

you want to manage these settings for each client machine separately, select <Device-Specific (Not Shared)> when starting the service for the first time (when no client machines are connected to the server machine). The data may be initialized if the scope of data sharing is changed after the service is started.

- For information on the keychain, see [▶Managing Users\(P. 803\)](#) .
- When the <Switch Language/Keyboard>, <Accessibility>, and <Personal SSID and Network Key Settings> settings could not be reflected immediately after logging in, they can be reflected when it becomes possible. For more information, see [▶Starting Setting Synchronization\(P. 991\)](#) .

Customizing the Touch Panel Display

961F-05L

In order to more easily use the <Home> screen and the Basic Features screen of each function, you can customize the screen by rearranging buttons or creating shortcut buttons. In addition, you can work more efficiently by registering the settings already specified for frequently used functions to <Personal>/<Shared>, or the Personal Settings to customize the operation environment to your preferences.



Customizing the <Home> Screen

The order, size, and number of buttons displayed on the <Home> screen can be changed, and the background image can be changed. <Home Management Settings> enables you to configure the timeline display settings and display/hide the function buttons.



▶ Customizing the <Home> Screen(P. 363)

Creating a Shortcut

Function shortcut buttons can be displayed on each function screen. Registering frequently used functions is convenient because it enables functions to be continuously used without returning to the <Home> screen.

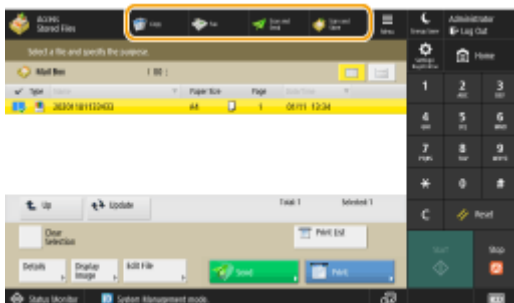

▶ Creating a Shortcut for a Frequently Used Function(P. 365)

Registering Favorite Settings

If you frequently use the same combination of settings for copy, fax, and scan, it is convenient that you have those settings registered as <Favorite Settings>.



(Items shown on the screen may differ depending on your model and options.)

▶ **Registering a Combination of Frequently Used Functions(P. 367)**

Customizing the Basic Features Screen

You can change the setting buttons that are displayed on the Basic Features screens (for copy, fax, and scan). You can also display a different Basic Features screen customized for each logged-in user.

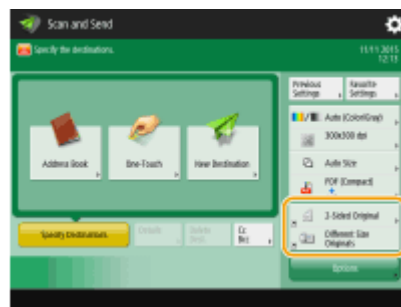

▶ **Customizing the Basic Features Screen(P. 370)**

Creating the <Personal>/<Shared> Button

It is possible to freely register frequently used functions and setting procedures on the <Home> screen.

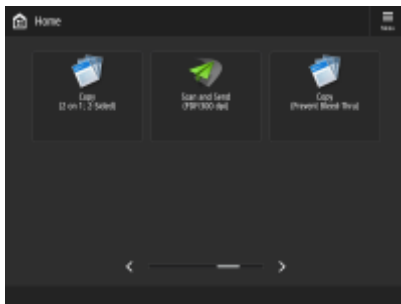

▶ **Registering Frequently Used Settings and Destinations as Personal Buttons/Shared Buttons on the <Home> Screen(P. 372)**

Changing the Language Displayed

You can change the language displayed on the touch panel display and keyboard.

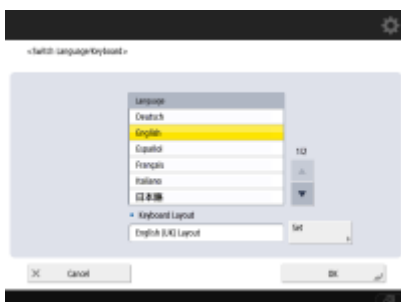

▶ **Switching the Displayed Language(P. 377)**

Creating the Settings/Registration Shortcut

You can create a shortcut for any setting item that is displayed with a press of  (Settings/Registration). If you frequently use a setting item provided at a very deep level, you can conveniently use the shortcut for that item to quickly switch the display.

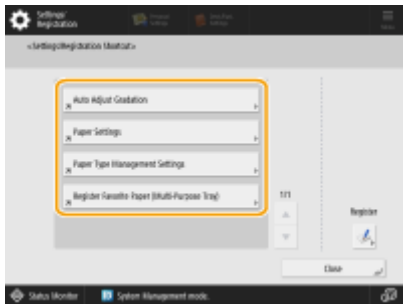

▶ Registering Shortcuts for Frequently Used Settings/Registered Items(P. 379)

Settings for Each User (Personal Settings)

The displays and operation environment can be changed for each user.



▶ Customizing the Screen Display Appearance and the Operational Conditions(P. 380)

LINKS

▶ Using the Touch Panel Display(P. 331)

Customizing the <Home> Screen

961F-05R

This section describes what can be customized and managed from the items displayed when <Menu> is pressed on the <Home> screen.

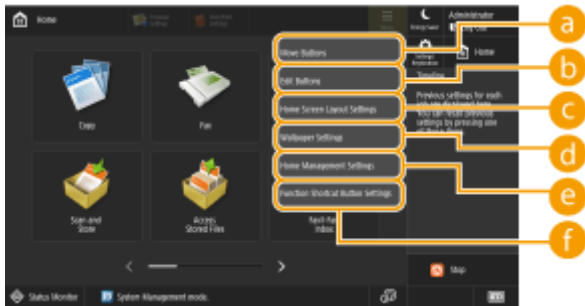

NOTE

- Depending on the setting for <Allow Home Screen Customization for Common Use> and the privileges of the login user, a screen for selecting either <Customize for Personal Use> or <Customize for Common Use> may be displayed when <Move Buttons>, <Edit Buttons>, <Home Screen Layout Settings>, or <Wallpaper Settings> is selected.
 - <Customize for Personal Use>: Select this to customize the Home screen for the current login user. The default settings for <Customize for Personal Use> follow the settings for <Customize for Common Use>.
 - <Customize for Common Use>: Select this to customize the Home screen for the users who have no personalized screen, such as non-login users, Guest users, etc. The settings in <Customize for Common Use> are applied until the authenticated user configures <Customize for Personal Use>.
- If the settings in <Customize for Common Use> are changed, the changes are also reflected to <Customize for Personal Use> until the authenticated user configures <Customize for Personal Use>.
- <Home> screen settings can be imported/exported between machines that support the <Home> screen. ▶ **Importing/Exporting the Setting Data(P. 946)**
- <Home> screen settings are not imported to machines that support the <Quick Menu> screen but do not support the <Home> screen.
- Even if any of the settings in <Home Management Settings for Personal Use> is disabled when exporting, personal settings are exported if they are already configured.

a <Move Buttons>

You can move function buttons and Personal buttons/Shared buttons.

b <Edit Buttons>

Only <Move:> can be used for function buttons.
<Rename>, <Delete>, and <Move> can be used for Personal buttons/Shared buttons.

c <Home Screen Layout Settings>

You can select one of the following items for the size and number of buttons displayed on a single screen.

- <3 large buttons per page>
- <6 large buttons per page>
- <9 medium buttons per page>
- <4 medium-small buttons per page>
- <12 medium-small buttons per page>

- <15 small buttons per page>

d <Wallpaper Settings>

You can change the background image.

e <Home Management Settings>

The following settings are available. (Red and bold text indicates the default setting.)

- <Allow Home Screen Customization for Common Use>: <On>/<Off>
- <Allow Non-Authentication Users to Use Timeline>: <On>/<Off>
- <Allow Each Login User to Use Timeline>: <On>/<Off>
- <Return to Home After Job is Performed>: <On>/<Off>
- <Restrict Function Display>: Select the functions or MEAP applications to hide on the <Home> screen.
- <Home Management Settings for Personal Use>: The following settings can be configured.
 - <Allow Registration/Editing of Personal Buttons>: <On>/<Off>
 - <Allow Use of Move Buttons When Customizing for Personal Use>: <On>/<Off>
 - <Allow Use of Home Screen Layout Settings When Customizing for Personal Use>: <On>/<Off>
 - <Allow Use of Wallpaper Settings When Customizing for Personal Use>: <On>/<Off>

NOTE

- Operating this setting requires administrator privileges.
- <Allow Home Screen Customization for Common Use>
When set to On, General users and users that are not logged in can register shared buttons and customize the Home screen for common use.
- <Return to Home After Job is Performed>
When set to On, the Home screen will be displayed after performing jobs using Shared buttons, Personal buttons or Timeline.
- History is not retained in the timeline when a user is not logged in and <Allow Non-Authentication Users to Use Timeline> is set to <Off>, or when a user is logged in and <Allow Each Login User to Use Timeline> is set to <Off>.
- When <Enable Use of Personal Settings> is disabled, <Home Management Settings for Personal Use> is grayed out and personal settings cannot be used. ▶<Enable Use of Personal Settings>(P. 1346)
- <Allow Registration/Editing of Personal Buttons>
Disable this to hide personal buttons.
- If <Allow Use of Move Buttons When Customizing for Personal Use> is disabled after moving buttons on the personalized screen with <Allow Use of Move Buttons When Customizing for Personal Use> enabled, buttons become unable to be moved on the personalized screen but their position is retained.
- <Allow Use of Home Screen Layout Settings When Customizing for Personal Use>
Disable this to apply the settings in <Device Settings>.
- <Allow Use of Wallpaper Settings When Customizing for Personal Use>
Disable this to apply the settings in <Device Settings>.

f <Function Shortcut Button Settings>

You can register function buttons as shortcuts. Select the registration destination, and then the function to register.

NOTE

- Operating this setting requires administrator privileges.
- If you do not use shortcuts, select <Unassigned> from the list.

Creating a Shortcut for a Frequently Used Function

961F-055

You can create a shortcut button for the functions on the <Home> screen. Use this button to access a different function without returning to the <Home> screen. To create a shortcut, log in with administrator privileges. **▶Logging into the Machine(P. 355)**

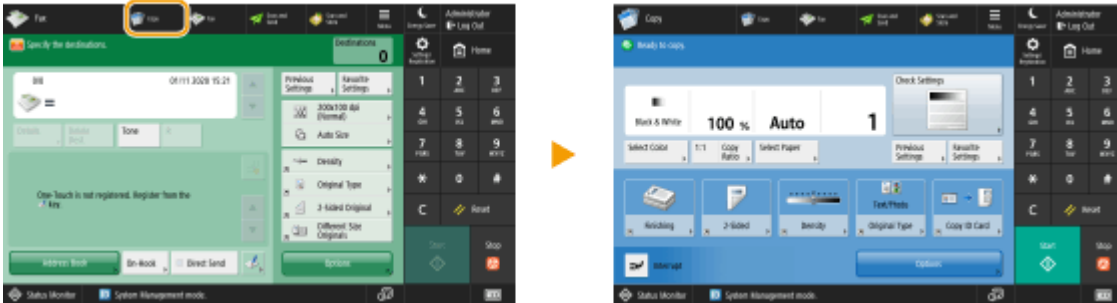

NOTE

- Shortcuts that can be registered: 4

Models with an upright control panel

- In the <Home> screen, shortcuts do not appear if the timeline is displayed.

- 1 Press . ▶<Home> Screen(P. 332)**
- 2 Press <Shortcut Button Settings>.**
- 3 Select a number for the shortcut to be created.**

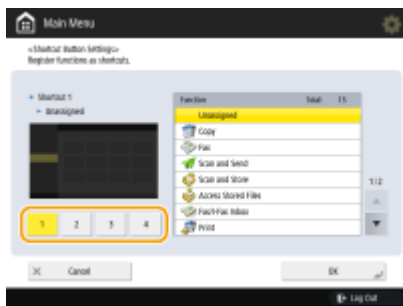

- 4 Select the function you want to create a shortcut for.**

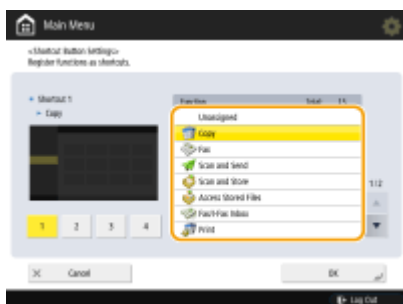

- Select the function from the list. You can check the position of the shortcut selected and the function assigned to it in the preview screen on the left of the list.
- If you do not use shortcuts, select <Unassigned> from the list.

5 Press <OK>.

Registering a Combination of Frequently Used Functions

961F-05U

If you use the same settings every time for the Copy, Fax, or Scan function or want to save complicated settings, you can register settings as favorite settings, which can then be conveniently recalled.

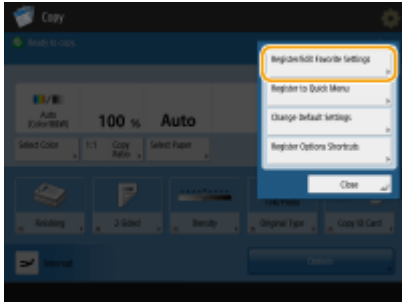

- ▶ Registering Settings(P. 367)
- ▶ Recalling Registered Settings(P. 368)

NOTE

- The settings stored in memory are not deleted, even if the main power is turned OFF.

Registering Settings

Example: Copy Function

- 1** Press <Copy>, and specify the settings you want to register.
 - ▶ <Home> Screen(P. 332)
 - ▶ Basic Copy Operations(P. 420)
- 2** Press  ▶ <Register/Edit Favorite Settings>.
- 3** Select a button, and press <Register>.



- To change a button name, select the button, press <Rename>, and enter the new name.
- To delete registered settings, select the button and press <Delete>.
- The name for the button is not deleted. To change a key name, press <Rename>.

- If an address included in a favorite settings button is deleted from the address book, it is also deleted from the settings registered in the favorite settings button.
- If you select <Device Login Authentication Information> for <Information Used for File TX/Browsing Authentication>, a password for a file destination cannot be stored in <Favorite Settings>.

4 Press <Yes> ► <Close>.

- For certain functions, press <Next>, enter a comment as necessary, and press <OK>. You can set <Show Comments> to <On> to display comments.

NOTE

- <The information for the new file destination specified may include a password. Do you want to include the password when registering? (Press [No] to register the destination without the password.)>
If the above messages is displayed when registering <Favorite Settings> for <Scan and Send>, perform the following operations.
 - If you want to recall favorite settings without entering a password, press <Yes> to retain the password information.
 - If you want to recall favorite settings by entering a password, press <No> to delete the password information. (If you often import favorite settings to other devices, you can require a password to be entered each time to prevent users from impersonating other users.)

Recalling Registered Settings

Example: Copy Function

1 Place the original. ► Placing Originals(P. 39)

2 Press <Copy>. ► <Home> Screen(P. 332)

NOTE

- With <Fax> and <Scan and Send>, you can change the default screen to the <Favorite Settings> screen.
 - Scan and Send: ► <Default Screen>(P. 1227)
 - Fax: ► <Default Screen>(P. 1250)

3 Press <Favorite Settings> on the Copy Basic Features screen. ► Copy Basic Features Screen(P. 418)

4 Select the button ► press <OK> ► <Yes>.



(Items shown on the screen may differ depending on your model and options.)

- You can also change the settings you recall after pressing <Yes>.

NOTE

- For the Copy/Scan and Send function, you can also set the machine not to display the confirmation screen when the registered settings are recalled.
 - Copy: <Display Confirmation for Favorite Settings>(P. 1197)
 - Scan and Send: <Display Confirmation for Favorite Settings>(P. 1227)

5 Press (Start).

⇒ Copying starts.

NOTE

- The limit to the number of <Favorite Settings> you can register is as follows.
 - Copy: 9
 - Fax: 18
 - Scan and Send: 18
 - Scan and Store (Mail Box): 9
 - Scan and Store (Advanced Space/Network/Memory Media): 9
 - Access Stored Files (Mail Box): 9
 - JPEG/TIFF files in Access Stored Files (Advanced Space/Network/Memory Media): 9
 - PDF/XPS files in Access Stored Files (Advanced Space/Network/Memory Media): 9

Customizing the Basic Features Screen

961F-05W

The setting buttons that are displayed on the Basic Features screens (for copy, fax, and scan) can be changed with other setting buttons in <Options>. By locating frequently used setting buttons on the Basic Features screen, you can use functions more efficiently. In addition, by logging in with personal authentication management, you can display a different Basic Features screen customized for each user.

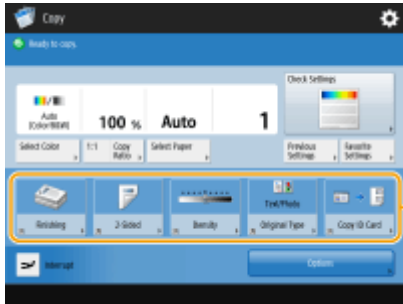

Copy Basic Features screen

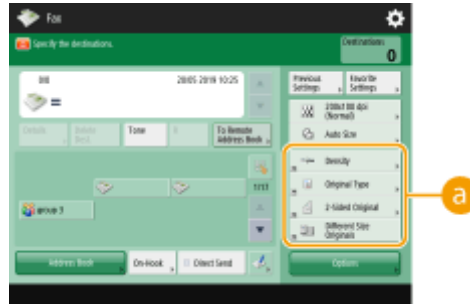

Fax Basic Features screen

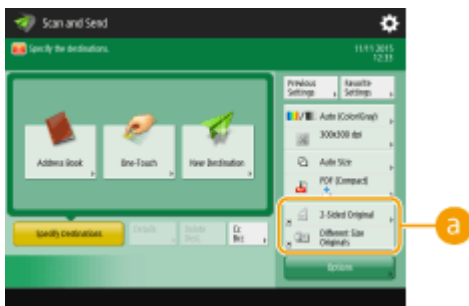

Scan Basic Features screen

(Items shown on the screen may differ depending on your model and options.)

a Buttons that can be replaced

Example : Copy Basic Features screen

- 1** Press <Copy> and press . <Home> Screen(P. 332)
- 2** Press <Register Options Shortcuts>.
- 3** Select a button to be replaced.

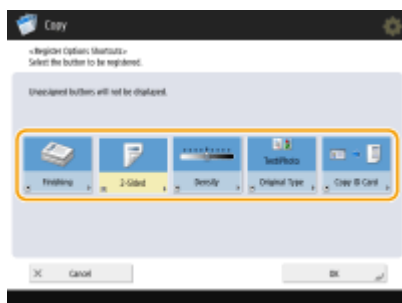

- Buttons displayed here are currently being displayed on the Basic Features screen. Buttons selected in this step will not be displayed on the Basic Features screen.

4 Select a button you want to display on the Basic Features screen and press <OK>.

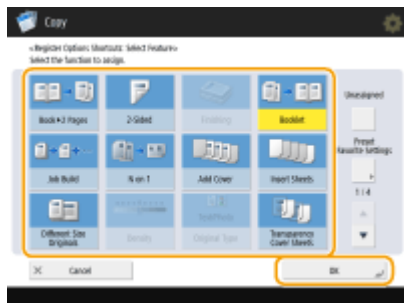

- If you do not want to display the button, press <Unassigned>.
- For the Regular Copy Screen, you can register from <Preset Favorite Settings> a shortcut to the <Favorite Settings> that you set.

5 Press <OK>.

- By replacing with the button selected in step 3, the new button selected in step 4 is displayed on the Basic Features screen.

NOTE

- The number of setting items located on the Basic Features screen and the location to be displayed differ depending on functions.
- A shortcut button is not displayed if <Unassigned> is set as a shortcut.
- The limit to the number of shortcuts for <Options> you can register is as follows.
 - Copy (Basic): 5
 - Copy (Express): 6
 - Fax: 4
 - Scan and Send: 2
- If you have changed the Copy Basic Features screen to the Express Copy screen (**▶ Changing the Settings Quickly (Express Copy Screen)(P. 516)**), select the button in step 3 and then press <Register>.

TIPS

Registering in <Favorite Settings>

- In <Favorite Settings>, you can register frequently used procedures for copying, as well as frequently specified destinations and settings for scanning. For more information, see **▶ Registering a Combination of Frequently Used Functions(P. 367)** .

Changing the default setting on the Basic Features screen

- After changing the settings for each function, you can register the current settings as a default on the Basic Features screen by pressing **☰** followed by <Change Default Settings>. If you log into the machine with personal authentication management (**▶ Logging into the Machine(P. 355)**) before performing this setting, it is registered as your own personal default setting (**▶ List of Items That Can Be Personalized(P. 357)**).

Registering Frequently Used Settings and Destinations as Personal Buttons/Shared Buttons on the <Home> Screen

961F-05X

Frequently used settings and destinations can be registered to the <Home> screen as Personal buttons/Shared buttons to recall those settings with a single button.

Shared buttons can be used by all users.

Personal buttons can only be used by login users.

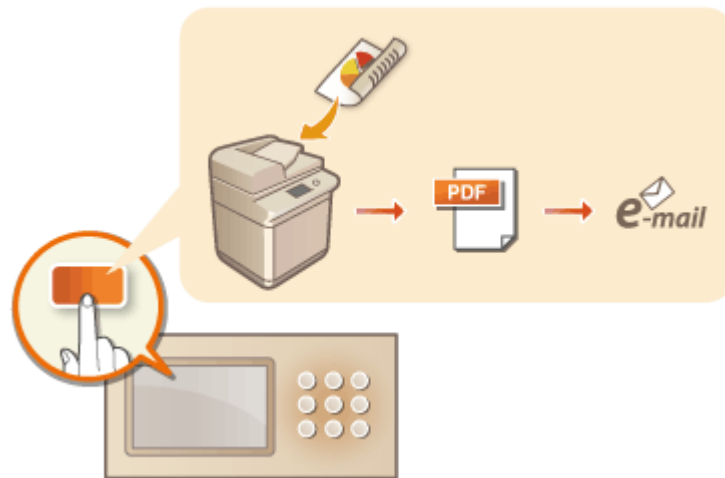

▶ Registering Personal Buttons/Shared Buttons(P. 373)

Registering Personal Buttons/Shared Buttons

961F-05Y

You can register Personal buttons for your own use, or Shared buttons that can be shared with all users.

NOTE

- To register a Personal button, you need to log in with personal authentication management. **▶Configuring the Personal Authentication Management Settings(P. 806)**
- If you select <Device Login Authentication Information> for <Information Used for File TX/Browsing Authentication>, a password for a file destination is not stored in a Personal button. **▶<Information Used for File TX/Browsing Authentication>(P. 1196)**
- For information on the maximum number of Personal buttons and Shared buttons that can be registered, see **▶Management Functions(P. 1586)** .
- Personal buttons cannot be changed to Shared buttons, and vice-versa. To do so, recall the settings and register another button from <Menu>.
- Press and hold a button to change its name/comment or move/delete it. The same operations (changing the name/comment of a button or moving/deleting a button) can be performed from <Menu> on the <Home> screen. **▶Customizing the <Home> Screen(P. 363)**
- Personal buttons can be shared between multiple devices by synchronizing personalized data. **▶List of Items That Can Be Personalized(P. 357)**

Settings that can be registered in Personal buttons/Shared buttons

Functions and settings that can be registered in Personal buttons/Shared buttons are indicated below.

- Settings that can be registered in <Favorite Settings> for the <Copy> function **▶Reducing Copying Operations(P. 513)**
- <Fax> function settings of the machine **▶Basic Operations for Sending Faxes(P. 524)**
- Settings that can be registered in <Favorite Settings> for the <Scan and Send> function **▶Useful Scanning Functions(P. 672)**
- Settings that can be registered in <Favorite Settings> for the <Scan and Store> function **▶Setting Screen and Operations for Scanning to Save(P. 749)**
- Save locations for the <Scan and Store> and <Access Stored Files> functions **▶Using Storage Space(P. 706)**
- Shortcuts to the Basic Features screen for the <Fax/I-Fax Inbox> function
- Access to a server and the login password can be registered to Personal buttons/Shared buttons. This is convenient for skipping password entry when recalling the registered button. If you want to set password in the settings stored in the registered button, as you often import settings in a Personal button or Shared button to another machine and you want to prevent users from pretending to be other users, exclude a password when registering.

Importing/exporting the registered buttons

- You can import and export the registered Personal/Shared buttons from the Remote UI. **▶Importing/Exporting All Settings(P. 950)**
- Depending on the model from which the buttons are being imported, you may not be able to import all the settings for Shared/Personal buttons. For more information, contact your dealer or service representative.

Example: Registering copy function

- 1 Press <Copy> ▶ specify the copy settings. ▶<Home> Screen(P. 332)**

2 Press  **<Register to Home>** when the setting is complete.

3 Confirm the settings and press **<Next>**.

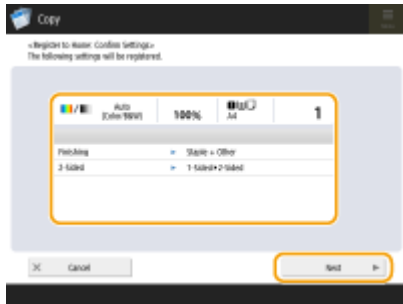

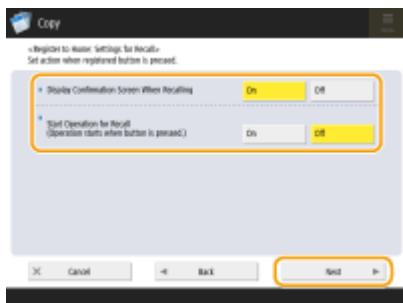

4 Specify the action that is performed when the registered button is pressed, and press **<Next>**.

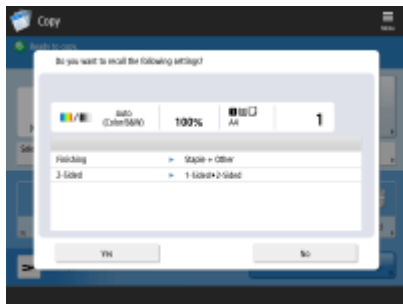

- The setting described below results in a different operation immediately after pressing the registered button. For more information, see [▶ Executing Personal Buttons/Shared Buttons\(P. 375\)](#) .
- If you select **<On>** for **<Display Confirmation Screen When Recalling>**, the confirmation screen below is displayed when you press the registered button. Select **<Off>** if you do not want to display the confirmation screen.



- If you select **<On>** for **<Start Operation for Recall (Operation starts when button is pressed.)>**, copying starts when you press the registered button without pressing  (Start). Select **<Off>** if you want to start copying manually by pressing  (Start).

NOTE

- If you select **<On>** for both **<Display Confirmation Screen When Recalling>** and **<Start Operation for Recall (Operation starts when button is pressed.)>**, copying starts after you select **<Yes>** on the confirmation screen.

5 Enter the button name and a comment, select **<Personal>** or **<Shared>**, and press **<OK>**.



- Press <Name> or <Comment> to enter. It is convenient if you enter a setting name in <Name> and a memo in <Comment>.

NOTE

- To register a button for yourself only, press <Personal>. To register a button to share with other users, press <Shared>.
- If <4 medium-small buttons per page>, <12 medium-small buttons per page>, or <15 small buttons per page> is selected in <Home Screen Layout Settings>, <Comment> is not displayed for Shared/Personal buttons. **▶ Customizing the <Home> Screen(P. 363)**

6 Press <Close>.

■ Executing Personal Buttons/Shared Buttons

This section describes how to execute Personal buttons/Shared buttons. The procedure for executing the function differs according to the settings specified when registering the Personal button/Shared button and the registered function.





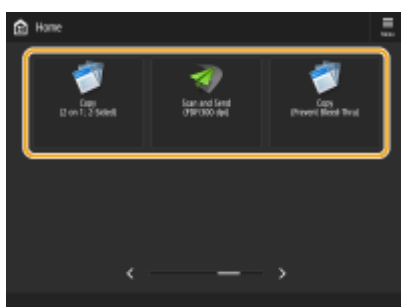

NOTE

- The destinations registered in the one-touch buttons on the Quick Menu of the client machine are not updated even if those registered in the one-touch buttons of a server machine are updated. Confirm if the destination is updated when you cannot send to the registered destinations.

1 Press the button you want to use.



- Each icon indicates the function type as shown below.

-  <Copy>
-  <Fax>
-  <Scan and Send>
-  <Scan and Store>
-  <Access Stored Files>
-  <Fax/I-Fax Inbox>

NOTE

- You can also execute the content of the button with the following procedure: press and hold the Personal button/Shared button ► press <Recall>.

2 Perform the following operation according to the content registered in the button.

■ When <Display Confirmation Screen When Recalling> is set to <On>

A confirmation screen asking whether to recall the settings is displayed.

- If <Start Operation for Recall (Operation starts when button is pressed.)> is set to <On>, operations registered in the button start when you press <Yes>.
- If <Start Operation for Recall (Operation starts when button is pressed.)> is set to <Off>, the setting screen is displayed when you press <Yes>. This enables you to change the settings before pressing  (Start) to start.

■ When <Display Confirmation Screen When Recalling> is set to <Off>

- If <Start Operation for Recall (Operation starts when button is pressed.)> is set to <On>, operations registered in the button start immediately.
- If <Start Operation for Recall (Operation starts when button is pressed.)> is set to <Off>, the setting screen is displayed. This enables you to change the settings before pressing  (Start) to start.

■ When you select <Scan and Store> function button

The folder specified as the save location for the scanned originals is displayed. Scan the originals you want to save.

- ▶ **Using as a Simple File Server(P. 708)**
- ▶ **Working with Other Devices(P. 720)**
- ▶ **Making Simple Edits to Files(P. 724)**

■ When you select <Access Stored Files> function button

The specified save folder is displayed. Select a file in the folder for sending or printing.

- ▶ **Using as a Simple File Server(P. 708)**
- ▶ **Working with Other Devices(P. 720)**
- ▶ **Making Simple Edits to Files(P. 724)**

■ When you select the <Fax/I-Fax Inbox> function button

The registered settings screen is displayed. Proceed with the operation that you want to perform.

- ▶ **Printing Documents in the Memory RX Inbox(P. 566)**
- ▶ **Keeping Received Documents Private(P. 569)**

LINKS

- ▶ **Customizing the <Home> Screen(P. 363)**
- ▶ **Creating a Shortcut for a Frequently Used Function(P. 365)**
- ▶ **Customizing the Basic Features Screen(P. 370)**

Switching the Displayed Language

961F-060

You can change the language and keyboard layout displayed on the touch panel display. If you switch languages frequently, it is convenient to use the <Switch Language/Keyboard> button. Follow the procedure below to show this button on the touch panel display.

- ▶ **Switching the Displayed Language and Keyboard Layout(P. 377)**
- ▶ **Showing the <Switch Language/Keyboard> Button on the Touch Panel Display(P. 377)**

Switching the Displayed Language and Keyboard Layout

- 1** Press  (Settings/Registration).
- 2** Press <Preferences> ▶ <Display Settings> ▶ <Switch Language/Keyboard>.
- 3** Select a language from the list and press <OK>.

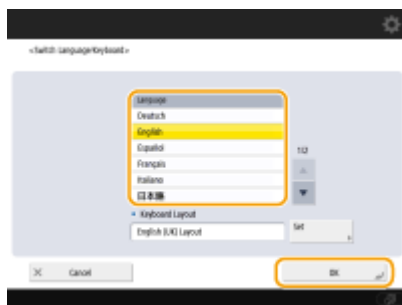

NOTE

- For some languages, the keyboard layout can be changed. After selecting the language, press <Set>, select the layout type, and press <OK>.

Showing the <Switch Language/Keyboard> Button on the Touch Panel Display

- 1** Press  (Settings/Registration).
- 2** Press <Preferences> ▶ <Display Settings> ▶ <Display Switch Language/Keyboard Button>.
- 3** Press <On> ▶ <OK>.

- If you set it to <On>,  appears at the bottom of the touch panel display. You can switch the currently displayed language to another by pressing the <Switch Language/Keyboard> button, selecting the desired language from the list, and then press <OK>.

NOTE

- You can change the displayed language for each login user. ▶ **Customizing the Screen Display Appearance and the Operational Conditions(P. 380)**

Registering Shortcuts for Frequently Used Settings/ Registered Items

961F-061

You can register shortcuts for the settings that are displayed when you press  (Settings/Registration), in <Settings/Regist. Shortcut>. This allows you to quickly display even those settings that are configured deep in the menu hierarchy.

NOTE

- If <Settings/Regist. Shortcut> is not displayed on the <Home> screen, press  ▶ <Home Management Settings> ▶ <Restrict Function Display> ▶ <Set> ▶ set <Settings/Regist. Shortcut> to be displayed.
- Shortcuts that can be registered: 10

1 Press <Settings/Regist. Shortcut>.  <Home> Screen(P. 332)

2 Press <Register>.

3 Select the button in which you want to register settings.



- You can select the assigned button to change the registered settings.

4 Select the settings to register as shortcuts and press <OK>.

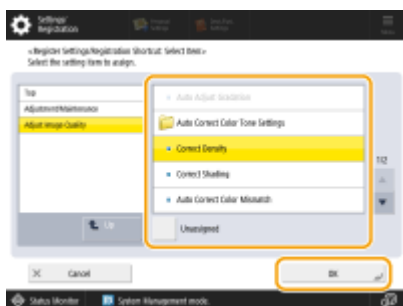

- If you do not want to register settings, select <Unassigned>.

Customizing the Screen Display Appearance and the Operational Conditions

961F-062

Individual users can customize the operational conditions to meet their preferences. For example, users who are English speakers can make a setting so that the English version of touch panel display appears when logging in, and other users can register their own SSID and network key to enable the machine to be easily connected to their mobile device. Because these settings are only enabled when the user who configured the settings logs in, they do not affect the settings of other users.

NOTE

- To use personal settings, you need to log in with personal authentication management. [▶Managing Users\(P. 803\)](#)

Available settings

The settings listed below can be configured.

- The language used on the touch panel display
- Accessibility functions for users who have difficulty seeing or performing input operations on the touch panel display
- Personal access point (personal SSID/network key)
- Automatically printing jobs after logging in

1 Press <Personal Settings>. [▶<Home> Screen\(P. 332\)](#)

- When the login screen is displayed, log in. [▶Logging into the Machine\(P. 355\)](#)

2 Press the setting button that you want to configure.



■ To set the displayed language

Press <Switch Language/Keyboard>, select a language from the list, and press <OK>.

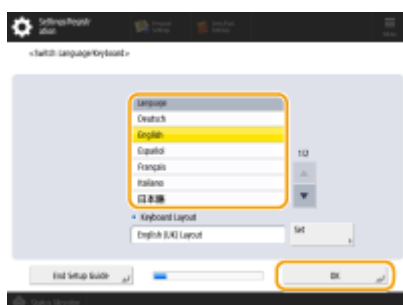

■ To set accessibility

Press <Accessibility>, and select the setting you want to configure.



- Press <Key Repetition Settings> to change the speed at which the same character is entered repeatedly when a button is held down. This setting may prevent users from inadvertently entering the same character more than once when performing input operations slowly.
- Press <Reversed Display (Color)> ► <On> ► <OK> to invert the screen colors and make text easier to read.
- Press <Enable Screen Magnification> ► <On> ► <OK> to enable you to zoom in or out on some screens by pinching out or in.

■ To specify a personal SSID and network key

Press <Personal SSID and Network Key Settings>, specify a personal SSID and network key, and press <OK>.



- When <Automatically Enable/Disable Direct Connection at Login/Logout> is set to <On>, direct connections are possible when logging in without the need to press <Enable> for <Direct Connection> in <Mobile Portal>.

NOTE

- This setting can be used when <Use Personal SSID and Network Key> is set to <On> in <Access Point Mode Settings>. ► <Access Point Mode Settings>(P. 1130)
- Only one mobile device may connect at a time when a personal SSID and network key are set.

■ Auto Print User Jobs When Logging In

- Press <On> to enable the <Auto Print User Jobs When Logging In> setting.

NOTE

- This setting is disabled if any of the following settings is specified.
 - If <Use User Authentication> is set to <Off>
 - If <Enable Auto Print Function When Logging In> is set to <Off>
 - If <Enable Use of Personal Settings> is set to <Off>
 - If <Use ACCESS MANAGEMENT SYSTEM> is set to <On>
 - If <Only Allow Encrypted Print Jobs> is set to <On>

- If <Personal> of <Job List Display Settings> is set to <Off>
- If <Display Warning When Starting to Print> of <Held Jobs Warning Settings> is set to <On>
- For details on this function, see [▶Printing Documents Retained in the Machine \(Forced Hold Printing\) \(P. 608\)](#) .

NOTE

Set the screen that is displayed when the machine starts

- If the machine is configured so that users are required to log in when it starts up ([▶Specifying When to Display the Login Screen\(P. 835\)](#)), <Default Screen after Startup/Restoration> is displayed as an item in <Personal Settings>. The screen that is displayed after the machine starts up can be set for each user.

LINKS

- [▶List of Items That Can Be Personalized\(P. 357\)](#)
- [▶Switching the Displayed Language\(P. 377\)](#)
- [▶<Accessibility>\(P. 1143\)](#)
- [▶<Access Point Mode Settings>\(P. 1130\)](#)

Canceling Send/Print Jobs



961F-063

If you press  (Stop) on the control panel while a send/print job is being processed and a screen that leads to <Send Jobs>/<Print Jobs> is being displayed, the ongoing send/print job is paused, and <Send Jobs>/<Print Jobs> appears.



Select the job that you want to cancel, and press <Cancel>.

NOTE

- Screens that lead to <Send Jobs>/<Print Jobs>
 - <Home> screen
 - <Print> screen
 - Top screens of <Status Monitor> (<Copy/Print>, <Send>, <Receive>, <Store>, <Consumables/Others>)
 - <Visual Message Settings> screen
- If you press  (Stop) on the control panel while a send/fax job is being processed and the <Fax>/<Scan and Send> screen is being displayed, a pop-up screen that directly cancels the ongoing job appears. When multiple jobs are in process, you can set which job to cancel: the job that was last made, or the job that is in the process of sending. (▶<Job to Cancel When Stop is Pressed>(P. 1237))
- If there is a job that was started after pressing  (Stop) on the control panel, the job is performed.
- For instructions on canceling jobs from the <Copy> screen or <Fax> screen, see ▶<Cancelling Copying>(P. 431) or ▶<Canceling Sending Faxes>(P. 540) .

Setting Sounds

You can adjust the volume of sounds produced by the machine when sending/receiving a fax. In addition to setting sounds for faxes, you can specify whether or not confirmation and warning sounds are produced.

- ▶ **Adjusting the Volume for Sending/Receiving Faxes(P. 384)**
- ▶ **Setting the Confirmation Sound and Warning Sound(P. 385)**

NOTE

- This setting works only for Line 1 (the standard line). Use this setting with Line 1 (the standard line).

Adjusting the Volume for Sending/Receiving Faxes

You can adjust the volume of the communication sounds during fax transmission and the sound produced for the fax sending/receiving result. You can also set whether to sound a tone indicating the result of Fax Memory Lock sending/receiving.

- 1** Press **<Volume Settings>**. ▶ **<Home> Screen(P. 332)**
- 2** Adjust the volume or specify the setting, and press **<OK>**.



a <Alarm Volume>

Adjust the volume of the tone that sounds when the sending or receiving faxes is complete (except when printing received faxes) and the volume of the tone that sounds when a fax is canceled or ends due to an error. To mute the sound, press  several times to set the volume to the far left.

b <Monitor Volume>

Adjust the volume of the following tones. To mute the sound, press  several times to set the volume to the far left.

- The tone that sounds when sending faxes
- The tone that sounds when printing of a received fax is complete, and the tone that sounds when a fax ends due to an error

c <Memory RX/TX End Tone>

Specify whether or not a sound is produced when Fax Memory Lock sending/receiving completes without an error. ▶ **Saving Received Documents in the Machine (Memory Reception)(P. 566)**

d <Memory RX/TX Error Tone>

Specify whether or not a sound is produced when Fax Memory Lock sending/receiving completes with an error. ▶ **Saving Received Documents in the Machine (Memory Reception)(P. 566)**

Setting the Confirmation Sound and Warning Sound

The machine produces sounds in a variety of situations, such as when control panel keys or touch panel buttons are pressed, or when a malfunction occurs. You can specify whether or not set each sound individually.

1 Press <Volume Settings>. ◀<Home> Screen(P. 332)

- If your machine does not have a fax function, proceed to Step 3.

2 Press <Other Volume Settings>.

3 Set each confirmation sound/warning sound and press <Close>.



Setting Items	Description
<Entry Tone>	Sound produced each time a key on the control panel or a button on the touch panel display is pressed
<Invalid Entry Tone>	Sound produced when an invalid key/button operation is performed, or when you enter a number outside the valid setting range
<Restock Supplies Tone>	Sound produced when the amount of toner is low
<Forgot Original Tone>	Sound produced if original is remained on the platen glass after operation is finished
<Error Tone>	Sound produced when a malfunction such as paper jam or operational error occurs
<Job Done Tone>	Sound produced when an operation such as copying or scanning is complete
<Sleep Mode Tone>*1	Sound produced when the machine enters sleep mode, or when the machine is turned OFF if you set <Quick Startup Settings for Main Power> to <On>. (Depending on the situations, the machine does not startup quickly and the tone does not sound.)
<Login Tone>	Sound produced when login is successful
<Non-Empty Toner Rplcd. Tone>*2	Sound produced when a non-empty toner cartridge is removed

*1 May appear as <Energy Saver/Sleep Tone> on some models.



*2 May not appear on some models.

4 Press <OK>.

Entering Sleep Mode

961F-065

The sleep mode function reduces power consumption by temporarily disabling some internal operations of the machine. You can easily put the machine into sleep mode by pressing  (Energy Saver) on the screen. When the machine is in the sleep mode, the touch panel display turns off.

- On machines with an upright control panel, press  (Energy Saver) on the control panel.  (Energy Saver) lights up in sleep mode.

NOTE

- The machine may not enter sleep mode depending on the machine's operation status and conditions.
- You can set the order for starting necessary functions when you perform operations after exiting sleep mode.  **<Sleep Mode Eco Exit>(P. 1078)**
- The Processing/Data indicator flashes or maintains a steady green light even when the machine enters the Sleep mode.









Exiting Sleep Mode

- Press the touch panel display. On machines with an upright control panel, press  (Energy Saver).

When You Want to Set the Auto Sleep Timer

You can use the <Auto Sleep Time> setting to automatically put the machine into sleep mode. If you want to change the amount of time that elapses before the machine enters auto sleep mode, follow the procedure below.



 (Settings/Registration)  <Preferences>  <Timer/Energy Settings>  <Auto Sleep Time>
  or  to set the amount of time that elapses before the machine automatically enters sleep mode  <OK>.

NOTE

- You can set the time range to automatically enter sleep mode by the day of the week.  **<Auto Sleep Weekly Timer>(P. 1077)**

Energy Consumption in Sleep Mode

You can set the amount of energy that the machine consumes when it is in sleep mode. Follow the procedure below to set the amount of energy consumed in sleep mode.



 (Settings/Registration)  <Preferences>  <Timer/Energy Settings>  set <Sleep Mode Energy Use> to <Low> or <High>.

NOTE

When using a wireless LAN also while in sleep mode

- Set <Sleep Mode Energy Use> to <High>.  <Sleep Mode Energy Use>(P. 1077)

Registering Destinations

961F-066

Destinations for sending faxes and scanned data can be registered in the Address Book or one-touch buttons.

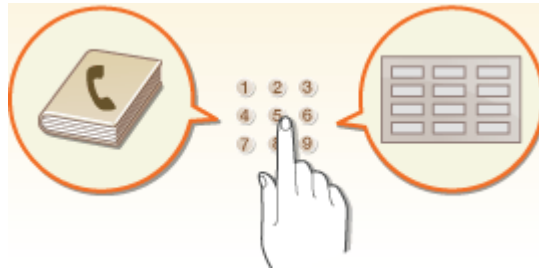

Address Book

If you want to register many destinations or classify them by department or business partner, register them in the Address Book. The Address Book allows you to search destinations by the first character of the name or by selecting a function such as fax or e-mail. You can register destinations for all users, destinations for your own use, and destinations that only an administrator can edit. **▶ Registering Destinations in the Address Book (P. 394)**



a Function type button

Select the button to filter destinations by function such as fax or e-mail.

b Address list drop-down list

Select an address list for a department or business partner.

c <Search by Name>

Enter the destination name.

d First letter button

Select the alphanumeric button for the first character of the destination name.

One-Touch Button

You can register frequently used destinations in one-touch buttons to simplify operations. The one-touch buttons with registered destinations are displayed on the touch panel display, enabling you to quickly search

and specify the destinations with the simple press of a button. **▶Registering a Destination in a One-Touch Button(P. 410)**



(Items shown on the screen may differ depending on your model and options.)

a One-touch button

You can easily specify the desired destination with the simple press of a button.

b One-touch number button

You can enter the three-digit number of a registered one-touch button if it is not shown on the touch panel display.

NOTE

For the administrator

- The Address Book and one-touch buttons can be exported/imported. This can be used for backup data if a failure occurs or to simplify the procedure for registering destinations between supported machines. For more information, see **▶Backing Up/Restoring Data(P. 965)** .
- The Address Book can be personalized for each logged-in user (**▶List of Items That Can Be Personalized(P. 357)**). Furthermore, the Synchronize Custom Settings facility can be used to enable the Address Book to be shared by a number of Canon multifunction printers (**▶Synchronizing Settings for Multiple Canon Multifunction Printers(P. 988)**).
- You can set a password to avoid unauthorized editing or deletion in the Address Book. **▶Setting a PIN for Address Book(P. 879)**
- If there are destinations that you do not want to display in the Address Book or if you want to limit user access to destinations, enter an access number when registering a destination. To use the access number, it is necessary to activate the setting in advance in **▶Restricting Access to Destinations Registered in the Address Book(P. 880)** .
- Configure User Group Address Lists from the Remote UI. (**▶Registering Destinations via the Remote UI(P. 912)**)

About the Address Books of the Machine

961F-067



Local Address Book and Remote Address Book

Local Address Book: The address book stored on the storage device of the machine. This address book is comprised of the following address lists.

- Address List 01 to 10
- Address List, One-Touch
- Address List for Administrator
- Personal Address List
- User Group Address List 01 to 50

Remote Address Book: The address book of another Canon machine connected to the machine via a network. It can be accessed in the same way as the Local Address Book to specify destinations.

NOTE

- To use a Remote Address Book, it is necessary to register the Remote Address Book to access on the client machine ( **<Acquire Remote Address Book>(P. 1318)**) and make the Remote Address Book open on the server machine ( **<Make Remote Address Book Open>(P. 1320)**).
- Up to eight machines including this machine can be connected as client machines at the same time to the server machine with the Remote Address Book that is opened externally. However, if the server machine is performing other network communication during this time, the number of machines that can connect may be reduced. If the machine cannot connect, a network error notice is sent.
- The server machine destinations registered in Favorite Settings and the **<Personal>/<Shared>** button of the client machine are not updated when the destinations are updated on the server machine. Confirm if the destination is updated when you cannot send to the registered destinations
- You cannot edit or delete destinations registered in a Remote Address Book from a client machine. To edit or delete destinations viewed in a Remote Address Book, do so in the Local Address Book on the server machine from which the Remote Address Book was shared using **<Make Remote Address Book Open>**.

Overview of Address Lists

■ Address List 01 to 10

Address lists that are open to all users.

■ Address List, One-Touch

The one-touch button destinations displayed on the **<Fax>** screen and **<Scan and Send>** screen. Only the one-touch buttons for fax destinations are displayed on the **<Fax>** screen. Fax destinations are also displayed on the **<Scan and Send>** screen if **<Enable Fax in Scan and Send Function>** is set to **<On>**.

■ **Address List for Administrator**

Used to register destinations used in <Forwarding Settings> and <Archive TX Document>.

■ **Personal Address List**

The personal address list displayed when user authentication is used.

■ **User Group Address List 01 to 50**

The group address list available to a group of users when user authentication is used. A User Group Address List corresponds to a single user group.

NOTE

- <Use Personal Address List> and <Use User Group Address List> must be enabled to use **▶<Use Personal Address List>(P. 1316)** and **▶<Use User Group Address List>(P. 1316)** .
- To use a User Group Address List, it is necessary to create a user group in advance (**▶Registering User Information in the Local Device(P. 809)**) and associate the created user group with the User Group Address List (**▶Registering Destinations via the Remote UI(P. 912)**).

Moving/Copying Destination Addresses

The table below indicates whether destination addresses can be moved or copied between the various address books.

		Move/Copy to:		
		Address List 01 to 10, Address List for Administrator	Personal Address List	User Group Address List 01 to 50
Move/ Copy from:	Address List 01 to 10, Address List for Administrator	Move	Copy	Copy
	Personal Address List	Copy	--	Move
	User Group Address List 01 to 50	Copy	Move	Move

NOTE

Destination addresses cannot be moved/copied in the following situations.

- Situations when destination addresses cannot be copied to <Address List 1> to <Address List 10>
 - When a general user is performing the operation and <Address Book PIN> has been set but the user has not entered the PIN
 - When the user is performing the operation from the control panel and <Use User Group Address List> is set to <On (Browse Only)> (Copying can be performed from the Remote UI)
- Situations when destination addresses cannot be copied to the <Personal Address List>
 - When <Use Personal Address List> is set to <Off>
 - When <Use User Group Address List> is set to <On (Browse Only)>
- Situations when destination addresses cannot be moved/copied to "User Group Address List 01 to 50"

- When <Use User Group Address List> is set to <On (Browse Only)> or <Off>

Differences in Address List Types

	Address List 01 to 10	Address List, One- Touch	Address List for Administrator	Personal Address List	User Group Address List 01 to 50
People who can use the address book	All users	All users	All users	Each logged- in user	Each user group* ¹
Address Book PIN (registration restriction)	Yes	Yes	No	No	No
Manage Address Book Access Numbers function	Yes	No	No	No	No
Printing the address list	Yes	Yes	Yes	No	No
Can be set as a <Forwarding Destination> in <Forwarding Settings>	Yes	Yes	Yes	No	No
Can be set with <URL Send Settings> in <Set Fax/I-Fax Inbox>	Yes	Yes	Yes	No	No
Can be set as a notification destination of <Job Done Notice>	Yes	Yes	Yes	No	No
Can be set as <Reply-to>	Yes	Yes	Yes	No	No
Creating <Group> in an address list	Yes	Yes	Yes	Yes	Yes

*1 Only the user groups that the user logged in on the control panel belongs to can be accessed. All User Group Address Lists can be accessed when a user with Administrator privileges logs in from the Remote UI.

NOTE

- For information on the maximum number of destinations that can be registered to each address list, see **Management Functions(P. 1586)** ▶ "Max. Destinations Registered to Address Book."
- The maximum number of Personal Address Lists and User Group Address Lists that can be stored in the machine depends on the limit in the user settings information. See **Management Functions(P. 1586)** ▶ "Maximum number of users whose setting information can be saved in the machine."

Registering Destinations in the Address Book

961F-068



You can register a recipient's fax number or an e-mail address that can be used when sending scanned originals in the Address Book. You can also register an I-fax destination, a file server folder location (IP address and path), and the storage (Advanced Space) of a Canon multifunction printer* in the Address Book as a destination.

* Available only for the imageRUNNER ADVANCE series

NOTE

- To register a destination for your own use, you need to log in with personal authentication management. ▶ **Managing Users(P. 803)**
- Registering/editing/deleting of destinations can also be performed from the following screens:
 - <Address Book> on the Fax Basic Features screen ▶ ▶ **Basic Operations for Sending Faxes(P. 524)**
 - <Address Book> on the Scan Basic Features screen ▶ ▶ **Basic Operations for Scanning Originals(P. 640)**

1 Press <Dest./Fwd. Settings>. ▶ <Home> Screen(P. 332)

2 Press <Register Destinations>.

3 Press <Register New Destination>.

4 Select functions you want to register.

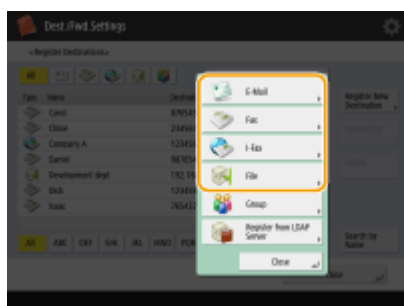

- Select the functions to use for the destination, from <Fax>, <E-Mail>, <I-Fax>, or <File>.

5 Press <Name> ▶ enter the destination name, and press <OK>.

6 Select the address list from <Personal Address List>, User Group Address Lists, <Address List 1> to <Address List 10> and <Address List for Admin.>.

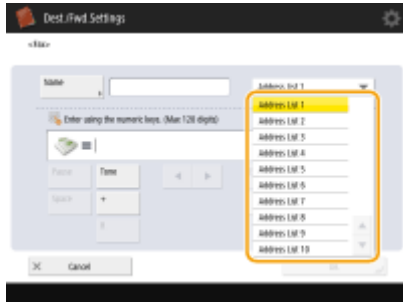

(Items shown on the screen may differ depending on your model and options.)

- If you want to register the destination for your own use, select <Personal Address List>.
- If you want to register the destination which only an administrator can edit, select <Address List for Admin.>.
- If you want to share the destination with a registered user group, select a registered User Group Address List.

NOTE

- <Address List 1> to <Address List 10> can be regarded as 10 separate address books. Classifying an address list by departments or by business partners makes them easier to find when specifying a destination. It is also easier to manage an address list if you change their names to department name or business partner name (▶<Rename Address List>(P. 1311)).
- You can also manage User Group Address Lists by enabling only the administrator to register/edit destinations from the Remote UI. ▶<Use User Group Address List>(P. 1316)

7 Configure settings depending on the function selected in step 4.

■ Fax

- 1 Enter the fax number.



a Fax number field

Enter the fax number using the numeric keys. Enter **b** to **g** as necessary.

b <Backspace>

Delete numbers to the left of the cursor in the fax number field (**a**) one by one.

c ◀/▶

Press when moving the fax number field cursor (**a**) to the left or right.

d <Tone>

If you press this button, the character "T" (tone) is inserted. Even if you are using pulse dial, numbers following "T" will be sent using tone dial.

e <R> key

If the machine is connected to a PBX (Private Branch Exchange), press this button before entering the destination. If this button is not available, you need to register the R-key settings. **>>><R-Key Setting>(P. 1256)**

f <Space>

Enter a blank space between numbers to make them easier to read.

g <Pause>

If you press this button, the character "P" (pause) is inserted. When sending a fax overseas, insert pauses after the international access code or fax number. This helps to improve the connection.

NOTE

- You cannot insert a pause at the beginning of a number.

2 Press <Set Details> and specify settings as necessary.**a <Subaddress>/<Password>**

Specify when sending or receiving documents to increase security by attaching a subaddress and password to all of your fax transactions. **>>>Basic Operations for Sending Faxes(P. 524)**

b <ECM TX>

Select <On> to correct image errors. Select <Off> if the recipient's fax machine does not support the Error Correction Mode (ECM).

! IMPORTANT

- To send faxes using ECM, it is also necessary to set **>>><ECM TX>(P. 1252)** to <On>.

c <Select Line>

If you have additional telephone lines, you can select the line to use for sending a fax.

d <Long Distance>

If transmission errors occur frequently when you make overseas calls, select <Long Distance (1)>. If errors persist, change the setting to <Long Distance (2)> or <Long Distance (3)>.

e <Sending Speed>

Depending on the recipient's fax machine or the status of the line, a transmission error may occur due to the transmission speed. If errors occur frequently, lower this setting value.

NOTE

- Although there are items you can set in the fax setting (**>>>Fax Basic Features Screen(P. 521)**), it is convenient to set them here if you want to change the sending conditions for each destination.

- Set **<Auto Adjust Communication Speed When Using VoIP>(P. 1257)** to <On> to send and receive faxes more accurately when the line or other party is prone to errors. If you set this to <On>, the communication speed is limited to 14,400 bps or slower, which reduces errors.

E-mail

- 1 <E-Mail Address> ► enter the e-mail address and press <OK>.

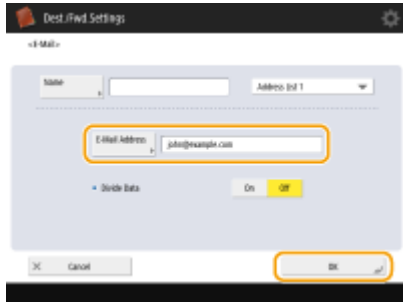

- 2 Select <On> or <Off> in <Divide Data>.

If the size of the data being sent exceeds the maximum limit (**<Maximum Data Size for Sending>(P. 1243)**), select whether you want to divide the data by size or by page.

- If you select <On>, the data is divided into smaller sizes that do not exceed the limit and is sent in several sections. The recipient's e-mail software must be able to combine the data received.
- If you select <Off>, the number of pages to be sent at one time decreases and the total transmission is divided into several sections. For example, 10 pages of data are transmitted twice, 5 pages each time. Therefore, your counterpart receives two e-mails. However, if you send data that cannot be separated into pages, such as JPEG, a transmission error occurs.

NOTE

- When the domain to use is fixed, you can skip domain entry. You can register a domain name to **<Auto Add Specified Domain to Dest. Without Domain>(P. 1248)** and enable <When Sending E-Mail> in advance to automatically add a domain when sending, without the need to enter "@" and the domain name.
- You can register frequently used domain names in <Registered Characters> on the keyboard, and you can recall them when entering an e-mail address. **<Registered Characters for Keyboard>(P. 1067)**

I-fax



- 1 Specify settings as necessary.



- a** <Send via Server>

Specify whether or not to send I-faxes to destinations via the mail server. Select <On> if you want to send I-faxes via the mail server. Select <Off> if you want to send data directly to a recipient on the same local area network (LAN). By sending directly to a recipient, you can send large amounts of data without placing a burden on the mail server.



NOTE

- To send an I-fax that is not in an IP address format such as "user name@[the recipient's IP address]" without using a mail server, settings such as an MX (Mail eXchange) record need to be configured on the DNS server. Ask your Network administrator whether or not this type of setting is available.
- When you set <Off> in <Send via Server>, you are required to set <On> in  <Use Send via Server>(P. 1246) in advance. If this setting is <Off>, the setting in <Send via Server> cannot be changed. It is recommended to set  <Allow MDN Not via Server>(P. 1247) to <On>.
- Even if you set <Send via Server> to <Off>, delivery confirmation of documents sent using the Full mode is carried out via the server.

<Register Standard Fields>

This setting is required for using an Internet fax service. If you do not use an Internet fax service, this setting is not necessary. For more information, contact your Internet service provider.





<I-Fax Address>

- Enter the I-fax address using the following format: adv01@example.com.
- When sending to a recipient on the same network, use the following format: adv01@[192.168.11.100] (the recipient device name@[IP address]).
- When the domain to use is fixed, you can skip domain entry. You can register a domain name to  <Auto Add Specified Domain to Dest. Without Domain>(P. 1248) and enable <When Sending I-Fax> in advance to automatically add a domain when sending, without the need to enter "@" and the domain name.
- You can register frequently used domain names in <Registered Characters> on the keyboard, and you can recall them when entering an I-fax address.  <Registered Characters for Keyboard>(P. 1067)

<Mode:>

You can select the type of sending results that are displayed when  (Status Monitor) is pressed. Select <Full> if you want to check whether an I-fax is delivered to the recipient's machine, or select <Simple> if you want to check whether an I-fax is delivered to a mail server. Note that you cannot confirm the delivery status if the recipient's machine does not support the <Mode:> function.

NOTE

- If you send an I-fax using the <Full> mode to a machine that does not support the <Full> mode, <Awaiting result...> is displayed when you press  (Status Monitor) to check the delivery status, even if the transmission is complete. It continues to be displayed until the time set in  <Full Mode TX Timeout>(P. 1246) passes.
- You can check the delivery status by pressing  (Status Monitor)  <Send>  <Job Log>. If the document was sent successfully, <OK> will be displayed, if it failed to send, <NG> will be displayed, and if the results cannot be confirmed, <--> will be displayed. In the Simple mode, even if the delivery was successful, <--> will be displayed because delivery confirmation cannot be carried out.

- 2 Press <Destination Conditions>  specify each setting and press <OK>.



(Items shown on the screen may differ depending on your model and options.)

a <Paper Size>

Set the paper size that the recipient can receive. Specify this setting after checking whether the paper size of the data to send matches the specifications of the recipient's device.

- <A4/LTR>: Sends with the A4/LTR size.
- <A4/LTR> + <B4>: Sends with the A4/LTR size or B4 size.
- <A4/LTR> + <A3/11x17>: Sends with the A4/LTR size or A3/11" x 17" size.
- <A4/LTR> + <B4> + <A3/11x17>: Sends with the A4/LTR size, B4 size, or A3/11" x 17" size.

NOTE

- If the paper size of the scanned data is smaller than the sizes set in <Paper Size>, the data is sent with the smallest paper size set in <Paper Size> with blank margins.
- If the paper size of the scanned data is larger than the sizes set in <Paper Size>, the data is reduced and sent with the largest paper size set in <Paper Size>.
- Set the destination conditions according to the specifications of the recipient's machine. If the paper size of the data to send is larger than the paper sizes that can be used with the recipient's device, the image may be clipped or cut off.

b <Compression Method>

Select compression method. The compression rate is highest for MMR, followed by MR, and then MH. The higher the compression rate, the shorter the required transmission time.

c <Resolution>

Select a higher value to increase the resolution and image quality. However, the higher the resolution, the longer the required transmission time.

d <Divide Data>

If the size of the data being sent exceeds the maximum limit (▶<Maximum Data Size for Sending>(P. 1243)), select whether you want to divide the data by size or by page.

- If you select <On>, the data is divided into smaller sizes that do not exceed the limit and is sent in several sections. The recipient's device must be able to combine the data received.
- If you select <Off> in <Send via Server> (a) in step 1 for configuring the I-fax setting, the data is sent without being divided, even if it exceeds the maximum limit.

e <Receive in Color>

Enables you to send in color if the destination machine supports color. Press <On> ▶ <Next>, and set the paper size and resolution.

! IMPORTANT

- Set the destination conditions according to the specifications of the recipient's machine. If you set conditions that the recipient's machine does not support, a transmission error may occur.

■ File server/Advanced Space

- 1 Enter the host name of the file server/Advanced Space which transmits data.

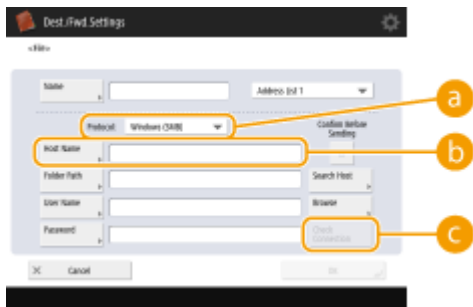

- Ask your Network administrator about the information on the file server/Advanced Space.

a <Protocol>

Select a protocol for the file server from <Windows (SMB)>, <FTP> and <WebDAV>.

When sending a document to the Advanced Space, select <Windows (SMB)> or <WebDAV>.

NOTE

- If you select <Windows (SMB)>, the <Search Host> and <Browse> buttons are displayed. You can easily specify a file server/Advanced Space by searching or viewing the network.
- You can only use <Browse> if <1.0> is set to <On> in <Specify SMB Client Version>.
- You can register up to five Directory servers used in <Browse>.

b <Host Name>

Enter the host name of the file server/Advanced Space.

- If you select <FTP> for the protocol, enter <Host Name> as follows.

When TLS is disabled

Example:

To save to the Shared Space: ftp://host name/share

To save to the Personal Space: ftp://host name/users

When TLS is enabled

Example:

To save to the Shared Space: ftps://host name/share

To save to the Personal Space: ftps://host name/users

When sending a document to the Advanced Space, enter <Host Name> as follows.

- If you select <Windows (SMB)> for the protocol

Example:

To save to the Shared Space: \\192.168.100.50\share

To save to the Personal Space: \\192.168.100.50\users

- If you select <WebDAV> for protocol

When TLS is disabled

Example:

To save to the Shared Space: http://<IP address or host name>

To save to the Personal Space: http://<IP address or host name>

When TLS is enabled

Example:

To save to the Shared Space: https://<IP address or host name>

To save to the Personal Space: https://<IP address or host name>

c <Check Connection>

Press this button after entering the host name to confirm the connection with the file server/Advanced Space.

NOTE

- If you are using a login service such as personal authentication management, it is necessary to enter <User Name> and <Password>.

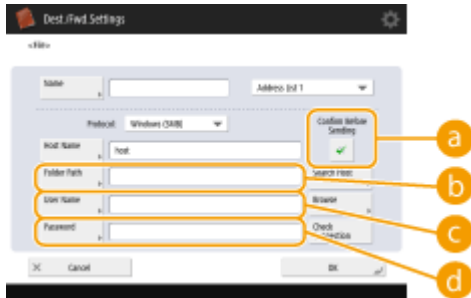
2 Configure the file server/Advanced Space information.

- Ask your Network administrator about the file server/Advanced Space information and the folder.

a <Confirm Before Sending>

By enabling <Confirm Before Sending>, a screen requiring password entry is displayed before sending, even if a password is entered in (**d**).

b <Folder Path>

Specify the folder's directory to which data is sent.

When sending a document to the Advanced Space with <WebDAV> selected for the protocol, enter <Folder Path> as follows.

Example:

To save to the Shared Space: /share

To save to the Personal Space: /users

c <User Name>

Enter the login user name of the file server/Advanced Space.

d <Password>

Enter the login password of the file server/Advanced Space.

NOTE

- When the file server/Advanced Space destination is included in the group (**▶Registering Multiple Destinations as a Group(P. 405)**), clear the check box in (**a**). If the check box is selected, you cannot send data.
- If you specify the destination for which you activate <Confirm Before Sending> as the forwarding destination, the screen to enter the password does not appear. The registered password is used and forwarding is performed.
- You can use different authentication information from the user name in (**c**) and password in (**d**) to register to the address book. For more information, see **▶<Information Used for File TX/ Browsing Authentication>(P. 1196)** .
- If you set <Protocol> to <Windows (SMB)> or <FTP>, specifying a folder that does not exist in <Folder Path> will result in the folder being automatically created and files being stored within. However, a sending error will occur if you specify a folder with multiple levels.
- When checking a WebDAV connection, the HEAD method of HTTP is used to check the connection. The folder specified in <Folder Path> is accessed using the HEAD method. If access via the HEAD

method is prohibited for the corresponding folder, an error occurs for the connection check. Examples of settings that prohibit access via the HEAD method are indicated below.

- IIS7: Access cannot be performed via the HEAD method unless [Source] is selected in the access permissions for the WebDAV authoring rules of the target folder.
- Apache: Access cannot be performed via the HEAD method unless HEAD is described using the [Limit] directive in httpd.conf.
- Advanced Space WebDAV server: Access via the HEAD method is always prohibited.

NOTE

- To send to the Advanced Space of a machine from the same machine, it is recommended that you specify a loopback address. If you specify a loopback address, you can use the following functions:
 - You can use the URI sending function to notify a user via e-mail that a file has been saved. **Notifying You by E-Mail of the Completion of Sending/Saving(P. 679)**
 - Even if <Prohibit Writing from External> is set to <On>, users with the Administrator privileges can store in the Advanced Space. **<Prohibit Writing from External>(P. 1294)**
- When sending using a loopback address, enter <Host Name> as follows.

Protocol		To save to the Shared Space of the Advanced Space:	To save to the Personal Space of the Advanced Space:
<Windows (SMB)>		<ul style="list-style-type: none"> • Using the IPv4 format: \\127.0.0.1\share • Using an IP address (IPv6 format): \\[::1]\share • Using a host name: \\localhost\share 	<ul style="list-style-type: none"> • Using the IPv4 format: \\127.0.0.1\users • Using an IP address (IPv6 format): \\[::1]\users • Using a host name: \\localhost\users
<WebDAV>	When TLS is disabled	<ul style="list-style-type: none"> • Using the IPv4 format: http://127.0.0.1 • Using an IP address (IPv6 format): http://[::1] • Using a host name: http://localhost 	<ul style="list-style-type: none"> • Using the IPv4 format: http://127.0.0.1 • Using an IP address (IPv6 format): http://[::1] • Using a host name: http://localhost
	When TLS is enabled	<ul style="list-style-type: none"> • Using the IPv4 format: https://127.0.0.1 • Using an IP address (IPv6 format): https://[::1] • Using a host name: https://localhost 	<ul style="list-style-type: none"> • Using the IPv4 format: https://127.0.0.1 • Using an IP address (IPv6 format): https://[::1] • Using a host name: https://localhost

8 Press <OK> ► <Close>.

NOTE

- When destinations are managed by access numbers, enter the access number (**Restricting Access to Destinations Registered in the Address Book(P. 880)**) after pressing <Next> in step 8.
- If you try to send to a file server/Advanced Space in which <Confirm Before Sending> is set to <On>, a screen appears prompting you to enter a user name and password. In this case, enter the previously set

password. If you want to register a file server/Advanced Space in a group address, set <Confirm Before Sending> to <Off>. You cannot send to a group address including a file server/Advanced Space in which <Confirm Before Sending> is set to <On>.

NOTE

- Multiple destinations registered in the Address Book can be combined into a group. For details, see [▶ Registering Multiple Destinations as a Group\(P. 405\)](#) .
- To change or delete the information of destinations registered in the Address Book, see [▶ Editing the Registered Destinations in the Address Book\(P. 408\)](#) .
- UPN can be used only if you are sending to a computer belonging to a domain operated with Active Directory.

TIPS

If the LDAP server has already been registered in the machine ([▶ Registering the LDAP Server\(P. 299\)](#)), you can search for destinations and register them in the Address Book. Press <Dest./Fwd. Settings> ▶ <Register Destinations> ▶ <Register New Destination> ▶ <Register from LDAP Server> and search for destinations using <Search by Conditions> or <Search by Name>.

- When the user name and password are correct but the search result is empty, check the time setting both on the LDAP server and the machine. If the time setting between the LDAP server and the machine differs by five minutes or more, a search cannot be performed.
- If multiple destinations are displayed as search results, you can register up to 256 of them at one time.
- The information that can be obtained via the LDAP server consists of only names and fax numbers/addresses. Register other information from <Details/Edit> as necessary.
- You cannot search for destinations on an LDAP server from both the control panel and the Remote UI at the same time.
- When searching for destinations on an LDAP server from the control panel of the machine, you can specify four search conditions. On the other hand, when searching for destinations on an LDAP server from the Remote UI, you can only specify one search condition.
- You may need to enter the user name and password. Enter the user name and password of the machine registered in the LDAP server. If authentication information is not used, search with the user name and password fields in the Remote UI left blank.

Specifying/registering destinations from the send history

- You can specify destinations and register destinations to the address book from the send history on the <Status Monitor> screen. This saves you the effort of directly entering the address, and also helps avoid sending to an incorrect destination due to entering the wrong address.
 - When specifying a destination: <Status Monitor> ▶ <Send> ▶ <Job Log> ▶ select the destination to send to ▶ <Specify as Send Destination> ▶ <OK>
 - When registering a destination: <Status Monitor> ▶ <Send> ▶ <Job Log> ▶ select the destination to register ▶ <Register Destination> ▶ register the destination from the registration screen for each destination type.

[▶ Checking Status and Log for Sent and Received Documents\(P. 574\)](#)

[▶ Checking Status and Log for Scanned Documents\(P. 656\)](#)

LINKS

- [▶ Basic Operations for Sending Faxes\(P. 524\)](#)
- [▶ Basic Operations for Scanning Originals\(P. 640\)](#)
- [▶ Using Storage Space\(P. 706\)](#)

▶<Change Default Display of Address Book>(P. 1311)

▶<Set Destination>(P. 1310)

Registering Multiple Destinations as a Group

961F-069



Multiple destinations registered in the Address Book([▶Registering Destinations in the Address Book\(P. 394\)](#)) can be combined into a group. You can use this feature to send documents and back up data at the same time because different types of destinations can be registered in the same group. For example, you can register e-mail addresses and file server IP addresses together in one group, or fax numbers and I-fax addresses in another one.

NOTE

- To register a group that contains destinations for your own use, you need to log into the machine. [▶ Logging into the Machine\(P. 355\)](#)
- You cannot register new destinations in a group address. Register destinations in the Address Book in advance.
- Only destinations in the same address list can be grouped. Destinations registered in a different address list cannot be grouped.
- You can register up to 256 destinations in a group address.
- Since each address entry is treated as a single entry, if you register a fax number in a group address, the fax number and group address entry are counted as two separate entries.
- In addition to registering destinations such as e-mail addresses, you can register a Mail Box (machine's temporary storage space) in a group ([▶Making Simple Edits to Files\(P. 724\)](#)). For example, when you register a Mail Box in a group and send a scanned document attached to an e-mail, the document can be saved in the machine and checked later.

- 1** Press **<Dest./Fwd. Settings>**. [▶<Home> Screen\(P. 332\)](#)
- 2** Press **<Register Destinations>**.
- 3** Press **<Register New Destination>**.
- 4** Press **<Group>**.
- 5** Press **<Name>** ▶ enter the group name, and press **<OK>**.
- 6** Select the address list.

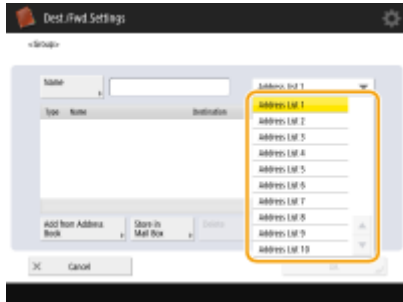

(Items shown on the screen may differ depending on your model and options.)

- You can create a group from the destinations registered in the selected address list. For example, if you select <Address List 2>, you cannot add a destination registered in <Address List 1> to the group. The created group is registered in the address list you select in this step.
- If you want to register a group that contains destinations for your own use, select <Personal Address List>.
- If you want to register destinations in a group which only an administrator can edit, select <Address List for Admin.>.

NOTE

- If you select <Personal Address List>, you cannot select <Store in Mail Box>.

7 Select the destinations you want to include in the group.

- 1 Press <Add from Address Book>.
- 2 Select the destinations you want to register in a group, and press <OK>.



a Destination type button

Select (e-mail), (fax), (I-fax) or (file) to filter the destinations displayed in the address list (**b**). Press <All> to display all registered destinations.

b Destination

Destinations registered in the address list that you selected in step 6 are displayed. From this list, select the destinations you want to register in a group.

NOTE

- When destinations are managed by access numbers, they are not displayed in the list unless you enter the access number (**Restricting Access to Destinations Registered in the Address Book(P. 880)**) after pressing <Access No.>.

c <Details/Edit>

Select a destination and press <Details/Edit> if you want to check the settings of the destination. Press <OK> to return to the previous screen.

d <Search by Name>

Enter the destination name. Press <Search by Name> again to return to the previous screen.

e First letter button

Select the alphanumeric button for the first character of the destination name. Press <All> to display all registered destinations.

■ To Register Mail Boxes in Groups

Destinations in the Address Book and Mail Box can be registered in the same group.

- 1 Press <Store in Mail Box>.
- 2 Select a Mail Box that you want to register in a group, and press <OK>.
 - Only one Mail Box can be registered in a group.

8 Press <OK> ► <Close>.

NOTE

- When destinations are managed by access numbers, enter the access number (**Restricting Access to Destinations Registered in the Address Book(P. 880)**) after pressing <Next> in step 8.
- If you try to send to a file server in which <Confirm Before Sending> is set to <On>, a screen appears prompting you to enter a user name and password. In this case, enter the previously set password. If you want to register a file server in a group address, set <Confirm Before Sending> to <Off>. You cannot send to a group address including a file server in which <Confirm Before Sending> is set to <On>.

Editing the Registered Destinations in the Address Book

961F-06A

After registering destinations, you can change or delete their settings.

- 1 Press <Dest./Fwd. Settings>. ▶<Home> Screen(P. 332)
- 2 Press <Register Destinations>.
- 3 Select the destination you want to edit.



a Destination type button

Select (e-mail), (fax), (I-fax), (file), or (group) to filter the destinations displayed in the address list (c). Press <All> to display all registered destinations.

b Address list drop-down list

Select <Personal Address List>, <Address List 1> to <Address List 10> or <Address List for Admin.> to filter the destinations to be displayed in the address list.

c Destination list

Select the destination you want to edit or delete.

d <Details/Edit>

Press to check or edit the settings of destinations.

e <Delete>

Press to delete the destination.

f <Search by Name>

Enter the destination name. Press <Search by Name> again to return to the previous screen.

g First letter button

Select the alphanumeric button for the first character of the destination name. Press <All> to display all registered destinations.

NOTE

- When destinations are managed by access numbers, enter the access number (**▶Restricting Access to Destinations Registered in the Address Book(P. 880)**) after pressing <Access No.>.
- Destinations in <Personal Address List> are only displayed for the login user that registered them. Even if you have administrator privileges, you cannot view or edit the destinations in <Personal Address List> for other users.

4 Press <Details/Edit>.

- If you want to delete a destination, select the destination and press <Delete> ▶ <Yes>.

5 Edit the settings of the destination.

- For details about how to edit the settings, see **▶Registering Destinations in the Address Book(P. 394)** .

6 Press <OK> ▶ <Close>.

Registering a Destination in a One-Touch Button

961F-06C



It is convenient to register a frequently used destination in a one-touch button. This enables you to quickly specify a destination with the simple press of a button. In addition to registering a fax number or e-mail address in a one-touch button, you can also register a file server folder location (IP address and path) to use when storing scanned data.

1 Press <Dest./Fwd. Settings>. ▶<Home> Screen(P. 332)

2 Press <Register One-Touch>.

3 Select the one-touch number to register the destination in, and press <Register/Edit>.



- A three-digit number (001 to 200) is assigned to each one-touch button. You can also specify a one-touch button by pressing  and entering the three-digit number using the numeric keys.

4 Select functions you want to register.



- Select the functions to use for the destination, from <Fax>, <E-Mail>, <I-Fax>, or <File>. ▶<Registering Destinations in the Address Book(P. 394)>

5 Press <Name> ▶ enter the destination name, and press <OK>.

6 Press <One-Touch Button Name> ► enter the one-touch button name to be displayed, and press <OK>.

7 Configure settings depending on the functions selected in step 4.

- For more information about the settings, see step 7 in [▶Registering Destinations in the Address Book\(P. 394\)](#) .

8 Press <OK> ► <Close>.

NOTE

- Destinations registered in one-touch buttons can be combined into a group and registered as a single destination. For details, see [▶Registering a Group in a One-Touch Button\(P. 412\)](#) .
- To change or delete the information of destinations registered in one-touch buttons, see [▶Editing the Registered Destinations in One-Touch Buttons\(P. 413\)](#) .
- Destinations stored in one-touch buttons also appear in the Local Address Book.

TIPS

If the LDAP server has already been registered in the machine ([▶Registering the LDAP Server\(P. 299\)](#)), you can search for destinations and register them in one-touch buttons. Press <Dest./Fwd. Settings> ► <Register One-Touch> ► select the one-touch button you want to register ► press <Register/Edit> ► <LDAP Server> and search for destinations using <Search by Conditions> or <Search by Name>. After confirming the settings of the destination, press <One-Touch Button Name> ► enter the one-touch name to be displayed ► press <OK>.

- When the user name and password are correct but the search result is empty, check the time setting both on the LDAP server and the machine. If the time setting between the LDAP server and the machine differs by five minutes or more, a search cannot be performed.
- Unlike the Address Book, you cannot select more than one destination at a time to register.
- The information that can be obtained via the LDAP server consists of only names and fax numbers/addresses. Register other information from <Details/Edit> as necessary.

Registering an address from the send history

- You can register a destination in a one-touch button from sent job logs in the <Status Monitor> screen. This saves the labor of manually entering a fax number and other destination information, and contributes to prevention of wrong transmission due to use of destination information registered incorrectly. When you specify an address in sent job logs and press <Register Destination> ► <One-Touch>, a screen for registering various items of destination information in a one-touch button.

[▶Checking Status and Log for Sent and Received Documents\(P. 574\)](#)

[▶Checking Status and Log for Scanned Documents\(P. 656\)](#)

Registering a Group in a One-Touch Button

961F-06E

Destinations registered in one-touch buttons can be combined into a group and registered as a single destination.

NOTE

- You can also register a Mail Box (machine's temporary storage space) in a group (▶ **Making Simple Edits to Files(P. 724)**).

- 1 Press <Dest./Fwd. Settings>. ▶ <Home> Screen(P. 332)
- 2 Press <Register One-Touch>.
- 3 Select the one-touch button you want to register and press <Register/Edit>.



- 4 Press <Group>.
- 5 Press <Name> ▶ enter the group name, and press <OK>.
- 6 Press <One-Touch Button Name> ▶ enter the one-touch button name to be displayed, and press <OK>.
- 7 Select the destinations you want to register in a group.
 - Press <Add from One-Touch> ▶ select the destination ▶ press <OK>.

NOTE:

When selecting a Mail Box

- Press <Store in Mail Box> ▶ select the Mail Box ▶ press <OK>.

- 8 Press <OK> ▶ <Close>.

Editing the Registered Destinations in One-Touch Buttons

961F-06F

After registering destinations, you can change or delete their settings.

- 1 Press <Dest./Fwd. Settings>. ▶<Home> Screen(P. 332)
- 2 Press <Register One-Touch>.
- 3 Select the one-touch button you want to edit or delete.



- If you want to edit the settings of the one-touch button, press <Register/Edit>. For details about how to edit the settings, see step 7 in ▶**Registering Destinations in the Address Book(P. 394)** . Press <OK> after you finish editing.
- If you want to delete a one-touch button, select the one-touch button and, press <Delete> ▶ <Yes>.

- 4 Press <Close>.

Copying

Copying	416
Copy Basic Features Screen	418
Basic Copy Operations	420
Cancelling Copying	431
Enhancing and Adjusting Copy Quality	433
Selecting the Type of Original for Copying	434
Adjusting Sharpness for Copying (Sharpness)	436
Erasing Dark Borders When Copying (Erase Frame)	437
Inverting Colors (Nega/Posi)	439
Adjusting the Color	440
One Touch Color Mode	443
Copying Efficiently	445
Copying Multiple Originals onto One Sheet (N on 1)	446
Copying a Facing Page Original as Two Separate Pages	448
Copying Different Size Originals Together (Different Size Originals)	451
Copying Separately Scanned Originals Together (Job Build)	453
Checking the Copy Results	455
Copying Immediately by Interrupting Other Jobs	458
Functions Useful for Making and Managing Material	459
Finishing by Collating/Grouping	460
Finishing with the Stapler	462
Other Finishing Functions	464
Attaching Numbers and Symbols to Copies	465
Making Booklets	468
Making Booklets (Booklet Copying)	469
Setting Binding Margins	473
Adding a Cover and Back Cover	475
Useful Copy Functions	477
Copying Free Size Originals	479
Mirroring Images (Mirror Image)	480
Shifting the Image	481
Copying with the Image Repeated (Repeat Images)	483
Inserting Sheets and Chapter Pages (Insert Sheets)	485
Inserting Sheets When Copying Onto Transparencies	488

Copying

Combining Jobs with Different Settings Into a Single Job (Merge Job Blocks)	490
Storing Copy Documents in the Machine	493
Notifying You of the Completion of Copying by E-Mail	495
Making ID Card Copies	497
Area Designation	499
Enlarging an Image to Make a Poster	503
Skipping Blank Pages When Printing	507
Restricting Copying of Confidential Documents	509
Embedding the "TOP SECRET" Text (Secure Watermark)	510
Reducing Copying Operations	513
Recalling Previously Used Copy Settings (Previous Settings)	514
Changing the Settings Quickly (Express Copy Screen)	516

Copying

This chapter describes basic copy operations and various other useful functions.

■ Introduction to Basic Copy Operations

This section describes the Copy Basic Features screen and basic copy operations.

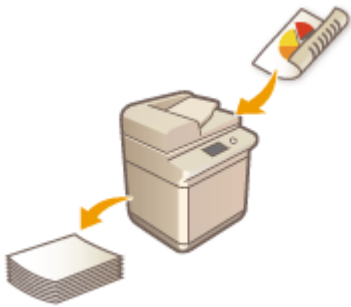

- ▶ **Copy Basic Features Screen(P. 418)**
- ▶ **Basic Copy Operations(P. 420)**
- ▶ **Cancelling Copying(P. 431)**

■ Enhancing Quality and Efficiency

This section describes functions useful for enhancing copy quality and operational efficiency such as adjusting sharpness to obtain clearer print results and combining multiple originals to efficiently copy them at once.



- ▶ **Enhancing and Adjusting Copy Quality(P. 433)**
- ▶ **Copying Efficiently(P. 445)**

■ Making Booklets and Handouts

This section describes copy functions that enable you to create booklets with covers, or create documents suitable for distribution and management with page numbers, reference numbers, etc.



- ▶ **Making Booklets(P. 468)**
- ▶ **Functions Useful for Making and Managing Material(P. 459)**

■ Using Useful Copy Functions

This section describes various copy functions from document editing functions, such as layout change and label making, to security functions for preventing information leakage.

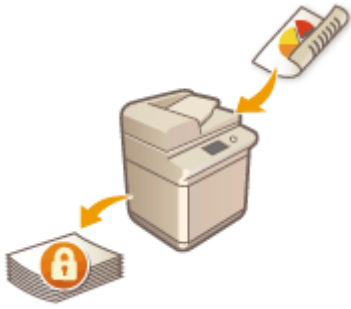

- ▶ **Useful Copy Functions(P. 477)**
- ▶ **Restricting Copying of Confidential Documents(P. 509)**
- ▶ **Reducing Copying Operations(P. 513)**

Copy Basic Features Screen

961F-06J

Pressing <Copy> ( <Home> Screen(P. 332)) displays the Copy Basic Features screen.

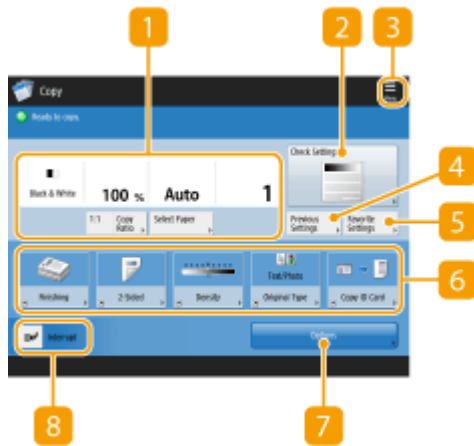

(Items shown on the screen may differ depending on your model and options.)

1 Current setting status and setting buttons



Displays setting status such as the copy ratio, paper size, and number of copies. Make sure to confirm the settings in order to copy properly. To change the settings, press the button under the display section.  **Basic Copy Operations(P. 420)**

- If you press <1:1>, you can make copies the same size as your original.
- Depending on the number of copies and settings, <Copy Sample> is displayed to check the copy result by printing a sample copy.  **Checking the Copy Results(P. 455)**

2 <Check Settings>

You can check the settings in the list. You can also make changes to the settings.  **Basic Copy Operations(P. 420)**

3

Press this icon to register the current settings in <Favorite Settings> of  **5** or to change the buttons displayed in  **6**.

-  **Registering a Combination of Frequently Used Functions(P. 367)**
-  **Customizing the Basic Features Screen(P. 370)**

4 <Previous Settings>

Press to recall the previously specified settings.  **Recalling Previously Used Copy Settings (Previous Settings)(P. 514)**

5 <Favorite Settings>

Register frequently used copy settings here in advance to easily recall them when necessary.  **Registering a Combination of Frequently Used Functions(P. 367)**

6 Function setting buttons

Displays the most frequently used buttons from <Options>. The setting status is displayed on the buttons. You can also press **3** to change which buttons are displayed.

- If the button for the function that you want to use is not displayed, press <Options> and select the desired button. ▶ **Basic Copy Operations(P. 420)**

7 <Options>

Displays all of the function setting buttons. For convenience, you can display frequently used function setting buttons in **6**.

8 <Interrupt>

You can interrupt waiting copy jobs and make your copy immediately. ▶ **Copying Immediately by Interrupting Other Jobs(P. 458)**

NOTE

- Some functions cannot be used in combination with each other. Buttons that cannot be selected are displayed in light gray.
- The number of pages remaining is displayed if a page limit is set with Department ID Management. For information on setting Department ID Management and page limits, see ▶ **Configuring the Department ID Management Settings(P. 842)** .

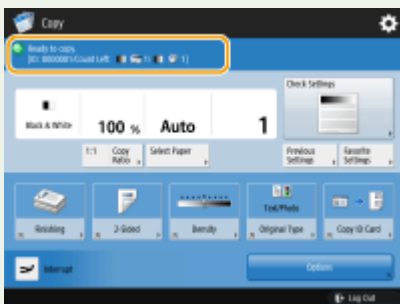

TIPS

- Change the Copy Basic Features screen to the "Express Copy Screen" to enable quick access to each setting item. ▶ **Changing the Settings Quickly (Express Copy Screen)(P. 516)**

Basic Copy Operations

This section describes the basic operations for copying.

1 Place the original. ▶ **Placing Originals(P. 39)**

NOTE

- If <Auto Collate> is set to <On>, the Collate mode is automatically set when you place your originals in the feeder. ▶ **<Auto Collate>(P. 1198)**
- When the screen for selecting the original thickness appears, select the thickness of the original being used.
(Appears if <Original Thickness Defaults for Scan from Feeder> is set to <Mode>. ▶ **<Original Thickness Defaults for Scan from Feeder>(P. 1189)**)

2 Press <Copy>. ▶ **<Home> Screen(P. 332)**

3 Enter the number of copies using the numeric keys on the Copy Basic Features screen. ▶ **Copy Basic Features Screen(P. 418)**

4 Specify the copy settings as necessary.

- ▶ Selecting Color Copying or Black and White Copying
- ▶ Enlarging or Reducing Copies
- ▶ Selecting Copy Paper
- ▶ 2-Sided Copying
- ▶ Adjusting Image Quality of Copies

Selecting Color Copying or Black and White Copying



You can select the color mode for copying. For example, this enables you to save toner by copying color originals in black and white, or copying tickets with a single color such as red or blue to indicate the date they are distributed.

1 Press <Select Color>.

2 Select the color to copy with.

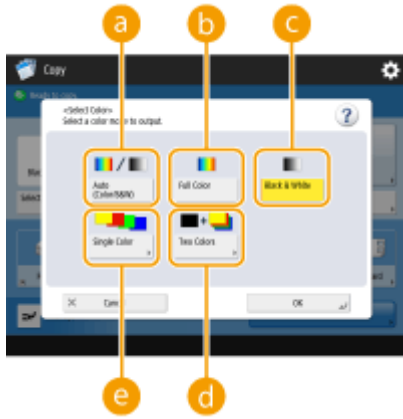

a <Auto (Color/B&W)>

Automatically detects the color of the original. Color pages are copied in four colors (CMYK), and black and white pages are copied in black (K) only.

b <Full Color>

Copies in four colors (CMYK), regardless of the color of the original.

c <Black & White>

Copies in black (K) only, regardless of the color of the original.

d <Two Colors>

Copies in black and the color you specify. Select <Red>, <Green>, <Blue>, <Yellow>, <Magenta>, or <Cyan>.

NOTE

- You can set whether to replace a chromatic color other than the specified color (or approximate color) with black or the specified color. ▶<Conversion Color by Specific Color for Two Colors Print>(P. 1173)

e <Single Color>

Copies with the color you specify only. Select <Red>, <Green>, <Blue>, <Yellow>, <Magenta>, or <Cyan>.

Example: If you copy with red



3 Press <OK>.

! IMPORTANT

- Depending on the state of the color original, it may be detected as black and white when scanned, even if you set <Auto (Color/B&W)>. To avoid this, set the color mode to <Full Color>.
- When the Auto (Color/B&W) mode is set, black-and-white copies are output at the same speed as colour copies.
- If a black-and-white document is copied in the <Full Color>, <Single Color>, or <Two Colors> mode, it is counted as a color copy.

- If you scan different sized originals without setting the Different Size Originals mode or selecting a non-standard paper size as the paper size, the machine may not be able to detect whether your originals are color or black-and-white.

NOTE

- The following restriction(s) will apply when storing originals in the Mail Box.
 - Color pages are stored in the RGB format.
 - You cannot specify <Two Colors> and <Single Color>.

Enlarging or Reducing Copies



You can enlarge or reduce copies from standard paper sizes to other standard paper sizes.

- ▶ Enlarging or Reducing Copies with Standard Paper Sizes



You can enlarge or reduce by specifying the copy ratio (%). You can specify the vertical and horizontal ratios individually.

- ▶ Enlarging or Reducing Copies by Specifying the Copy Ratio



You can enlarge or reduce by specifying the finished dimension, and the output image is fit to the dimension. You can specify the vertical and horizontal dimensions individually.

- ▶ Enlarging or Reducing Copies by Specifying Dimensions



You can enlarge or reduce to automatically fit the paper size selected.

- ▶ Enlarging and Reducing Copies to Fit Paper Size

■ Enlarging or Reducing Copies with Standard Paper Sizes

- 1 Press <Copy Ratio>.

- 2** To reduce, select the copy ratio from **a**, to enlarge, select the copy ratio from **b**, and press <OK>.



! IMPORTANT

Place your original horizontally when enlarging in the following ways with a preset zoom: Placing an original horizontally means setting the original with the longer side sideways.

- A4 → A3
- A5 → A3

■ Enlarging or Reducing Copies by Specifying the Copy Ratio

- 1** Press <Copy Ratio>.

- 2** Specify the copy ratio and press <OK>.



NOTE

- To specify vertical and horizontal ratios individually, press <XY Ratio> and then specify the ratios for each. Depending on the ratio, the image on the printout may be rotated by 90 degrees.

! IMPORTANT

- If you specified <Auto XY Ratio>, select paper in <Select Paper>. If you do not specify a paper size, the copy ratio is automatically set to match the paper loaded in paper drawer 1.

■ Enlarging or Reducing Copies by Specifying Dimensions

1 Press <Copy Ratio>.

2 Press <Set by Length>.

3 Enter the dimensions and press <OK>.

- Press <Original Size> to enter the dimension of the original, and press <Copy Size> to enter the output dimension.
- For both <Original Size> and <Copy Size>, enter either the vertical dimension or horizontal dimension. For example, if you enter the vertical dimension for <Original Size>, enter the vertical dimension for <Copy Size> as well.

NOTE

- To specify the vertical dimension and horizontal dimension individually, press <XY Independent> and specify the dimension for each.
- The machine automatically calculates the correct copy (zoom) ratio based on the values you entered. However, the original image may be cut off slightly depending on the paper size.
- The machine converts the specified sizes into a copy (zoom) ratio (%) using the following formula. (The result is rounded to the closest integer.)
 - Copy (zoom) ratio (%) = (copy (data output) size/original size) x 100

■ Enlarging and Reducing Copies to Fit Paper Size

1 Press <Select Paper>.

2 Select paper and press <OK>.

3 Press <Copy Ratio>.

4 Press <Auto> ► <OK>.

NOTE

- When copying in equal copy ratio to paper that has the same size as the original, the edges of the copied image may be slightly missing. To avoid this, reduce the size of the image by pressing <Copy Ratio> ► <Fit to Page> to obtain the missing edges of the image.
- If you select <Fit to Page>, <Shift> is automatically set to <Center>.
- You cannot scan highly transparent originals, such as transparencies, using the Auto setting for Copy Ratio. Use the Preset Zoom or Zoom by Percentage mode instead.
- If you set <Auto>, you have to select a paper size manually. If you do not select a paper size, the copy ratio is automatically set to match the size of paper loaded in paper drawer 1.

When configuring settings in <Scan and Store>

- You cannot specify <Fit to Page> when storing documents in the Mail Box.

Selecting Copy Paper



If you want to copy free size originals or highly transparent originals, or if you want to copy with paper set in the multi-purpose tray, you need to select paper manually.

1 Press <Select Paper>.

2 Select paper and press <OK>.

- Pressing  enables you to confirm detailed information of the paper selected.

NOTE

When the screen to select the size of the original is displayed

- If <Select Paper> is set to <Auto>, the screen to select the size of the original may be displayed. This is displayed because the size of the original cannot be verified and paper cannot be selected automatically when highly transparent originals, originals with extremely dark base color, or small-size originals are placed. Select the size of the original, or a size close to the original.
- If <Paper Source Auto Selection> is set to <Off> for a particular paper source, you cannot make copies on paper loaded in that paper source when <Select Paper> is set to <Auto>. ▶<Paper Source Auto Selection>(P. 1165)

Also, even if <Paper Source Auto Selection> is set to <On> for a paper source, depending on the paper type, automatic paper selection may not be performed. To use paper loaded in a paper drawer for which automatic paper selection cannot be performed, manually specify the paper drawer.

! IMPORTANT

- Be sure to correctly set the paper type. If the type of paper is not set correctly, it may adversely affect image quality. Moreover, the fixing unit may become dirty, or the paper could jam, and a service repair may be needed.
- Take care when copying an original with an image that extends all the way to the edges. If you copy on the same size paper, the periphery of the original image may be cut off slightly on the copy. For more information on how much may be cut off, see ▶<Hardware Specifications(P. 215) .

2-Sided Copying



You can copy 1-sided originals on both sides of the paper. You can also copy a 2-sided original on both sides of the paper, or on two separate sheets.

- ▶ Copying 1-Sided to 2-Sided
- ▶ Copying 2-Sided to 2-Sided
- ▶ Copying 2-Sided to 1-Sided

NOTE

- Place the original in a proper orientation as shown in the illustrations below.

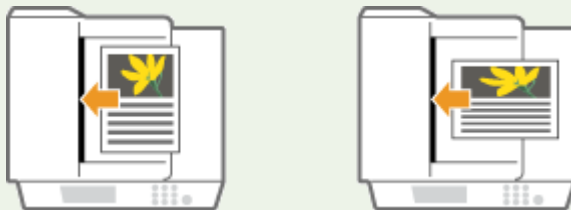

- Originals of heavy or thin paper cannot be placed in the feeder. Place the original on the platen glass. In this case, place the original in a proper orientation as shown in the illustrations below.



- When making 2-sided copies, functions of some settings such as the paper size and type are limited. For more information, see ▶ **Hardware Specifications(P. 215)** .

! IMPORTANT

- Only A4 paper can be used for <Book ▶ 2-Sided>.
- Place your originals on the platen glass when using <Book ▶ 2-Sided>.

■ Copying 1-Sided to 2-Sided

When copying a horizontally long original, place the original in landscape orientation.

1 Press <Options> ▶ <2-Sided>.

2 Press <1-Sided ▶ 2-Sided>.

3 Set <Finishing Copy Format> and press <OK>.

- To change the print orientation, press <Set Details>. Select <Book Type> to make the front and back sides of the printout have the same top-bottom orientation. Select <Calendar Type> to make the front and back sides of the printout have opposite top-bottom orientations.

■ Copying 2-Sided to 2-Sided

1 Press <Options> ▶ <2-Sided>.

2 Press <2-Sided> ▶ 2-Sided>.

3 Set <Original Type> and <Finishing Copy Format>, and press <OK>.

- To specify orientation of the original and change the print orientation, press <Set Details>. Select <Book Type> when the front and back sides of the original have the same top-bottom orientation. Select <Calendar Type> when the front and back sides of the original have opposite top-bottom orientations. You can also set the page orientation of the printout with <Book Type> or <Calendar Type>.

■ Copying 2-Sided to 1-Sided

Place the original in the feeder.

1 Press <Options> ▶ <2-Sided>.

2 Press <2-Sided> ▶ 1-Sided>.

3 Set <Original Type> and press <OK>.

- To specify the orientation of the original, press <Set Details>. Select <Book Type> when the front and back sides of the original have the same top-bottom orientation. Select <Calendar Type> when the front and back sides of the original have opposite top-bottom orientations.

Adjusting Image Quality of Copies



You can adjust density of the entire document. For example, increasing copy density enables you to easily read faint characters written in pencil.

▶ Adjusting the Density of Copies



You can adjust density of the background. This enables you to make clear copies of originals such as newspapers or originals with colored backgrounds.

🔴 Adjusting the Density of the Background of Copies

■ Adjusting the Density of Copies

1 Press **<Options>** ▶ **<Density>**.

2 Adjust density and press **<OK>**.

- Press to decrease density. Press to increase density.

■ Adjusting the Density of the Background of Copies

1 Press **<Options>** ▶ **<Density>**.

2 Press **<Adjust>** in **<Background Density>**.

- To adjust the background automatically, press **<Auto>** and proceed to step 4.

3 Adjust density and press **<OK>**.

- Press **<->** to decrease the density of the entire background. Press **<+>** to increase the density of the entire background.

NOTE

- Depending on the colors of originals, sections other than the background may be affected.
- If you press **<Adjust>** ▶ **<Adjust Each Color>**, you can adjust the background density by color.

4 Press **<OK>**.

NOTE

If the **<BleedReduce>** setting appears

- Setting this to On reduces the amount of bleed-through from the back of the sheet being copied or from the next page during copying.

■ Confirm settings before copying

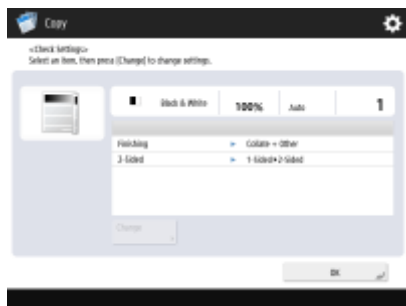

If you press **<Check Settings>**, the list of the specified settings is displayed.



- If you select a setting on the list and press <Change>, you can change the setting. After changing the setting, press <OK>.

5 Press (Start).

⇒ Copying starts.

- To cancel copying, press <Cancel> or  (Stop). ▶ **Cancelling Copying(P. 431)**
- Pressing  or  during copying enables you to adjust density.

IMPORTANT

- You cannot change the density while printing with <Secure Watermark> set.

■ When <Press the [Start] key to scan the next original.> is displayed

Place the next original and press  (Start). After scanning all of the originals, press <Start Copying> to start copying.

NOTE

When multiple sheets are fed at once

- Scanning is stopped and the message is displayed on the screen. Follow the instructions to clear the jam. When you have cleared the jam, the resume job screen is displayed. If the machine mistakenly detects multiple sheet feeding, press <Do Not Detect Multi. Sheet Feed> to resume scanning.
- To set the machine in advance to not notify you of multiple sheet feeding, perform one of the following operations.
 - Each time you copy, press <Options> on the Copy Basic Features screen ▶ select <Detect Feeder Multi Sheet Fd.> to disable the setting.
 - Set <Set Detection of Feeder Multi. Sheet Feed as Default> to <Off> (▶<Set Detection of Feeder Multi. Sheet Feed as Default>(P. 1185)).

TIPS

Reserving a copy

- Scanning can be performed in advance, even if the machine is preparing to print or printing. This function is called "Reserved copy." For example, to perform reserved copy while the printing or waiting screen is displayed, press <Close>, specify the copy settings in the usual manner, and press  (Start).

- You can specify up to 50 jobs to be reserved, including the current job. Interrupt copy jobs are not included in this count.

LINKS

- ▶ **Copy Basic Features Screen(P. 418)**
- ▶ **Specifying Paper Size and Type(P. 64)**
- ▶ **Hardware Specifications(P. 215)**
- ▶ **Loading Paper in the Multi-Purpose Tray(P. 50)**
- ▶ **Optional Equipment(P. 173)**
- ▶ **<Paper Output Settings>(P. 1168)**

Cancelling Copying

961F-06L



You can cancel copying while scanning originals or cancel waiting copy jobs.

■ Canceling Copying While Scanning

The following screen is displayed while scanning originals. Press <Cancel> to cancel copying.



NOTE

- If you press  (Stop) on the control panel while the Copy Basic Features screen is being displayed, the copy job is paused and, the message <<Stop>Select the Copy job you want to cancel.> and the list of copy jobs are displayed. You can select the copy job from the list and cancel the job by pressing <Cancel>.
- If you log in with personal authentication management and log out after pressing  (Stop) on the control panel to display the message <<Stop>Select the Copy job you want to cancel.> and the list of copy jobs, the last job that the logged out user executed is canceled and other jobs are resumed.

■ Canceling Waiting Copy Jobs

- 1 Press  (Status Monitor).
- 2 Press <Copy/Print> ► <Job Status>.
- 3 Select <Copy> from the drop-down list and display waiting copy jobs.

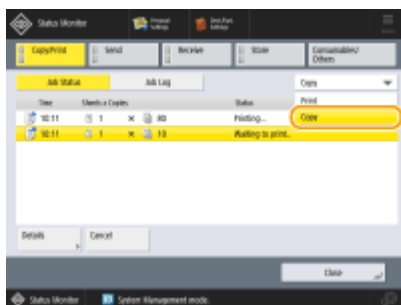

4 Select the copy job to cancel and press <Cancel>.

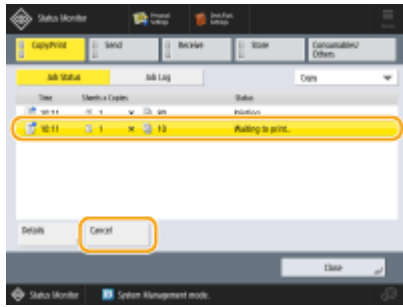

NOTE

- If you press <Details>, detailed information such as the number of copies and the Department ID is displayed.

5 Press <Yes>.

⇒ Copying stops.

6 Press <Close>.

NOTE

- If you press  (Stop) on the control panel when copy jobs are waiting, all the copy jobs are paused and then the message <<Stop>Select the Copy job you want to cancel.> and the list of the copy jobs are displayed. You can select a copy job from the list and cancel the copy job by pressing <Cancel>. If you want to resume copying, press <Resume Copying>.

Enhancing and Adjusting Copy Quality

961F-06R

You can enhance the copy quality by making fine adjustments such as adjusting sharpness and erasing unnecessary dark borders. In addition, you can change the visual image of the copy result by inverting colors.



▶ **Selecting the Type of Original for Copying(P. 434)**

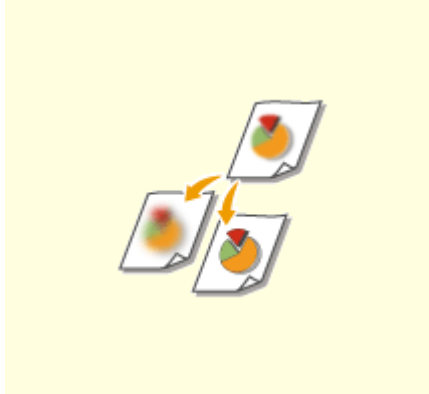

▶ **Adjusting Sharpness for Copying (Sharpness)(P. 436)**

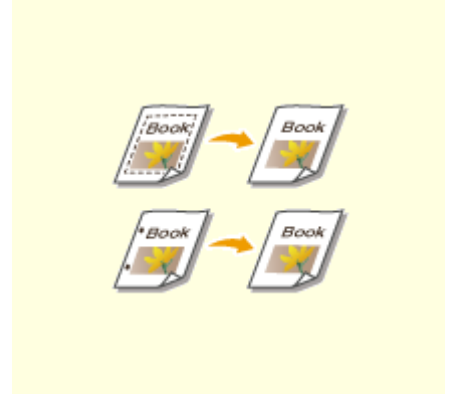

▶ **Erasing Dark Borders When Copying (Erase Frame)(P. 437)**

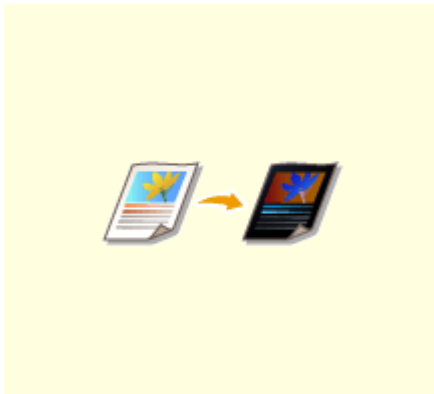

▶ **Inverting Colors (Nega/Posi) (P. 439)**

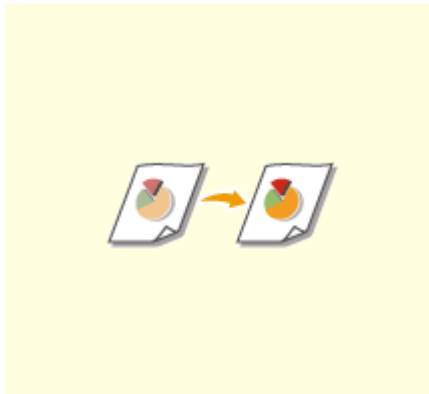

▶ **Adjusting the Color(P. 440)**

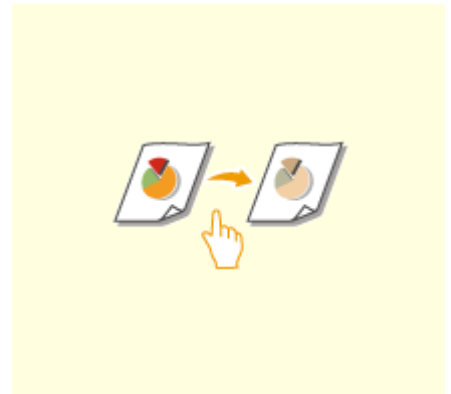

▶ **One Touch Color Mode(P. 443)**

Selecting the Type of Original for Copying

961F-06S



You can select the optimal image quality for the copy depending on the type of original such as originals with only characters or magazines with photographs.

1 Place the original. **▶** [Placing Originals\(P. 39\)](#)

2 Press <Copy>. **▶** [<Home> Screen\(P. 332\)](#)

3 Press <Options> on the Copy Basic Features screen. **▶** [Copy Basic Features Screen\(P. 418\)](#)

4 Press <Original Type>.

5 Select the type of original.

- For information on types of original, see the help screen displayed when you press  at the top right of the screen.
- To adjust the text/photo processing priority level, press <Adjust Level> **▶** select <Text Priority> or <Photo Priority>.

NOTE:

- For thin black-and-white originals such as newspapers, it is recommended that you specify <Options> **▶** <Density> **▶** <Background Density> **▶** <Auto>. **▶** [Basic Copy Operations\(P. 420\)](#)

If the <BleedReduce> setting appears

- Setting this to On reduces the amount of bleed-through from the back of the sheet being copied or from the next page during copying.

6 Press <OK> **▶** <Close>.

NOTE:

- If you select <Photo Printout> and copy, highlights may be blown out (areas with stronger brightness may become bright white).
In this case, adjust the background density so that blow out does not occur.
Press <Options> **▶** <Density> **▶** <Adjust> for <Background Density> **▶** <+>.

7 Press  (Start).

⇒ Copying starts.

Adjusting Sharpness for Copying (Sharpness)

961F-06U



You can copy the image with clear contours and lines by increasing the sharpness, or soften the copied image by decreasing the sharpness. Use this function when you want to sharpen blurred text and diagrams, or to reduce moire (a striped, wavy pattern) to smooth the finished image.

- 1 Place the original. ▶ **Placing Originals(P. 39)**
- 2 Press <Copy>. ▶ **<Home> Screen(P. 332)**
- 3 Press <Options> on the Copy Basic Features screen. ▶ **Copy Basic Features Screen(P. 418)**
- 4 Press <Sharpness>.
- 5 Adjust sharpness and press <OK>.



- To sharpen blurred text, adjust the control in <Text> to <High>.
- To reduce moire when copying originals that contain printed photos, such as magazines or pamphlets, adjust the control in <Photo/Image> to <Low>.

- 6 Press <Close>.
- 7 Press  (Start).

⇒ Copying starts.

Erasing Dark Borders When Copying (Erase Frame)

961F-06W



When copying originals that are smaller than the output paper size, frame lines of the originals may appear in the copied image. When copying thick books, dark borders may appear. <Erase Frame> enables you to erase these frame lines and dark borders. You can also set the machine to not copy punch holes in the originals.

! IMPORTANT

- Place originals with punch holes on the platen glass. Placing them in the feeder may result in damage.

- 1 Place the original. ▶ **Placing Originals(P. 39)**
- 2 Press <Copy>. ▶ **<Home> Screen(P. 332)**
- 3 Press <Options> on the Copy Basic Features screen. ▶ **Copy Basic Features Screen(P. 418)**
- 4 Press <Erase Frame>.
- 5 Specify erasing type and width.

■ Erasing the frames in copies of documents

- 1 Press <Erase Original Frame> and set <Original Size>.



- If the size displayed in <Original Size> is different from the size of the original you set, press <Change> to select the size.

- 2 Enter the width of the frame to erase.

■ Erasing the dark borders in copies of books

You can erase the dark borders both in the center and contour lines that appear when you copy facing pages in a book.

- 1 Press <Erase Book Frame> and confirm <Original Size>.



- If the size displayed in <Original Size> is different from the size of the book you set, press <Change> to select the size.

- 2 Press <Center> or <Sides>, and enter each erasing width.

■ Erasing punch holes in copies of documents

- 1 Press <Erase Binding> and select punch hole location.



- 2 Enter erasing width.

NOTE

- If you want to adjust the width for each border independently, press <Erase Original Frame> or <Erase Book Frame>, and then press <Adjust Independently> to enter the erasing widths.

- 6 Press <OK> ► <Close>.

- 7 Press  (Start).

⇒ Copying starts.

Inverting Colors (Nega/Posi)

961F-06X



By inverting the hue or gradation of the entire original, you can make white portions of the original appear black on the copy, and black portions appear white. The printed image will look like a film negative.

- 1 Place the original.** ▶ **Placing Originals(P. 39)**
- 2 Press <Copy>.** ▶ **<Home> Screen(P. 332)**
- 3 Press <Options> on the Copy Basic Features screen.** ▶ **Copy Basic Features Screen(P. 418)**
- 4 Press <Nega/Posi>.**
- 5 Press <Close>.**
- 6 Press  (Start).**

▣ Copying starts.

Adjusting the Color

961F-06Y



Adjust the density of yellow, magenta, cyan, and black separately.

- 1 Place the original. ▶Placing Originals(P. 39)
- 2 Press <Copy>. ▶<Home> Screen(P. 332)
- 3 Press <Options> on the Copy Basic Features screen. ▶Copy Basic Features Screen(P. 418)
- 4 Press <Color Balance>.
- 5 Press <-> or <+> for each color to adjust the color balance.

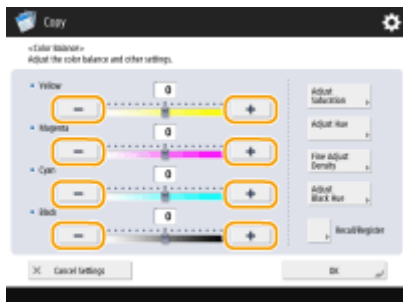

(Items shown on the screen may differ depending on your model and options.)

6 Perform other adjustment.



a <Adjust Saturation>

To set the saturation for all colors, use the <Low> or <High> button for <All Colors>. To set each color separately, use the <Low> or <High> button for each color. When adjustment is complete, press <OK>.



b <Adjust Hue>

To set the hue for all colors, use the ← or → button for <All Colors>. To set each color separately, use the buttons to the left and right of each color. When adjustment is complete, press <OK>.



c <Fine Adjust Density>

Select a color and adjust its density level by its density area using the <-> or <+> button. When adjustment is complete, press <OK>.

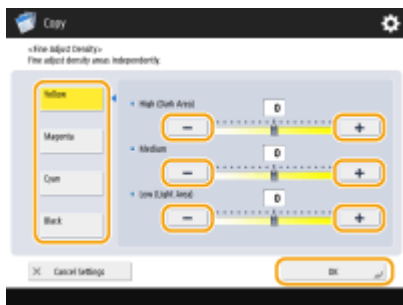

d <Adjust Black Hue>

Adjust towards the side of <Lighter> to prevent the image from becoming over-darkened. Adjust towards the side of <Darker> if text and images are too light. When adjustment is complete, press <OK>.

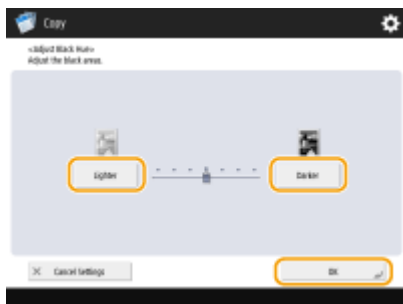

7 Press <OK> ► <Close>.

8 Press  (Start).

⇒ Copying starts.

TIPS

- You can register up to four settings after adjustment. After adjusting the color, press <Recall/Register> ► select a button from <C1> to <C4> ► press <Register> ► <Yes> ► <OK>.

NOTE

- To recall registered settings, press <Recall/Register>, select a button, and press <OK>.
- You can change the button names of <C1> to <C4>. Select the button to change, press <Rename>, and enter a new name.
- To delete registered settings, select the button ► press <Delete> ► <Yes>.

One Touch Color Mode

961F-070



You can intuitively select the image quality with a single button, such as having subtle colors or having a retro finish like an old photograph.

- 1** Place the original. ▶ **Placing Originals(P. 39)**
- 2** Press <Copy>. ▶ **<Home> Screen(P. 332)**
- 3** Press <Options> on the Copy Basic Features screen. ▶ **Copy Basic Features Screen(P. 418)**
- 4** Press <Adjust OneTouch Color>.
- 5** Select the desired image quality.



Example adjustment:

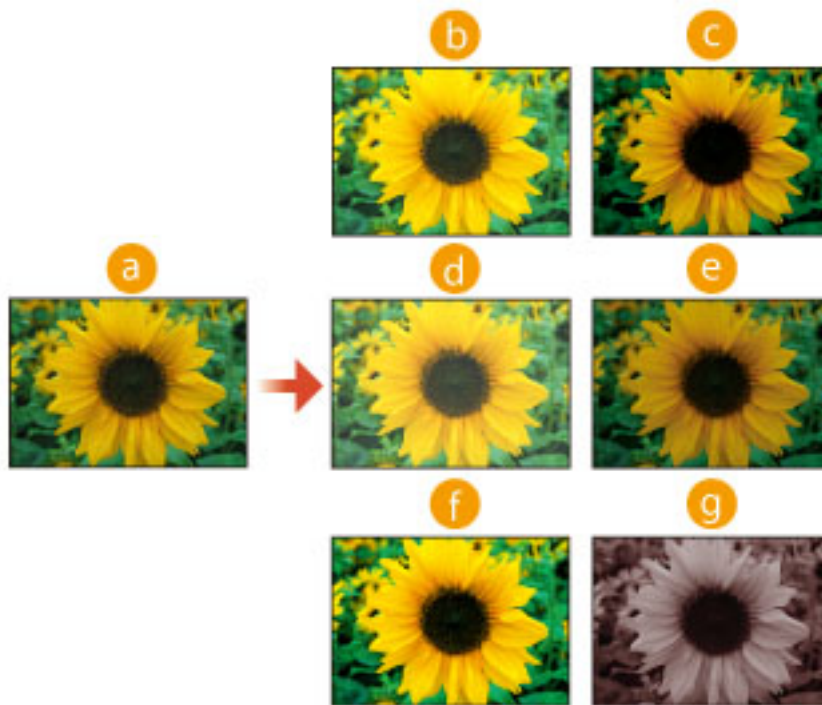

- a** Original
- b** Vivid Colors
- c** Tranquil Colors
- d** Lighten Image
- e** Darken Image
- f** Highlight Reproduction
- g** Sepia Tone

- If you select <Highlight Reproduction>, the image quality is adjusted so that highlights are not blown out.
- You can select multiple types of image quality at the same time. However, <Vivid Colors> and <Tranquil Colors> cannot be selected at the same time, and <Lighten Image>, <Darken Image>, and <Highlight Reproduction> cannot be selected at the same time.

6 Press <OK> ► <Close>.

7 Press  (Start).

▣ Copying starts.

NOTE

- The settings in <Options> ► <Color Balance> automatically change according to the image quality you select.
- If you select <Sepia Tone>, <Single Color (Sepia Tone) > is displayed in <Select Color> on the Basic Features screen.
- If you are printing a document in the Mail Box with <Access Stored Files>, you cannot specify <Vivid Colors> and <Tranquil Colors>.

Copying Efficiently

961F-071

You can save paper by copying several originals onto one sheet or checking the copy result before making copies. You can also enhance efficiency by setting different sized originals to copy them together, or combining originals scanned with different settings to copy them together.



▶ Copying Multiple Originals onto One Sheet (N on 1)(P. 446)

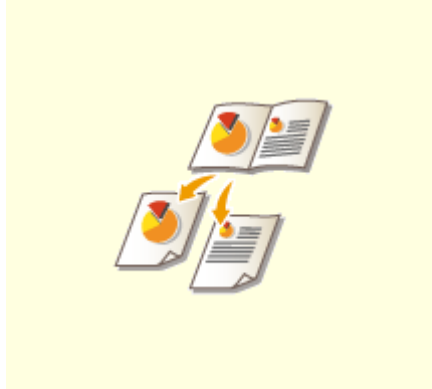

▶ Copying a Facing Page Original as Two Separate Pages(P. 448)

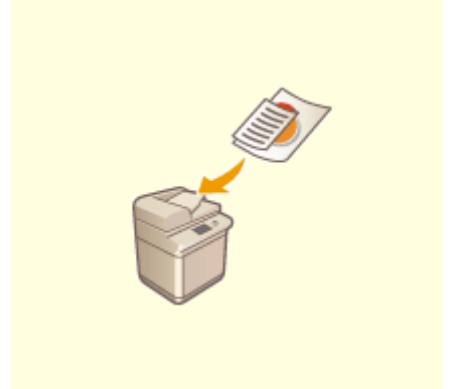

▶ Copying Different Size Originals Together (Different Size Originals) (P. 451)



▶ Copying Separately Scanned Originals Together (Job Build) (P. 453)

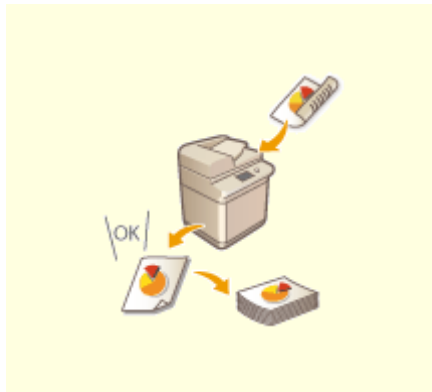

▶ Checking the Copy Results(P. 455)



▶ Copying Immediately by Interrupting Other Jobs(P. 458)

Copying Multiple Originals onto One Sheet (N on 1)

961F-072



You can copy several pages of originals onto a single sheet. This function enables you to copy with a smaller amount of paper than the original number of pages.

- 1 Place the original. ▶ **Placing Originals(P. 39)**
- 2 Press <Copy>. ▶ **<Home> Screen(P. 332)**
- 3 Press <Options> on the Copy Basic Features screen. ▶ **Copy Basic Features Screen(P. 418)**
- 4 Press <N on 1>.
- 5 Select the way to arrange pages and select the original size and paper size for copying.

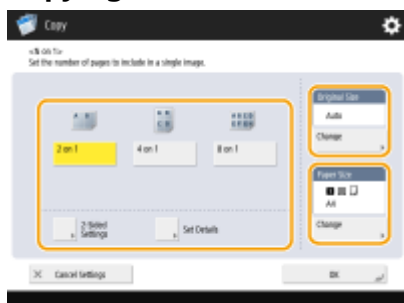

- Select how many pages to be arranged onto a single sheet of paper. You can change the arrangement order as well.
- To make 2-sided copies, or to scan 2-sided originals to make 1-sided copies, press <2-Sided Settings>. For more information on the setting, see "2-Sided Copying" in step 4 of ▶ **Basic Copy Operations(P. 420)** .
- Pressing <Change> in <Original Size> enables you to select the size of original and pressing <Change> in <Paper Size> enables you to select the paper size.

- 6 Press <OK> ▶ <Close>.

- 7 Press  (Start).

▢▢▢▢ Copying starts.

 **IMPORTANT**

- Originals must all be the same size.

NOTE

- If you set <N on 1>, <Shift> is automatically set to <Center>.

Copying a Facing Page Original as Two Separate Pages

961F-073



You can copy an original with two facing pages such as books and magazines into separate pages, dividing the left and right pages. You can make 2-sided copies as well by copying the right page onto the front side and the left page onto the back side.

▶ Copying a Facing Page Original onto Two Sheets of Paper(P. 448)

▶ Copying a Facing Page Original onto Both Sides of One Sheet of Paper(P. 449)

NOTE

- When scanning facing pages of a book or bound original, place the original on the platen glass. Place it face down with its corner aligned with the top-left corner of the platen glass, as shown below.



Copying a Facing Page Original onto Two Sheets of Paper

- 1 Place the original.** ▶ Placing Originals(P. 39)
- 2 Press <Copy>.** ▶ <Home> Screen(P. 332)
- 3 Press <Options> on the Copy Basic Features screen.** ▶ Copy Basic Features Screen(P. 418)
- 4 Press <Book ▶ 2 Pages>.**
- 5 Press ▶ <Close>.**
- 6 Press  (Start).**

⇒ Copying starts.

Copying a Facing Page Original onto Both Sides of One Sheet of Paper

- 1 Place the original. ▶ **Placing Originals(P. 39)**
- 2 Press <Copy>. ▶ **<Home> Screen(P. 332)**
- 3 Press <Options> on the Copy Basic Features screen. ▶ **Copy Basic Features Screen(P. 418)** .
- 4 Press <2-Sided> ▶ **<Book ▶ 2-Sided>**.
- 5 Check and change the setting according to your original type.

- If you want to change the setting, press <Set Details>.



a <Book ▶ 2-Sided Type>

If you select <Left/Right ▶ 2-Sided>, the left and right pages of the facing page original are copied separately onto both sides of one sheet of paper.



If you select <Front/Back ▶ 2-Sided>, the front side and back side of one page of the facing page original are copied onto both sides of one sheet of paper.



- 6 Press <OK> ▶ **<Close>**.

- 7 Press  (Start).

▢▢▢▢ Scanning starts.

- To scan the next page, place the original and press  (Start). After scanning all of the originals, proceed to step 7.

8 Press <Start Copying>.

▣▣▣▣ Copying starts.

Copying Different Size Originals Together (Different Size Originals)

961F-074



You can place different size originals in the feeder and scan them at one time. You can eliminate the need to select paper and place the original again.

! IMPORTANT

- You are limited to certain combinations of original sizes for scanning. Scanning with an improper combination may cause damage to the originals or paper jams. [▶Hardware Specifications\(P. 215\)](#)
- Do not place the originals together that are of different weights or paper types, as this may cause damage to the originals or paper jams.
- You cannot combine all of the following modes at the same time.
 - <Different Size Originals>
 - <Shift>
 - <Select Paper>:<Auto>

- 1 Place the originals in the feeder.** [▶Placing Originals\(P. 39\)](#)
- 2 Press <Copy>.** [▶<Home> Screen\(P. 332\)](#)
- 3 Press <Options> on the Copy Basic Features screen.** [▶Copy Basic Features Screen\(P. 418\)](#)
- 4 Press <Different Size Originals>.**
- 5 Press <Close>.**
- 6 Press  (Start).**

⇒ Copying starts.

NOTE

- If <Different Size Originals> is set for copying, each original is output with the optimal size of paper. If you want to copy all originals with the same size of paper or copy 1-sided originals of different sizes to both

sides, specify the paper with <Select Paper>. If you do not specify <Select Paper>, the output paper cannot be stapled properly.

▶ **Basic Copy Operations(P. 420)**

▶ **Optional Equipment(P. 173)**

Copying Separately Scanned Originals Together (Job Build)

961F-075



Even if you have too many originals to be placed in the feeder at once, you can scan the originals separately and copy them as a batch of documents. Originals scanned with both the feeder and the platen glass also can be copied at one time.

- 1 Place the original.** ▶ **Placing Originals(P. 39)**
- 2 Press <Copy>.** ▶ **<Home> Screen(P. 332)**
- 3 Press <Options> on the Copy Basic Features screen.** ▶ **Copy Basic Features Screen(P. 418)**
- 4 Press <Job Build> ▶ <Close>.**
- 5 Press  (Start) to scan the originals.**

⇒ When scanning is complete, the screen appears prompting you to scan the next original.

- 6 Place the next original and press  (Start) to scan the original.**

- Repeat this step until you finish scanning all of the originals.
- To change the scan settings, press <Change Settings>.

NOTE

- The following functions can be used in <Change Settings>: You need to set the necessary scan settings in advance, since you cannot change the other functions during the Job Build mode.
 - <Select Color>
 - <Copy Ratio>
 - <2-Sided Original>
 - <Density>
 - <Original Type>
- If you specify the <N on 1 > mode together with the Job Build mode, you cannot change <Select Color>, <Copy Ratio>, and <Density> in <Change Settings>.

- 7 Press <Start Copying>.**

⇒ Copying starts.

Checking the Copy Results

961F-076



Prior to a large amount of copying, you can check the copy result by printing a copy sample. You can also check scanned images by copying page by page when you scan originals. Confirming the copy results beforehand enables you to eliminate output mistakes.

▶ **Checking the Copy Result by Making a Copy (Copy Sample)(P. 455)**

▶ **Checking Scanned Images Page by Page (Print & Check)(P. 456)**

NOTE

- <Copy Sample> appears only if you set to make multiple copies and one of the following settings at the same time.
 - Collate (Page Order)
 - Offset
 - Rotate 90 Degrees
 - Staple + Collate
 - Booklet
 - Front Cover
 - Insert Sheets
 - Transparency Cover Sheets

Checking the Copy Result by Making a Copy (Copy Sample)

When you specified multiple numbers of copies, you can first make a copy of your whole original to check the result and then start making the rest of the copies. You can also copy only specific pages of your original.

- 1 Place the originals in the feeder.** ▶ **Placing Originals(P. 39)**
- 2 Press <Copy>.** ▶ **<Home> Screen(P. 332)**
- 3 Enter the number of copies, and specify the copy settings according to your purpose and objective.** ▶ **Basic Copy Operations(P. 420)**
- 4 Press <Copy Sample> on the Copy Basic Features screen.** ▶ **Copy Basic Features Screen(P. 418)**

5 Select pages for the copy sample and press <OK>.



- If you want to copy all of the pages, select <All Pages>.
- To copy specific pages, select <Specified Pages>. Enter the pages by pressing <Start Page> or <End Page>.

NOTE

If you select <All Pages>

- If you select <All Pages>, the machine's counter counts the sample set as a copy.

If you select <Specified Pages>

- Settings such as finishing and booklet are not performed.
- Specify the pages based on the output page numbers. For example, if the number of pages of document is 10 and you copy with the 2 on 1 setting (▶ **Copying Multiple Originals onto One Sheet (N on 1) (P. 446)**), the number of finished pages becomes 5. If you want to copy the seventh to tenth pages of the original, specify the fourth page for <Start Page> and the fifth page for <End Page>.

6 Press (Start) to scan the originals, and press <Start Copying>.

⇒ The copy sample is printed. Check the result.

■ If there is no problem with the copy result

Press <Start Printing> to print the number of copies you specified. If you selected <All Pages> in step 5, the number of copies minus one is printed. If you select <Specified Pages> in step 5, the total number of copies is printed.

■ If you want to change settings

Press <Change Settings> to change the settings. <Copy Sample> is displayed after the settings are changed. Copy a sample again.

Checking Scanned Images Page by Page (Print & Check)

When scanning an original, you can check the scanned images by copying page by page and copy the whole original after scanning all of the pages.

1 Place the original on the platen glass. ▶ **Placing Originals(P. 39)**

2 Press <Copy>. ▶ **<Home> Screen(P. 332)**

3 Specify the copy settings as necessary. ▶ **Basic Copy Operations(P. 420)**

4 Press <Options> on the Copy Basic Features screen.  Copy Basic Features Screen(P. 418)

5 Press <Print & Check>  <Close>.

6 Press  (Start).

⇒ The check print is output. Check the result.

■ If there is no problem with the copy result

To scan the next original, place the original and press  (Start). After scanning all of the pages, press <Start Copying> to start copying.

■ If you want to scan the original again

To delete the scanned document and scan again, select the <Re-Scan> check box and press  (Start).

■ If you want to change settings

Press <Change Settings> and change the settings. After changing the settings, press  (Start) to output the check print.

NOTE

- When <Print & Check> is specified, the output becomes 1-sided copies. If you want to make 2-sided copies, press <Start Copying>.

Copying Immediately by Interrupting Other Jobs

961F-077



You can copy immediately even while another operation is being performed. This is convenient for cases in which you only want to copy several pages urgently, but another person's output will not finish soon.

- 1 Place the original.** ▶ **Placing Originals(P. 39)**
- 2 Press <Copy>.** ▶ **<Home> Screen(P. 332)**
- 3 Press <Interrupt> on the Copy Basic Features screen.** ▶ **Copy Basic Features Screen(P. 418)**
- 4 Specify the copy settings as necessary.** ▶ **Basic Copy Operations(P. 420)**
- 5 Press  (Start).**

⇒ The previous job is paused and interrupt copying starts.



- To cancel interrupt copying, press <Interrupt> again before pressing  (Start).

NOTE

- When interrupt copying finishes, the previous job restarts automatically.
- During interrupt copying, you cannot perform another interrupt copying. After the current interrupt copying finishes, perform the next interrupt copying.
- Even when the number of reserved copy jobs has reached its limit, interrupt copying can still be performed.

TIPS

You can interrupt jobs with a reserved copy job (▶ **Basic Copy Operations(P. 420)**).

- To interrupt the current job and perform a reserved copy job, press  (Status Monitor) ▶ <Copy/Print> ▶ <Job Status> ▶ Select the document to copy ▶ <Interrupt/Priority Print> ▶ <Interrupt and Print>.
- To perform a reserved copy job right after the current job finishes, press  (Status Monitor) ▶ <Copy/Print> ▶ <Job Status> ▶ Select the document to copy with the first priority ▶ <Interrupt/Priority Print> ▶ <Priority Print>.

Functions Useful for Making and Managing Material

961F-078

You can attach page numbers and dates when copying. In addition, attaching serial numbers or "CONFIDENTIAL" to important material calls attention to the handling of the material.



▶ **Finishing by Collating/
Grouping(P. 460)**



▶ **Finishing with the
Stapler(P. 462)**



▶ **Other Finishing
Functions(P. 464)**





▶ **Attaching Numbers and Symbols
to Copies(P. 465)**

Finishing by Collating/Grouping

961F-079



When copying two copies or more from the feeder, you can select collating or grouping for the order of printouts. Select "Collate" to print in sequential page order. Select "Group" to print bundles of each page, as in 10 sheets for the first page, 10 sheets for the second page, and so forth.

- 1 Place the original. ▶ **Placing Originals(P. 39)**
- 2 Press <Copy>. ▶ **<Home> Screen(P. 332)**
- 3 Press <Options> on the Copy Basic Features screen. ▶ **Copy Basic Features Screen(P. 418)**
- 4 Press <Finishing>.
- 5 Press <Collate (Page Order)> or <Group (Same Pages)>.
- 6 Set <Offset> as necessary.
 - If you do not want to use offset (a function to shift the paper output position), press .
 - If you selected <Collate (Page Order)>, specify how many copies to be printed in each position using the numeric keys.
- 7 Press <OK> ▶ <Close>.
- 8 Press  (Start).

⇒ Copying starts.

NOTE

- Depending on finishing functions, the installation of optional devices is needed. ▶ **Optional Equipment(P. 173)**
- Depending on the paper type, you cannot use finishing functions. ▶ **Hardware Specifications(P. 215)**

When placing an original on the platen glass

- Pressing <Options> ▶ <Job Build> on the Copy Basic Features screen enables you to use the Collate/Group function even if the original is placed on the platen glass.

Insert a job separator between each page during a group output

- If you select <Group (Same Pages)>, you can insert a job separator between each group. For more information, see <Job Separator Between Groups>. ▶<Job Separator Between Groups>(P. 1200)

When configuring settings in <Access Stored Files>

- The finishing function can be used only when you are printing a PDF/XPS file or a file stored in the Mail Box.

Finishing with the Stapler



You can bind each copy with the stapler after a collate or group output.

- 1 Place the original. ▶ **Placing Originals(P. 39)**
- 2 Press <Copy>. ▶ **<Home> Screen(P. 332)**
- 3 Press <Options> on the Copy Basic Features screen. ▶ **Copy Basic Features Screen(P. 418)**
- 4 Press <Finishing>.
- 5 Press <Staple + Collate> or <Staple + Group> ▶ <Next>.

NOTE

- <Staple> is displayed only when you are printing a PDF file with <Access Stored Files>.

- 6 Select how to staple.



- To staple in one location in the corner of the page, select <Corner> for the staple position.



- To staple in two locations in the side of the page, select <Double> for the staple position.



- To staple in the section where the paper is folded in half, select <Saddle Stitch>. Depending on the option, you can attach a cover or change the folding position. When trimming the edges of the output sheets, you can adjust the trimming position.



- Depending on the option, you can bind the paper by crimping without using staples. Select <Staple-Free> and specify the binding position. This is convenient for when you want to save staples or temporarily bind the paper, as you can easily tear off the paper by rubbing the crimped part.

7 Press <OK> ► <Close>.

8 Press  (Start).

⇒ Copying starts.

NOTE

- Depending on finishing functions, the installation of optional devices is needed. ▶ **Optional Equipment(P. 173)**
- Depending on the paper type, you cannot use finishing functions. ▶ **Hardware Specifications(P. 215)**
- You can specify the procedure to perform when there are too many sheets to staple at once. ▶ **<Action When Too Many Sheets to Staple>(P. 1170)**
- <Saddle Stitch> can be set only if 2-Sided Copying is set.

When configuring settings in <Access Stored Files>

- The finishing function can be used only when you are printing a PDF/XPS file or a file stored in the Mail Box.

Other Finishing Functions

961F-07C



Installing options enables you to use other finishing functions. Note that the available functions may differ depending on your model and the installed options.

- ▶ **Optional Equipment(P. 173)**
- ▶ **Checking the Options Installed on This Machine(P. 1038)**

Rotate 90 Degrees

You can output each set of paper in alternating portrait and landscape orientation.



Hole Punch

You can make punch holes for filing.



Saddle Fold

Using the booklet finisher, you can fold the output sheets in half. You can specify how many sheets to fold together and which page to start printing on.



NOTE

- Depending on the paper type, you cannot use finishing functions. ▶ **Hardware Specifications(P. 215)**

When configuring settings in <Access Stored Files>

- The finishing function can be used only when you are printing a PDF/XPS file or a file stored in the Mail Box.

Attaching Numbers and Symbols to Copies

961F-07E



You can attach page numbers, management numbers, or dates, etc. when copying. You can also attach stamps which read "Confidential," etc. This allows for easier management in situations such as when you distribute multiple copies of documents.

- 1 Place the original. ▶ **Placing Originals(P. 39)**
- 2 Press <Copy>. ▶ **<Home> Screen(P. 332)**
- 3 Press <Options> on the Copy Basic Features screen. ▶ **Copy Basic Features Screen(P. 418)**
- 4 Press <Page Numbering>, <Copy Set Numbering>, <Watermark>, or <Print Date>.
- 5 Select the printing format.

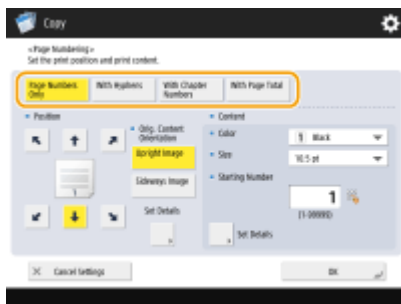

- There are no settings to select if you specified <Copy Set Numbering>, <Watermark>, or <Print Date> in step 4. Proceed to step 6.

- 6 Select the printing position.

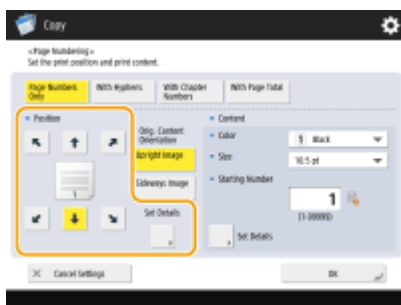

NOTE

Finely adjust the page number position

- In <Set Details>, you can adjust the printing position and change the print position when performing two-sided printing.
- Enter a positive (+) value for X to move the printing position to the left, or a minus (-) value for Y to move the printing position upward.
- Press <Set Details>, specify each setting, and press <OK>.

7 Select the orientation of the placed original.



- As shown in the illustrations below, if the original is placed in the portrait orientation when facing you, select <Upright Image>, if placed in the landscape orientation, select <Sideways Image>.



<Upright Image>

<Sideways Image>

8 Specify the content to print.



9 Press <OK> ► <Close>.

10 Press (Start).

⇒ Copying starts.

NOTE

- Numbers and symbols are not printed on covers (► **Adding a Cover and Back Cover(P. 475)**) or insert sheets (► **Inserting Sheets and Chapter Pages (Insert Sheets)(P. 485)**).
- Copy set numbers are printed on all copied pages.

- Copy set numbers can be printed together with dates or text. ▶Copy Set Numbering Option Settings>(P. 1174)
- The text for <Page Numbering> and <Watermark> can also be selected from the text which has been registered in ▶Register Characters for Page Numbering/Watermark>(P. 1174) .
- If you set any two of <Page Numbering>, <Watermark>, <Print Date>, or <Copy Set Numbering> to print in the same position, a message asking whether to print with these settings appears when you press  (Start).
- If you select <With Chapter Numbers> in combination with <Insert Sheets>, the chapter numbers are counted at the following times:
 - After each chapter page is inserted
 - After each sheet insertion is inserted
- If you set <Copy Set Numbering Option Settings> to <On>, the settings you can specify change as follows. ▶Copy Set Numbering Option Settings>(P. 1174)
 - You can no longer select <Full Surface> and <Numbers in 5 Locations> for print positions in the Copy Set Numbering mode.
 - The number sizes of the Copy Set Numbering mode become <10.5 pt>, <12.0 pt>, and <14.0 pt>.

LINKS

▶Print Settings>(P. 1172)

Making Booklets

961F-07F

You can make easy-to-read professional-looking booklets with binding margins and covers. In addition, you can efficiently configure the settings for making booklets such as page layout, 2-sided copying, and adding covers.

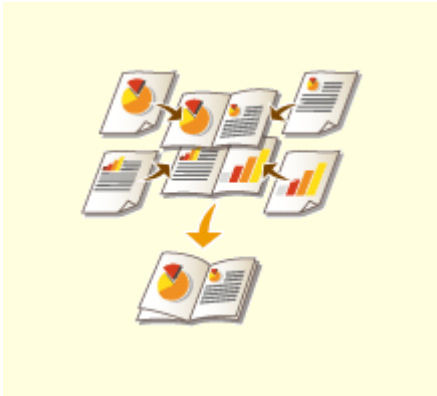

▶ **Making Booklets (Booklet Copying)(P. 469)**

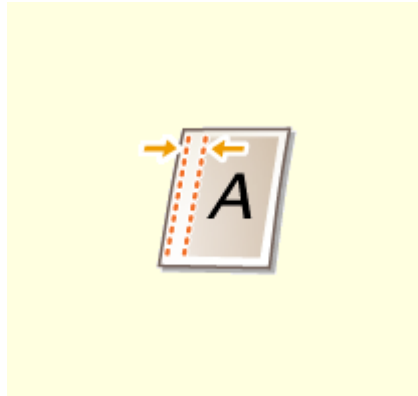

▶ **Setting Binding Margins(P. 473)**

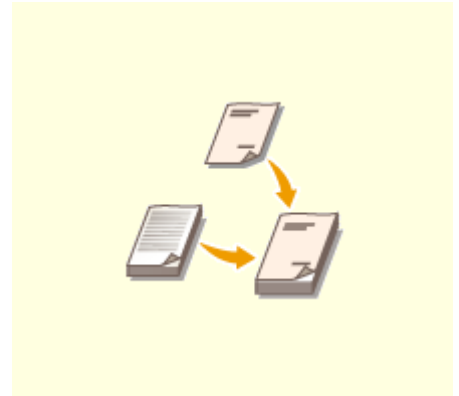

▶ **Adding a Cover and Back Cover(P. 475)**

Making Booklets (Booklet Copying)

961F-07H



You can set the print layout so that the printouts turn into a booklet when they are folded in half. Using options enables you to automatically process operations such as folding in half and stapling in the crease (Saddle Stitch).

- ▶ **Optional Equipment(P. 173)**
- ▶ **Checking the Options Installed on This Machine(P. 1038)**

! IMPORTANT

Paper

There are restrictions for paper that can be used with this function. Take note of the following. For information on restrictions on paper for each option, see ▶ **Hardware Specifications(P. 215)** .

- Depending on paper size and type, booklet copying may not be available.
- The number of sheets to be printed using saddle stitch is limited.
- Paper that can be used for the content and cover pages is limited.

1 Place the original. ▶ **Placing Originals(P. 39)**

- When copying a vertically long original, place the original in portrait orientation.



2 Press <Copy>. ▶ **<Home> Screen(P. 332)**

3 Press <Options> on the Copy Basic Features screen. ▶ **Copy Basic Features Screen(P. 418)**

4 Press <Booklet>.

5 Press <Booklet Scan>.

- When you perform booklet copying with 2-sided originals, press <2-Sided Original> and select <Book Type> or <Calendar Type> as necessary.

NOTE

- When you copy an original that is already in booklet format, such as one printed from the machine using booklet copying, press <Do Not Booklet Scan>.

If the <N on 1> setting appears

- This allows you to place multiple pages from the original onto a single page in the booklet. Press <N on 1> and specify the number of pages to place on the single page and the page order.
- Even after you set <N on 1>, you still can set <Page Numbering> in <Options> to print page numbers. However, page numbers cannot be printed on all pages of the original document. Page numbers are printed on each page of the booklet.

6 Select how to bind the booklet.

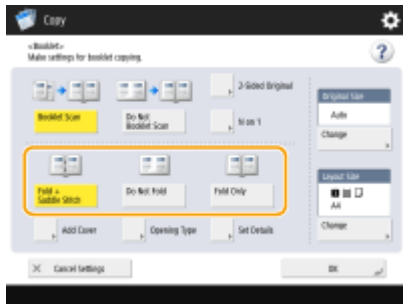

7 Set the original size and the output size.



- Press <Change> in <Original Size> and select the size of original. If you select <Auto>, the booklet size is automatically selected according to the size of original.
- Press <Change> in <Layout Size> and select the paper size for the booklet.

NOTE

- To make the booklet in the same print size as the original print size, select the output size of the facing pages. If you specify the same size in <Original Size> and <Layout Size>, the print size on the booklet is automatically reduced.

8 <Add Cover> ▶ Specify the cover settings and press <OK>.

- Select whether to copy the original onto the cover and the back cover.
- Press <Change> in <Paper Size> and select the paper size of the cover and the paper source.

NOTE

- Make sure to use the same size paper for the cover and content pages.
- If you use heavy paper for the cover, you may be unable to print even if you select <Print>, depending on the thickness of the paper. For more information, see **Available Paper(P. 224)** .

9 <Opening Type> ▶ Select the opening type and press <OK>.

10 Press <Set Details> and specify detailed settings as necessary.

■When the number of pages is large

When the number of pages is large and the booklet cannot be stapled together, you can divide it into volumes so that they can be stapled.

- 1 Press <Divided Booklet>.
- 2 Enter the number of pages per volume.
- 3 <OK> ► Press <OK>.

■When the inner pages protrude after being folded in half

If a stack of paper is folded in half, the inner pages protrude as the number of pages increases. You can correct this paper shift. Optional products are required to use this function.

Without correction



With correction



The red sections are shifting The red sections are aligned

- 1 Press <Creep Correction>.
- 2 Press <Auto> or <Manual>.
 - If you select <Manual>, enter the value for correction with ▼ / ▲ .
- 3 <OK> ► Press <OK>.

NOTE

- If <Trim> is displayed, you can trim the protruding part to align the edge of the booklet.



- If you can select <Adjust Trim Width>, you can adjust the trimming position.

■Adjusting the saddle stitch position

You can shift the folding position and stapling position at the same time.



- 1 Press <Change Fold/Stitch Position>.

- 2 Select the paper for copying and enter the saddle stitch position.
- 3 Press <OK> ► <Close> ► <OK>.

■ Adjusting the folding position of the paper

When you selected <Fold Only> in step 6, you can shift the folding position from the center.



- 1 Press <Adjust Fold Position>.
- 2 Select the paper for copying and enter the folding position of the paper.
- 3 Press <OK> ► <Close> ► <OK>.

11 Press <OK> ► <Close>.

12 Press  (Start).

► Copying starts.

NOTE

When configuring settings in <Access Stored Files>

- The booklet mode can be used only when you are printing a PDF/XPS file or a file stored in the Mail Box.
- You cannot set <2-Sided Original>, <2-Sided Original>, and <Original Size> for a file stored in the Mail Box.
- When a PDF/XPS file is selected, you can only set the Fold mode and the Saddle Stitch mode.

LINKS

- ◉ [Adding a Cover and Back Cover\(P. 475\)](#)
- ◉ [Hardware Specifications\(P. 215\)](#)

Setting Binding Margins

961F-07J



You can make binding margins for stapling or punching holes. You can set binding margins on the front side and back side of pages individually.

! IMPORTANT

- When the margin is set, images are shifted by the margin width and copied. An original whose image extends all the way to the edges of the sheet may be partially cut off on the copy.

- 1 Place the original.** ▶ **Placing Originals(P. 39)**
- 2 Press <Copy>.** ▶ **<Home> Screen(P. 332)**
- 3 Press <Options> on the Copy Basic Features screen.** ▶ **Copy Basic Features Screen(P. 418)**
- 4 Press <Gutter>.**
- 5 Select the margin position.**



! IMPORTANT

- If <Gutter> is set with <N on 1> (▶ **Copying Multiple Originals onto One Sheet (N on 1)(P. 446)**), the margin specified for the front side is applied to both sides. The margin specified for the back side is not applied.

- 6 Enter the margin width.**

- Press <Front Side> or <Back Side> and enter each margin width.
- If you enter a number smaller than 0, the margin is set on the opposite side of the position specified in step 4. Use this if you want to narrow the margin width when copying an original that already has margins.

- If you press <±>, the value switches between <-> and <+>.

7 Press <OK> ► <Close>.

8 Press  (Start).

⇒ Copying starts.

NOTE

- If you are using <Gutter> and <2-Sided> together follow the instructions below:
 - If there is a gutter:
 - 1-Sided ► 2-Sided: Set the Gutter mode for the back side only.
 - 2-Sided ► 2-Sided: You do not need to set the Gutter mode.
 - 2-Sided ► 1-Sided: Set the Gutter mode for the back side only.
 - If there is no gutter:
 - 1-Sided ► 2-Sided: Set the Gutter mode for both the front side and back side.
 - 2-Sided ► 2-Sided: Set the Gutter mode for both the front side and back side.
 - 2-Sided ► 1-Sided: Set the Gutter mode for both the front side and back side.

Adding a Cover and Back Cover

961F-07K



When making a booklet, you can add a front cover and a back cover using paper different from the body such as heavy paper and colored paper. You can specify whether to copy to the cover and the back cover as well.

! IMPORTANT

- When using special paper such as heavy paper for the cover and the back cover, make sure to set the paper size and paper type properly. [▶Specifying Paper Size and Type\(P. 64\)](#)

- 1 Place the original. [▶Placing Originals\(P. 39\)](#)
- 2 Press <Copy>. [▶<Home> Screen\(P. 332\)](#)
- 3 Press <Options> on the Copy Basic Features screen. [▶Copy Basic Features Screen\(P. 418\)](#)
- 4 Press <Add Cover>.
- 5 Specify the settings for the cover and back cover.



- To add a cover, press <Front Cover>. When copying to the cover, you can set where to copy, the front side, the back side, or both sides.
- To add a back cover, press <Back Cover>. When copying to the back cover, you can set where to copy, the front side, the back side, or both sides.

- 6 Press <Change> and select the paper to use.

- 7 Press <OK> ▶ <Close>.

8 Press  (Start).

▣▶ Copying starts.

LINKS

▶ **Making Booklets (Booklet Copying)(P. 469)**

Useful Copy Functions

961F-0YH

You can copy while shifting the position of images from the machine. The machine also has useful functions such as copying both sides of an ID card onto a single page, and notifying you when copying in large quantities is completed by e-mail.

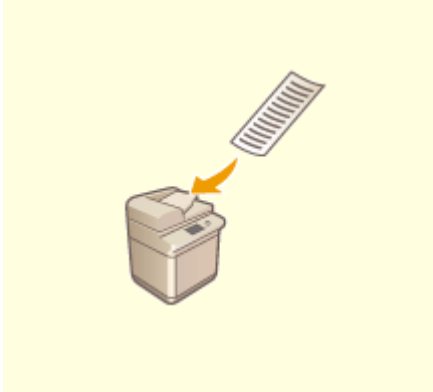

▶ **Copying Free Size Originals**(P. 479)



▶ **Mirroring Images (Mirror Image)**(P. 480)



▶ **Shifting the Image**(P. 481)

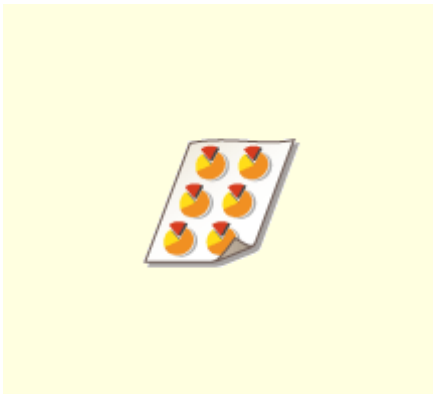

▶ **Copying with the Image Repeated (Repeat Images)**(P. 483)



▶ **Inserting Sheets and Chapter Pages (Insert Sheets)**(P. 485)



▶ **Inserting Sheets When Copying Onto Transparencies**(P. 488)

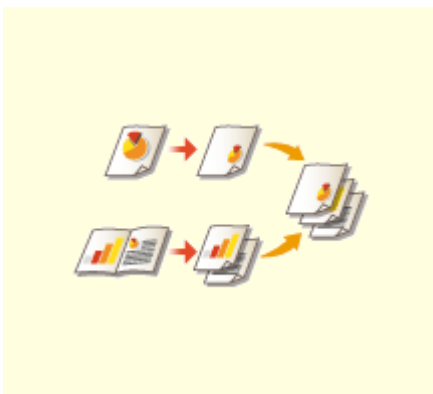

▶ **Combining Jobs with Different Settings Into a Single Job (Merge Job Blocks)**(P. 490)



▶ **Storing Copy Documents in the Machine**(P. 493)

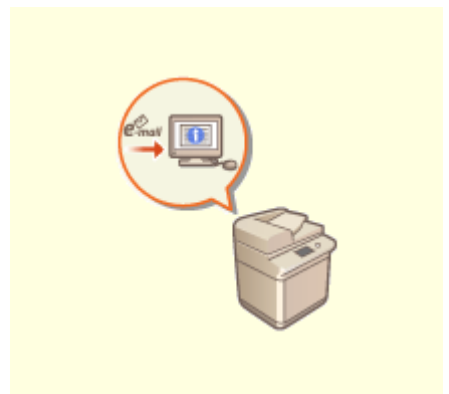

▶ **Notifying You of the Completion of Copying by E-Mail**(P. 495)



▶ Making ID Card Copies(P. 497)



▶ Area Designation(P. 499)

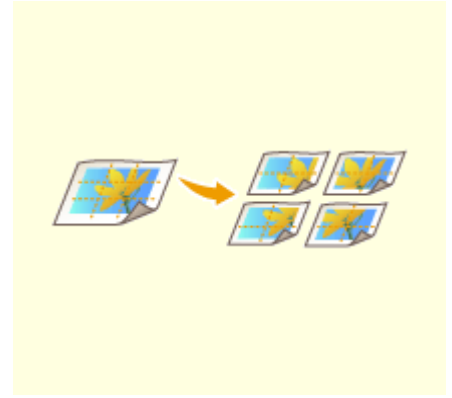

▶ Enlarging an Image to Make a Poster(P. 503)

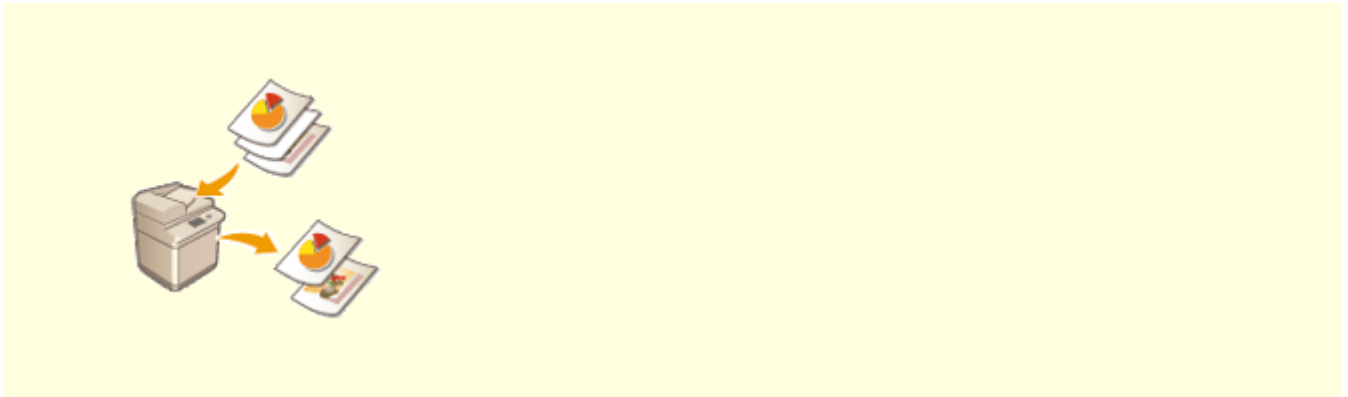

▶ Skipping Blank Pages When Printing(P. 507)

Copying Free Size Originals

961F-07R



You can scan free size originals automatically and fit to the paper selected for copying. Copying 2-sided originals is also available with this function. Place free size originals in the feeder.

- 1** Place the originals in the feeder. [▶Placing Originals\(P. 39\)](#)
- 2** Press <Copy>. [▶<Home> Screen\(P. 332\)](#)
- 3** Press <Options> on the Copy Basic Features screen. [▶Copy Basic Features Screen\(P. 418\)](#)
- 4** Press <Free Size Original> and press <Close>.
- 5** Select copy paper. [▶Basic Copy Operations\(P. 420\)](#)
- 6** To copy 2-sided originals, configure the 2-sided copy settings. [▶Basic Copy Operations\(P. 420\)](#)
- 7** Press  (Start).

⇒ Copying starts.

NOTE

- The enlarging or reducing setting cannot be performed properly because the lengths of free size originals cannot be specified.

Mirroring Images (Mirror Image)

961F-07S



This function enables you to copy the original image reversed, as if it were a reflection in a mirror. Without using a computer, you can easily create symmetrical graphics and diagrams.

- 1 Place the original.** ▶ **Placing Originals(P. 39)**
- 2 Press <Copy>.** ▶ **<Home> Screen(P. 332)**
- 3 Press <Options> on the Copy Basic Features screen.** ▶ **Copy Basic Features Screen(P. 418)**
- 4 Press <Mirror Image>.**
- 5 Press <Close>.**
- 6 Press  (Start).**

▢ Copying starts.

Shifting the Image

961F-07U



This function enables you to make copies with the entire image shifted towards an edge or the center of the page. Shift the image when you want to make blank space on the page to input or arrange text and images on material.

- ▶ **Shifting the Image to an Edge or the Center(P. 481)**
- ▶ **Specifying Moving Distance(P. 482)**

Shifting the Image to an Edge or the Center

You can make margins around the image by copying to paper larger than the original or by reducing the copied image to a size smaller than the paper size. When these margins are available, the image can be shifted to an edge or the center of the paper.

- 1 Place the original.** ▶ **Placing Originals(P. 39)**
- 2 Press <Copy>.** ▶ **<Home> Screen(P. 332)**
- 3 Press <Options> on the Copy Basic Features screen.** ▶ **Copy Basic Features Screen(P. 418)**
- 4 Press <Shift>.**
- 5 Press <By Position> and select which direction to move the image.**



- Press an arrow button or <Center> to select the direction of movement.

- 6 Press <OK> ▶ <Close>.**

- 7 Press  (Start).**

⇒ Copying starts.

Specifying Moving Distance

If no blank space exists because the original image and the output paper are the same size, or if you want to shift images by a few millimeters, specify the moving distance.

- 1 Place the original. ▶ **Placing Originals(P. 39)**
- 2 Press <Copy>. ▶ **<Home> Screen(P. 332)**
- 3 Press <Options> on the Copy Basic Features screen. ▶ **Copy Basic Features Screen(P. 418)**
- 4 Press <Shift>.
- 5 Press <By Numeric Keys> and specify the moving distance.



- Press <Set> in <Front Side> and specify the moving distance. Press the up/down/left/right buttons indicating directions and enter the moving distance using the numeric keys.
- If you want to move the image on the back side when copying both sides, the <Back Side> setting is needed. To move to the same position as the front side, press <Same as Front Side>. To move symmetrically, press <Opposite to Front Side>. To move to a position different from the front side, press <Set> and enter the moving distance.

- 6 Press <OK> ▶ <Close>.

- 7 Press  (Start).

▮▶▶▶ Copying starts.

LINKS

- ▶ **Setting Binding Margins(P. 473)**

Copying with the Image Repeated (Repeat Images)

961F-07W



You can copy the same image repeatedly on one page. You can easily make address labels and coupons.

! IMPORTANT

Pay attention to the sizes of the original and the output paper

- When making address labels, set an original that is the same size as a single label and manually select the output paper size (▶ **Basic Copy Operations(P. 420)**). For example, if you set an original that is the same size as the output paper and perform image repeat, the image in the original size is repeated and the printed images may be partially cut off.

Example of an incorrect setting: Placing an original that is the same size as the output paper and repeating the image twice vertically and twice horizontally



Example of a correct setting: Placing an original that is one-fourth the size of the output paper and repeating the image twice vertically and twice horizontally



*If the original size is smaller than the output paper size, the desired output size may not be selected while auto paper select is set.

- 1 Place the original.** ▶ **Placing Originals(P. 39)**
- 2 Press <Copy>.** ▶ **<Home> Screen(P. 332)**
- 3 Press <Options> on the Copy Basic Features screen.** ▶ **Copy Basic Features Screen(P. 418)**
- 4 Press <Repeat Images>.**
- 5 Specify the number of times to repeat and press <Set Margins>.**

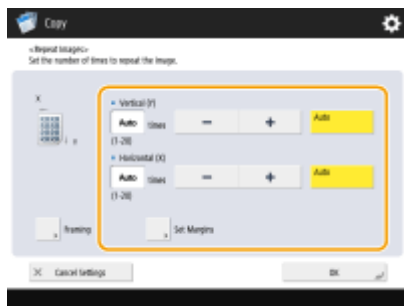

- Specify the vertical and horizontal number of times to repeat respectively.
- When setting to <Auto>, the image is repeated automatically until the images fill the paper.

6 Set blank spaces between images and press <OK>.

- Enter the blank space width. If you want to set a different blank space width above the image, under the image, to the left of the image, and to the right of the image, press <Adjust Independently> to enter each width.

7 Press <OK> ► <Close>.

8 Press (Start).

►► Copying starts.

Inserting Sheets and Chapter Pages (Insert Sheets)

961F-07X



You can insert sheets between content pages. For example, when you make a large amount of copies, you can easily check the number of output sheets by inserting colored paper every 50 pages. Inserted sheets can be used as chapter pages if you print on them.

NOTE

- You can specify the range for the insert sheet from 1 to 30,000 pages.
- You can insert up to 100 insert sheets.

Inserting Sheets

Specify the page to insert the sheets, set the number of the sheets, and select whether to print on the sheets.

! IMPORTANT

- When inserting special types of paper such as heavy paper, make sure to set the paper size and the paper type properly before operation. ▶ [Specifying Paper Size and Type\(P. 64\)](#)

- 1** Load paper used for sheets insertion. ▶ [Loading Paper\(P. 46\)](#)
- 2** Place the original. ▶ [Placing Originals\(P. 39\)](#)
- 3** Press <Copy>. ▶ [<Home> Screen\(P. 332\)](#)
- 4** Press <Options> on the Copy Basic Features screen. ▶ [Copy Basic Features Screen\(P. 418\)](#)
- 5** Press <Insert Sheets>.
- 6** Press <Sheets> ▶ <Add>.
- 7** Specify the page to insert the sheet.



- Enter the page to insert the sheet using the numeric keys. For example, when copying 100 pages, if you want to insert the sheet after the 50th page, enter "51."

8 Specify detailed settings.

- Press <Change> in <Select Paper> and select the paper to insert.
- To insert two or more sheets, press <Number of Sheets to Insert> and enter the number of sheets using the numeric keys.
- To print on the sheets, select <Print on Front Side>, <Print on Back Side>, or <Print on Both Sides> in <Print Settings>.

9 Press <OK>.

⇒ The screen returns to the screen in step 5 and the setting you specified is shown in the first line of the list.

■ Inserting the sheet in another page

Select the second line onwards in the list, press <Add>, and repeat steps 6 to 8.

■ Editing or deleting the sheet

Select the sheet from the list, press <Details/Edit> or <Delete>.

10 Press <OK> ► <Close>.

11 Press (Start).

⇒ Copying starts.

NOTE

- If inserting the sheet only, it is not counted as a copy number. If you print on the sheet, it is counted as a copy number.

Adding a chapter title

- Using the function to print on the sheet, you can insert chapter pages in essays, reports, etc. Include the original to be printed on the chapter page in the original document.
- If you do not copy anything on the back side of the chapter page and leave it blank, select <Chapter Pages> in step 5. You do not need to configure <Print Settings> because <Chapter Pages> is set to print only on one side by default.

LINKS

- ▶ **Inserting Sheets When Copying Onto Transparencies(P. 488)**
- ▶ **Adding a Cover and Back Cover(P. 475)**

Inserting Sheets When Copying Onto Transparencies

961F-07Y



When copying onto transparencies, you can prevent transparencies from sticking together by inserting sheets between transparencies. You can also print on inserted sheets.

1 Load transparencies and paper to insert.

- Load the transparency in the multi-purpose tray and the paper to insert in the paper drawer, and specify the paper size and type for the transparency and paper. [▶Loading Paper\(P. 46\)](#)

NOTE

- For information on the paper size available for transparencies, see [▶Hardware Specifications\(P. 215\)](#) .

2 Place the original. [▶Placing Originals\(P. 39\)](#)

3 Press <Copy>. [▶<Home> Screen\(P. 332\)](#)

4 Press <Options> on the Copy Basic Features screen. [▶Copy Basic Features Screen\(P. 418\)](#)

5 Press <Transparency Cover Sheets>.

6 Select whether to copy on the insert sheet and specify the insert sheet.



- To copy onto the insert sheet, press <Print>. The image printed on the preceding transparency is printed on the insert sheet.
- To specify the size of the insert sheet, press <Change> in <Cover Sheet Size> and select the paper size.

7 Press <OK> ▶ <Close>.

8 Press (Start).

⇒ Copying starts.

LINKS

🔴 **Inserting Sheets and Chapter Pages (Insert Sheets)(P. 485)**

Combining Jobs with Different Settings Into a Single Job (Merge Job Blocks)

961F-081



You can scan multiple originals with different settings, and then combine the jobs into a single job and print it out. For example, scan one original with the Hole Punch setting and another original with the 2-sided setting, after that, you can combine these originals into a single job and add page numbers or attach covers to the whole output.

- 1 Press <Copy>.
- 2 Press <Options> on the Copy Basic Features screen. **▶ Copy Basic Features Screen(P. 418)**
- 3 Press <Merge Job Blocks>.
- 4 Specify settings that are applied to all of the originals and press <OK>.

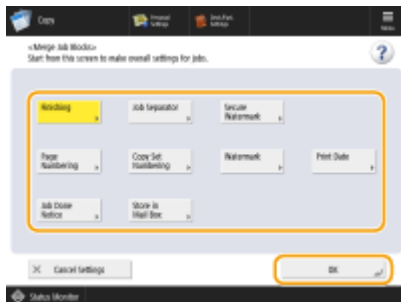

- To configure <Finishing>, see **▶ Basic Copy Operations(P. 420)** .
- To configure <Job Separator>, see **▶ <Job Separator Between Jobs>(P. 1169)** or **▶ <Job Separator Between Copies>(P. 1170)** .
- To configure <Secure Watermark>, see **▶ Restricting Copying of Confidential Documents(P. 509)** .
- To configure <Page Numbering>, <Copy Set Numbering>, <Watermark>, <Print Date>, see **▶ Functions Useful for Making and Managing Material(P. 459)** .
- To configure <Job Done Notice>, <Store in Mail Box>, see **▶ Useful Copy Functions(P. 477)** .

- 5 Place the first original, configure settings on the Copy Basic Features screen, and press **▶ (Start)**.

▶▶▶ Scanning starts. When scanning is complete, the screen appears prompting you to scan the next original.

- If you want to keep the setting specified in this step for the next original, proceed to step 7.
- If you want to change some of the settings such as copy ratio or density for the next original, press <Change Settings> on the screen, change the settings, and proceed to step 7.

- 6 Press <Scan Settings of Next Block>.

NOTE

- You can change or specify the following settings using <Change Settings> before scanning the next batch of originals (i.e., between batches): You need to set the necessary scan settings in advance, since you cannot change the settings in <Options> during the Job Build mode.
 - <Copy Ratio>
 - <2-Sided Original>
 - <Density>
 - <Original Type>
- You cannot adjust the exposure while printing if <Secure Watermark> is set for the entire block.

7 Place the next original, configure settings on the Copy Basic Features screen and press (Start).

- Repeat steps 6 and 7 for the originals you want to combine.
- To apply the last setting you used to the original, place the original and press  (Start).

8 Press <Check/Merge All Blocks>.

9 Enter the number of copies and confirm the settings for the scanned originals.



a <No. of Prints>

Enter the number of copies using the numeric keys.

b <Check Overall Settings>

You can check the settings specified in step 4.

c <List of scanned originals>

Displays the information of the scanned originals as a list.

- The number in  appears as 1, 2, 3... in the order that the originals are scanned, and the copies are printed in order. If you want to change the order, press <Clear Selection> in **i** and specify the order.

d <Add Cover>/<Insert Sheets>

You can include covers and insert sheets (chapter pages).

▶ **Adding a Cover and Back Cover(P. 475)**

▶ **Inserting Sheets and Chapter Pages (Insert Sheets)(P. 485)**

e <Edit & Adjust>

You can preview pages, or delete specific pages or jobs.

f <Add Originals>

You can scan more originals to add to the output.

g <Add from Mail Box>

You can call originals from the Mail Box to add to the output. ▶ **Making Simple Edits to Files(P. 724)**

h <Details>

When selecting originals in **c**, <Details> is displayed. You can confirm the settings for each original.

i <Print Sample>

You can print a copy sample to check the result before making a large amount of copies. ▶ **Checking the Copy Results(P. 455)**

j <Clear Selection>/<Select All>

You can change the original order in **c**.

10 Press <Start Printing>.

▣ Copying starts.

NOTE

- You cannot perform an interrupt copy job while scanning with the Merge Job Blocks mode.
- You cannot recall the Merge Job Blocks mode using <Previous Settings>.
- Maximum number of job blocks that can be scanned: 100

Storing Copy Documents in the Machine

961F-082



You can save scanned documents in the "Mail Box" of the machine temporarily and print them out later. The data is saved for a certain period of time.

- 1 Place the original. ▶ [Placing Originals\(P. 39\)](#)
- 2 Press <Copy>. ▶ [<Home> Screen\(P. 332\)](#)
- 3 Specify the copy settings as necessary. ▶ [Basic Copy Operations\(P. 420\)](#)
- 4 Press <Options> on the Copy Basic Features screen. ▶ [Copy Basic Features Screen\(P. 418\)](#)
- 5 Press <Store in Mail Box>.
- 6 Select the destination Mail Box.

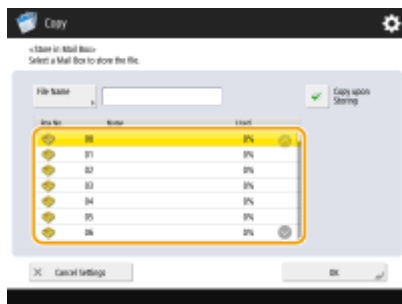

- 7 Enter a file name by pressing <File Name> and then press <OK>.

NOTE

- Even if you do not enter a file name, the machine automatically assigns it a name using the year, month, day, and time the file was created. For example, if a file is created at 1:05 PM, 12 seconds, on October 30, 2015, its name will be "20151030130512."

- 8 Press <OK> and then  (Start).

- ▣ Documents are scanned and saved in the Mail Box. A duplicate of the document is output at the same time.
- If you do not need the duplicate, press <Copy upon Storing> on the screen in step 5 to clear the check box.

NOTE

- Print settings are saved together, allowing you to always print documents with the same finishing, as well as save you the trouble of specifying settings.
- To print the stored files, see [▶Printing Files in the Mail Box\(P. 734\)](#) .
- You can change the time period for storing files. [▶Specifying the Mail Box Settings\(P. 737\)](#)

LINKS

- ▶[Making Simple Edits to Files\(P. 724\)](#)

Notifying You of the Completion of Copying by E-Mail

961F-083



You can receive an e-mail notifying you that originals are finished copying. When performing a large copying job or reservation copies (▶ **Basic Copy Operations(P. 420)**), you do not need to wait beside the machine for the print completion.

! IMPORTANT

- The destination for the notification e-mail needs to be specified from the Address Book. Register the desired destination beforehand. ▶ **Registering Destinations in the Address Book(P. 394)**

- 1 Place the original. ▶ **Placing Originals(P. 39)**
- 2 Press <Copy>. ▶ **<Home> Screen(P. 332)**
- 3 Specify the copy settings as necessary. ▶ **Basic Copy Operations(P. 420)**
- 4 Press <Options> on the Copy Basic Features screen. ▶ **Copy Basic Features Screen(P. 418)**
- 5 Press <Job Done Notice>.
- 6 Select an e-mail address from the Address Book and press <OK>.



- For information on how to view and use the Address Book, see ▶ **Address Book(P. 389)** .

- 7 Press <Close>.

8 Press  (Start).

- ▣ Documents are scanned and copying starts. When copying is complete, the notification e-mail is sent to the specified address.

Making ID Card Copies

961F-084



This function enables you to copy both the front and back of an ID card onto a single sheet of paper. This function is useful when copying ID cards (identification cards) such as driver's licenses, because the orientation and print position of the images of both sides of the ID card are aligned automatically according to the paper size.

! IMPORTANT

- Place the ID card on the platen glass. Place the ID card face down with its corner aligned with the top-left corner of the platen glass, as shown below. The Copy ID Card mode cannot be used when the ID card is placed in the feeder.



NOTE

- If another original is set in the feeder, you cannot start copying. Remove the original from the feeder.
- Only A4 size paper can be used for <Copy ID Card>.

- 1 Place the ID card on the platen glass face down.** ▶ **Placing Originals(P. 39)**
- 2 Press <Copy>.** ▶ **<Home> Screen(P. 332)**
- 3 Press <Options> on the Copy Basic Features screen.** ▶ **Copy Basic Features Screen(P. 418)**
- 4 Press <Copy ID Card>.**
- 5 Press <Change>, select the paper to use, and press <OK>.**
- 6 Press <OK> ▶ <Close>.**
- 7 Press  (Start) to scan the front side.**

⇒ Once scanning is completed, a screen will appear notifying you that preparations to scan the back side are complete.

8 Turn the ID card over so that its back side is facing down and press  (Start) to scan the back side.

⇒ After the back side is scanned, printing starts automatically.

Area Designation

961F-085



You can extract a single part of an original for copying, like when trimming photos or cutting out articles from a newspaper. Since you can specify the area to copy while checking the preview screen, it is not necessary to cut the original.

- 1 Place the original.** ▶ **Placing Originals(P. 39)**
- 2 Press <Copy>.** ▶ **<Home> Screen(P. 332)**
- 3 Press <Options> on the Copy Basic Features screen.** ▶ **Copy Basic Features Screen(P. 418)**
- 4 Press <Area Designation>.**
- 5 Press <Touch Entry>.**
- 6 Press <Start Scanning>.**

⇒ The original is scanned, and the preview screen is displayed.

- 7 Specify the area to copy.**

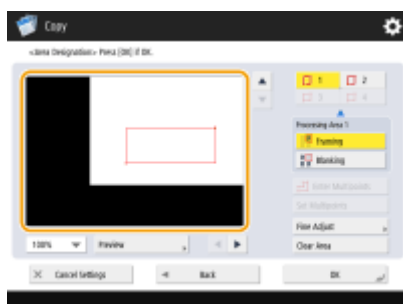

(Items shown on the screen may differ depending on your model and options.)

- Touch two diagonally opposite points to specify a rectangle area with those points as reference points. Specify an area that encloses the area you want to copy in a rectangle.

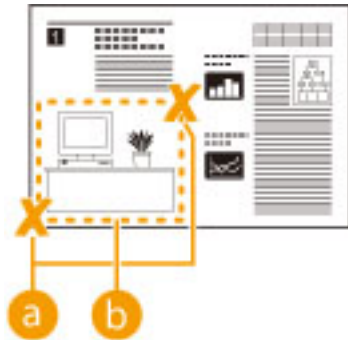

- a** Two opposing points to enter
- b** The area to copy

- To cancel a point you have specified, press <Delete Point>. To delete the area after you have specified it, press <Clear Area>.

NOTE

- If it is difficult to specify the area because the image displayed on the preview screen is small, press <100% ▼> to enlarge it. You can press ◀, ▶, ▼, or ▲ after selecting the zoom ratio to move to the location you want to display.
- If it is difficult to specify an area because the space between text or images is small, press <Fine Adjust> to perform fine adjustment of the area. You can move the position of an individual point by selecting the desired <Move Point> button after selecting one of the corner points by pressing the <Select Point>.
- If the area of a specified area is too small, the color information of the original may not be correctly detected, and the copy may be output in black and white.

If buttons appear that allow you to specify multiple areas

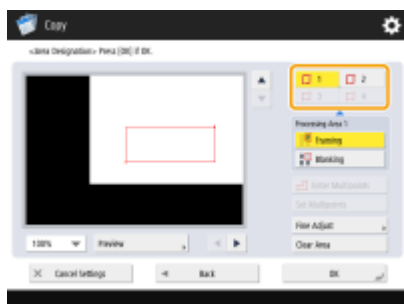

- You can specify up to four areas. After specifying the first area, press 2 , 3 , or 4 to specify the second and subsequent areas.

8 Press <Framing> ▶ <Preview>.

NOTE

If you press <Framing>, the specified areas are copied.
 If you press <Blanking>, the contents outside the specified areas are copied.

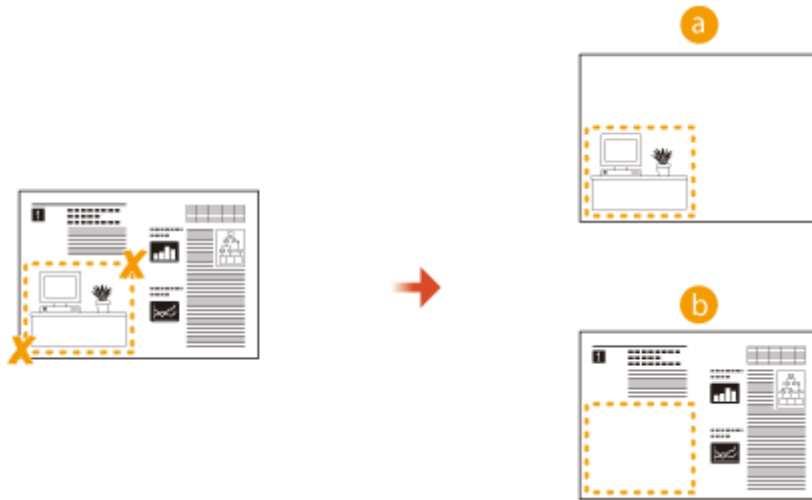

- a** Framing
- b** Blanking

9 Confirm whether the areas are specified correctly, and press <OK>.

- To adjust an area, press <OK> to return to step 7, press <Clear Area> or <Fine Adjust>, and specify the area again.

NOTE

If you select <Blanking> in step 8, press <OK> and proceed to step 12.

10 Press <Next > ▶ <Center Shift> or <Do Not Center Shift>.

- To move the specified area to the center of the paper, press <Center Shift>.

11 Press <OK>.

12 Press ◀▶ (Start).

⇒ Copying starts.

NOTE

Specifying more complicated areas (only if the <Enter Multipoints> setting appears)

You can specify areas with a complicated shape, as indicated in the diagram below. Press <Enter Multipoints> on the screen in step 7, and specify the area using 4 to 10 points. After pressing the last point, press <Set Multipoints> to confirm the area. When using this method, you can only specify one area. In addition, you cannot designate a rectangular area and a polygonal area at the same time.

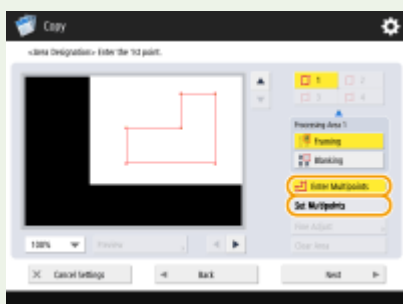

Specifying a more accurate area

Since areas are specified on the preview screen, they may shift when actual copies are made. If you want to specify more accurate areas, enter dimensions that you have measured in advance. As indicated in the diagram, measure the distance between the right edge of the area and the original's right edge (X1), the left edge of the area and the original's right edge (X2), the top edge of the area and the original's top edge (Y1), and the bottom edge of the area and the original's top edge (Y2), press <Numeric Key Entry> in step 5, and enter the dimensions of X1, X2, Y1, and Y2 using the numeric keys.



(Items shown on the screen may differ depending on your model and options.)

Combining with the Image Repeat mode

If you want to use <Framing> and <Repeat Images> at the same time, set <Repeat Images> first, and then set <Framing>.

Enlarging an Image to Make a Poster

961F-086



You can enlarge an image and copy it to multiple sheets of paper to create a large poster by joining the sheets together. There are two methods for copying to multiple sheets of paper; specifying the copy ratio only, and specifying the number of sheets of paper to use.

◀ Specifying the Copy Ratio(P. 504)

◀ Specifying the Paper Size to Use and Number of Sheets(P. 505)

NOTE

- A maximum of one set can be copied at one time.
- Place your original on the platen glass. The Poster mode cannot be used if the original is placed in the feeder.
- You cannot create a poster using the following paper:
 - Custom size paper
 - Envelopes
 - Transparencies
 (For information on the paper supported by your machine, see ▶ **Available Paper(P. 224)** .)
- If you set <Poster> while the color mode is set to <Auto (Color/B&W)>, <Select Color> is automatically set to <Full Color>. ▶ **Basic Copy Operations(P. 420)**

Copy Ratio and Paper Settings

- The following table indicates an estimate of the original size and copy ratio for different size posters and the optimal paper size and number of sheets to use. Refer to this table when entering the copy ratio and when specifying the paper size and number of sheets.

Poster size	Original size and copy ratio		Optimal paper size and number of sheets
	A3	A4	
A0 Landscape	282 %	—	A3 / 9 sheets
A1 Portrait	—	282 %	A3 / 6 sheets
A2 Portrait	—	200 %	A3 / 3 sheets

- You can create a poster using an original size and copy ratio not indicated in this table, but the maximum original size is A3 and the maximum copy ratio is 400%.
- Since the poster is output after being divided into the optimal number of sheets, fewer sheets may be output than the number you specify.
- The poster size after the copied sheets are joined will be slightly smaller than the value in the table.

TIPS

Joining the copied sheets

- The copied sheets have areas where the images overlap (**a** and **b**), as indicated in the diagram below. When joining the sheets together, cut these areas to an appropriate width and glue them together.

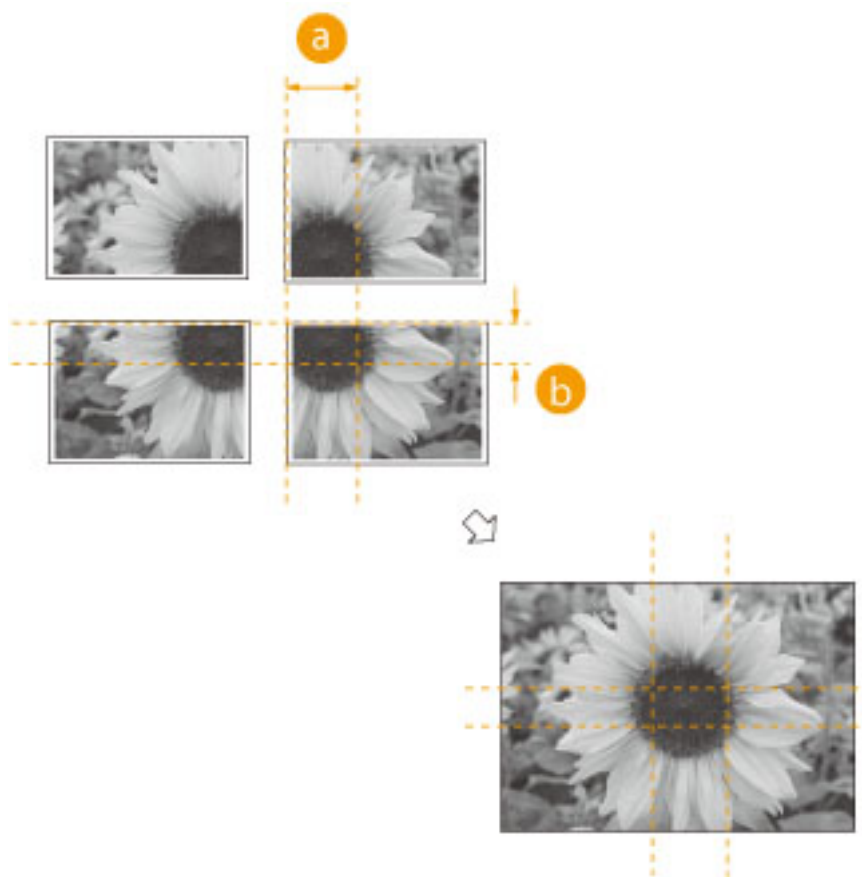

NOTE

- The width of the areas where the images overlap differs according to the copy ratio and paper size.

Specifying the Copy Ratio

Specify the ratio for enlarging the image to create a poster. The optimal paper size and number of sheets are automatically selected according to the original size and copy ratio.

- 1 Place the original.** ▶ **Placing Originals(P. 39)**
- 2 Press <Copy>.** ▶ **<Home> Screen(P. 332)**
- 3 Press <Copy Ratio>.**
- 4 Press <Poster>.**
- 5 Press <Copy Ratio> ▶ <Next>.**

6 Specify the copy ratio, and press <OK>.



- Specify the copy ratio using the buttons on the screen or the numeric keys.

7 Press (Start).

⇒ Copying starts.

Specifying the Paper Size to Use and Number of Sheets

If you want to create a poster by selecting the paper because you want to use paper in the multi-purpose tray or if there is only a specific size of paper loaded in the machine, it is necessary to specify the paper size and number of sheets.

1 Place the original. ▶ Placing Originals(P. 39)

2 Press <Copy>. ▶ <Home> Screen(P. 332)

3 Press <Copy Ratio>.

4 Press <Poster>.

5 Press <Number of Output Pages> ▶ <Next>.

6 Press <Change>, select the paper size, and press <OK>.

- If you select the multi-purpose tray, specify the paper size and type to load.

7 Select the number of sheets, and press <OK>.



8 Press  (Start).

⇒ Copying starts.

Skipping Blank Pages When Printing

961F-087

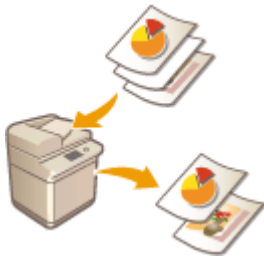

The machine can detect blank pages when scanning, and print all the pages except blank pages.

- 1** Place the original. ▶ **Placing Originals(P. 39)**
- 2** Press **<Copy>**. ▶ **<Home> Screen(P. 332)**
- 3** Press **<Options>** on the **Copy Basic Features** screen. ▶ **Copy Basic Features Screen(P. 418)**
- 4** Press **<Skip Blank Pages>**.
- 5** Select the color of the originals to skip.

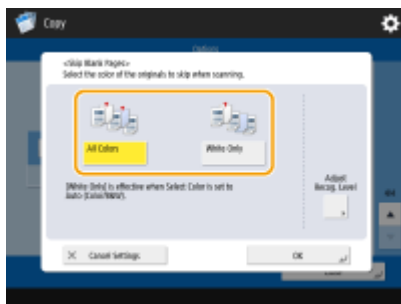

- To skip blank originals regardless of their color, select **<All Colors>**. To skip blank originals only in white, select **<White Only>**.
- If a setting other than **<Auto (Color/B&W)>** is set in **<Select Color>**, the same operations as **<All Colors>** is performed even if you select **<White Only>**.

- 6** Press **<Adjust Recog. Level>**, set the accuracy to detect blank paper, and then press **<OK>**.

⇒ Pressing **<+>** makes the detection accuracy higher.

- 7** Press **<OK>** ▶ **<Close>**.

- 8** Press ▶ (Start).

⇒ Copying starts.

IMPORTANT

- If the size of the original is smaller than the scan size setting, it may not be skipped correctly.

NOTE

- To check the number of pages that have been printed, follow the procedures below:
 -  (Status Monitor) ▶ <Copy/Print> ▶ <Job Log> ▶ select a document ▶ <Details> ▶ check the number displayed for <Original Pages>.
 - The status screen and report display the number including blank paper. ▶ **Checking the Status of Copies/Prints(P. 906)**
 - The copy counter is not incremented for blank paper that is saved. However, the scan counter is incremented for those pages.
- If you are configuring settings in <Scan and Store>, read <Skip Blank Pages> as <Skip Blank Originals> in this section.

Restricting Copying of Confidential Documents

961F-088

In order to prevent carelessly copying documents that include personal or confidential information, the machine provides a "Secure Watermark" function. Secure Watermark enables you to embed hidden text such as "CONFIDENTIAL" on output copies. If the output copies are copied again, the text emerges as a warning.



▶ **Embedding the "TOP SECRET" Text (Secure Watermark)(P. 510)**

NOTE

- You can set the machine to always perform Secure Watermark for every copy job.
 - ▶ **Embedding Invisible Text (Forced Secure Watermark)(P. 893)**
- The text for <Secure Watermark> can also be selected from the text which has been registered in ▶ **<Register Characters for Page Numbering/Watermark>(P. 1174)** .

Embedding the "TOP SECRET" Text (Secure Watermark)

961F-089



When copying documents that include confidential information, you can embed invisible text such as "TOP SECRET" or "CONFIDENTIAL" to warn unauthorized users not to copy them. When copying a document that has already been copied, the embedded text appears across the entire page, preventing unauthorized copies of copies. **▶System Options(P. 1597)**

Depending on the machine you are using, this function is available by default.

- 1 Place the original. **▶Placing Originals(P. 39)**
- 2 Press <Copy>. **▶<Home> Screen(P. 332)**
- 3 Press <Options> on the Copy Basic Features screen. **▶Copy Basic Features Screen(P. 418)**
- 4 Press <Secure Watermark>.
- 5 Select the type of characters and specify detailed settings as necessary.

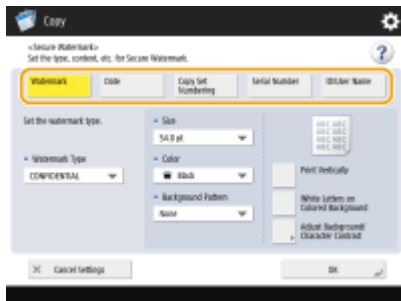

■ Embedding watermarks such as "TOP SECRET" or "CONFIDENTIAL"

- 1 Press <Watermark>.
- 2 Select the type of watermark.

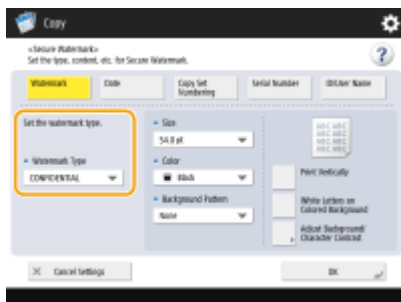

- To embed arbitrary text, select <Custom> and enter the text by pressing <Enter>.

NOTE

- You can register frequently used text. Select <Custom> and enter the text by pressing <Register>.
- To edit or delete registered text, press <Register>, select the text from the list, and press <Edit> or <Delete>.

■ Embedding dates

- 1 Press <Date>.
- 2 Set the dates to embed.



- The dates set in the machine are displayed in <Specify date>. To embed other dates, enter using the numeric keys.
- 3 Select the format for dates.
 - Press <Date Format> to select the date format.

■ Embedding reference numbers

If you copy specifying the number of copies, you can embed different four-digit reference numbers set by set.

- 1 Press <Copy Set Numbering>.
- 2 Enter the starting reference number.

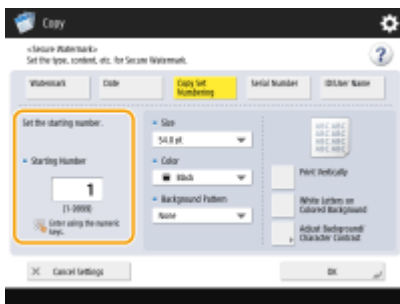

- Enter in the input field of <Starting Number> using the numeric keys.

■ Embedding serial numbers

Embed the serial number of the machine.

- 1 Press <Serial Number>.

■ Embedding ID or user name

Embed login information (department ID or user name) to use the machine with.

1 Press <ID/User Name>.

6 Specify the print settings for the watermark.



- Set the character format.

NOTE

- You can adjust the density of patterns and backgrounds. If you press <Adjust Background/Character Contrast> ► <Sample Print>, a sample of the pattern and background is printed. Check the sample and press ▼ / ▲ to adjust the density.
- The sample print includes the hidden text and the background for each relative contrast value.
- The area within the frame on the sample print is the output sample for the currently set relative contrast value.
- The <Adjust Background/Character Contrast> setting is canceled when the job is complete. If you want to use the same settings for the next copy job, specify the settings again.

7 Press <OK> ► <Close>.

8 Press  (Start).

- ⇒ Copying starts.
- You cannot change the density during output.

LINKS

▶ **Printing With Settings Disabling Unauthorized Copying(P. 614)**

Reducing Copying Operations

961F-08A

You can eliminate the need to specify the same settings every time you make copies by recalling previously used settings. In addition, switching the Copy Basic Features screen (▶ **Copy Basic Features Screen**(P. 418)) to the "Express Copy Screen" enables you to change the settings with fewer steps.



▶ **Recalling Previously Used Copy Settings (Previous Settings)**(P. 514)

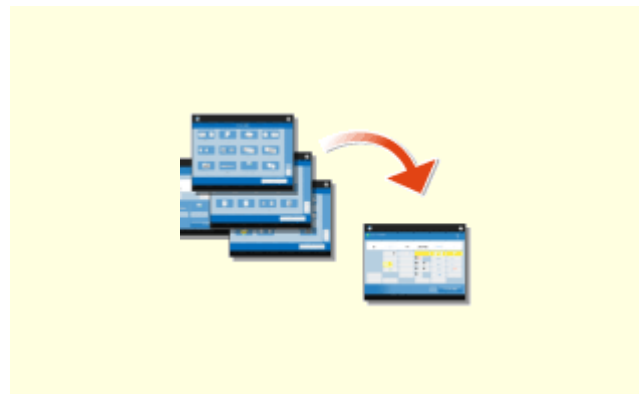

▶ **Changing the Settings Quickly (Express Copy Screen)**(P. 516)

Recalling Previously Used Copy Settings (Previous Settings)

961F-08C



You can recall the previously used copy settings. The details of the recalled setting can be changed before copying.

NOTE

- The three most recent settings that were stored in memory are not deleted even when the main power is turned Off.

- 1 Place the original.** ▶ **Placing Originals(P. 39)**
- 2 Press <Copy>.** ▶ **<Home> Screen(P. 332)**
- 3 Press <Previous Settings> on the Copy Basic Features screen.** ▶ **Copy Basic Features Screen(P. 418)**
- 4 Select the setting to recall and press <OK>.**

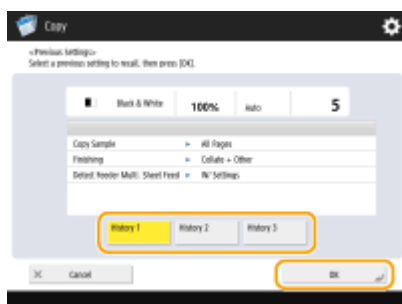

- When personal authentication management is in use, the machine recalls the settings specified in the past by the user who is logging in to the machine.

- 5 Press  (Start).**

⇒ Copying starts.

! **IMPORTANT**

Merge Job Blocks* setting

- Previous jobs cannot be recalled.

* Merge Job Blocks:  **Combining Jobs with Different Settings Into a Single Job (Merge Job Blocks)(P. 490)**

Changing the Settings Quickly (Express Copy Screen)

961F-08E

Switching the Copy Basic Features screen from the "Regular Copy Screen" to the "Express Copy Screen" enables you to change the settings related to basic copy operation (**Basic Copy Operations(P. 420)**) more quickly. For example, to copy both sides of an original using the Regular Copy Screen, you need to press <2-Sided> and press <1-Sided ▶ 2-Sided> or <2-Sided ▶ 2-Sided>. On the Express Copy Screen, you can directly select <1-Sided ▶ 2-Sided> or <2-Sided ▶ 2-Sided>, so you can finish settings with fewer steps.

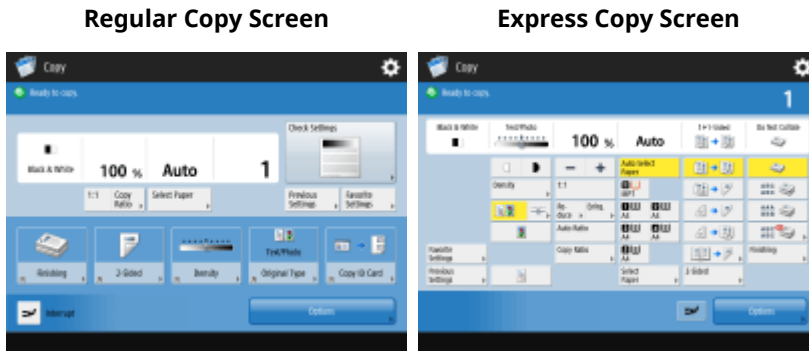

- ▶ Switching to the Express Copy Screen(P. 516)
- ▶ Express Copy Screen(P. 516)

Switching to the Express Copy Screen



⚙️ (Settings/Registration) ▶ <Preferences> ▶ <Display Settings> ▶ <Copy Screen Display Settings> ▶ <Express Copy> ▶ <OK> ▶ ⚙️ (Settings/Registration) ▶ ⚙️ (Settings/Registration) ▶ <Apply Set. Changes> ▶ <Yes>

Express Copy Screen

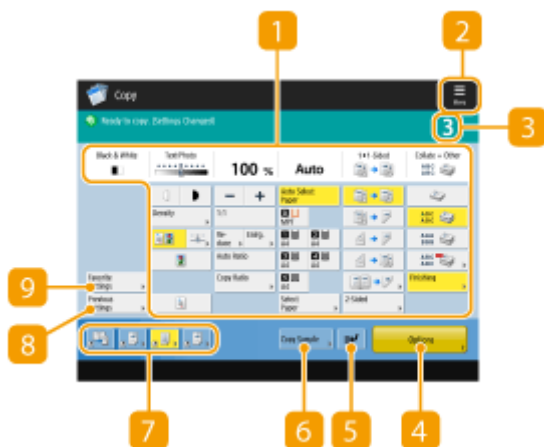

1 Current main setting status and setting buttons

Displays the setting status such as the copy ratio, paper size, number of copies, etc. Make sure to confirm the settings here in order to copy properly. To change the settings, press the button under the display section. ▶ **Basic Copy Operations(P. 420)**

2 

Press this icon to register the current settings in <Favorite Settings> of **9** or to change the buttons displayed in **7**.

▶ **Registering a Combination of Frequently Used Functions(P. 367)**

▶ **Customizing the Basic Features Screen(P. 370)**

3 Number of copies

Displays the number of copies. Enter using the numeric keys.

4 <Options>

Displays the setting functions such as <Booklet> or <Page Numbering> that are not displayed in **1** or **7**.

5 <Interrupt>

You can interrupt waiting copy jobs and make your copy immediately. ▶ **Copying Immediately by Interrupting Other Jobs(P. 458)**

6 <Copy Sample>

Depending on the number of copies and settings, this button is displayed. You can print a copy sample to check the copy result before making a large amount of copies. ▶ **Checking the Copy Results(P. 455)**

7 Function setting buttons

Displays the most frequently used buttons from <Options>. The setting status is displayed on the buttons. You can change the buttons displayed currently into other function setting buttons using the icon in **2**.

8 <Previous Settings>

You can select a setting from among the past three settings you specified. ▶ **Recalling Previously Used Copy Settings (Previous Settings)(P. 514)**

9 <Favorite Settings>

Register frequently used copy settings here in advance to easily recall them when necessary. ▶ **Registering a Combination of Frequently Used Functions(P. 367)**

LINKS

▶ **Customizing the Basic Features Screen(P. 370)**

▶ **Copy Basic Features Screen(P. 418)**

Faxing

Faxing	519
Fax Basic Features Screen	521
Basic Operations for Sending Faxes	524
Canceling Sending Faxes	540
Receiving Faxes	542
Sending Faxes Successfully	544
Checking Scanned Images Before Sending (Preview)	545
Checking the Connection to the Recipient Before Sending (Direct Send)	547
Sending Faxes Manually (Manual Sending)	549
Notifying You by E-Mail of the Completion of Sending	551
Simplifying Sending Operations	553
Sending Different Size Originals Together (Different Size Originals)	554
Sending Separately Scanned Documents Together (Job Build)	555
Recalling Previously Used Settings for Sending (Previous Settings)	557
Useful Functions When Sending	559
Sending at a Specified Time	560
Saving a Copy of a Sent Document	562
Various Receiving Methods	565
Saving Received Documents in the Machine (Memory Reception)	566
Keeping Received Documents Private	569
Forwarding Received Documents Automatically	571
Checking Status and Log for Sent and Received Documents	574
Sending Faxes from Your Computer (PC Fax)	577
Sending PC Faxes	578
Using Internet Faxes (I-Fax)	582
Sending I-Faxes	583
Receiving I-Faxes	591
Using Remote Faxes	592

Faxing

This chapter introduces the basic methods for sending and receiving faxes as well as convenient fax functions you can use according to your needs.

■ Introduction to Basic Operations

This section describes the Fax Basic Features screen and the basic sending and receiving methods.



- ▶ **Fax Basic Features Screen(P. 521)**
- ▶ **Basic Operations for Sending Faxes(P. 524)**
- ▶ **Receiving Faxes(P. 542)**
- ▶ **Checking Status and Log for Sent and Received Documents(P. 574)**

■ Successfully, Easily, Conveniently

You can find and choose among various sending and receiving methods right for you. Fully using functions can provide you with an efficient way to send and receive faxes.

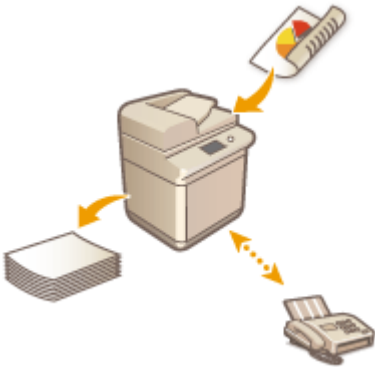

- ▶ **Sending Faxes Successfully(P. 544)**
- ▶ **Simplifying Sending Operations(P. 553)**
- ▶ **Useful Functions When Sending(P. 559)**
- ▶ **Various Receiving Methods(P. 565)**
- ▶ **Forwarding Received Documents Automatically(P. 571)**

■ Sending Faxes from Your Computer

You can directly fax a document saved on a computer. This method can eliminate the need to print, saving paper and toner, as well as make the images and fine print on documents more clear.



- ▶ **Sending Faxes from Your Computer (PC Fax)(P. 577)**

■ Using Fax Functions More Fully

This section describes how to send and receive faxes via the Internet. You can also learn how to use a multifunction printer without the ability to fax for sending and receiving faxes via other multifunction printers on the network.

▶ **Using Internet Faxes (I-Fax)(P. 582)**

▶ **Using Remote Faxes(P. 592)**



TIPS

- Installing an option enables you to use an IP fax. The IP fax is a function to send and receive faxes over a TCP/IP network such as an office LAN. Sending and receiving faxes between devices in the same network helps reduce communication costs as well as makes communication speed faster than normal faxes.

IP FAX Expansion Kit User's Guide

▶ **Options(P. 171)**

Fax Basic Features Screen

961F-08H

Pressing <Fax> ( <Home> Screen(P. 332)) displays the Fax Basic Features screen.



1 Destination

Displays the name of the specified destination, fax number, number of destinations, and the current time.

2 <Details>

Enables you to check the detailed information of the destination displayed in **1**.

3 <Delete Dest.>

Enables you to delete the destination displayed in **1**.

4 <Tone>

If you press this button when specifying the destination, the character "T" (tone) is inserted. Even if you are using pulse dial, numbers following "T" will be sent using tone dial. Press this button when using fax information services.

5 One-touch button

Enables you to specify a fax destination registered in one-touch buttons.

6 <Address Book>

Enables you to specify a fax destination registered in the Address Book.

7 <On-Hook>

Press to send a fax document manually.  **Sending Faxes Manually (Manual Sending)(P. 549)**

8 <Direct Send>

Press to check the connection to the recipient's fax machine before scanning originals.  **Checking the Connection to the Recipient Before Sending (Direct Send)(P. 547)**



Press to register destinations in one-touch buttons. ▶ **Registering a Destination in a One-Touch Button(P. 410)**

10 <Options>

Displays all of the function setting buttons. For convenience, you can display frequently used function setting buttons in 11.

11 Function setting buttons

Displays the most frequently used buttons from <Options>. The setting status is displayed on the buttons. You can also press 14 to change which buttons are displayed.

- If the button for the function that you want to use is not displayed, press <Options> and select the desired button. ▶ **Basic Operations for Sending Faxes(P. 524)**

12 Current setting status and setting buttons

Displays setting status such as the resolution. Make sure to confirm the settings in order to scan properly. To change the settings, press the desired button. ▶ **Basic Operations for Sending Faxes(P. 524)**

13 <Favorite Settings>

Register frequently used scan settings here in advance to easily recall them when necessary. ▶ **Registering a Combination of Frequently Used Functions(P. 367)**



Press this icon to register the current settings in <Favorite Settings> of 13 and change the button displayed in 11.

- ▶ **Registering a Combination of Frequently Used Functions(P. 367)**
- ▶ **Customizing the Basic Features Screen(P. 370)**

15 <Previous Settings>

Press to recall the previously specified settings. ▶ **Recalling Previously Used Settings for Sending (Previous Settings)(P. 557)**

16 <To Remote Address Book>

Press to specify destinations in one-touch buttons of other Canon multifunction printers. This button is available only when the Remote Address Book is activated for use. ▶ **<Acquire Remote Address Book>(P. 1316)**

17 <R>

Press to use the R key. ▶ **Basic Operations for Sending Faxes(P. 524)**

NOTE

- You can select whether to hide the Address Book and one-touch buttons to restrict use of the Address Book. ▶ **<Restrict Address Book Use>(P. 1227)**

- Some functions cannot be used in combination with each other. Buttons that cannot be selected are displayed in light gray.
- The total number of specified destinations is displayed on the top right of the screen.

LINKS

▶ **Registering Destinations(P. 389)**

Basic Operations for Sending Faxes

961F-08J

This section describes the basic operations for sending fax documents.

1 Place the original. ▶Placing Originals(P. 39)

NOTE:

- When the screen for selecting the original thickness appears, select the thickness of the original being used. (Appears if <Original Thickness Defaults for Scan from Feeder>is set to <Always Specify>. ▶ <Original Thickness Defaults for Scan from Feeder>(P. 1189))

2 Press <Fax>. ▶<Home> Screen(P. 332)

3 Specify the destination on the Fax Basic Features screen. ▶Fax Basic Features Screen(P. 521)

- ▶Specifying Destinations from the Address Book
- ▶Specifying Destinations from One-Touch Buttons
- ▶Entering Destinations Manually
- ▶Specifying Destinations in the LDAP Server

NOTE:

- To check the detailed information about the specified destination, select the desired destination using ▲ and ▼ and press <Details>. To delete a destination from the specified destinations, press <Delete Dest.>.
- You can only change destinations from <Details> specified using the New Destination and destinations obtained via an LDAP server.
- <ECM TX>, <Sending Speed>, and <Long Distance> do not appear when you specify a destination from the Remote Address Book.
- If the server machine is performing the System Manager information settings, authentication between the server machine and the client machine is performed while the client machine is obtaining the Remote Address Book/one-touch buttons. Authentication is performed by matching the System Manager ID and System Manager PIN set by the server machine and client machine. ▶<Changing the System Manager ID and PIN(P. 840)>

The availability of the Remote Address Book/one-touch buttons depends on the status of the System Manager information settings for the server machine and client machine, as shown below.

When the server machine is performing the System Manager information settings	When the client machine is performing the System Manager information settings	The System Manager ID and System PIN for the server machine and client machine match	Can use the Remote Address Book/One-Touch Button
Performing	Performing	Matches	Yes
		Does Not Match	No
Not Performing	Performing	-	Yes
	Not Performing	-	Yes

Specifying Destinations from the Address Book

1 Press <Address Book>.

2 Select the destination and press <OK>.

- If an access number is set when the destination is registered, press <Access No.> and enter the access number using the numeric keys. The corresponding destination is displayed in the Address Book.
- To use the Remote Address Book, press <To Remote Address Book>. When <Change Address Book> is displayed, press <Change Address Book> ► <Remote>.

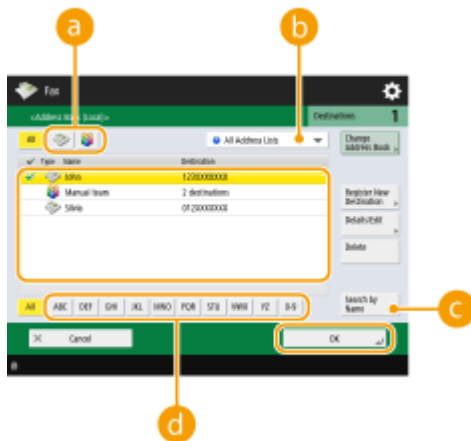

a Destination type buttons

Pressing and displays fax and group destinations, respectively.

b Drop-down list for selection of Address Book types

Enables you to display a specific group of destinations. When you are logged in to the machine with personal authentication management, selecting <Personal Address List> displays your personal Address Book.

c <Search by Name>

Enables you to search the destination by the name you are entering.

d Search buttons by first letter

Enables you to narrow down a search by the first letter of the destination name.

! IMPORTANT

- If you select the group destination containing destinations other than fax destinations, sending a fax is not allowed.

NOTE

- <Register New Destination>, <Details/Edit>, and <Delete> on the <Address Book (Local)> screen can be used to register new destinations, check details, and edit/delete destinations.
- To use the Remote Address Book, it is necessary to configure the server machine settings. Set to open the Remote Address Book externally on the server machine.

Specifying Destinations from One-Touch Buttons

1 Press the desired one-touch button.

- To specify the destination using a one-touch button number (one-touch number), press  and enter the number for the desired one-touch button.
- To use the Remote Address Book, press <To Remote Address Book>.



NOTE

- The destinations registered in the one-touch buttons of the server machine are updated in the following times:
 - When a fax job has been sent on the client machine
 - When you press  (Reset) on the client machine
 - When Auto Reset is activated on the client machine

Entering Destinations Manually

You can specify destinations manually that are not registered in the Address Book or one-touch buttons.

1 Enter a fax number using the numeric keys and press <OK>.

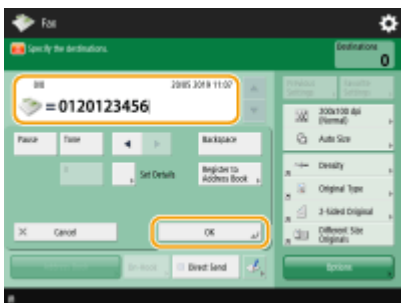

- To add another fax number, repeat this step.
- If the machine is connected to a PBX (Private Branch Exchange), press <R> before entering the destination. If <R> is not available, you need to register the R-key settings.  <R-Key Setting>(P. 1256)

NOTE:

- You can press <Register to Address Book> to register the entered destination. Set the required conditions, and specify <Name> and <Address Book>. For information on the settings, see **▶Registering Destinations in the Address Book(P. 394)** .

NOTE

To send faxes overseas

- Enter the international access number, the country code, and the fax number, in that order. If you cannot successfully connect to the destination overseas, press <Pause> to insert a pause between a number and the next number.

To send faxes with a subaddress

- The machine supports the use of ITU-T* standard subaddresses. If the recipient's fax machine is compatible with the use of ITU-T subaddresses, you can enhance the confidentiality of sent documents using a subaddress and password. To send a document with a subaddress, enter a fax number, press <Subaddress> or <Set Details>, and then enter the subaddress and password.

* Stands for International Telecommunication Union-Telecommunication Standardization Sector, which is the group that makes recommendations towards the standardization of worldwide telecommunications.

Specifying Destinations in the LDAP Server

You can search and specify destinations registered in the LDAP server.

1 Press <Address Book>.

2 Press <To LDAP Server>.

- When <Change Address Book> is displayed, press <Change Address Book> ▶ <LDAP Server>.
- If the network password input screen is displayed, enter the user name and password and press <OK>.

3 Press <Search by Conditions>.

- To display all the destinations in the LDAP server without specifying any conditions, proceed to step 5.

4 Specify the search conditions.



a Search categories

Select a criterion to search for destinations from name, fax number, organization name, and organization unit (department name, etc).

b Search conditions

Select a search condition such as a destination name that contains "John" and a department name that begins with "Development."

c Search characters

Press <Set> and enter search characters for the search condition.

NOTE

To search with multiple conditions

- You can search destinations with multiple conditions. Specify the first search condition, press <Add Search Condition>, and then select <or> or <and> for the next condition.

5 Press <Start Searching>.

⇒ The search results are displayed.

- To search with another condition, press <Delete> to delete the specified settings and then set a new condition.

NOTE

- A maximum of 2,000 destinations can be displayed in the search results.

6 Select the destination and press <OK>.

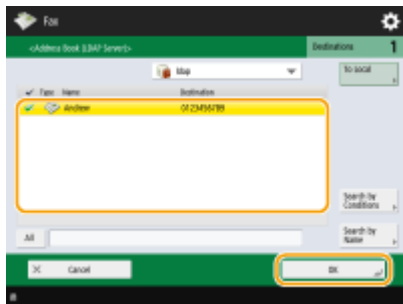

4 Specify the scan settings as necessary.

- ▶ Specifying How to Scan Originals
- ▶ Adjusting Image Quality
- ▶ Enlarging or Reducing
- ▶ Erasing Dark Borders (Erase Frame)

Specifying How to Scan Originals



If you are scanning free size/highly transparent originals, or the edge of image is missing when scanning, you need to manually specify the scanning size.

- ▶ Specifying the Scanning Size of Originals

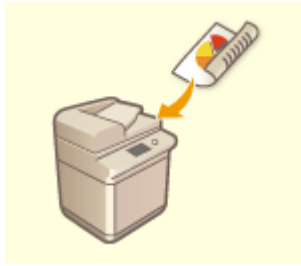

The machine can automatically scan both the front and back sides of an original.
 ▶ Scanning Both Sides of Originals



You can scan two facing pages in a book or magazine onto separate pages in one operation.
 ▶ Scanning a Facing Page Original and Faxing it as Two Separate Pages

■ Specifying the Scanning Size of Originals

1 Press the setting button for scanning size.

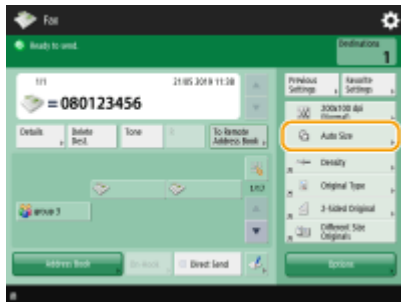

2 Select the scanning size and press <OK>.

- To set the machine to detect the size of the original, select <Auto>.

NOTE:

If <A3+> appears in the scanning size

- If you want to scan an A3 original with an image that extends all the way to the edges without the periphery of the original being cut off, place the original on the platen glass and press <A3+>.

■ When scanning a free size original

Place the original in the feeder and select <Free Size>.

■ When specifying the values of scanning size

Place the original on the platen glass/in the feeder, select <Custom>, and enter the length and width of the original.

NOTE

- When a scanning size smaller than the minimum size that can be scanned with the feeder is set, scanning cannot be performed with the feeder. For information on the document sizes that can be scanned with the feeder, see ▶ **Hardware Specifications(P. 215)** .

■ When scanning a long original

Place the original in the feeder and select <Long Original>.

NOTE

To register the scanning size

- If you frequently specify the scanning size with the same values, register the size in <Custom> ▶ <Register Size> to quickly recall the setting for convenience.

■ Scanning Both Sides of Originals

Place the original in the feeder. For landscape-oriented originals, place them horizontally.

1 Press <Options> ▶ <2-Sided Original>.

2 Select <Book Type> or <Calendar Type> and press <OK>.

- Select <Book Type> for originals whose images on the front and back sides face the same direction, or <Calendar Type> for originals whose images on the front and back sides face in opposite directions.

3 Press <Close>.

■ Scanning a Facing Page Original and Faxing it as Two Separate Pages

NOTE

- When scanning facing pages of a book or bound original, place the original on the platen glass. Place it face down with its corner aligned with the top-left corner of the platen glass, as shown below.



1 Press <Options> ▶ <Book ▶ 2 Pages>.

2 Press <Close>.

Adjusting Image Quality

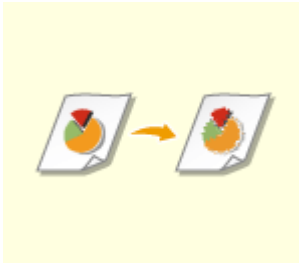

You can select the resolution suitable for your type of original. The higher the resolution is, the clearer the image becomes, but the longer it takes to send.

▶ Selecting Resolution



Specifying the type of original such as documents with characters only or magazines with photographs enables you to send with optimal image quality.

▶ Selecting the Type of Original



You can adjust the density of the entire original. For example, increasing the density enables you to easily read faint characters written in pencil.

▶ Adjusting the Density of the Entire Original



You can adjust the density of the background. You can clearly send originals with a colored background or thin originals such as newspapers whose characters and images on the back side are transparently visible.

▶ Adjusting the Density of the Background



You can scan the image with clear contours and lines by increasing the sharpness, or soften the image by decreasing the sharpness. Use this function when you want to sharpen blurred text and diagrams, or to reduce moire (a shimmering, wavy pattern) to smoothen the finished image.

▶ Adjusting Sharpness (Sharpness)

■ Selecting Resolution

1 Press the setting button for resolution.

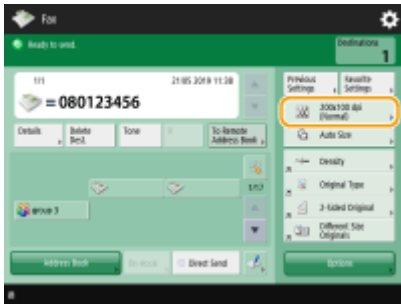

(Items shown on the screen may differ depending on your model and options.)

2 Select the resolution and press <OK>.

- A lower resolution is suitable for originals containing text only, while a higher resolution is suitable for originals containing photographs. The higher the resolution is, the more finely originals can be scanned.

■ Selecting the Type of Original

1 Press <Options> ► <Original Type>.

2 Select the type of original and press <OK>.

- To adjust the text/photo processing priority level, press <Adjust Level> ► select <Text Priority> or <Photo Priority>.

3 Press <Close>.

■ Adjusting the Density of the Entire Original

1 Press <Options> ► <Density>.

2 Adjust the density and press <OK>.

- Press  to decrease the density. Press  to increase the density.

3 Press <Close>.

■ Adjusting the Density of the Background

1 Press <Options> ▶ <Density>.

2 Press <Adjust> in <Background Density>.

- To adjust the background automatically, press <Auto> and proceed to step 4.

NOTE

- When the type of original is set to <Text> (▶ **Selecting the Type of Original(P. 532)**) and <Quality Priority> is specified for <Speed/Image Quality Priority for B&W Scan>, the density of the background is automatically adjusted. ▶ **<Speed/Image Quality Priority for B&W Scan>(P. 1186)**

3 Adjust the density and press <OK>.

- If <-> is pressed, the density of the entire background decreases. If <+> is pressed, the density of the entire background increases.

NOTE

- Depending on the colors of originals, sections other than the background may be affected.

4 Press <OK> ▶ <Close>.

■ Adjusting Sharpness (Sharpness)

NOTE

- The setting for <Sharpness> is invalid when all of the conditions below are met. The setting is reflected in the image displayed for <Preview>, but not for the actual scanned image.
 - <Original Type>: <Text>
 - <Resolution>: <200x100 dpi (Normal)>

1 Press <Options> ▶ <Sharpness>.

2 Adjust the sharpness and press <OK>.

- To sharpen blurred text, adjust the control to <High>.
- To reduce moire when scanning originals that contain printed photos, such as magazines or pamphlets, adjust the control to <Low>.

3 Press <Close>.

Enlarging or Reducing



You can enlarge or reduce standard size originals to other standard sizes when scanning.

▶ Enlarging or Reducing in Standard Paper Sizes



You can enlarge or reduce by specifying magnification (%).

▶ Enlarging or Reducing by Specifying Magnification

■ Enlarging or Reducing in Standard Paper Sizes

1 Press <Options> ▶ <Copy Ratio>.

2 To reduce, select magnification from **a**, to enlarge, select magnification from **b** and press <OK>.

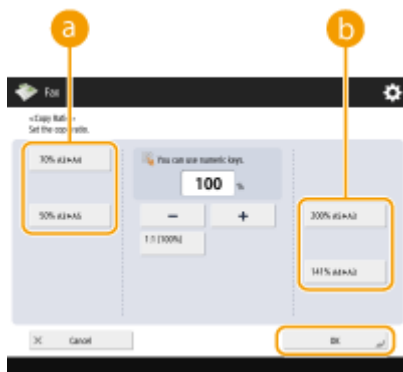

(Items shown on the screen may differ depending on your model and options.)

3 Press <Close>.

■ Enlarging or Reducing by Specifying Magnification

1 Press <Options> ▶ <Copy Ratio>.

2 Specify magnification and press <OK>.



3 Press <Close>.

Erasing Dark Borders (Erase Frame)

When scanning originals that are smaller than the scanning size, frame lines of the originals may appear in the scanned image. When scanning a thick book, dark borders may appear. This function enables you to erase these frame lines and dark borders. You can also set the machine to not copy punch holes in the originals.

! IMPORTANT

- Place the original with punch holes on the platen glass. Placing in the feeder may result in damage.

1 Press <Options> ► <Erase Frame>.

2 Specify the erasing type and width.

■ Erasing the frames of documents

1 Press <Erase Original Frame> and check <Original Size>.

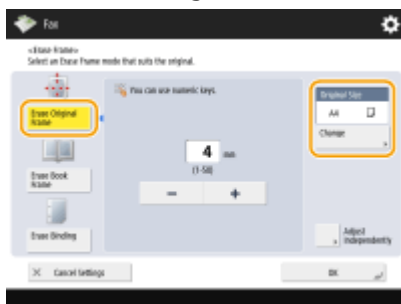

- If the size displayed in <Original Size> is different from the size of the original, press <Change> to select the size. You can only set the Erase Original Frame mode for the original sizes shown on the touch panel display.

2 Enter the width of the frame to erase.

■ Erasing dark borders of books

You can erase the dark borders both in the center and contour lines that appear when you scan facing pages in a book.

- 1 Press <Erase Book Frame> and check <Original Size>.



- If the size displayed in <Original Size> is different from the size of the book, press <Change> to select the size. You can only set the Erase Book Frame mode for the original sizes shown on the touch panel display.

- 2 Press <Center> or <Sides> and enter each erasing width.

■ Erasing punch holes of documents

- 1 Press <Erase Binding> and select the punch hole location.



- 2 Enter the erasing width.

NOTE

- If you want to adjust the width for each border independently, press <Erase Original Frame> or <Erase Book Frame>, and then press <Adjust Independently> to enter the erasing widths.
- If you are using <Erase Binding>, the borders you do not select are also erased by 4 mm.

- 3 Press <OK> ► <Close>.

- 5 Press  (Start).

Originals are scanned and sending starts.

- To cancel scanning, press <Cancel> or  (Stop) ► <Yes>.

■When <Press the [Start] key to scan the next original.> is displayed

Place the next original to scan and press  (Start). When scanning all of the originals is complete, press <Start Sending> to send the fax.

- To cancel sending, see  **Canceling Sending Faxes(P. 540)** .

NOTE

To check the total number of specified destinations

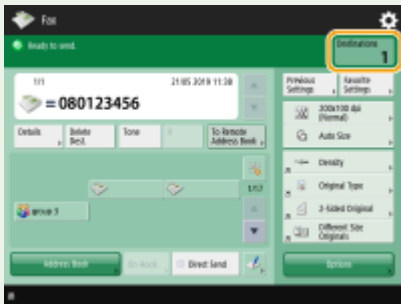

- The total number of specified destinations is displayed on the top right of the screen. This enables you to confirm that the number of destinations is correct before sending.



To send with the sender information

- You can send with the sender's name and fax number.  **<TX Terminal ID>(P. 1230)**

To check the statuses for sent documents

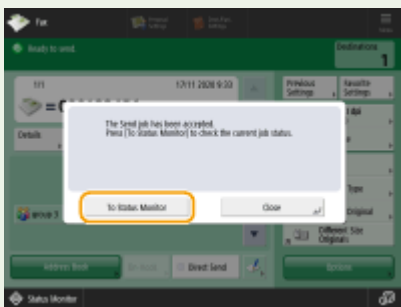

- On the <Status Monitor> screen, you can check the statuses for sent documents. This screen enables you to send faxes again or cancel sending after checking the statuses.  **Checking Status and Log for Sent and Received Documents(P. 574)**
- When <Display Notification When Job Is Accepted> is set to <On>, the <Status Monitor> screen can be displayed from the following screen that is shown after a send job is received.  **<Display Notification When Job Is Accepted>(P. 1237)**



When a transmission error occurs because the recipient's line is busy

- The machine automatically redials after a certain period of time. You can change the settings such as how many times the machine redials and the interval between redials.  **<Auto Redial>(P. 1253)**

To print the report for the results of sending

- On the Fax Basic Features screen, pressing <Options>  **<TX Report>** enables you to set to automatically print the report listing the results of sending.
- To set this for each job from <Options>, it is necessary to select <For Error Only> or <Off> in  **<TX Report>(P. 1228)** , and then set <Allow Printing from Options> to <On>.

When multiple sheets are fed

- Scanning is stopped and the message is displayed on the screen. Follow the instructions to clear the jam. When you have cleared the jam, the resume job screen is displayed. If the machine mistakenly detects multiple sheet feeding, press <Do Not Detect Multi. Sheet Feed> to resume scanning.
- To set the machine in advance to not notify you of multiple sheet feeding, perform one of the following operations.
 - Each time you send, press <Options> on the Fax Basic Features screen ► select <Detect Feeder Multi Sheet Fd.> to disable the setting.
 - Set <Set Detection of Feeder Multi. Sheet Feed as Default> to <Off>. ◀<Set Detection of Feeder Multi. Sheet Feed as Default>(P. 1185)

When photos in the sent image are too dark or light colors in the background of color originals cannot be removed

- The quality of the sent image may be able to be improved if the following conditions/settings are met.
 - Job type: Fax (Memory Sending) or Scan and Send (Fax/I-fax)
 - <Select Color>: <Black & White> (Scan and Send)
 - <Original Type>: <Text>
 - <Density> ► <Background Density>: <Auto>
 - <Resolution>: 200 dpi x 400 dpi, 300 dpi x 300 dpi*, 400 dpi x 400 dpi, or 600 dpi x 600 dpi*
*Can be set for Scan and Send
 - <Speed/Image Quality Priority for B&W Scan> ► Fax/I-Fax Send Jobs: <Quality Priority> (◀<Speed/Image Quality Priority for B&W Scan>(P. 1186))

When multiple telephone lines are set

- You can select the telephone line to use for sending faxes by pressing <Options> ► <Select Line>. For instructions on specifying fax line settings, see ▶<Fax Line Settings(P. 314) .

TIPS

Saving a copy of a sent document

- You can set the machine so that a copy of a sent document is automatically saved in a file server. The copy is converted into an electric file such as PDF and saved, allowing you to easily check the contents from your computer. ▶<Saving a Copy of a Sent Document(P. 562)

Selecting a sender's name

- On the Basic Fax Features screen, pressing <Options> ► <Sender Name (TTI)> enables you to select a name from a list of registered sender's names to include in the sender information. ▶<Register Sender Name (TTI)>(P. 1251)
- If logging in using User Authentication, the login name appears in <100> of Sender Name (TTI).

Checking scanned images before sending

- You can check scanned images on the preview screen before sending. ▶<Checking Scanned Images Before Sending (Preview)(P. 545)

Registering frequently used settings

- You can combine frequently used destinations and scan settings into a button of the machine for later use. By pressing the registered button when scanning originals, you can quickly complete your settings. ▶<Registering a Combination of Frequently Used Functions(P. 367)

LINKS

- ▶ **Canceling Sending Faxes(P. 540)**
- ▶ **Sending Faxes Successfully(P. 544)**
- ▶ **Simplifying Sending Operations(P. 553)**
- ▶ **Useful Functions When Sending(P. 559)**
- ▶ **Registering Destinations(P. 389)**
- ▶ **Registering the LDAP Server(P. 299)**
- ▶ **Managing Users(P. 803)**
- ▶ **<Set Destination>(P. 1310)**

Canceling Sending Faxes

You can cancel scanning originals or sending faxes that are being sent or waiting to be sent.

■ Canceling Scanning Originals

1 Press <Cancel> on the displayed screen or  (Stop).

2 Press <Yes>.

⇒ Scanning originals is canceled.

■ Canceling Sending Faxes Being Sent or Waiting to Be Sent

1 Press <To Status Monitor> on the displayed screen or  (Status Monitor).

2 Press <Send> ► <Job Status>.

3 Select <Fax>.

⇒ A list of jobs being sent or waiting to be sent is displayed.

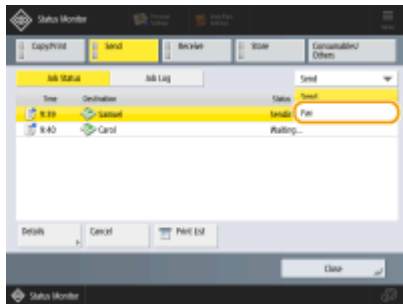

4 Select the job to cancel and press <Cancel>.



5 Press <Yes>.

⇒ Sending the fax is canceled.

NOTE

To immediately cancel a job that is being sent

If you press  (Stop) on the control panel to cancel a fax job while it is being sent, the message <Is it OK to cancel the following Send job?> appears. Press <Yes> to cancel sending the fax.

- You can select <Latest Received Job> or <Job Being Sent> to choose the job to cancel.  **<Job to Cancel When Stop is Pressed>(P. 1237)**
- Press  (Stop) when there are multiple send jobs to display the screen for selecting the send job to cancel. If the send job you want to cancel is not displayed, press <Check Other Jobs> to display <Send Jobs>. Select the job that you want to cancel, and press <Cancel>.

LINKS

 **Basic Operations for Sending Faxes(P. 524)**

 **Checking Status and Log for Sent and Received Documents(P. 574)**

Receiving Faxes

961F-08L

■ When a fax is received

The Processing/Data indicator on the control panel blinks green. When receiving is complete, the document is automatically printed and the indicator turns off.

NOTE

- To cancel receiving, press  (Status Monitor) ▶ <Receive> ▶ <Job Status> ▶ select a document ▶ <Cancel>.

■ Output paper

An incoming fax is printed on the same size of paper as the document size received. When there is no paper matching the size of the received document, the document is printed according to the setting of <Select Drawer>.  <Select Drawer>(P. 1268)

NOTE

To receive fax information services







- Follow the recorded message to enter the service number, and then press <Start RX>.
- If you require more information about the service, contact the company providing the service.

Receiving with a subaddress

- The machine supports the use of ITU-T* standard subaddresses. To receive a document with a subaddress, see  <Forwarding Settings>(P. 1272) .

* Stands for International Telecommunication Union-Telecommunication Standardization Sector, which is the group that makes recommendations towards the standardization of worldwide telecommunications.

TIPS

- You can save paper when printing.
 -  <Print on Both Sides>(P. 1268)
 -  <2 on 1 Log>(P. 1269)
 -  <Reduce Fax RX Size>(P. 1269)
- You can include information, such as reception time, in received documents when printing.  <Print RX Page Footer>(P. 1270)
- If you set the machine to check a reception password for subaddress communication, you can prevent the machine from receiving spam faxes.  <RX Password>(P. 1280)
- Setting <Forward Temporarily Stored File to Memory RX Inbox> to <Yes> enables you to forward received documents to the storage location of the machine (Memory RX Inbox) if they cannot be printed due to paper jams or lack of paper. In this case, <Fax Memory Lock>/<Use I-Fax Memory Lock> is automatically set to <On>, and forwarded documents can be checked from the screen. Also, forwarded documents can be printed later. ( <Saving Received Documents in the Machine (Memory Reception)>(P. 566)) To return to normal printing, set <Fax Memory Lock>/<Use I-Fax Memory Lock> to <Off>.

LINKS

- ▶ **Various Receiving Methods(P. 565)**
- ▶ **Forwarding Received Documents Automatically(P. 571)**
- ▶ **Checking Status and Log for Sent and Received Documents(P. 574)**

Sending Faxes Successfully

961F-08R

This section describes how to avoid potential sending errors caused by incorrectly scanning documents or a busy line, etc.



▶ **Checking Scanned Images Before Sending (Preview)(P. 545)**



▶ **Checking the Connection to the Recipient Before Sending (Direct Send)(P. 547)**



▶ **Sending Faxes Manually (Manual Sending)(P. 549)**

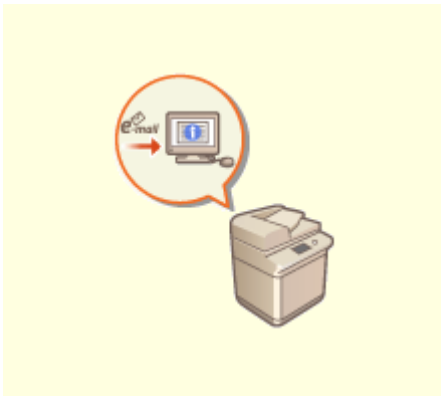

▶ **Notifying You by E-Mail of the Completion of Sending(P. 551)**

Checking Scanned Images Before Sending (Preview)



961F-08S



You can check scanned images on the preview screen before sending. You can also delete, move, or switch pages on the preview screen.

NOTE

- The original cannot be checked before sending with the Direct Sending or Manual Sending mode, even if <Preview> is set.

- 1 Place the original.** ▶ **Placing Originals(P. 39)**
- 2 Press <Fax>.** ▶ **<Home> Screen(P. 332)**
- 3 Specify the destination on the Fax Basic Features screen.** ▶ **Fax Basic Features Screen(P. 521)**
- 4 Specify the scan settings as necessary.** ▶ **Basic Operations for Sending Faxes(P. 524)**
- 5 Press <Options> ▶ <Preview> ▶ <Close>.**
- 6 Press  (Start).**
 - ⇒ Originals are scanned and the preview screen appears.
 - To cancel scanning, press <Cancel> or  (Stop) ▶ <Yes>.

■When <Press the [Start] key to scan the next original.> is displayed

Place the next original to scan and press  (Start). When scanning all of the originals is complete, press <Preview and Send> to display the preview screen.
- 7 Check the scanned images on the preview screen.**
 - Edit the scanned image on the preview screen as necessary.

■ To delete a page

You can delete the page currently displayed on the preview screen.

- 1 Press <Delete Page>.

■ To move a page

You can move a page to the specified destination.

- 1 Press <Edit Scanned Data>.
- 2 Press <Move Page Position>.
- 3 Enter the page numbers corresponding to <Move Page> and <Behind Page>.
- 4 Press <OK>.

■ To switch the locations of pages

You can switch the locations of specified pages.

- 1 Press <Edit Scanned Data>.
- 2 Press <Switch Page Position>.
- 3 Enter the page numbers corresponding to <Target Page A> and <Target Page B>.
- 4 Press <OK>.

8 Press <Start Sending>.

▣▣▣▣ Sending starts.

Checking the Connection to the Recipient Before Sending (Direct Send)



To successfully send faxes to the destination you intend, you can check beforehand that the recipient is connected and ready to start communication. As the machine bypasses memory when scanning originals, you can send faxes even if there is no memory available.

1 Place the original. ▶ Placing Originals(P. 39)

- To send multiple pages, place the originals in the feeder. When the original is placed on the platen glass, only one page can be sent.

2 Press <Fax>. ▶ <Home> Screen(P. 332)

3 Specify the destination on the Fax Basic Features screen. ▶ Fax Basic Features Screen(P. 521)

4 Specify the scan settings as necessary. ▶ Basic Operations for Sending Faxes(P. 524)

5 Press <Options> ▶ <Direct Send> ▶ <Close>.

6 Press (Start).

⇒ The machine dials the recipient's number. When the machine connects the call, originals are scanned and sending starts.

- The machine does not start sending when the recipient's line is busy.

IMPORTANT

Direct Send is not available in the following cases

- When any of the following functions is specified in the scan settings:
 - <2-Sided Original>
 - <Different Size Originals>
 - <Erase Frame>
 - <Job Build>
 - <Delayed Send>

(The functions that can be specified differ depending on your model.)

- Multiple destinations are specified.

- <Limit Functions> is set to <Off> for any function when the machine is in the Department ID mode.  **Configuring the Department ID Management Settings(P. 842)**

NOTE

To specify the scanning size of originals

- The scanning size of originals placed in the feeder is automatically set. To specify the size yourself, use the platen glass.

Sending Faxes Manually (Manual Sending)

961F-08W



You can manually send fax documents after checking that the destination is ready to receive fax transmissions.

NOTE

- If you have added additional lines, you can only use Line 1 (the standard line) for manual sending.
- To send fax documents manually by pressing <On-Hook>, set <Use ACCESS MANAGEMENT SYSTEM> to <Off>. If it is set to <On>, you may not be able to send documents. ▶ **Using ACCESS MANAGEMENT SYSTEM(P. 849)**
- If the control card is removed while a call is being made by pressing <On-Hook> with the Copy Card Reader attached, the line is disconnected.

1 Place the original. ▶ **Placing Originals(P. 39)**

- When you want to send multiple pages, place originals in the feeder. When the original is placed on the platen glass, you can only send one page.

2 Press <Fax>. ▶ **<Home> Screen(P. 332)**

3 Press <On-Hook> on the Fax Basic Features screen. ▶ **Fax Basic Features Screen(P. 521)**

4 Enter the recipient's phone number.

5 Make sure that you hear the recipient or a high-pitched tone.

6 Press (Start).

⇒ Originals are scanned and sending starts.

IMPORTANT

Manual Sending is not available in the following cases

- When any of the following functions is specified in the scan settings:
 - <2-Sided Original>

- <Different Size Originals>
- <Erase Frame>
- <Job Build>
- <Delayed Send>

(The functions that can be specified differ depending on your model.)

- <Limit Functions> is set to <Off> for any function when the machine is in the Department ID mode. 
- Configuring the Department ID Management Settings(P. 842)**

NOTE

To specify the scanning size of originals

- The scanning size of originals placed in the feeder is automatically set. To specify the size yourself, use the platen glass.

Notifying You by E-Mail of the Completion of Sending

961F-08X



You can receive an e-mail notifying you that sending documents is complete. Even if documents are waiting to be sent, you can use your computer or portable device to check whether sending documents is complete, giving you reassurance. When an error occurs, you are notified of destinations whose documents failed to be sent.

! IMPORTANT

- To select the destination to notify from <Address Book>, it is necessary to register the destination in advance. ▶ **Registering Destinations in the Address Book(P. 394)**
- To select <Send to Myself> as the destination to notify, it is necessary to register your e-mail address in the user information in advance, and log in using personal authentication management. ▶ **Registering User Information in the Local Device(P. 809)**

- 1 Place the original.** ▶ **Placing Originals(P. 39)**
- 2 Press <Fax>.** ▶ **<Home> Screen(P. 332)**
- 3 Specify the destination on the Fax Basic Features screen.** ▶ **Fax Basic Features Screen(P. 521)**
- 4 Specify the scan settings as necessary.** ▶ **Basic Operations for Sending Faxes(P. 524)**
- 5 Press <Options> ▶ <Job Done Notice>.**
- 6 Select the notification timing, and set the destination to notify.**



- If you select <Notice for Any Result>, a notification e-mail is sent for each send job. If you select <Notice Only for Errors>, a notification e-mail is sent only when an error occurs.
- For more information on how to view and use the Address Book, see ▶ **Address Book(P. 389)** .

- If you want to check the content of the sent document, select <Attach TX Image> to attach the first page of the document as a PDF file to a notification e-mail.

7 Press <OK> ► <Close>.

8 Press  (Start).

- Originals are scanned and sending starts. When sending is complete, the notification e-mail is sent to the specified address.

Simplifying Sending Operations

961F-08Y

You can scan different size originals at once or send separately scanned documents together. By recalling previously used settings, you can simplify sending operations.

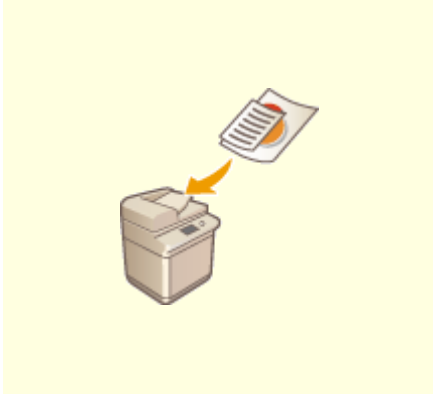

▶ **Sending Different Size Originals Together (Different Size Originals)**
(P. 554)



▶ **Sending Separately Scanned Documents Together (Job Build)**
(P. 555)



▶ **Recalling Previously Used Settings for Sending (Previous Settings)**(P. 557)

Sending Different Size Originals Together (Different Size Originals)

961F-090



You can place different size originals in the feeder and scan them at the same time. This eliminates the need to place originals separately.

! IMPORTANT

- The combination of original sizes that you can scan is limited. Scanning with an improper combination may cause damage to the originals or paper jams. ▶ **Hardware Specifications(P. 215)**
- Do not place the originals together that are of different weights or paper types. Doing so may cause damage to the originals or paper jams.

- 1 Place the originals in the feeder** ▶ **Placing Originals(P. 39)**
- 2 Press <Fax>.** ▶ **<Home> Screen(P. 332)**
- 3 Specify the destination on the Fax Basic Features screen.** ▶ **Fax Basic Features Screen(P. 521)**
- 4 Specify the scan settings as necessary.** ▶ **Basic Operations for Sending Faxes(P. 524)**
- 5 Press <Options> ▶ <Different Size Originals>.**
- 6 Press <Close>.**
- 7 Press  (Start).**

⇒ Originals are scanned and sending starts.

NOTE

- If you set the Different Size Originals mode, the scanning speed may be slower than normal.

Sending Separately Scanned Documents Together (Job Build)

961F-091



Even if you have too many originals to be placed in the feeder at the same time, you can scan the originals separately and send them as a batch of documents. Documents scanned with both the feeder and the platen glass can also be sent at the same time.

- 1** Place the first original. ▶ **Placing Originals(P. 39)**
- 2** Press <Fax>. ▶ **<Home> Screen(P. 332)**
- 3** Specify the destination on the Fax Basic Features screen. ▶ **Fax Basic Features Screen(P. 521)**
- 4** Specify the scan settings as necessary. ▶ **Basic Operations for Sending Faxes(P. 524)**
- 5** Press <Options> ▶ <Job Build> ▶ <Close>.
- 6** Press ◀▶ (Start) to scan the original.

⇒ When scanning is complete, the screen appears prompting you to scan the next original.

NOTE:

- If you place your originals in the feeder, remove the originals from the original output area when the scanning of each batch is complete.

- 7** Place the next original and press ◀▶ (Start).

- Repeat this step until you finish scanning all of the originals.
- To change the scan settings, press <Change Settings>.

NOTE:

- The following functions can be used in <Change Settings>. You cannot change the setting for the other functions while in the Job Build mode. You need to specify the necessary scan settings in advance.
 - <Scan Size>
 - <2-Sided Original>
 - <Density>

- <Original Type>
- If you want to place different size originals in the feeder, set <Different Size Originals>. **▶ Sending Different Size Originals Together (Different Size Originals)(P. 554)**
- When scanning and sending 1-sided originals and 2-sided originals together, if the first document you scan is a 2-sided original, set <2-Sided Original>. When scanning a 1-sided original, disable the <2-Sided Original> setting in <Change Settings>.

8 Press <Start Sending>.

- ▣ All scanned documents are combined into one and sent to the specified destination.

Recalling Previously Used Settings for Sending (Previous Settings)

961F-092



You can recall the destinations specified in the past. Their scan settings such as density are also recalled at the same time.

NOTE

- You can store a series of destination, scan, or send settings specified before pressing  (Start) as a single group of Previous Settings.
- The three most recent settings that were stored in memory are not deleted even when the main power is turned Off.
- When you use fax information services, you cannot specify a destination that is stored in the Address List or use the Job Recall mode.

1 Place the original.  **Placing Originals(P. 39)**

2 Press <Fax>.  **<Home> Screen(P. 332)**

3 Press <Previous Settings> on the Fax Basic Features screen.  **Fax Basic Features Screen(P. 521)**

4 Select the log to recall and press <OK>.



⇒ The destination and its scan settings are specified according to the selected log.

- When personal authentication management is in use, the machine recalls the settings specified in the past by the user who are logging in to the machine.
- You can change the recalled settings before sending.

5 Press (Start).

- ▣ Originals are scanned and sending starts.
- If you set <Manage Address Book Access Numbers> to <On>, you cannot recall settings from memory.
- If you set any address type to <On> in <Limit New Destination>, the currently stored Previous Settings are deleted.

LINKS

Managing Users(P. 803)

Useful Functions When Sending

961F-093

This section describes how to send a document at a specified time and how to save a copy of a fax document in an external file server.



▶ Sending at a Specified Time(P. 560)

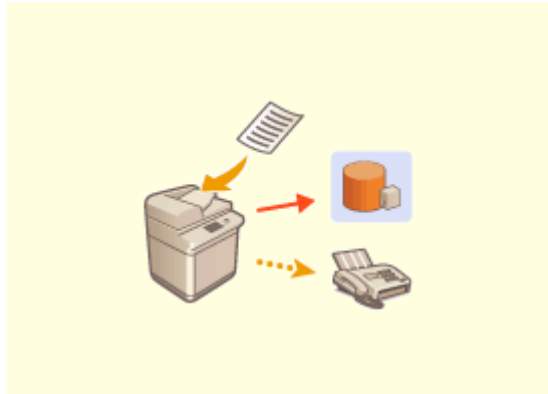

▶ Saving a Copy of a Sent Document(P. 562)

Sending at a Specified Time

961F-094



You can scan originals in advance and send the scanned documents at a specified time.

- 1 Place the original. ▶ [Placing Originals\(P. 39\)](#)
- 2 Press <Fax>. ▶ [<Home> Screen\(P. 332\)](#)
- 3 Specify the destination on the Fax Basic Features screen. ▶ [Fax Basic Features Screen\(P. 521\)](#)
- 4 Specify the scan settings as necessary. ▶ [Basic Operations for Sending Faxes\(P. 524\)](#)
- 5 Press <Options> ▶ <Delayed Send>.
- 6 Enter the time to send and press <OK>.
 - Enter all four digits of the time. For example, for 5 minutes past 7, enter "0705" and for 18 minutes past 23, enter "2318."

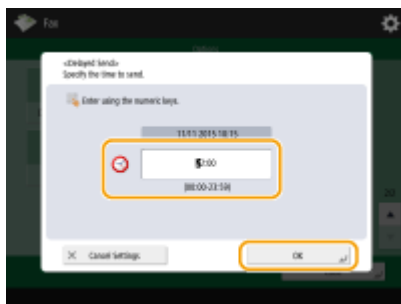

- 7 Press <Close>.
- 8 Press  (Start).

⇒ Originals are scanned and sent at the specified time.

NOTE

- You can check on the <Status Monitor> screen whether sending is complete or not. [▶Checking Status and Log for Sent and Received Documents\(P. 574\)](#)

LINKS

- ▶[Notifying You by E-Mail of the Completion of Sending\(P. 551\)](#)

Saving a Copy of a Sent Document

961F-095



You can save a copy of a sent fax in a pre-specified destination (e-mail or file server, etc.). Depending on the destination, the saved fax copy is converted into another digital file format such as PDF, thus keeping documents organized and manageable. This method also helps you easily manage logs because a folder categorized by sender name or date is automatically created in the specified destination on the server.

! IMPORTANT

- A copy of a document is saved even if a sending error occurs.
- Depending on the type of destination, the following restrictions may apply.
 - E-Mail: An e-mail without a message is sent.
 - Fax/I-Fax: The sent fax cannot be saved as an electronic file.

Registering the Storage Location and File Format

In order to back up fax documents, it is necessary to register settings such as the storage location and file format in advance.

! IMPORTANT

- You cannot perform Direct Sending if you set <Archive TX Document> to <On>.
- This setting automatically switches to <Off> in the following cases. Specify the destination again or return the setting to <On> as required.
 - When the backup destination has been deleted from the address book
 - When an address book has been imported from the Remote UI **▶ Importing/Exporting the Setting Data(P. 946)**
 - When an address book has been received from <Device Information Distribution Settings> **▶ Distributing the Device Information to Other Canon Multifunction Printers(P. 1005)**

1 Press **⚙** (Settings/Registration) ▶ <Function Settings> ▶ <Send> ▶ <Common Settings> ▶ <Archive TX Document>.

2 Press <On> for <Use TX Document Archiving>.

3 Press <Backup Location> ▶ select the destination ▶ press <OK>. **▶ Registering Destinations in the Address Book(P. 394)**

NOTE

- A destination in <Personal Address List> cannot be specified as the destination.

4 Press <Folder Name> ► set how to organize the created folders ► press <OK>.

- You can select <Sender Information>, <Date>, or <Off> to categorize folder names.
- File names are specified by send date and time, job number, sender information, destination information, and result information.

Example: 201603151005_0050_John_1112223333_OK.pdf

NOTE

Sender information

- Information regarding the sender is displayed in the following situations.
 - Sender Name: When <Sender Name (TTI)> is set to <W/Settings>
 - User Name: When <Sender Name (TTI)> is set to <No Settings>, and the user is authenticated
 - Line Name: When <Sender Name (TTI)> is set to <No Settings>, the user is not authenticated, and the user name is registered for the line used to send the fax
 - Telephone Number: When <Sender Name (TTI)> is set to <No Settings>, the user is not authenticated, and the user telephone number is registered, but the user name is not registered, for the line used to send the fax
 - ----: When none of the above information is available

Destination information

- Information regarding the destination is displayed in the following situations.
 - Destination Unit Name: When the destination unit name is available
 - Telephone Number: When the destination unit name is not available
 - Destination name of first successful sending: When performing a sequential broadcast transmission

5 Press <File Format> ► select the file format for saving the sent data.



6 Press <OK>.

- Registration is complete.

TIPS

Specifying multiple destinations including a fax destination

- You can save a copy of a sent document by sending to multiple destinations which include a fax destination from the Scan Basic Features screen. To display fax destinations on the Scan Basic Features screen, it is necessary to set <Enable Fax in Scan and Send Function> to <On>.  **<Display Fax Function>(P. 1065)**

LINKS

 **Basic Operations for Sending Faxes(P. 524)**

Various Receiving Methods

961F-096

The machine can be set to temporarily save received documents in it without printing. By checking and selecting documents you want to print, you can save paper. There is also a function to receive and keep confidential documents private.

NOTE

- If image files attached to received I-fax documents are not compatible with this machine, the machine does not process (print, forward, or store) these files. The files are deleted instead. In this case, the names of the deleted files and the message "No programs can process the file attachment." are printed with the text of the received I-fax.

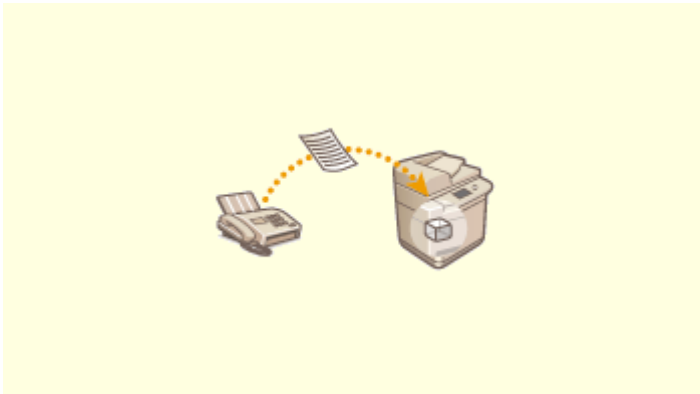

▶ **Saving Received Documents in the Machine (Memory Reception)(P. 566)**



▶ **Keeping Received Documents Private(P. 569)**

Saving Received Documents in the Machine (Memory Reception)

961F-097



You can have incoming documents saved in the storage location (Memory RX Inbox) of the machine without printing. By printing just what you need and deleting unnecessary documents such as direct mails from the Memory RX Inbox, you can save paper.

- ▶ **Saving in the Memory RX Inbox(P. 566)**
- ▶ **Printing Documents in the Memory RX Inbox(P. 566)**

Saving in the Memory RX Inbox

To use this function, you need to activate the memory reception function first (▶<Use Fax Memory Lock>(P. 1275) and ▶<Use I-Fax Memory Lock>(P. 1275)), and then follow the procedure below to specify the settings so that incoming documents can be received in memory.

- 1 Press <Fax/I-Fax Inbox>. ▶<Home> Screen(P. 332)**
- 2 Press <Memory RX Inbox>.**
 - If the password is set for the Memory RX Inbox, the screen appears prompting you to enter the password (▶<Memory RX Inbox PIN>(P. 1274)). Enter the password and press <OK>.
- 3 Select <Memory RX Inbox> and set <Fax Memory Lock> to <On>.**
 - To receive I-faxes in memory, set <I-Fax Memory Lock> to <On>.

Printing Documents in the Memory RX Inbox

When the Processing/Data indicator on the control panel maintains a steady green, follow the following procedures to check/print saved documents.

- 1 Press <Fax/I-Fax Inbox>. ▶<Home> Screen(P. 332)**
- 2 Press <Memory RX Inbox>.**

NOTE

Divided Data RX Inbox

Pressing <Divided Data RX Inbox> enables you to check the receive status of an I-fax that has been divided into several parts before being sent, and the remaining capacity of the Divide Data RX Inbox. The following can be performed using <Divided Data RX Inbox>.

- Pressing <Divided Data List> enables you to check the document list.
- Pressing <Delete> enables you to delete a document that was divided and sent. Selecting <Print When Deleted> enables you to set the machine to print the divided received data document when it is deleted.

3 Select <Memory RX Inbox>.

⇒ A list of saved documents is displayed.

4 Select a document to print and press <Print>.

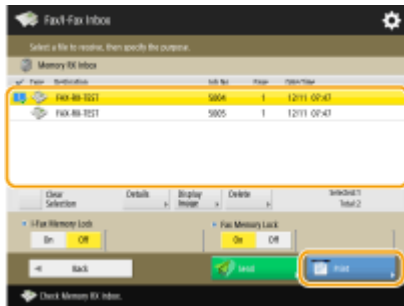

- Pressing <Details> enables you to check information about the document, including senders' names and the number of pages received. Pressing <Display Image> enables you to check the contents of the document as well as select and delete pages.
- Pressing <Delete> ► <Yes> deletes the document. You cannot delete multiple documents simultaneously. To delete multiple documents, select and delete one document at a time.
- Pressing <Send> enables you to specify destinations to send the document. To delete the document from the Fax/I-Fax Inbox after sending, press <Delete File After Sending> before sending.
- Pressing <Select All (Max 32 Files)> enables you to select the documents at once. When a document is selected, <Clear Selection> is displayed enabling you to clear all selections.

NOTE

- To print all the documents in memory, press <Off> for <Fax Memory Lock> or <I-Fax Memory Lock>. You can skip step 5.
- You cannot print multiple documents simultaneously. To print multiple documents, select and print one document at a time.

5 Press <Start Printing>.

⇒ Once a document is printed, it is automatically deleted from memory.

TIPS

- You can specify a day of the week or the time such as on weekends or night time during which received documents are saved in memory. ▶<Memory Lock Start Time>(P. 1275) and ▶<Memory Lock End Time>(P. 1276)
- Registering an arbitrary level of the Memory RX Inbox to the <Personal>/<Shared> button enables operations to be executed quickly and efficiently.

NOTE

- The Fax/I-Fax Inbox storage space is shared with Mail Boxes. For information on the maximum space, see the capacity for [▶Mail Box\(P. 1585\)](#) .

LINKS

- ▶[Basic Operations for Sending Faxes\(P. 524\)](#)
- ▶[Sending I-Faxes\(P. 583\)](#)
- ▶[Basic Operations for Scanning Originals\(P. 640\)](#)

Keeping Received Documents Private

961F-098



This function is to save in the specified storage location (Confidential Fax Inbox) the received documents that match specific conditions. The Confidential Fax Inbox contains multiple boxes, and each box can be protected by password. By specifying a condition such as saving all documents from Company A in Box No. 10, you are allowed to only check the documents you need. This function also enables you to prevent unauthorized persons from seeing confidential documents unintentionally by setting a password. When the Processing/Data indicator on the control panel maintains a steady green, follow the following procedures to check/print saved documents.

! IMPORTANT

To use this function

- Some settings such as the save location and password for documents need to be registered beforehand.
- ▶ **Forwarding Received Documents Automatically**(P. 571)
- ▶ **<Set/Register Confidential Fax Inboxes>**(P. 1273)

1 Press **<Fax/I-Fax Inbox>**. ▶ **<Home> Screen**(P. 332)

2 Press **<Confidential Fax Inbox>**.

3 Select the box where documents are saved.

- If the password is set for the box, the screen appears prompting you to enter the password. Enter the password and press **<OK>**.
- ⇒ A list of saved documents is displayed.

4 Select the document to print and press **<Print>**.

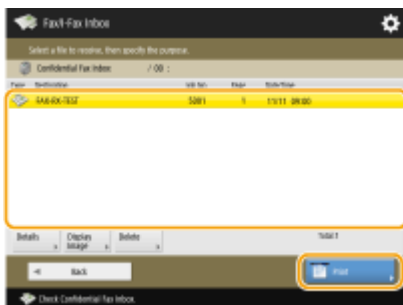

- Pressing **<Details>** enables you to check information about the document, including senders' names and the number of pages received.
- Pressing **<Display Image>** enables you to check the contents of the document as well as select and delete pages.

- Pressing <Delete> ► <Yes> deletes the document. You cannot delete multiple documents simultaneously. To delete multiple documents, select and delete one document at a time.

NOTE:

- You cannot print multiple documents simultaneously. To print multiple documents, select and print one document at a time.

5 Press <Start Printing>.

- To delete the document to print, press <Delete File After Printing> before printing.
 ▣▣▣▣ Printing starts.

TIPS

- You can set to receive the URL of the save location by e-mail when receiving documents. Just entering the URL in the address bar of a Web browser enables you to check the contents of documents from your computer through the Remote UI. ▶<Set/Register Confidential Fax Inboxes>(P. 1273)
- Registering an arbitrary level of Fax Inboxes to the <Personal>/<Shared> button enables operations to be executed quickly and efficiently.

LINKS

- ▶<Managing the Machine from a Computer (Remote UI)>(P. 900)

Forwarding Received Documents Automatically

961F-099



You can set to forward received documents to specified destinations. Fax numbers as well as e-mail addresses and shared folders in computers can be specified as forwarding destinations.

Forwarding All Documents Automatically (Forwarding All)

The machine forwards all received documents to specified destinations. This method is useful when you want to get faxes even if you are out of the office. You can also set to print forwarded documents or receive an e-mail notifying you that forwarding documents is complete.

Forwarding Automatically by Specified Conditions (Conditional Forwarding)

The machine forwards received documents that only match the specific conditions, such as sender's fax number and received dates/times. For example, you can set conditions such as forwarding documents from Company A to all branch offices and forwarding documents received on holidays to e-mail addresses. Just like with the Forwarding All method above, you can also set to print forwarded documents or receive an e-mail notifying you that forwarding documents is complete.

Configuring Forwarding Settings

To use automatic forwarding, it is necessary to specify the forwarding destination and file format, etc., in advance.

- 1 Press  (Settings/Registration) ▶ <Function Settings> ▶ <Receive/Forward> ▶ <Common Settings> ▶ <Forwarding Settings>.

NOTE

- You can also display the <Forwarding Settings> screen by pressing <Dest./Forwarding Settings>( <Home> Screen(P. 332)) ▶ <Forwarding Settings>.

- 2 Press <Register>.

- 3 Press <Condition Name> and enter the name.

- 4 Press <Conditions> and specify the conditions for the destinations to forward.

- A document will be forwarded if it is received from a destination that meets the conditions specified here.

Example: Forwarding a fax from 1111111111

- <Receive Method>: <Fax: Line Shared>
- <Fax Number>: Select <Equals> from the drop-down list and enter "1111111111."

Example: Forwarding an I-fax to xxxxx@canon.com

- <Receive Method>: <I-Fax>
- <To>: Select <Equals> from the drop-down list and enter "xxxxx@canon.com".

NOTE

- If you have added lines, you can also specify a particular line. In this case, select <Fax: Line 1>, etc. for <Receive Method>.
- You cannot change <Receive Method> after registering <Forwarding Settings>. To use forwarding settings with <Receive Method> changed, you have to register the forwarding settings again.

5 Press <Forwarding Destination> and specify the destination to forward to. ▶ Registering Destinations in the Address Book(P. 394)

- To specify a registered destination, press <Address Book> ▶ select the address list that includes the destination from the address list drop-down list.

NOTE

- You cannot specify a destination in <Personal Address List> or a destination in a user group address list as the forwarding destination.
- A destination in <Personal Address List> cannot be specified as the forwarding destination.
- When the Remote Address Book is activated for use, forwarding destinations can also be selected from a remote address book.
- ▶<Acquire Address Book>(P. 1318)
- ▶<About the Address Books of the Machine(P. 391)
- You can store received fax/I-fax files in the Confidential Fax Inbox by specifying it as a forwarding destination.
- If a Confidential Fax Inbox is selected as the forwarding destination, the following settings cannot be used.
 - File Name
 - Store/Print Received File
 - Forwarding Done Notice
 - File Format
- If you select a fax number as the forwarding destination, the subaddress and password registered in the Address Book are ignored.

6 Press <OK>.

- This completes the registration.

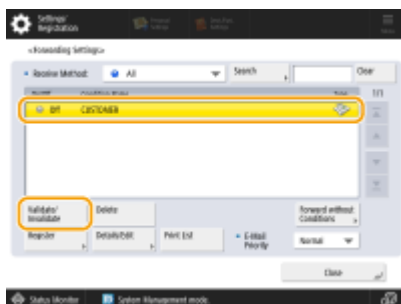

7 Select the registered forwarding settings and press <Validate/Invalidate> to switch the forwarding conditions to <On>.



IMPORTANT

- When a forwarding destination is deleted from the address book, <Validate/Invalidate> automatically switches to <Off>. To resume forwarding with the same conditions, specify the destination again and switch the forwarding conditions to <On>.

NOTE

- You cannot specify a WebDAV server as an I-fax forwarding destination.
- If you specify a destination for which <Confirm Before Sending> is enabled as a forwarding destination, the screen to enter the password does not appear. The registered password is used and forwarding is performed.  **Registering Destinations(P. 389)**
- Documents with forwarding errors are handled according to the  **<Handle Files with Forwarding Errors>(P. 1271)** settings.
- You can store up to 1,000 forwarding settings.

TIPS

- Selecting <Forward without Conditions> enables you to forward all received documents that do not meet the specified conditions to the desired destination.
- You can forward to multiple destinations by specifying a group destination in <Forwarding Destination>.
 - Machines that allow mail boxes to be registered in group destinations:
When you specify a group destination that includes mail boxes, documents are not forwarded to the mail boxes.
- <Specify Fwd. Time> enables you to specify the time and day to perform forwarding.
- If you set <Forwarding Done Notice>, you can send a notification that forwarding was performed. You can select <Notice Only for Errors>, so that you are not notified of a successful forwarding.
- If you set <Store/Print Received File> to <On>, you can store or print the received file by following the Memory Lock settings. The received file is stored if Memory Lock is <On> and it is printed if Memory Lock is <Off>.

Checking Status and Log for Sent and Received Documents

961F-09A

You can check the statuses and communication logs for sent and received documents.

- ▶ **Checking the Statuses for Sent Documents(P. 574)**
- ▶ **Checking the Statuses for Received Documents(P. 575)**
- ▶ **Checking If Documents Are Sent or Received Successfully(P. 575)**

NOTE

- When personal authentication management is used, you can restrict users from performing operations on the jobs of other users on the <Status Monitor> screen. ▶ **<Restrict Access to Other User Jobs>(P. 1339)**

Checking the Statuses for Sent Documents

1 Press  (Status Monitor).

2 Press <Send> ▶ <Job Status>.

- To display only fax documents, select <Fax> from the drop-down list in the upper-right of the screen.

3 Check the statuses.

- Selecting a document and pressing <Details> enables you to check detailed information such as the destinations and the number of pages.
- Selecting a document and pressing <Cancel> enables you to cancel sending. You cannot select multiple jobs and cancel them all at once. Select and cancel one job at a time.
- Pressing <Print List> prints a status list of sent documents displayed on the screen.

NOTE

- Pressing <Details> ▶ <Resend> enables you to resend the documents that failed to send. To specify another destination, press <Change Destination>. For documents with multiple destinations specified using the same sending method, press <Broadcast List>, select a destination, and then press <Resend> or <Change Destination>.
- You can resend documents when <Delete Failed TX Jobs> is set to <Off> (▶ **<Delete Failed TX Jobs>(P. 1231)**). Note that you cannot resend the documents sent with Direct Send/Manual Sending/PC fax.
- You can change the destinations of documents that are set to be sent at a specified time as well as documents that failed to send. Note that you cannot change the destinations for documents with multiple destinations specified that are being sent, or when entering a new destination is restricted (▶ **Limiting Available Destinations(P. 882)**).
- The destination can be changed for a job that is canceled because of transmission errors, or a job that is waiting to be sent in the Delayed Send mode.

- You cannot change multiple destinations at one time. Also, you cannot change the destinations in a group at one time.

Checking the Statuses for Received Documents

1 Press  (Status Monitor).



2 Press <Receive> ► <Job Status>.

- To display only fax documents, select <Fax> from the drop-down list in the upper-right of the screen.

3 Check the statuses.

- Selecting a document and pressing <Details> enables you to check detailed information such as the sender's names and the number of pages.
- Selecting a document and pressing <Cancel> enables you to cancel receiving. You cannot select multiple jobs and cancel them all at once. Select and cancel one job at a time.
- If you press <Check I-Fax RX>, reception starts if an I-fax has been received by the POP server. You can display <Check I-Fax RX> by selecting <Forward> from the drop-down list on the top right of the screen.

NOTE

- To use <Check I-Fax RX>, set <POP> to <On> in <Communication Settings> to enable the machine to receive via POP.  **Setting E-mail/I-Fax Communication(P. 316)**
- You can automatically receive I-faxes in the following cases:  **Setting E-mail/I-Fax Communication(P. 316)**
 - <POP Interval> in <Communication Settings> is set to a value other than '0'.
 - I-faxes are received with SMTP without going via a server.

Checking If Documents Are Sent or Received Successfully

1 Press  (Status Monitor).

2 Press <Send> or <Receive> ► <Job Log>.

- To display only fax documents, select <Fax> from the error code list at the top right of the screen.

3 Check if documents are sent or received successfully.

- <OK> is displayed in the <Result> column when a document was sent or received successfully. If <NG> is displayed, this shows that a document failed to be sent or received because it was canceled or there was some error.
- You can check the error code by selecting a document and pressing <Details>. You can check the causes and solutions for errors based on error codes.  **Countermeasures for Each Error Code(P. 1469)**

- Pressing <Communic. Mgt. Report> or <Fax Activity Report> prints a log list of sent and received documents displayed on the screen.

TIPS

Registering an address from the send history

- You can register an address to the Address Book or a one-touch button via the send history on the <Status Monitor> screen. This saves you the effort of directly entering the fax number, and also helps avoid sending a fax to an incorrect number due to entering the wrong fax number.
- ▶ **Registering Destinations in the Address Book(P. 394)**
 - ▶ **Registering a Destination in a One-Touch Button(P. 410)**

LINKS

- ▶ **Sending at a Specified Time(P. 560)**
- ▶ **Checking the Connection to the Recipient Before Sending (Direct Send)(P. 547)**
- ▶ **Sending Faxes Manually (Manual Sending)(P. 549)**
- ▶ **Sending Faxes from Your Computer (PC Fax)(P. 577)**
- ▶ **Printing a List of Usage History(P. 1027)**
- ▶ **Outputting a Communication Result Report(P. 1029)**

Sending Faxes from Your Computer (PC Fax)

961F-09C

You can send fax documents created on your computer directly from your computer, just like printing operations. This method eliminates the need to print documents for faxing, allowing you to save paper. To use this function, you need to install a fax driver in your computer ([▶Installing Drivers\(P. 313\)](#)).



▶Sending PC Faxes(P. 578)

■ Help for fax driver

Clicking [Help] (Windows) or  (Mac OS) on the fax driver setting screen displays the Help screen. For information that is not in the User's Guide, including driver features and how to set up those features, see Help.

Sending PC Faxes

961F-09E

This section describes the basic flow of sending PC faxes from a computer.

▶ **For Windows(P. 578)**

▶ **For Mac OS(P. 579)**

Windows

- 1** Open a document and display the print screen.
- 2** Select the machine and click [Print] or [OK].

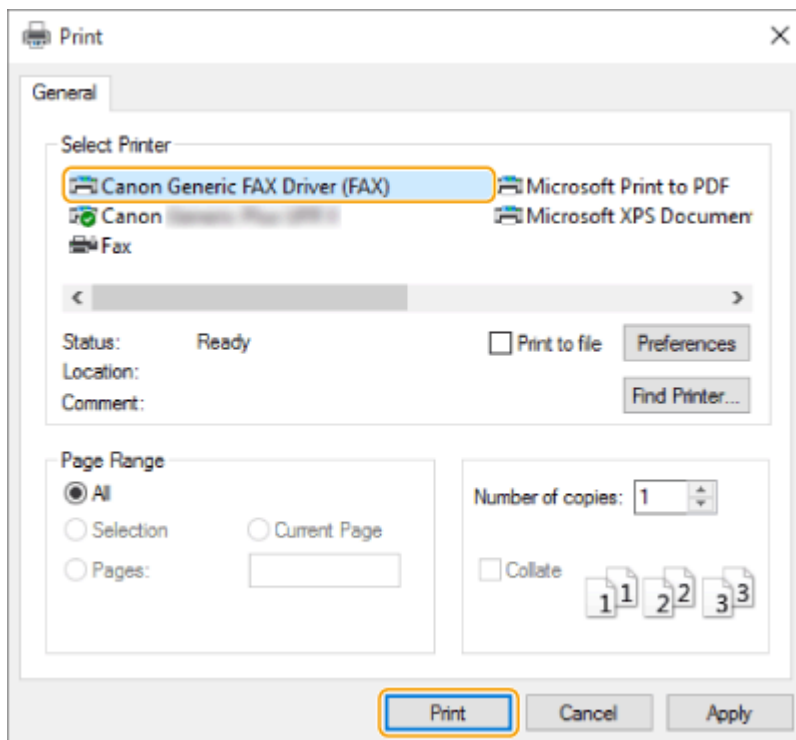

- 3** Click the [Enter Destination] tab, and specify the communication mode and fax number you are using.

- [* Communication Mode]: Make sure that [G3] is selected.
- [* Fax Number/URI]: Make sure that [Fax Number] is selected.
- [* Fax Number]: Enter a fax number.
- If you need to specify a number to dial an outside line, click [Detailed Settings] ▶ [Add Outside Dialing Prefix to G3/IP Fax Number], and enter a fax number in the [G3] text box.

NOTE

- If [Confirm Fax Number/URI when Setting Destination] is set in the [Security Settings] dialog box, enter the specified fax number in the [Confirm Fax Number]. For details, see Help for fax driver.

4 Click [Send].

⇒ Sending starts.

- To cancel sending, double-click the printer icon displayed in the task tray of the desktop, select the file to cancel, and click [Document] ► [Cancel] ► [Yes]. If the icon is not displayed, you can cancel from the control panel of the machine. ➤ **Checking Status and Log for Sent and Received Documents(P. 574)**

NOTE

When the department ID and password or the user name and password input screen is displayed

- Enter the department ID and password or the user name and password.

Mac OS

1 Open a document and display the print screen.

2 Select the machine and click [Show Details].

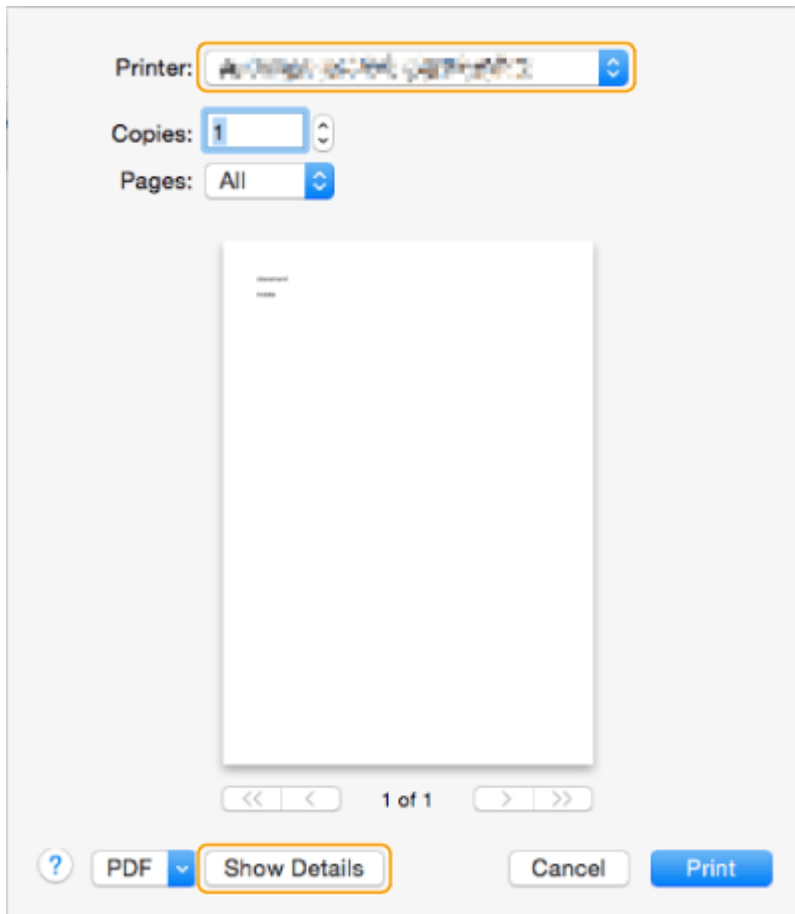

3 Click [General Settings].

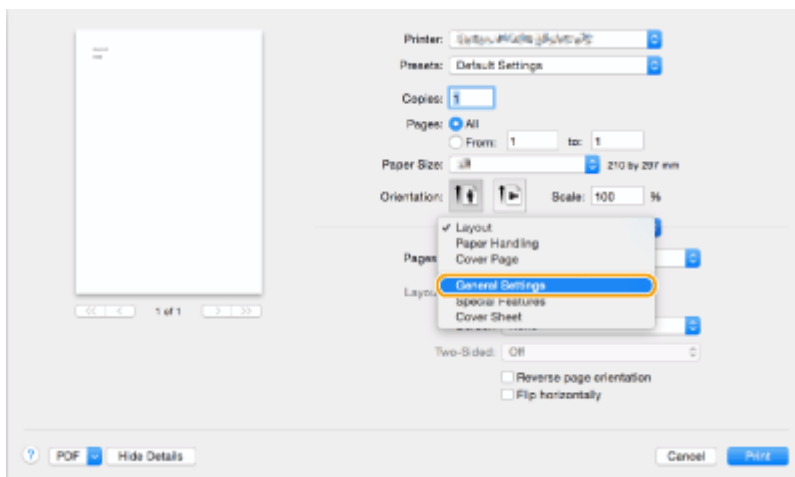

4 Click [Add Destination].

5 Enter the destination name in [Destination Name] and fax number in [Fax Number], and then click [Add] ► [Cancel].

- If you need to specify a number to dial an outside line, click [Outside Dialing Prefix] ► [Settings] on the [Special Features] panel, and then enter the number.

6 Click [Print].

⇒ Sending starts.

- To cancel sending, click the printer icon displayed in the Dock, select the file to cancel ▶ click [Delete] or  .
If the icon is not displayed, you can cancel from the control panel of the machine. ▶ **Checking Status and Log for Sent and Received Documents(P. 574)**

NOTE

When the department ID and password input screen is displayed

- Enter the department ID and password.

Using Internet Faxes (I-Fax)

961F-09F

Internet fax (I-fax) is a function to send and receive faxes via the Internet. Scanned documents are converted into TIFF format image and are sent as e-mail attachments. Even if you are sending to a distant place or you have lots of documents to send, you do not have to worry about transmission costs because telephone lines are not used. With this function, you can also send and receive I-faxes between devices in the same network using an office LAN.



▶ **Sending I-Faxes(P. 583)**

▶ **Receiving I-Faxes(P. 591)**

NOTE

- To send documents to an e-mail address used on a computer or mobile device, see ▶ **Basic Operations for Scanning Originals(P. 640)** .
- Standards for I-fax are defined by ITU-T (International Telecommunication Union - Telecommunication Standardization Sector). You can send and receive with other manufacturer's machines as long as that machine is ITU-T compliant. The imageRUNNER ADVANCE is compliant with Recommendation T.37 (Procedures for the transfer of facsimile data via store-and-forward on the Internet).

Sending I-Faxes

1 Place the original. ▶Placing Originals(P. 39)

NOTE:

- When the screen for selecting the original thickness appears, select the thickness of the original being used. (Appears if <Original Thickness Defaults for Scan from Feeder>is set to <Always Specify>. ▶ <Original Thickness Defaults for Scan from Feeder>(P. 1189))

2 Press <Scan and Send>. ▶<Home> Screen(P. 332)

3 Specify the destination on the Scan Basic Features screen. ▶Scan Basic Features Screen(P. 637)

- ▶Specifying Destinations from the Address Book
- ▶Specifying Destinations from One-Touch Buttons
- ▶Entering Destinations Manually
- ▶Specifying Destinations in the LDAP Server

NOTE:

- You can only change destinations from <Details> specified using the New Destination and destinations obtained via an LDAP server.
- If the server machine is performing the System Manager information settings, authentication between the server machine and the client machine is performed while the client machine is obtaining the Remote Address Book/one-touch buttons. Authentication is performed by matching the System Manager ID and System Manager PIN set by the server machine and client machine. ▶Changing the System Manager ID and PIN(P. 840)

The availability of the Remote Address Book/one-touch buttons depends on the status of the System Manager information settings for the server machine and client machine, as shown below.

When the server machine is performing the System Manager information settings	When the client machine is performing the System Manager information settings	The System Manager ID and System PIN for the server machine and client machine match	Can use the Remote Address Book/One-Touch Button
Performing	Performing	Matches	Yes
		Does Not Match	No
Not Performing	Not Performing	-	No
	Performing	-	Yes
Not Performing	Performing	-	Yes
	Not Performing	-	Yes

Specifying Destinations from the Address Book

1 Press <Address Book>.

2 Select the destination and press <OK>.

- If an access number is set when the destination is registered, press <Access No.> and enter the access number using the numeric keys. The corresponding destination is displayed in the Address Book.
- To use the Remote Address Book, press <To Remote Address Book>. When <Change Address Book> is displayed, press <Change Address Book> ► <Remote>.



a Destination type buttons

Pressing and displays I-fax and group destinations, respectively.

b Drop-down list for selection of Address Book types

Enables you to display a specific group of destinations. When you are logged in to the machine with personal authentication management, selecting <Personal Address List> displays your personal Address Book.

c <Search by Name>

Enables you to search the destination by the name you are entering.

d Search buttons by first letter

Enables you to narrow down a search by the first letter of the destination name.

NOTE

- To use the Remote Address Book, it is necessary to configure the server machine settings. Set to open the Remote Address Book externally on the server machine.

Specifying Destinations from One-Touch Buttons

1 Press <One-Touch>.

2 Select the desired one-touch button and press <OK>.

- To specify the destination using a one-touch button number (one-touch number), press and enter the number for the desired one-touch button.
- To use the Remote Address Book, press <To Remote Address Book>.

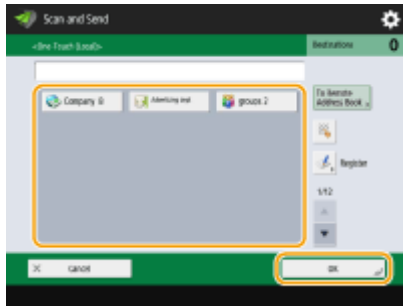

NOTE

- The destinations registered in the one-touch buttons of the server machine are updated in the following times:
 - When a fax job has been sent on the client machine
 - When you press  (Reset) on the client machine
 - When Auto Reset is activated on the client machine

Entering Destinations Manually

You can specify destinations manually that are not registered in the Address Book or one-touch buttons.

1 Press <New Destination> ► <I-Fax>.

2 Select the transmission mode.

- If you want to set the machine so that you can check the sending result of a document on the <Status Monitor> screen, select <Full>. If not, select <Simple>. Note that the recipient also needs to support the transmission mode in order to check the sending result. Depending on the recipient's machine, sending an I-fax is not allowed unless you select <Simple>.



NOTE

- If you send an I-fax to a destination that does not support the transmission mode, the <Status Monitor> screen displays <Awaiting result...> even if sending is complete. This message is displayed until the time set for <Full Mode TX Timeout> passes.  <Full Mode TX Timeout>(P. 1246)

3 Enter the I-fax destination.

- Press <I-Fax Address>, enter the destination, and then press <OK>. The destination needs to be specified in a format such as "adv01@example.com." To send to a device within the same network, enter the destination in a format such as "adv01@192.168.11.100 (recipient's name@IP address)."

4 Press <Destination Conditions>.

5 Specify the receiving conditions the recipient supports and press <OK>.

- Be sure to check the receiving functions the recipient supports before specifying the conditions.
- To add another I-fax address, press <Next Destination> and repeat steps 2 through 5.
- In <Compression Method>, the compression ratio of files increases in the order of MH → MR → MMR, and shortens transmission time.
- In <Divide Data>, select <On> to divide large amounts of document data for sending. If the recipient does not have the function to combine divided data, select <Off>. For the <Off> setting, a transmission error occurs when the size of send data exceeds a certain value. ▶<Maximum Data Size for Sending>(P. 1243)

IMPORTANT

- Specifying the conditions the recipient does not support may cause a transmission error.

NOTE:

- You can press <Register to Address Book> to register the entered destination. Set the required conditions, and specify <Name> and <Address Book>. For information on the settings, see ▶<Registering Destinations in the Address Book>(P. 394) .

6 Press <OK>.

NOTE

To send to a device within the same network

- When sending an I-fax to a device within the same network, you can send directly to the device without going through the mail server. Set <Send via Server> to <Off> before sending an I-fax.

Specifying Destinations in the LDAP Server

You can search and specify destinations registered in the LDAP server.

1 Press <Address Book>.

2 Press <To LDAP Server>.

- When <Change Address Book> is displayed, press <Change Address Book> ▶ <LDAP Server>.
- If the network password input screen is displayed, enter the user name and password and press <OK>.

3 Press <Search by Conditions>.

- To display all the destinations in the LDAP server without specifying any conditions, proceed to step 5.

4 Specify the search conditions.

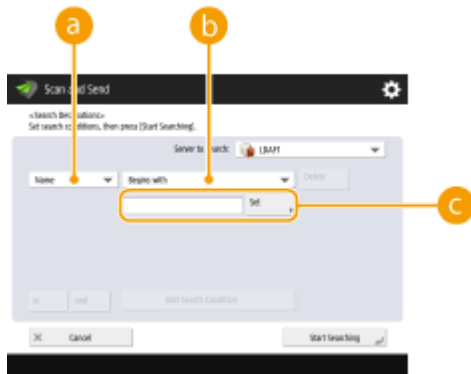

a Search categories

Select a criterion to search for destinations from name, e-mail address, organization name, and organization unit (department name, etc).

b Search conditions

Select a search condition such as a destination name that contains "John" and a department name that begins with "Development."

c Search characters

Press <Set> and enter search characters for the search condition.

NOTE

To search with multiple conditions

- You can search destinations with multiple conditions. Specify the first search condition, press <Add Search Condition>, and then select <or> or <and> for the next condition.

5 Press <Start Searching>.

⇒ The search results are displayed.

- To search with another condition, press <Delete> to delete the specified settings and then set a new condition.

6 Select destination and press <Specify E-Mail Address as I-Fax> ► <OK>.

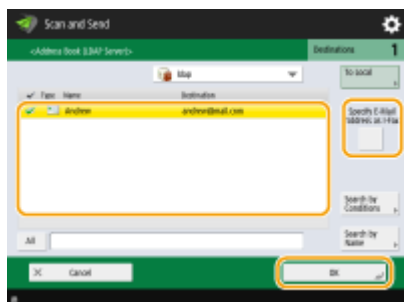

7 Check the displayed message and press <OK>.

8 Press <Details>.

9 Specify the receiving conditions the recipient supports and press <OK>.

- Press <Destination Conditions> and select the functions the recipient supports. Be sure to check the receiving functions the destination before specifying the conditions.
- In <Compression Method>, the compression ratio of files increases in the order of MH → MR → MMR, so shortens transmission time.
- In <Divide Data>, select <On> to divide send large amounts of document data for sending. If the recipient does not have the function to combine divided data, select <Off>. For the <Off> setting, a transmission error occurs when the size of send data exceeds a certain value. ▶<Maximum Data Size for Sending>(P. 1243)

IMPORTANT

- Specifying the conditions the recipient does not support may cause a transmission error.

10 Press <OK>.

4 Press <Options> and specify the scan settings as necessary.

- See the following for details.
 - ▶<Basic Operations for Scanning Originals>(P. 640)
 - ▶<Scanning Clearly>(P. 658)
 - ▶<Scanning Efficiently>(P. 664)
 - ▶<Useful Scanning Functions>(P. 672)

5 Press (Start).

▣ Originals are scanned and sending starts.

- To cancel scanning, press <Cancel> or  (Stop) ▶ <Yes>.

■<When <Press the [Start] key to scan the next original.> is displayed

Place the next original to scan and press  (Start). When scanning all of the originals is complete, press <Start Sending> to send the I-fax.

- To cancel sending, press <To Status Monitor> ▶ select a document ▶ <Cancel> ▶ <Yes>.

NOTE

To check the total number of specified destinations

- The total number of specified destinations is displayed on the top right of the screen. This enables you to confirm that the number of destinations is correct before sending.

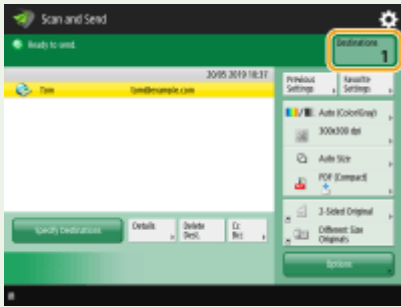

To send with the sender information

- You can send with the sender's name and I-fax address. ▶<TX Terminal ID>(P. 1230)

To check the statuses for sent documents

- On the <Status Monitor> screen, you can check the statuses for sent documents. This screen enables you to send faxes again or cancel sending after checking the statuses. ▶<Checking Status and Log for Sent and Received Documents(P. 574)
- When <Display Notification When Job Is Accepted> is set to <On>, the <Status Monitor> screen can be displayed from the following screen that is shown after a send job is received. ▶<Display Notification When Job Is Accepted>(P. 1237)

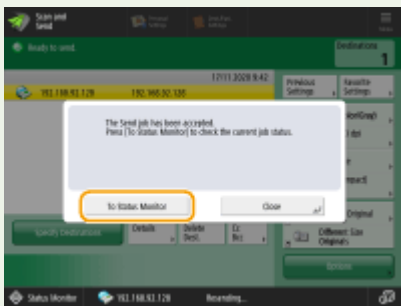

To print the report for the results of sending

- On the Scan Basic Features screen, pressing <Options> ▶ <TX Report> enables you to set to automatically print the report listing the results of sending. ▶<Checking Status and Log for Sent and Received Documents(P. 574)
- To set this for each job from <Options>, it is necessary to select <For Error Only> or <Off> in ▶<TX Report>(P. 1228) , and then set <Allow Printing from Options> to <On>.

To send files securely

- Using TLS communication enables you to send an encrypted file. ▶<Configuring the Key and Certificate for TLS(P. 864)

When multiple sheets are fed

- Scanning is stopped and the message is displayed on the screen. Follow the instructions to clear the jam. When you have cleared the jam, the resume job screen is displayed. If the machine mistakenly detects multiple sheet feeding, press <Do Not Detect Multi. Sheet Feed> to resume scanning.
- To set the machine in advance to not notify you of multiple sheet feeding, perform one of the following operations.
 - Each time you send, press <Options> on the Fax Basic Features screen ▶ select <Detect Feeder Multi Sheet Fd.> to disable the setting.
 - Set <Set Detection of Feeder Multi. Sheet Feed as Default> to <Off>. ▶<Set Detection of Feeder Multi. Sheet Feed as Default>(P. 1185)

When photos in the sent image are too dark or light colors in the background of color originals cannot be removed

- The quality of the sent image may be able to be improved if the following conditions/settings are met.
 - Job type: Fax (Memory Sending) or Scan and Send (Fax/I-fax)

- <Select Color>: <Black & White> (Scan and Send)
- <Original Type>: <Text>
- <Density> ▶ <Background Density>: <Auto>
- <Resolution>: 200 dpi x 400 dpi, 300 dpi x 300 dpi*, 400 dpi x 400 dpi, or 600 dpi x 600 dpi*
*Can be set for Scan and Send
- <Speed/Image Quality Priority for B&W Scan> ▶ Fax/I-Fax Send Jobs: <Quality Priority> (▶<Speed/Image Quality Priority for B&W Scan>(P. 1186))

TIPS

Checking scanned images before sending

- You can check scanned images on the preview screen before sending. ▶<Checking Scanned Originals Before Sending/Saving (Preview)>(P. 675)

Registering frequently used settings

- You can combine frequently used destinations and scan settings into a button of the machine for later use. By pressing the registered button when scanning originals, you can quickly complete your settings. ▶<Registering a Combination of Frequently Used Functions>(P. 367)

LINKS



- ▶<Registering Destinations>(P. 389)
- ▶<Registering the LDAP Server>(P. 299)
- ▶<Set Destination>(P. 1310)

Receiving I-Faxes

■ When an I-fax is received

The Processing/Data indicator on the control panel blinks green. When receiving is complete, the document is automatically printed and the indicator turns off.

NOTE



- To cancel receiving, press  (Status Monitor) ▶ <Receive> ▶ <Job Status> ▶ select a document ▶ <Cancel>.
- You can specify the time before reception is canceled when receiving a divided I-fax and the subsequent data cannot be received. Data received by the specified time is printed.  <Divided Data RX Timeout>(P. 1277)

■ Output paper





An incoming I-fax is printed on the same size of paper as the document size received. When there is no paper matching the size of the received document, the document is printed according to the setting of <Select Drawer>.  <Select Drawer>(P. 1268)

NOTE



To receive I-faxes manually

- Press  (Status Monitor) ▶ <Receive> ▶ <Job Log> ▶ <Check I-Fax RX>. Pressing <Fax/I-Fax Inbox>( <Home> Screen(P. 332)) ▶ <Memory RX Inbox> ▶ <Divided Data RX Inbox> enables you to check the receiving statuses of I-faxes divided and their data size.

TIPS

- You can save paper when printing.
 -  <Print on Both Sides>(P. 1268)
 -  <2 on 1 Log>(P. 1269)
 -  <Reduce Fax RX Size>(P. 1269)
- You can include information, such as reception time, in received documents when printing.  <Print RX Page Footer>(P. 1270)

LINKS

-  <Various Receiving Methods>(P. 565)
-  <Forwarding Received Documents Automatically>(P. 571)
-  <Checking Status and Log for Sent and Received Documents>(P. 574)

Using Remote Faxes

961F-09K

Even if you have a multifunction printer without the ability to fax, you can use the printer to send and receive faxes via another multifunction printer with fax functionality if both printers are on the same network. In this case, the printer with fax functionality and the printer without fax functionality can be likened to a server machine and client machine, respectively. Sharing fax functionality and communication lines reduces introduction costs and offers an efficient use of fax functions.

* Available only for the imageRUNNER ADVANCE series

! IMPORTANT

Models with fax functionality

- Can be used only as a server machine, but not as a client machine.
- Does not support Remote Fax Kit.

Models with an optional fax function

- To use the Remote Fax function, you must install the following options to beforehand: **System Options(P. 1597)**
 - On a machine to be used as a server machine: Super G3 FAX Board
 - On a machine to be used as a client machine: Remote Fax Kit

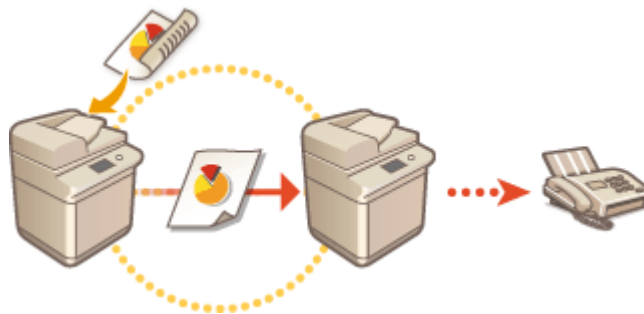

Before Using a Remote Fax

Specify the respective settings on the server machine and client machine beforehand.

- Settings for server machines: **<Remote Fax Settings>(P. 1265)**
- Settings for client machines: **<Remote Fax TX Settings>(P. 1262)**

Sending a Fax

You can send a fax from a client machine in the same way as a normal fax. **<Basic Operations for Sending Faxes>(P. 524)**

Receiving a Fax

Faxes received at a server machine are converted into I-faxes and forwarded to a client machine. You need to specify the settings for a server machine to forward I-faxes to a client machine and for the client machine to receive I-faxes.

- Settings for server machines: **<Forwarding Settings>(P. 1272)**
- Settings for client machines: **<Setting E-mail/I-Fax Communication>(P. 316)**

NOTE

- When the department ID and password input screen is displayed, enter the ID and password registered in the server machine.
- The sender information of a fax sent from the client machine is printed according to the setting in the server machine. [▶<TX Terminal ID>\(P. 1230\)](#)

LINKS

[▶Receiving I-Faxes\(P. 591\)](#)

Printing

Printing	595
Printing From a Computer	597
Canceling Printing	600
Checking the Printing Status and History	602
Printing from an External Network (IPP Printing)	604
Advanced Functions for Printing	607
Printing Documents Retained in the Machine (Forced Hold Printing)	608
Printing at a Specified Time (Scheduled Printing)	612
Printing With Settings Disabling Unauthorized Copying	614
Various Printing Methods	616
Directly Printing Files without Opening Them	617
Printing Using a Virtual Printer	619
Printing From Memory Media (Media Print)	622
Copying Files to a Folder for Printing (Hot Folder)	623
Printing Using the Microsoft Cloud Service (Universal Print)	627
Configuring the Universal Print User Settings	631

Printing

You can print documents and images prepared on a computer. This section introduces basic procedures and convenient printing functions.

■ Introduction of basic operations

This section describes the basic operation methods when printing from a computer.



- ▶ **Printing From a Computer(P. 597)**
- ▶ **Canceling Printing(P. 600)**
- ▶ **Checking the Printing Status and History(P. 602)**

■ Advanced functions for printing

This section introduces functions used when you want to print a sample set or edit the document before printing large quantities, avoid to leave or to be copied printed paper, etc.



- ▶ **Printing Documents Retained in the Machine (Forced Hold Printing)(P. 608)**
- ▶ **Printing at a Specified Time (Scheduled Printing)(P. 612)**
- ▶ **Printing With Settings Disabling Unauthorized Copying(P. 614)**

■ Printing in various environments

This section introduces printing methods for printing without the printer driver of the machine such as printing without your computer during a business trip, etc.



- ▶ **Directly Printing Files without Opening Them(P. 617)**
- ▶ **Printing Using a Virtual Printer(P. 619)**
- ▶ **Printing From Memory Media (Media Print)(P. 622)**
- ▶ **Copying Files to a Folder for Printing (Hot Folder)(P. 623)**
- ▶ **Printing Using the Microsoft Cloud Service (Universal Print)(P. 627)**

TIPS

- You can print photographs, PDF files, etc. from a mobile device such as a smart phone, tablet, etc. For more information, see [▶ Linking with Mobile Devices\(P. 764\)](#) .

Printing From a Computer

961F-09R

This section describes basic printing from a computer with the printer driver installed.

- ▶ **Help for Printer Drivers(P. 597)**
- ▶ **Basic Printing Operations(P. 597)**

Help for Printer Drivers

Clicking [Help] (Window) or  (Mac OS) on the printer driver setting screen displays the Help screen. For information that is not in the User's Guide, including about driver features and how to set up those features, see Help.

Basic Printing Operations

This section describes the basic flow when printing from a computer.

- ▶ **In case of Windows(P. 597)**
- ▶ **In case of Mac OS(P. 598)**

Windows

- 1 Open a document and display the print screen.**
- 2 Select the machine and click [Preferences] or [Properties].**
- 3 Specify the print settings as necessary and click [OK].**
 - Switch tabs as necessary to specify the desired print settings.

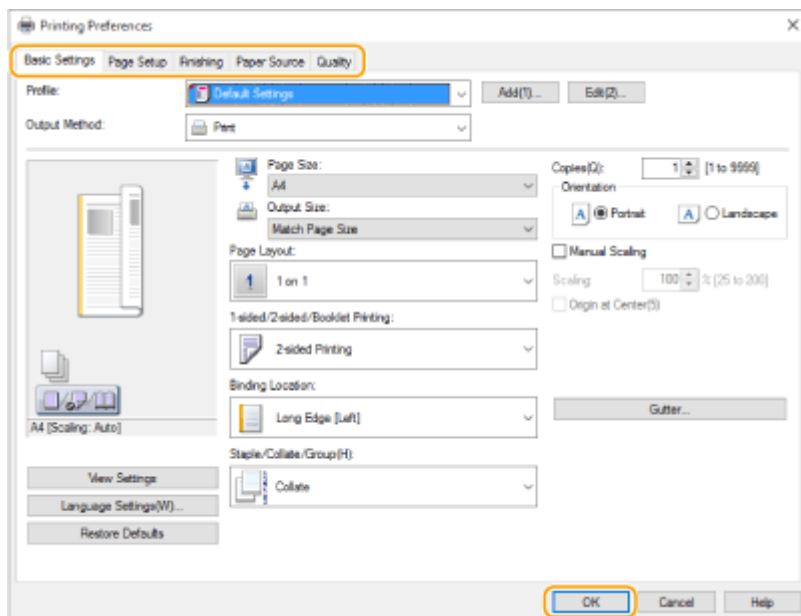

4 Click [Print] or [OK].

⇒ Printing starts.

- If you want to cancel, see [Canceling Printing\(P. 600\)](#) .

Mac OS

1 Open a document and display the print screen.

2 Select the machine.

3 Specify the print settings as necessary.

- After selecting the setting panel from the drop-down list, set for printing on each panel.

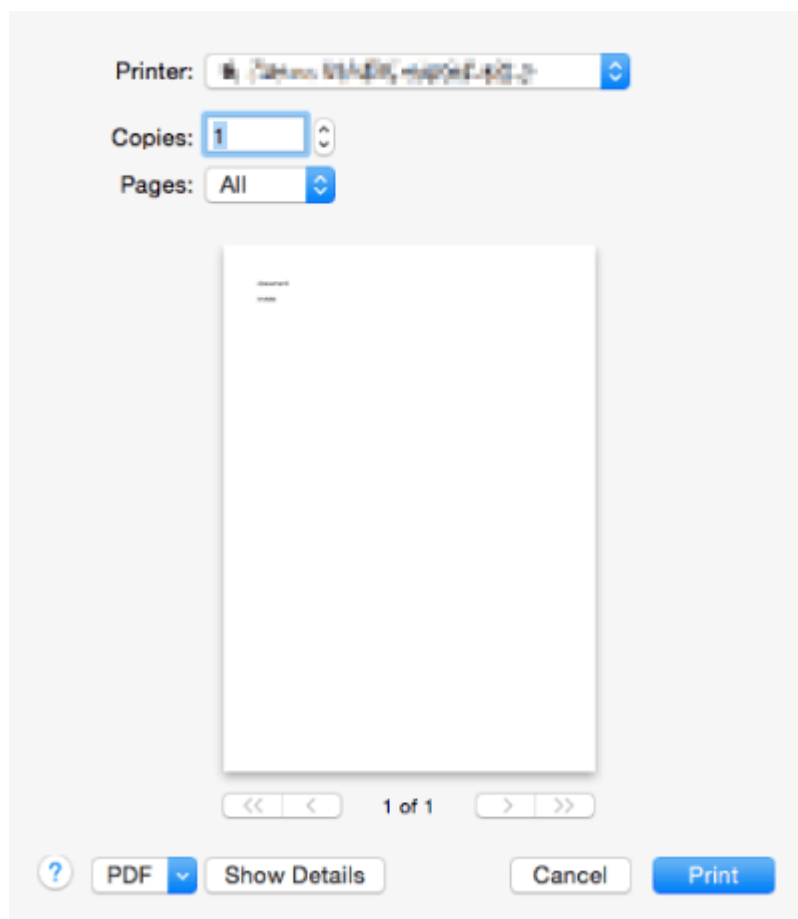

4 Click [Print].

⇒ Printing starts.

- If you want to cancel, see [Canceling Printing\(P. 600\)](#) .

LINKS

- ▶ **Checking the Printing Status and History(P. 602)**
- ▶ **<Paper Feed Mode for Printer Driver Jobs with MP Tray>(P. 1203)**

Canceling Printing

You can cancel printing before it has finished. You can also cancel a print job on the control panel of the machine. ▶ **Checking the Printing Status and History(P. 602)**

▶ **In case of Windows(P. 600)**

▶ **In case of Mac OS(P. 600)**

Windows

1 Double-click the printer icon displayed in the task tray of the desktop.



NOTE

When the printer icon is not displayed

- Open the printer folder, and click or double-click the icon for the machine.

2 Select the document to cancel and click [Document] ▶ [Cancel].

- If you cannot find the document to cancel, the document is already sent to the machine. In that case, you cannot cancel the printing on the computer.

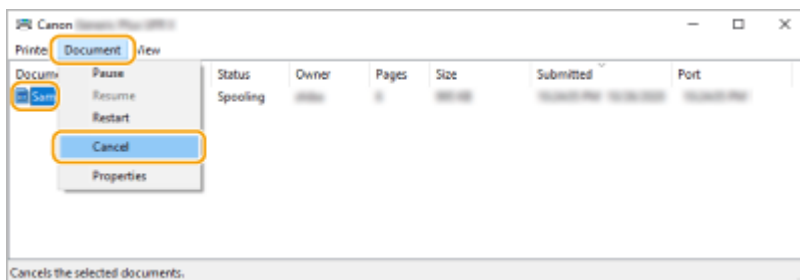

3 Click [Yes].

⇒ Printing is canceled.

Mac OS

1 Click the printer icon displayed on the Dock.



2 Select the document to cancel and click [Delete] or .

⇒ Printing is canceled.

Checking the Printing Status and History

961F-09U

You can check the wait status for print jobs and whether or not an error has occurred during printing. Operations such as printing the document ahead of other documents and temporarily suspending or canceling printing are possible as well.

NOTE

- When personal authentication management is used, you can restrict users from performing operations on the jobs of other users on the <Status Monitor> screen.  <Restrict Access to Other User Jobs>(P. 1339)

1 Press  (Status Monitor).

2 Press <Copy/Print> ► <Job Status>.

- To display only the documents to be printed, select <Print> from the drop-down list in the upper-right of the screen.

z

3 Check the status.

- Pressing <Details> after selecting a document, enables you to cancel printing, to check the status of the job, etc.
- Pressing <Cancel> after selecting a document, enables you to cancel printing.
- When pressing <Interrupt/Priority Print> after selecting a document, <Interrupt and Print> and <Priority Print> appear. Press <Interrupt and Print> to suspend a print job in process and immediately start printing the document selected. Press <Priority Print> to jump the selected document to the top of the waiting list, and print it after printing the print job in progress.

NOTE

- To ignore an error and continue printing, press <Details> ► select a document ► <Skip Error>.
- To forcibly print any unprinted job in the machine, press <Details> ► select a document ► <Paper Feed>.
- You cannot interrupt an interrupt print job with another job. If you try to interrupt an interrupt print job, the job is started after the current interrupt job is complete.

■ Checking the printing history

Press <Job Log> to display a list of printed documents. If a document is printed without problems, the <Result> column displays <OK>. If <NG> is displayed, it shows that printing was canceled or an error occurred.

NOTE

- To see the detailed information, press <Details> after selecting a document.
- To print a history list, press <Print List>.

LINKS

▶ **Canceling Printing(P. 600)**

Printing from an External Network (IPP Printing)

961F-09W

Using the IPP port enables you to print from an external network via the Internet. To use IPP printing, you must specify the IPP port in the printer driver. To use IPPS also, you must install this machine's key and certificate on your computer.  **Installing This Machine's Key and Certificate on Your Computer(P. 605)**

IMPORTANT

- To use IPP printing, you must specify the <IPP Print Settings>.  **<IPP Print Settings>(P. 1099)**
- To perform the following procedure, you need to log in to your computer with the administrator account.

1 Prepare the printer driver.

- If the machine is supplied with a CD-ROM, insert the CD-ROM into the drive on the computer.
- To download the printer driver, go to the Canon website (<https://global.canon/en/support/>) and download your printer driver.

2 Select [Windows System] ▶ [Control Panel] ▶ [Hardware and Sound] ▶ [Devices and Printers].

3 Click [Add a Printers].

4 Click [The printer that I want isn't listed].

5 Select [Select a shared printer by name], enter the connection destination and click [Next].

- To use IPP, enter "http://<IP address of the machine>/ipp" for the connection destination.
- To use IPPS, enter "https://<IP address of the machine>/ipp" for the connection destination.

6 Click [Have a Disk...].

7 Click [Browse...].

8 Specify the folder containing the printer driver, select the INF file and click [Open].

- The INF file is stored in the [Driver] folder.

9 Proceed with the settings by following the on-screen instructions.

➡ The printer driver is installed. To use IPPS, install this machine's key and certificate on your computer.

■ Installing This Machine's Key and Certificate on Your Computer

This description shows the procedure for installing the key and certificate using the Microsoft Edge.

- 1 Start the Web browser.**
- 2 Enter "http://<IP address of the machine>/" in the address input field and press the [ENTER] key on the computer keyboard.**
- 3 Click [No secure] ► [Your connection to this site isn't secure] ► [Certificate] in the URL input field.**
- 4 Click [Copy to File...] on the [Details] tab.**
- 5 Click [Next].**
- 6 Select a file format and click [Next].**
- 7 Set the save destination and certificate file name and then click [Next].**
- 8 Check the content being saved and click [Finish] ► [OK].**

 ⇒ This completes certificate saving.
- 9 Click [OK].**
- 10 Close the Web browser.**
- 11 Install the certificate saved in step 8 on your computer.**

■ For DER/Base64 (with the ".cer" extension)

- 1** Double-click the saved certificate.
- 2** Click [Install Certificate...].
- 3** Select a save location and click [Next].
- 4** Select [Place all certificates in the following store] then [Browse...] ► [Trusted Root Certification Authorities], and then click [OK].
- 5** Click [Next] ► [Finish].

■ **For PKCS#7 (with the "p7b" extension)**

- 1 Double-click the saved certificate.
- 2 Double-click the path for the folder containing the certificate with the name shown in [Logical Store Name].
- 3 Double-click the [Certificates] shown in [Object Type].
- 4 Double-click the file shown in [Issued To].
- 5 Click [Install Certificate...].
- 6 Select a save location and click [Next].
- 7 Select [Place all certificates in the following store] then [Browse...] ► [Trusted Root Certification Authorities], and then click [OK].
- 8 Click [Next] ► [Finish].

Advanced Functions for Printing

961F-09X

This section introduces printing functions such as running a print job efficiently, or improving the security on printing.



▶ **Printing Documents Retained in the Machine (Forced Hold Printing)** (P. 608)



▶ **Printing at a Specified Time (Scheduled Printing)**(P. 612)



▶ **Printing With Settings Disabling Unauthorized Copying**(P. 614)

Printing Documents Retained in the Machine (Forced Hold Printing)

961F-0A3



To avoid leaving printed material, accidental information leakage, misprinting, etc., the administrator sets to store the document before printing. To print the stored document, see the followings.

▶<Forced Hold>(P. 1301)

▶<Restricting Printing from a Computer>(P. 886)

! IMPORTANT

- The Forced Hold mode needs to be set in advance. ▶<Forced Hold>(P. 1301)
- Up to 200 users can use this mode. If a document which is shared with several people is retained in the machine, only the user who sends the job is counted.
- You can store up to 2,000 jobs.
- At least 4 GB is guaranteed for storing retained documents.
- The maximum size of a retained document that can be stored is 2 GB.
- The documents retained in the machine are saved even if the machine is turned OFF.
- Note that documents are automatically deleted after a specified period of time passes. Please consult your administrator regarding the length of this time period.

1 Press <Print>. ▶<Home> Screen(P. 332)

2 Select a document.









a <Personal>/<Shared>/<Group>

- <Personal>: Displays the documents sent by the user who is logged in.
- <Shared>: Documents held based on specific conditions according to forced hold settings are displayed. All users can display/print these documents.

- <Group>: Displays documents that have the same group information as the user who is logged in. Uses Department IDs to identify groups.

b Document list

- Documents which match the document type selected in the drop-down list **a** and their related information are displayed in a list format.
- When a document is selected,  which indicates "selected" is displayed. When multiple documents are selected, the numbers in the center of  are displayed as 1, 2, 3 ... in the order selected. When you press a selected document, the selection is canceled.
- Press <Date/Time> to sort the documents by date/time, in ascending () or descending () order.
- If you log in with personal authentication management, the last sorting condition is retained. **▶List of Items That Can Be Personalized(P. 357)**
- Secured print or encrypted secured print documents display  next to the number of sheets x number of copies on the job list.
- If <Display Warning on Job List Screen> is set to <On> in <Held Jobs Warning Settings>,  is displayed on the job list for documents that match the specified conditions. If <Display Warning on Job List Screen> is set to <Off> in <Held Jobs Warning Settings>, a warning pop-up is displayed when printing, for documents that match the specified conditions. **▶<Held Jobs Warning Settings>(P. 1304)**

NOTE

- You can print from here if the printer driver output method is set to [Secured Print].

c <Jobs to Be Printed>/<Jobs Printed>/<Scheduled Print>

When selecting an unprinted document, confirm that <Jobs to Be Printed> is selected.

d Update button

Updates the document list.

e <No. of Copies>

To change the number of sets to be printed, enter the number of sets to change.

f <Start Printing>

Executes printing.

g <Cancel Printing>

Cancels printing.

h <Delete Job>

Deletes documents.

i <Display Image>

Enables you to check the contents of the document as well as select and delete pages.

NOTE

- You cannot restore a page that has been deleted.
- You cannot delete a page from <Display Image> if it is the only page there.
- Previews may not be available with <Display Image>, depending on the settings of the printer driver.
- For information on the page description languages that enable previewing and the file formats for direct printing, see **▶Printer Functions(P. 1582)** .
- <Delete Page> from <Display Image> of the PrintRelease function of Canon PRINT Business is not supported.
- If the message <Failed to delete the page.> is displayed when deleting a page, press <Delete Page> in <Preview> again.

j <Print Settings>/<Print Set. for Selected Jobs>

You can edit the printing settings such as number of copy. You can also change the print settings when multiple documents are selected.

NOTE

- You can print a sample set with the settings specified in Print Settings by pressing <Print Sample>.
- Depending on changed settings, the document may not be printed correctly.
- If you change the settings on <Print Settings>/<Print Set. for Selected Jobs>, the document in which the new settings are applied is displayed in <Printed>.
- If you select general print jobs, secured print jobs, and encrypted secured print jobs at the same time, you cannot change the print settings of them at once.
- The settings may not be able to be changed in <Print Settings>, depending on the settings of the printer driver.
- For information on the page description languages that enable the configuration of print settings and the file formats for direct printing, see **Printer Functions(P. 1582)** .
- You cannot change the print settings of multiple jobs at once when using the PrintRelease function of Canon PRINT Business.

k <Select All (Max 100 jobs)>/<Clear Selection>

If a document is not selected in **b** , <Select All (Max 100)> is displayed, which enables you to select all the documents in the document list. When documents are selected, <Clear Selection> is displayed enabling you to cancel the entire selection.

NOTE

- The messages <Some jobs could not be stored after being received.> and <Some jobs have been deleted.> may be displayed if an error occurs when receiving a document or a document is automatically deleted because its retention period has elapsed, etc. In this case, press  to cancel the message.

3 Press <Start Printing>.

⇒ Printing starts.

NOTE

- To cancel printing, select the job to cancel in <Jobs Printed>, and select <Cancel Printing>. You can also press  (Stop) on the control panel and select the job to cancel from <Print Jobs>. For information on canceling jobs with the Stop key, see **Canceling Send/Print Jobs(P. 383)** .

Automatically Printing Forced Hold Print Jobs after Logging In

You can set to automatically print jobs when a user logs in. When the administrator has set **<Enable Auto Print Function When Logging In>(P. 1305)** to <On>, users that are logged in with personal authentication management can set whether automatic printing is performed or not. Set **<Auto Print User Jobs When Logging In>(P. 1306)** to <On> to perform automatic printing. The setting is retained for each user. **<List of Items That Can Be Personalized>(P. 357)**

IMPORTANT

- The following jobs are not automatically printed even if this setting is enabled.
 - <Personal> jobs of other users, <Shared> jobs, and <Group> jobs
 - Printed jobs
 - Encrypted secure printing jobs
 - Secure printing jobs (when <Require PIN for Printing/Displaying User Jobs> is set to <On> in **<PIN Settings for Secure Print Jobs>(P. 1304)**)

NOTE

- When multiple jobs are held, they are printed in the display order of <Date>.
- A maximum of 100 jobs can be printed with a single login operation.
- If jobs are already held, this setting is enabled by logging in again after setting <Auto Print User Jobs When Logging In> to <On>.

Printing More Safely with Encrypted Secure Print

By using Encrypted Secure Printing, you can send encrypted printing data to a machine from your computer. This enables you to reduce the risk of information leaks when sending printed data, and to print more safely. Use this especially when printing highly confidential documents.

NOTE

- The document with Encrypted Secure Printing is displayed along with  on the setting change screen.
- To print the encrypted document, you must enter the password. The password must be the same as the password you set on the printer driver.
- For information on setting items, see "Help" by clicking [Help] on the printer driver setting screen (Windows only).
- Encrypted Secure Print cannot be used with Mac OS.
- To use encrypted secure printing, display the printer folder ► right-click the icon for the machine ► select [Printer properties] ► see the [Help] on the [Encrypted-P] tab. For information on displaying the printer folder, see [▶ Displaying the Printer Folder\(P. 1574\)](#) .

Printing at a Specified Time (Scheduled Printing)

961F-0A4



You can set a time to start printing, which is useful when printing large amounts of documents at night, etc.

- ▶ **Sending Scheduled Print Documents from a Computer (Windows)(P. 612)**
- ▶ **Checking the Scheduled Print Jobs(P. 613)**

! IMPORTANT

- To use the scheduled print function, it is necessary to set ▶ **<Forced Hold>(P. 1301)** to <Off> in advance.
- To use the scheduled print function, it is necessary to set ▶ **<Use ACCESS MANAGEMENT SYSTEM>(P. 1351)** to <Off> in advance.
- The scheduled print jobs are deleted when ▶ **<Use ACCESS MANAGEMENT SYSTEM>(P. 1351)** is set to <On>.

Sending Scheduled Print Documents from a Computer Windows

- 1 Open the document and display the print screen.**
 - For information on displaying the print screen, see the help for the application.
- 2 Select the machine, and click [Details] or [Properties].**
- 3 Select [Scheduled Print] from [Output Method] and click [Yes].**

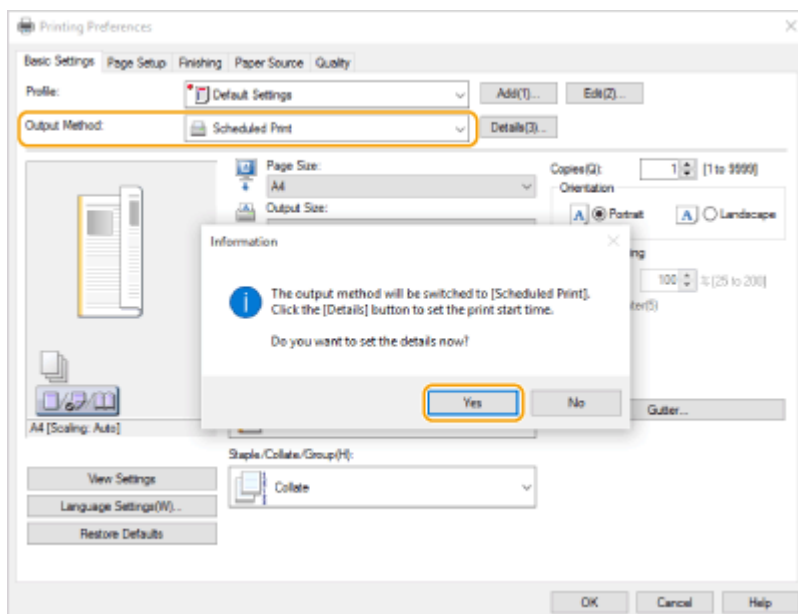

4 Specify [Print Start Time] and click [OK].

5 Configure the print settings as necessary, and click [OK].

6 Click [Print] or [OK].

⇒ The document is sent to the machine.

NOTE

- The scheduled print jobs are executed according to the time set in the machine. Confirm that the time set in the machine matches that of your computer in advance.
- If a print job is scheduled at a time longer than 24 hours in advance, the job is canceled.
- A print start time between 0:00 and 23:59 is specified on the printer driver screen, but the time is processed in the format year, month, day, hour, minute, and second (with the second fixed to 0).

Checking the Scheduled Print Jobs

1 Press <Print>. ◀<Home> Screen(P. 332)

2 Press <Scheduled Print>, and check the print jobs waiting to be output.

- The scheduled print date and time can be checked in <Scheduled>.
- To delete a print job, select the document, and press <Delete Job>.
- Scheduled print jobs are deleted after they are executed. They are also not displayed in <Jobs Printed>.

Printing With Settings Disabling Unauthorized Copying

961F-0A5



When printing documents including personal or confidential information, it is necessary to avoid leaks caused by unauthorized copying by third parties. To prevent unauthorized copying, the machine is equipped with a "Secure Watermark" function that prompts attention by making characters such as "TOP SECRET" appear when reproduced. To use the Secure Watermark function on the machine, the security printing function of the printer driver must be set first.

NOTE

Check whether setting by the printer driver is necessary

- If the machine is set to use the Secure Watermark function on all printed documents, this operation is not necessary. By printing as usual, the Secure Watermark information is automatically embedded (▶ **Embedding Invisible Text (Forced Secure Watermark)(P. 893)**). When enabling or disabling the Secure Watermark function for each document, follow the procedures below.

- ▶ **Enabling the Secure Watermark (Windows) (P. 614)**
- ▶ **Printing Using Secure Watermark(Windows) (P. 614)**

Enabling the Secure Watermark **Windows**

To use the Secure Watermark function, it is necessary to enable the security printing function of the printer driver. You are required to log in to a computer with the administrator account to perform this setting.

- 1 Open the printer folder. ▶ **Displaying the Printer Folder(P. 1574)****
- 2 Right click the icon of the machine and then click [Printer properties].**
- 3 Select the [Secure Printing Function of Device] check box on the [Device Settings] tab.**
- 4 Click [OK].**

Printing Using Secure Watermark **Windows**

To print the Secure Watermark, perform the following operations on the printer driver for each printing.

- 1 Open a document and display the print setting screen of the printer driver.**
- 2 Select the machine and click [Details] or [Properties].**

3 Click [Advanced Settings] on the [Finishing] tab.

4 Select [On] at [Secure Printing Function of Device] and click [OK].

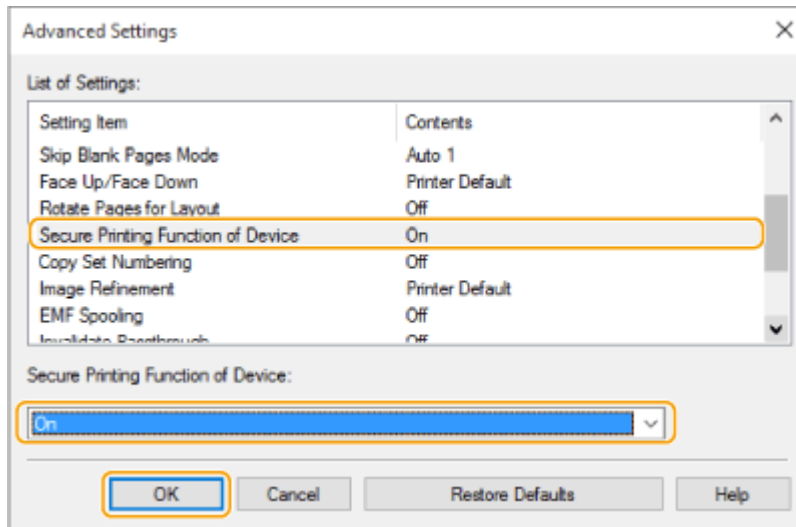

5 Click [OK].

6 Click [Print] or [OK].

⇒ Printing is executed with the Secure Watermark embedded into the document.

LINKS

▶ **Restricting Copying of Confidential Documents(P. 509)**

Various Printing Methods

961F-0A6

This section introduces printing method using the Remote UI, or how to print a file stored in memory media.



▶ **Directly Printing Files without Opening Them(P. 617)**

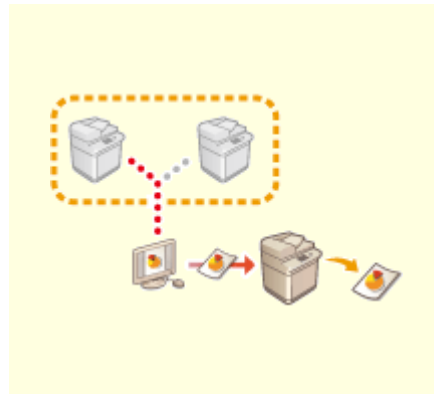

▶ **Printing Using a Virtual Printer(P. 619)**



▶ **Printing From Memory Media (Media Print)(P. 622)**

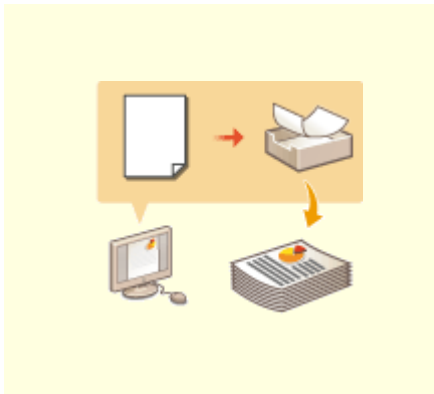

▶ **Copying Files to a Folder for Printing (Hot Folder)(P. 623)**



▶ **Printing Using the Microsoft Cloud Service (Universal Print) (P. 627)**

Directly Printing Files without Opening Them

961F-0A7



By using remote UI, it is possible to print files saved on a computer or network directly from the machine without using the printer driver. You do not need to open files on the computer for printing.

- 1 Start the Remote UI. ▶ Starting the Remote UI(P. 902)**
- 2 Click [Direct Print] on the portal page. ▶ Remote UI Screen(P. 904)**
- 3 Select a file format and then a file.**

4 Specify the print settings as necessary.

- If a password is set for the PDF file, press [Specify PDF File] ▶ enter the password in [Document Password]. When printing PDF files linked to the policy server, select [Specify PDF File] ▶ enter the policy server user name in [Policy Server User Name] and the policy server password in [Policy Server Password].
- To print the PDF file which is prohibited for printing, or to print PDF files that only allow low-resolution printing in high resolution, enter the master password.
- Depending on the selected paper size, PDF/XPS files may be canceled on printing.

5 Click [Start Printing].

⇒ Printing starts.

IMPORTANT

- Do not click [Start Printing] repeatedly during file transfer. Otherwise, file malfunction may occur and the file may not be transferred.
- Printing may not be performed properly depending on the data.

NOTE

- If printing with Direct Print is not possible or the printing position deviates, opening files from the application and using the printer driver may enable proper printing.

Printing Using a Virtual Printer



A virtual printer enables you to use LPD printing or FTP printing with the print settings registered as a virtual printer in advance. For example, registering settings such as the paper type, number of copies, and two-sided printing in advance eliminates the need to specify these settings for each job.

▶ **Adding a Virtual Printer(P. 619)**

▶ **Printing with a Virtual Printer(P. 620)**

! IMPORTANT

- Set ▶ **<Forced Hold>(P. 1301)** to <Off>. If <Forced Hold> is set when a job is executed, the results may differ depending on the settings. ▶ **Configuring the Forced Hold Printing Settings(P. 886)**
 - If the job matches the set conditions for <Job Action> and <Cancel>: The job is canceled.
 - If the job matches the set conditions for <Job Action> and <Print>: The job is printed according to the virtual printer.
 - If the job matches the set conditions for <Job Action> and <Hold as Shared Job>: The virtual printer is disabled and the job is held in the machine.
- For Secure Print and Encrypted Secure Print, the virtual printer is disabled and the job is held in the machine.

NOTE

- Set ▶ **<LPD Print Settings>(P. 1096)** to <On> to perform LPD printing.
- Set ▶ **<FTP Print Settings>(P. 1097)** to <On> to perform FTP printing.
- The page description language and file format that can be used with a virtual printer is PS and PDF.

Adding a Virtual Printer

- 1 Start the Remote UI. ▶ Starting the Remote UI(P. 902)**
- 2 Click [Settings/Registration] on the portal page. ▶ Remote UI Screen(P. 904)**
- 3 Click [Printer] ▶ [Virtual Printer Management].**
- 4 Click [Add Virtual Printer].**

NOTE

- Operations cannot be performed from multiple browsers at the same time.

5 Enter the virtual printer name and specify the required settings.

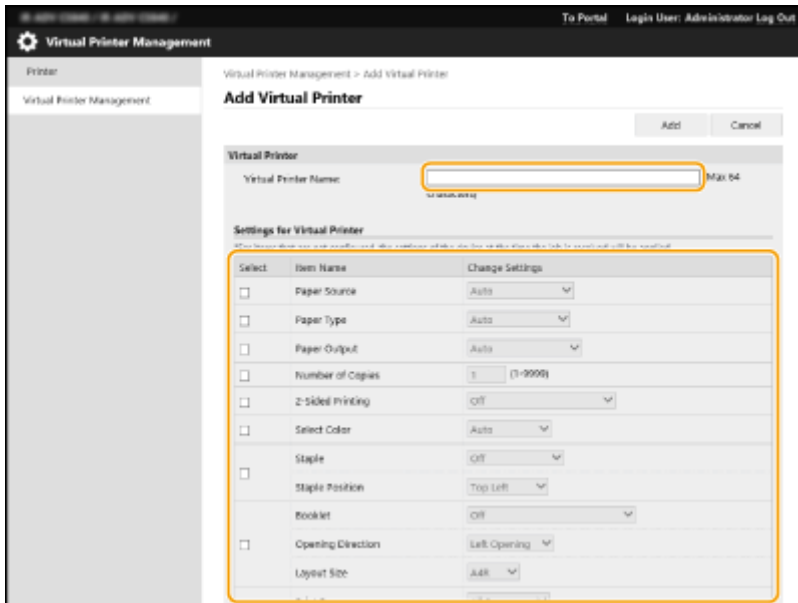

NOTE

- Multiple virtual printers with the same name cannot be registered.
- A maximum of 20 virtual printers can be registered.

6 Click [Add].

NOTE

- You are required to log in to the Remote UI with any of the following privileges to perform this setting. For more information, see the items in [Select Role to Set:] in [▶ Registering User Information in the Local Device\(P. 809\)](#) .
 - Administrator
 - DeviceAdmin
 - NetworkAdmin
- This setting can be imported/exported with models that support batch importing of this setting. [▶ Importing/Exporting the Setting Data\(P. 946\)](#)
- This setting is included in [Settings/Registration Basic Information] when batch exporting. [▶ Importing/Exporting All Settings\(P. 950\)](#)

Printing with a Virtual Printer

For LPD printing

- LPR -S [IP address of the machine] -P [virtual printer name] [file name]

Printing

Example: Printing "sample.pdf" with a virtual printer named "001"

```
lpr -S IP address of the machine -P 001 sample.pdf
```

For FTP printing

- put [file name] [virtual printer name]

Example: Printing "sample.pdf" with a virtual printer named "001"

```
> put sample.pdf 001
```

Printing From Memory Media (Media Print)

961F-0A9

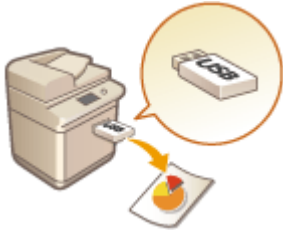

It is possible to print files saved on memory media directly from the machine without using a computer. This is convenient when printing after bringing data back from an outside location or when printing data you have brought with you to a business destination.

NOTE

Using memory media

- For available memory media and information on inserting/removing memory media, see [▶Connecting a USB Memory Device\(P. 23\)](#) .
- For instructions on using memory media, see [▶Working with Data in Memory Media\(P. 739\)](#) .
- Depending on the file format, an optional product may be required. [▶System Options\(P. 1597\)](#)

Copying Files to a Folder for Printing (Hot Folder)

961F-0AA



Files can be printed simply by copying them to a hot folder created in the shared folder of the Advanced Box. Print settings do not need to be specified from the printer driver because they can be specified for each folder.

▶ **Adding a Hot Folder(P. 623)**

▶ **Storing Files to a Hot Folder for Printing(P. 624)**

NOTE

- When using a hot folder, it is necessary to change the following Advanced Box settings in advance. For details, see ▶ **Setting Advanced Space to Public(P. 321)** .
 - <Advanced Space> ▶ <Open to Public> ▶ <By SMB> or <By WebDAV>
 - <Advanced Space> ▶ <Prohibit Writing from External> ▶ <Off>

Adding a Hot Folder

- 1 Start the Remote UI.** ▶ **Starting the Remote UI(P. 902)**
- 2 Click [Settings/Registration] on the portal page.** ▶ **Remote UI Screen(P. 904)**
- 3 Click [Printer] ▶ [Hot Folder Management].**
- 4 Click [Add Folder].**
- 5 Enter the folder name of the hot folder, and specify the required settings.**

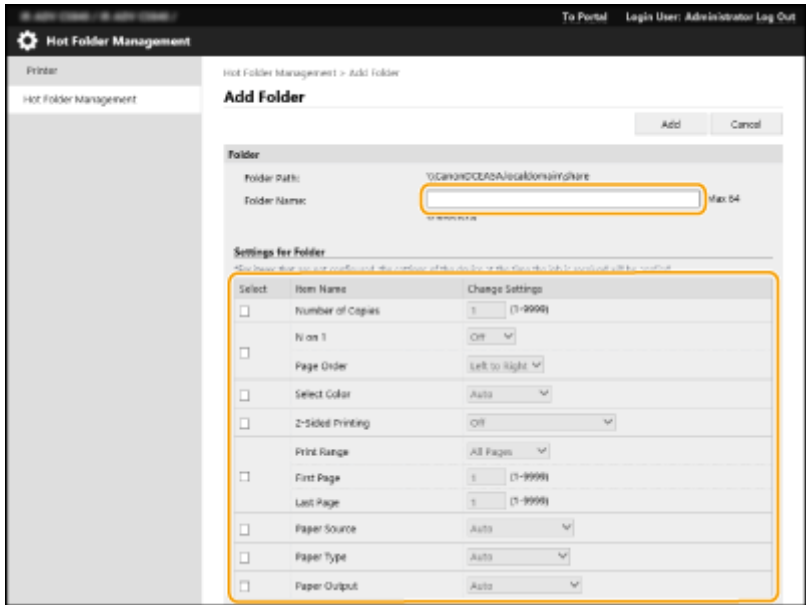

NOTE

- Multiple folders with the same folder name cannot be registered.
- A folder with the same name as an existing folder in the shared folder cannot be registered.
- A maximum of 20 hot folders can be registered.

6 Click [Add].

➡ The path to the generated hot folder is displayed.

NOTE

- Hot folders are generated directly below the shared folder of the Advanced Space.
- The specifications of added folders are the same as the Advanced Space. For details on the specifications of the Advanced Space, see **Storage Space Functions(P. 1585)**.
- The generated hot folder can be renamed and deleted from the Advanced Box. It still functions as a hot folder after being renamed.
- This setting can only be specified by a user with Administrator privileges.
- This setting can be imported/exported with models that support batch importing of this setting.
- When performing batch exporting, this setting is included in [Settings/Registration Basic Information].
- Hot folders may not operate correctly when the Advanced Space is backed up or restored. When the Advanced Space is backed up or restored, check the settings on the [Hot Folder Management] screen and change them as required.

Storing Files to a Hot Folder for Printing

IMPORTANT

- Files stored in the hot folder are deleted after printing. When storing files in a folder, store a copy rather than the original files.

■ When Disclosed via SMB

- 1 Display Windows Explorer.**
- 2 Enter the address of the Advanced Space in the address entry field, and press the [ENTER] key on the keyboard.**
 - Enter the folder path used when adding the hot folder.
 - ⇒ The content of the Advanced Space is displayed.

NOTE

- When using an IPv6 address, enter the IP address enclosed in square brackets ([]).

- 3 Store the files for printing to the hot folder.**

⇒ Printing starts.

■ When Disclosed via WebDAV

- 1 Display Windows Explorer, and click [This PC].**
- 2 Click [Map network drive] on the [Computer] tab.**
- 3 Select the drive from the [Drive] drop-down list.**
- 4 Enter the address in the [Folder] text box, and click [Finish].**
 - Enter the folder path used when adding the hot folder.
 - ⇒ The content of the Advanced Box is displayed.

NOTE

- When using an IPv6 address, enter the IP address enclosed in square brackets ([]).
- When TLS is enabled, enter "https" instead of "http" when entering the address.

- 5 Store the files for printing to the hot folder.**

⇒ Printing starts.

NOTE

Printing

- Files in the PDF, TIFF, or JPEG format can be printed with a hot folder.
- Files cannot be printed when the following security settings are enabled. Remote UI [Hot Folder Management] will also no longer appear.
 - [Use ACCESS MANAGEMENT SYSTEM]
 - <Restrict Job from Remote Device without User Auth.>

Printing Using the Microsoft Cloud Service (Universal Print)

961F-0AC



Universal Print is a Microsoft service that enables you to print documents via the cloud. There is no need to install a printer driver to print documents from your computer. You can also print documents from a remote location as long as your computer is connected to the Internet.

Conditions of Use

To use Universal Print, you must first register as a Microsoft 365 service user and use the Azure Active Directory Service.

NOTE

- You cannot use Universal Print for communication using a sub-line.

Required Settings

Administrator settings

Use the Remote UI to register this machine in Azure Active Directory. [▶Registering This Machine in Azure Active Directory\(P. 628\)](#)

User settings

Configure your computer so that Universal Print can be used. [▶Configuring a Printer Registered in Azure Active Directory on the Computer\(P. 630\)](#)

NOTE

When a proxy server is used

- To use Universal Print via a proxy server, you must also configure the proxy settings on your computer.

Associating Users and Universal Print Jobs

You can associate Universal Print jobs with users authenticated through User Authentication. You can still use Universal Print without configuring these settings. [▶Configuring the Universal Print User Settings\(P. 631\)](#)

Printing with Universal Print

See the Microsoft website for information on printing with Universal Print.

! IMPORTANT

- In some operating systems, print errors or problems with the print results may occur. See Universal Print Troubleshooting on the Microsoft website for information on the compatibility of your operating system.

NOTE

- If Forced Hold printing is enabled, Universal Print jobs will run as specified in the <Forced Hold> settings. ▶
<Forced Hold>(P. 1301)

Registering This Machine in Azure Active Directory

- 1 Start the Remote UI. ▶Starting the Remote UI(P. 902)**
- 2 Click [Settings/Registration] on the portal page. ▶Remote UI Screen(P. 904)**
- 3 Click [Network Settings] ▶ [Settings for Universal Print].**
- 4 Click [Edit...] for [Basic Settings].**
- 5 Select the [Use Universal Print] checkbox and enter the printer name in the [Printer Name] field.**
 - To verify the server certificate sent from the server, select the [Verify Server Certificate] checkbox.
 - To add CN (Common Name) to the items to be verified, select the [Add CN to Verification Items] checkbox.
 - Change the [Application ID], [Azure Active Directory Authentication URL] or [Azure Active Directory Registration URL] settings according to your cloud environment.
- 6 Click [OK].**
- 7 Click [Register...] in [Registration Status].**
- 8 Wait a few seconds, and then click [↔].**

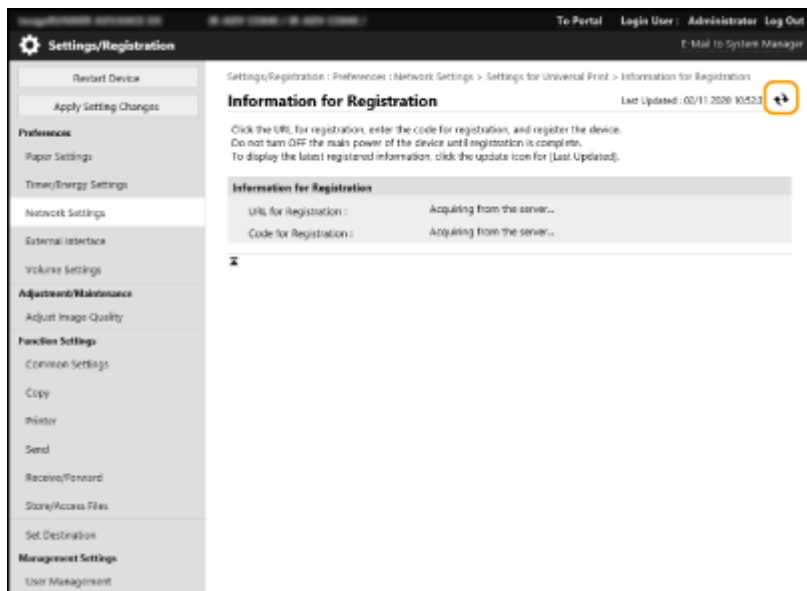

9 Click the URL link displayed for [URL for Registration].

10 Follow the instructions on the screen to register the machine.

11 Wait a few minutes, and then click [↻] in the Remote UI screen.

⇒ Once registration is completed, [Registered] appears in [Registration Status].

12 View the Universal Print management screen of Azure Active Directory in your web browser.

13 Select the registered machine and click [Share Printer].

- To change the name displayed on the computer, enter the new name in [Printer Share Name], and then click [Share Printer].

⇒ [Printer shared.] appears at the top right of the screen.

14 Click [Members], and then click [Add].

15 Select the members and groups who will use the registered printer from the list.

- The selected members and groups will be able to use the printer.

■ To Delete a Registered Printer

1 Start the Remote UI. ▶ Starting the Remote UI(P. 902)

- 2** Click [Settings/Registration] on the portal page. ▶ Remote UI Screen(P. 904)
- 3** Click [Network Settings] ▶ [Settings for Universal Print].
- 4** Click [Registration Status] for [Unregister].
- 5** Click [OK].
- 6** View the Azure Active Directory device management screen in your web browser.
- 7** Select the model to be deleted and click [Delete].

Configuring a Printer Registered in Azure Active Directory on the Computer

- 1** Click [Windows] ▶ [Settings] ▶ [Accounts].
- 2** Click [Access work or school] ▶ [Connect].
- 3** Follow the on-screen instructions to sign in to your Microsoft 365 account.
- 4** Click [Home] ▶ [Devices].
- 5** Click [Printers & scanners] ▶ [Add a printer or scanner].
- 6** Select a registered printer from the list.

Configuring the Universal Print User Settings

961F-0AE

Configure these settings if you want to manage users authenticated through User Authentication and their associated Universal Print jobs. Universal Print can still be run without configuring these settings.

- ▶ **Set by the User(P. 631)**
- ▶ **Set by the Administrator(P. 631)**
- ▶ **Set by the Administrator Using a CSV File(P. 632)**

Set by the User

- 1 Start the Remote UI.** ▶ **Starting the Remote UI(P. 902)**
- 2 Click [Settings/Registration] on the portal page.** ▶ **Remote UI Screen(P. 904)**
- 3 Click [User Management] ▶ [Authentication Management].**
- 4 Enter [User Name for Universal Print:] in [Information for Universal Print].**
 - In [User Name for Universal Print:], enter the email address or phone number used in the Microsoft 365 account.

Set by the Administrator

- 1 Start the Remote UI.** ▶ **Starting the Remote UI(P. 902)**
- 2 Click [Settings/Registration] on the portal page.** ▶ **Remote UI Screen(P. 904)**
- 3 Click [User Management] ▶ [Authentication Management].**
- 4 Click [Edit...] for the user to be set.**

NOTE:

If the Universal Print user is not registered

- Click [Add User] and register the user information. When registering the user information, enter the [User Name for Universal Print:] in [Information for Universal Print].

- 5 Enter [User Name for Universal Print:] in [Information for Universal Print].**

- In [User Name for Universal Print:], enter the email address or phone number used in the Microsoft 365 account.

6 Click [Update].

Set by the Administrator Using a CSV File

You can associate User Authentication users with a Microsoft 365 account by editing a CSV file.

1 Start the Remote UI. ▶ Starting the Remote UI(P. 902)

2 Click [Settings/Registration] on the portal page. ▶ Remote UI Screen(P. 904)

3 Click [User Management] ▶ [Authentication Management] ▶ [Settings for Universal Print].

4 Click [Start Exporting].

- If there is no user information that is associated with a Microsoft 365 account, you cannot configure the settings using a CSV file. Click [Add Association...], add the associated user and then click [Start Exporting].

5 Editing the exported CSV file

- Enter a registered user name in "mcp_uid".
- In "azureaccount_name", enter the email address or phone number used in the Microsoft 365 account.

6 Click [Import...] and specify the file edited in step 5.

7 Click [Start Importing].

NOTE

- If the authentication method is set to [Picture Login] and [User Registration Method:] is set to [Register Automatically When Job Is Received], the following information is registered as the user information for a job executed by the Microsoft 365 account called "user1@example.com".
 - Settings registered in the user database
User name: user1@example.com
 - Universal Print settings
User name: user1
Microsoft 365 account: example.com
 - Information displayed on the login screen for Picture Login
user1
example.com

Setting <Allow Use of @ in User Name> to <On> enables you to register "user1@example.com" as the user name. ▶<Allow Use of @ in User Name>(P. 1328)

- When printing, select "user1@example.com" on the control panel to log in ▶ select <Print> ▶ execute printing.

Scanning

Scanning	635
Scan Basic Features Screen	637
Basic Operations for Scanning Originals	640
Checking Status and Log for Scanned Documents	656
Scanning Clearly	658
Adjusting Image Quality	659
Adjusting Density	660
Adjusting Sharpness When Scanning (Sharpness)	661
Erasing Dark Borders When Scanning (Erase Frame)	662
Scanning Efficiently	664
Sending/Saving Different Size Originals Together (Different Size Originals)	665
Scanning a Facing Page Original and Storing/Sending it as Two Separate Pages	666
Scanning to Make a Booklet (Booklet Scan)	668
Sending/Saving Separately Scanned Documents Together (Job Build)	670
Useful Scanning Functions	672
Skipping Blank Pages When Scanning	673
Checking Scanned Originals Before Sending/Saving (Preview)	675
Sending/Saving at a Specified Time	677
Notifying You by E-Mail of the Completion of Sending/Saving	679
Scanning with the OCR Function	681
Enhancing the Security of Electronic Files	686
Recalling Previously Used Settings for Sending/Saving (Previous Settings)	691
Setting a File Name	693
Specifying E-Mail Settings	695
Using Your Computer to Scan (Remote Scan) (Windows)	697
Using Color Network ScanGear 2	698
Scanning Originals from an Application	700
Using WSD	702
Scanning Originals Using WSD (WSD Scan)	703

Scanning

961F-0AF

Scanning paper originals enables you to convert them into electronic files, such as PDF, commonly supported by a computer. Converted files can be sent as e-mail attachments from the machine, or saved in a file server. This chapter describes a variety of useful functions for easy scanning as well as basic operations.

■ Introduction to Basic Operations

This section describes the Scan Basic Features screen and the basic sending/saving methods.

- ▶ **Scan Basic Features Screen(P. 637)**
- ▶ **Basic Operations for Scanning Originals(P. 640)**

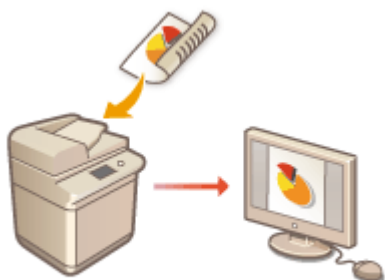

■ Scanning Clearly

This section describes the methods to solve problems such as blurry photographs, illegible text due to dark paper, and the appearance of dark borders.

- ▶ **Scanning Clearly(P. 658)**



■ Scanning Various Types of Originals

You can efficiently scan originals with many pages and originals made up of multiple documents.

▶ **Scanning Efficiently(P. 664)**



■ **Efficiently, Reliably, Safely**

This section describes a variety of functions useful for increasing working efficiency, avoiding operation errors, and enhancing security.

▶ **Useful Scanning Functions(P. 672)**



■ **Scanning Using a Computer**

If you are editing a scanned document in a computer, save directly into the computer for convenience.

▶ **Using Your Computer to Scan (Remote Scan) (Windows) (P. 697)**

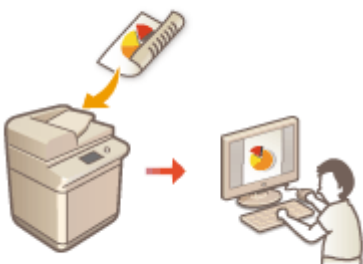

Scan Basic Features Screen

961F-0AH

Pressing <Scan and Send> (▶<Home> Screen(P. 332)) displays the Scan Basic Features screen.

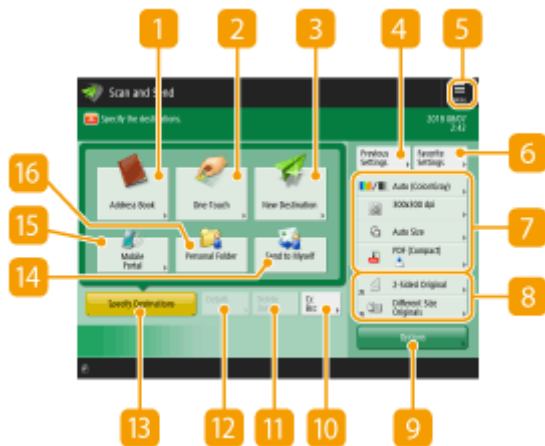

1 <Address Book>

Enables you to specify a sending destination and a save location registered in the Address Book.

2 <One-Touch>

Enables you to specify a sending destination and a save location registered in one-touch buttons.

3 <New Destination>

Enables you to specify destinations manually that are not registered in the Address Book or one-touch buttons.

4 <Previous Settings>

Press to recall the previously specified settings. ▶ **Basic Operations for Scanning Originals(P. 640)**

5 ☰

Press this icon to register the current settings in <Favorite Settings> of 6 and change the button displayed in 8.

▶ **Managing the Machine(P. 790)**

▶ **Customizing the Basic Features Screen(P. 370)**

6 <Favorite Settings>

Register frequently used scan settings here in advance to easily recall them when necessary. ▶ **Managing the Machine(P. 790)**

7 Current setting status and setting buttons

Displays setting status such as the resolution and file formats. Make sure to confirm the settings in order to scan properly. To change the settings, press the desired button. ▶ **Basic Operations for Scanning Originals(P. 640)**

8 Function setting buttons

Displays the most frequently used buttons from <Options>. You can also press **5** to change which buttons are displayed.

- If the button for the function that you want to use is not displayed, press <Options> and select the desired button. ▶ **Basic Operations for Scanning Originals(P. 640)**

9 <Options>

Displays all of the function setting buttons. For convenience, you can display frequently used function setting buttons in **8**.

10 <Cc Bcc>

Enables you to specify e-mail destinations as Cc or Bcc. ▶ **Basic Operations for Scanning Originals(P. 640)**

11 <Delete Dest.>

Enables you to delete the specified destination.

12 <Details>

Enables you to check the detailed information about the specified destination.

13 <Specify Destinations>

Displays the methods for specifying destinations or a list of specified destinations.

14 <Send to Myself>

Enables you to directly specify your own e-mail address. This button is available only when you are logged in to the machine with personal authentication management. ▶ **Managing Users(P. 803)**

15 <Mobile Portal>

Enables you to specify a destination from the address book of a mobile device.

- ▶ **Basic Operations for Scanning Originals(P. 640)**

16 <Personal Folder>

Enables you to specify your personal folder registered as a save location. This button is available only when you are logged in to the machine with personal authentication management.

- ▶ **Configuring Personal Folders(P. 846)**

- ▶ **Managing Users(P. 803)**

NOTE

- You can select whether to hide the Address Book and one-touch buttons to restrict use of the Address Book. ▶ **<Restrict Address Book Use>(P. 1227)**
- Some functions cannot be used in combination with each other. Buttons that cannot be selected are displayed in light gray.
- The total number of specified destinations is displayed on the top right of the screen.

LINKS

▶ **Registering Destinations(P. 389)**

Basic Operations for Scanning Originals

961F-0AJ

This section describes the basic operations for scanning originals.

1 Place the original. [▶Placing Originals\(P. 39\)](#)

NOTE

- When the screen for selecting the original thickness appears, select the thickness of the original being used. (Appears if <Original Thickness Defaults for Scan from Feeder> is set to <Always Specify>. [▶<Original Thickness Defaults for Scan from Feeder>\(P. 1189\)](#))

2 Press <Scan and Send>. [▶<Home> Screen\(P. 332\)](#)

3 Specify the destination on the Scan Basic Features screen. [▶Scan Basic Features Screen\(P. 637\)](#)

- [▶Specifying Destinations from the Address Book](#)
- [▶Specifying Destinations from One-Touch Buttons](#)
- [▶Entering Destinations Manually](#)
- [▶Specifying Destinations in the LDAP Server](#)
- [▶Specifying Your Own E-Mail Address](#)
- [▶Specifying Personal Folder](#)
- [▶Specifying Destinations from the Address Book of a Mobile Device](#)
- [▶Specifying Addresses in Cc/Bcc](#)

NOTE:

- To specify multiple destinations, press <Specify Destinations> and specify an additional destination.
- To delete a destination, select the destination you want to delete, and press <Delete Dest.>.
- You can select a destination and press <Details> to confirm the detailed information for the destination.
- You can only change destinations from <Details> specified using the New Destination and destinations obtained via an LDAP server.
- If the server machine is performing the System Manager information settings, authentication between the server machine and the client machine is performed while the client machine is obtaining the Remote Address Book/one-touch buttons. Authentication is performed by matching the System Manager ID and System Manager PIN set by the server machine and client machine. [▶Changing the System Manager ID and PIN\(P. 840\)](#)

The availability of the Remote Address Book/one-touch buttons depends on the status of the System Manager information settings for the server machine and client machine, as shown below.

When the server machine is performing the System Manager information settings	When the client machine is performing the System Manager information settings	The System Manager ID and System PIN for the server machine and client machine match	Can use the Remote Address Book/One-Touch Button
Performing	Performing	Matches	Yes
		Does Not Match	No
	Not Performing	-	No

When the server machine is performing the System Manager information settings	When the client machine is performing the System Manager information settings	The System Manager ID and System PIN for the server machine and client machine match	Can use the Remote Address Book/One-Touch Button
Not Performing	Performing	-	Yes
	Not Performing	-	Yes

Specifying Destinations from the Address Book

1 Press <Address Book>.

2 Select the destination and press <OK>.

- If an access number is set when the destination is registered, press <Access No.> and enter the access number using the numeric keys. The corresponding destination is displayed in the Address Book.
- To use the Remote Address Book, press <To Remote Address Book>. When <Change Address Book> is displayed, press <Change Address Book> ► <Remote>.



a Destination type buttons

Pressing , , and  displays e-mail, file server, and group destinations, respectively.

b Drop-down list for selection of Address Book types

When you are logged in to the machine with personal authentication management, selecting <Personal Address List> displays your personal Address Book. You can also display dedicated user group address lists (User Group Address Lists) in which you are included.

c <Search by Name>

Enables you to search the destination by the name you are entering.

d Search buttons by first letter

Enables you to narrow down a search by the first letter of the destination name.

NOTE

- <Register New Destination>, <Details/Edit>, and <Delete> on the <Address Book (Local)> screen can be used to register new destinations, check details, and edit/delete destinations.  **Registering Destinations(P. 389)**

- To use the Remote Address Book, it is necessary to configure the server machine settings. Set to open the Remote Address Book externally on the server machine.

Specifying Destinations from One-Touch Buttons

1 Press <One-Touch>.

2 Select the desired one-touch button and press <OK>.

- To specify the destination using a one-touch button number (one-touch number), press  and enter the number for the desired one-touch button.
- To use the Remote Address Book, press <To Remote Address Book>.

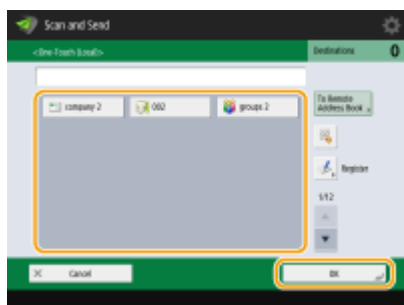

NOTE

- To select a destination from the <One-Touch> screen after scanning, set <One-Touch> for <Default Screen>. The work required for sending scanned documents to the same destination can be reduced.
▶<Default Screen>(P. 1227)
- The destinations registered in the one-touch buttons of the server machine are updated in the following times:
 - When a fax job has been sent on the client machine
 - When you press  (Reset) on the client machine
 - When Auto Reset is activated on the client machine

Entering Destinations Manually

You can specify destinations manually that are not registered in the Address Book or one-touch buttons.

1 Press <New Destination> and select the destination type (<E-Mail> or <File>).

NOTE

- Selecting <I-Fax> enables you to send scanned documents as a fax via the Internet.

If <Store in Mail Box> appears as the destination type

- Selecting <Store in Mail Box> enables you to save scanned documents in the Mail Box of the machine.

- When <Store in Mail Box> is selected, you can send "Mail Box Incoming Notice" to the address specified in **<Set/Register Mail Boxes>(P. 1288)** by selecting <URL Send>.
- You can only select one mail box in <Store in Mail Box>.
- If the URL Send mode is set, you cannot send to a group address that includes a mail box as a destination.

2 Specify the destination and press <OK>.

NOTE

- You can press <Register to Address Book> to register the entered destination. Set the required conditions, and specify <Name> and <Address List>. For information on the settings, see **<Registering Destinations in the Address Book>(P. 394)** .
- If you select <File> in step 1, specify the settings such as the IP address of a file server and the path of the save location folder. For details about the setting items, consult your network administrator.

Specifying Destinations in the LDAP Server

You can search and specify destinations registered in the LDAP server.

1 Press <Address Book>.

2 Press <To LDAP Server>.

- When <Change Address Book> is displayed, press <Change Address Book> ► <LDAP Server>.
- If the network password input screen is displayed, enter the user name and password and press <OK>.

3 When searching destinations in the LDAP server, press either <Search by Conditions> or <Search by Name>.

- To display all the destinations in the LDAP server, proceed to step 4.

NOTE

- A maximum of 2,000 destinations can be displayed in the search results.

■ When searching by conditions

Press <Search by Conditions>, specify the search conditions on the screen, and press <Start Searching>.



a Search categories

Select a criterion to search for destinations from name, e-mail address, organization name, and organization unit (department name, etc).

b Search conditions

Select a search condition such as a destination name that contains "John" and a department name that begins with "Development."

c Search characters

Press <Set> and enter search characters for the search condition.

NOTE**To search with multiple conditions**

You can search destinations with multiple conditions. Specify the first search condition, press <Add Search Condition>, and then select <or> or <and> for the next condition.

To change conditions and search again

Press <Delete> to delete the specified contents, and specify the conditions again.

■ When searching by name

Press <Search by Name> ► enter the text to search ► press <OK>.

NOTE

You can specify attributes used when performing "Search by Name" for a destination from the LDAP server.

▶ <Settings for Search by Name When Using LDAP Server>(P. 1315)

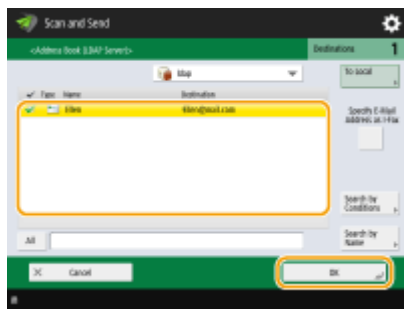
4 Select the destination and press <OK>.**Specifying Your Own E-Mail Address**

You can specify the e-mail address of the user who is logged in to the machine with personal authentication management.

1 Press <Send to Myself>.

⇒ The e-mail address of the user who is logged in to the machine is specified as the destination.

Specifying Personal Folder

You can specify the personal folder of the user who is logged in to the machine with personal authentication management.

1 Specify <Personal Folder>.

⇒ The personal folder of the user who is logged in to the machine is specified as destination.

Specifying Destinations from the Address Book of a Mobile Device

You can specify a destination from the address book of a mobile device.

NOTE

- Only e-mail destinations can be specified from the address book of a mobile device.
- To use this function, you must install the "Canon PRINT Business" application to your mobile device.
 - ▶ **Utilizing the Machine through Applications(P. 770)**

1 Connect to the mobile device. ▶ **Connecting with Mobile Devices(P. 765)**

2 Send the address from the mobile device to the machine.

- For detailed information on operations using the mobile device, see the Help of the application.

NOTE

- You can send information including the subject, message body, and file name from the mobile device to the machine. ▶ **Specifying E-Mail Settings(P. 695)**

Specifying Addresses in Cc/Bcc

E-mail addresses can be specified in Cc (Carbon copy) and Bcc (Blind carbon copy).

1 Press <Cc Bcc>.

2 Press <Cc> or <Bcc> ▶ <Specify Destinations>.

NOTE

- To move a destination from Cc or Bcc, press <To/Bcc|Cc> or <To/Cc|Bcc> and specify the destination to move to To, Cc, or Bcc.

3 Specify the destination ▶ press <OK>.

- For information on specifying the destination, see the method for specifying each type of destination.

NOTE

- A destination other than an e-mail destination can be specified with <Specify Destinations>, but cannot be specified in Cc or Bcc or moved to Cc or Bcc.

4 Specify the scan settings as necessary.

- ▶ Selecting a File Format
- ▶ Selecting Resolution
- ▶ Specifying the Scanning Size of Originals

- ▶ Selecting Color Scan/Black & White Scan
- ▶ Scanning Both Sides of Originals
- ▶ Enlarging or Reducing

Selecting a File Format



Scanned originals are converted into electronic files such as PDF. Select the file format according to your purposes and environment of use.

1 Press the setting button for file format.

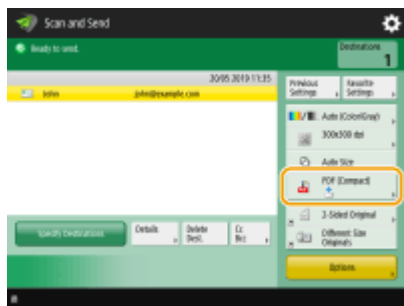

2 Select the file format.

<JPEG>	This file format is suitable for photographic originals. Multiple-page originals will be divided into one file per page.
<TIFF>	This file format is suitable for graphical originals. Originals are scanned in black and white.
<PDF>	This file format is suitable for text documents. Documents can be displayed in the same way on any computer, regardless of the operating system used.
<XPS>	This is a file format taken from Windows Vista. Documents can be displayed in the same way on any Windows computer, regardless of the operating system used.
<OOXML>	This file format can be edited in Microsoft Office Word or PowerPoint.

■ If you selected <PDF>, <XPS>, or <OOXML>

You can set various additional functions.

- For details of the additional functions, see the help screen displayed when you press at the top right of the screen.

■ If you selected <JPEG> or <TIFF>

This completes the procedure. Press <OK>.

NOTE

- <PDF (Trace & Smooth)> is only valid with the following settings:
 - Select Color: Color mode other than the Black-and-White mode
 - Resolution: 300 dpi x 300 dpi
 - Copy Ratio: 100% or Auto
- <PDF (Compact)>, <PDF (Limited Color)> or <XPS (Compact)> is only valid with the following settings:
 - Select Color: Color mode other than the Black-and-White mode
 - Resolution: 300 dpi x 300 dpi
 - Copy Ratio: 100% or Auto
- <Word> documents to which <OOXML> is set can only be sent with the following settings.
 - Select Color: Color mode other than the Black & White mode
 - Resolution: 300 dpi x 300 dpi
 - Copy Ratio: 100% or Auto
- <PowerPoint> documents to which <OOXML> is set can only be sent with the following settings.
 - Select Color: Color mode other than the Black & White mode
 - Resolution: 300 dpi x 300 dpi or 600 dpi x 600 dpi
 - Copy Ratio: 100% or Auto
- You cannot set <Trace & Smooth> for the file format and <Long Original> for the scan size at the same time.
- If you select <PDF (Trace & Smooth)>, the machine may be unable to recognize which parts of the scanned document are text and line drawings, depending on the scanned document.
- The text and background of PDF files containing outline data may become misaligned, and text and line drawings may not be displayed, depending on the version of Adobe Illustrator used to open the PDF.

When creating files by pages

- To scan a multiple-page original and save each page as a separate file instead of saving all pages as a single file, press <Divide into Pages>.
- To specify the number of pages to include in each file, after pressing <Divide into Pages>, specify the desired number of pages. To save each page as a separate file, specify <1> for the number of pages.
- If you select <TIFF/JPEG>, each page will automatically be created as a separate file according to the Select Color mode.
 - When Black & White is set for the Select Color mode: TIFF
 - When a setting other than Black & White is set for the Select Color mode: JPEG
- You cannot specify the number of pages to include in one file if you are currently using the <Scan and Store> function.

TIPS

Installing an option can expand functions for scanning to create files. For information on the required optional products and on the file formats, see **System Options(P. 1597)** .

Selecting Resolution

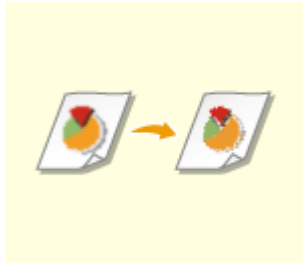

To scan an original clearly, increase the resolution. To reduce the file size, decrease the resolution.

1 Press the setting button for resolution.



2 Select the resolution and press <OK>.

- Depending on the file format you are selecting, the resolution that you can select is limited.

Specifying the Scanning Size of Originals



If you are scanning free size/highly transparent originals, or the edge of image is missing when scanning, you need to manually specify the scanning size.

1 Press the setting button for scanning size.



2 Select the scanning size and press <OK>.

- To set the machine to detect the size of the original, select <Auto>.

NOTE:

If <A3+> appears in the scanning size

- If you want to scan an A3 original with an image that extends all the way to the edges without the periphery of the original being cut off, place the original on the platen glass and press <A3+>.

■ When scanning a free size original

Place the original in the feeder and select <Free Size>. You can only set a zoom ratio of 100%.

■ When specifying the values of scanning size

Place the original on the platen glass/in the feeder, select <Custom>, and enter the height and width of the original. Sent images are not rotated.

NOTE:

- When a scanning size smaller than the minimum size that can be scanned with the feeder is set, scanning cannot be performed with the feeder. For information on the document sizes that can be scanned with the feeder, see **Hardware Specifications(P. 215)** .

■ When scanning a long original

Place the original in the feeder and select <Long Original>. You can only set a zoom ratio of 100%.

NOTE

To register the scanning size

- If you frequently specify the scanning size with the same values, register the size in <Custom>
 - ▶ <Register Size> to quickly recall the setting for convenience.

If the scanning size is specified

- Documents that are scanned using a specified scan size (<Custom>, <Long Original>, or <Free Size>), cannot be stored in a mail box.
- If you are currently using the <Scan and Store> function, you cannot select <Long Original>.

Selecting Color Scan/Black & White Scan



You can specify color when scanning original.

1 Press the setting button for color.

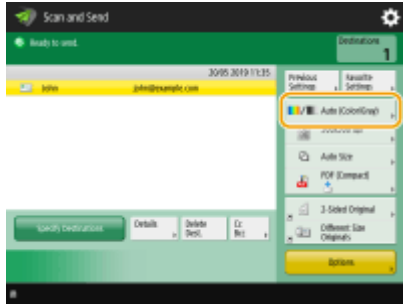

2 Select the color and press <OK>.

- Depending on the file format you are selecting, the setting item that you can select is limited.



a <Auto (Color/Gray)>

Determines automatically what color is used for scanning according to the color of an original. For example, color pages are scanned in color, and monochrome pages are scanned in grayscale (monochrome gradation).

b <Auto (Color/B&W)>

Determines automatically what color is used for scanning according to the color of an original. For example, colored pages are scanned in color, and monochrome pages are scanned in black and white. Select this mode when text is faint with <Auto (Color/Gray)>, or when the original mainly consists of text.

c <Full Color>

Scans in color regardless of a document's color. Depending on the state of the color original, it may be detected as black and white when scanned, even if you set <Auto (Color/B&W)>. To avoid this, set the color mode to <Full Color>.

d <Black & White>

Scans in black and white regardless of an original's color. This mode is automatically set for the TIFF file format.

e <Grayscale>

Scans in grayscale regardless of an original's color. This mode uses different shades of color, such as black, dark gray, gray, light gray, and white, making color look more natural and beautiful compared with <Black & White>.

NOTE

- If a black-and-white original is scanned in the Full Color mode, it is counted as a color scan.
- If you select <JPEG> as the file format, <Black & White> is changed to <Grayscale>.
- If you select <TIFF> as the file format, <Black & White> is set.
- If <OOXML> is selected as the file format, you can only send in <Auto (Color/Gray)>, <Full Color>, or <Grayscale>.

Scanning Both Sides of Originals



The machine can automatically scan both the front and back sides of an original.

NOTE

- Place the original in the feeder. For landscape-oriented originals, place them horizontally.
- If you want to scan each side of the 2-sided originals placed on the platen glass, specify the <Job Build> settings. **▶ Sending/Saving Separately Scanned Documents Together (Job Build)(P. 670)**

1 Press <2-Sided Original>.

2 Select <Book Type> or <Calendar Type> and press <OK>.

- Select <Book Type> for originals whose images on the front and back sides face the same direction, or <Calendar Type> for originals whose images on the front and back sides face in opposite directions.

Enlarging or Reducing



You can enlarge or reduce standard size original to other standard sizes when scanning.

▶ Enlarging or Reducing in Standard Paper Sizes



You can enlarge or reduce by specifying magnification (%).

▶ Enlarging or Reducing by Specifying Magnification



You can enlarge or reduce to automatically fit the paper size selected.
 ▶ Enlarging and Reducing to Fit the Finished Paper Size

■ Enlarging or Reducing in Standard Paper Sizes

1 Press <Options> ▶ <Copy Ratio>.

2 To reduce, select magnification from **a**, to enlarge, select magnification from **b** and press <OK>.



3 Press <Close>.

■ Enlarging or Reducing by Specifying Magnification

1 Press <Options> ▶ <Copy Ratio>.

2 Specify magnification and press <OK>.



3 Press <Close>.

■ Enlarging and Reducing to Fit the Finished Paper Size

1 Press <Options> ▶ <Copy Ratio>.

2 Press <Auto>, specify the finished size, and then press <OK>.

- Depending on the resolution you are selecting, you cannot specify the finished size.



3 Press <Close>.

NOTE

- If you want to send with <Auto>, set the resolution to 300 dpi x 300 dpi or 600 dpi x 600 dpi.
- If you select <Long Original> as the scan size, you can only send documents at a zoom ratio of 100%.

5 Press  (Start).

Originals are scanned and sending/saving starts.

- To cancel scanning, press <Cancel> or  (Stop) ▶ <Yes>.

■ When <Press the [Start] key to scan the next original.> is displayed

Place the next original to scan and press  (Start). When scanning all of the originals is complete, press <Start Sending> to send/save the file.

- Depending on the communication settings, you may be prompted to enter the user name and password. ▶ **Setting E-mail/I-Fax Communication(P. 316)**

NOTE



To check the total number of specified destinations

- The total number of specified destinations is displayed on the top right of the screen. This enables you to confirm that the number of destinations is correct before sending.





To immediately cancel a job that is being sent

If you press  (Stop) on the control panel while a job is being sent, the message <Is it OK to cancel the following Send job?> appears. Press <Yes> to cancel sending.



- You can select <Latest Received Job> or <Job Being Sent> to choose the job to cancel.  **<Job to Cancel When Stop is Pressed>(P. 1237)**
- Press  (Stop) when there are multiple send jobs to display the screen for selecting the send job to cancel. If the send job you want to cancel is not displayed, press <Check Other Jobs> to display <Send Jobs>. Select the job that you want to cancel, and press <Cancel>.

To check the statuses for sent/saved documents

- On the <Status Monitor> screen, you can check the statuses for sent/saved documents. This screen enables you to send/save documents again or cancel sending/saving after checking the statuses.  **<Checking Status and Log for Scanned Documents>(P. 656)**
- When <Display Notification When Job Is Accepted> is set to <On>, the <Status Monitor> screen can be displayed from the following screen that is shown after a send job is received.  **<Display Notification When Job Is Accepted>(P. 1237)**



To print the report for the results of sending/saving



- On the Scan Basic Features screen, pressing <Options>  <TX Report> enables you to set to automatically print the report listing the results of sending/saving.
- To set this for each job from <Options>, it is necessary to select <For Error Only> or <Off> in  **<TX Report>(P. 1228)** , and then set <Allow Printing from Options> to <On>.

File name

When a file is sent/saved, its file name is automatically set based on the following format. You can change the setting so that a different name can be assigned.  **<Setting a File Name>(P. 693)**

- When sending by e-mail
"Job numbers (four digits)_page numbers (three digits).file extension name" format, such as "1042_001.jpg"
- When saving in a file server
"The year, month, day, hour, minute, and second the file is saved (14 digits).file extension name" format, such as "20151030133541.jpg"

E-mail subject

- The subject entered in <Default Subject> is automatically set ( **<Default Subject>(P. 1244)**). If you specify a different subject, change the setting, or specify each time you send an e-mail ( **<Specifying E-Mail Settings>(P. 695)**).

When multiple sheets are fed

- Scanning is stopped and the message is displayed on the screen. Follow the instructions to clear the jam. When you have cleared the jam, the resume job screen is displayed. If the machine mistakenly detects multiple sheet feeding, press <Do Not Detect Multi. Sheet Feed> to resume scanning.
- To set the machine in advance to not notify you of multiple sheet feeding, perform one of the following operations.
 - Each time you send/save a document, press <Options> on the Scan Basic Features screen  select <Detect Feeder Multi Sheet Fd.> to disable the setting.

- Set <Set Detection of Feeder Multi. Sheet Feed as Default> to <Off>. [▶<Set Detection of Feeder Multi. Sheet Feed as Default>\(P. 1185\)](#)

TIPS

Determining the top and bottom of the original

- You can set the orientation of the document before scanning so that its top and bottom are positioned correctly when the sent/saved file is displayed on a computer.
- When placing an A4 size original, press <Options> on the Scan Basic Features screen ▶ <Orig. Content Orientation> ▶ <Top at Far Edge> ▶ <OK>.
- When placing large-sized originals such as A3 size, press <Options> on the Scan Basic Features screen ▶ <Orig. Content Orientation> ▶ select <Top at Far Edge> or <Top at Side Edge> according to the orientation of the original ▶ press <OK>.

Specifying multiple destinations including faxes

- Setting <Enable Fax in Scan and Send Function> to <On> enables you to specify fax destinations from the Scan Basic Features screen ([▶<Display Fax Function>\(P. 1065\)](#)). This setting is useful for specifying multiple destinations including faxes, such as when saving a copy of a sent fax in a file server.

Checking scanned images before sending/saving

- You can check scanned images on the preview screen before sending/saving. [▶Checking Scanned Originals Before Sending/Saving \(Preview\)\(P. 675\)](#)

Registering frequently used settings

- You can combine frequently used destinations and scan settings into a button of the machine for later use. By pressing the registered button when scanning originals, you can quickly complete your settings. [▶Registering a Combination of Frequently Used Functions\(P. 367\)](#)

LINKS

- [▶Scanning Clearly\(P. 658\)](#)
- [▶Scanning Efficiently\(P. 664\)](#)
- [▶Useful Scanning Functions\(P. 672\)](#)
- [▶Registering Destinations\(P. 389\)](#)
- [▶Making Simple Edits to Files\(P. 724\)](#)
- [▶Sending I-Faxes\(P. 583\)](#)
- [▶Registering the LDAP Server\(P. 299\)](#)
- [▶Managing Users\(P. 803\)](#)
- [▶Configuring Personal Folders\(P. 846\)](#)
- [▶<Set Destination>\(P. 1310\)](#)

Checking Status and Log for Scanned Documents

961F-0AK

You can check the statuses and communication logs for sent and saved documents.

- ▶ **Checking the Statuses for Sent/Saved Documents(P. 656)**
- ▶ **Checking If Documents Are Sent or Saved Successfully(P. 656)**

NOTE

- When personal authentication management is used, you can restrict users from performing operations on the jobs of other users on the <Status Monitor> screen. ▶ **<Restrict Access to Other User Jobs>(P. 1339)**

Checking the Statuses for Sent/Saved Documents

1 Press  (Status Monitor).

2 Press <Send> ▶ <Job Status>.

3 Check the statuses.

- Selecting a document and pressing <Details> enables you to check detailed information such as destinations and the number of pages.
- Selecting a document and pressing <Cancel> enables you to cancel sending/saving.
- Pressing <Print List> prints a status list of sent/saved documents displayed on the screen.

NOTE

- Pressing <Details> ▶ <Resend> enables you to resend/resave the documents that failed to send/save. To specify another destination, press <Change Destination>. For documents with multiple destinations specified using the same sending/saving method, press <Broadcast List>, select a destination, and then press <Resend> or <Change Destination>.
- You can resend/resave documents when <Delete Failed TX Jobs> is set to <Off>. ▶ **<Delete Failed TX Jobs>(P. 1231)**
- You can change the destinations of documents that are set to be sent/saved at a specified time as well as documents that failed to send/save. Note that you cannot change the destinations for documents with multiple destinations specified that are being sent/saved, or when entering a new destination is restricted (▶ **Restricting New Destinations(P. 882)**).

Checking If Documents Are Sent or Saved Successfully

1 Press  (Status Monitor).

2 Press <Send> ▶ <Job Log>.

3 Check if documents are sent or saved successfully.

- <OK> is displayed in the <Result> column when a document was sent or saved successfully. If <NG> is displayed, this shows that a document failed to be sent or saved because it was canceled or there was some error.
- You can check the error code by selecting a document and pressing <Details>. You can use the error code to check the causes of errors and their solutions. **▶ Countermeasures for Each Error Code(P. 1469)**
- By pressing <Communic. Mgt. Report>, the displayed send/save log can be printed as a list.

TIPS

Specifying/registering destinations from the send history

- You can specify destinations and register destinations to the address book from the send history on the <Status Monitor> screen. This saves you the effort of directly entering the address, and also helps avoid sending to an incorrect destination due to entering the wrong address.
 - When specifying a destination: <Status Monitor> ▶ <Send> ▶ <Job Log> ▶ select the destination to send to ▶ <Specify as Send Destination> ▶ <OK>
 - When registering a destination: <Status Monitor> ▶ <Send> ▶ <Job Log> ▶ select the destination to register ▶ <Register Destination> ▶ register the destination from the registration screen for each destination type
- ▶ Registering Destinations in the Address Book(P. 394) ▶ Registering a Destination in a One-Touch Button(P. 410)**

LINKS

- ▶ **Sending/Saving at a Specified Time(P. 677)**
- ▶ **Printing a List of Usage History(P. 1027)**
- ▶ **Outputting a Communication Result Report(P. 1029)**

Scanning Clearly

961F-0AL

For catalogs with many photographs included, reports written in pencil, and thick magazines, adjusting the density and sharpness and erasing unnecessary shadows can scan originals clearly.



▶ Adjusting Image Quality(P. 659)



▶ Adjusting Density(P. 660)

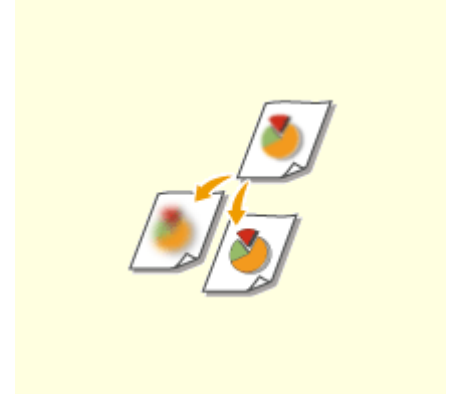

▶ Adjusting Sharpness When Scanning (Sharpness)(P. 661)

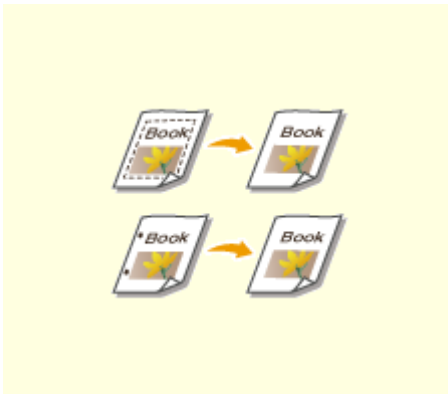

▶ Erasing Dark Borders When Scanning (Erase Frame)(P. 662)

Adjusting Image Quality



You can scan with optimal image quality suitable for your type of original. For example, making the color tone beautiful for originals with photos, while making the contrast sharp for text-only originals, which makes it easy to read.

- 1 Place the original. [▶Placing Originals\(P. 39\)](#)
- 2 Press <Scan and Send>. [▶<Home> Screen\(P. 332\)](#)
- 3 Specify the destination on the Scan Basic Features screen. [▶Scan Basic Features Screen\(P. 637\)](#)
- 4 Press <Options> ▶ <Original Type>.
- 5 Select the type of original and press <OK>.
 - To adjust the text/photo processing priority level, press <Adjust Level> ▶ select <Text Priority> or <Photo Priority>.
- 6 Press <Close>.
- 7 Press  (Start).
 - ⇒ Originals are scanned and sending/saving starts.

NOTE



- If the phenomenon called moire (striped pattern noise) occurs when scanning an original, adjust the sharpness. [▶Adjusting Sharpness When Scanning \(Sharpness\)\(P. 661\)](#)
- If <Original Thickness Defaults for Scan from Feeder> is set to <Fixed>, you can select the thickness of paper loaded in the feeder from <Thickness of Feeder Originals>. [▶<Original Thickness Defaults for Scan from Feeder>\(P. 1189\)](#)

Adjusting Density

961F-0AS



You can scan originals more clearly by manually adjusting the density according to the contents of the original. For example, increasing the density enables you to easily read faint characters written in pencil.

- 1 Place the original. ▶ **Placing Originals(P. 39)**
- 2 Press <Scan and Send>. ▶ **<Home> Screen(P. 332)**
- 3 Specify the destination on the Scan Basic Features screen. ▶ **Scan Basic Features Screen(P. 637)**
- 4 Press <Options> ▶ **<Density>**.
- 5 Adjust the density and press <OK>.
 - Press  to decrease the density. Press  to increase the density.

NOTE

To adjust the density of the background

- You can send/store documents such as newspapers, or documents with colored backgrounds clearly. Press <Auto> to automatically adjust the background density.
- Press <Adjust> to manually adjust the background density, and adjust the background density of each color in <Adjust Each Color>.

- 6 Press <Close>.
- 7 Press  (Start).

⇒ Originals are scanned and sending/saving starts.

Adjusting Sharpness When Scanning (Sharpness)

961F-0AU



You can scan the image with clear contours and lines by increasing the sharpness, or soften the image by decreasing the sharpness. Use this function when you want to sharpen blurred text and diagrams, or to reduce moire (a shimmering, wavy pattern) to smoothen the finished image.

- 1 Place the original.** ▶ **Placing Originals(P. 39)**
- 2 Press <Scan and Send>.** ▶ **<Home> Screen(P. 332)**
- 3 Specify the destination on the Scan Basic Features screen.** ▶ **Scan Basic Features Screen(P. 637)**
- 4 Press <Options> ▶ <Sharpness>.**
- 5 Adjust the sharpness and press <OK>.**
 - To sharpen blurred text, adjust the control to <High>.
 - To reduce moire when scanning originals that contain printed photos, such as magazines or pamphlets, adjust the control to <Low>.
- 6 Press <Close>.**
- 7 Press  (Start).**
 - ▣ Originals are scanned and sending/saving starts.

Erasing Dark Borders When Scanning (Erase Frame)

961F-0AW



When scanning originals that are smaller than the scanning size, frame lines of the originals may appear in the scanned image. When scanning a thick book, dark borders may appear. This function enables you to erase these frame lines and dark borders. You can also set the machine to not copy punch holes in the originals.

! IMPORTANT

- Place the original with punch holes on the platen glass. Placing in the feeder may result in damage.

- Place the original. [▶Placing Originals\(P. 39\)](#)
- Press <Scan and Send>. [▶<Home> Screen\(P. 332\)](#)
- Specify the destination on the Scan Basic Features screen. [▶Scan Basic Features Screen\(P. 637\)](#)
- Press <Options> ▶ <Erase Frame>.
- Specify the erasing type and width.

■Erasing the frames in copies of documents

- Press <Erase Original Frame> and check <Original Size>.



- If the size displayed in <Original Size> is different from the size of the original, press <Change> to select the size. Only the original sizes shown on the touch panel display can be scanned.

- Enter the width of the frame to erase.

■Erasing dark borders in copies of books

You can erase the dark borders both in the center and contour lines that appear when you scan facing pages in a book.

- 1 Press <Erase Book Frame> and check <Original Size>.



- If the size displayed in <Original Size> is different from the size of the book, press <Change> to select the size. Only the original sizes shown on the touch panel display can be scanned.

- 2 Press <Center> or <Sides> and enter each erasing width.

■ Erasing punch holes in copies of documents

- 1 Press <Erase Binding> and select the punch hole location.



- 2 Enter the erasing width.

NOTE

- If you want to adjust the width for each border independently, press <Erase Original Frame> or <Erase Book Frame>, and then press <Adjust Independently> to enter the erasing widths.
- If you are using <Erase Binding>, the borders you do not select are also erased by 4 mm.

- 6 Press <OK> ► <Close>.

- 7 Press  (Start).

⇒ Originals are scanned and sending/saving starts.

Scanning Efficiently

961F-0AX

This section describes convenient functions, such as scanning different size originals at once, scanning two facing pages onto separate pages, and scanning a large number of originals separately to put into one.

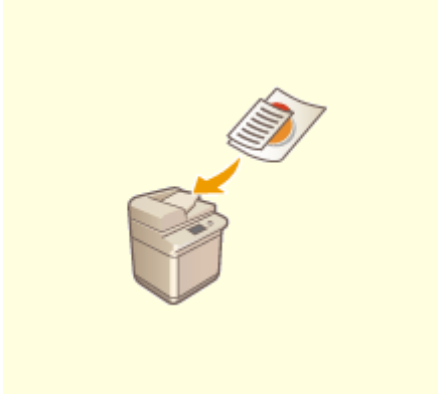

▶ **Sending/Saving Different Size Originals Together (Different Size Originals)(P. 665)**

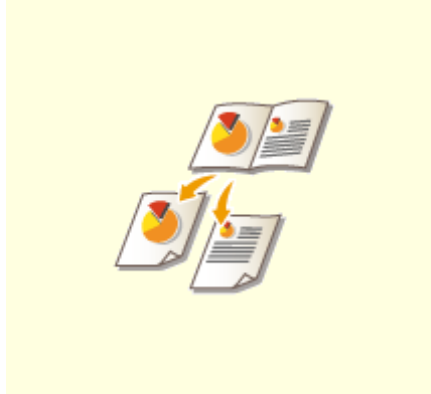

▶ **Scanning a Facing Page Original and Storing/Sending it as Two Separate Pages(P. 666)**

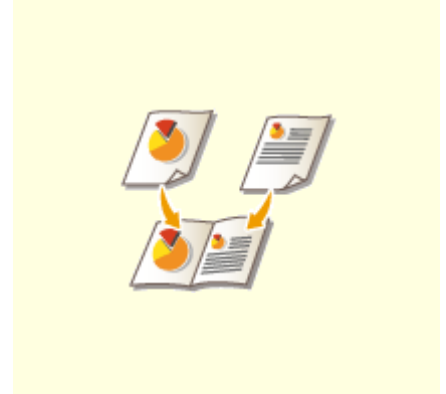

▶ **Scanning to Make a Booklet (Booklet Scan)(P. 668)**



▶ **Sending/Saving Separately Scanned Documents Together (Job Build)(P. 670)**

Sending/Saving Different Size Originals Together (Different Size Originals)

961F-0AY



You can place different size originals in the feeder and scan them at the same time. This eliminates the need to place originals separately.

! IMPORTANT

- The combination of original sizes that you can scan is limited. Scanning with an improper combination may cause damage to the originals or paper jams. ▶ **Hardware Specifications(P. 215)**
- Do not place the originals together that are of different weights or paper types. Doing so may cause damage to the originals or paper jams.

- 1 Place the originals in the feeder.** ▶ **Placing Originals(P. 39)**
- 2 Press <Scan and Send>.** ▶ **<Home> Screen(P. 332)**
- 3 Specify the destination on the Scan Basic Features screen.** ▶ **Scan Basic Features Screen(P. 637)**
- 4 Specify the scan settings as necessary.** ▶ **Basic Operations for Scanning Originals(P. 640)**
- 5 Press <Options> ▶ <Different Size Originals>.**
- 6 Press <Close>.**
- 7 Press  (Start).**

⇒ Originals are scanned and sending/saving starts.

Scanning a Facing Page Original and Storing/Sending it as Two Separate Pages

961F-0C0



You can scan two facing pages in a book or magazine onto separate pages in one operation.

NOTE

- When scanning facing pages of a book or bound original, place the original on the platen glass. Place it face down with its corner aligned with the top-left corner of the platen glass, as shown below.



- 1 Place the original.** ▶ **Placing Originals(P. 39)**
- 2 Press <Scan and Send>.** ▶ **<Home> Screen(P. 332)**
- 3 Specify the destination on the Scan Basic Features screen.** ▶ **Scan Basic Features Screen(P. 637)**
- 4 Specify the scan settings as necessary.** ▶ **Basic Operations for Scanning Originals(P. 640)**
- 5 Press <Options> ▶ <Book ▶ 2 Pages>.**
- 6 Press <Close>.**
- 7 Press  (Start).**

⇒ Originals are scanned and sending/saving starts.

▶ **Erasing Dark Borders When Scanning (Erase Frame)(P. 662)**

Scanning to Make a Booklet (Booklet Scan)

961F-0C1



You can scan to enable printing in the form of a booklet.

NOTE

- This function can only be used when saving to a Mail Box.

1 Place the original. ▶ **Placing Originals(P. 39)**

2 Press <Scan and Store>. ▶ **<Home> Screen(P. 332)**

3 Press <Mail Box>.

4 Select the destination Mail Box.

- For information on the items displayed on the screen and the method for operating them, see ▶ **Editing Files in the Mail Box(P. 729)** .

5 Press <Scan>.

6 Press <Options> ▶ **<Booklet Scan>**.

7 Specify the original size and the paper size for the booklet.



- Press <Change> for <Original Size>, and select the original size. If you select <Auto>, the optimal booklet layout size is automatically selected according to the original size.

- Press <Change> for <Layout Size>, and select the paper size for the booklet.

NOTE

- To print a booklet with the same dimensions as the original, select the paper size for facing pages. If you select the same size for <Original Size> and <Layout Size>, the size of the image is automatically reduced when output.

8 Press <OK> ► <Close>.

9 Press  (Start).

▢▢▢▢ Originals are scanned and saving starts.

IMPORTANT

- Make sure to use the same size for all originals.

NOTE

- Make sure to place portrait originals vertically, because the images for even number pages become upside down if you scan them when placed horizontally.

Sending/Saving Separately Scanned Documents Together (Job Build)

961F-0C2



Even if you have too many originals to be placed in the feeder at the same time, you can scan the originals separately and send/save them as a batch of documents. Originals scanned with both the feeder and the platen glass can also be sent/saved at the same time.

- 1** Place the first original. ▶ **Placing Originals(P. 39)**
- 2** Press <Scan and Send>. ▶ **<Home> Screen(P. 332)**
- 3** Specify the destination on the **Scan Basic Features** screen. ▶ **Scan Basic Features Screen(P. 637)**
- 4** Specify the scan settings as necessary. ▶ **Basic Operations for Scanning Originals(P. 640)**
- 5** Press <Options> ▶ <Job Build> ▶ <Close>.
- 6** Press  (Start) to scan the original.

⇒ When scanning is complete, the screen appears prompting you to scan the next original.

NOTE

- If you place your originals in the feeder, remove the originals from the original output area when the scanning of each batch is complete.

- 7** Place the next original and press  (Start).

- Repeat this step until you finish scanning all of the originals.
- To change the scan settings, press <Change Settings>.

NOTE

- If you place different size originals in the feeder, set the <Different Size Originals> mode. ▶ **Sending/Saving Different Size Originals Together (Different Size Originals)(P. 665)**
- If you want to scan one-sided and two-sided originals and store them as two-sided documents, divide the originals into one-sided and two-sided batches. For example, if the first batch consists of two-sided originals, set the <2-Sided Original> mode. Thereafter, you have to manually set or cancel the <2-Sided Original> mode for each batch of originals that you scan.

- It is useful to store scanned images in a mail box first, and print them later using the Merge Files mode if you cannot prepare the originals at one time, or if you want to specify different settings for each original.
 - ▶ **Printing Files in the Mail Box(P. 734)**
- The following functions can be used in <Change Settings> of <Scan and Send>: You need to set the necessary scan settings in advance, since you cannot change the other functions during the Job Build mode.
 - <Select Color>
 - <Scan Size>
 - <Copy Ratio>
 - <2-Sided Original>
 - <Density>
 - <Original Type>
- The following functions can be used in <Change Settings>, if the <Scan and Store> destination is <Mail Box>. You need to set the necessary scan settings in advance, since you cannot change the other functions during the Job Build mode.
 - <Select Color>
 - <2-Sided Original>
 - <Density>
 - <Original Type>
- If the <Scan and Store> destination is <Mail Box> and you set the <N on 1> mode together with the Job Build mode, you cannot change <Select Color> and <Density> in <Change Settings>.
- The following functions can be used in <Change Settings>, if the <Scan and Store> destination is <Advanced Space>, <Network>, or <Memory Media>. You need to set the necessary scan settings in advance, since you cannot change the other functions during the Job Build mode.
 - <Select Color>
 - <Scan Size>
 - <2-Sided Original>
 - <Density>
 - <Original Type>

8 Press <Start Sending>.

- ▣ All scanned documents are combined into one and sent/saved to the specified destination.

Useful Scanning Functions

961F-0C3

The machine has various useful functions, including skipping originals with blank pages when scanning as well as notifying you of the completion of sending/saving scanned originals.



▶ **Skipping Blank Pages When Scanning**(P. 673)

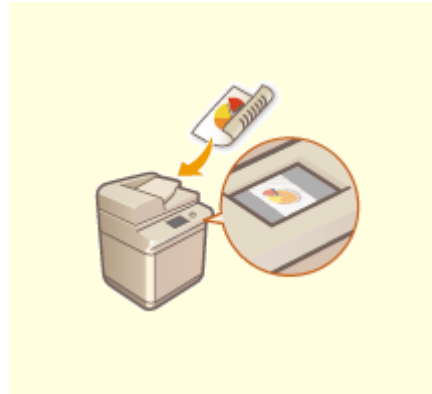

▶ **Checking Scanned Originals Before Sending/Saving (Preview)** (P. 675)



▶ **Sending/Saving at a Specified Time**(P. 677)

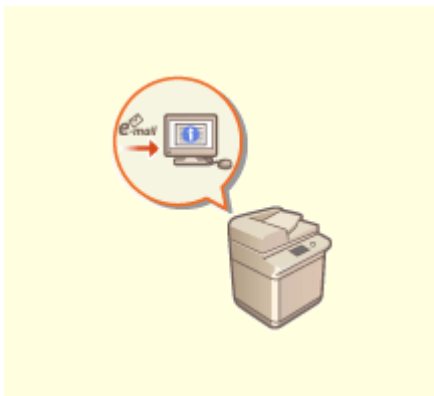

▶ **Notifying You by E-Mail of the Completion of Sending/Saving**(P. 679)



▶ **Scanning with the OCR Function**(P. 681)

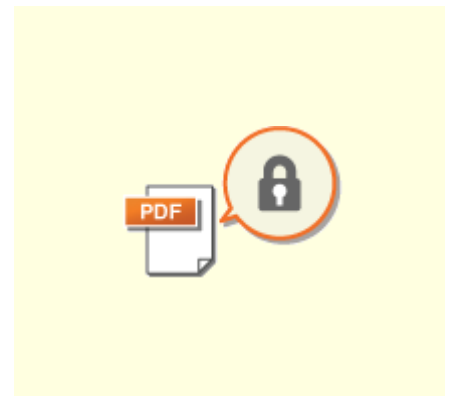

▶ **Enhancing the Security of Electronic Files**(P. 686)



▶ **Recalling Previously Used Settings for Sending/Saving (Previous Settings)**(P. 691)



▶ **Setting a File Name**(P. 693)



▶ **Specifying E-Mail Settings**(P. 695)

Skipping Blank Pages When Scanning

961F-0C4



The machine can detect blank pages when scanning, and send/store all the pages except blank pages.

- 1 Place the original. ▶ **Placing Originals(P. 39)**
- 2 Press <Scan and Send>. ▶ **<Home> Screen(P. 332)**
- 3 Specify the destination on the Scan Basic Features screen. ▶ **Scan Basic Features Screen(P. 637)**
- 4 Specify the scan settings as necessary. ▶ **Basic Operations for Scanning Originals(P. 640)**
- 5 Press <Options> ▶ **<Skip Blank Originals>**.
- 6 Select the color of the originals to skip.

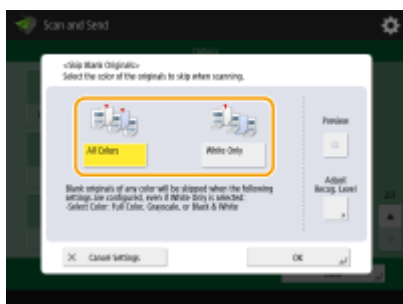

- To skip blank originals regardless of their color, select <All Colors>. To skip blank originals only in white, select <White Only>.
- When something other than <Auto (Color/B&W)> or <Auto (Color/Gray)> is selected in <Select Color>, the same operation as <All Colors> is performed, even if <White Only> is set.

NOTE

- Pressing <Preview> to select the button enables you to check the contents of the scanned originals on the preview screen. <Preview> is not displayed when <Mail Box> is selected in <Scan and Store>. ▶ **Checking Scanned Originals Before Sending/Saving (Preview)(P. 675)**

7 Press <Adjust Recog. Level>, set the accuracy to detect blank paper, and then press <OK>.

- Pressing <+> makes the detection accuracy higher.

8 Press <OK> ► <Close>.

9 Press  (Start).

►► Originals are scanned and sending/saving starts.

IMPORTANT

- Only <E-Mail> or <File> type destinations can be specified when <Skip Blank Originals> is set. Sending cannot be performed if a destination with a type other than <E-Mail> or <File> is set.
- If the size of the original is smaller than the scan size setting, it may not be skipped correctly.

NOTE

- To check the number of pages that have been sent/saved, follow the procedures below:  (Status Monitor) ► <Send> ► <Job Log> ► select a document ► <Details> ► check the number displayed for <Send Pages>
The status screen and Communication Management Report display the number including blank paper. ►
Checking Status and Log for Scanned Documents(P. 656)

Checking Scanned Originals Before Sending/Saving (Preview)

961F-0C5



You can check scanned originals on the preview screen before sending/saving. You can also delete, move, or switch pages on the preview screen.

- 1 Place the original. ▶ **Placing Originals(P. 39)**
- 2 Press <Scan and Send>. ▶ **<Home> Screen(P. 332)**
- 3 Specify the destination on the Scan Basic Features screen. ▶ **Scan Basic Features Screen(P. 637)**
- 4 Specify the scan settings as necessary. ▶ **Basic Operations for Scanning Originals(P. 640)**
- 5 Press <Options> ▶ <Preview> ▶ <Close>.

6 Press (Start).

⇒ Originals are scanned and the preview screen appears.

- To cancel scanning, press <Cancel> or  (Stop) ▶ <Yes>.

■ When <Press the [Start] key to scan the next original.> is displayed

Place the next original to scan and press  (Start). When scanning all of the originals is complete, press <Preview and Send> to display the preview screen.

7 Check the scanned originals on the preview screen.

- Edit the scanned original on the preview screen as necessary.

■ To delete a page

You can delete the page currently displayed on the preview screen.

- 1 Press <Delete Page>.

■ To move a page

You can move a page to the specified destination.

- 1 Press <Edit Scanned Data>.
- 2 Press <Move Page Position>.
- 3 Enter the page numbers corresponding to <Move Page> and <Behind Page>.
- 4 Press <OK>.

■ To switch the locations of pages

You can switch the locations of specified pages.

- 1 Press <Edit Scanned Data>.
- 2 Press <Switch Page Position>.
- 3 Enter the page numbers corresponding to <Target Page A> and <Target Page B>.
- 4 Press <OK>.

8 Press <Start Sending>.

▣▣▣ Sending/saving starts.

Sending/Saving at a Specified Time

961F-0C6



You can scan originals in advance and send/save the scanned documents at a specified time.

- 1** Place the original. ▶ **Placing Originals(P. 39)**
- 2** Press <Scan and Send>. ▶ **<Home> Screen(P. 332)**
- 3** Specify the destination on the Scan Basic Features screen. ▶ **Scan Basic Features Screen(P. 637)**
- 4** Specify the scan settings as necessary. ▶ **Basic Operations for Scanning Originals(P. 640)**
- 5** Press <Options> ▶ **<Delayed Send>**.
- 6** Enter the time to send/save and press <OK>.
 - Enter all four digits of the time. For example, for 5 minutes past 7, enter "0705" and for 18 minutes past 23, enter "2318."



- 7** Press <Close>.
- 8** Press  (Start).

⇒ Originals are scanned and sent/saved at the specified time.

NOTE

- You can check on the <Status Monitor> screen whether sending/saving is complete or not. **▶Checking Status and Log for Scanned Documents(P. 656)**
- You can reserve up to 64 jobs for delayed sending. However, the actual number of send jobs that the machine can handle may be fewer than 64, depending on the following conditions:
 - When multiple documents are being sent at the same time
 - When large documents are being sent
 - When a large amount of memory is being used for the Mail Box and Fax/I-Fax Inbox

LINKS

- ▶**Notifying You by E-Mail of the Completion of Sending/Saving(P. 679)**

Notifying You by E-Mail of the Completion of Sending/ Saving

961F-0C7



You can receive an e-mail notifying that sending/saving documents is complete. Even if documents are waiting to be sent/saved, you can use your computer or portable device to check whether sending documents is complete, giving you reassurance. When an error occurs, you are notified of destinations whose documents failed to be sent/saved.

! IMPORTANT

- To select the destination to notify from <Address Book>, it is necessary to register the destination in advance. ▶ **Registering Destinations in the Address Book(P. 394)**
- To select <Send to Myself> as the destination to notify, it is necessary to register your e-mail address in the user information in advance, and log in using personal authentication management. ▶ **Registering User Information in the Local Device(P. 809)**

- 1 Place the original.** ▶ **Placing Originals(P. 39)**
- 2 Press <Scan and Send>.** ▶ **<Home> Screen(P. 332)**
- 3 Specify the destination on the Scan Basic Features screen.** ▶ **Scan Basic Features Screen(P. 637)**
- 4 Specify the scan settings as necessary.** ▶ **Basic Operations for Scanning Originals(P. 640)**
- 5 Press <Options> ▶ <Job Done Notice>.**
- 6 Specify the notification condition and the destination to notify.**



- If you select <Notice for Any Result>, a notification e-mail is sent for each send job. If you select <Notice Only for Errors>, a notification e-mail is sent only when an error occurs.
- For more information on how to view and use the Address Book, see  **Address Book(P. 389)** .
- If you want to check the content of the sent document, select <Attach TX Image> to attach the first page of the document as a PDF file to a notification e-mail.

7 Press <OK>  <Close>.

8 Press  (Start).

- ▣ Originals are scanned and sending/saving starts. When sending/saving is complete, the notification e-mail is sent to the specified address.

Scanning with the OCR Function

961F-0C8



This mode enables you to perform OCR (optical character recognition) to extract data that can be recognized as text from the scanned image and create a PDF/XPS/OOXML (pptx/docx) file that is searchable. You can also set <Compact> if you select PDF or XPS as the file format.

- ▶ Scanning with OCR(P. 681)
- ▶ OCR Results Are Not Satisfactory(P. 683)

Scanning with OCR

- 1 Place the original. ▶ Placing Originals(P. 39)
- 2 Press <Scan and Send>. ▶ <Home> Screen(P. 332)
- 3 Specify the destination on the Scan Basic Features screen. ▶ Scan Basic Features Screen(P. 637)
- 4 Specify the scan settings as necessary. ▶ Basic Operations for Scanning Originals(P. 640)
- 5 Select a file format.

If you want to separate multiple images and send them as separate files, each of which consists of only one page, press <Divide into Pages> ▶ enter the number of pages to divide by ▶ press <OK>. If you want to scan the images as a single file, press <Divide into Pages> ▶ <Cancel Settings>.

■ To select PDF

- 1 Select <PDF> ▶ press <OCR (Prioritize Speed)> or <OCR (Prioritize Precision)>.

NOTE

- You cannot use OCR (Prioritize Precision) in the following cases:
 - If you selected <OCR (Prioritize Precision)> and <Trace & Smooth>
 - If you selected <OCR (Prioritize Precision)> and <Limited Color>
- If you set both <OCR (Prioritize Precision)> and <Compact>, the <Image Quality Level for Limited Color/Compact> setting is disabled. ▶ <Image Quality Level for Limited Color/Compact>(P. 1190)
- If you create a PDF file with both <OCR (Prioritize Precision)> and <Compact> set, the image quality may differ from a PDF file created with <OCR (Prioritize Speed)> and <Compact> set.
- To change a language to use for OCR, press <OCR Language> ▶ select a language ▶ press <OK>.
- Only European languages can be detected with <OCR (Prioritize Precision)>. ▶ Settings and Languages for OCR Processing(P. 683)

■ To select XPS

- 1 Select <XPS> ► press <OCR (Text Searchable)>.

NOTE

- To change a language to use for OCR, press <OCR Language> ► select a language ► press <OK>.

■ To select the Word format for OOXML

- 1 Select <OOXML> ► <Word>.

NOTE

- To change a language to use for OCR, press <Change> ► select a language or language group ► press <OK>.
- Select a language or language group according to the language used in the scanned documents.

■ To select the PowerPoint format for OOXML

- 1 Select <OOXML> ► <PowerPoint> ► <OCR (Text Searchable)>.
- 2 Select a language to use for OCR ► press <OK>.

6 Press <OK>.

IMPORTANT

- Long strip originals (432 mm or longer) cannot be used with <OCR (Text Searchable)>.

NOTE

- If you select <PDF (OCR)>, <XPS (OCR)>, or <OOXML (OCR)> as the file format, and <Smart Scan> is set to <On> in <OCR (Text Searchable) Settings>/<OCR (Prioritize Speed)>, the orientation of the original is detected, and the document is automatically rotated if necessary before it is sent. ►<OCR (Text Searchable) Settings>(P. 1191)
- If you select <OCR (Text Searchable)>, you can only send at a zoom ratio of <1:1> or <Auto>.
- If you select <PDF> or <XPS> as the file format, you can set <Compact> and <OCR (Text Searchable)> at the same time. In that case, <PDF (Compact)> or <XPS (Compact)> is displayed as the file format on the Scan and Send Basic Features screen.
- If you select <Word> for <OOXML>, you can set to delete the scanned background images. You can generate Word files which are easy to edit without unwanted images. ►<Include Background Images in Word File>(P. 1193)
- If you are currently using the <Scan and Store> function, the OCR language can only be specified when <Word> is selected for <OOXML> or <OCR (Prioritize Precision)> is selected for <PDF>.



OCR Results Are Not Satisfactory

When you create text-searchable PDF/XPS/OOXML files, OCR (Optical Character Recognition) may not be properly processed. This may be because the settings on the machine, or the language, character type or format of the original document are not appropriate for OCR processing.

■ Checking the Machine Settings and Supported Languages

You can improve OCR processing by customizing the machine settings regarding character recognition according to the originals, or by using suitable character types or fonts in the originals so that the machine can recognize the characters.

■ Settings and Languages for OCR Processing

Item	Details
Language Settings for Character Recognition	<p>When a language is specified with OCR selected in <File Format>: Characters are recognized based on the language you select for each file format.</p> <p>When a language is not specified with OCR selected in <File Format>: Characters are recognized based on the language you select in <Switch Language/Keyboard> ( <Switch Language/Keyboard>(P. 1066)).*1</p>
Recognizable Asian Languages*2	<p>Japanese, Chinese (Simplified), Chinese (Traditional), Korean</p> <p> Recognizable Character Types and Fonts (Asian Languages)(P. 683)</p>
Recognizable European Languages and Language Groups	<p>Languages: English, French, Italian, German, Spanish, Dutch, Portuguese, Albanian, Catalan, Danish, Finnish, Icelandic, Norwegian, Swedish, Croatian, Czech, Hungarian, Polish, Slovak, Estonian, Latvian, Lithuanian, Russian, Greek, Turkish, Slovenian*3, Romanian*3, Bulgarian*3, Hebrew*3</p> <p>Language Groups: Western European (ISO)*4, Central European (ISO)*5, Baltic (ISO)*6</p> <p> Recognizable Character Types and Fonts (European Languages)(P. 684)</p>

*1 Displayed languages in the list may vary. If you select English, French, Italian, German, Spanish, Thai, or Vietnamese, the selected language is recognized as Western European (ISO).

*2 Asian languages cannot be detected when <OCR (Prioritize Precision)> is selected.

*3 This can only be selected with <OCR (Prioritize Precision)>.

*4 Including English, French, Italian, German, Spanish, Dutch, Portuguese, Albanian, Catalan, Danish, Finnish, Icelandic, Norwegian, and Swedish.

*5 Including Croatian, Czech, Hungarian, Polish, and Slovak.

*6 Including Estonian, Latvian, and Lithuanian.

■ Recognizable Character Types and Fonts (Asian Languages)

Item	Details
Recognizable Character Types	<p>Japanese: Alphanumeric characters, Kana characters, Kanji characters (JIS first level, and some of the JIS second level), Symbols</p> <p>Chinese (Simplified): Alphanumeric characters, Chinese characters, Symbols (GB2312-80)</p>

Item	Details
	<p>Chinese (Traditional): Alphanumeric characters, Chinese characters, Symbols (Big5)</p> <p>Korean: Alphanumeric characters, Chinese characters, Hangul characters, Symbols (KSC5601)</p>
Recognizable Fonts	<ul style="list-style-type: none"> Multiple fonts are supported. (Ming-cho type is recommended.) Italicized characters cannot be recognized.
Fonts Used for Converted Characters (Only when Word is selected as the file format)	<p>Japanese: Asian characters: MS Mincho European characters: Century</p> <p>Chinese (Simplified): Asian characters: SimSun European characters: Calibri</p> <p>Chinese (Traditional): Asian characters: PMingLiU European characters: Calibri</p>

■ Recognizable Character Types and Fonts (European Languages)

Item	Details
Recognizable Character Types	Alphanumeric characters, Special characters of the recognized language*1, Symbols
Recognizable Fonts	<ul style="list-style-type: none"> Multiple fonts are supported. (Times, Century, and Arial are recommended.)*2 Italicized characters can be recognized.
Fonts Used for Converted Characters (Only when Word is selected as the file format)	<ul style="list-style-type: none"> Calibri Italic style is not reproduced.

*1 The following special Greek characters can be recognized. Special characters for each language can also be recognized. Some special characters cannot be recognized depending on the languages.

A, B, Γ, Δ, E, Z, H, Θ, I, K, Λ, M, N, Ξ, O, Π, P, Σ, T, Y, Φ, X, Ψ, Ω, α, β, γ, δ, ε, ζ, η, θ, ι, κ, λ, μ, ν, ξ, ο, π, ρ, σ, τ, υ, φ, χ, ψ, ω

*2 When <OCR (Prioritize Precision)> is selected, Arial type, Times New Roman type, and Courier New type fonts are recognized.

■ Checking the Format of the Original Documents

Use originals suitable for OCR processing to improve the processing accuracy when creating searchable PDF/XPS/OOXML files.

Item	Details
Original Format	Printed documents, Word processor documents (documents consisting of text, graphics, photographs, or tables, and with no character slant)
Text Format	<ul style="list-style-type: none"> Horizontal and vertical writing (documents containing both horizontal and vertical writing can also be recognized) Only horizontal writing can be recognized for European languages and Korean text. One to three column documents with no complex column settings
Character Size	8 to 40 point

Item	Details
Table Format (For Word Format Only)	Tables that meet the following conditions: <ul style="list-style-type: none">• Tables consist of squares divided with solid lines• Tables with up to 32 columns• Tables with up to 32 rows

 **IMPORTANT****Some originals suitable for OCR processing may not be processed properly.**

- High accuracy may not be achieved with originals including a large amount of text on each page.
- Characters may be replaced with unintended characters or be missing due to the background color of the original, form and size of characters, or slanted characters.*
- Paragraphs, line breaks, or tables may not be reproduced.*
- Some parts of illustrations, photographs, or seal impressions may be recognized as characters and be replaced with characters.*

* When Word is selected as the file format.

Enhancing the Security of Electronic Files

961F-0C9



Electronic files are vulnerable to security threats, such as those of files being viewed easily and tampered without leaving any traces. When scanning important papers, you can enhance the security of the files by encrypting or adding a digital signature to them.

NOTE

- Only PDF files can be encrypted.
- PDF and XPS files can have digital signatures.

▶ **Performing Encryption(P. 686)**

▶ **Adding a Digital Signature(P. 688)**

Performing Encryption

Setting a password when scanning an original enables PDF files to be encrypted for sending/saving. This helps reduce the risk of the files being viewed or edited by others.

- 1 Place the original.** ▶ **Placing Originals(P. 39)**
- 2 Press <Scan and Send>.** ▶ **<Home> Screen(P. 332)**
- 3 Specify the destination on the Scan Basic Features screen.** ▶ **Scan Basic Features Screen(P. 637)**
- 4 Press the setting button for file format.**

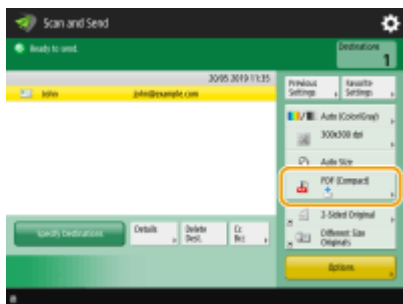

- 5 Press <PDF> ▶ <Encrypt>.**

NOTE

- To perform encryption, it is necessary to disable <Format to PDF/A>.
- You cannot set the Encrypted PDF mode when <Auto (OCR)> is set for <File Name>.
- This mode can be used only if an e-mail address or file server is specified as the destination.

6 Set the password and press <OK>.



a <Encryption Level>

Select the encryption level. If you want to use <Acrobat 9.0 or Equivalent/256-bit AES> rather than <Acrobat 10.0 or Equivalent/256-bit AES> as the encryption level, use this setting to change the selections you can make. ▶ <256-bit AES Settings for Encrypted PDF>(P. 1194)

b <Password Required to Open Document>

Enables you to set the password that is required when opening the file. Press <Password Required to Open Document> ▶ <Password to Open Doc.> to enter the password.

c <Password Required to Change Permission>

Enables you to set the password that is required when printing the file or editing the file, such as deleting pages, as well as to specify the operations that are allowed. Press <Password Required to Change Permission> ▶ <Permission Password> to enter the password, and then specify the operations to be permitted.

NOTE

- <Allow Printing>
 - <Do Not Allow>: Printing is not allowed.
(Even if you select <Do Not Allow>, the document can be printed if it is opened with the permission password in Adobe Acrobat 5 or earlier.)
 - <Allow (Low Resolution Only)>: Only low-resolution printing is allowed.
(Appears only if you select <Acrobat 6.0 or Later/128-bit RC4>, <Acrobat 7.0 or Later/128-bit AES>, <Acrobat 9.0 or Equivalent/256-bit AES>, or <Acrobat 10.0 or Equivalent/256-bit AES>.)
 - <Allow>: Printing is allowed.
- <Allow Changes>
 - <Do Not Allow>: Changing of files is not allowed.
 - <Insert, Delete, or Rotate Pages>: Inserting, deleting, and rotating pages are allowed. (Appears only if you select <Acrobat 6.0 or Later/128-bit RC4>, <Acrobat 7.0 or Later/128-bit AES>, <Acrobat 9.0 or Equivalent/256-bit AES>, or <Acrobat 10.0 or Equivalent/256-bit AES>.)
 - <Signature Field Signing>: If there is already a signature field in the PDF, adding a digital signature to that signature field is allowed. (Appears only if you select <Acrobat 6.0 or Later/128-bit RC4>, <Acrobat 7.0 or Later/128-bit AES>, <Acrobat 9.0 or Equivalent/256-bit AES>, or <Acrobat 10.0 or Equivalent/256-bit AES>.)
 - <Commenting and Signature Field Signing>: Adding comments, and adding a digital signature to a signature field (if there is already a signature field in the PDF) are allowed.
 - <Changes but Add Comments/Extract Pages>: Changes to the document are allowed, except for adding comments and extracting pages. (Appears only if you select <Acrobat 3.0 or Later/40-bit RC4>.)
 - <Changes but Extract Pages>: Changing of files except for extracting pages is allowed.
- <Enable Copying and Extraction of Images/Text>
 - Appears only if you select an item other than <Acrobat 3.0 or Later/40-bit RC4> for <Encryption Level>. If you select this item, you can copy or extract image/text from the scanned file.
- <Enable Access for the Visually Impaired>

- Appears only if you select an item other than <Acrobat 3.0 or Later/40-bit RC4> for <Encryption Level>. Selecting this item enables functions for reading aloud the text inside a file for the visually impaired.
- <Enable Accessibility, Copy, Extraction of Image/Text>
- Appears only if you select <Acrobat 3.0 or Later/40-bit RC4> for <Encryption Level>. Selecting this key sets both <Enable Copying and Extraction of Images/Text> and <Enable Access for the Visually Impaired> at the same time.

NOTE

- If you are logging in to the machine with personal authentication management (**▶Managing Users(P. 803)**), the <Store Password> button is displayed. Pressing this button saves the passwords you entered so that you can eliminate the need to enter passwords for the next setting.
- One password can be stored for each user. If you enter a new password when a password is already stored, the existing password is overwritten (the password is deleted if it is left blank).
- You cannot set the same password for both <Password to Open Document> and <Permission Password>.
- If you leave <Password to Open Document> or <Permission Password> empty, the stored password is erased.
- If you log in using User Authentication when all of the following conditions are true, multiple passwords may exist. In this case, a message confirming whether or not to use the password stored in <Store Password> may appear. Press <Yes> to use the password stored in <Store Password>. Press <No> to use the password registered in Favorite Settings.
 - A password is stored in <Store Password>
 - An encrypted PDF file is stored in Favorite Settings
 - The encrypted PDF file is recalled and sent from Favorite Settings
- To set digital signatures when <Password Required to Change Permission> is set, set <Allow Changes> to <Changes but Extract Pages>.
- Even if you set restrictions for a PDF file with <Permission Password>, some of the restrictions may be ignored if the reader opens the PDF with certain software.

7 Press (Start).

⇒ Originals are scanned and sending/saving starts.

Adding a Digital Signature

You can convert scanned originals into PDF/XPS files with a digital signature. A digital signature is similar to the act of signing and sealing papers, which enables you to check who created the file and if the file was tampered or forged after it was signed. For detailed information about a digital signature and its settings, see **▶Adding a Digital Signature to Sent Files(P. 895)** .

1 Place the original. ▶Placing Originals(P. 39)

2 Press <Scan and Send>. ▶<Home> Screen(P. 332)

3 Specify the destination on the Scan Basic Features screen. ▶Scan Basic Features Screen(P. 637)

4 Press the setting button for file format.

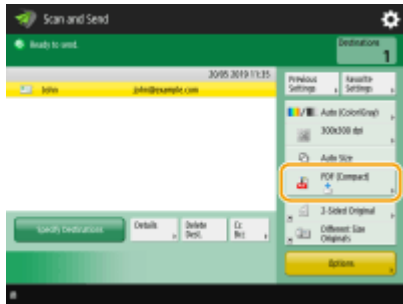

5 Press <PDF> or <XPS> ▶ <Add Digital Signatures>.

- If you do not log in to the machine with personal authentication management and select <XPS>, press <Add Device Signature>.

6 Select the digital signature and press <OK>.



a <Device Signature>

The name of the machine is added to the file as a signature. The reader can verify that the file is scanned from the machine.

b <User Signature>

The name of the user who logs in to the machine with personal authentication management is added to the file as a signature. The reader can verify that the file is scanned by the user.

7 Press (Start).

- ⇒ Originals are scanned and sending/saving starts.

NOTE

Making a digital signature recognized at a glance by the reader (visible signature) (only for a PDF file)

- Pressing <Visible Signatures> makes the signature appear on the first page of the file, enabling the reader to check at a glance who created the file.

When using together with PDF file encryption

- If you want to set a password for <Password Required to Change Permission> when encrypting a PDF file, select <Changes but Extract Pages> for <Allow Changes>.  **Performing Encryption(P. 686)**

- Setting S/MIME enables you to send an e-mail with a digital signature as well as encryption. [▶<S/MIME Settings>\(P. 1241\)](#)

LINKS

- [▶Managing Users\(P. 803\)](#)

Recalling Previously Used Settings for Sending/Saving (Previous Settings)

961F-0CA



You can recall destinations specified in the past. Their scan settings such as density are also recalled at the same time.

- 1 Place the original. ▶ **Placing Originals(P. 39)**
- 2 Press <Scan and Send>. ▶ **<Home> Screen(P. 332)**
- 3 Press <Previous Settings> on the Scan Basic Features screen. ▶ **Scan Basic Features Screen(P. 637)**
- 4 Select the log to recall and press <OK>.



⇒ The destination and its scan settings are specified according to the selected log.

- When personal authentication management is in use, the machine recalls the settings specified in the past by the user who are logging in to the machine.
- You can change the recalled settings before sending/saving.

- 5 Press  (Start).

⇒ Originals are scanned and sending/saving starts.

IMPORTANT

- If you set <Manage Address Book Access Numbers> to <On>, you cannot recall recently used settings.
- If you set any address type to <On> in <Limit New Destination>, the currently stored Previous Settings are deleted.

NOTE

- If  **<Prohibit Caching of Authentication Password>(P. 1366)** is set to <On>, the following password will not be stored in <Previous Settings>.
 - A password entered by specifying the destination in <New Destination>, and then pressing <File>

LINKS

 **Managing Users(P. 803)**

Setting a File Name

961F-0CC



A scanned document is sent/saved with its file name automatically assigned. If you want to change the file name of documents so that the contents can be guessed from the name, specify the following settings before scanning.

- 1 Place the original.** ▶ **Placing Originals(P. 39)**
- 2 Press <Scan and Send>.** ▶ **<Home> Screen(P. 332)**
- 3 Specify the destination on the Scan Basic Features screen.** ▶ **Scan Basic Features Screen(P. 637)**
- 4 Specify the scan settings as necessary.** ▶ **Basic Operations for Scanning Originals(P. 640)**
- 5 Press <Options> ▶ <File Name>.**
- 6 Press <File Name>, enter the file name, and then press <OK>.**
 - If you use characters such as "\", "/", ":", "*", "?", "<", ">", or "|" in the document name, you are unable to send the file to file servers that run on operating systems that do not recognize such characters.
- 7 Press <OK> ▶ <Close>.**

8 Press (Start).

▣ Originals are scanned and sending/saving starts.

- When sending a document by e-mail, it is sent with its file name assigned in the format of "entered file name_page numbers (three digits).file extension," such as "business log_001.jpg." If you do not enter a file name, the format will be "Job numbers (four digits)_page numbers (three digits).file extension."
- When saving a document in a file server, it is saved with its file name assigned in the format of "entered file name_the year, month, day, hour, minute, and second the file is saved (14 digits).file extension," such as "business log_20151030133541.jpg." If you do not enter a file name, the format will be "the year, month, day, hour, minute, and second the file is saved (14 digits). file extension."

NOTE

- Pressing to add a check mark to <Remove Date/Job No. from File Name> excludes the data/time and the job number from the file name.
- If you are saving a document in a file server, selecting <Divide into Pages> when specifying a file format adds a page number (five digits) at the end of a file name.

TIPS**Extracting a text block in the document for use as its file name**

- If you set <OCR (Text Searchable)> for <PDF>, <XPS>, or <OOXML> in <File Format>, and then press <Auto (OCR)> for <File Name>, the text in the original is extracted and automatically entered into <File Name>. The maximum number of characters to be extracted can be set in <Max Number of Characters for File Name> for **▶<OCR (Text Searchable) Settings>(P. 1191)** .
- You cannot set <Encrypt> and <Auto (OCR)> at the same time.
- If you manually enter the file name and set <Auto (OCR)>, the extracted text is appended to the end of the filename. Characters over the character limit will be cut off.
- When <OCR (Prioritize Precision)> is set for <File Format>, the settings for <Auto (OCR)> are disabled.

Editing a file name from the Remote UI

- If you register a file name in a state where <File Name> is set in <Favorite Settings>, you can edit the file name from the Remote UI.



Start the Remote UI ▶ click [Settings/Registration] ▶ [Function Settings] ▶ [Send] ▶ [Favorite Settings]

NOTE

- The file name generated with <Auto (OCR)> is not reflected to the following items:
 - The send job status (status display (on the bottom of the touch panel display))
 - TX Report
 - <File Name> in the job log

LINKS

▶ **System Options(P. 1597)**

▶ **Performing Encryption(P. 686)**

Specifying E-Mail Settings

961F-0CE



You can specify the subject, body, reply-to address, and priority used when sending your documents as e-mail attachments.

! IMPORTANT

- The reply-to address needs to be specified from among those registered in the Address Book. Register the desired address in the Address Book beforehand. ▶ **Registering Destinations in the Address Book(P. 394)**
- You can specify a destination from the address book of a mobile device. You can also send information including the subject, body, and file name from the mobile device to the machine. ▶ **Scan Basic Features Screen(P. 637)**

- 1 Place the original. ▶ **Placing Originals(P. 39)**
- 2 Press <Scan and Send>. ▶ **<Home> Screen(P. 332)**
- 3 Specify the destination on the Scan Basic Features screen. ▶ **Scan Basic Features Screen(P. 637)**
- 4 Specify the scan settings as necessary. ▶ **Basic Operations for Scanning Originals(P. 640)**
- 5 Press <Options> and specify e-mail settings.

■ To specify subject/body

- 1 Press <Subject/Message>.
- 2 Press <Subject>, enter the subject, and then press <OK>.

NOTE

- If nothing is entered, the subject entered in <Default Subject> is automatically set. ▶ **<Default Subject>(P. 1244)**

- 3 Press <Message>, enter the body, and then press <OK>.
- 4 Press <OK>.

NOTE

- If you send the subject/body from a mobile device to the machine, the complete sent text may not appear in the entry field. If this happens, press <Cancel Settings> on the subject/body entry screen.

■ To specify reply-to address

- 1 Press <Reply-to>.
- 2 Select a reply-to address and press <OK>.
 - For instructions on how to specify destinations, see **Basic Operations for Scanning Originals(P. 640)** .

NOTE

- When you send an e-mail, the selected destination is set as the reply-to e-mail address when the recipient replies.
- When you send an I-fax, a Full mode delivery confirmation message is sent to the selected reply-to address.
- If you set a login service for the machine and set <Specify Authentication User for Reply-To> to <On>, the e-mail address of the login user appears as the reply-to address.

■ To specify priority

- 1 Press <E-Mail Priority>.
- 2 Select a priority level and press <OK>.

6 Press <Close>.

7 Press  (Start).

⇒ Originals are scanned and sending starts.

Using Your Computer to Scan (Remote Scan)

Windows

961F-OCF

You can scan originals placed on the machine by operating your computer. There are two methods for scanning, using the "Color Network ScanGear 2" scanner driver supplied with the machine and the WSD function available for Windows.

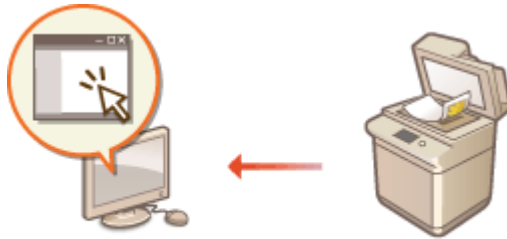

Using Color Network ScanGear 2 to Scan

You can scan originals directly into your favorite application for editing. This method is useful when you want to edit scanned photos in Photoshop or want to paste scanned picture into a Word document. ▶ **Using Color Network ScanGear 2(P. 698)**

Using WSD to Scan

Even if you do not have a dedicated scanner driver, you can scan an original easily from a computer using the WSD function available for Windows. ▶ **Using WSD(P. 702)**

Using Color Network ScanGear 2

961F-0CH

You can scan an original by starting Color Network ScanGear 2 from an application such as Adobe Photoshop and Microsoft Office Word. Scanned documents can be edited or saved using the application's functions. You need to complete some procedures before using Color Network ScanGear 2. **▶Preparing to Use Color Network ScanGear 2(P. 698)**

▶Scanning Originals from an Application(P. 700)

NOTE

- For information about system environments in which Color Network ScanGear 2 can be used, see Help for Color Network ScanGear 2.
- Depending on the version of the Windows operating system you are using, the Color Network ScanGear 2 screens in this section may differ from your screens.
- Starting Color Network ScanGear 2 requires TWAIN-compliant applications. Check Help for each application to determine whether it supports TWAIN or not.

■ Help for Color Network ScanGear 2

Clicking [Help] ▶ [Color Network ScanGear 2 Help] on the Color Network ScanGear 2 screen displays the Help screen. For information that is not in the User's Guide, including driver features and how to set up those features, see Help.

■ Preparing to Use Color Network ScanGear 2

After installing Color Network ScanGear 2 on a computer (▶**Installing Drivers(P. 313)**), follow the following procedures to connect Color Network ScanGear 2 to the machine.

1 [] ▶ [Color Network ScanGear 2] ▶ [Color Network ScanGear 2 Tool].

2 Search the machine.

■ Specifying the IP address or host name of the machine

- 1 Click [Specify Address] and enter the IP address or host name of the machine in the [IP Address or Host Name] text box.

■ Searching for the machine automatically

- 1 Click [Search for Scanners on the Network].
- 2 Select [IP Address] or [IP Address or Host Name] from the [Address Displayed in Search Result] drop-down list and click [Search].
- 3 Click to select the machine from the [Search Results] list box.

3 Click [OK].

- The [Select Scanner] dialog box closes.

4 Check that this machine is selected and click [Exit].

- To check if it can be connected properly, click [Test Connection].

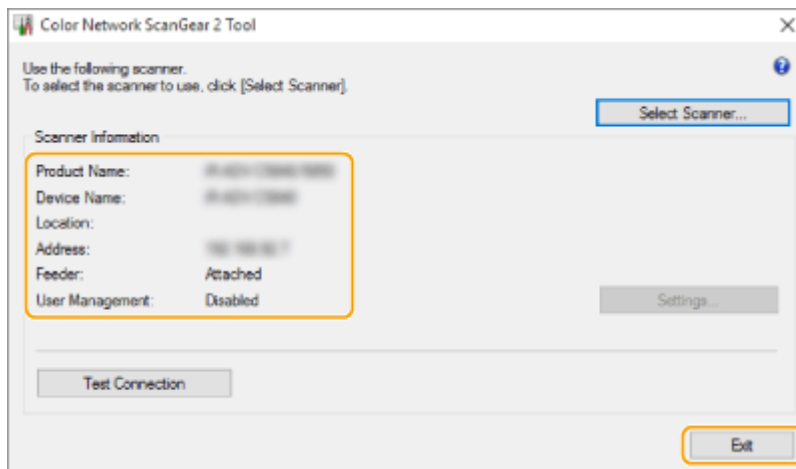

Scanning Originals from an Application

961F-0CJ

This section describes the method for scanning an original by starting Color Network ScanGear 2 from an application. You can also scan a part of the original by specifying the scanning area.



From the control panel

1 Place the original. ▶ **Placing Originals(P. 39)**

- To specify the scanning area, place the original on the platen glass.
- To scan multiple pages successively, place the originals in the feeder.

2 Press <Scanner>. ▶ **<Home> Screen(P. 332)**

3 Press <Online>.

⇒ Now you are ready for scanning from your computer.

- During the online state, other functions such as copying are not available.

NOTE

- You can also set the machine to automatically go online. ▶ **<Auto Online>(P. 1187)**



From a computer

4 From the application menu, select the command that starts the scanning.

- Color Network ScanGear 2 starts. For more information, see the instruction manual for each application.

5 At [Scanning Method] of the [Basic Settings] tab, select the location where the original is placed.

- When placing the original on the platen glass, select [Platen Glass].
- When placing a 1-sided original in the feeder, select [Feeder (1-sided)]. For 2-sided originals, select [Feeder (2-sided)].

6 Specify the scan settings as necessary.

- You can specify the color, resolution, and original size for scanning. Clicking the [Advanced Settings] tab enables you to perform detailed settings such as original orientation. For more information, see Help for Color Network ScanGear 2.

7 Click [Scan].

- ▣ Scanning an original starts.
- When scanning is complete, the Color Network ScanGear 2 screen closes and the scanned original is displayed on the application screen.
- When the scanning operations are complete, press <Offline> on the <Scanner> screen.

NOTE

- You can also set the machine to automatically go offline. ▶<Auto Offline>(P. 1188)

Using WSD

"WSD (Web Services on Devices)" is a function to search devices located on the network. Using WSD enables you to automatically find the machine on the network from a computer, and start scanning the original on the machine. This function is called "WSD Scan." You need to complete some procedures before using WSD Scan. [▶Preparing for WSD Scan\(P. 702\)](#)

▶Scanning Originals Using WSD (WSD Scan)(P. 703)

IMPORTANT

In the following cases, WSD Scan is not available.

- ACCESS MANAGEMENT SYSTEM is activated [▶Using ACCESS MANAGEMENT SYSTEM\(P. 849\)](#)
- DepartmentID Authentication is in use as a login service [▶Changing Login Services\(P. 1569\)](#)

■ Preparing for WSD Scan

From the control panel

- 1 Press  (Settings/Registration).
- 2 Press <Preferences> ▶ <Network> ▶ <TCP/IP Settings> ▶ <WSD Settings>.
- 3 Press <On> for <Use WSD Scan>.
- 4 Press <OK>.

From a computer

- 5 Open the printer folder. [▶Displaying the Printer Folder\(P. 1574\)](#)
- 6 Click [Add a device].
- 7 Select this machine and click [Next].

- Follow the on-screen instructions to operate.

NOTE

- If this machine is not displayed, a Firewall setting problem may exist. For more information, see the instruction manual of the computer.

Scanning Originals Using WSD (WSD Scan)

961F-0CL

This section describes how to scan originals from a computer using WSD.

NOTE

- The available scanning size is A4(LTR). Note that even if you place an original larger than A4(LTR), only A4(LTR) size is scanned.



From the control panel

1 Place the original. ▶ **Placing Originals(P. 39)**

2 Press <WSD Scan>. ▶ **<Home> Screen(P. 332)**

3 Press <Allow Remote Scan>.

⇒ Now you are ready for scanning from your computer.



From a computer

4 [Windows Key] ▶ [Windows Accessories] ▶ [Windows Fax and Scan].

5 Click [Scan].

6 Click [New Scan].

- When the [Select Device] dialog box is displayed, select the machine and click [OK].

7 From the [Source] drop-down list, select the location where the original is placed.

- When placing the original on the platen glass, select [Flatbed]. When placing in the feeder, select [Feeder (Scan one side)].

8 Specify the scan settings as necessary.

- Selecting the type of original from the [Profile] drop-down list enables you to make adjustments for the optimal image quality. For originals mainly consisting of text, select [Document]. For originals consisting of photographs only, select [Photo (Default)].
- From the [File type] drop-down list, select the file format for the saved image of the scanned original.
- To check the scanned image with the specified settings reflected, click [Preview].

9 Click [Scan].

▢▢▢▢ Scanning an original starts.

- When scanning is complete, the scanned document is displayed in the list of files on the [Windows Fax and Scan] screen and saved in the [Scanned Documents] folder of [Documents].

NOTE

Registering frequently used scan settings

- If you always scan with the same settings, follow the procedures below to register the settings. You can easily and conveniently recall them when scanning.
Select [Add profile] from the [Profile] drop-down list ► Specify the scan settings you want to register ► Enter a name in the [Profile name] text box ► Click [Save Profile]

Sending the document to a computer using WSD

- You can also send the scanned document to computers on the network that support WSD. In this case, press <WSD Scan> ► select the computer you want to send to ► <Start>. The [Windows Fax and Scan] screen and the folder open in the computer, and the scanned document is displayed.
- Up to 40 destination computers are displayed.

Using Storage Space

Using Storage Space	706
Using as a Simple File Server	708
Saving Documents in the Advanced Space	709
Accessing the Advanced Space from a Computer	711
Working with Files and Folders in the Advanced Space	713
Creating the Personal Space in the Advanced Space	717
Printing Files in the Advanced Space	718
Working with Other Devices	720
Saving Documents in Other Devices	721
Working with Files and Folders in Other Devices	722
Printing Files in Other Devices	723
Making Simple Edits to Files	724
Saving Documents in the Mail Box	725
Editing Files in the Mail Box	729
Printing Files in the Mail Box	734
Sending Files in the Mail Box	736
Specifying the Mail Box Settings	737
Working with Data in Memory Media	739
Saving Documents in Memory Media	741
Working with Files and Folders in Memory Media	743
Printing Files in Memory Media	747
Setting Screen and Operations for Scanning to Save	749
Setting Screen and Operations for Printing Saved Files	752
Storage Locations and File Formats for Each Mode	761

Using Storage Space

961F-0CR

The storage device installed in the machine has "storage space" to save, share, and edit scanned documents. Connecting memory media to the machine also provides you with an external storage space. Find and use the ideal storage space according to your needs.

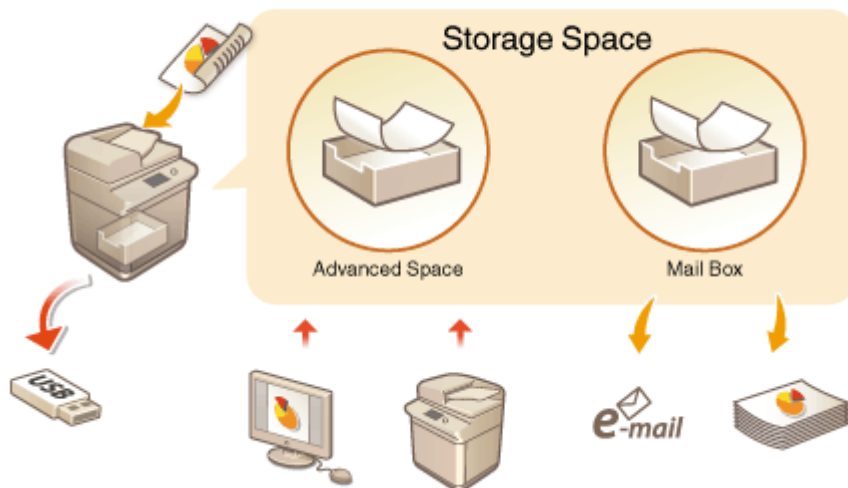

- ▶ **Setting Screen and Operations for Scanning to Save(P. 749)**
- ▶ **Setting Screen and Operations for Printing Saved Files(P. 752)**

■ Using as a Simple File Server

You can use the machine as a file server by saving data in the "Advanced Space" that allows the access of multiple computers. For example, saving scanned documents in the Advanced Space can achieve the sharing of information among the staff in an office. A part of the Advanced Space also can be assigned as a personal storage space, not open to the public.

▶ Using as a Simple File Server(P. 708)



■ Working with Other Devices

You can access a shared storage, "Advanced Space" of other Canon multifunction printers* from your machine for remote operations of files, such as saving and deleting. Other printers can access and operate files in the Advanced Space of your machine as well, which allows for each device to easily work together sharing data and expanding storage space without a computer or file server at hand. You can also access a Windows server from your machine to perform file operations such as printing.

* Available only for imageRUNNER ADVANCE series machines connected to a network

▶ Working with Other Devices(P. 720)



■ Editing Files without a Computer

By scanning and saving documents in a temporary storage space, "Mail Box," you can make simple edits to files, such as combining files and deleting pages from files. As the Mail Box does not require any special settings, you can get started using it quickly and easily. Once files are edited, you can handle them according to your purposes, such as printing and sending files to a computer via e-mail.

▶ Making Simple Edits to Files(P. 724)



■ Working with Data in Memory Media

Even if the machine is not connected to a network, the use of memory media allows for easy data exchange with computers. With memory media, you can also rename data and delete unwanted data in the media from the machine, as well as save scanned data and print data.

▶ Working with Data in Memory Media(P. 739)



Using as a Simple File Server

961F-0CS

The storage device installed in the machine has a shared storage called "Advanced Space." This space can be used as a file server as it enables you to save scanned documents and perform file operations (viewing/saving/downloading) from a computer. The Advanced Space has two types of storage locations inside: "Shared Space" that allows the access of multiple computers and "Personal Space" that serves as a personal storage area, not open to the public. Use these storage locations differently. For example, for data you want to share with the staff in an office, save in "Shared Space," while for highly confidential data, save in "Personal Space."

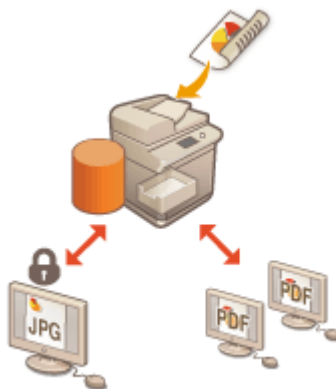

- ▶ **Saving Documents in the Advanced Space(P. 709)**
- ▶ **Accessing the Advanced Space from a Computer(P. 711)**
- ▶ **Working with Files and Folders in the Advanced Space(P. 713)**
- ▶ **Creating the Personal Space in the Advanced Space(P. 717)**
- ▶ **Printing Files in the Advanced Space(P. 718)**

! IMPORTANT

- To use the Advanced Space, some settings need to be specified beforehand. ▶ **Setting the Advanced Space of the Machine(P. 320)**
- To use the Personal Space, both the personal authentication management and Personal Space settings need to be specified beforehand. ▶ **Creating the Personal Space in the Advanced Space(P. 717)**
- As the Advanced Space is intended for use on a network, it normally requires a user authentication during use. If the login screen is displayed when accessing the Advanced Space, enter the same user name and password as those used when logging in to the machine. When your operations are complete, be sure to log out.
- Pressing <Store Password> saves the passwords you entered so that you can eliminate the need to enter passwords for the next setting.

NOTE

- Installing an optional storage device enables you to expand the storage area of the Advanced Space. ▶ **System Options(P. 1597)**
- By connecting the machine with another Canon multifunction printer*, data in the Advanced Space of both machines can be shared. ▶ **Working with Other Devices(P. 720)**

* Available only for imageRUNNER ADVANCE series machines connected to a network

Saving Documents in the Advanced Space

961F-0CU

Follow the procedures below to save scanned documents in the Advanced Space. You can use this convenient method when you want to digitize many documents so that you can share the information with the staff in a department in a paperless environment.

NOTE

- We recommend that you delete unwanted files or image data from the Advanced Space to make space for storing new documents.
- You can also send documents to the Advanced Space by specifying it as the destination from <Scan and Store>. For instructions on sending documents to the Advanced Space, see [▶Registering Destinations in the Address Book\(P. 394\)](#) .

1 Set the original. [▶Placing Originals\(P. 39\)](#)

2 Press <Scan and Store>. [▶<Home> Screen\(P. 332\)](#)

3 Press <Advanced Space>.

4 Press <Shared Space> or <Personal Space>.

- For information on the items on the screen and instructions on how to use them, see [▶Working with Files and Folders in the Advanced Space\(P. 713\)](#) .

5 Display the save location and press <Scan>.

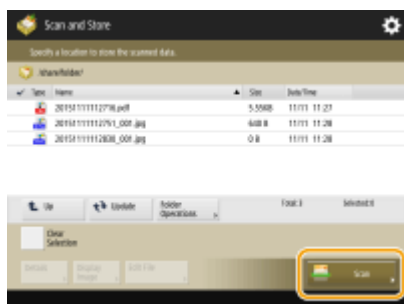

6 Specify the scan settings as necessary.

- For scan settings, see [▶Setting Screen and Operations for Scanning to Save\(P. 749\)](#) .

7 Press  (Start).

Originals are scanned and saved as files.

- To cancel scanning, press <Cancel> or  (Stop) ▶ <Yes>.

■ **When <Press the [Start] key to scan the next original.> is displayed**

Place the next original to scan and press  (Start). After scanning all of the originals, press <Start Storing> to save the file.

NOTE

- To check the result of saving, press  (Status Monitor) ▶ <Store> ▶ <Job Log>. If <NG> is displayed, the file is not saved successfully. Try the operation again.

Accessing the Advanced Space from a Computer

961F-0CW

You can access the Advanced Space from a computer to save files on the computer or download files from the Advanced Space. This shared storage can hold data in the file formats commonly supported by a computer, offering you a versatile usage - save and share PDF files created on a computer or scan documents from the machine to save as JPEG files so they can be downloaded from a computer whenever you need. The Advanced Space is opened externally as either a SMB or WebDAV server. The way to access the Advanced Space differs depending on which server it uses as a role.

IMPORTANT

- To access the Advanced Space from a computer, some settings need to be specified beforehand.  **Setting Advanced Space to Public(P. 321)**
- If the machine is shut down while a client computer is writing a file to the Advanced Space, an incomplete file is generated in the Advanced Space. In this case, perform the operation again after restarting the machine.

NOTE

- In order to directly connect to the Advanced Box from the Explorer of a computer to create/change/delete files/folders, it is necessary to set <Prohibit Writing from External> to <Off>.  **<Prohibit Writing from External>(P. 1294)**
- If the Advanced Space is opened externally as an SMB or WebDAV server, a user with Administrator privileges can delete the folders and files created by general users by directly connecting to the Advanced Space from Windows Explorer on a computer.

 **When Opened Using SMB(P. 711)**

 **When Opened Using WebDAV(P. 712)**

When Opened Using SMB

1 Open Windows Explorer.

2 Enter the address of the Advanced Space in the address bar and press the [ENTER] key on the computer keyboard.

- To access the Shared Space, enter "\\host name or IP address of this machine\share." To access the Personal Space, enter "\\host name or IP address of this machine\users."

⇒ When login is successful, the Advanced Space is displayed.

NOTE

- If you are using an IPv6 address, enclose the address with [].
- When the login screen is displayed, enter the user name and password.

When Opened Using WebDAV

- 1** Open Windows Explorer, and click [This PC].
- 2** Click [Map network drive] on the [Computer] tab.
- 3** Select a drive from the [Drive] drop-down list.
- 4** Enter an address in the [Folder] text box, and click [Finish].
 - To access the Shared Space, enter "http://host name or IP address of this machine/share." To access the Personal Space, enter "http://host name or IP address of this machine/users."
 - ⇒ When login is successful, the Advanced Space is displayed.

NOTE

- If you are using an IPv6 address, enclose the address with [].
- If TLS is in use, enter "https" instead of "http" when entering the address.
- When the login screen is displayed, enter the user name and password.

Working with Files and Folders in the Advanced Space

961F-0CX

You can rename and delete files saved in the Advanced Space as well as add and delete folders.

1 Press <Access Stored Files>. ▶<Home> Screen(P. 332)

2 Press <Advanced Space>.

3 Press <Shared Space> or <Personal Space>.

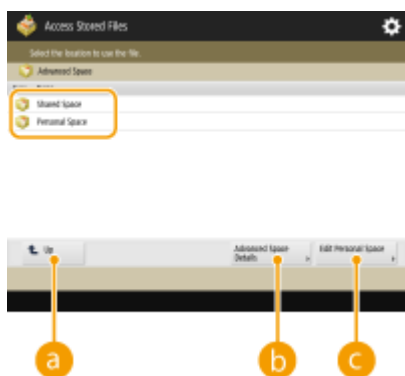

a <Up>

Press to move to the upper level from the current one.

b <Advanced Space Details>

Enables you to check the locations (URL) of the Shared Space and the Personal Space, and the available memory of the Advanced Space.

c <Edit Personal Space>

Enables you to create, rename, and delete the Personal Space. ▶<Creating the Personal Space in the Advanced Space(P. 717)>

4 Operate files and folders.

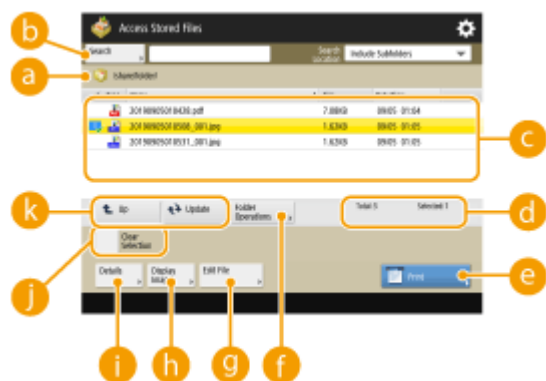

a Location currently displayed

Displays the location (path) where files and folders of **c** are saved.

b <Search>

Searches the files and folders saved in **a** .

c Files and folders saved

Displays whether files or folders are selected, icons indicating the file type or folder, names, file sizes, and saved dates/times.

- Press <Name> or <Date/Time> to sort the list of files and folders by name or date/time in ascending (▲) or descending (▼) order.
- If you log in with personal authentication management, the sorting condition that was last used is retained. ▶ **List of Items That Can Be Personalized(P. 357)**
- When files are selected, numbered icons are displayed in the order you select the files. If you are printing multiple files at the same time, they are printed in that order.
- In the Shared Space, a folder named "folder" is prepared.

d Total number of files/folders and number of selected files

Displays the total number of files and folders saved in **a** and the number of files in the selection.

e <Print>

Prints files. ▶ **Printing Files in the Advanced Space(P. 718)**

f <Folder Operations>

Press to create or delete folders.

g <Edit File>

Press to rename or delete files.

h <Display Image>

Displays the preview image of a file. You can also print after checking the preview image.

i <Details>

Displays the size and the updated date/time of a file.

j <Clear Selection>

Deselects all the files selected in **c** .

k Display switch button

Press <Up> to move to the upper level from the current one. To update the contents of the displayed screen, press <Update>.

■ To change a file name

- 1 Select a file and press <Edit File> ▶ <Change File Name>.
- 2 Enter a file name and press <OK>.

■ To display the preview image of a file

- 1 Select a file and press <Display Image>.
- 2 After checking the preview image, press <Back>.
 - To print the file, press <Print>.

■ To check the detailed information of a file

- 1 Select a file and press <Details>.
- 2 After checking the detailed information, press <OK>.

■ To delete a file

- 1 Select a file and press <Edit File> ► <Delete>.
- 2 Press <Yes>.

NOTE

- You can select and delete up to 32 files at a time.

■ To scan and save documents

- 1 Set the original. ▶ **Placing Originals(P. 39)**
- 2 Press <Edit File> ► <Add Files (Scan and Store)>.
- 3 Specify the scan settings as necessary and press  (Start).
 - For scan settings, see ▶ **Setting Screen and Operations for Scanning to Save(P. 749)** .

■ To create a folder

- 1 Press <Folder Operations>.
- 2 Press <Create Folder>.
- 3 Enter a folder name and press <OK>.
- 4 Press <OK>.

■ To change a folder name

- 1 Display a folder whose name you want to change and press <Folder Operations>.
- 2 Select a folder and press <Details>.
- 3 Press <Rename Folder>.
- 4 Enter a folder name and press <OK>.
- 5 Press <OK>.

■ To check the detailed information of a folder

- 1 Display a folder whose information you want to check and press <Folder Operations>.
- 2 Select a folder and press <Details>.

- 3 After checking the detailed information, press <OK>.

■ To delete a folder

- 1 Display a folder to delete and press <Folder Operations>.
- 2 Select a folder and press <Delete> ► <Yes>.

NOTE



- When the operation is complete, press <Disconnect>. <Disconnect> is displayed when all of the following conditions are met.
 - User authentication is not performed
 - <Authentication Management> is set to <On> for the Advanced Space ► **Setting Advanced Space to Public(P. 321)**

Creating the Personal Space in the Advanced Space

961F-0CY

The Advanced Space is typically used for data sharing, but you are allowed to create a "Personal Space" so that you can use it as your personal storage area, not open to the public. The Personal Space is suitable for saving highly confidential documents as it permits only the access of users who are logged in to the machine with personal authentication management.

IMPORTANT

- To create a Personal Space, the personal authentication management settings need to be specified beforehand. ( **Managing Users(P. 803)**). Also, you need to set both <Authentication Management> and <Allow to Create Personal Space> to <On> ( **Setting Advanced Space to Public(P. 321)**).

1 Press <Access Stored Files>.  <Home> Screen(P. 332)

2 Press <Advanced Space>.

3 Press <Edit Personal Space> ▶ <Create Personal Space>.

NOTE

- When a Personal Space already exists, <Delete Personal Space> is displayed instead of <Create Personal Space>. Each user is allowed to create only one Personal Space, but you can create multiple folders in the Personal Space.

4 Press <Yes>.

NOTE

To change the public folder name of a Personal Space

- The name of a user who logs in to the machine to create the Personal Space is automatically used as its public folder name (folder name on the network). To change to another name, press <Edit Personal Space> ▶ <Rename Opened Folder> ▶ enter a folder name ▶ <OK>.

To delete a Personal Space

- Press <Edit Personal Space> ▶ <Delete Personal Space> ▶ <Yes>.
- Users with Administrator privileges can delete single Personal Spaces or all Personal Spaces from the Remote UI.



Start the Remote UI ▶ click [Settings/Registration] ▶ [Function Settings] ▶ [Store/Access Files] ▶ [Delete Personal Space].

Printing Files in the Advanced Space

961F-0E0

Save files in the Advanced Space so that you can easily print them from the machine whenever you need. For example, holding documents, such as maps and brochures issued at irregular intervals, in the Shared Space saves you the trouble of opening an application on a computer.

NOTE

- We recommend that you delete unwanted files or image data from the Advanced Space to make space for storing new documents.

1 Press **<Access Stored Files>**. **▶<Home> Screen(P. 332)**

2 Press **<Advanced Space>**.

3 Press **<Shared Space> or <Personal Space>**.

- For information on the items on the screen and instructions on how to use them, see **▶Working with Files and Folders in the Advanced Space(P. 713)** .

4 Select a file and press **<Print>**.

- If you select PDF or XPS files, proceed to step 6.

NOTE

- You can select and print up to 6 files in the same folder at a time.

5 Select the paper source and press **<OK>**.

6 Enter the number of prints using the numeric keys.

- If you select multiple files in step 4, press **<Change No. of Copies>** and enter the number of prints.

7 Specify the print settings as necessary.

- For print settings, see **▶Setting Screen and Operations for Printing Saved Files(P. 752)** .

NOTE

- To print a PDF file with a password, press **<Options> ▶ <Password to Open Doc.> ▶ <Encryption Password> or <Policy Password>**, enter the password, and press **<OK>**. To print PDF files that forbid printing, or print PDF files that only allow low-resolution printing in high resolution, enter the specified password.
- If you press **<Start Printing>** without entering a password, a password entry screen is displayed if the file has an encryption password.

8 Press <Start Printing>.

▣▣▣ Printing starts.

- To cancel printing, press <Cancel> ▶ <Yes>.

NOTE

- You can also display the file preview image and print from this screen. ▶ **Working with Files and Folders in the Advanced Space(P. 713)**

LINKS

▶ **Saving Documents in the Advanced Space(P. 709)**

▶ **Loading Paper(P. 46)**

Working with Other Devices

961F-0E1

Documents scanned from your machine can be saved in the Advanced Space of other Canon multifunction printers*, or files saved in the Advanced Space of other printers can be printed and deleted from your machine. The other printers are permitted to perform the same operations as well, which allows for each device to easily work together sharing data, performing remote operations, and expanding storage space without a computer at hand. You can also access a Windows server from your machine to perform file operations such as printing.

* Available only for imageRUNNER ADVANCE series machines connected to a network



- ▶ **Saving Documents in Other Devices(P. 721)**
- ▶ **Working with Files and Folders in Other Devices(P. 722)**
- ▶ **Printing Files in Other Devices(P. 723)**

! IMPORTANT

- To access other devices, some settings need to be specified beforehand. ▶ **Connecting to the Other Devices(P. 326)**
- To prevent unauthorized operations from being performed, the Advanced Space that is open to a network requires a user authentication. The machine being accessed also requires a user authentication. When the login screen is displayed when accessing the Advanced Space of the other machine, enter the user name and password used to log in to that machine. When your operations are complete, be sure to log out.

Saving Documents in Other Devices

961F-0E2

Follow the procedures below to save scanned documents in the Advanced Space of another Canon multifunction printer or in a Windows server.

1 Set the original. ▶ **Placing Originals(P. 39)**

2 Press <Scan and Store>. ▶ **<Home> Screen(P. 332)**

3 Press <Network>.

4 Select the device you want to access.

- For information on the items on the screen and instructions on how to use them, see ▶ **Working with Files and Folders in Other Devices(P. 722)** .

5 Display the save location and press <Scan>.

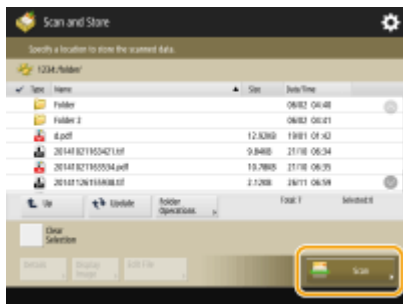

6 Specify the scan settings as necessary.

- For scan settings, see ▶ **Setting Screen and Operations for Scanning to Save(P. 749)** .

7 Press  (Start).

⇒ Originals are scanned and saved as files.

- When canceling scanning, press <Cancel> or  (Stop) ▶ <Yes>.

■ When <Press the [Start] key to scan the next original.> is displayed

Place the next original to scan and press  (Start). After scanning all of the originals, press <Start Storing> to save the file.

NOTE

- To check the result of saving, press  (Status Monitor) ▶ <Store> ▶ <Job Log>. If <NG> is displayed, the file is not saved successfully. Try operating again.

Working with Files and Folders in Other Devices

961F-0E3

You can use the machine to perform remote operations, such as checking and deleting files, in the Advanced Space of another Canon multifunction printer or in a Windows server.

1 Press <Access Stored Files>. ▶<Home> Screen(P. 332)

2 Press <Network>.

3 Select the device you want to access.

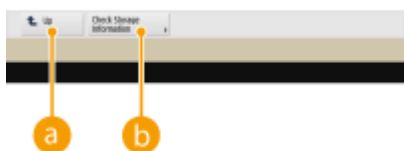

a <Up>

Press to move to the upper level from the current one.

b <Check Storage Information>

Selecting a device and pressing <Details> enables you to check the information (protocol/path) of the device.

NOTE

- You can also use a personal folder as the destination. For information on the personal folder settings, see ▶**Configuring Personal Folders(P. 846)** .

4 Operate files and folders.

- For information on the items on the screen and instructions on how to use them, see step 4 of ▶**Working with Files and Folders in the Advanced Space(P. 713)** . Note that you cannot change folder names and delete folders in other devices.

NOTE

- When the operation is complete, press <Disconnect>. <Disconnect> is displayed when all of the following conditions are met.
 - User authentication is not performed
 - The machine is logged in to the connected file server

Printing Files in Other Devices

961F-0E4

You can use the machine to directly print files saved in the Advanced Space of another Canon multifunction printer or in a Windows server.

1 Press <Access Stored Files>. ▶<Home> Screen(P. 332)

2 Press <Network>.

3 Select the device you want to access.

- For information on the items on the screen and instructions on how to use them, see ▶<Working with Files and Folders in Other Devices(P. 722) .

4 Select a file and press <Print>.

- If you select PDF or XPS files, proceed to step 6.

NOTE

- You can select and print up to 6 files in the same folder at a time.

5 Select the paper source and press <OK>.

6 Enter the number of prints using the numeric keys.

- If you select multiple files in step 4, press <Change No. of Copies> and enter the number of prints.

7 Specify the print settings as necessary.

- For print settings, see ▶<Setting Screen and Operations for Printing Saved Files(P. 752) .

NOTE

- To print a PDF file with a password, press <Options> ▶ <Password to Open Doc.> ▶ <Encryption Password> or <Policy Password>, enter the password, and press <OK>. To print PDF files that forbid printing, or print PDF files that only allow low-resolution printing in high resolution, enter the specified password.

8 Press <Start Printing>.

▢▶ Printing starts.

- To cancel printing, press <Cancel> ▶ <Yes>.

LINKS

- ▶<Saving Documents in Other Devices(P. 721)
- ▶<Loading Paper(P. 46)

Making Simple Edits to Files

961F-0E5

The storage device installed in the machine has a temporary data storage space called "Mail Box." By saving documents in the Mail Box, you can make simple edits to files, such as combining files and deleting pages from files, from the machine. Edited documents can be converted into file formats such as PDF and TIFF that are supported by a computer and sent to the desired destination via e-mail and the like. You can also save documents and retain print settings such as 2-sided printing, allowing you to print without having to specify the settings again.



- ▶ **Saving Documents in the Mail Box(P. 725)**
- ▶ **Editing Files in the Mail Box(P. 729)**
- ▶ **Printing Files in the Mail Box(P. 734)**
- ▶ **Sending Files in the Mail Box(P. 736)**
- ▶ **Specifying the Mail Box Settings(P. 737)**

! IMPORTANT

- The machine is set to automatically delete saved files after a certain period of time. You can extend the period of time, or choose to store files indefinitely. ▶ **Specifying the Mail Box Settings(P. 737)**

NOTE

- To prevent unauthorized access or incorrect operations, you can set a password for the Mail Box. ▶ **Specifying the Mail Box Settings(P. 737)**

Saving Documents in the Mail Box

961F-0E6

There are two methods for saving documents in the Mail Box: scanning originals from the machine and sending files on a computer from the printer driver. Print settings are saved together with documents that are saved from a printer driver, allowing you to always print documents with the same finishing, as well as saving you the trouble of specifying settings.

NOTE

- We recommend that you delete unwanted files or image data from your Mail Box to make space for storing new documents.

▶ **Scanning from the Machine to Save(P. 725)**

▶ **Saving Data on Computers(P. 726)**

Scanning from the Machine to Save

1 Set the original. ▶ Placing Originals(P. 39)

2 Press <Scan and Store>. ▶ <Home> Screen(P. 332)

3 Press <Mail Box>.

4 Select the box to save in.

- For information on the items on the screen and instructions on how to use them, see ▶ **Editing Files in the Mail Box(P. 729)** .

5 Press <Scan>.

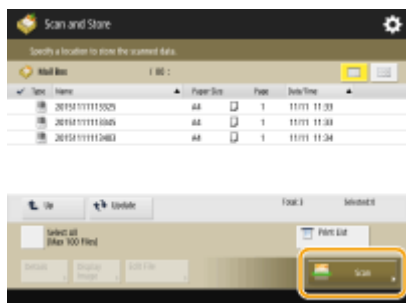

(Items shown on the screen may differ depending on your model and options.)

6 Specify the scan settings as necessary.

- For scan settings, see ▶ **Setting Screen and Operations for Scanning to Save(P. 749)** .

7 Press (Start).

Originals are scanned and saved as files.

- To cancel scanning, press <Cancel> or  (Stop) ▶ <Yes>.

■ When <Press the [Start] key to scan the next original.> is displayed

Place the next original to scan and press  (Start). After scanning all of the originals, press <Start Storing> to save the file.

Saving Data on Computers

▶ For Windows(P. 726)

▶ For Mac OS(P. 727)

Windows

- 1 Open a file and display the print screen.
- 2 Select the machine and click [Preferences] or [Properties].
- 3 Select [Store] from [Output Method] and click [Yes].

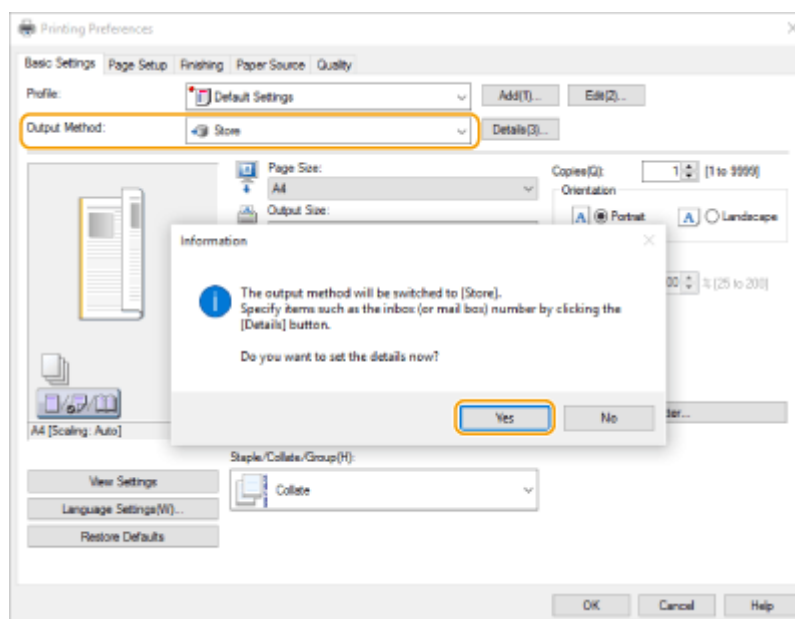

- 4 Specify the detailed settings for saving and click [OK].

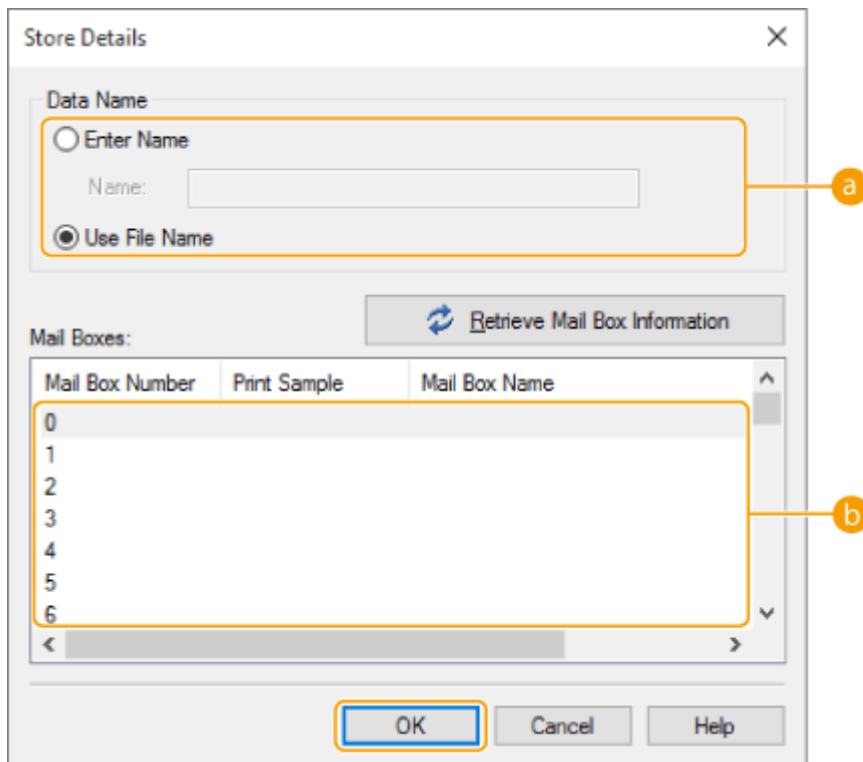

a [Data Name]

To save using the file name of the data on the computer, select [Use File Name]. To change the file name, select [Enter Name] and enter a file name in the [Name] text box.

b [Mail Boxes]

Select the box you want to save in. Clicking while holding down the [CTRL] key on the computer keyboard enables you to select multiple boxes and save the same files in each box.

NOTE

- The box name registered in the machine can be applied to the printer driver. For details, see Help of the printer driver.

5 Specify the print settings as necessary and click [OK].

6 Click [Print] or [OK].

⇒ The file is saved in the box selected in step 4.

Mac OS

1 Open a file and display the print screen.

2 Select the machine and specify the print settings.

3 Select [Store] in [Job Processing] of [Special Features] panel.

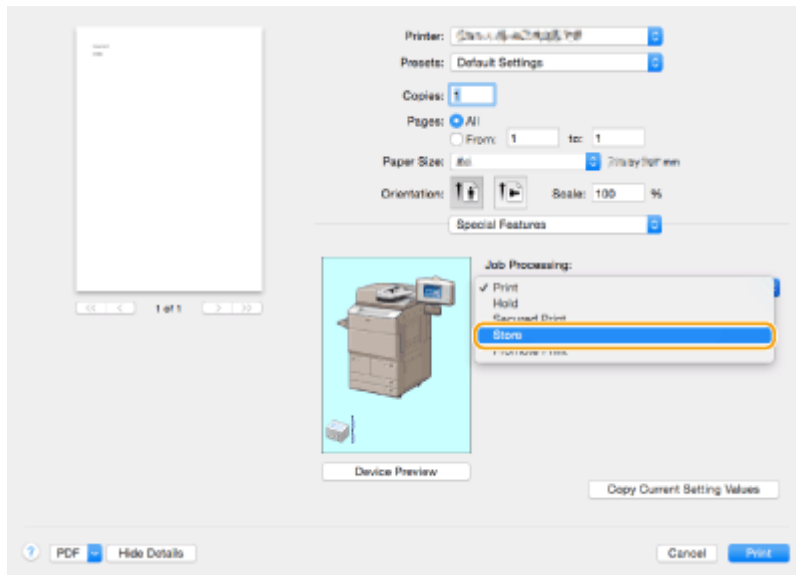

4 Click [Print].

5 Specify the detailed settings for saving.

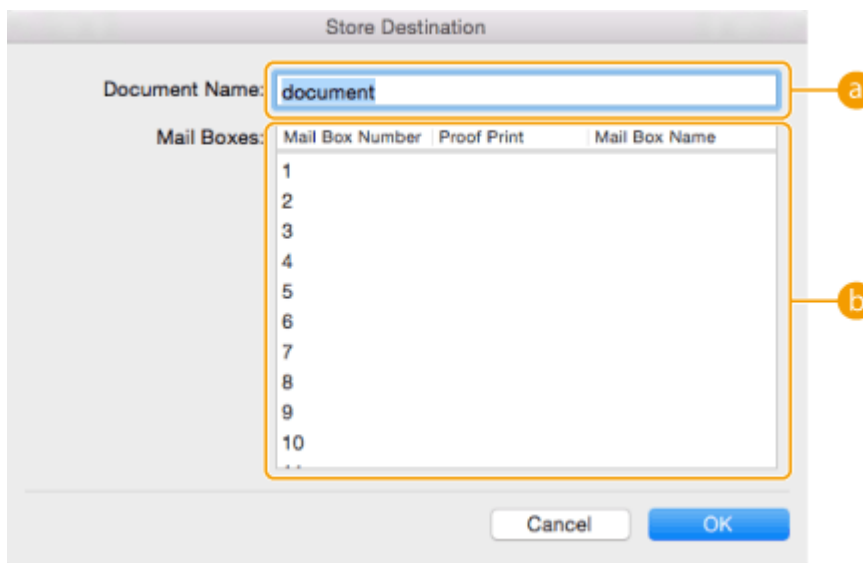

a [Document Name]

Enter the name of a file to save in the box.

b [Box]

Select the box you want to save in. Clicking while holding down the [COMMAND] key on the computer keyboard enables you to select multiple boxes and save the same files in each box.

6 Click [OK].

⇒ The file is saved in the box selected in step 5.

LINKS

- ▶ [Printing From a Computer\(P. 597\)](#)
- ▶ [Canceling Printing\(P. 600\)](#)

Editing Files in the Mail Box

961F-0E7

You can edit documents saved in the Mail Box. This storage space enables you to rename and delete saved files, as well as combine multiple files into a single file or insert a file into another one.

1 Press <Access Stored Files>. ▶<Home> Screen(P. 332)

2 Press <Mail Box>.

3 Select the desired box.

- You can also enter the box number using the numeric keys to directly specify the desired box.

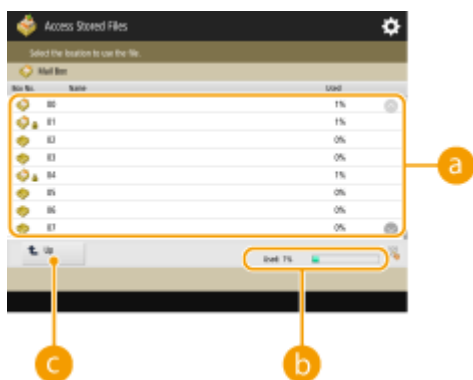

a Mail box list

Displays icons indicating the statuses of the boxes, box numbers, box names, and the amount of memory consumed by each box.

- Icon types displayed are as follows:

- Mail box with files saved

- Mail box with no files saved

- Mail box with passwords set ▶<Specifying the Mail Box Settings(P. 737)>

b <Used>

Displays the total amount of memory consumed by all the boxes.

c <Up>

Press to move to the upper level from the current one.

4 Operate files.

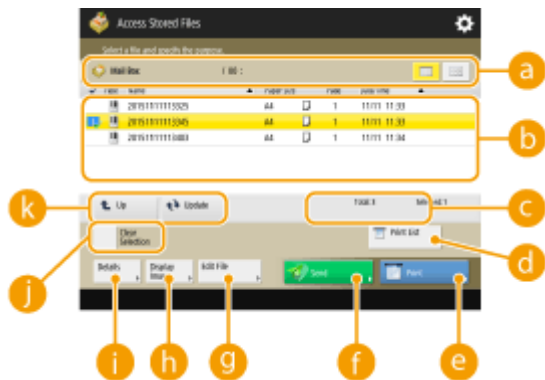

a Mail box information

Displays the number and name of the box displayed. You can change the display format, depending on the model of your machine.

b Files saved in the box

Displays whether files are selected, icons indicating the file type, names, scanning sizes, number of pages, and saved dates/times.

- Press <Name> or <Date/Time> to sort the list of files and folders by name or date/time in ascending (▲) or descending (▼) order.
- If you log in with personal authentication management, the sorting condition that was last used is retained. ▶ **List of Items That Can Be Personalized(P. 357)**
- When files are selected, numbered icons are displayed in the order you select the files. If you are printing multiple files at the same time, they are printed in that order.

NOTE:

- The files below retain their print settings. However, note that combining files or editing files (e.g. inserting pages) clears all the print settings.
 - Files saved from the printer driver ▶ **Saving Data on Computers(P. 726)**
 - Files saved using <Store in Mail Box> in the <Copy> function ▶ **Storing Copy Documents in the Machine(P. 493)**

c Total number of files and number of selected files

Displays the total number of files saved and the number of files in the selection.

d <Print List>

Prints a list of documents saved in the box displayed. You can check the names, paper sizes, and the number of pages of documents.

e <Print>

Prints files. ▶ **Printing Files in the Mail Box(P. 734)**

f <Send>

Sends files, or saves files in a file server. ▶ **Sending Files in the Mail Box(P. 736)**

g <Edit File>

Press to rename files or combine multiple files.

h <Display Image>

Displays the preview image of a file. You can also print after checking the preview image and deleting unnecessary pages.

i <Details>

Displays the detailed information of a file, such as the number of pages and paper size.

j <Select All (Max 100 Files)>/<Clear Selection>

If files are not selected in **b**, <Select All (Max 100 Files)> is displayed. If one or more files are selected, <Clear Selection> is displayed. Press <Select All (Max 100 Files)> to select up to 100 files in the box at the same time or <Clear Selection> to deselect them.

k Display switch button

Press <Up> to move to the upper level from the current one. To update the contents of the displayed screen, press <Update>.

■ To change a file name

- 1 Select a file and press <Edit File> ► <Change File Name>.
- 2 Enter a file name and press <OK>.

■ To display the preview image of a file

- 1 Select a file and press <Display Image>.
- 2 After checking the preview image, press <Back>.
 - To print the file, press <Print>.

■ To check the detailed information of a file

- 1 Select a file and press <Details>.
- 2 After checking the detailed information, press <OK>.

■ To delete a file

- 1 Select a file and press <Edit File> ► <Delete>.
- 2 Press <Yes>.

■ To scan and save documents

- 1 Set the original. **▶ Placing Originals(P. 39)**
- 2 Press <Edit File> ► <Add Files (Scan and Store)>.
- 3 Specify the scan settings as necessary and press  (Start).
 - For scan settings, see **▶ Setting Screen and Operations for Scanning to Save(P. 749)** .

■ To move/duplicate files to another box

- 1 Select a file and press <Edit File> ► <Move/Duplicate>.
- 2 If the screen for selecting the Move/Duplicate destination appears, press <Mail Box>.

- 3 Select the box and press <Shift> or <Duplicate>.
 - When a file is duplicated, the file name will be the same as that of the original file.

■To combine multiple files into one file

The files in the same box can be combined into one file. Note that if the resolution settings of each file do not match, you cannot combine files.

- 1 Select the files to combine, and press <Edit File> ► <Merge Multiple Files>.
 - The files are combined in the order they are selected.
- 2 Enter a file name.
 - Press <File Name>, enter the name, and press <OK>.

NOTE

- If you do not specify anything, the saved date and time is automatically assigned as a file name. For example, if a file is saved at 1:05:12 p.m. on October 30, 2015, its name will be "20151030130512."
- 3 Press <Start Merging>.
 - All the print settings for each file are canceled, and the settings registered in <Change Default Settings> are applied to a new file. ►<Change Default Settings>(P. 1286)

■To insert a file into another one

The files in the same box can be inserted. Note that if the resolution settings of each file do not match, you cannot insert files.

- 1 Select the file where you want to insert another file, and press <Edit File> ► <Insert Pages>.
- 2 Specify the file to insert and the position to insert it, and press <Next>.

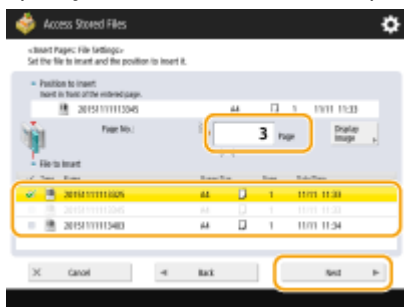

- Enter the page number where you want to insert the file using the numeric keys.
- 3 Enter a file name.
 - Press <File Name After Insertion>, enter the name, and press <OK>.

NOTE

- If you do not specify anything, the saved date and time is automatically assigned as a file name. For example, if a file is saved at 1:05:12 p.m. on October 30, 2015, its name will be "20151030130512."
- 4 Check the page order and press <Start Inserting>.
 - All the print settings for each file are canceled, and the settings registered in <Change Default Settings> are applied to a new file. ►<Change Default Settings>(P. 1286)

■ To delete pages

- 1 Select a file and press <Edit File> ► <Delete Page>.
- 2 Specify the pages to delete.



- To delete only one page, press <Single Page> and enter the corresponding page number.
 - To delete multiple pages at the same time, press <Multiple Pages> ► <First Page> or <Last Page> and enter the corresponding page numbers.
- 3 Press <Start Deleting> ► <Yes>.

Printing Files in the Mail Box

961F-0E8

Follow the procedures below to print files in the Mail Box. As files remain saved with the print settings, you can always print with the same result. By setting the period of time for saving in the Mail Box to an indefinite period of time (▶ **Specifying the Mail Box Settings(P. 737)**), and saving documents you use in a daily routine such as a fax cover sheet with the print settings, you can save the trouble of printing from a computer.

1 Press <Access Stored Files>. ▶<Home> Screen(P. 332)

2 Press <Mail Box>.

3 Select the desired box.

- For information on the items on the screen and instructions on how to use them, see ▶ **Editing Files in the Mail Box(P. 729)** .

4 Select a file and press <Print>.

NOTE

- You can select and print up to 100 files in one mail box at a time. However, if there are reserved jobs in the mail box, the number of files you can select and print varies, depending on the number of files reserved.

5 Enter the number of prints using the numeric keys.

- If you select multiple files in step 4, press <Change No. of Copies> and enter the number of prints.

6 Specify the print settings as necessary.

- For print settings, see ▶ **Setting Screen and Operations for Printing Saved Files(P. 752)** .

! IMPORTANT

- On the File Selection screen, files for which an icon with  are displayed have been saved together with the print settings specified when they were saved. To print with these settings, do not press <Change Print Settings>. The specified settings may become disabled.

7 Press <Start Printing>.

▢▶▶▶ Printing starts.

- To cancel printing, press <Cancel>.

NOTE

- Depending on the file saved from a computer, printing may not be available as the machine does not support the settings of the file.

- You can also display the file preview image and print from this screen. ▶ **Editing Files in the Mail Box(P. 729)**
- The maximum number print jobs that can be reserved is 100.

LINKS

- ▶ **Saving Documents in the Mail Box(P. 725)**
- ▶ **Loading Paper(P. 46)**

Sending Files in the Mail Box

961F-0E9

You can send files in the Mail Box, or save them in a file server.

NOTE

- Sending may not be able to be performed, depending on the saved document.

1 Press <Access Stored Files>. ▶<Home> Screen(P. 332)

2 Press <Mail Box>.

3 Select the desired box.

- For information on the items on the screen and instructions on how to use them, see ▶<Editing Files in the Mail Box(P. 729) .

4 Select a file and press <Send>.

5 Specify the destination and the settings for sending as necessary.

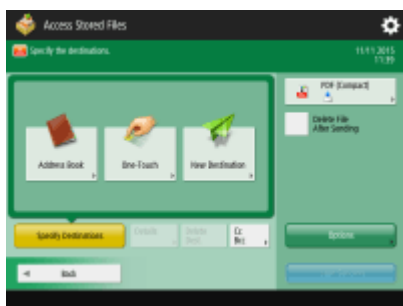

- For details, see the following, but note that they include some settings that you cannot specify in this step.
 - ▶<Faxing(P. 519)
 - ▶<Scanning(P. 635)
- To delete the selected file after sending, press <Delete File After Sending>.

6 Press <Start Sending>.

⇒ The selected file is sent to the specified destination.

- To cancel sending, press  (Status Monitor) ▶ <Send> ▶ <Job Status> ▶ select a file ▶ press <Cancel>.

Specifying the Mail Box Settings

961F-0EA

You can set a password and name for the Mail Box as well as change the period of time before files are automatically deleted.

- 1 Press  (Settings/Registration).
- 2 Press <Function Settings> ▶ <Store/Access Files> ▶ <Mail Box Settings> ▶ <Set/Register Mail Boxes>.
- 3 Select the desired box.
- 4 Specify the settings necessary and press <OK>.



(Items shown on the screen may differ depending on your model and options.)

a <Register Box Name>

Enter a name for the box.

b <PIN>

Set a password for the box. Enter a number of up to seven digits, press <Confirm>, enter the same password, and then press <OK>.

IMPORTANT

- Passwords with only "0" are not allowed.
- If you forget your password, there is no way to retrieve it. Be careful not to forget the password.

c <Time Until File Auto Delete>

Press <->/<+> to change the period of time until saved files are automatically deleted. When set to "0," files will not be deleted.

d <URL Send Settings>

Notifies you by e-mail of the location (URL) of the box where files are saved. This setting is helpful for checking saved files from the Remote UI screen.



e <Initialize>

Restores all the settings to the factory default values. Note that you cannot initialize the settings when files are stored in the box.

f <Print When Storing from Printer Driver>

Specify whether to print a file when it is sent from a computer and saved in the box.

NOTE

- <Time Until File Auto Delete> and <Print When Storing from Printer Driver> can be specified for all boxes at the same time. See  <**Time Until File Auto Delete**>(P. 1290) and  <**Print When Storing from Printer Driver**>(P. 1290) .

Working with Data in Memory Media

961F-0EC

Connecting memory media to the USB port of the machine enables you to save scanned data or print files in the media. Rename files or delete unwanted files from the machine so that you can manage and organize data in the media without using a computer.

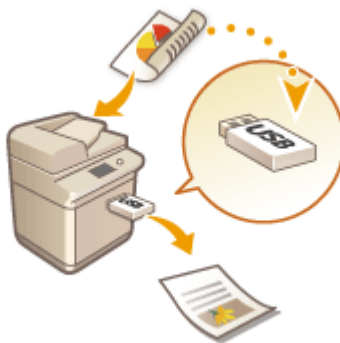

- ▶ **Saving Documents in Memory Media(P. 741)**
- ▶ **Working with Files and Folders in Memory Media(P. 743)**
- ▶ **Printing Files in Memory Media(P. 747)**

Inserting a memory media

For available memory media or how to insert a memory media, see ▶ **Connecting a USB Memory Device(P. 23)** .

! IMPORTANT

Be sure to check before using memory media

- To use the memory media, it is necessary that <Memory Media> in <Store Location Display Settings> is set to <On>. ▶ **<Store Location Display Settings>(P. 1065)**
- Set <Use Scan Function> and <Use Print Function> to <On>. ▶ **<Use Scan/Print Function>(P. 1300)**
- When the memory media is not recognized even if it is connected properly, the machine may be set to use the MEAP driver for USB external storage device. Set <Use MEAP Driver for USB Storage Device> to <Off>. ▶ **<Use MEAP Driver for USB Storage Device>(P. 1142)**

NOTE

- If <Select Option When Connecting Memory Media> is set to <On>, shortcuts to the available functions are displayed when you insert memory media. ▶ **<Select Option When Connecting Memory Media>(P. 1300)**

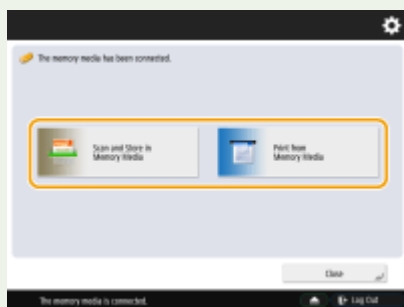

- Since the shortcuts may not be displayed if the machine is in the Sleep mode, insert the memory media after the machine has recovered from the Sleep mode.

Removing the memory media

When removing the memory media, always use the following procedure. Using a different procedure to remove the memory media may cause damage to the memory media and the main unit of the machine.

- 1 Press .



- 2 Select the memory media that you want to disconnect and press <Remove>.



- 3 Disconnect the memory media from the USB port and press <OK> ► <OK>.

Saving Documents in Memory Media

961F-0EE

Follow the procedures below to convert scanned documents into a file format commonly supported by a computer to save in memory media. This method is convenient when you need to move files to a computer not connected to a network.

NOTE

- You cannot store documents in the memory media if there is no free space available.

1 Set the original. ▶ **Placing Originals(P. 39)**

2 Press <Scan and Store>. ▶ **<Home> Screen(P. 332)**

- If <Select Option When Connecting Memory Media> is set to <On>, a shortcut to <Scan and Store in Memory Media> is displayed when you insert memory media. Press <Scan and Store in Memory Media> and proceed to step 4. ▶ **<Select Option When Connecting Memory Media>(P. 1300)** ▶ **Inserting a memory media(P. 739)**

3 Press <Memory Media>.

4 Select the desired memory media.

- For information on the items on the screen and instructions on how to use them, see ▶ **Working with Files and Folders in Memory Media(P. 743)** .

5 Display the save location and press <Scan>.

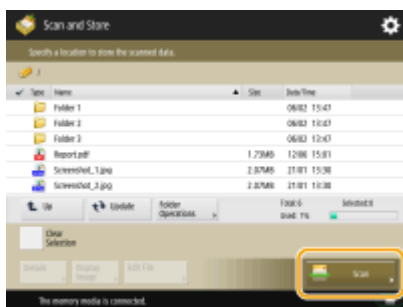

6 Specify the scan settings as necessary.

- For scan settings, see ▶ **Setting Screen and Operations for Scanning to Save(P. 749)** .

7 Press (Start).

Originals are scanned and saved as files.

- To cancel scanning, press <Cancel> or  (Stop) ▶ <Yes>.

■ **When <Press the [Start] key to scan the next original.> is displayed**

Place the next original to scan and press  (Start). After scanning all of the originals, press <Start Storing> to save the file.

NOTE

- To check the result of saving, press  (Status Monitor) ▶ <Store> ▶ <Job Log>. If <NG> is displayed, the file is not saved successfully. Try the operation again.

Working with Files and Folders in Memory Media

961F-0EF

You can create folders and delete files saved in memory media from the machine. For example, you can save a file created on a computer in memory media, and delete it from the machine after printing.

1 Press **<Access Stored Files>**. **><Home> Screen(P. 332)**

2 Press **<Memory Media>**.

3 Select the desired memory media.

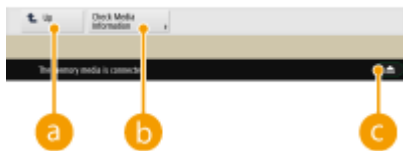

a **<Up>**

Press to move to the upper level from the current one.

b **<Check Media Information>**

Enables you to check the serial number and the free space of the memory media.

c

Press to remove the memory media. Be sure to press this button to safely remove the memory media. For instructions on how to remove, see **>Removing the memory media(P. 740)** .

4 Operate files and folders.



a **Files and folders saved**

Displays whether files or folders are selected, icons indicating the file type or folder, names, file sizes, and saved dates/times.

- Press <Name> or <Date/Time> to sort the list of files and folders by name or date/time in ascending (▲) or descending (▼) order.
- If you log in with personal authentication management, the sorting condition that was last used is retained. ▶ **List of Items That Can Be Personalized(P. 357)**
- When files are selected, numbered icons are displayed for each file, in the order selected. If you are printing multiple files at the same time, they are printed in that order.

b Total number of files/folders, number of selected files, and memory usage rate of memory media

Displays the total number of files/folders saved in the memory media, the number of currently selected files, and the memory usage rate of the memory media.

c <Print>

Prints files. ▶ **Printing Files in Memory Media(P. 747)**

d <Folder Operations>

Press this in the following cases.

- When checking <Details> for a folder that exists in the displayed level
- When performing <Create Folder> in the displayed level
- When performing <Delete> for a folder that exists in the displayed level

NOTE

- The following items can be checked in <Details>. You can also press <Rename Folder> to rename the folder.
 - Folder Name
 - Location
 - Updated

e <Edit File>

Press to rename or delete files.

f <Display Image>

Displays the preview image of a file. You can also print after checking the preview image and deleting unnecessary pages.

g <Details>

Displays the following items. You can also press <Change File Name> to rename the file.

- File Name
- Location
- File Type
- Size
- Updated

h <Clear Selection>

Deselects all the files selected in **a**.

i Display switch button

Press <Up> to move to the upper level from the current one. To update the contents of the displayed screen, press <Update>.

■ To change a file name

- 1 Select a file and press <Edit File> ▶ <Change File Name>.

- 2 Enter a file name and press <OK>.

■To display the preview image of a file

- 1 Select a file and press <Display Image>.
- 2 After checking the preview image, press <Back>.

■To check the detailed information of a file

- 1 Select a file and press <Details>.
- 2 After checking the detailed information, press <OK>.

■To delete a file

- 1 Select a file and press <Edit File> ► <Delete>.
- 2 Press <Yes>.

NOTE

- You can select and delete up to 32 files at a time.

■To scan and save documents

- 1 Set the original. ▶ **Placing Originals(P. 39)**
- 2 Press <Edit File> ► <Add Files (Scan and Store)>.
- 3 Specify the scan settings as necessary and press  (Start).
 - For scan settings, see ▶ **Setting Screen and Operations for Scanning to Save(P. 749)** .

■To create a folder

- 1 Press <Folder Operations>.
- 2 Press <Create Folder>.
- 3 Enter a folder name and press <OK>.
- 4 Press <OK>.

■To change a folder name

- 1 Display a folder whose name you want to change and press <Folder Operations>.
- 2 Select a folder and press <Details>.
- 3 Press <Rename Folder>.

4 Enter a folder name and press <OK>.

5 Press <OK>.

■ To check the detailed information of a folder

1 Display a folder whose information is to be checked and press <Folder Operations>.

2 Select a folder and press <Details>.

3 After checking the detailed information, press <OK>.

Printing Files in Memory Media

961F-0EH

Even if the machine is not connected to a computer, or a printer driver is not installed in the computer, you can print files saved in memory media from the machine.

1 Press <Access Stored Files>. ▶ <Home> Screen(P. 332)

- If <Select Option When Connecting Memory Media> is set to <On>, a shortcut to <Print from Memory Media> is displayed when you insert memory media. Press <Print from Memory Media> and proceed to step 4. ▶ <Select Option When Connecting Memory Media>(P. 1300) ▶ <Inserting a memory media>(P. 739)

2 Press <Memory Media>.

3 Select the desired memory media.

- For information on the items on the screen and instructions on how to use them, see ▶ <Working with Files and Folders in Memory Media>(P. 743) .

4 Select a file and press <Print>.

- If you select PDF or XPS files, proceed to step 6.

NOTE

- You can select and print up to 6 files in the same memory media at a time.

5 Select the paper source and press <OK>.

6 Enter the number of prints using the numeric keys.

- If you select multiple files in step 4, press <Change No. of Copies> and enter the number of prints.

7 Specify the print settings as necessary.

- For print settings, see ▶ <Setting Screen and Operations for Printing Saved Files>(P. 752) .

NOTE

- To print a file with a password, press <Options> ▶ <Password to Open Document> ▶ <Encryption Password> or <Policy Password>, enter the password, and press <OK>. To print PDF files that forbid printing, or print PDF files that only allow low-resolution printing in high resolution, enter the specified password.
- If you press <Start Printing> without entering a password, a password entry screen is displayed if the file has an encryption password.

8 Press <Start Printing>.

▣▶▶▶ Printing starts.

- To cancel printing, press <Cancel> ► <Yes>.

LINKS

▶ **Saving Documents in Memory Media(P. 741)**

▶ **Loading Paper(P. 46)**

Setting Screen and Operations for Scanning to Save

961F-0EJ

When you press <Scan and Store> on the <Home> screen, and then press <Mail Box>, <Advanced Space>, <Network>, or <Memory Media> to scan originals, the following setting screen is displayed.

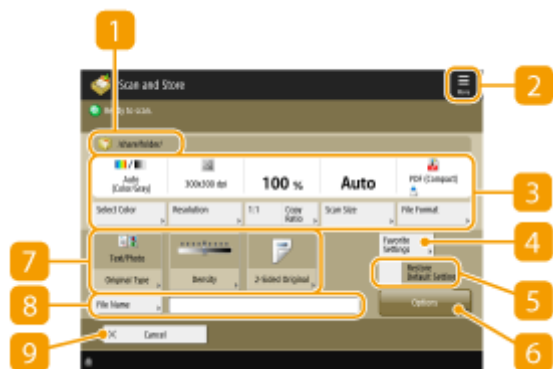

1 Save location

Mail Box, Advanced Space, Network, or Memory Media is displayed.

- For Mail Box, the box number and name is displayed next to the icon.
- For Advanced Space/Network/Memory Media, the directory path is displayed next to the icon.

2

Press this icon to register the current settings in <Favorite Settings> of **4** or in the Personal button/Shared button. **▶ Registering Frequently Used Settings and Destinations as Personal Buttons/Shared Buttons on the <Home> Screen(P. 372)**

3 Current setting status and setting buttons

Displays setting status such as resolution, magnification, and scanning size. Make sure to confirm the settings in order to scan properly. To change the settings, press the button under the display section. For information on file formats, see **▶ System Options(P. 1597)** .

- You can select the color mode for scanning by pressing <Select Color>. You can also select the following scan settings.
 - Mail Box: <Auto (Color/B&W)>, <Full Color>, <Black & White>
 - Other than Mail Box: <Auto (Color/Gray)>, <Auto (Color/B&W)>, <Full Color>, <Grayscale>, <Black & White>
- Depending on the state of the color original, it may be detected as black and white when scanned, even if you set <Auto (Color/Gray)> or <Auto (Color/B&W)>. To avoid this, set the color mode to <Full Color>.
- You can set the copy ratio to 100% by pressing <1:1>.
- You can specify the copy ratio to enlarge/reduce the scanning size by pressing <Copy Ratio>.
- When the size of the original cannot be detected with <Auto>, or when it is necessary to specify a particular size, press <Scan Size> and specify the size of the original to be scanned.
- Set <Resolution> to high when you want to scan the original clearly, and set <Resolution> to low when you want to reduce the file size. You can select the following resolutions.
 - Other than Mail Box: See "Resolution for Scan" in "Push Scan". **▶ Send Functions(P. 1580)**
 - For Mail Box, the resolution is fixed to 600 dpi x 600 dpi.
- Press <File Format> when you want to convert the scanned data into a digital file such as PDF. You can select the file format to convert to according to your purposes and environment.

4 <Favorite Settings>

Register frequently used scan settings here in advance to easily recall them when necessary.

5 <Restore Default Settings>

Changes scan setting into setting values registered in <Change Default Settings>. ▶<Change Default Settings>(P. 1284)

6 <Options>

Enables you to specify the settings of functions that are not displayed in **3** / **7**. For details about each setting item, see ▶<Options>(P. 1543) .

7 Function setting buttons

Displays the most frequently used buttons. The setting status is displayed on the buttons. To change the settings, press the desired button.

- If you press <Original Type>, you can manually select the scanning mode according to the type of originals, such as materials with only letters and magazines with pictures on them. To adjust the text/photo processing priority level, press <Adjust Level> ▶ select <Text Priority> or <Photo Priority>.
- If you press <Density>, you can adjust the density of the original.
- If you press <2-Sided Original>, you can automatically scan both the front and back sides of the original.

8 <File Name>

Press to assign a file name for a file when saving.

- You cannot use the following characters in a file name: \ / : , * ? " < > |. Also, you cannot use a . (period) or space for the first or last character of a file name.
- If you do not specify anything, the saved date and time is automatically assigned as a file name. For example, if a file is saved as a JPEG at 1:05:12 p.m. on October 30, 2015, its name will be "20151030130512.jpg."

NOTE

- If a file name is too long, the string (path) indicating the file location may exceed the maximum of 256 characters, causing the file to not be specified.
- If you enter a file name that already exists in the save location, (1) to (9) is added to the file name, for example, "a(1).pdf" (except for the files in the Mail Box).
- If <Divide into Pages> is selected when specifying the file format, a three-digit page number is added to the end of a file name. For a file with the name "a.pdf," for example, the file is divided into "a_001.pdf," "a_002.pdf," and "a_003.pdf" when saved.

9 <Cancel>

Cancels scan settings and returns to the file selection screen.

NOTE

- The number of pages remaining is displayed if a page limit is set with Department ID Management. For information on setting Department ID Management and page limits, see ▶<Configuring the Department ID Management Settings>(P. 842) .



LINKS

- ▶ **Saving Documents in the Advanced Space(P. 709)**
- ▶ **Saving Documents in Other Devices(P. 721)**
- ▶ **Saving Documents in the Mail Box(P. 725)**
- ▶ **Saving Documents in Memory Media(P. 741)**
- ▶ **Basic Operations for Scanning Originals(P. 640)**

Setting Screen and Operations for Printing Saved Files

961F-0EK

When you press <Access Stored Files> on the <Home> screen, and then press <Mail Box>, <Advanced Space>, <Network>, or <Memory Media> to print files, the following setting screen is displayed.

▶ **Setting screen for Mail Box(P. 752)**

▶ **Setting screen for Advanced Space/Network/Memory Media(P. 756)**

NOTE

- Depending on the function, see the <Copy> function for details.

Setting screen for Mail Box

■ Print Screen/Print Settings Screen

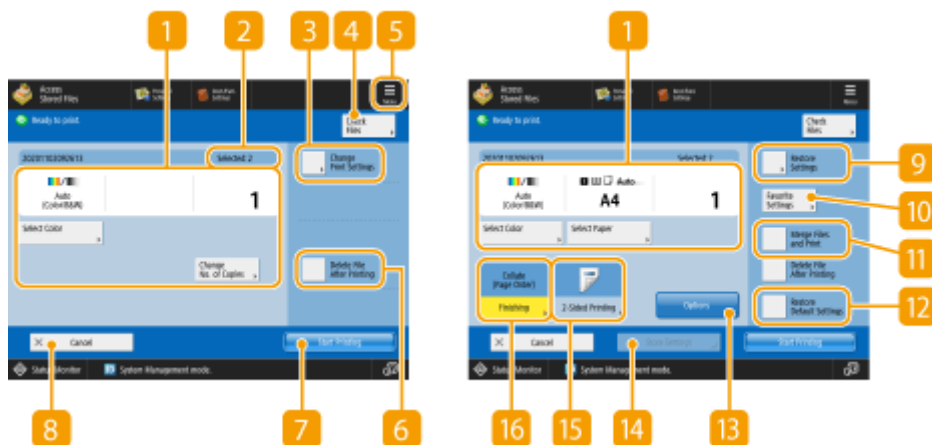

(Items shown on the screen may differ depending on your model and options.)

1 Current setting status and setting buttons

Displays setting status such as paper size to print on and the number of prints. Make sure to confirm the settings in order to print properly. To change the settings, press the button under the display section. To change the number of prints, enter the number using the numeric keys.

- You can select the color mode for printing by pressing <Select Color>.
- Depending on the settings you are specifying, the <Print Sample> button is displayed, which enables you to check the print result of a file.
- If you select multiple files, the <Change No. of Copies> button appears. Press this button when changing the number of copies.
- You can select the paper size/type and the paper source by pressing <Select Paper>.

NOTE:

- <Print Sample> appears only if you set to make multiple prints and one of the following settings at the same time. Note that the available functions may differ depending on your model and the installed options.
 - <Collate (Page Order)>

- <Offset>
- <Rotate 90 Degrees>
- <Staple + Collate>
- <Booklet>
- <Front Cover>
- <Insert Sheets>
- <Merge Files and Print> when multiple files are selected

2 Number of selected files

Displays the number of selected files.

- When selecting multiple files, the <Change No. of Copies> button appears. To change the number of prints, press this button.

3 <Change Print Settings>

To change the specified print settings, press this button to display the print settings screen.

NOTE:

- The settings registered in <Change Default Settings> are applied as print settings to the files saved using the <Scan and Store> function. ▶<Change Default Settings>(P. 1286)
- The print settings used for the files below are those current when the files were saved.
 - Files saved from the printer driver ▶<Saving Data on Computers>(P. 726)
 - Files saved using <Store in Mail Box> in the <Copy> function ▶<Storing Copy Documents in the Machine>(P. 493)

4 <Check Files>

Can be used to check the types and names of selected files.

- Select a file in the <Check Files> screen and press <Details> to display information such as the file size and update date/time.
- Select a file in the <Check Files> screen and press <Display Image> to display a preview image of the file.

5

Press this icon to register the current settings in <Favorite Settings> of **10** or to change the factory default print settings.

6 <Delete File After Printing>

Deletes a file automatically after it is printed.

7 <Start Printing>

Starts printing.

8 <Cancel>

Cancels print settings and returns to the file selection screen.

9 <Restore Settings>

Press to specify the settings again from the beginning and return to the print screen.

10 <Favorite Settings>

Register frequently used scan settings here in advance to easily recall them when necessary.

11 <Merge Files and Print>

Prints multiple selected files as one file. The file is printed using the settings registered in <Change Default Settings> instead of the print settings stored in each file. ▶<Change Default Settings>(P. 1286)

12 <Restore Default Settings>

Changes print settings into setting values registered in <Change Default Settings>. ▶<Change Default Settings>(P. 1286)

13 <Options>

Enables you to specify the settings of functions that are not displayed in **1** / **15**. For details about each setting item, see ▶<Options>(P. 755) .

14 <Store Settings>

Resaves a file with the print settings you changed.

- This key cannot be used if multiple files are selected.
- If there are already print settings stored, the information is overwritten.

15 <2-Sided Printing>

Select the type of 2-sided printing. Select <Book Type> when printing the front and back sides in the same top-bottom orientation. Select <Calendar Type> when printing the front and back sides in opposite top-bottom orientations.

16 <Finishing>

Select the finishing method.

- ▶<Finishing by Collating/Grouping>(P. 460)
- ▶<Finishing with the Stapler>(P. 462)
- ▶<Other Finishing Functions>(P. 464)

■ Options

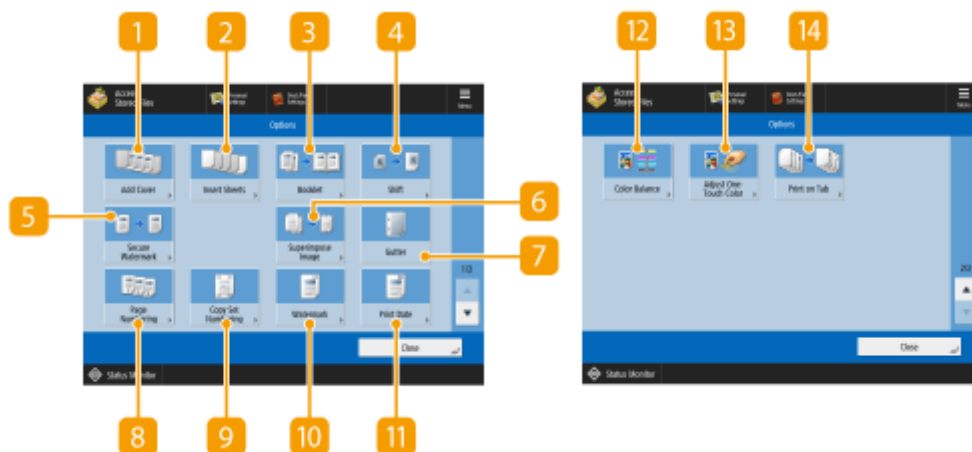

(Items shown on the screen may differ depending on your model and options.)

1 <Add Cover>

Adds covers. ▶ **Adding a Cover and Back Cover(P. 475)**

2 <Insert Sheets>/<Job Separator>

Inserts blank sheets between the specified pages. When selecting multiple documents, you can select <Job Separator> which can separate each document. ▶ **Inserting Sheets and Chapter Pages (Insert Sheets) (P. 485)**

3 <Booklet>

Prints a document with several pages in such a way that the prints are made into a booklet. ▶ **Making Booklets (Booklet Copying)(P. 469)**

4 <Shift>

Shifts the image to the specified location on the paper. ▶ **Shifting the Image(P. 481)**

5 <Secure Watermark>

Embeds hidden text in the background of the print. The hidden text will become visible if the resulting output is printed. ▶ **Embedding the "TOP SECRET" Text (Secure Watermark)(P. 510)**

7 <Gutter>

Creates gutters along the sides of the paper. ▶ **Setting Binding Margins(P. 473)**

8 <Page Numbering>

Adds page numbers. ▶ **Attaching Numbers and Symbols to Copies(P. 465)**

9 <Copy Set Numbering>

Adds the number of sets. ▶ **Attaching Numbers and Symbols to Copies(P. 465)**

10 <Watermark>

Adds watermarks. ▶ **Attaching Numbers and Symbols to Copies(P. 465)**

11 <Print Date>

Adds the date. ▶ **Attaching Numbers and Symbols to Copies(P. 465)**

12 <Color Balance>

Enables you to adjust the color balance. ▶ **Adjusting the Color(P. 440)**

13 <Adjust One-Touch Color>

Enables you to adjust the contrast. ▶ **One Touch Color Mode(P. 443)**

Setting screen for Advanced Space/Network/Memory Media

■ **Print Settings Screen**

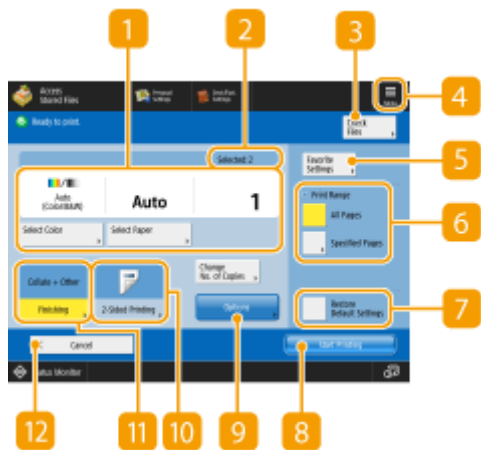

1 Current setting status and setting buttons

Displays setting status such as paper size to print on and the number of prints. Make sure to confirm the settings in order to print properly. To change the settings, press the button under the display section. To change the number of prints, enter the number using the numeric keys.

- You can select the color mode for printing by pressing <Select Color>.
- You can select the paper size/type and the paper source by pressing <Select Paper>.

2 Number of selected files

Displays the number of selected files.

- When selecting multiple files, the <Change No. of Copies> button appears. To change the number of prints, press this button.

3 <Check Files>

Can be used to check the types and names of selected files.

- Select a file in the <Check Files> screen and press <Details> to display information such as the file size and update date/time.
- Select a file in the <Check Files> screen and press <Display Image> to display a preview image of the file.



Press this icon to register the current settings in <Favorite Settings> of **5** or to change the factory default print settings.

5 <Favorite Settings>

Register frequently used scan settings here in advance to easily recall them when necessary.

6 <Print Range>

Specify this setting when you select a file with two pages or more. To print all pages of a file, press <All Pages>, or to specify the pages to print, press <Specified Pages> and enter the range of pages to print.

7 <Restore Default Settings>

Changes print settings into setting values registered in <Change Default Settings>. ▶<Change Default Settings>(P. 1286)

8 <Start Printing>

Starts printing.

9 <Options>

Enables you to specify the settings of functions that are not displayed in **1** / **10**. For details about each setting item, see ▶<Options>(P. 758) .

10 <2-Sided Printing>

Select the type of 2-sided printing.

NOTE:

- If you select a PDF file when <Select Paper> is set to <Auto>, and the sizes of the front and back page differ, the pages are printed as one-sided prints on paper of their respective sizes. If you want such pages to be printed as two-sided documents, select the appropriate paper sizes in advance.

11 <Finishing>

Select the finishing method.

- ▶<Finishing by Collating/Grouping>(P. 460)
- ▶<Finishing with the Stapler>(P. 462)
- ▶<Other Finishing Functions>(P. 464)

- Available when printing PDF/XPS files.

12 <Cancel>

Cancels print settings and returns to the file selection screen.

■ Options

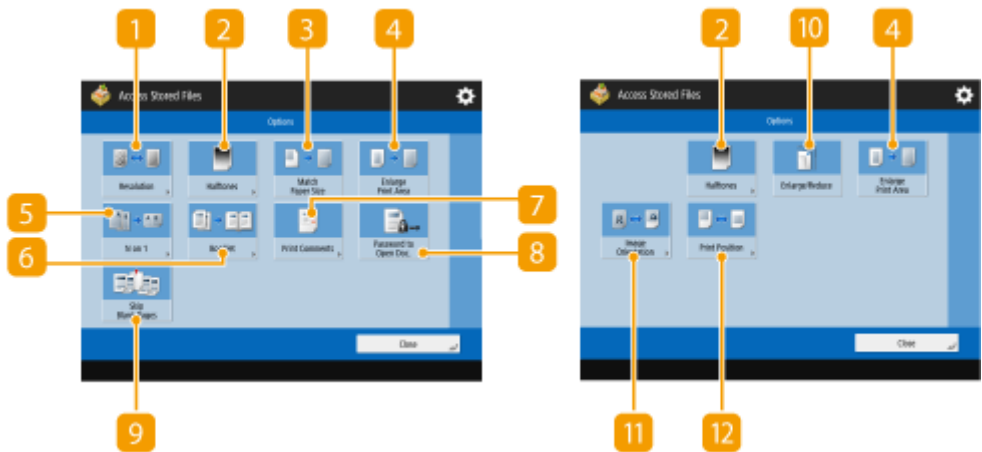

1 <Resolution>

Enables you to select the resolution.

2 <Halftones>

Enables you to select the halftone printing mode to match the file you want to print.

- <Resolution>: Enables fine printing so that the outlines of text data, etc. are clearer. This mode is optimal for printing data containing a lot of text or fine lines.
- <Gradation>: Enables printing with both smooth gradations and clear outlines. You can adjust this setting to smoothly print shapes and graphs using gradation.
- <Error Diffusion>: Suitable for sharply printing the contours of CAD data, and data that includes text and fine lines, etc.

3 <Match Paper Size>

Adjusts the size of a PDF/XPS file to match the paper size when printing.

4 <Enlarge Print Area>

Narrows the blank borders at each side of the page and enlarges the printable area.

5 <N on 1>

Automatically reduces multiple pages to fit on a single page when printing a PDF/XPS file. You can reduce 2, 4, 6, 8, 9, or 16 pages to fit on one page.

6 <Booklet>

Prints a document with several pages in such a way that the prints are made into a booklet. **▶ Making Booklets (Booklet Copying)(P. 469)**

7 <Print Comments>

Adds comments when printing PDF files.

8 <Password to Open Doc.>

Prints password protected PDF files by entering the password required to open them.

NOTE:

- When printing multiple PDF files with a password, each PDF file must have the same password to use this function.

9 <Skip Blank Pages>

Enables you to set the machine to detect blank pages included in documents and not print them.

10 <Enlarge/Reduce>

Enables you to adjust the image size of JPEG and TIFF files to match the paper size when printing.

11 <Image Orientation>

Enables you to set the machine to automatically detect the aspect ratio of the image for a JPEG or TIFF file, and print it vertically or horizontally as required. You can also manually specify to print vertically or horizontally.

12 <Print Position>

Enables you to set the print position for JPEG and TIFF files to the center or top left of the page when printing.

NOTE

- For information on file formats, see [▶System Options\(P. 1597\)](#) .
- The number of pages remaining is displayed if a page limit is set with Department ID Management. For information on setting Department ID Management and page limits, see [▶Configuring the Department ID Management Settings\(P. 842\)](#) .

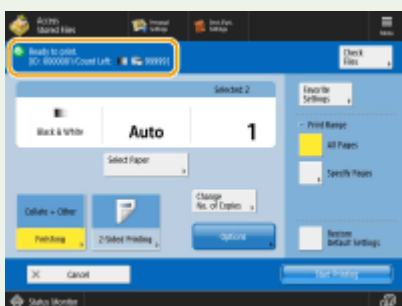

- Only the following functions can be set/changed when different file types (such as PDF and JPEG) are selected at the same time.
 - Color
 - Select Paper
 - 2-Sided Printing
 - Change No. of Copies

LINKS

[▶Printing Files in the Advanced Space\(P. 718\)](#)

- ▶ **Printing Files in Other Devices(P. 723)**
- ▶ **Printing Files in the Mail Box(P. 734)**
- ▶ **Printing Files in Memory Media(P. 747)**

Storage Locations and File Formats for Each Mode

961F-0EL

You can use <Options> from the print settings screen to access a wide variety of print options to meet your needs. The <Options> that you can use differ based on the storage location and file format. The following <Options> are supported for each storage location and file format.

✓ : Available

- : Unavailable

Options	Storage			
	Mail Box	Advanced Space/ Network/ Memory Media		
		TIFF/ JPEG	PDF	XPS
<Front Cover>	✓	-	-	-
<Job Separator>/<Insert Sheets>	✓	-	-	-
<Booklet>	✓	-	✓	✓
<Shift>	✓	-	-	-
<Secure Watermark>	✓	-	-	-
<Gutter>	✓	-	-	-
<Page Numbering>	✓	-	-	-
<Copy Set Numbering>	✓	-	-	-
<Watermark>	✓	-	-	-
<Print Date>	✓	-	-	-
<Color Balance>	✓	-	-	-
<Adjust OneTouch Color>	✓	-	-	-
<Resolution>	-	-	✓	✓
<Halftones>	-	✓	✓	✓
<Enlarge/Reduce>	-	✓	-	-
<Enlarge Print Area>	-	✓	✓	✓
<Image Orientation>	-	✓	-	-
<Print Position>	-	✓	-	-
<Match Paper Size>	-	-	✓	✓
<N on 1>	-	-	✓	✓
<Print Comments>	-	-	✓	-
<Password to Open Doc.>	-	-	✓	-

Using Storage Space

<Skip Blank Pages>	-	-	✓	✓
--------------------	---	---	---	---

Linking with Mobile Devices

Linking with Mobile Devices	764
Connecting with Mobile Devices	765
Connecting Directly	766
Utilizing the Machine through Applications	770
Using AirPrint	773
Printing with AirPrint	778
Scanning with AirPrint	781
Faxing with AirPrint	783
If AirPrint Cannot Be Used	785
Printing with Default Print Service (Android)	786

Linking with Mobile Devices

961F-0ER

Linking the machine with mobile devices such as smart phones and tablets enables you to easily print and scan using applications. In addition, you can operate the machine from mobile devices via remote control to confirm printing status and change the settings of the machine.



- ▶ **Connecting with Mobile Devices(P. 765)**
- ▶ **Utilizing the Machine through Applications(P. 770)**
- ▶ **Using AirPrint(P. 773)**
- ▶ **Printing with Default Print Service (Android)(P. 786)**

IMPORTANT

- Depending on your mobile device, the machine may not operate correctly.

Connecting with Mobile Devices

There are two methods to connect the mobile devices with the machine, "Connecting via a Wireless LAN Router" and "Direct connection." Select a connection method in accordance with the communication environment and the device you are using.

Perform communication with mobile devices from <Mobile Portal> ([▶<Home> Screen\(P. 332\)](#)). You can confirm the information of connected mobile devices, etc., from here.

■ Connecting via a Wireless LAN Router

For information on how to connect a mobile device to your wireless LAN router, see the manuals provided with the devices, or contact the manufacturer.

Connect with the machine using either a wired LAN or wireless LAN router. [▶Setting up the Network Environment\(P. 263\)](#)



NOTE

- To use Wireless LAN, the required wireless LAN connection must be installed. [▶System Options\(P. 1597\)](#)
- If you connect to the machine via a wireless LAN router, you can confirm details of the machine on the <LAN Connection> screen by pressing <Mobile Portal> ([▶<Home> Screen\(P. 332\)](#)) [▶<LAN Connection>](#).

■ Connecting Directly

Directly connect a mobile device to the machine wirelessly without using wireless LAN. It is possible to immediately connect to the machine wirelessly even outside of a wireless LAN environment. [▶Connecting Directly\(P. 766\)](#)



Connecting Directly

Even in an environment without a wireless LAN router, you can still directly connect your mobile device to the machine via "Access Point Mode" or "Wi-Fi Direct," which enable connections between the device and the machine without the need to configure complicated settings.



- ▶ **Preparing to Connect Directly(P. 766)**
- ▶ **Connecting Directly (Access Point Mode)(P. 767)**
- ▶ **Connecting Directly (Wi-Fi Direct)(P. 768)**

Preparing to Connect Directly

Establish a connection by using Access Point Mode in the following order.



Check the network settings of the machine.

- Press (Settings/Registration) ▶ <Preferences> ▶ <Network> ▶ <TCP/IP Settings> ▶ <IPv4 Settings> ▶ set <Use IPv4> to <On>.



Prepare the mobile device.

- Configure the mobile device to enable Wi-Fi connection.



Prepare the machine for connection.

- Press (Settings/Registration) ▶ <Preferences> ▶ <Network> ▶ <Direct Connection Settings> ▶ set <Use Direct Connection> to <On>.
- Press (Settings/Registration) ▶ <Preferences> ▶ <Network> ▶ <Direct Connection Settings> ▶ select the type of direct connection to use in <Direct Connection Type>.
- Press <Mobile Portal> (▶<Home> **Screen(P. 332)**) ▶ <Direct Connection> ▶ <Enable>.
- If <Wireless LAN> or <Wired LAN + Wireless LAN> is selected in <Select Interface>, <Wi-Fi Direct> cannot be used in <Direct Connection Type>. ▶<Select Interface>(P. 1089)

- If <Automatically Enable/Disable Direct Connection at Login/Logout> is set to <On> in <Personal SSID and Network Key Settings>, direct connections are possible when logging in without pressing <Mobile Portal> ▶ <Direct Connection> ▶ <Enable>. 🔄
<Personal SSID and Network Key Settings>(P. 1132)

NOTE

- For details on using Canon PRINT Business, see the related manuals. (<https://global.canon/gomp/>)
- If the message <Cannot be used with the current settings. Contact the system manager.> is displayed on the top of the touch panel display and <Enable> cannot be pressed, confirm that <Use Direct Connection> is set to <On>. If <Use Direct Connection> is set to <On> but <Enable> cannot be pressed, change the IP address in <IP Address Settings for Direct Connection>.
 - ▶<Use Direct Connection>(P. 1129)
 - ▶<IP Address Settings for Direct Connection>(P. 1132)
- When using the Access Point Mode, if the machine is started with <Always Keep Enabled If SSID/Network Key Specified> set to <On>, direct connections are possible without pressing <Mobile Portal> ▶ <Enable>. 🔄<Always Keep Enabled If SSID/Network Key Specified>(P. 1131)

Connecting Directly (Access Point Mode)

! IMPORTANT

- It may take some time for connection between the machine and the mobile device to be established.

■ Connecting Manually

- 1** With the machine as the connection destination, configure the wireless LAN settings on your mobile device, using the SSID and network key information shown on the touch panel display of the machine.
- 2** After completing the desired operations, press <Disconnect>.

■ Connecting with a QR Code

For Canon PRINT Business

- 1** Start Canon PRINT Business on the mobile device.
- 2** Read the QR code shown on the touch panel display of the machine.
- 3** After completing the desired operations, press <Disconnect>.

NOTE

- If you cannot read the QR code, update Canon PRINT Business to the latest version.

For devices using iOS (iOS11 or later)

- 1 Start the standard camera app on the iOS device.**
- 2 Read the QR code shown on the touch panel display of the machine.**
- 3 After completing the desired operations, press <Disconnect>.**

Connecting Directly (Wi-Fi Direct)**■ Connecting to the Machine from a Mobile Device**

- 1 Start a direct connection on the mobile device.**
 - Open the Wi-Fi Direct screen from the Wi-Fi settings screen of the mobile device, and tap the machine from the list of Wi-Fi Direct devices that have been detected.
 - ⇒ A message indicating that a connection request has been received from the mobile device is displayed on the touch panel display of the machine.
- 2 Press <Yes> on the touch panel display of the machine.**
 - ⇒ A connection between the machine and the mobile device is started.
- 3 After completing the desired operations, press <Disconnect>.**

■ Connecting to a Mobile Device from the Machine

- 1 Press the name of the device to directly connect to from the list displayed on the touch panel display, and press <Connect>.**
 - ⇒ A screen for selecting whether to allow a connection to the mobile device is displayed.
- 2 Tap [Yes] on the screen of the mobile device.**
 - ⇒ A connection between the machine and the mobile device is started.

3 After completing the desired operations, press <Disconnect>.

NOTE

- For details on linking with mobile devices, see the Setup for Linking with Mobile Devices Administrator Guide.

TIPS

- To check the connected mobile devices, press <Mobile Dev. Info> on the <Direct Connection> screen.

IMPORTANT

- While connecting via direct connection, you may not be able to connect to the Internet depending on the mobile device you are using.
- The connection standby status ends if a wireless connection is not performed from the mobile device within five minutes of the device name being displayed.
- If the status without data transmission between a mobile device and the machine continues during communication by direct connection, the communication may end.
- Power saving performance of sleep mode degrades while connecting via direct connection.
- When you finish the desired operation, be sure to terminate the connection between the machine and the mobile device. If they remain connected, power saving performance of sleep mode degrades.
- If you use the direct connection, do not set the IP address manually on the mobile device. Doing so may prevent proper communication after using the direct connection.

Utilizing the Machine through Applications

961F-0EW

Print by using applications from a mobile device connected to the machine. Various applications including those exclusive to Canon are supported. Use properly in accordance with your device, the application, and the situation.

■ Canon PRINT Business

An application for printing, etc. from mobile devices that support iOS/Android. No operations on the machine are necessary to perform printing. For information on supported operating systems, detailed setting methods, and operational procedures, see the Help of the application or the Canon website (<https://global.canon/gomp/>).

IMPORTANT

- Canon PRINT Business can be downloaded free of charge, but the customer is responsible for any fees regarding internet connection.

■ Printing with Canon Print Service

You can easily print from the menu of applications that support the Android print subsystem. For more information on supported operating systems and detailed settings and procedures, see the Canon website (<https://global.canon/gomp/>).

■ Printing and Scanning with Mopria®

The machine also supports Mopria®. Using Mopria® enables you to print from mobile devices that support Android using common operations and settings, even if manufacturers and models differ. For example, if you are using printers supporting Mopria® made by multiple manufacturers or a printer supporting Mopria® that is located in a place you are visiting, you can print without installing an application exclusive for each manufacturer or model. Mopria® can also be used to directly import the data scanned with the machine to mobile devices that support Android. For more information on supporting models or operation environments, see <http://www.mopria.org>.



Confirming Mopria® settings



Log in to the Remote UI with Administrator privileges (▶ **Starting the Remote UI(P. 902)**)
▶ [Settings/Registration] ▶ [Network Settings] ▶ [Mopria Settings] ▶ select the [Use Mopria] check box ▶ [OK]

IMPORTANT

- If you enable the Mopria® setting, <Use Network Link Scan> also changes to <On>.

- To use the Mopria® scan service, <Use Network Link Scan> must be set to <On>. [▶<Use Network Link Scan>\(P. 1109\)](#)

■ Printing with IPP Everywhere

This machine also supports IPP Everywhere. If your Chromebook supports IPP Everywhere, you can print directly from your Chromebook using IPP Everywhere.

Confirming IPP Everywhere



Log in to the Remote UI with Administrator privileges ([▶Starting the Remote UI\(P. 902\)](#))
 ▶ [Settings/Registration] ▶ [Network Settings] ▶ [IPP Everywhere Settings] ▶ select the [Use IPP Everywhere] check box ▶ [OK]

! IMPORTANT

If you select [Use IPP Everywhere], the following settings in <TCP/IP Settings> are set to <On>.

- Use HTTP
- IPP Print Settings
- Use IPv4 mDNS
- Use IPv6 mDNS

■ Printing from Windows Phone (Windows 10 Mobile and Later)

You can perform printing from a Windows Phone without downloading a dedicated application or installing a driver. Make sure that the <Use WSD>, <Use WSD Browsing>, and <Multicast Discovery Settings> are enabled.

[▶<WSD Settings>\(P. 1098\)](#)

[▶<Multicast Discovery Settings>\(P. 1099\)](#)

TIPS

Scan for Mobile

- The MEAP application, "Scan for Mobile" enables you to use the Scan function of the machine from the mobile device. You can operate the machine from your mobile device to scan originals, and then send the image that you scanned on the machine to your mobile device using WebDAV communication.

■ Printing from Chrome OS

You can perform printing from Chrome OS without downloading a dedicated application or installing a driver. To print with the machine, it is necessary to enable Mopria®.

Confirming Mopria® settings



Log in to the Remote UI with Administrator privileges (▶ **Starting the Remote UI(P. 902)**)
 ▶ [Settings/Registration] ▶ [Network Settings] ▶ [Mopria Settings] ▶ select the [Use Mopria] check box ▶ [OK]

! IMPORTANT

- If you enable the Mopria® setting, <Use Network Link Scan> also changes to <On>.
- To use the Mopria® scan service, <Use Network Link Scan> must be set to <On>. ▶ **<Use Network Link Scan>(P. 1109)**

Printing

1 Before printing, make sure that the machine is turned ON and connected to a Chromebook.

- For information on checking the connection status, see ▶ **Setting up the Network Environment(P. 263)** .
- See the Chromebook Help page (<https://support.google.com/chromebook/answer/7225252>) for more information on printing.

NOTE

- You can also connect the machine to a Chromebook using a USB cable. See the Chromebook website (<https://support.google.com/chromebook/answer/7225252>) for information on the connection procedure.

! IMPORTANT

- Printing from Chrome OS may not be supported, depending on your country or region.

Using AirPrint

961F-0EX

This section describes the settings required to use AirPrint and the procedure for printing, scanning, and sending faxes from Apple devices.



AirPrint Settings

- ▶ [Configuring AirPrint Settings\(P. 773\)](#)
- ▶ [Displaying the Screen for AirPrint\(P. 775\)](#)

Functions of the AirPrint

- ▶ [Printing with AirPrint\(P. 778\)](#)
- ▶ [Scanning with AirPrint\(P. 781\)](#)
- ▶ [Faxing with AirPrint\(P. 783\)](#)

Troubleshooting

- ▶ [If AirPrint Cannot Be Used\(P. 785\)](#)

Configuring AirPrint Settings

You can register information, including the name of the machine and installation location, that is used for identifying the machine. The settings required for using AirPrint can be configured remotely using the Remote UI.

■ Configuring Settings Using the Remote UI

- 1 Start the Remote UI and log on in System Manager Mode.** ▶ [Starting the Remote UI\(P. 902\)](#)
- 2 Click [Settings/Registration].**
 - If you are using a mobile device, such as an iPad, iPhone, or iPod touch, read "click" as "tap" in this section.
- 3 Click [Network Settings] ▶ [AirPrint Settings].**
- 4 Specify the required settings, and click [OK].**

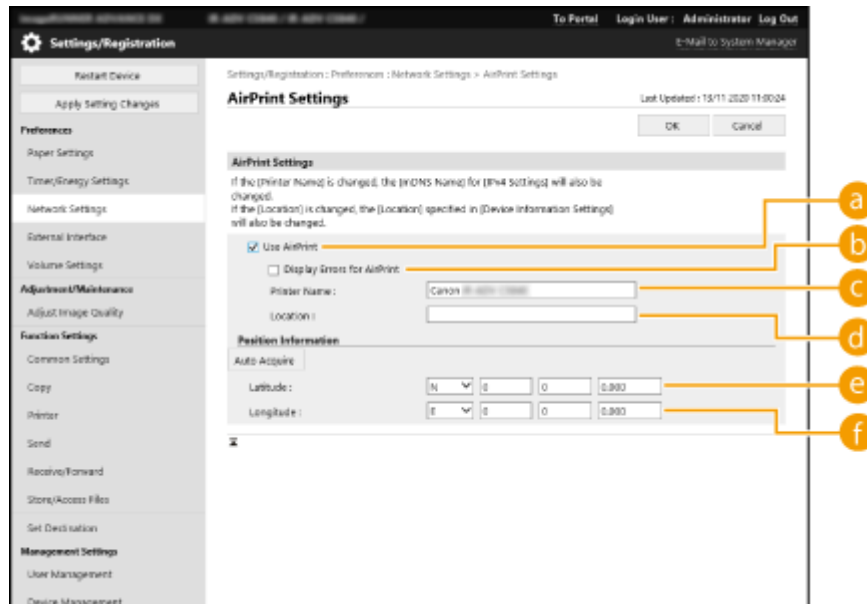

a [Use AirPrint]

Select the check box to enable AirPrint. To disable AirPrint, clear the check box.

b [Display Errors for AirPrint]

If you are printing with AirPrint and there is an issue with the print file and the file does not print correctly, you can use this setting to choose whether error screens appear on the control panel.

c [Printer Name]

Enter the name of the machine. If an mDNS name has already been registered in [mDNS Settings] ([Network Settings] in [Preferences] (Settings/Registration)), the registered name is displayed.

d [Location]

Enter the location of the machine. If a location has already been registered in [Device Information Settings] ([Device Management] in [Management Settings] (Settings/Registration)), the registered name is displayed.

e [Latitude]

Enter the latitude of the location where the machine is installed.

f [Longitude]

Enter the longitude of the location where the machine is installed.

5 Restart the machine.

- Turn OFF the machine, wait at least 10 seconds, and then turn it ON.

■ Configuring Settings from the Touch Panel Display

1 Press (Settings/Registration).

2 Press <Log In>.

- Enter the System Manager ID and System PIN.

3 Press <Preferences> ► <Network> ► <Use AirPrint>.

4 Press <On> ► <OK>.

IMPORTANT

If you select [Use AirPrint], the following settings in <TCP/IP Settings> are set to <On>.

- Use HTTP
- IPP Print Settings
- Use IPv4 mDNS
- Use IPv6 mDNS
- Use Network Link Scan

NOTE

- If you change [Printer Name] that you have once specified, you may be unable to print any more from the Mac that has been able to be used for printing so far. This phenomenon occurs because <mDNS Name> ( **Making DNS Settings(P. 289)**) of IPv4 is also changed automatically. In this case, add the machine to the Mac again.
- When AirPrint is in-use, <Use Same mDNS Name as IPv4> is fixed to <On> for the mDNS name of IPv6.
- Entering the printer name makes it easier to identify multiple printers that support AirPrint.

Displaying the Screen for AirPrint

You can display the screen for AirPrint, on which you can not only access the AirPrint Settings but also view information about consumables, such as paper and toner cartridge. Further, you can configure security function settings.

■ Displaying from a Mac

1 Click [System Preferences] in the Dock on the desktop ► [Printers & Scanners].

2 Select the machine, and click [Options & Supplies].

3 Click [Show Printer Webpage].

4 Logging in to the Remote UI

- To change the AirPrint settings, it is necessary to log in as an administrator.

■ Configuring the Screen for AirPrint

If you log in with administrator privileges, you can also change the AirPrint settings from the page for AirPrint.

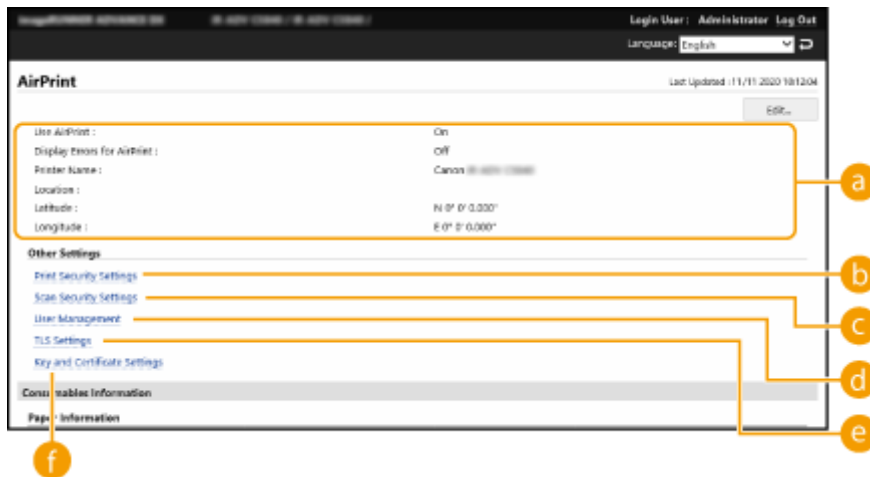

a [AirPrint]

Enables you to check the values entered in the AirPrint settings, such as the name and location of the machine. You can click [Edit...] to change the settings.

b [Print Security Settings]

Specify the settings required to print using TLS and authentication.

If <IPP Print Settings> is already set, the existing settings are displayed. The values registered in [Print Security Settings] change according to the values in <IPP Print Settings>.

c [Scan Security Settings]

Specify the settings required to scan using TLS.

If <Use TLS> in <Use Network Link Scan> is already set, the existing settings are displayed. The values registered in [Scan Security Settings] change according to the value in <Use TLS> in <Use Network Link Scan>.

d [User Management]

You can add/edit users to authenticate. ▶ **Managing Users(P. 803)**

e [TLS Settings]

Enables you to change the key and certificate used for TLS. ▶ **Configuring the Key and Certificate for TLS(P. 864)**

f [Key and Certificate Settings]

Enables you to generate and install a key and certificate, or request a certificate to be issued. ▶ **Configuring the Key and Certificate for TLS(P. 864)**

■ Checking Consumables and the Device Version

You can check information regarding the paper sources of the machine, the remaining amount of toner, and the device version.

Trademarks

Apple, Bonjour, iPad, iPhone, iPod touch, Mac, OS X, and Safari are trademarks of Apple Inc. AirPrint and the AirPrint logo are trademarks of Apple Inc.

iOS is a trademark or registered trademark of Cisco in the U.S. and other countries and is used under license.

Printing with AirPrint

961F-0EY

You can print from an iPad, iPhone, iPod touch, or Mac without using a printer driver.

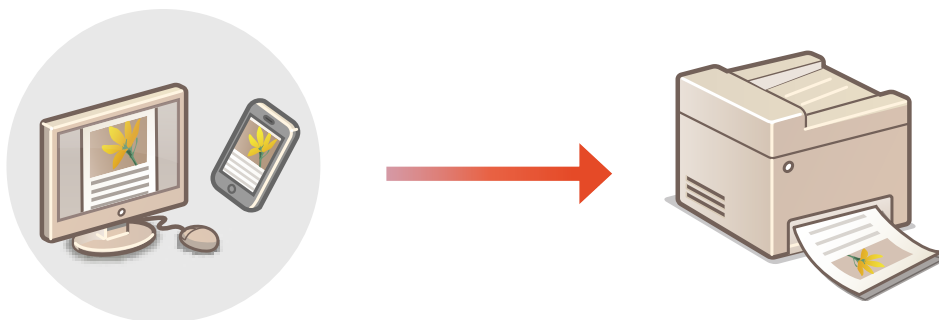

▶ **Printing from an iPad, iPhone, or iPod touch(P. 778)**

▶ **Printing from a Mac(P. 779)**

System Requirements

One of the following Apple devices is required to print with AirPrint.

- iPad (all models)
- iPhone (3GS or later)
- iPod touch (3rd generation or later)
- Mac (Mac OS X 10.7 or later)*

* OS X 10.9 or later when using a USB connection

Network Environment

One of the following environments is required.

- An environment where an Apple device and the machine are connected to the same LAN
- An environment where an Apple device and the machine are connected directly
- An environment where a Mac is connected to the machine via USB

Printing from an iPad, iPhone, or iPod touch

1 Make sure that the machine is turned ON and connected to the Apple device.

- For how to make sure of this, see ▶ **Setting up the Network Environment(P. 263)** .
- For information on the Direct Connection, see ▶ **Connecting Directly(P. 766)** .

2 From the application on your Apple device, tap  to display the menu options.

3 Tap [Print].

4 Select this machine from [Printer].

⇒ The printers connected to the network are displayed here. Select this machine in this step.

IMPORTANT

- The screen for selecting the machine in [Printer] is not displayed for applications that do not support AirPrint. In this case, printing cannot be performed.

5 Specify the print settings as necessary.

NOTE

- The available settings and paper sizes differ depending on the application you are using.

6 Tap [Print].

⇒ Printing starts.

NOTE

Checking the print status

- During printing, press the Home button of the Apple device twice ► tap [Print].

Printing from a Mac

1 Make sure that the machine is turned ON and connected to the Mac.

- For how to make sure of this, see [▶ Setting up the Network Environment \(P. 263\)](#) .

2 From your Mac, add the machine in [System Preferences] ► [Printers & Scanners].

- If the machine has already been added for scanning or sending faxes, this operation is not required.

3 Open a document in an application and display the print dialog box.

- How to display the print dialog box differs for each application. For more information, see the instruction manual for the application you are using.

4 Select the machine in the print dialog box.

⇒ The printers added to the Mac are displayed. Select the machine in this step.

5 Specify the print settings as necessary.

NOTE

- The available settings and paper sizes differ depending on the application you are using.

6 Click [Print].

⇒ Printing starts.

NOTE

- You can specify whether to display an error screen on the control panel if printing cannot be performed as expected due to a problem with the print data. For details, see [▶<Display Errors for AirPrint>\(P. 1087\)](#) .

Scanning with AirPrint

961F-0F0

You can use AirPrint to transfer the data scanned by the machine directly to a Mac.

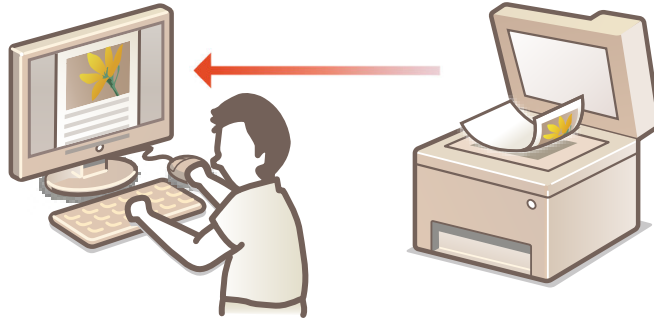

System Requirements

To scan with AirPrint, you need a Mac with OS X 10.9 or later installed. To scan using TLS, you need a Mac with OS X 10.11 or later installed.

Network Environment

One of the following environments is required.

- An environment where an Apple device and the machine are connected to the same LAN
- An environment where a Mac is connected to the machine via USB

! IMPORTANT

- For scanning, it is required to set <Use Network Link Scan> to <On>. ▶<Use Network Link Scan>(P. 1109)
- A firmware update may also be required. ▶<Updating the Firmware>(P. 970)
- You cannot scan while settings for operations are being made, or while the machine is performing any operation whatsoever.

Scanning from a Mac

- 1 Make sure that the machine is turned ON and connected to the Mac.**
 - For how to make sure of this, see ▶<Setting up the Network Environment>(P. 263) .
- 2 From your Mac, add the machine in [System Preferences] ▶ [Printers & Scanners].**
 - If the machine has already been added for printing or sending faxes, this operation is not required.
- 3 Select this machine from the list of printers in [Printers & Scanners].**
- 4 Click [Scan].**

5 Click [Open Scanner].

⇒ The [Scanner] screen is displayed.

6 Configure the scan settings as necessary.

7 Click [Scan].

⇒ The document is scanned, and the image is displayed.

Faxing with AirPrint

961F-0F1

You can send faxes from a Mac in almost the same way as when you print from a Mac.



System Requirements

To send faxes with AirPrint, you need a Mac with OS X 10.9 or later installed.

Network Environment

One of the following environments is required.

- An environment where an Apple device and the machine are connected to the same LAN
- An environment where a Mac is connected to the machine via USB

! IMPORTANT

- A firmware update may be required to send faxes. ▶ [Updating the Firmware \(P. 970\)](#)

Faxing from a Mac

1 Make sure that the machine is turned ON and connected to the Mac.

- For how to make sure of this, see ▶ [Setting up the Network Environment \(P. 263\)](#) .

2 From your Mac, add the machine in [System Preferences] ▶ [Printers & Scanners].

- If the machine has already been added for printing or sending faxes, this operation is not required.

3 Open a document in an application and display the print dialog box.

- How to display the print dialog box differs for each application. For more information, see the instruction manual for the application you are using.

4 Select this machine in the print dialog box.

⇒ The printers added to the Mac are displayed. Select the fax driver of the machine in this step.

5 Specify the destination.

6 Click [Fax].

⇒ Fax sending starts.

If AirPrint Cannot Be Used

961F-0F2

If AirPrint cannot be used, try taking the following solutions.

- Make sure that the machine is turned ON. If the machine is turned ON, first turn it OFF, then wait for at least 10 seconds and then turn it back ON to check if the problem is solved.
- Make sure that no error messages are displayed on the machine.
- Make sure that Apple devices and the machine are connected to the same LAN. If the machine is turned ON, it may take several minutes before the machine is ready for communication.
- Make sure that Bonjour on your Apple device is enabled.
- Make sure that the machine is configured to enable operations from a computer even when no department ID and password are entered.
- For printing, make sure that the paper is loaded in the machine and the machine has sufficient toner levels remaining. ▶ **Displaying the Screen for AirPrint(P. 775)**
- For scanning, make sure that the machine's setting for Network Link Scan is <On>. ▶ **<Use Network Link Scan>(P. 1109)**

Printing with Default Print Service (Android)

961F-0F3

If your Android terminal supports Default Print Service, you can print from the Default Print Service of your Android terminal.

To print with the machine using Default Print Service, it is necessary to enable Mopria®.

Confirming Mopria® settings



Log in to the Remote UI with Administrator privileges (▶ **Starting the Remote UI(P. 902)**)
 ▶ [Settings/Registration] ▶ [Network Settings] ▶ [Mopria Settings] ▶ select the [Use Mopria] check box ▶ [OK]

! IMPORTANT

- If you enable the Mopria® setting, <Use Network Link Scan> also changes to <On>.
- To use the Mopria® scan service, <Use Network Link Scan> must be set to <On>. ▶ **<Use Network Link Scan>(P. 1109)**

NOTE

- In order to use the Canon machine/printer from the Default Print Service of your Android terminal, you must first configure the following settings on your Android terminal.
 - Enable Default Print Service.
 - Disable or uninstall Mopria®.
 - Disable or uninstall Canon Print Service.

Managing the Machine

Managing the Machine	790
Applying a Security Policy to the Machine	792
Using a Password to Protect the Security Policy Settings	793
Configuring the Security Policy Settings	795
Security Policy Setting Items	797
Managing Users	803
Configuring the Personal Authentication Management Settings	806
Registering User Information in the Local Device	809
Importing/Exporting User Data	813
Adding and Editing User Information in a CSV File	818
Registering Server Information	823
Configuring the Authentication Functions	829
Using Personal Authentication to Manage Printing/Faxing/Remote Scanning via a Computer	837
Using Other Convenient Personal Authentication Management Functions	838
Setting the Department ID Management	839
Changing the System Manager ID and PIN	840
Configuring the Department ID Management Settings	842
Using Department IDs to Manage Printing or Remote Scanning via Computer	845
Configuring Personal Folders	846
Using ACCESS MANAGEMENT SYSTEM	849
Deleting User Setting Information	850
Configuring the Network Security Settings	852
Restricting Communication by Using Firewalls	854
Specifying IP Addresses in Firewall Settings	855
Specifying MAC Addresses in Firewall Settings	858
Configuring the Firewall of the Sub Line	859
Setting a Proxy	862
Configuring the Key and Certificate for TLS	864
Generating the Key and Certificate for Network Communication	867
Configuring the IPSec Settings	869
Configuring the IEEE 802.1X Authentication Settings	874
Restricting the Machine's Functions	877
Restricting Access to Address Book and Sending Functions	878
Restricting Use of the Address Book	879
Limiting Available Destinations	882
Restricting the Fax Sending Functions	884

Restricting Printing from a Computer	886
Restricting the Use of Memory Media	889
Increasing the Security of Documents	890
Printing User Information on Documents	891
Embedding Invisible Text (Forced Secure Watermark)	893
Adding a Digital Signature to Sent Files	895
Generating a Device Signature Certificate	896
Registering a User Signature Certificate	897
Managing the Machine from a Computer (Remote UI)	900
Starting the Remote UI	902
Checking the Status and Logs	906
Turning OFF/Restarting the Machine	911
Registering Destinations via the Remote UI	912
Sharing an Address List with Specific Users	916
Registering User Groups	918
Registering a Key and Certificate for Network Communication	920
Configuring the Expiration Check Method for Received Certificates	924
Generating a Key and Certificate Signing Request (CSR)	926
Retrieving/Updating a Certificate from an SCEP Server	929
Managing Stored Files	935
Managing the Logs	941
Importing/Exporting the Setting Data	946
Importing/Exporting All Settings	950
Importing/Exporting the Settings Individually	954
Address Book Items	960
Backing Up/Restoring Data	965
Updating the Firmware	970
Updating the Firmware (Distribution)	972
Setting Scheduled Updates	975
Displaying Messages from the Administrator	977
Configuring the Visual Message Function	979
Sending E-Mail Notification When an Error Occurs	984
Installing System Options	986
Synchronizing Settings for Multiple Canon Multifunction Printers	988
Starting Setting Synchronization	991
Specifying Detailed Synchronization Settings (Server Machine or Server/Client Machine)	995
Switching the Machines to Synchronize	1000
Distributing the Device Information to Other Canon Multifunction Printers	1005
Registering the Device Information Destinations	1007
Performing User Authentication when Distributing Device Information	1009
Distributing the Device Information	1011
Checking the Results of Device Information Distribution	1014
Managing Storage Device Data	1015

Initializing All Data/Settings	1016
Using TPM	1018
Functions Linked to Cloud Service	1022
Checking the Number of Pages for Copy/Print/Fax/Scan	1025
Printing Reports and Lists	1026
Checking the Options Installed on This Machine	1038
Paper Type Management Settings	1039
Adjusting the Image Position	1044
Adjusting the Secondary Transfer Voltage	1047

Managing the Machine

961F-0F4

To reduce the various risks associated with using this machine, such as the leakage of personal information or unauthorized use by third parties, constant and effective security measures are required. Designate an administrator to handle important machine settings, such as the user management and security settings, to ensure that the machine is used safely.

■ Configuring the Basic Management System

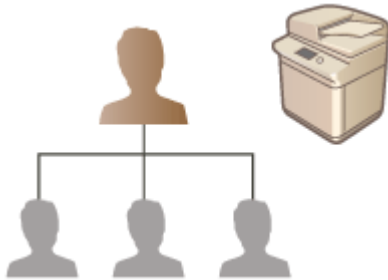

- ▶ **Applying a Security Policy to the Machine(P. 792)**
- ▶ **Managing Users(P. 803)**
- ▶ **Configuring the Network Security Settings(P. 852)**
- ▶ **Managing Storage Device Data(P. 1015)**

■ Limiting Risks from Negligence, Operation Errors, and Misuse



- ▶ **Restricting the Machine's Functions(P. 877)**
- ▶ **Increasing the Security of Documents(P. 890)**

■ Ensuring Effective Management

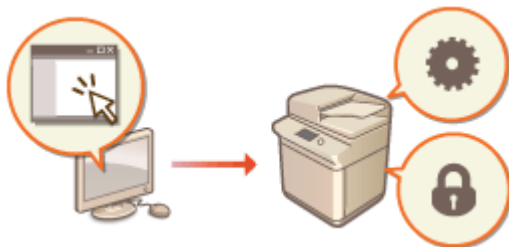

- ▶ **Managing the Machine from a Computer (Remote UI) (P. 900)**
- ▶ **Synchronizing Settings for Multiple Canon Multifunction Printers(P. 988)**
- ▶ **Distributing the Device Information to Other Canon Multifunction Printers(P. 1005)**

■ Managing the System Configuration and Settings



- ▶ **Installing System Options(P. 986)**
- ▶ **Initializing All Data/Settings(P. 1016)**

■ Others



- ▶ **Functions Linked to Cloud Service(P. 1022)**
- ▶ **Checking the Number of Pages for Copy/Print/Fax/Scan(P. 1025)**
- ▶ **Printing Reports and Lists(P. 1026)**
- ▶ **Paper Type Management Settings(P. 1039)**

Applying a Security Policy to the Machine

961F-0F5

It is a common practice for organizations to adopt a security policy that defines basic information security objectives and standards, which requires information devices such as computers and multifunctional printers to be operated accordingly. On this machine, multiple settings related to security policy can be managed in batch via the Remote UI, and a dedicated password can be set up so that only the information security administrator is able to modify the settings. Before configuring these settings, make sure that the Remote UI is set up to use TLS. [Starting the Remote UI\(P. 902\)](#)



- [Using a Password to Protect the Security Policy Settings\(P. 793\)](#)
- [Configuring the Security Policy Settings\(P. 795\)](#)
- [Security Policy Setting Items\(P. 797\)](#)

IMPORTANT

- The purpose of the security policy settings is to manage all functions and settings related to information security, and not to actually prevent information leakage itself.

Using a Password to Protect the Security Policy Settings

961F-0F6

It is recommended that you use a password to protect the machine settings related to security policy. By setting a password, the privilege for modifying the security policy settings can be restricted only to the information security administrators who know the password.

1 Start the Remote UI. ▶Starting the Remote UI(P. 902)

2 Click [Settings/Registration] on the portal page. ▶Remote UI Screen(P. 904)

3 Click [Security Settings] ▶ [Security Policy Settings].

⇒ The [Confirm Security Policy] page is displayed.

4 Click [Password Settings].

5 Enter a password and click [OK].

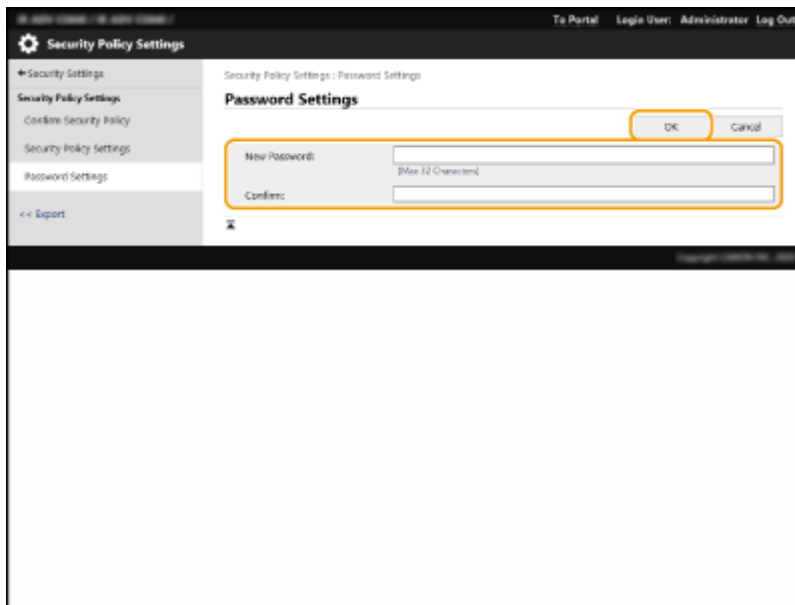

- Use alphanumeric characters or symbols for the password.
- Make sure that the password is entered correctly, and enter the new password again in [Confirm:].

NOTE

To change the password

- Enter the current password in [Old Password:] and the new password in [New Password:], then enter the new password again in [Confirm:] and click [OK].

To remove the password

- Enter the current password in [Old Password:], and click [OK] without entering any value for [New Password:] or [Confirm:] (leave them blank). If an input character limit has been configured in [Password Settings Policy], a value must be entered for this setting. Cancel the limit before removing the password.

▶Security Policy Setting Items(P. 797)

IMPORTANT

- Make sure that you do not forget your password. If you forget your password, contact your dealer or service representative.

NOTE

- To set/change the password, it is necessary to log in to the Remote UI with one of the following privileges.
 - Administrator
 - DeviceAdmin
 - NetworkAdmin
- If a password is set, it will be required for authentication in order to initialize the machine. After authentication is performed and the machine is initialized, the password will be deleted. ▶ **Initializing All Data/Settings(P. 1016)**

Configuring the Security Policy Settings

961F-0F7

Machine settings related to information security can be applied and managed in batch. It is recommended that the information security administrator in charge of managing your security policy apply the security policy to the machine in accordance with the policy of your organization. To configure the security policy, log in to the Remote UI with Administrator privileges.

- 1 Start the Remote UI. [▶Starting the Remote UI\(P. 902\)](#)
- 2 Click [Settings/Registration] on the portal page. [▶Remote UI Screen\(P. 904\)](#)
- 3 Click [Security Settings] ▶ [Security Policy Settings].
- 4 Click [Security Policy Settings].

⇒ The setting precautions are displayed. Make sure to read and understand the contents.

NOTE

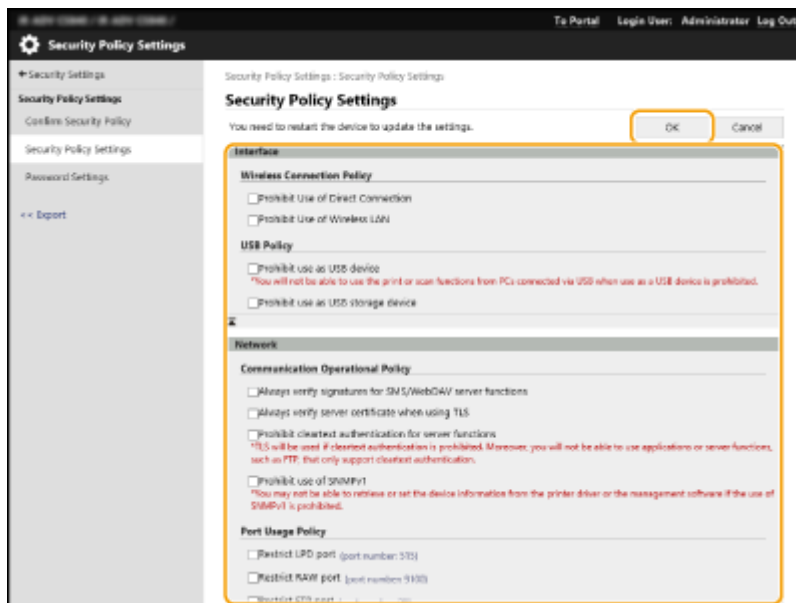

- If no password has been configured ([▶Using a Password to Protect the Security Policy Settings\(P. 793\)](#)), read the contents and click [OK] to proceed to step 6.

- 5 Enter the password and click [Log In].
- 6 Configure the necessary items and click [OK].



- For information on the settings, see [▶Security Policy Setting Items\(P. 797\)](#) .



- The settings related to items indicated with a check mark here cannot be changed using  (Settings/Registration) or the Remote UI.
- For any machine settings that were changed when the security policy settings were applied, you cannot simply clear the check box to restore the previously set value. To change the settings, use  (Settings/Registration) or the Remote UI.

7 Click [OK].

NOTE

- If a security policy has been configured, a message indicating that functions and operations are restricted is displayed when the <Settings/Registration> screen is displayed on the control panel or the Remote UI.

■ Applying the Security Policy Settings to Another Device

You can import and export the machine's security policy settings. By applying the same policy to multiple devices*, you can manage all of the devices in your organization using identical settings.  **Importing/Exporting the Setting Data(P. 946)**

* Only Canon devices that are compatible with security policy settings

NOTE

- The security policy settings can only be imported if the security policy setting password on the exporting machine matches that of the importing machine, or if no password has been set for the importing machine. If no password has been set for the importing machine, the password configured for the exporting machine is set to the importing machine.

Security Policy Setting Items

961F-0F8

The setting items related to the security policy of the machine are described below. Select the check boxes for the items that you want to apply on the setting screen.

■ [Interface]

[Wireless Connection Policy]

Prevent unauthorized access by prohibiting wireless connections.

[Prohibit Use of Direct Connection]	<Use Direct Connection> and <Always Keep Enabled If SSID/ Network Key Specified> are set to <Off>. It is not possible to access the machine from mobile devices.	<input checked="" type="checkbox"/> <Connecting Directly>(P. 766) <input checked="" type="checkbox"/> <Network>(P. 1080)
[Prohibit Use of Wireless LAN]	<Select Wired/Wireless LAN> is set to <Wired LAN>. It is not possible to establish a wireless connection with the machine via a wireless LAN router or access point.	<input checked="" type="checkbox"/> <Select Interface>(P. 1089)

[USB Policy]

Prevent unauthorized access and data breaches by prohibiting USB connection.

[Prohibit use as USB device]	<Use as USB Device> is set to <Off>. It is not possible to connect to a computer via USB.	<input checked="" type="checkbox"/> <Use as USB Device>(P. 1141)
[Prohibit use as USB storage device]	<Use USB Storage Device> is set to <Off>. It is not possible to use USB storage devices.	<input checked="" type="checkbox"/> <Use USB Storage Device>(P. 1142)

■ [Network]

[Communication Operational Policy]

Increase the security of communications by requiring the verification of signatures and certificates.

[Always verify signatures for SMS/WebDAV server functions]	In <SMB Server Settings>, the <Require SMB Signature for Connection> and <Use SMB Authentication> options are set to <On>, and <Use TLS> in <WebDAV Server Settings> is set to <On>. When the machine is used as an SMB server or WebDAV server, digital certificate signatures are verified during communication.	<input checked="" type="checkbox"/> <SMB Server Settings>(P. 1093) <input checked="" type="checkbox"/> <WebDAV Server Settings>(P. 1293)
[Always verify server certificate when using TLS]	The following settings are set to <On>, and a check mark is added to <CN>. <ul style="list-style-type: none"> • <Confirm TLS Certificate for WebDAV TX> • <Confirm TLS Certificate for FTPS TX> • <Confirm TLS Certificate for SMTP TX> • <Confirm TLS Certificate for POP RX> • <Confirm TLS Certificate for Network Access> • <Confirm TLS Certificate Using MEAP Application> • <Confirm TLS Certificate for LDAP Server Access> The following settings are set to <On>. <ul style="list-style-type: none"> • <SIP Settings> ▶ <TLS Settings> ▶ <Verify Server Certificate> • <SIP Settings> ▶ <TLS Settings> ▶ <Verify CN> 	<input checked="" type="checkbox"/> <Confirm TLS Certificate for WebDAV TX>(P. 1233) <input checked="" type="checkbox"/> <Confirm TLS Certificate for FTPS TX>(P. 1233) <input checked="" type="checkbox"/> <Confirm TLS Certificate for SMTP TX>(P. 1242) <input checked="" type="checkbox"/> <Confirm TLS Certificate for POP RX>(P. 1243) <input checked="" type="checkbox"/> <Confirm TLS Certificate for Network Access>(P. 1298) <input checked="" type="checkbox"/> <Confirm TLS Certificate Using MEAP Application>(P. 1354) <input checked="" type="checkbox"/> <Confirm TLS Certificate for LDAP Server Access>(P. 1313) <input checked="" type="checkbox"/> <SIP Settings>(P. 1108)

	<ul style="list-style-type: none"> [License/Other] ► [Visual Message Settings] ► [Confirm Certificate for TLS Communication] [License/Other] ► [Visual Message Settings] ► [Add CN to Verification Items] <p>During TLS communication, verification will be performed for digital certificates with common names.</p>	<p>► Configuring the Visual Message Function(P. 979) IP FAX Expansion Kit User's Guide</p>
[Prohibit cleartext authentication for server functions]	<p><Use FTP Printing> in <FTP Print Settings> is set to <Off>, <Allow TLS (SMTP RX)> in <E-Mail/I-Fax Settings> ► <Communication Settings> is set to <Always TLS>, <Dedicated Port Authentication Method> in <Network> is set to <Mode 2>, and <Use TLS> in <WebDAV Server Settings> is set to <On>. When using the machine as a server, plain text authentication and functions that use plain text authentication are not available.</p>	<p>► <FTP Print Settings>(P. 1097) ► <Communication Settings>(P. 1239) ► <Dedicated Port Authentication Method>(P. 1083) ► <WebDAV Server Settings>(P. 1293)</p>
[Prohibit use of SNMPv1]	<p>In <SNMP Settings>, <Use SNMPv1> is set to <Off>. It is not possible to use SNMPv1 when obtaining device information from the computer.</p>	<p>► <SNMP Settings>(P. 1081)</p>

NOTE

- This setting does not apply to communication with IEEE 802.1X networks, even if the check box is selected for [Always verify server certificate when using TLS].
- If [Prohibit cleartext authentication for server functions] is selected and your device management software or driver version is old, it may not be possible to connect to the machine. Ensure that you are using the latest versions.

[Port Usage Policy]

Prevent external breaches by closing unused ports.

[Restrict LPD port (port number: 515)]	<p><LPD Print Settings> is set to <Off>. It is not possible to perform LPD printing.</p>	<p>► <LPD Print Settings>(P. 1096)</p>
[Restrict RAW port (port number: 9100)]	<p><RAW Print Settings> is set to <Off>. It is not possible to perform RAW printing.</p>	<p>► <RAW Print Settings>(P. 1096)</p>
[Restrict FTP port (port number: 21)]	<p>In <FTP Print Settings>, <Use FTP Printing> is set to <Off>. It is not possible to perform FTP printing.</p>	<p>► <FTP Print Settings>(P. 1097)</p>
[Restrict WSD port (port number: 3702, 60000)]	<p>In <WSD Settings>, <Use WSD>, <Use WSD Browsing>, and <Use WSD Scan> are all set to <Off>. It is not possible to use WSD functions.</p>	<p>► <WSD Settings>(P. 1098)</p>
[Restrict BMLinkS port (port number: 1900)]	<p>There are no setting items that the security policy is applied to for the machine.</p>	<p>-</p>
[Restrict IPP port (port number: 631)]	<p>The <IPP Print Settings> and <Use Mopria> options are all set to <Off>. It is not possible to print using IPP or Mopria™.</p>	<p>► <IPP Print Settings>(P. 1099) ► <Use Mopria>(P. 1087)</p>
[Restrict SMB port (port number: 139, 445)]	<p>In <SMB Server Settings>, <Use SMB Server> is set to <Off>. It is not possible to use the machine as an SMB server.</p>	<p>► <SMB Server Settings>(P. 1093)</p>

[Restrict SMTP port (port number: 25)]	In <E-Mail/I-Fax Settings> ► <Communication Settings>, <SMTP RX> is set to <Off>. SMTP reception is not possible.	◻<Communication Settings>(P. 1239)
[Restrict dedicated port (port number: 9002, 9006, 9007, 9011-9015, 9017-9019, 9022, 9023, 9025, 20317, 47545-47547)]	<Dedicated Port Settings> is set to <Off>. It is not possible to use dedicated ports.	◻<Dedicated Port Settings>(P. 1083)
[Restrict Remote Operator's Software port (port number: 5900)]	<Remote Operation Settings> is set to <Off>. It is not possible to use remote operation functions.	◻<Remote Operation Settings>(P. 1350)
[Restrict SIP (IP Fax) port (port number: 5004, 5005, 5060, 5061, 49152)]	<Use Intranet> in <Intranet Settings> and <Use VoIP Gateway> in <VoIP Gateway Settings> are set to <Off>. It is not possible to use IP fax.	IP FAX Expansion Kit User's Guide
[Restrict mDNS port (port number: 5353)]	In <mDNS Settings>, the <Use IPv4 mDNS> and <Use IPv6 mDNS> options are set to <Off>, <Use Mopria> is set to <Off>. It is not possible to search the network or perform automatic settings using mDNS. It is also not possible to print using Mopria™.	◻<mDNS Settings>(P. 1116) ◻<Use Mopria>(P. 1087)
[Restrict SLP port (port number: 427)]	In <Multicast Discovery Settings>, <Response> is set to <Off>. It is not possible to search the network or perform automatic settings using SLP.	◻<Multicast Discovery Settings>(P. 1099)
[Restrict SNMP port (port number: 161)]	In <SNMP Settings>, the <Use SNMPv1> and <Use SNMPv3> options are set to <Off>, and <Display Scan for Mobile> is set to <Off>. It is not possible to obtain device information from the computer or configure settings using SNMP.	◻<SNMP Settings>(P. 1081) ◻<Display Scan for Mobile>(P. 1071)

■ [Authentication]

[Authentication Operational Policy]

Prevent unregistered users from performing unauthorized operations by implementing secure user authentication.

[Prohibit guest users to use device]	<p>The following settings are set to <On>.</p> <ul style="list-style-type: none"> ◻ <Advanced Space Settings> ► <Authentication Management> ◻ <User Management> ► <Authentication Management> ► <Use User Authentication> ◻ <Restrict Job from Remote Device without User Auth.> ◻ [Login for Unregistered Users:] ► [Allow unregistered users to log in as Guest User] <p><Login Screen Display Settings> is set to <Displ When Dev Operation Start>. It becomes [Standard Authentication Mode] if [Guest Authentication Mode] is set for [Authentication Mode:] in [Remote UI Authentication]. In addition, [Guest Authentication Mode] can no longer be selected for [Authentication Mode:] in [Remote UI Authentication]. Unregistered users cannot log in to the machine, and print jobs from computers are canceled.</p>	<p>◻<Authentication Management>(P. 1295)</p> <p>◻<Use User Authentication>(P. 1326)</p> <p>◻<Login Screen Display Settings>(P. 1326)</p> <p>◻<Restrict Job from Remote Device without User Auth.>(P. 1327)</p> <p>ACCESS MANAGEMENT SYSTEM Administrator Guide</p>
[Force setting of auto logout]	<Auto Reset Time> is enabled. The user is automatically logged out if no operations are performed for a specified period of time. Select [Time Until Logout:] on the Remote UI setting screen.	◻<Auto Reset Time>(P. 1074)

[Password Operational Policy]

Impose strict limits for password operations.

[Prohibit caching of password for external servers]	<Prohibit Caching of Authentication Password> is set to <On>, and <Save authentication information for login users> is set to <Off>. Users will always be required to enter a password when accessing an external server.	<p>🔴<Prohibit Caching of Authentication Password>(P. 1366)</p> <p>🔴<Registering Server Information>(P. 823)</p>
[Display warning when default password is in use]	<Display Warning When Default Password Is in Use> is set to <On>. A warning message will be displayed whenever the machine's factory default password is used.	🔴<Display Warning When Default Password Is in Use>(P. 1366)
[Prohibit use of default password for remote access]	<Allow Use of Default Password for Remote Access> is set to <Off>. It is not possible to use the factory default password when accessing the machine from a computer.	🔴<Allow Use of Default Password for Remote Access>(P. 1367)

[Password Settings Policy]

Prevent third parties from easily guessing passwords by setting a minimum level of complexity and a period of validity for user authentication passwords.

[Set minimum number of characters for password]	<Minimum Length Settings> is set to <On>. It is not possible to set a password with fewer characters than the number specified for [Minimum Number of Characters] on the Remote UI setting screen.	🔴<Minimum Length Settings>(P. 1367)
[Set password validity period]	<Validity Period Settings> is set to <On>. A period of validity is set for the password. Specify the period in [Validity Period:] on the Remote UI setting screen.	🔴<Validity Period Settings>(P. 1367)
[Prohibit use of 3 or more identical consecutive characters]	<Prohibit Use of 3 or More Identical Consecutive Char.> is set to <On>. It is not possible to set a password that includes the same character repeated three or more times consecutively.	🔴<Prohibit Use of 3 or More Identical Consecutive Char.>(P. 1368)
[Force use of at least 1 uppercase character]	<Use at Least 1 Uppercase Character> is set to <On>. Passwords are required to include at least one uppercase alphabetic character.	🔴<Use at Least 1 Uppercase Character>(P. 1368)
[Force use of at least 1 lowercase character]	<Use at Least 1 Lowercase Character> is set to <On>. Passwords are required to include at least one lowercase alphabetic character.	🔴<Use at Least 1 Lowercase Character>(P. 1369)
[Force use of at least 1 digit]	<Use at Least 1 Digit> is set to <On>. Passwords are required to include at least one numeric character.	🔴<Use at Least 1 Digit>(P. 1369)
[Force use of at least 1 symbol]	<Use at Least 1 Symbol> is set to <On>. Passwords are required to include at least one symbol.	🔴<Use at Least 1 Symbol>(P. 1370)

[Lockout Policy]

Block users from logging in for a specified period of time after a certain number of consecutive invalid login attempts.

[Enable lockout]	In <Lockout Settings>, <Enable Lockout> is set to <On>. Specify the values for [Lockout Threshold] and [Lockout Period] on the Remote UI setting screen.	🔴<Lockout Settings>(P. 1364)
------------------	--	------------------------------

■ [Key/Certificate]

Protect important data by preventing the use of weak encryption, or by saving encrypted user passwords and keys in a designated hardware component.

[Prohibit use of weak encryption]	<Prohibit Use of Weak Encryption> is set to <On>. It is not possible to use weak encryption. When the check box is selected, [Prohibit use of key/certificate with weak encryption] can be selected.	🔴<Prohibit Use of Weak Encryption>(P. 1371)
[Prohibit use of key/certificate with weak encryption]	In <Prohibit Use of Weak Encryption>, <Prohibit Use of Key/Certificate with Weak Encryption> is set to <On>. It is not possible to use a key or certificate with weak encryption.	🔴<Prohibit Use of Weak Encryption>(P. 1371)
[Use TPM to store password and key]	<TPM Settings> is set to <On>. Passwords and keys are encrypted and saved in a designated hardware component.	🔴<TPM Settings>(P. 1356)

 **IMPORTANT**

When TPM settings are enabled

- Make sure to change the "Administrator" password from the default value, to prevent a third party other than the administrator from being able to back up the TPM key. If a third party takes the TPM backup key, you will not be able to restore the TPM key.
- For the purpose of enhanced security, the TPM key can only be backed up once. If the TPM settings are enabled, make sure to back up the TPM key on to a USB memory device, and store it in a secure place to prevent loss or theft.
- The security functions provided by TPM do not guarantee complete protection of the data and hardware.

■ [Log]

You can periodically survey how the machine is used, by requiring logs to be recorded.

[Force recording of audit log]	<Save Operation Log> is set to <On>, <Display Job Log> is set to <On>, <Retrieve Job Log with Management Software> in <Display Job Log> is set to <Allow>, <Save Audit Log> is set to <On>, <Retrieve Network Authentication Log> is set to <On>, and <Use Login Name as User Name for Print Jobs> is set to <On>. Audit logs are always recorded.	🔴<Save Operation Log>(P. 1295) 🔴<Display Job Log>(P. 1340) 🔴<Save Audit Log>(P. 1340) 🔴<Retrieve Network Authentication Log>(P. 1341) 🔴<Use Login Name as User Name for Print Jobs>(P. 1133)
[Force SNTP settings]	In <SNTP Settings>, <Use SNTP> is set to <On>. Time synchronization via SNTP is required. Enter a value for [Server Name] on the Remote UI setting screen.	🔴<SNTP Settings>(P. 1097)

■ [Job]

[Printing Policy]

Prevent information leakage from occurring when printing.

[Prohibit immediate printing of received jobs]	The following settings are set to <On>. <ul style="list-style-type: none"> • <Fax Memory Lock> in the Fax/I-Fax Inbox • <I-Fax Memory Lock> in the Fax/I-Fax Inbox • <Set Fax/I-Fax Inbox> ▶ <Use Fax Memory Lock> • <Set Fax/I-Fax Inbox> ▶ <Use I-Fax Memory Lock> 	🔴<Handle Files with Forwarding Errors>(P. 1271) 🔴<Use Fax Memory Lock>(P. 1275) 🔴<Use I-Fax Memory Lock>(P. 1275) 🔴<Memory Lock End Time>(P. 1276)
--	--	---

Managing the Machine

	<ul style="list-style-type: none"> • <Forced Hold> <p>The following settings are set to <Off>.</p> <ul style="list-style-type: none"> • <Set/Register Mail Boxes> ▶ <Print When Storing from Printer Driver> • <Box Security Settings> ▶ <Display Print When Storing from Printer Driver> <p><Handle Files with Forwarding Errors> is set to <Store/Print>.</p> <p><Memory Lock End Time> is set to <Do Not Specify>.</p> <p>Only <Hold as Shared Job> can be set for the operation conditions of <Forced Hold>.</p> <p>In addition, settings for <Settings for All Mail Boxes> ▶ <Print When Storing from Printer Driver> cannot be changed.</p> <p>Printing does not occur immediately, even when printing operations are performed.</p>	<ul style="list-style-type: none"> ▶ <Set/Register Mail Boxes>(P. 1288) ▶ <Display Print When Storing from Printer Driver>(P. 1291) ▶ <Forced Hold>(P. 1301) ▶ <Print When Storing from Printer Driver>(P. 1290) ▶ <Saving Received Documents in the Machine (Memory Reception)> (P. 566)
--	---	--

[Sending/Receiving Policy]

Limit the sending operations for destinations, and limit how received data is processed.

[Allow sending only to registered addresses]	In <Limit New Destination>, the <Fax>, <E-Mail>, <I-Fax>, and <File> options are set to <On>. It is only possible to send to destinations that are registered in the Address Book.	▶ <Limit New Destination>(P. 1234)
[Force confirmation of fax number]	<Confirm Entered Fax Number> is set to <On>. Users are required to enter a fax number again for confirmation when sending a fax.	▶ <Confirm Entered Fax Number>(P. 1256)
[Prohibit auto forwarding]	<Use Forwarding Settings> is set to <Off>. It is not possible to automatically forward faxes.	▶ <Use Forwarding Settings>(P. 1271)

■ [Storage]

Prevent information leakage by deleting unnecessary data on the storage device.

[Force Complete Deletion of Data]	There are no setting items that the security policy is applied to for the machine. -
-----------------------------------	--

Managing Users

You can ensure a higher level of security and efficiency by utilizing a user authentication application (login service) to manage the users of the machine ([▶Login Service\(P. 803\)](#)). It is recommended that the administrator manage all users in accordance with your operating environment and required security measures. [▶User Management Functions\(P. 803\)](#)

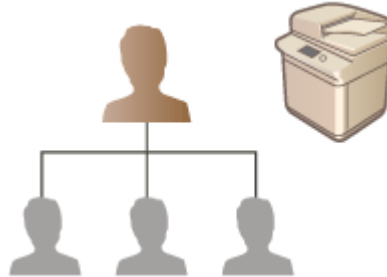

- ▶[Configuring the Personal Authentication Management Settings\(P. 806\)](#)
- ▶[Using Other Convenient Personal Authentication Management Functions\(P. 838\)](#)
- ▶[Deleting User Setting Information\(P. 850\)](#)

Login Service

A user authentication application (login service) called "User Authentication" is used as the primary method of managing the users of the machine. With the User Authentication login service, personal authentication can be performed for users based on the user name and password registered for each user. The user information is checked either on the database inside the machine or on an external authentication server. With the ability to precisely define which functions are available to each user, you can personalize machine operations and improve security by limiting access to certain functions. It may also be possible to use Department ID Management to manage groups, depending on the device used for authentication.

NOTE

- If you are not using the Personalization function, set <Enable Use of Personal Settings> ([▶<Enable Use of Personal Settings>\(P. 1346\)](#)) to <Off>.

User Management Functions

User management can provide the advantages described below. To protect important data and reduce costs, you can limit access to the machine and define the range of operations that are available to users.

Preventing Unauthorized Use by Third Parties

Because machine usage is limited to approved users, information leakage due to unauthorized use by third parties is prevented, even if the machine is located in a busy area that is open to outside parties.

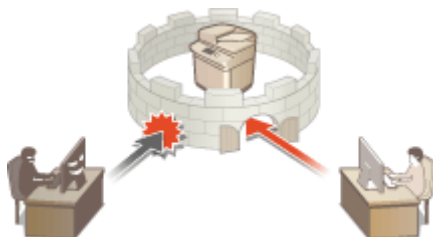

Setting the Privilege Levels

With personal authentication management, you can define the range of available operations by specifying the role (privilege level) for each user. For example, you can select the Administrator role to allow full access privileges, the NetworkAdmin role to allow configuration of network-related settings, or the DeviceAdmin role to allow the configuration of device information settings and the settings for keys and certificates that are required when using particular functions. By selecting and assigning various privilege levels to administrators, you can operate more effectively as a team in handling a wide range of machine management tasks.



Setting Usage Restrictions

Personal authentication management enables a user with Administrator privileges to manage the range of operations that are available to users. The ability to set function restrictions for each user provides you with more precise control in user management.



Managing Groups of Users

Users can be assigned to groups based on Department ID (Department ID Management), enabling you to check the total number of printed or scanned pages for each Department ID. You can also set specific limits for each Department ID, such as a maximum of 500 printed pages or a maximum of 200 copied pages. This function can help boost cost awareness and provide hints on how to improve your operations.



Optimizing the Settings for Each User

Various settings can be saved for each user and applied at login. Users can create Personal buttons, and they can specify a Personal folder on the network. It is also possible for the machine to remember passwords once they have been entered, enabling users to log in again without entering the password.

NOTE

Associating User Accounts with Keychains for Smooth Operations

- When authentication information different from the authentication information used when logging in is required, the authentication information has to be entered once, but does not need to be entered again once authentication is successful. This authentication information is called a keychain. Since keychains are

associated with user accounts, authentication information does not need to be entered again, even if the power of the machine is turned OFF.

Associating User Accounts with Department IDs to Restrict the Number of Copies and Prints

- User Authentication user accounts can be associated with Department IDs. By specifying copy and print restrictions for Department IDs in advance, you can apply restrictions on the number of copies or prints for each department that a user belongs to. For information on associating user accounts with Department IDs, see [▶ Registering User Information in the Local Device\(P. 809\)](#) . For information on specifying restrictions according to department, see [▶ Configuring the Department ID Management Settings\(P. 842\)](#) .

Configuring the Personal Authentication Management Settings

961F-0FA

The User Authentication login service performs personal authentication based on the information registered for each user, enabling you to limit the users who can access the machine. User information registration (authentication) can be performed on this machine and on an external server. You can configure the authentication system to use only this machine as the authentication device, or you can additionally specify an Active Directory or LDAP authentication server on the network as an authentication device to utilize the existing user information registered on the server ([▶ Authentication Device\(P. 806\)](#)). Administrators can also specify which functions are available to each individual user, such as "user A is prohibited from making copies" or "user B is allowed to use all machine functions." For the user login method, you can enter authentication information or, select a user ([▶ Login Method\(P. 806\)](#)). Before configuring the user authentication settings, decide the authentication device and login method. [▶ Configuring Personal Authentication Management with User Authentication\(P. 807\)](#)



- [▶ Registering User Information in the Local Device\(P. 809\)](#)
- [▶ Importing/Exporting User Data\(P. 813\)](#)
- [▶ Registering Server Information\(P. 823\)](#)
- [▶ Configuring the Authentication Functions\(P. 829\)](#)
- [▶ Using Personal Authentication to Manage Printing/Faxing/Remote Scanning via a Computer\(P. 837\)](#)

Authentication Device

The authentication devices described below can be used for personal authentication management. Each type of authentication device requires a different environment and settings. Confirm your system environment before configuring. [▶ System Specifications\(P. 1577\)](#)

Local Device (This Machine)

User information is managed on the database inside the machine. User information is registered and edited via the control panel or the Remote UI. When the local device is configured as a standalone authentication device, Department ID Management can also be performed at the same time. [▶ Registering User Information in the Local Device\(P. 809\)](#)

Active Directory/LDAP Server

In addition to the local device, you can specify an LDAP server or Windows Server with Active Directory installed as the authentication device. One advantage of using this type of device is that the users registered on the server can be added as general users without any changes. To provide administrator privileges to a user, the user must be assigned to a specific administrator group on the Active Directory or LDAP server. To specify the additional authentication device, you must register the information of the server used for authentication. [▶ Registering Server Information\(P. 823\)](#)

Login Method

The user login methods described below are available for personal authentication management. It is also possible to use these methods in combination with each other. For more information on login operations, see [▶ Logging into the Machine\(P. 355\)](#) .

Keyboard Authentication

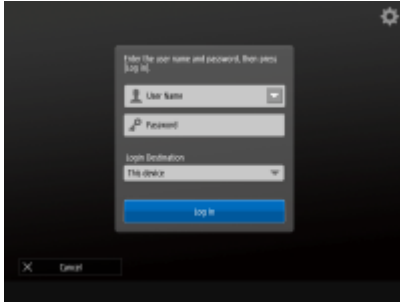

With this method, users log in by entering their user name and password using the keyboard displayed on the control panel. This method is available regardless of the authentication device that is used.

Mobile Authentication



Perform user authentication with a mobile device. You can log in to the machine using Canon PRINT Business. Optional products are required to use this function (**System Options(P. 1597)**). You must first enter user information with Canon PRINT Business. For more information on settings and operational procedures, see the Help of the application.

Configuring Personal Authentication Management with User Authentication

Configure the personal authentication management settings in the order described below.



Check the basic configuration.

- Is the machine properly connected to the computer? **Setting up the Network Environment(P. 263)**
- If you are using an authentication server, have the DNS settings been configured for the machine?
- If you are using an authentication server, have the date and time been properly set? **Setting the Date/Time(P. 261)**



Check the login service.

- Log in to the Remote UI with Administrator privileges, click [Settings/Registration] ▶ [User Management] ▶ [Authentication Management] ▶ [Authentication Service Information], and check that the login service is indicated as User Authentication.



Configure the authentication server settings.

- Register user information on the local device and specify the authentication server.
 - ▶ **Registering User Information in the Local Device(P. 809)**
 - ▶ **Registering Server Information(P. 823)**



4



Select the user authentication system.

▶ **Configuring the Authentication Functions**(P. 829)

▶ **Using Personal Authentication to Manage Printing/Faxing/Remote Scanning via a Computer**(P. 837)

IMPORTANT

- Make sure to log out after you finish using the Remote UI. If you close the Remote UI without logging out, it may take a long time to log in next time.
- If you want to limit authentication method to User Authentication (restrict use of System Manager ID for authentication) when the machine is accessed from a device management software or driver, make sure to set <Prohibit Authentication Using Department ID and PIN> to <On>. ▶ **<Prohibit Authentication Using Department ID and PIN>**(P. 1364)

Registering User Information in the Local Device

961F-0FC



To perform personal authentication management, you must first register user information in the database of the machine.

1 Start the Remote UI. ▶Starting the Remote UI(P. 902)

2 Click [Settings/Registration] on the portal page. ▶Remote UI Screen(P. 904)

3 Click [User Management] ▶ [Authentication Management].

NOTE

Disabling "Administrator"

- "Administrator" is registered as the default administrator name (user name). This user cannot be deleted but it can be disabled after adding a user with "Administrator" privileges. ▶Logging in as an Administrator(P. 259)

4 Click [Add User].

NOTE

To edit user information

- Click [Edit] for the user information that you want to edit, make the necessary changes, and click [Update].

To delete user information

- Select the check box for the user information that you want to delete, and click [Delete] ▶ [OK].

5 Enter the necessary information.

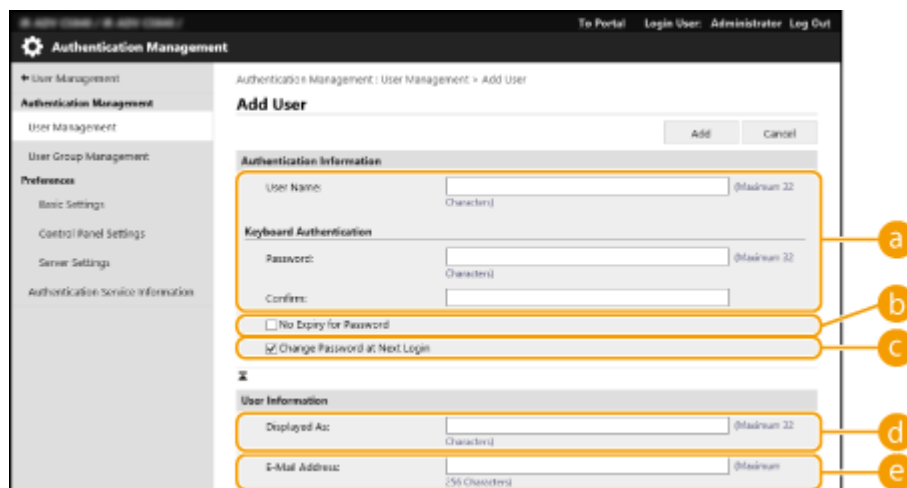

a [User Name:] / [Password:] / [Confirm:]

Enter the user name and password. For confirmation, enter the password again in [Confirm:]. Single-byte or double-byte characters can be used for the user name.

b [No Expiry for Password]

Select the check box to set the password of the user to register to have no expiration date. This setting can be specified when [Password Validity Period] is set to [Off] in [Password Settings Policy] in [Authentication] in [Security Policy Settings].

c [Change Password at Next Login]

Select this check box to force registered users to change their passwords the first time they log in. Once a user has changed their password, the check box is cleared automatically.

d [Displayed As:]

Enter the name of the user. The display name is displayed as the user name for forced hold printing and used as the sender name when sending e-mail.

e [E-Mail Address:]

Enter the e-mail address that the user is using on devices such as computers. When sending scanned documents, this address will be displayed along with the sender's name. This address is also used when sending documents by using <Send to Myself>.

When an I-fax is sent, the e-mail address registered here is displayed in the Sender line on the recipient device.

NOTE

- It is also possible for general users to change their own password and PIN.
- Selecting the [Allow e-mail address settings] check box enables general users to specify e-mail addresses.
 - ▶ **Configuring the User Login Methods and Authentication Devices(P. 829)**
- The following data can be imported as an icon image.
 - File extension: .jpg, .jpeg, or .png
- If the imported image is 54 pixels x 54 pixels or larger, the image is resized.
- The resize process is performed with the aspect ratio retained. The background color is applied to the blank areas if the imported image is not a square.

6 Specify other required settings.

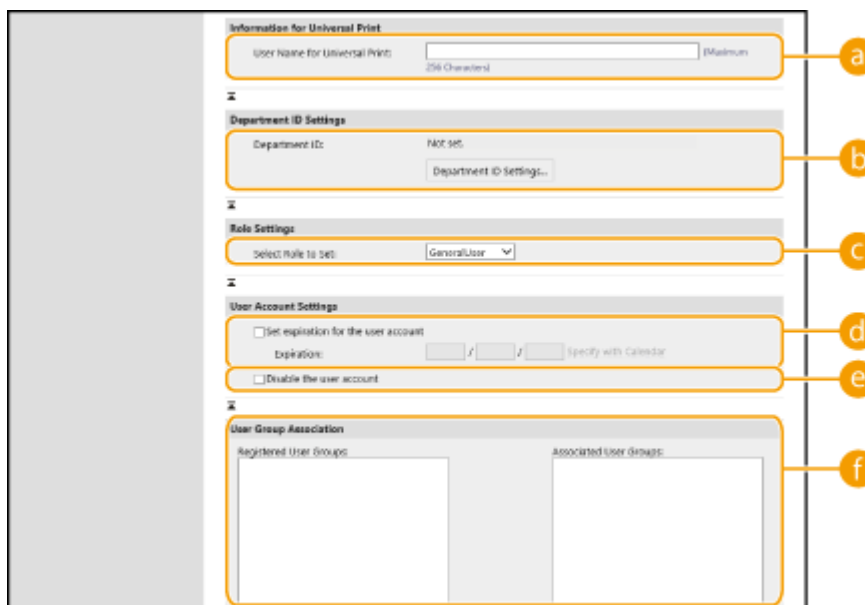

a [User Name for Universal Print:]

If [Settings/Registration] ► [Network Settings] ► [Settings for Universal Print] is enabled, you can enter the email address or phone number used in the Microsoft 365 account of the user with which Universal Print jobs are associated.

b [Department ID:]

When using Department ID Management, you must click [Department ID Settings...] and select the Department ID from the list to assign to the user. First, register the necessary Department IDs in [Register New Department...] on the list screen. If the Department ID that you specify here is later deleted, make sure to change this setting. ► **Configuring the Department ID Management Settings(P. 842)**

c [Select Role to Set:]

The user privileges (roles) listed below can be selected. Also specify the settings here when adding an administrator. The available setting items vary depending on the privileges (► **Settings/Registration(P. 1054)**). In addition, you can create your own roles. ► **Using ACCESS MANAGEMENT SYSTEM(P. 849)**

[Administrator]	Allows all operations as an administrator of the machine.
[GeneralUser]	Allows general user privileges.
[DeviceAdmin]	Allows operations that are available to general users, along with the ability to change settings related to basic functions such as copying, printing, sending, and receiving.
[NetworkAdmin]	Allows operations that are available to general users, along with the ability to change network-related settings.

d [Set expiration for the user account]

When setting a period of validity for the account, select the check box and enter a value for [Expiration].

e [Disable the user account]

Select the check box to temporarily disable the account.

f [User Group Association]

When you want to assign the user to a group, select a registered user group from the list and click [Add]. This setting is not displayed when using Department IDs as user groups. ► **Configuring the User Login Methods and Authentication Devices(P. 829)**

7 Click [Add].

NOTE

Configuring settings via the control panel

- You can also register user information by pressing  (Settings/Registration) ► <Management Settings> ► <User Management> ► <Authentication Management> ► <Register/Edit Authentication User>. ► **<Register/Edit Authentication User>(P. 1325)**

Creating user groups

- Address Lists in the Address Book can be shared between users who are registered in a user group. ► **Registering User Groups(P. 918)**

TIPS

Check for unregistered Department IDs

- If you click [Check Unregistered Department ID...] on the screen displayed in step 4, you can find out Department IDs that are not registered in the machine by checking Department IDs assigned to the users against Department IDs registered in the machine.

Batch settings for Department IDs

- If you click [Batch Settings for Department ID...] on the screen displayed in step 4, you can create new Department IDs and apply settings for all users.
- If the user name is comprised of numbers and is seven digits or fewer, the same number is assigned to the same user as the Department ID. If the password of the same user is registered as a number that is seven digits or fewer, it is also set as the PIN for that Department ID.
- If the user name and password do not meet the above conditions, a Department ID is automatically assigned starting from 0000001, and 0 (none) is set for the PIN.

Registering the Department ID as the User Name

- If you click [Add User Using Department ID...] on the screen in step 4, a new user with the same name as the Department ID is registered. When keyboard authentication is used, authentication can be performed using numeric key entry only.

LINKS

▶ **Registering Server Information(P. 823)**

▶ **Configuring the Authentication Functions(P. 829)**

▶ **Using Personal Authentication to Manage Printing/Faxing/Remote Scanning via a Computer(P. 837)**

Importing/Exporting User Data

961F-0FE

You can save user information stored in the machine to a computer (export), as well as load user information from other machines into the machine you are using (import). This is useful when you want to register multiple users at once.

- ▶ **Exporting User Data(P. 813)**
- ▶ **Automatically Importing User Data(P. 813)**
- ▶ **Manually Importing User Data(P. 815)**

NOTE

- For information on editing a CSV file for importing, see ▶ **Adding and Editing User Information in a CSV File(P. 818)** .
- If duplicates of data exist in a CSV file for importing, the version of the data that was read first will be prioritized and registered.
- It is recommended that you export the registered/edited user data to make a backup copy.

Exporting User Data

- 1 Start the Remote UI.** ▶ **Starting the Remote UI(P. 902)**
- 2 Click [Settings/Registration] on the portal page.** ▶ **Remote UI Screen(P. 904)**
- 3 Click [User Management] ▶ [Authentication Management].**
- 4 Click [Export].**
- 5 Select the file format, and click [Start Export].**
 - User information created in the file format that can be used with User Authentication is exported. The file extension is "csv."
- 6 Follow the instructions on the screen to specify the location to store the file.**
 - ▣▶ The csv file is stored.

Automatically Importing User Data

You can automatically update user data by periodically importing import files stored in a specified location.

- 1 Start the Remote UI. ▶ Starting the Remote UI(P. 902)
- 2 Click [Settings/Registration] on the portal page. ▶ Remote UI Screen(P. 904)
- 3 Click [User Management] ▶ [Authentication Management].
- 4 Click [Import] ▶ [Auto Import Settings...].
- 5 Select the check box for [Use auto import] and specify the required settings.

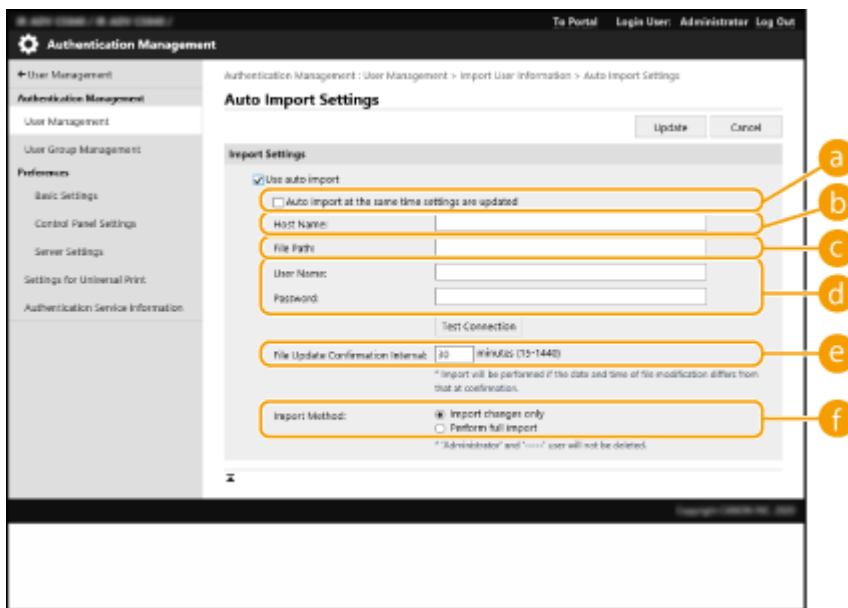

a [Auto import at the same time settings are updated]

Click the [Update] button to start importing.

b [Host Name:]

Enter the host name of the server to access, along with the path that require authentication.

Example:

- \\Host Name
- \\IP Address\Shared Folder Name

c [File Path:]

Enter the path of the file for importing.

d [User Name:]/[Password:]

Enter the user name and password required to log in to the computer in which the file for importing is stored.

e [File Update Confirmation Interval:]

You can specify the interval in minutes for checking for files to import.

NOTE

- If the operation cannot be performed at the specified time because the machine is turned OFF or is completely in the Sleep mode, the operation is performed and information is reflected when the machine recovers.

f [Import Method:]

Select whether to import only updated or added user data, or all user data.

NOTE

- If you select [Perform full import] and a user with the same user name is already registered, the user information is overwritten.
- When importing information of a user who accesses the Advanced Space with SMB, specify the appropriate value in the "password" column. If you export the data from the machine and import it to the other machine without performing the above operation, authentication may fail. (The value is "*****" when exported.)
- When performing a complete import, any users not listed in the imported files are deleted from the machine. However, "-----" and "Administrator", which are registered by default, will remain even if they are not listed in the imported files.
- "User Authentication Format" is the only file format that is supported. Also, the "uid" column is required.
- Note that if you are using a server that does not support SMB 3.0/3.1 encrypted communication, user data travels unencrypted across communication paths while it is being obtained.

6 Click [Connection Test], confirm that you can connect, and then click [Update].

Manually Importing User Data

You can manually specify data for importing and update user information.

- 1 Start the Remote UI. ▶Starting the Remote UI(P. 902)**
- 2 Click [Settings/Registration] on the portal page. ▶Remote UI Screen(P. 904)**
- 3 Click [User Management] ▶ [Authentication Management].**
- 4 Click [Import] ▶ [Manual Import Settings...]**
- 5 Specify the required settings.**

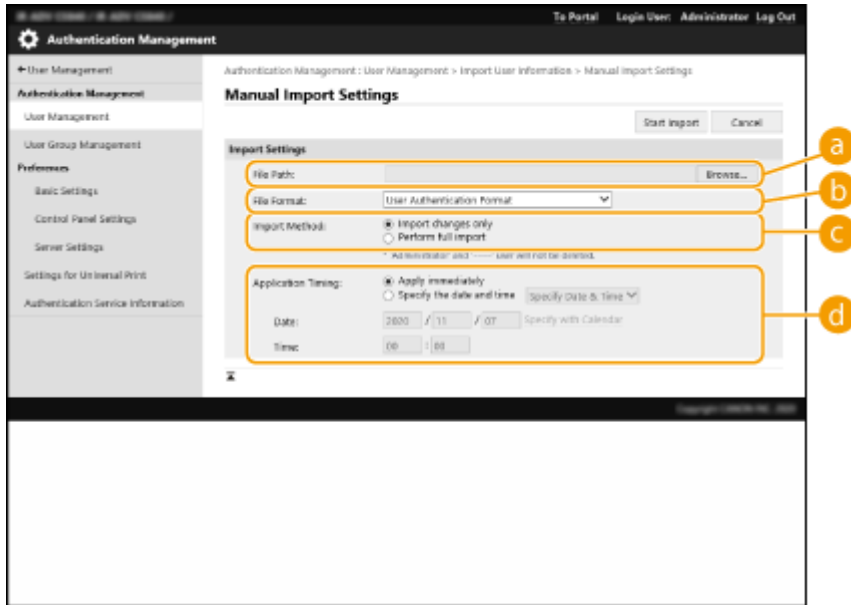

a [File Path:]

Specify the path of the file for importing.

b [File Format:]

Select the file format for importing.

- <Simple Device Login Format>:
Imports user information exported from a Canon machine using the Local Device Authentication of SSO-H. The file extension is ".ldif."
- <User Access Control for Advanced Space Format>:
Imports user information exported from a Canon machine with Advanced Space user access control. The file extension is ".csv."
- <User Authentication Format>:
Imports user information created in the file format that can be used with User Authentication. The file extension is ".csv."

c [Import Method:]

Select whether to import only updated or added user data, or all user data.

NOTE

- If you select [Perform full import] and a user with the same user name is already registered, the user information is overwritten.
- When importing information of a user who accesses the Advanced Space with SMB, specify the appropriate value in the "password" column. If you export the data from the machine and import it to the other machine without performing the above operation, authentication may fail. (The value is "*****" when exported.)
- When performing a complete import, any users not listed in the imported files are deleted from the machine. However, "-----" and "Administrator", which are registered by default, will remain even if they are not listed in the imported files.

d [Application Timing:]

Select [Apply immediately] or [Specify the date and time]. If you select [Specify the date and time], enter the desired date and time or the time only.

NOTE

- If the user information cannot be reflected at the specified time because the machine is turned OFF or is completely in the Sleep mode, the information is reflected when the machine recovers.

6 Click [Start Import]

NOTE

- If the Department ID (dept_id) and PIN (dept_pin) are written in the imported CSV file, [Check Unregistered Department ID] will be displayed after importing is complete. Perform Department ID registration.

Adding and Editing User Information in a CSV File

961F-OFF

This section describes the content of each column in a CSV file used for importing or exporting. Refer to this section when editing CSV files. However, if "No" is written in the "Change Required" section for a particular column, do not change the content of that column.

Column Name	Change Required	Valid Characters	Invalid Characters	Compatibility With Remote UI Screen	Notes
uid	Yes	1 to 32 characters	Control characters, single-byte spaces, and the following characters: \\/:*? <>[] ; , = + @ "	a	<ul style="list-style-type: none"> Must be input when importing. "@" may be available depending on a setting. <Allow Use of @ in User Name>(P. 1328)
password	Yes	0 to 32 characters within the ISO885915 character set	Control characters	b	<ul style="list-style-type: none"> Output as "*****" (* x 8) when exporting. When updating the password, "*****" will be deleted and overwritten by the new password. However, when importing changes, even if you leave the field unspecified (blank), it will not be overwritten as empty (blank), but will instead retain the existing value. If this item is omitted when importing changes, the existing user will carry over the original password.
next_password_change_required	Yes	0 or 1	Any character besides "1" (enable) or "0" (disable)	c	When this item is omitted, the default value is 0 (disable).
cn	Yes	0 to 32 characters	Control characters	d	N/A
cn;lang-ja;phonetic	Yes	0 to 32 characters	Control characters	See "Notes."	Displayed as "phonetic" if the display language is set to "Japanese."
cardIdList	Yes	Card ID: a number up to eight alphanumeric characters You can specify up to 1,000 items.	Non-single-byte alphanumeric characters	See "Notes."	<ul style="list-style-type: none"> Exported only if the optional Copy Card Reader is attached. Multiple items of card information are connected with a semi-colon (;). This item appears between "e-mail address" and "icon image" when the optional Copy Card Reader is attached.

Managing the Machine

Column Name	Change Required	Valid Characters	Invalid Characters	Compatibility With Remote UI Screen	Notes
mail	Yes	Combination of 0 to 256 alphanumeric characters and symbols	Control characters	e	N/A
avatorImgPath	No	-	-	f	Cannot be changed. Automatically assigned when specifying icon images.
dept_id	Yes	A number up to seven digits	Non-single-byte numeric characters	g	N/A
dept_pin	Yes	A number up to seven digits	Non-single-byte numeric characters	h	N/A
roleName	Yes	0 to 32 characters	Control characters, single-byte spaces, and the following characters: \\ : * ? < > [] ; , = + @ " &	i	If this item is omitted, or if a name is specified that is not registered in role management, it will be changed to the initial role setting.
accountExpires	Yes	See "Notes."	See "Notes."	j	YYYYMMDD format. "235959" is automatically added as the time after importing.
accountDisabled	Yes	1 or 0	Any character besides "1" (disable) or "0" (enable)	k	N/A
group	Yes	0 to 64 characters. You can specify up to 10 items.	Control characters, single-byte spaces, and special symbols.	l	The "Group name" registered in the user group management is written here. If the user belongs to multiple groups, group names are connected with a " ".
createDate	Yes	See "Notes."	See "Notes."	- (N/A)	<ul style="list-style-type: none"> Output in the "YYYYMMDDhhmmssmmm" format when exporting. (The "T" is added in order to prevent corruption of the text.) When importing, input the information in one of the following formats. <ul style="list-style-type: none"> YYYYMMDDhhmmssmmm YYYYMMDDhhmmssmmm YYYYMMDD YYYYMMDD Used for sorting in the Picture Login registration order.

Managing the Machine

Column Name	Change Required	Valid Characters	Invalid Characters	Compatibility With Remote UI Screen	Notes
					<ul style="list-style-type: none"> If you omit this item, the date and time of importing is used for the date and time of registration for new users. For existing users, the original registration date and time are carried over.
lastLoginDate	Yes	See "Notes."	See "Notes."	- (N/A)	<ul style="list-style-type: none"> The date and time that the user last logged in are stored. Output in the "YYYYMMDDhhmmssmmm" format when exporting. (The "T" is added in order to prevent corruption of the text.) When importing, input the information in one of the following formats. <ul style="list-style-type: none"> YYYYMMDDhhmmssmmm YYYYMMDDhhmmssmmm YYYYMMDD YYYYMMDD Used for determining whether a user has logged in and whether to perform automatic user deletion. If you omit this item, the date and time that the user last logged in are blank for new users. For existing users, date and time that the user last logged in are carried over.
dc	No	0 to 32 characters	Control characters	- (N/A)	<p>Cannot be changed. It will be automatically assigned for the following users.</p> <ul style="list-style-type: none"> Users registered following server authentication Users registered via <Register Automatically When Job Is Received> in Picture Login
uuid	No	-	-	-	Cannot be changed. Automatically assigned during user registration.
sdl_digest	No	-	-	-	Cannot be changed. Automatically generated when registering/ changing password.
uac_advbox_digest1	No	-	-	-	Cannot be changed. Automatically generated when registering/ changing password.
uac_advbox_digest2	No	-	-	-	Cannot be changed. Automatically generated when registering/ changing password.

Column Name	Change Required	Valid Characters	Invalid Characters	Compatibility With Remote UI Screen	Notes
pin_digest	No	-	-	-	Cannot be changed. Automatically generated when registering/ changing PIN.
server_user_flg	No	-	-	-	Cannot be changed. This is an identification flag for the user registered after completing server authentication.
server_user_gp_key	No	-	-	-	Cannot be changed. This is the group to which the user who is registered after completing server authentication belongs.
server_user_gp_value	No	-	-	-	Cannot be changed. This is the group to which the user who is registered after completing server authentication belongs.
CharSet	-	-	-	-	For UTF8, "CharSet:UTF8" will be written in the column line.

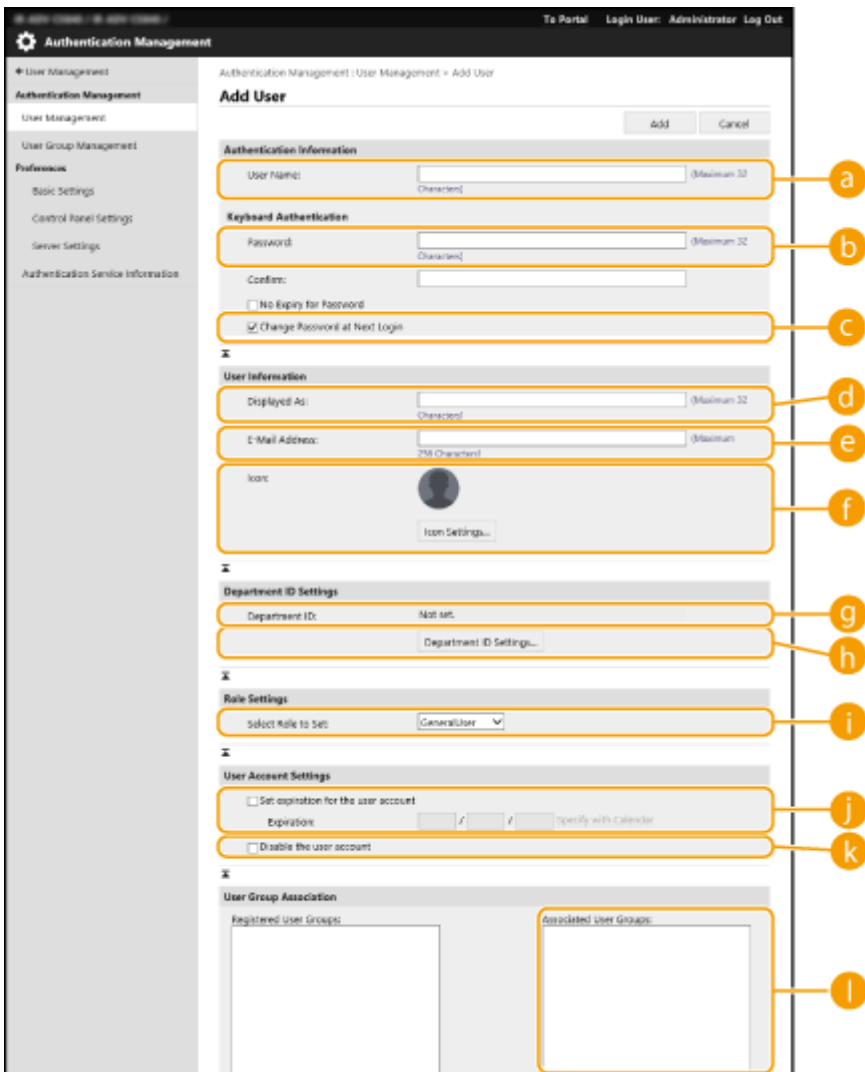

NOTE

- The line at the beginning of the file is the column line.
- Items names may not appear in sequence.
- The encodings supported by CSV files are UTF-8, SJIS, BIG5, GB2312, and Korean.
- Text strings in exported CSV files are surrounded by "[" and "]" if any of the following conditions apply. When editing a CSV file and adding new text strings that meet the following conditions, surround any such text strings with "[" and "]".
 - Numbers starting with "0"
 - Numbers greater than 12 digits
 - Text strings surrounded by "[" and "]"

Registering Server Information

961F-0FH



To specify an Active Directory or LDAP server as an additional authentication device, you must register the information of the server used for authentication. Conduct a connection test as necessary.

- 1 Start the Remote UI. ▶ Starting the Remote UI(P. 902)
- 2 Click [Settings/Registration] on the portal page. ▶ Remote UI Screen(P. 904)
- 3 Click [User Management] ▶ [Authentication Management].
- 4 Click [Server Settings] ▶ [Edit...].
- 5 Set the authentication server and domain information.

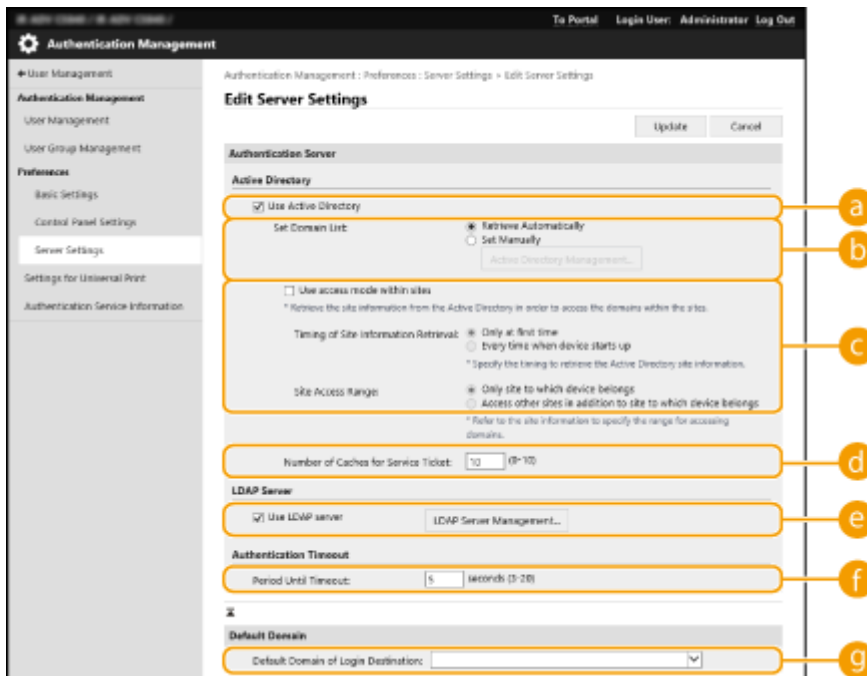

a [Use Active Directory]

Select the check box when using Active Directory.

b [Set Domain List:]

Select whether the Active Directory information of the login destination is retrieved automatically or entered manually. To enter it manually, select [Set Manually] and add the domain of the login destination in [Active Directory Management...].

c [Use access mode within sites]

Select the check box if there are multiple Active Directory servers and you want to assign access priority to the Active Directory located in the same site as the machine. Change the settings for [Timing of Site Information Retrieval:] and [Site Access Range:] as necessary.

! IMPORTANT

- Even when [Only site to which device belongs] in [Site Access Range:] is set, the machine may access sites outside the site it belongs to when performing domain controller access during the startup process. However, access to domain controllers in the same site as the machine is prioritized. As an exception, if domain controllers in the same site cannot be accessed but domain controllers outside the site can be accessed, priority is given to accessing domain controllers outside the site.

d [Number of Caches for Service Ticket:]

Specify the number of service tickets that the machine can hold. A service ticket is an Active Directory function that acts as a record of a previous login, which reduces the amount of time it takes for the same user to log in next time.

e [Use LDAP server]

Select the check box when using an LDAP server.

f [Period Before Timeout]

Specify the time limit for attempting to connect to the authentication server and the time limit for waiting for a response. When [Save authentication information for login users] is enabled, if you cannot log in within the time limit specified here, login is attempted using the authentication information saved in the cache.

g [Default Domain of Login Destination:]

Specify the domain that has connection priority.

Manually specifying the Active Directory domain

- 1 Select the check box for [Use Active Directory] and select [Set Manually] for [Set Domain List:].
- 2 Click [Active Directory Management...] ► [OK].
- 3 Click [Add Domain...].
- 4 Enter the necessary information.

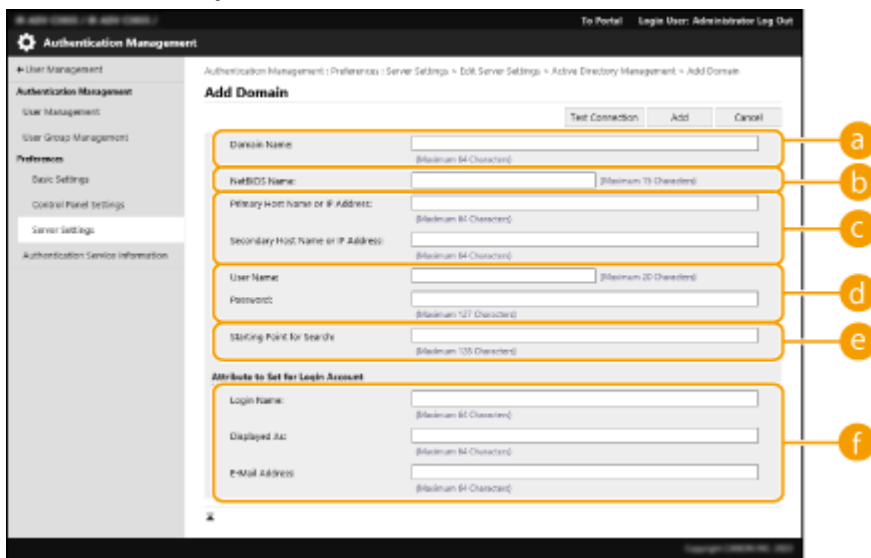

a [Domain Name:]

Enter the domain name of the Active Directory that is the login destination (**Example:** company.domain.com).

b [NetBIOS Name]

Enter the NetBIOS domain name (**Example:** company).

c [Primary Host Name or IP Address:] / [Secondary Host Name or IP Address:]

Enter the host name of the Active Directory server or the IPv4 address. When using a secondary server, specify the name in [Secondary Host Name or IP Address:].

- **Example:**
Using a host name: ad-server1
Using an IPv4 address: 192.168.18.138

d [User Name:] / [Password:]

Enter the user name and password to use for accessing and searching the Active Directory server.

e [Starting Point for Search:]

Specify the location (level) to access and search for user information during Active Directory Server authentication.

f [Login Name:] / [Displayed As] / [E-Mail Address]

Specify the data fields (attribute names) for the login name, display name, and e-mail address of each user account on the Active Directory server (**Example:** sAMAccountName, cn, mail).

5 Click [Connection Test] to confirm that connection is possible, and then click [Add].

NOTE

To edit server information

- Click [Edit] for the server information that you want to edit, make the necessary changes, and click [Update].

■ Registering LDAP server information

- 1** Select the check box for [Use LDAP server] and click [LDAP Server Management...] ► [OK].
- 2** Click [Add Server...].
- 3** Enter the LDAP server information.

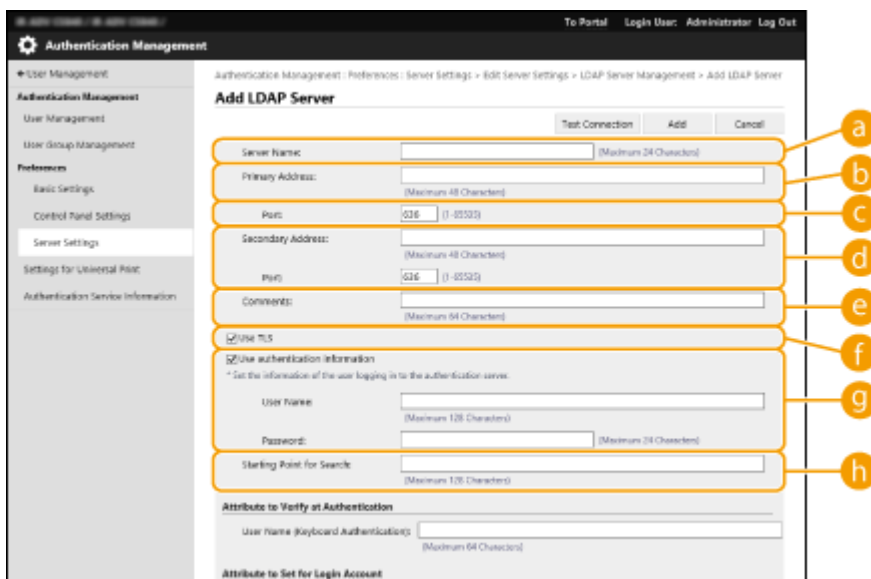

a [Server Name]

Enter the name for the LDAP server. The name "localhost" cannot be used. The server name may not include spaces.

b [Primary Address]

Enter the IP address or host name of the LDAP server (**Example:** ldap.example.com). The loopback address (127.0.0.1) cannot be used.

c [Port:]

Enter the port number used for communicating with the LDAP server. Use the same setting that is configured on the server. If you do not enter a number, it is automatically set to "636" when the check box is selected for [Use TLS], or it is set to "389" when the check box is cleared.

d [Secondary Address:] / [Port:]

When using a secondary server in your environment, enter the IP address and the port number.

e [Comments]

Enter a description or note as necessary.

f [Use TLS]

Select the check box when using TLS encryption for communications with the LDAP server.

g [Use authentication information]

Clear the check box to allow anonymous access to the LDAP server, only if the LDAP server is set to allow anonymous access. When using the user name and password for authentication, select the check box and enter values for [User Name:] and [Password:].

h [Starting Point for Search:]

Specify the location (level) to search for user information when LDAP server authentication is performed.

4 Specify how to set the attribute names and domain name.

a [User Name (Keyboard Authentication):]

Specify the LDAP data field (attribute name) for the user name on the LDAP server (**Example:** uid).

b [Login Name:] / [Display Name] / [E-Mail Address]

Specify the LDAP data fields (attribute names) for the login name, display name, and e-mail address of each user account on the LDAP server (**Example:** uid, cn, mail).

c [Specify the domain name] / [Specify the attribute name for domain name acquisition]

Select how to set the domain name of the login destination. To specify the domain name directly, select [Specify the domain name] and enter the domain name. To specify an LDAP data field (attribute name) from which to acquire the domain name on the LDAP server, select [Specify the attribute name for domain name acquisition] and enter the attribute name (**Example:** dc).

5 Click [Connection Test] to confirm that connection is possible, and then click [Add].

NOTE

To edit server information

- Click [Edit] for the server information that you want to edit, make the necessary changes, and click [Update].

6 Enter the user information and set the privileges.

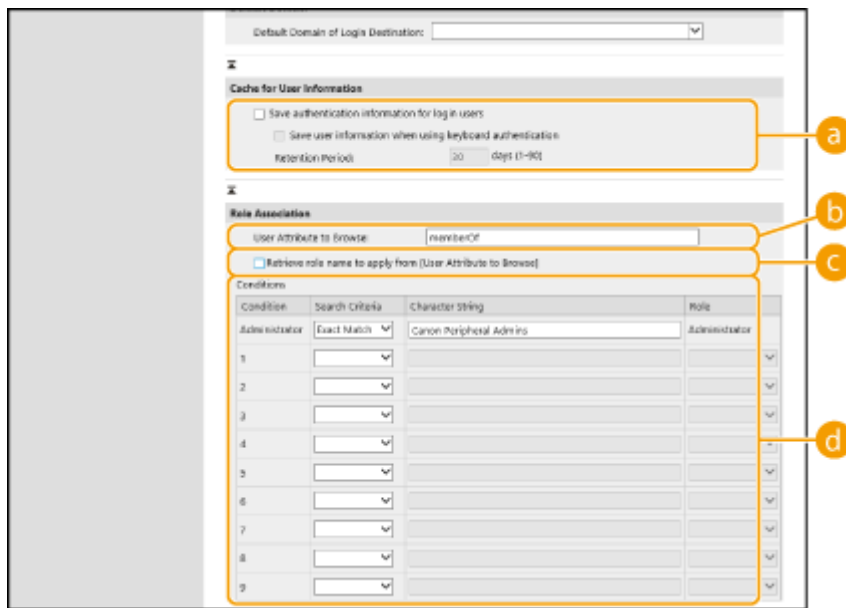

a [Save authentication information for login users]

Select the check box to save the authentication information of users who log in via the control panel. Select the [Save user information when using keyboard authentication] check box to save the information of users who log in using keyboard authentication to the cache. After the settings are configured, the saved authentication information can be used for login, even if the machine is unable to connect to the server. Change the [Retention Period:] setting as necessary.

b [User Attribute to Browse:]

Enter the data field (attribute name) on the referenced server that is used to determine user privileges (roles). Normally, you can use the preset value of "memberOf", which indicates the group that the user belongs to.

c [Retrieve role name to apply from [User Attribute to Browse]]

Select the check box to use the character string registered in the data field on the server specified in [User Attribute to Browse:] for the role name. Before configuring, check the role names that can be selected on the machine, and register them on the server.

d [Conditions]

You can set the conditions that determine user privileges. The conditions below are applied in the order that they are listed.

[Search Criteria]	Select the search criteria for [Character String].
-------------------	--

[Character String]	Enter the character string that is registered to the attribute specified in [User Attribute to Browse:]. To set the privileges based on the group that user belongs to, enter the group name.
[Role]	Select the privileges that apply to users who match the criteria.

NOTE

The [Conditions] settings when using Active Directory servers

- "Canon Peripheral Admins" is set in advance as the Administrator user group. Assign different privileges to the other groups created on the server.

7 Click [Update].

8 Restart the machine. ▶ [Restarting the Machine\(P. 911\)](#)

NOTE

DNS Settings

The following settings are required if the port number used for Kerberos on the Active Directory side is changed.

- Information for the Kerberos service of Active Directory must be registered as an SRV record as follows:
 - Service: "_kerberos"
 - Protocol: "_udp"
 - Port number: The port number used by the Kerberos service of the Active Directory domain (zone)
- Host offering this service: Host name of the domain controller that is actually providing the Kerberos service of the Active Directory domain (zone)

LINKS

- ▶ [Registering User Information in the Local Device\(P. 809\)](#)
- ▶ [Configuring the Authentication Functions\(P. 829\)](#)
- ▶ [Using Personal Authentication to Manage Printing/Faxing/Remote Scanning via a Computer\(P. 837\)](#)

Configuring the Authentication Functions

961F-0FJ

You can configure the user login methods, authentication devices, and other authentication functions based on your system environment and needs. You can also specify how the login screen is displayed.

- ▶ **Configuring the User Login Methods and Authentication Devices(P. 829)**
- ▶ **Specifying When to Display the Login Screen(P. 835)**

Configuring the User Login Methods and Authentication Devices

Specify the user login methods (▶ **Login Method(P. 806)**) and authentication devices (▶ **Authentication Device(P. 806)**). Note that the authentication devices need to be set up before configuring the settings below.

- ▶ **Registering User Information in the Local Device(P. 809)**
- ▶ **Registering Server Information(P. 823)**

- 1 Start the Remote UI. ▶ Starting the Remote UI(P. 902)**
- 2 Click [Settings/Registration] on the portal page. ▶ Remote UI Screen(P. 904)**
- 3 Click [User Management] ▶ [Authentication Management].**
- 4 Click [Basic Settings] ▶ [Edit...].**
- 5 Select the check box for [Use the user authentication function] and specify the required settings.**
 - Select the login methods that you want to use, and specify detailed settings such as authentication device settings.

■ **Configuring mobile authentication**

Specify the following settings when using mobile authentication.

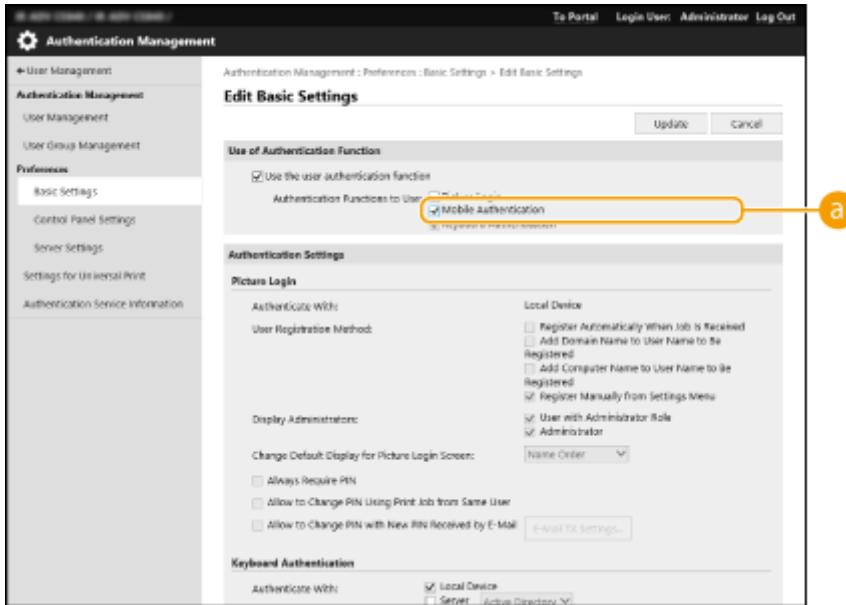

a [Authentication Functions to Use:]

Select the [Mobile Authentication] check box.

NOTE

- If you select the check box for mobile authentication, the check box for keyboard authentication is selected automatically. Also make sure to specify the settings for keyboard authentication.

■ Using keyboard authentication

Configure the settings below when using keyboard authentication.

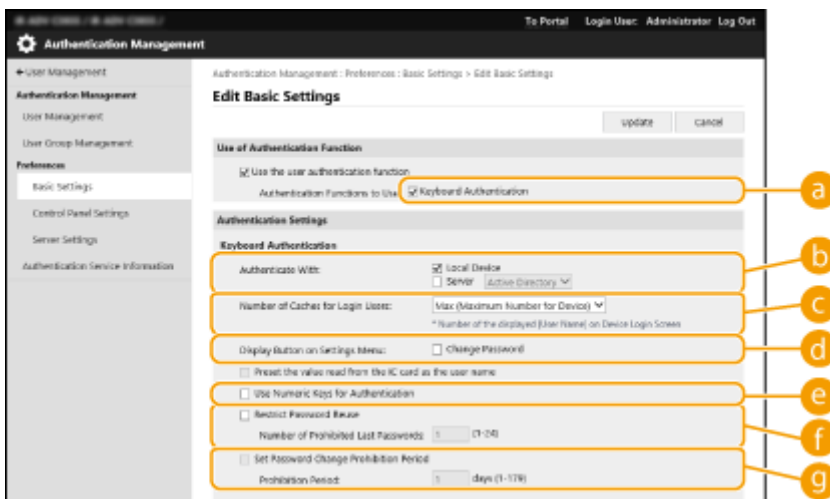

a [Authentication Functions to Use:]

Select the check box for [Keyboard Authentication].

b [Authenticate With:]

Select the user authentication device.

- Select the check box for [Local Device] if you are using the database inside this machine to manage user information.
- When using an external authentication server, select [Server] and specify the type of server.

c [Number of Caches for Login Users:]

The names of users who previously logged in can be displayed in a drop-down list on the login screen on the machine. Select [0] to hide the login history, and select [1] to display only the name of the user who logged in most recently.

d [Display Button on Settings Menu:]

Select the check box to add the <Change Password> button to the menu that is displayed when pressing  on the top right corner of the login screen.

e [Use Numeric Keys for Authentication]

If this function is enabled and the user name and password are comprised of numbers only, authentication can be performed with numeric key entry only.

f [Restrict Password Reuse]

Select this check box to prohibit the re-use of a password that has already been used. The password history count should also be configured to match this setting.

g [Set Password Change Prohibition Period]

Select this check box to specify the period for which password changes are prohibited. You can also specify the expiry period.

■ Configuring detailed settings for authentication functions

You can configure detailed settings for the personal authentication functions.

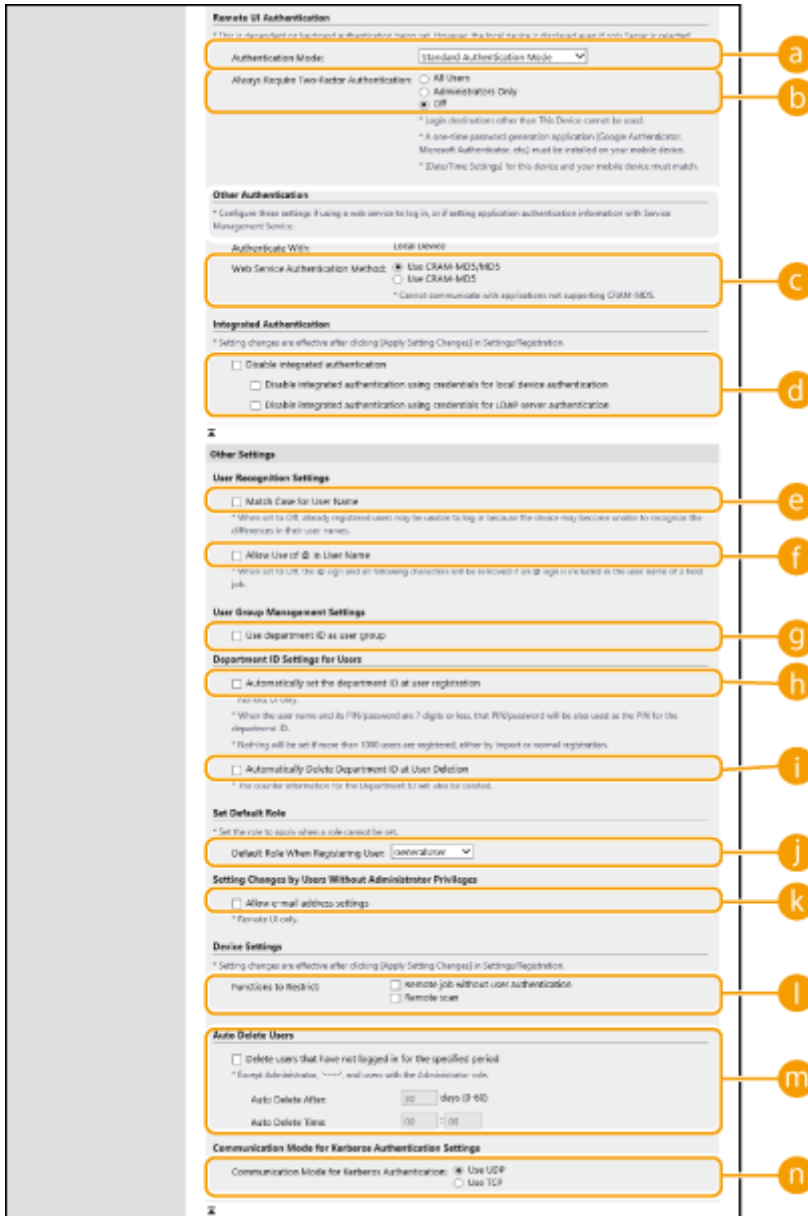

a [Authentication Mode:]

Select the authentication mode to use for Remote UI login. When [Guest Authentication Mode] is selected, unregistered users can also log in by clicking [Log In (Guest)]. Select [Administrator Authentication Mode] to only allow users with Administrator privileges to log in.

b [Always Require Two-Factor Authentication]

You can require users logging in to the Remote UI to use two-factor authentication. Select [All users] or [Administrators Only] to set the users to which this applies.

c [Web Service Authentication Method:]

Select the local device authentication method to use for communications with Web service applications.

d [Disable integrated authentication]

Integrated authentication is a function that enables the authentication information used when logging in to be used when logging in at other times. Select the check box to disable the integrated authentication function.

- To disable the integrated authentication function only for logged-in users who are registered in the local device, select the check box for [Disable integrated authentication using credentials for local device authentication].
- To disable the integrated authentication function only for logged-in users who are registered in the LDAP server, select the check box for [Disable integrated authentication using credentials for LDAP server authentication].

NOTE

- When integrated authentication is disabled, a separate user name and password must be registered in order to access the folders and boxes listed below.
 - Personal folder
 - LDAP server
 - Shared folder/FTP server/WebDAV server
 - Advanced Space
- Integrated authentication is valid while the session is valid.

e [Match Case for User Name]

If this function is set, you can set whether user names are case-sensitive.

NOTE

- It is recommended that this is set together with <Function Settings> ► <Print> ► <Match Case for User Name>.

f [Allow Use of @ in User Name]

Select whether to allow "@" to be used in user names.

g [Use department ID as user group]

Select the check box to use Department IDs as the user groups (► **Registering User Information in the Local Device(P. 809)**) to which users are registered.

h [Automatically set the department ID at user registration]

Select the check box to automatically allocate a Department ID when you register/edit a user via the Remote UI. A new Department ID will not be allocated if one has already been allocated. This setting can only be specified from the Remote UI.

NOTE

- If the user name is comprised of numbers and is seven digits or fewer, the same number is assigned to the same user as the Department ID. If the password of the same user is registered as a number that is seven digits or fewer, it is also set as the PIN for that Department ID.
- If the user name and password do not meet the above conditions, a Department ID is automatically assigned starting from 0000001, and 0 (none) is set for the PIN.
- In the following cases, the Department ID is not registered automatically.
 - If a user is registered from the control panel of the machine
 - If 1,000 Department IDs are already registered
 - If 1,001 or more users are already registered

i [Automatically Delete Department ID at User Deletion]

If this check box is selected, when a user is deleted, the department ID assigned to the user is automatically deleted. Counter information assigned to the corresponding department ID is also deleted. If multiple users are registered to the department ID, it is not automatically deleted.

j [Default Role When Registering User:]

Select the role to apply to users in situations such as when no privileges are set.

k [Allow e-mail address settings]

Select the check box to enable users without Administrator privileges to specify their own e-mail addresses in their user accounts.

l [Functions to Restrict:]

Select the check boxes for functions that cannot be used when personal authentication management is enabled.

m [Delete users that have not logged in for the specified period]

Select the check box to delete users registered in the local device who have not logged in to the machine for a specified period of time. Make sure to also specify the number of days before automatic deletion and the time it is executed.

NOTE

- If you set [Auto Delete After:] to [0], all accounts other than the administrator are deleted at the time set in [Auto Delete Time:].
- If the accounts cannot be deleted at the specified time because the machine is turned OFF or is completely in sleep mode, the accounts are deleted the next time that the machine starts.
- If a user has never logged in before, the date and time that the user was registered is displayed as the time that the user last logged in.

n [Communication Mode for Kerberos Authentication]

Select the communication method used for Kerberos authentication.

6 Click [Update].**7 Restart the machine. ▶ [Restarting the Machine\(P. 911\)](#)****NOTE**

- The authentication method selected for [Web Service Authentication Method:] is also used for personal authentication during the device information distribution. ▶ [Performing User Authentication when Distributing Device Information\(P. 1009\)](#)

Specifying When to Display the Login Screen

You can specify when to display the login screen by selecting either "when you start using the machine" or "after a function button is pressed." If "after a function button is pressed" is selected, you can specify the functions that require user login. Functions that are not specified are available to unregistered users.

- 1 Start the Remote UI. ▶Starting the Remote UI(P. 902)**
- 2 Click [Settings/Registration] on the portal page. ▶Remote UI Screen(P. 904)**
- 3 Click [User Management] ▶ [Authentication Management].**
- 4 Click [Control Panel Settings] ▶ [Edit...].**
- 5 Configure the settings as necessary.**

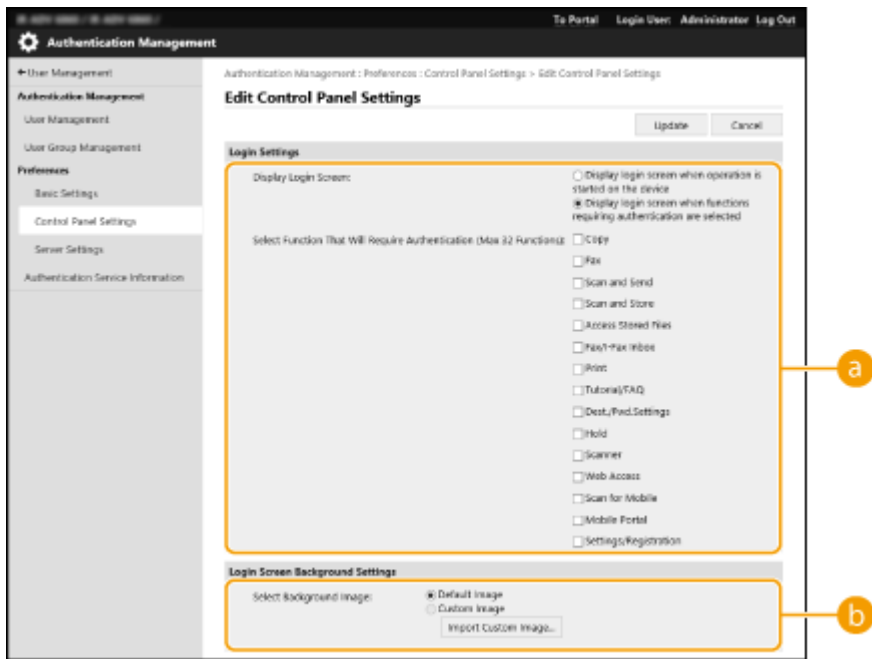

a [Login Settings]

In [Display Login Screen:], select when the login screen is displayed. If you selected [Display login screen when functions requiring authentication are selected], also select the functions to display the login screen for.

NOTE

- If you change this setting, <Restrict Access to Other User Jobs> may be set to <On>. The relationship between the settings is indicated below. ▶<Restrict Access to Other User Jobs>(P. 1339)
- When the [Display login screen when operation is started on the device] check box is selected: <Copy/Print>, <Send>, and <Store> in <Restrict Access to Other User Jobs> are set to <On>
- When the [Display login screen when functions requiring authentication are selected] check box is selected and the [Copy], [Access Stored Files], or [Print] check box is selected in [Select Function That Will Require Authentication]: <Copy/Print> in <Restrict Access to Other User Jobs> is set to <On>

- When the [Display login screen when functions requiring authentication are selected] check box is selected and the [Fax] or [Scan and Send] check box is selected in [Select Function That Will Require Authentication]:
<Send> in <Restrict Access to Other User Jobs> is set to <On>
- When the [Display login screen when functions requiring authentication are selected] check box is selected and the [Scan and Store] check box is selected in [Select Function That Will Require Authentication]:
<Store> in <Restrict Access to Other User Jobs> is set to <On>
- If you want to set <Restrict Access to Other User Jobs> to <Off>, set it to <Off> after this setting is complete.

b [Login Screen Background Settings]

You can specify a background image for the login screen.

6 Click [Update].

LINKS

- ▶ **Registering User Information in the Local Device(P. 809)**
- ▶ **Registering Server Information(P. 823)**
- ▶ **Using Personal Authentication to Manage Printing/Faxing/Remote Scanning via a Computer(P. 837)**

Using Personal Authentication to Manage Printing/ Faxing/Remote Scanning via a Computer

961F-0FK

You can apply personal authentication management to printing, faxing, and remote scanning ([▶Using Your Computer to Scan \(Remote Scan\) \(Windows\)\(P. 697\)](#)) via a computer. This can provide greater security, as the machine does not accept these operations unless the user is identified.

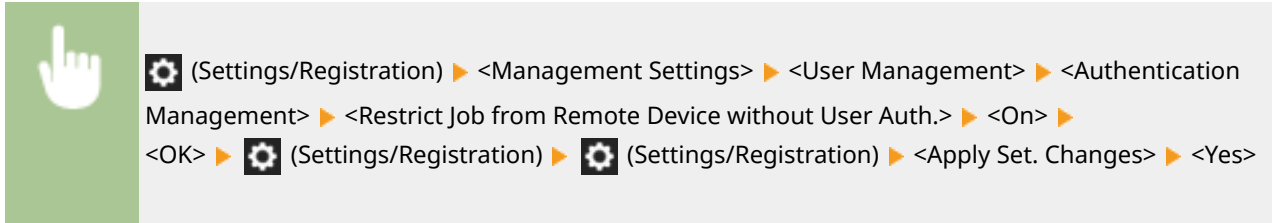

LINKS

- ▶ [Registering User Information in the Local Device\(P. 809\)](#)
- ▶ [Registering Server Information\(P. 823\)](#)
- ▶ [Configuring the Authentication Functions\(P. 829\)](#)

Using Other Convenient Personal Authentication Management Functions

Personal authentication management provides a variety of advantages in addition to user authentication. This section describes some of the other convenient functions that use personal authentication to expand the capabilities of multifunctional printers, such as managing user groups or creating Personal folders for individual users.

Department ID Management

Users registered in the machine can be organized into groups such as the departments that they belong to, and managed based on their Department ID. This function lets you check the total number of pages used for each Department ID, or set maximum limits on the number of pages that each group can use for copying or printing, which can help reduce costs. [▶Setting the Department ID Management\(P. 839\)](#)



Personal Folder

Users who log in with personal authentication management can create a Personal folder for individual use. A Personal folder can be specified as the send destination for scanned documents, and it can be created in a shared folder or on a file server. Registering a Personal folder makes it easy for users to send documents to themselves, which can effectively prevent information leakage due to sending to wrong destinations. [▶Configuring Personal Folders\(P. 846\)](#)

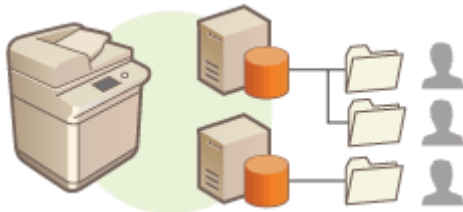

ACCESS MANAGEMENT SYSTEM

An environment that uses ACCESS MANAGEMENT SYSTEM can provide more precise control in user management, by allowing you to create new privilege levels and define which functions are available to each privilege level. [▶Using ACCESS MANAGEMENT SYSTEM\(P. 849\)](#)

Setting the Department ID Management

961F-0FR

Users can be organized into groups such as the departments that they belong to, and managed based on their Department ID. First, create all of the Department IDs that are to be managed, and assign users to each one ([▶ Registering User Information in the Local Device\(P. 809\)](#)). After assigning users to Department IDs, enable Department ID Management. To perform the same type of management for printing or scanning documents from a computer, configure the additional required settings. Administrator privileges are required in order to configure these settings.



- ▶ [Changing the System Manager ID and PIN\(P. 840\)](#)
- ▶ [Configuring the Department ID Management Settings\(P. 842\)](#)
- ▶ [Using Department IDs to Manage Printing or Remote Scanning via Computer\(P. 845\)](#)

Changing the System Manager ID and PIN

961F-0FS

When Department ID Management is enabled, Department IDs must be set for users before they can log in. The System Manager ID and System Manager PIN are both set to "7654321" by default, but it is recommended to change them for security reasons. Follow the procedure below to change them.

! IMPORTANT

- Make sure that you do not forget the System Manager PIN. If you forget the System Manager PIN, contact your dealer or service representative.

NOTE

- This setting is not a default User Authentication administrator setting. To specify this setting for a user with administrator privileges in User Authentication, set [Select Role to Set:] to "Administrator". [▶ Registering User Information in the Local Device\(P. 809\)](#)

- 1 Press  (Settings/Registration).
- 2 Press <Management Settings> ▶ <User Management> ▶ <System Manager Information Settings>.
- 3 Make the necessary changes to the System Manager settings, and press <OK>.

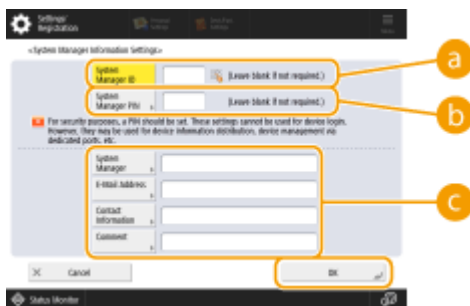

a <System Manager ID>

Enter a number of 7 digits or less for the new System Manager ID.

b <System Manager PIN>

Enter a number of 7 digits or less for the new System Manager PIN, and press <Confirm>. For confirmation, enter the PIN again and press <OK>.

c <System Manager> / <E-Mail Address> / <Contact Information> / <Comment>

Enter information about the administrator as necessary.

NOTE

- You cannot register a System Manager ID or PIN consisting only of 0s, such as "00" or "0000000".
- Even if you enter fewer than seven digits, zeros are added to the start of the number, and a seven digit number is set.

- When the optional Copy Card Reader is attached, the System Manager ID and System Manager PIN are reset to "7654321". [▶Optional Equipment\(P. 173\)](#)
- You can also make entering seven digits a requirement for the System Manager ID and System Manager PIN. For more information, contact your dealer or service representative.

LINKS

- ▶[Configuring the Department ID Management Settings\(P. 842\)](#)
- ▶[Registering User Information in the Local Device\(P. 809\)](#)

Configuring the Department ID Management Settings

961F-0FU

You can organize and manage users in groups based on Department ID. Follow the procedure below to configure Department ID Management and enable the machine to count the number of pages used for printing and scanning.

! IMPORTANT

- Make sure that Department IDs have been set for the users registered in the machine. ▶ **Registering User Information in the Local Device(P. 809)**
- Department ID Management is only valid for users who are registered to the local device.
- If you login as a user with Administrator privileges, a System Manager ID and PIN are automatically assigned, and managed as Department ID.
- If Department ID Management is activated through the Copy Card Reader, the Department IDs assigned to the cards are used. Therefore, you cannot register Department IDs.

NOTE

- For information on the number of Department IDs that you can register, see ▶ **Management Functions(P. 1586)** .

1 Press  (Settings/Registration).

2 Press <Management Settings> ▶ <User Management> ▶ <Department ID Management>.

3 Press <On>.

⇒ Department ID Management is enabled.

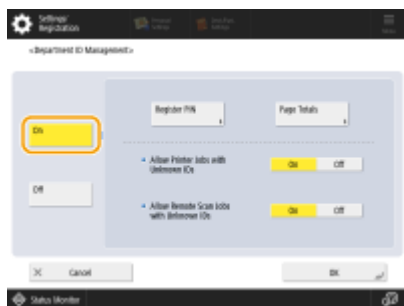

- To disable Department ID Management, press <Off>.

■ Registering Department IDs and PINs

1 Press <Register PIN>.

2 Press <Register>.

NOTE

To edit Department ID settings

- Select the Department ID that you want to edit, and press <Edit> to display the Edit screen.

To delete Department ID settings

- Select the Department ID that you want to delete, and press <Delete> ► <Yes>.

3 Enter the Department ID and PIN, and press <OK>.



a <Department ID>

Enter a number of 7 digits or less for the Department ID.

b <PIN>

Enter a number of 7 digits or less for the PIN, and press <Confirm>. For confirmation, enter the PIN again and press <OK>. If you do not want to set a PIN, leave this item blank.

NOTE

- You cannot register a Department ID or PIN consisting only of 0s, such as "00" or "0000000".
- Even if you enter fewer than seven digits, zeros are added to the start of the number, and a seven digit number is set.
- You can press <Turn Limit On/Off and Set Page Limit> to set the total number of pages that the department is allowed to use for copying, scanning, and printing.
- You can also make entering seven digits a requirement for Department IDs and PINs. For more information, contact your dealer or service representative.
- The machine stops printing if any one of the color or black-and-white page limits is reached while printing a document that contains both color and black-and-white areas.
- The machine stops copying if any one of the total color or black-and-white print or copy limits is reached while copying a document that contains both color and black-and-white areas.

4 Press <OK>.

4 Press <OK>.

NOTE

To check the page counts

- If you want to check the total number of pages used by each Department ID for copies, prints, and scans, press <Page Totals> on the screen displayed in step 3. The page counts do not include blank pages or sample prints used for checking items such as gradation adjustment or secure watermarks.
- For models with a fax function, you can also check the total number of fax pages sent.

Logging In Using a Department ID and PIN

- By registering a user with the same name as a department ID, login operations can be performed using a registered department ID and PIN. ► **Registering User Information in the Local Device(P. 809)**

The login screen can either be displayed when starting an operation or after a function is selected. ▶
Specifying When to Display the Login Screen(P. 835)

Changing the Login Service

- The machine uses "User Authentication" (personal authentication management) as the login service. However, you can change the login service to "DepartmentID Authentication" using SMS. ▶**Changing Login Services(P. 1569)**

LINKS

▶**Using Department IDs to Manage Printing or Remote Scanning via Computer(P. 845)**

Using Department IDs to Manage Printing or Remote Scanning via Computer

961F-0FW

You can use Department ID Management to manage printing and remote scanning operations performed via a computer (▶ **Using Your Computer to Scan (Remote Scan) (Windows)(P. 697)**). Use this function when you would like to improve security or monitor the number of pages that are printed.

- 1 Press  (Settings/Registration).
- 2 Press <Management Settings> ▶ <User Management> ▶ <Department ID Management>.
- 3 Select <Off> for the functions that you want to manage, then press <OK>.

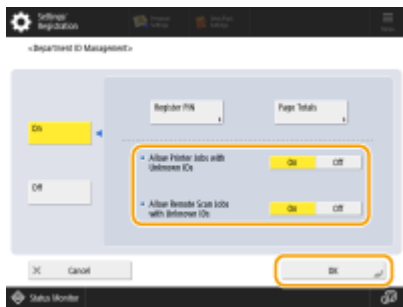

If <Off> is selected, a Department ID must be entered when executing a corresponding job.

Configuring Personal Folders

961F-0FX

A Personal folder is an individual folder that can be used by the user logged in with personal authentication management. Shared folders and file servers can be specified and used as a Personal folder. An administrator with Administrator privileges selects the method for specifying Personal folders. The login users specify Personal folders based on the setting specified by the administrator.

NOTE

- A Personal folder is a folder shared by the following screens.
 - <Scan and Send>
 - <Network> in <Scan and Store>
 - <Network> in <Access Stored Files>

Creating Folders in Any Location Specified by Users

Users create a Personal folder in any location they desire. This enables each user to send documents to a folder in a familiar location.

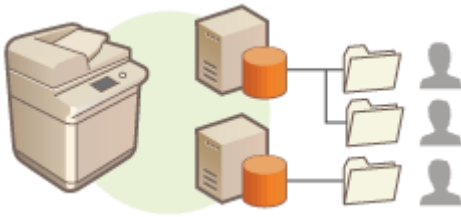

Creating Folders in a Home Folder Specified by the Administrator

A folder for each user name is created inside a parent folder (home folder) specified by the administrator. Personal folders are easier to manage because they are all kept together in one location. A Windows (SMB) shared folder or WebDAV server can be specified.

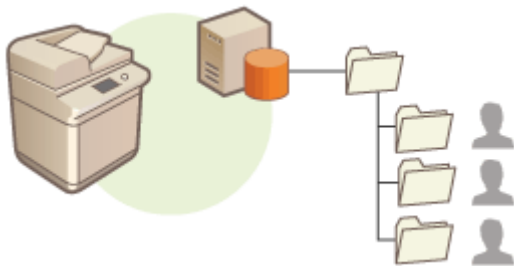

NOTE

- If you set up the home folder on the WebDAV server, folders for all users must be prepared beforehand.

Creating Folders in a Location Specified by the Server

Personal folders are specified based on the folder information registered in an authentication server, such as the homeDirectory attribute of Active Directory in Windows. Only a Windows (SMB) shared folder can be specified.

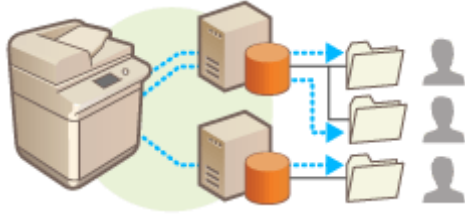

Setting How to Specify the Location of Personal Folders

1 Press (Settings/Registration).

2 Press <Function Settings> ▶ <Send> ▶ <Common Settings> ▶ <Personal Folder Specification Method>.

- This setting is the same as the following setting. The settings are in different locations, but they perform the same function.

(Settings/Registration) ▶ <Function Settings> ▶ <Store/Access Files> ▶ <Network Settings> ▶ <Personal Folder Specification Method>

3 Select how to specify the location of Personal folders.

■ Creating folders in any location specified by users

Press <Register for Each User> ▶ <OK>. Each user can specify the location of the Personal folder.

■ Creating folders in a home folder specified by the administrator

- 1 Press <Home Folder> ▶ <Set>.
- 2 Specify the home folder and press <OK>.



a <Protocol>

Select the protocol to use when accessing Personal folders.

b <Host Name>

Enter the host name or IP address of the computer where you want to create the home folder.

c <Folder Path>

Enter the folder path for the home folder. For example, enter "users\public\share" for a home folder created inside a subfolder named "share" in the "Public" folder on the C: drive (path: "C:\users\public\share").

NOTE

- You may not be able to specify the path if there are too many folder levels.

3 Select the authentication information to use, and press <OK>.

- To use a separate user name and password for the Personal folder, press <Use Authentication Info. of Each User> to add a check mark. Remove the check mark to use the same user name and password entered at login. If a check mark is added to this item, a user name and password must be registered for each user.
- A folder is created inside a home folder, with the following names.
 - If a check mark is added to <Use Authentication Info. of Each User>: the user name specified by a user
 - If no check mark is added to <Use Authentication Info. of Each User>: the user name used for logging in

■ Creating folders in a location specified by the server

1 Press <Use Login Server>.

2 Select the authentication information to use, and press <OK>.

- To use a separate user name and password for the Personal folder, press <Use Authentication Info. of Each User> to add a check mark. Remove the check mark to use the same user name and password entered at login. If a check mark is added to this item, a user name and password must be registered for each user.

! IMPORTANT



- The authentication information required for accessing a personal folder (user name and password) cannot be retrieved from Active Directory. If <Use Authentication Info. of Each User> is selected, the user name and password for logging in to the machine with keyboard authentication are registered as authentication information for accessing a personal folder.

NOTE

- It is necessary to use the login service that supports this function. For more information, consult your dealer or service representative.
- If you are using User Authentication, configure a folder in "homeDir" which is a user attribute in the Active Directory, using the "\\host name\folder path" format.

NOTE

Registering a Personal folder and authentication information for each user



- If <Personal Folder Specification Method> is set to <Register for Each User>, register one of the following as the Personal folder for each user. The registered settings are the same and the same Personal folder is registered, no matter where the setting is configured.
 - <Scan and Send> ▶  ▶ <Register/Edit Information for Each User> ▶ <Personal Folder>
 - <Scan and Store> ▶ <Network> ▶  ▶ <Register/Edit Information for Each User> ▶ <Personal Folder>
 - <Access Stored Files> ▶ <Network> ▶  ▶ <Register/Edit Information for Each User> ▶ <Personal Folder>

Using ACCESS MANAGEMENT SYSTEM

961F-0FY

In an environment that uses ACCESS MANAGEMENT SYSTEM, it is possible to define which functions are available to each privilege level (role), as well as create new roles. This provides more precise control in user management by enabling you to specify which functions are available to each individual user. For example, you can prohibit user A from copying, while allowing user B to use all functions. Follow the procedure below to enable ACCESS MANAGEMENT SYSTEM functions.



 (Settings/Registration) ▶ <Management Settings> ▶ <License/Other> ▶ <Use ACCESS MANAGEMENT SYSTEM> ▶ <On> ▶ <OK> ▶  (Settings/Registration) ▶  (Settings/Registration) ▶ <Apply Set. Changes> ▶ <Yes>

NOTE

- If this setting is set to <On>, <Use User Authentication> in Settings/Registration is also set to <On>. To set <Use User Authentication> to <Off>, first set this setting to <Off>.
- If you set this function to <On>, the following settings in Settings/Registration are disabled.
 - Setting a PIN for Address Book
 - Restricting New Destinations
- Similar restrictions can be set for roles using the ACCESS MANAGEMENT SYSTEM. For details, see ACCESS MANAGEMENT SYSTEM Administrator Guide.
- Even if you change this setting from <Off> to <On>, the following settings in Settings/Registration do not automatically return to their previous values. Change the settings manually.
 - Setting a PIN for Address Book
 - Restricting New Destinations
- For more information on system requirements and how to create and edit roles, see ACCESS MANAGEMENT SYSTEM Administrator Guide.

Deleting User Setting Information

961F-0H0

You can delete unnecessary user setting information. User setting information is a type of table that includes data about where and what settings have been configured for users. Setting information is registered automatically, and some setting information must be manually deleted because it remains even after a user has been deleted. To delete user setting information, log in to the Remote UI with Administrator privileges. Note, however, that it may not be possible to delete setting information for the user who is using a MEAP application.

NOTE

- You can also set to automatically delete user setting information when the maximum amount of information that can be registered has been reached. [▶<Action When Maximum Number of Users Exceeded>\(P. 1346\)](#)
- For information on the maximum amount of user setting information that can be registered, see [▶System Specifications\(P. 1577\)](#) .
- The User Setting Information that the User Setting Information Management can link with User Authentication is as follows:
 - Information of Personal buttons/Shared buttons ([▶Registering Frequently Used Settings and Destinations as Personal Buttons/Shared Buttons on the <Home> Screen\(P. 372\)](#))
 - Keychain information ([▶Managing Users\(P. 803\)](#))

1 Start the Remote UI. [▶Starting the Remote UI\(P. 902\)](#)

2 Click [User Setting Information Management Service] on the portal page. [▶Remote UI Screen\(P. 904\)](#)

3 Delete the user setting information.

■Deleting the setting information for all users

Click [Delete All User Setting Information] ▶ [Yes].

■Deleting the setting information for individual users

1 Click [Select User and Delete Setting Information].

2 Select the check box for the user with the setting information that you want to delete, and click [Delete] ▶ [Yes].

■Deleting the shared setting information of all users

Click [Delete Shared Setting Information of All Users] ▶ [Yes].

■Deleting the setting information for all user groups

Click [Delete All User Group Setting Information] ▶ [Yes].

■Deleting the setting information for individual user groups

1 Click [Select User Group and Delete Setting Information].

- 2 Select the check box for the user group with the setting information that you want to delete, and click [Delete] ► [Yes].

NOTE

- The changed user setting information is enabled when the machine is restarted. It may take some time until the old user setting information is deleted. Wait for a while and restart the machine.

LINKS

- **Configuring the Personal Authentication Management Settings(P. 806)**

Configuring the Network Security Settings

961F-0H1

Authorized users may incur unanticipated losses from attacks by malicious third parties, such as sniffing, spoofing, and tampering of data as it flows over a network. To protect your important and valuable information from these attacks, the machine supports the following features to enhance security and secrecy.

Firewall Settings

Unauthorized access by third parties, as well as network attacks and breaches, can be blocked by only allowing communication with devices that have a specific IP address. [▶Restricting Communication by Using Firewalls\(P. 854\)](#)



Proxy Settings

You can provide greater security by using a proxy server for connections outside the network, such as when browsing websites. [▶Setting a Proxy\(P. 862\)](#)



TLS Encrypted Communication

TLS is a protocol for encryption for data sent over a network and is often used for communication via a Web browser or an e-mail application. TLS enables secure network communication when accessing the machine in a variety of situations, such as when using the Remote UI or distributing device information. [▶Configuring the Key and Certificate for TLS\(P. 864\)](#)



IPSec Communication

While TLS only encrypts data used on a specific application, such as a Web browser or an e-mail application, IPSec encrypts the whole (or payloads of) IP packets. This enables IPSec to offer a more versatile security system than TLS. [▶Configuring the IPSec Settings\(P. 869\)](#)

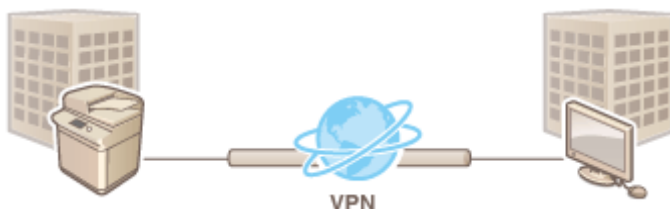

IEEE 802.1X Authentication

If a device tries to connect and start communicating on an 802.1X network, the device must go through user authentication in order to prove that the connection is made by an authorized user. Authentication information is sent to and checked by a RADIUS server, which permits or rejects communication to the network depending on the authentication result. If authentication fails, a LAN switch (or an access point) blocks access from the outside of the network. The machine can connect to an 802.1X network as a client device. **►Configuring the IEEE 802.1X Authentication Settings(P. 874)**

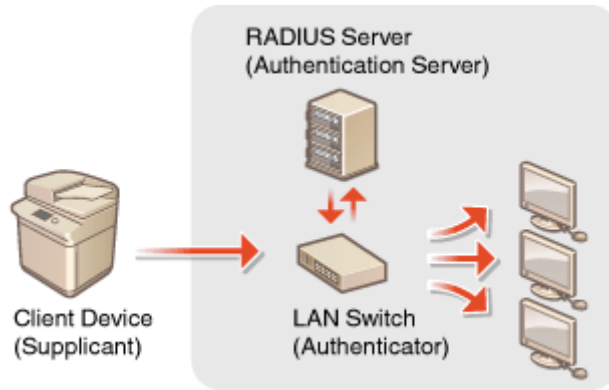

Restricting Communication by Using Firewalls

961F-0H2

By configuring packet filtering to only allow communication with devices that have a specific IP address or MAC address, you can reduce the risk of unauthorized access by outside third parties. Administrator or NetworkAdmin privileges are required in order to configure these settings.



- ▶ **Specifying IP Addresses in Firewall Settings(P. 855)**
- ▶ **Specifying MAC Addresses in Firewall Settings(P. 858)**
- ▶ **Configuring the Firewall of the Sub Line(P. 859)**

Specifying IP Addresses in Firewall Settings

961F-0H3

You can set whether to allow or reject communication with a device that has a specific IP address. After configuring the IP addresses in the firewall settings, you can check the results in the log of blocked communication requests. You can also set whether to allow or reject ICMP communications such as PING commands, etc., after specifying firewall settings.

1 Press  (Settings/Registration).

2 Press <Preferences> ▶ <Network> ▶ <Firewall Settings>.

3 Press <IPv4 Address Filter> or <IPv6 Address Filter>.

- Select the filter setting that corresponds to the IP address set on the machine.

4 Select <Outbound Filter> or <Inbound Filter>.

- To restrict data sent from the machine to a computer, select <Outbound Filter>.
- To restrict data received from a computer, select <Inbound Filter>.
- To restrict data communication but allow only ICMP communications such as PING commands, etc., set <Always Allow Sending/Receiving Using ICMP> to <On>.

5 Set <Use Filter> to <On>, select <Default Policy>, then press <Register>.

- For <Default Policy>, select <Reject> to only allow communication with devices that have an IP address specified in <Exception Addresses> in the next step, or select <Allow> to reject communication with them.

NOTE

- If <Reject> is selected for <Default Policy>, the restrictions do not apply to sending to multicast or broadcast addresses.

6 Set the exception addresses.

When using IPv4



When using IPv6



- Specify the IP addresses to designate as exceptions of the <Default Policy> option selected in the previous step. Select one of the input methods described below.

a <Single Address>

Enter an individual IP address to designate as an exception. In the case of IPv6, press <Address> to display the input screen.

b <Range Address>

Specify a range of IP addresses. Enter a separate address for <First Address> and <Last Address>. It is not possible to enter IPv6 addresses.

c <Prefix Address>

Specify a range of IP addresses using a prefix (network address). Enter a network address for <Address>, and specify the network address length in <Prefix Length>.

■ Setting exception addresses for the transmission filter/reception filter

- 1 Select the IP address input method, and enter the exception addresses.
- 2 Press <Next>.
- 3 Set the port number if necessary, and press <OK>.
 - Select whether to specify a port number. You can configure detailed communication restrictions by specifying a port number for the exception address.



a <Do Not Specify>

The exception address setting applies to all communication received from the specified IP address.

b <Specify>

The exception address setting only applies to communication received from the specified IP address using the designated port number. Press <Add>, enter the port number, and press <OK>. You can register up to 50 ports per one exception address for both IPv4/IPv6.

NOTE

To edit an exception address



- On the screen displayed in step 5, select the exception address that you want to edit, and press <Edit> to display the edit screen.

7 Press <OK>.

8 Press (Settings/Registration) ▶ (Settings/Registration) ▶ <Apply Set. Changes> ▶ <Yes>.

NOTE

Checking the blocked communication requests in the log

- The latest 100 communications blocked by the firewall can be displayed from  (Settings/Registration) ▶ <Preferences> ▶ <Network> ▶ <Firewall Settings> ▶ <IP Address Block Log>. The history of blocked communications can be exported from the Remote UI in the CSV format.  **Exporting a Log as a File(P. 943)**
- If <Default Policy> is set to <Reject>, the history of communication blocked by the firewall is not displayed in <IP Address Block Log>.

LINKS

-  **Specifying MAC Addresses in Firewall Settings(P. 858)**

Specifying MAC Addresses in Firewall Settings

961F-0H4

You can set whether to allow or reject communication with a device that has a specific MAC address.

1 Press  (Settings/Registration).

2 Press <Preferences> ► <Network> ► <Firewall Settings> ► <MAC Address Filter>.

3 Select <Outbound Filter> or <Inbound Filter>.

- To restrict data sent from the machine to a computer, select <Outbound Filter>.
- To restrict data received from a computer, select <Inbound Filter>.

4 Set <Use Filter> to <On>, select <Default Policy>, then press <Register>.

- For <Default Policy>, select <Reject> to only allow communication with devices that have a MAC address specified in <Exception Addresses> in the next step, or select <Allow> to reject communication with them.

NOTE

- If <Reject> is selected for <Default Policy>, the restrictions do not apply to sending to multicast or broadcast addresses.

5 Enter the exception addresses, and press <OK>.

- Specify the MAC addresses to designate as exceptions of the <Default Policy> option selected in the previous step.
- You can register 100 exception addresses for <Outbound Filter> and <Inbound Filter>.

NOTE

To edit an exception address

- On the screen displayed in step 4, select the exception address that you want to edit, and press <Edit> to display the edit screen.

6 Press <OK>.

7 Press  (Settings/Registration) ►  (Settings/Registration) ► <Apply Set. Changes> ► <Yes>.

LINKS

◉ Specifying IP Addresses in Firewall Settings(P. 855)

Configuring the Firewall of the Sub Line

961F-0H5

You can set whether to allow communication only with devices that have the specified IP address for communication with the sub line.

NOTE

- Only IPv4 addresses can be registered for the sub line.
- For information on the exception addresses and exception port numbers that can be used for communication and are registered by default, see [▶Management Functions\(P. 1586\)](#) .

1 Press  (Settings/Registration).

2 Press <Preferences> ▶ <Network> ▶<Sub Line Settings> ▶ <Firewall Settings>.

3 Press <IPv4 Address Filter>.

4 Select <Outbound Filter> or <Inbound Filter>.

- To restrict data sent from the machine to a computer, select <Outbound Filter>.
- To restrict data received from a computer, select <Inbound Filter>.

5 Set <Use Filter> to <On>, select <Default Policy>, then press <Register>.

- For <Default Policy>, select <Reject> to only allow communication with devices that have an IP address specified in <Exception Addresses> in the next step, or select <Allow> to reject communication with them.

NOTE

- If <Reject> is selected for <Default Policy>, the restrictions do not apply to sending to multicast or broadcast addresses.

6 Set the exception addresses.



- Specify the IP addresses to designate as exceptions of the <Default Policy> option selected in the previous step. Select one of the input methods described below.

a <Single Address>

Enter an individual IP address to designate as an exception.

b <Range Address>

Specify a range of IP addresses. Enter a separate address for <First Address> and <Last Address>.

c <Prefix Address>

Specify a range of IP addresses using a prefix (network address). Enter a network address for <Address>, and specify the network address length in <Prefix Length>.

■ Setting exception addresses for the transmission filter/reception filter

- 1 Select the IP address input method, and enter the exception addresses.
- 2 Press <Next>.
- 3 Set the port number if necessary, and press <OK>.
 - Select whether to specify a port number. You can configure detailed communication restrictions by specifying a port number for the exception address.



a <Do Not Specify>

The exception address setting applies to all communication received from the specified IP address.

b <Specify>

The exception address setting only applies to communication received from the specified IP address using the designated port number. Press <Add>, enter the port number, and press <OK>. You can register up to 50 ports per one exception address.

NOTE

To edit an exception address

- On the screen displayed in step 5, select the exception address that you want to edit, and press <Edit> to display the edit screen.

7 Press <OK>.

8 Press (Settings/Registration) ▶ (Settings/Registration) ▶ <Apply Set. Changes> ▶ <Yes>.

NOTE

Checking the blocked communication requests in the log

- The latest 100 communications blocked by the firewall can be displayed from (Settings/Registration) ▶ <Preferences> ▶ <Network> ▶ <Firewall Settings> ▶ <IP Address Block Log>. The history of blocked

communications can be exported from the Remote UI in the CSV format. ▶ **Exporting a Log as a File(P. 943)**

- If <Default Policy> is set to <Reject>, the history of communication blocked by the firewall is not displayed in <IP Address Block Log>.

Setting a Proxy

961F-0H6

You can set a proxy to handle communication in place of the machine, and use it when connecting to devices outside the network, such as when browsing websites. Security is enhanced when using a proxy, because the machine does not directly access resources outside the network. Administrator or NetworkAdmin privileges are required in order to configure these settings.



- 1** Press  (Settings/Registration).
- 2** Press <Preferences> ▶ <Network> ▶ <TCP/IP Settings> ▶ <Proxy Settings>.
- 3** Set <Use Proxy> to <On>, configure the necessary settings, and press <OK>.



a <Server Address>

Enter the address of the proxy server to use. Specify the IP address or host name depending on your environment.

b <Port Number>

Enter the port number of the proxy server to use.

c <Use Proxy within Same Domain>

Select <On> if you want to use the proxy server even when communicating with devices in the same domain.

NOTE

- This setting is only displayed for the proxy settings screen of the main line.

d <Set Authentication>

To use the proxy server authentication function, press this and configure the authentication information. On the screen that is displayed, press <On>, enter the user name and password to use for proxy authentication, and press <OK>.

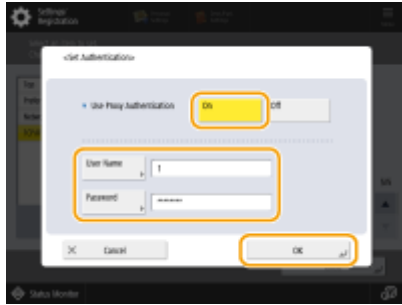

4 Press  (Settings/Registration) ►  (Settings/Registration) ► <Apply Set. Changes> ► <Yes>.

Configuring the Key and Certificate for TLS

961F-0H7

You can use TLS encrypted communication to prevent sniffing, spoofing, and tampering of data that is exchanged between the machine and other devices such as computers. When configuring the settings for TLS encrypted communication, you must specify a key and certificate (server certificate) to use for encryption. You can use the key and certificate that are preinstalled in the machine, or you can generate your own or acquire them from a certification authority. Administrator or NetworkAdmin privileges are required in order to configure these settings.



Generating the Key and Certificate for Network Communication(P. 867)

NOTE

- If you want to use a key and certificate that you generate yourself, generate the key and certificate before performing the procedure below. **Generating the Key and Certificate for Network Communication(P. 867)**
- If you want to use a key and certificate that you acquire from a certification authority (CA), register the key and certificate before performing the procedure below. **Registering a Key and Certificate(P. 920)**
- If you set <Format Encryption Method to FIPS 140-2> to <On>, you can make the TLS communication encryption method comply with the United States government-approved FIPS (Federal Information Processing Standards) 140-2. **<Format Encryption Method to FIPS 140-2>(P. 1371)**
- If <Format Encryption Method to FIPS 140-2> is set to <On>, an error will occur when you try to specify a certificate for TLS that uses an algorithm not recognized by FIPS (lower than RSA2048bit).
- A communication error will occur if you set <Format Encryption Method to FIPS 140-2> to <On>, and send to a remote party that does not support FIPS-recognized encryption algorithms.
- If <Format Encryption Method to FIPS 140-2> is set to <On>, <CHACHA20- POLY1305> and <X25519> switch to <Off>.
- If <CHACHA20- POLY1305> or <X25519> is set to <On>, <Format Encryption Method to FIPS 140-2> switches to <Off>.

1 Press  (Settings/Registration).

2 Press <Preferences> ▶ <Network> ▶ <TCP/IP Settings> ▶ <TLS Settings>.

3 Press <Key and Certificate>.

4 Select the key and certificate to use for TLS encrypted communication, and press <Set as Default Key> ▶ <Yes>.

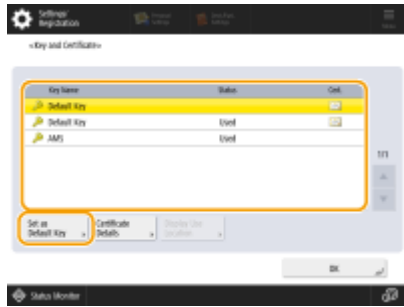

- If you want to use the preinstalled key and certificate, select <Default Key>.

NOTE

- TLS encrypted communication cannot use <Device Signature Key>, which is used for the device signature, or <AMS>, which is used for access restrictions.

5 Press <OK>.

6 Press <Specify Allowed Versions>.

7 Specify <Maximum Version> and <Minimum Version> ► press <OK>.

8 Select the settings for each algorithm.



9 Select the algorithm to use ► press <OK>.

Example: When <Encryption Algorithm Settings> is selected



NOTE:

- The displayed items may differ, depending on the algorithm.

The following combinations of TLS version and algorithm are available.

✓ : Available
 -: Unavailable

Algorithm	TLS Version			
	<TLS 1.3>	<TLS 1.2>	<TLS 1.1>	<TLS 1.0>
<Encryption Algorithm Settings>				
<AES-CBC (256-bit)>	-	✓	✓	✓
<AES-GCM (256-bit)>	✓	✓	-	-
<3DES-CBC>	-	✓	✓	✓
<AES-CBC (128-bit)>	-	✓	✓	✓
<AES-GCM (128-bit)>	✓	✓	-	-
<CHACHA20- POLY1305>	✓	-	-	-
<Key Exchange Algorithm Settings>				
<RSA>	-	✓	✓	✓
<ECDHE>	✓	✓	✓	✓
<X25519>	✓	-	-	-
<Signature Algorithm Settings>				
<RSA>	✓	✓	✓	✓
<ECDSA>	✓	✓	✓	✓
<HMAC Algorithm Settings>				
<SHA1>	-	✓	✓	✓
<SHA256>	✓	✓	-	-
<SHA384>	✓	✓	-	-

10 Press  (Settings/Registration) ▶  (Settings/Registration) ▶ <Apply Set. Changes> ▶ <Yes>.

⇒ The machine restarts, and the settings are applied.

LINKS

- ▶ Starting the Remote UI(P. 902)
- ▶ Distributing the Device Information to Other Canon Multifunction Printers(P. 1005)
- ▶ Setting E-mail/I-Fax Communication(P. 316)
- ▶ Setting Advanced Space to Public(P. 321)
- ▶ MEAP(P. 1557)

Generating the Key and Certificate for Network Communication

961F-0H8



The machine can generate the key and certificate (server certificate) used for TLS encrypted communication. If you want to start using TLS encrypted communication immediately, it is convenient to use the key and certificate that are preinstalled in the machine. If necessary, have an administrator generate a key and certificate. Note, however, that TLS encrypted communication is not enabled simply by generating a key and certificate. ▶**Configuring the Key and Certificate for TLS(P. 864)**

NOTE

- If you want to use a server certificate with a CA signature, you can generate the key along with a CSR, instead of the certificate. ▶**Generating a Key and CSR(P. 926)**

1 Press  (Settings/Registration).

2 Press <Management Settings> ▶ <Device Management> ▶ <Certificate Settings> ▶ <Generate Key> ▶ <Generate Network Communication Key>.

3 Configure the necessary items for the key, and press <Next>.



a <Key Name>

Enter a name for the key. Use a name that will be easy to find when displayed in a list.

b <Signature Algorithm>

Select the hash algorithm to use for the signature. The available hash algorithms vary depending on the key length (▶**System Specifications(P. 1577)**). A key length of 1024 bits or more can support SHA384 and SHA512 hash algorithms. If <RSA> is selected for **c**, and <Key Length (bit)> is set to <1024> or more for **d**, the SHA384 and SHA512 hash algorithms can be selected.

c <Key Algorithm>

Select the key algorithm. If <RSA> is selected, <Key Length (bit)> is displayed as a setting item for **d**. If <ECDSA> is selected, <Key Type> is displayed instead.

d <Key Length (bit)> / <Key Type>

Specify the key length if <RSA> is selected for **c**, or specify the key type if <ECDSA> is selected. In both cases, a higher value provides greater security but reduces the communication processing speed.

4 Configure the necessary items for the certificate, and press <Generate Key>.

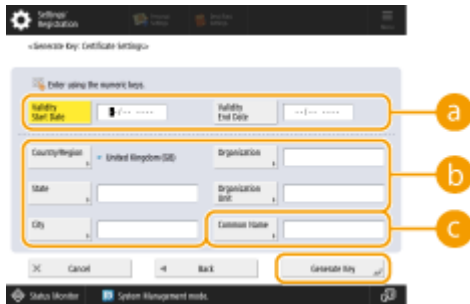

a <Validity Start Date> / <Validity End Date>

Enter the validity start and end date.

b <Country/Region>/ <State> / <City> / <Organization> / <Organization Unit>

Select the country code from the list, and enter the location and the organization name.

c <Common Name>

Enter the IP address or FQDN.

- When performing IPPS printing in a Windows environment, make sure to enter the machine's IP address.
- A DNS server is required in order to enter the FQDN of the machine. Enter the IP address if a DNS server is not used.

NOTE

Managing keys and certificates

You can check the detailed settings or delete keys and certificates on the screen that is displayed when you press (Settings/Registration) ▶ <Management Settings> ▶ <Device Management> ▶ <Certificate Settings> ▶ <Key and Certificate List>. If the list of keys and certificates is not displayed, press <Key and Certificate List for This Device> to display it.

- If is displayed, the key is corrupted or invalid.
- If is not displayed, the certificate for the key does not exist.
- If you select a key and certificate and press <Certificate Details>, detailed information about the certificate is displayed. You can also press <Verify Certificate> on this screen to check whether the certificate is valid.
- To delete keys and certificates, select the ones that you want to delete, and press <Delete> ▶ <Yes>.

LINKS

- ▶ **Registering a Key and Certificate for Network Communication(P. 920)**
- ▶ **Generating a Device Signature Certificate(P. 896)**

Configuring the IPSec Settings

961F-0H9

By using IPSec, you can prevent third parties from intercepting or tampering with IP packets transported over the IP network. Because IPSec adds security functions to IP, a basic protocol suite used for the Internet, it can provide security that is independent of applications or network configuration. To perform IPSec communication with this machine, you must configure settings such as the application parameters and the algorithm for authentication and encryption. Administrator or NetworkAdmin privileges are required in order to configure these settings.



! IMPORTANT

Communication mode

- This machine only supports transport mode for IPSec communication. As a result, authentication and encryption is only applied to the data portions of IP packets.

Key exchange protocol

This machine supports Internet Key Exchange version 1 (IKEv1) for exchanging keys based on the Internet Security Association and Key Management Protocol (ISAKMP). For the authentication method, set either the pre-shared key method or the digital signature method.

- When setting the pre-shared key method, you need to decide on a passphrase (pre-shared key) in advance, which is used between the machine and the IPSec communication peer.
- When setting the digital signature method, use a CA certificate and a PKCS#12 format key and certificate to perform mutual authentication between the machine and the IPSec communication peer. For more information on registering new CA certificates or keys/certificates, see [▶ Registering a Key and Certificate for Network Communication\(P. 920\)](#) . Note that SNTP must be configured for the machine before it uses this method. [▶ Making SNTP Settings\(P. 309\)](#)

NOTE

- Regardless of the setting of <Format Encryption Method to FIPS 140-2> for IPSec communication, an encryption module which has already obtained FIPS140-2 certification will be used.
- In order to make IPSec communication comply with FIPS 140-2, you must set the key length of both DH and RSA for IPSec communication to 2048-bit or longer in the network environment that the machine belongs to.
- Only the key length for DH can be specified from the machine.
- Take note when configuring your environment, as there are no settings for RSA in the machine.
- You can register up to 10 security policies.

1 Press  (Settings/Registration).

2 Press <Preferences> ▶ <Network> ▶ <TCP/IP Settings> ▶ <IPSec Settings>.

3 Set <Use IPSec> to <On>, and press <Register>.

4 Specify a name for the policy.

- Press <Policy Name>, enter the name, and press <OK>.
- Canon multifunction printers support two key lengths for the AES encryption method: 128 bit and 256 bit. To restrict the key length to 256 bit and meet CC authentication standards, set <Only Allow 256-bit for AES Key Length> to <On>.

5 Configure the IPSec application parameters.

1 Press <Selector Settings>.

2 Specify the IP address to apply the IPSec policy to.

- Specify the IP address of this machine in <Local Address>, and specify the IP address of the communication peer in <Remote Address>.



<All IP Addresses>	IPSec is applied to all sent and received IP packets.
<IPv4 Address>	IPSec is applied to IP packets sent to and received from the IPv4 address of this machine.
<IPv6 Address>	IPSec is applied to IP packets sent to and received from the IPv6 address of this machine.
<All IPv4 Addresses>	IPSec is applied to IP packets sent to and received from the IPv4 address of the communication peer.
<All IPv6 Addresses>	IPSec is applied to IP packets sent to and received from the IPv6 address of the communication peer.
<IPv4 Manual Settings>	Specify the IPv4 address to apply IPSec to. <ul style="list-style-type: none"> • Select <Single Address> to enter an individual IPv4 address. • Select <Address Range> to specify a range of IPv4 addresses. Enter a separate address for <First Address> and <Last Address>. • Select <Subnet Settings> to specify a range of IPv4 addresses using a subnet mask. Enter separate values for <Address> and <Subnet Mask>.
<IPv6 Manual Settings>	Specify the IPv6 address to apply IPSec to. <ul style="list-style-type: none"> • Select <Single Address> to enter an individual IPv6 address. • Select <Address Range> to specify a range of IPv6 addresses. Enter a separate address for <First Address> and <Last Address>.

- Select <Specify Prefix> to specify a range of IPv6 addresses using a prefix. Enter separate values for <Address> and <Prefix Length>.

3 Specify the port to apply IPsec to.

- Press <Specify by Port Number> to use port numbers when specifying the ports that IPsec applies to. Select <All Ports> to apply IPsec to all port numbers. To apply IPsec to a specific port number, press <Single Port> and enter the port number. After specifying the ports, press <OK>. Specify the port of this machine in <Local Port>, and specify the port of the communication peer in <Remote Port>.

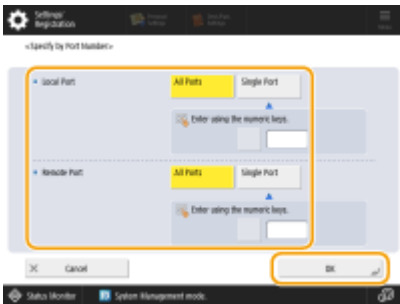

- Press <Specify by Service Name> to use service names when specifying the ports that IPsec applies to. Select the service in the list, press <Service On/Off> to set it to <On>, and press <OK>.



4 Press <OK>.

6 Configure the authentication and encryption settings.

- 1 Press <IKE Settings>.
- 2 Configure the necessary settings.

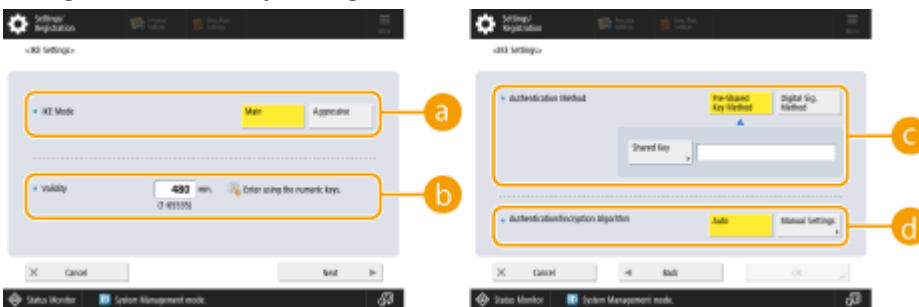

a <IKE Mode>

Select the operation mode for the key exchange protocol. When the operation mode is set to <Main>, security is enhanced because the IKE session itself is encrypted, but a higher burden is placed on the communication compared to <Aggressive>, which does not perform encryption.

b <Validity>

Set the expiration period of the generated IKE SA.

c <Authentication Method>

Select one of the authentication methods described below.

<Pre-Shared Key Method>	Set the same passphrase (pre-shared key) that is set for the communication peer. Press <Shared Key>, enter the character string to use as the shared key, and press <OK>.
<Digital Sig. Method>	Set the key and certificate to use for mutual authentication with the communication peer. Press <Key and Certificate>, select the key and certificate to use, and press <Set as Default Key> ▶ <Yes> ▶ <OK>.

d <Authentication/Encryption Algorithm>

Select either <Auto> or <Manual Settings> to set how to specify the authentication and encryption algorithm for IKE phase 1. If you select <Auto>, an algorithm that can be used by both this machine and the communication peer is set automatically. If you want to specify a particular algorithm, select <Manual Settings> and configure the settings below.

<Authentication>	Select the hash algorithm.
<Encryption>	Select the encryption algorithm.
<DH Group>	Select the group for the Diffie-Hellman key exchange method to set the key strength.

3 Press <OK>.

NOTE

- When <IKE Mode> is set to <Main> on the <IKE Settings> screen and <Authentication Method> is set to <Pre-Shared Key Method>, the following restrictions apply when registering multiple security policies.
 - **Pre-shared key method key:** when specifying multiple remote IP addresses to which a security policy is to be applied, all shared keys for that security policy are identical (this does not apply when a single address is specified).
 - **Priority:** when specifying multiple remote IP addresses to which a security policy is to be applied, the priority of that security policy is below security policies for which a single address is specified.

7 Configure the IPSec communication settings.

1 Press <IPSec Network Settings>.

2 Configure the necessary settings.



a <Validity>

Set the expiration period of the generated IPsec SA. Make sure to set either <Time> or <Size>. If you set both, the setting with the value that is reached first is applied.

b <PFS>

If you set the Perfect Forward Secrecy (PFS) function to <On>, the secrecy of the encryption key is increased, but the communication speed is slower. In addition, the PFS function must be enabled on the communication peer device.

c <Authentication/Encryption Algorithm>

Select either <Auto> or <Manual Settings> to set how to specify the authentication and encryption algorithm for IKE phase 2. If you select <Auto>, the ESP authentication and encryption algorithm is set automatically. If you want to specify a particular authentication method, press <Manual Settings> and select one of the authentication methods below.

<ESP>	Authentication and encryption are both performed. Select the algorithm for <ESP Authentication> and <ESP Encryption>. Select <NULL> if you do not want to set the authentication or encryption algorithm.
<ESP (AES-GCM)>	AES-GCM is used as the ESP algorithm, and authentication and encryption are both performed.
<AH (SHA1)>	Authentication is performed, but data is not encrypted. SHA1 is used as the algorithm.

3 Press <OK> ► <OK>.

8 Enable the registered policies and check the order of priority.

- Select the registered policies from the list, and press <Policy On/Off> to turn them <On>.
- Policies are applied in the order that they are listed, starting at the top. If you want to change the order of priority, select a policy in the list and press <Raise Priority> or <Lower Priority>.
- If you do not want to send or receive packets that do not correspond to the policies, select <Reject> for <Receive Non-Policy Packets>.

9 Press <OK>.

10 Press  (Settings/Registration) ►  (Settings/Registration) ► <Apply Set. Changes> ► <Yes>.

NOTE

Managing IPsec policies

You can edit policies on the screen displayed in step 3.

- To edit the details of a policy, select the policy in the list and press <Edit>.
- To disable a policy, select the policy in the list and press <Policy On/Off>.
- To delete a policy, select the policy in the list and press <Delete> ► <Yes>.

Configuring the IEEE 802.1X Authentication Settings

961F-0HA

In a network environment that uses IEEE 802.1X authentication, unauthorized network access is blocked by a LAN switch (authenticator) that only grants access privileges to client devices (supplicants) that are authorized by the authentication server (RADIUS server). To connect this machine to an IEEE 802.1X network, settings such as the authentication method used by the authentication server must be configured on the machine. Administrator or NetworkAdmin privileges are required in order to configure these settings.

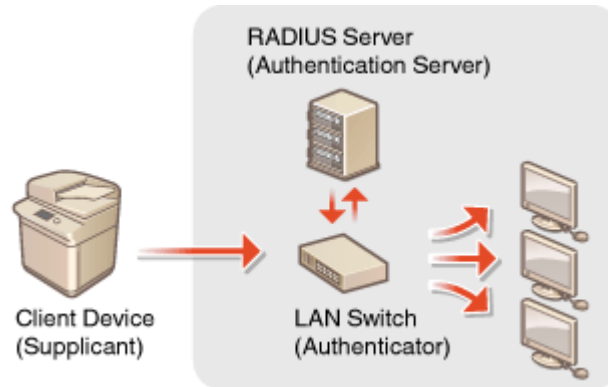

IEEE 802.1X Authentication Method

The machine supports the authentication methods described below. You must register a CA certificate before using any of these authentication methods. [Registering a CA Certificate\(P. 921\)](#)

■ EAP-TLS (Extensible Authentication Protocol-Transport Level Security)

The machine and the authentication server authenticate each other by mutually sending certificates. A CA certificate must be registered on the machine to verify the certificate (server certificate) sent from the authentication server. In addition, a PKCS#12 format key and certificate (client certificate) must be specified in this setting, so that the authentication server can authenticate the machine. Register these items before configuring the settings ([Registering a Key and Certificate\(P. 920\)](#)). This authentication method cannot be used in combination with the other methods.

■ EAP-TTLS (EAP-Tunneled TLS)

Only the authentication server sends a certificate. A CA certificate must be registered on the machine to verify the certificate (server certificate) sent from the authentication server. In addition, a user name and password need to be specified in these settings, so that the authentication server can authenticate the machine. Microsoft Challenge Handshake Authentication Protocol Version 2 (MS-CHAPv2) or Password Authentication Protocol (PAP) can be selected as the internal authentication protocol to support EAP-TTLS.

■ PEAP (Protected EAP)

Only the authentication server sends a certificate. A CA certificate must be registered on the machine to verify the certificate (server certificate) sent from the authentication server. In addition, a user name and password need to be specified in these settings, so that the authentication server can authenticate the machine. Only MS-CHAPv2 can be selected as the internal authentication protocol to support PEAP.

Setting the IEEE 802.1X Authentication Method

- 1 Press  (Settings/Registration).
- 2 Press <Preferences> ▶ <Network> ▶ <IEEE 802.1X Settings>.

3 Set <Use IEEE 802.1X> to <On>, configure the necessary settings, and press <Next>.



a <Login Name>

Enter the name (EAP Identity) of the login user to receive IEEE 802.1X authentication.

b <Verify Authentication Server Certificate>

Set this setting to <On> when verifying server certificates sent from an authentication server.

c <Verify Authentication Server Name>

To verify a common name in the server certificate, select <On> in <Verify Authentication Server Name>, and enter the name of the authentication server registered by the login user in <Authentication Server Name>.

4 Select the authentication method and configure the necessary settings.

■ Selecting EAP-TLS

- 1 Press <On> for <Use TLS>, and press <Key and Certificate>.
- 2 In the list, select the key and certificate to use, and press <Set as Default Key> ► <Yes>.
- 3 Press <OK>.

■ Selecting EAP-TTLS

- 1 Press <On> for <Use TTLS>.
- 2 Select <MSCHAPv2> or <PAP>, and press <OK>.
- 3 Enter the user name and password.
 - Press <User Name> or <Password>, and enter the information. If you enter a name for <User Name>, disable <Same User Name as Login Name>.
 - If you want to set <User Name> to the same login name that was entered in step 3, press <Same User Name as Login Name>.
 - <Confirm> is displayed when you enter a password and press <OK>. For confirmation, enter the password again and press <OK>.

■ Selecting PEAP

- 1 Press <On> for <Use PEAP>.
- 2 Enter the user name and password.
 - Press <User Name> or <Password>, and enter the information. If you enter a name for <User Name>, disable <Same User Name as Login Name>.

- If you want to set <User Name> to the same login name that was entered in step 3, press <Same User Name as Login Name>.
- <Confirm> is displayed when you enter a password and press <OK>. For confirmation, enter the password again and press <OK>.

5 Press <OK>.

6 Press  (Settings/Registration) ▶  (Settings/Registration) ▶ <Apply Set. Changes> ▶ <Yes>.

Restricting the Machine's Functions

961F-0HC

You can restrict the use of certain functions that may lead to information leaks or that are subject to misuse. It is also possible to completely disable the use of individual functions.

Restricting Access to Address Book and Sending Functions

You can set a PIN for the Address Book so that general users cannot make any changes, and you can limit the destinations that can be specified when sending faxes and scans. You can also set individual access numbers for specific contacts whose information you do not want to make available to everyone, so that only the users who know the number can access the destination. **Restricting Access to Address Book and Sending Functions(P. 878)**



Restricting Printing from a Computer

You can prohibit all users from printing documents from a computer, or only allow printing if the user is authorized on the machine. You can also configure the machine so that only Encrypted Secure Print documents can be printed. **Restricting Printing from a Computer(P. 886)**



Restricting the Use of Memory Media

Although memory media such as USB memory devices provide convenience, they also increase the potential for security risks such as information leakage. You can set access restrictions for memory media based on your security policy. **Restricting the Use of Memory Media(P. 889)**



Restricting Access to Address Book and Sending Functions

961F-0HE

You can set a PIN for the Address Book to prevent users from editing destination information, or you can restrict the available sending destinations to reduce the risk of information leakage. On models with a fax function, you can also reduce the chance of mistakenly sent faxes by specifying that faxes are only sent if the fax number is entered twice.



- ▶ **Restricting Use of the Address Book(P. 879)**
- ▶ **Limiting Available Destinations(P. 882)**
- ▶ **Restricting the Fax Sending Functions(P. 884)**

Restricting Use of the Address Book



You can prevent the leakage of sensitive or personal information from the Address Book by setting a PIN or preventing certain destinations from being displayed in the Address Book. You can also hide the Address Book itself. Administrator privileges are required in order to configure these settings.

- ▶ **Setting a PIN for Address Book(P. 879)**
- ▶ **Restricting Access to Destinations Registered in the Address Book(P. 880)**
- ▶ **Hiding the Address Book(P. 880)**

Setting a PIN for Address Book

The Address Book can be set to require users to enter a PIN in order to add new entries to the Address Book or edit existing entries. This can reduce the risk of unauthorized editing of the Address Book. Note, however, that even if a PIN is set for the Address Book, a user who logs in with Administrator privileges can add and edit entries without entering the required PIN.

- 1** Press  (Settings/Registration).
- 2** Press <Set Destination> ▶ <Address Book PIN> ▶ <Set>.
- 3** Set the PIN for editing the Address Book.

- Enter the PIN and press <Confirm>. For confirmation, enter the PIN again and press <OK>.



NOTE

- You cannot set a PIN that consists only of zeros, such as "00" or "0000000".
- To disable the PIN, press  (Clear) to erase the PIN (leave the text box blank), and press <OK>.

- 4** Press <OK>.

NOTE

In addition to setting the Address Book PIN, you can further enhance security by performing the following operations:

- Restricting the addition of new destinations **▶ Limiting Available Destinations(P. 882)**
- Disabling the PC fax function **▶ Restricting Fax Sending from a Computer(P. 884)**

Restricting Access to Destinations Registered in the Address Book

You can set an access number for important business contacts and other destinations in the Address Book that you do not want to display to all users. Destinations with a registered access number are only displayed to users who enter the correct access number. Follow the procedure below to enable the access number registration function.

IMPORTANT

- If the access number registration function is enabled, users cannot specify a destination using <Previous Settings>.



 (Settings/Registration) ▶ <Set Destination> ▶ <Manage Address Book Access Numbers> ▶ <On> ▶ <OK>

- After configuring this setting, register the access numbers in the Address Book.

NOTE

- You can enter up to seven digits for the access number. If you enter fewer than seven digits, the machine stores the access number with leading zeros.
Example: If <321> is entered, <0000321> is stored.
- You cannot store an access number with only zeros as the number, such as <0000000>.
- If you enter a number that begins in zeros, such as <02> or <002>, the zeros are ignored and the number is registered as <0000002>, the same as if you had simply entered <2>.

Hiding the Address Book

Set whether to hide the Address Book and one-touch buttons. You can specify separate settings for Fax as well as Scan and Send.

Hiding the Fax Address Book and One-Touch Buttons



 (Settings/Registration) ▶ <Function Settings> ▶ <Send> ▶ <Fax Settings> ▶ <Restrict Address Book Use> ▶ <On> ▶ <OK>

Hiding the Scan and Send Address Book and One-Touch Buttons



 (Settings/Registration) ▶ <Function Settings> ▶ <Send> ▶ <Common Settings> ▶ <Restrict Address Book Use> ▶ <On> ▶ <OK>

LINKS

- ▶ **Registering Destinations in the Address Book(P. 394)**
- ▶ **Registering Destinations via the Remote UI(P. 912)**

Limiting Available Destinations

961F-0HH



You can set restrictions on the destinations that can be specified. For example, you can limit the destinations to those that are registered in the Address book or LDAP server. With personal authentication management, you can restrict the send destination to the user's own e-mail address or to a folder that is specified in advance. You can also restrict the domains that can be specified as destinations. By restricting the send destinations, you can prevent information leakage that may occur due to operation errors or misuse. Administrator or DeviceAdmin privileges are required in order to configure these settings.

! IMPORTANT

- Some of the restrictions on the destinations that are described below may not be available when ACCESS MANAGEMENT SYSTEM is enabled. [Using ACCESS MANAGEMENT SYSTEM\(P. 849\)](#)

- Restricting New Destinations(P. 882)
- Restricting E-Mail Destination to <Send to Myself>(P. 883)
- Restricting File Send Destination to Personal Folder(P. 883)
- Restricting the Domain of Send Destination(P. 883)

Restricting New Destinations

The destinations that can be specified when sending faxes or scanned documents can be restricted to those registered in the Address Book or one-touch buttons, those registered in <Favorite Settings> or <Send to Myself>, or those that can be searched on the LDAP server. When this function is enabled, users cannot specify destinations using alphanumeric character input.

- Press  (Settings/Registration).
- Press <Function Settings> ▶ <Send> ▶ <Common Settings> ▶ <Limit New Destination>.
- Select the functions that you want to restrict new destinations for.

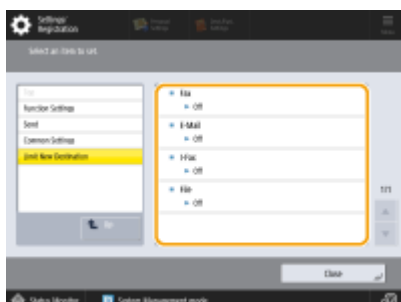

4 Press <On> ► <OK>.

Restricting E-Mail Destination to <Send to Myself>

You can set restrictions so that users who log in with personal authentication can only send scanned documents to their own e-mail address. To use this function, an e-mail address must be registered in the user information. Configure the user information before performing the procedure below.



⚙️ (Settings/Registration) ► <Function Settings> ► <Send> ► <Common Settings> ► <Limit E-Mail to Send to Myself> ► <On> ► <OK>

Restricting File Send Destination to Personal Folder

You can set restrictions so that users who log in with personal authentication can only send scanned documents to their Personal folder ([Configuring Personal Folders\(P. 846\)](#) .)



⚙️ (Settings/Registration) ► <Function Settings> ► <Send> ► <Common Settings> ► <Restrict File TX to Personal Folder> ► <On> ► <OK>

Restricting the Domain of Send Destination

You can restrict e-mail and I-fax destinations so that only addresses in a specific domain are available. When a domain is specified, you can also set whether to allow sending to subdomains.



⚙️ (Settings/Registration) ► <Function Settings> ► <Send> ► <E-Mail/I-Fax Settings> ► <Restrict TX Destination Domain> ► Select <On> for <Restrict Sending to Domains> ► <Register> ► Specify the destination domain ► <OK> ► Select <Allow> or <Reject> for <Send to Subdomain> ► <OK> ► <OK>

NOTE

- You can register up to three domains.

LINKS

- [Basic Operations for Sending Faxes\(P. 524\)](#)
- [Basic Operations for Scanning Originals\(P. 640\)](#)

Restricting the Fax Sending Functions

961F-0HJ

You can set various restrictions for sending faxes, which can prevent sending errors and information leakage to third parties. Administrator privileges are required in order to configure these settings.



- ▶ **Confirming Fax Numbers before Sending(P. 884)**
- ▶ **Restricting Fax Sending from a Computer(P. 884)**
- ▶ **Displaying a Confirmation Screen for Fax Destinations(P. 884)**
- ▶ **Restricting Sequential Broadcasting(P. 885)**
- ▶ **Restricting Sending from Log(P. 885)**

Confirming Fax Numbers before Sending

You can require users to enter a fax number twice for confirmation before sending faxes, to prevent misdialing. This setting can also be configured with DeviceAdmin privileges.



⚙️ (Settings/Registration) ▶ <Function Settings> ▶ <Send> ▶ <Fax Settings> ▶ <Confirm Entered Fax Number> ▶ <On> ▶ <OK>

Restricting Fax Sending from a Computer

You can prohibit users from sending faxes from a computer (▶ **Sending Faxes from Your Computer (PC Fax) (P. 577)**). This setting can also be configured with DeviceAdmin privileges.



⚙️ (Settings/Registration) ▶ <Function Settings> ▶ <Send> ▶ <Fax Settings> ▶ <Allow Fax Driver TX> ▶ <Off> ▶ <OK>

Displaying a Confirmation Screen for Fax Destinations

You can set the machine to display a confirmation screen when sending to a fax destination. This can help prevent fax sending errors.



⚙️ (Settings/Registration) ▶ <Function Settings> ▶ <Send> ▶ <Fax Settings> ▶ <Confirm Before Sending When Fax Dest. Included> ▶ <On> ▶ Select <Only for Seq. Broadcast> or <All> ▶ <OK> ▶ ⚙️ (Settings/Registration) ▶ ⚙️ (Settings/Registration) ▶ <Apply Set. Changes> ▶ <Yes>

NOTE

- <Only for Seq. Broadcast> and <All> cannot be selected if sequential broadcasting is restricted (▶ **Restricting Sequential Broadcasting(P. 885)**).
- When the function for confirming the fax number before sending (▶ **Confirming Fax Numbers before Sending(P. 884)**) is enabled, the confirmation screen is not displayed if there is only one destination.

Restricting Sequential Broadcasting

You can restrict the sequential broadcasting function, which enables users to send a fax to multiple recipients in succession.



⚙️ (Settings/Registration) ▶ <Function Settings> ▶ <Send> ▶ <Fax Settings> ▶ <Restrict Sequential Broadcast When Fax Dest. Included> ▶ <On> ▶ <OK> ▶ ⚙️ (Settings/Registration) ▶ ⚙️ (Settings/Registration) ▶ <Apply Set. Changes> ▶ <Yes>

Restricting Sending from Log

You can prohibit users from being able to specify a previously used destination from the log. After configuring this setting, previously used destinations cannot be selected from the log when sending faxes.



⚙️ (Settings/Registration) ▶ <Function Settings> ▶ <Send> ▶ <Common Settings> ▶ <Restrict Resending from Log> ▶ <On> ▶ <OK>

LINKS

▶ **Basic Operations for Sending Faxes(P. 524)**

Restricting Printing from a Computer

961F-0HK

You can restrict printing from a computer ([▶Printing From a Computer\(P. 597\)](#)) so that only specific types of documents can be printed. You can also configure the machine so that documents are not printed until the user is authorized on the machine ([▶Printing Documents Retained in the Machine \(Forced Hold Printing\)\(P. 608\)](#)). You can also restrict the machine to only print Encrypted Secure Print ([▶Printing More Safely with Encrypted Secure Print\(P. 611\)](#)) documents, which can prevent information leakage due to unattended printouts or unprotected print data. Administrator or DeviceAdmin privileges are required in order to configure these settings.

- ▶[Prohibiting Printing from a Computer\(P. 886\)](#)
- ▶[Configuring the Forced Hold Printing Settings\(P. 886\)](#)
- ▶[Allowing Only Encrypted Secure Print\(P. 888\)](#)

Prohibiting Printing from a Computer

You can prohibit users from printing documents from a computer. However, even when printing from a computer is prohibited, you can allow users to save documents in the temporary storage space of the machine (Mail Box), as well as print documents saved in the Mail Box.



 (Settings/Registration) ▶ <Function Settings> ▶ <Printer> ▶ <Restrict Printer Jobs> ▶ <On> ▶
Select the restriction exceptions ▶ <OK>

Configuring the Forced Hold Printing Settings



When printing documents from a computer, you can hold print data in the machine and prevent documents from being printed immediately ([▶Printing Documents Retained in the Machine \(Forced Hold Printing\)\(P. 608\)](#)). You can configure settings so that printing cannot be performed until the user is authorized on the machine, which ensures greater security and reduces the risk of other people viewing or inadvertently picking up sensitive documents. Administrator privileges are required in order to configure these settings.

- 1** Press  (Settings/Registration).
- 2** Press <Function Settings> ▶ <Print> ▶ <Forced Hold>.
- 3** Press <On>, set the necessary conditions, and then press <OK>.

- You can set detailed conditions for holding printer jobs, such as the user or IP address. If no conditions are set, all print jobs are held except for jobs from unidentified users. If no conditions are set and a print job from an unidentified user is received, it is canceled without being held.

■ Setting the conditions for holding documents

- 1 Press <Register>.
- 2 Set the conditions for holding documents, and press <OK>.



a <Condition Name>

Enter a name for the condition. Use a name that will be easy to identify when displayed in a list.

b <Job Condition>

The types of conditions listed below can be selected.

<User Name>	Specify a particular user name as the condition. If this is left blank, print documents for which the user cannot be identified will be targeted.
<IP Address>	Specify a particular IP address as the condition. You can also specify a range of IP addresses.
<Input Method>	Specify a particular printing protocol as the condition.

c <Job Action>

Select how to handle documents that match the conditions. When <Hold as Shared Job> is selected, you can set <ID for Substitution> to specify the user name output to the log when printing. Select <Cancel> to discard the document.

d <Target>

You can set either a value specified by the operation target, or one not specified.

- 3 Set the order in which to apply the conditions, and press <OK>.
 - The conditions are applied in the order that they are listed, starting at the top. If you want to change the order, select a condition in the list and press <Raise Priority> or <Lower Priority>.
 - To edit the details of a condition, select it in the list and press <Details/Edit>.
 - To disable a condition, select it in the list and press <Validate/Invalidate>.
 - To delete a condition, select it in the list and press <Delete> ► <Yes>.

NOTE



Configuring the detailed settings for forced hold printing

- You can configure detailed settings for documents that are held for printing, such as how long to save them and how to display them. **▶<Print>(P. 1301)**

Allowing Only Encrypted Secure Print

You can configure the machine to only allow printing of Encrypted Secure Print documents from a computer, which can prevent information leakage due to unprotected print data. With this setting, documents cannot be printed using normal printing operations. Users are required to enter a password on the machine when printing Encrypted Secure Print documents. **▶ Printing More Safely with Encrypted Secure Print(P. 611)**





 (Settings/Registration) ▶ <Function Settings> ▶ <Print> ▶ <Only Allow Encrypted Print Jobs>
 ▶ <On> ▶ <OK> ▶  (Settings/Registration) ▶  (Settings/Registration) ▶ <Apply Set.
 Changes> ▶ <Yes>

Restricting the Use of Memory Media

961F-0HL

Although memory media such as USB memory devices provide convenience, they can also be a source of information leakage if they are not properly managed. This section describes the procedures for prohibiting the use of memory media, as well as for restricting the ability to save scanned documents on memory media, or print data saved on memory media. Administrator or DeviceAdmin privileges are required in order to configure these settings.



 (Settings/Registration) ▶ <Function Settings> ▶ <Store/Access Files> ▶ <Memory Media Settings> ▶ <Use Scan/Print Function> ▶ Select <Off> for <Use Scan Function> or <Use Print Function> ▶ <OK> ▶  (Settings/Registration) ▶  (Settings/Registration) ▶ <Apply Set. Changes> ▶ <Yes>

LINKS

- ▶ **Working with Data in Memory Media(P. 739)**
- ▶ **Printing From Memory Media (Media Print)(P. 622)**

Increasing the Security of Documents

961F-0HR

The machine is equipped with security functions designed to prevent paper and electronic documents from leakage and tampering. Designate an administrator to implement measures that minimize the risk of unauthorized copying, which can lead to leakage of sensitive documents and information, or the falsification of official documents.

Force Print of Recognition Information

You can configure the machine to always print information such as the name of the logged in user on printed or copied documents. This enables you to identify the user responsible for the output of each document. ▶ **Printing User Information on Documents(P. 891)**



Forced Secure Watermark

You can configure the machine to always embed invisible text such as "CONFIDENTIAL" or "TOP SECRET" in the background of printed or copied documents. The embedded text becomes visible when the documents are copied, alerting users to unauthorized duplication or the risk of information leakage. ▶ **Embedding Invisible Text (Forced Secure Watermark)(P. 893)**



Digital Signatures

You can increase the reliability of documents created on the machine by adding digital signatures to scanned documents. The digital signature is added using a key and certificate mechanism, which enables you to identify the device and/or user that created the document, while ensuring that the data has not been altered. ▶ **Adding a Digital Signature to Sent Files(P. 895)**

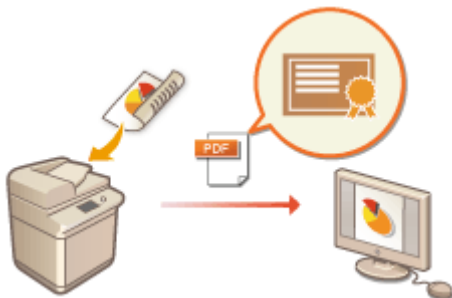

Printing User Information on Documents

961F-0HS

You can configure the machine to forcibly print user information such as the name of the logged in user on printed or copied documents. This function enables you to identify who output each document simply by checking the printed information, which can discourage unauthorized copying. Administrator or DeviceAdmin privileges are required in order to configure these settings.



- 1 Press  (Settings/Registration).
- 2 Press <Function Settings> ▶ <Common> ▶ <Print Settings> ▶ <Forced Print of Recognition Information>.
- 3 Press <On> and select the functions that forcibly print the user information.

- In <Target Function>, press <On> for each function that you want to apply this setting to.



- 4 Specify the print position and original's orientation, and press <OK>.

- Press the arrow buttons to select the print position. To precisely adjust the position, press <Set Details> and specify the location.
- Select <Upright Image> to orient the original vertically, or select <Sideways Image> to orient the original horizontally.



LINKS

▶ **Configuring the Forced Hold Printing Settings(P. 886)**

Embedding Invisible Text (Forced Secure Watermark)

961F-0HU

When the Forced Secure Watermark function is enabled, the machine forcibly embeds invisible text such as "CONFIDENTIAL" or "TOP SECRET" in the background of printed or copied documents. The embedded text becomes visible when the documents are copied, alerting users to unauthorized duplication or the risk of information leakage. Use this function to discourage the copying of documents that include personal or sensitive information. Administrator or DeviceAdmin privileges are required in order to configure these settings.

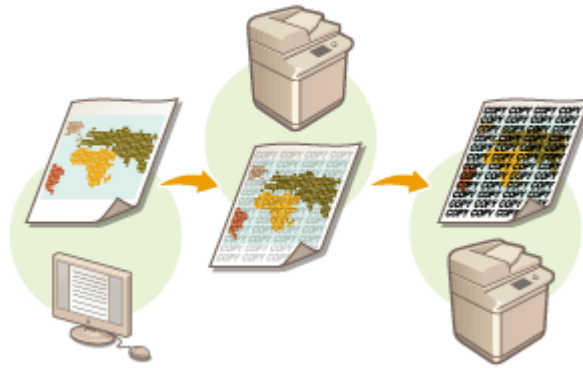

1 Press  (Settings/Registration).

2 Press <Function Settings> ▶ <Common> ▶ <Print Settings> ▶ <Secure Watermark Settings> ▶ <Forced Secure Watermark>.

3 Select the functions for which Forced Secure Watermark is enabled.

- Press <Set> for the functions that you want to use Secure Watermark for. When <Set> is selected for <Access Stored Files>, the Secure Watermark is embedded in stored files when they are printed.

4 Specify the text to embed.

- Select one of the items described below to embed as the watermark text.



a <Watermark>

In the <Watermark Type> drop-down list, select the text to embed. If you want to embed your own text, select <Custom>, press <Enter>, and enter the desired text.

b <Date>

Embed the date that the print or copy is made. Select the display format in the <Date Format> drop-down list.

c <Copy Set Numbering>

You can embed a five-digit control number in the background, only when copy set numbering is specified for prints or copies. A separate control number is embedded for each set. Enter the first control number in <Starting Number>.

d <Serial Number>

Embed the serial number of the machine.

e <ID/User Name>

Embed the name or Department ID of the logged in user. The "CONFIDENTIAL" watermark is embedded if user management is not performed for individual users or Department IDs.

5 Configure the print settings, and press <OK>.

- Set the text style.
- To add a background pattern such as polka dots or mesh, select the desired pattern in the <Background Pattern> drop-down list.
- To rotate the text and print it sideways, press <Print Vertically>.
- To print white text on a colored background, press <White Letters on Colored Background>.

6 Press <OK>.

- If you want to configure Secure Watermark for additional functions, return to step 3.

NOTE

- You can adjust the density of the watermark and background. After pressing <Secure Watermark Settings> in step 2, print a sample sheet from <Adjust Background/Character Contrast>. Examine the sheet, and press ▼ / ▲ to adjust accordingly.
- You can also set the Secure Watermark mode when printing from the printer driver. ▶ <Printer Driver Secure Watermark>(P. 1179)

LINKS

- ▶ <Embedding the "TOP SECRET" Text (Secure Watermark)>(P. 510)
- ▶ <Secure Watermark Settings>(P. 1179)

Adding a Digital Signature to Sent Files

961F-0HW

By adding a digital signature to a scanned document that is sent in a particular file format, you can certify that the document has not been altered and is guaranteed by the creator. The machine can add a device signature or user signature to documents.

Device Signature



The device signature uses a key and certificate mechanism, enabling the recipient of a scanned document to verify that it was created on this machine. The recipient can check what machine was used to create the document, as well as whether the document has been altered. Before you can add a device signature, the key and certificate (device certificate) used for the device signature needs to be created on the machine. [▶Generating a Device Signature Certificate\(P. 896\)](#)

User Signature



The user signature is linked with personal authentication management functions, enabling the recipient of a scanned document to verify who created it. As with the device signature, the user signature enables the recipient to check whether the document was altered after the signature was added. Before you can add a user signature, a key and certificate (user certificate) needs to be registered for each user via the Remote UI. [▶Registering a User Signature Certificate\(P. 897\)](#)

NOTE

- For information on validating certificates, registering certificates in the trusted certificates list, and verifying signatures on the reader side, see the documentation for the software that supports the PDF format (such as Adobe Reader/Adobe Acrobat).
- You can set multiple digital signatures for a file. In this case, device signatures are applied before user signatures.
- If a recipient verifies a PDF or XPS that has had multiple signatures added to it using software that supports the PDF format (such as Adobe Reader/Adobe Acrobat) or the XPS format (such as XPS Viewer), only the last signature added to the file remains valid. The device signature causes the document to be handled as if it has been altered.
- You cannot forward a received I-fax document with a user signature from the machine.

TIPS

Displaying a digital signature (visible signature)

Digital signature information can be displayed on the first page of the document, making it easy for the reader to see that a digital signature has been added. Only PDF documents support visible signatures. [▶Adding a Digital Signature\(P. 688\)](#)

Generating a Device Signature Certificate



The key and certificate (device certificate) required when adding a device signature can be generated on the machine. Designate an administrator to generate these items. Once they are generated, you can add a digital signature to scanned documents that are sent in a particular file format. **▶ Adding a Digital Signature(P. 688)**



 (Settings/Registration) ▶ <Management Settings> ▶ <Device Management> ▶ <Certificate Settings> ▶ <Generate Key> ▶ <Generate/Update Device Signature Key> ▶ <Yes> ▶ <OK>

NOTE

Key and certificate for device signature

- The generated key and certificate are registered with the name "Device Signature Key". You can register only one key and certificate for the device signature.

Managing the key and certificate for device signature

You can check the detailed settings of the key and certificate on the screen that is displayed when you press

 (Settings/Registration) ▶ <Management Settings> ▶ <Device Management> ▶ <Certificate Settings> ▶ <Key and Certificate List> ▶ <Key and Certificate List for This Device>.

- If  is displayed, the key is corrupted or invalid. You can update the key and certificate by configuring the settings again.
- If you select <Device Signature Key> and press <Certificate Details>, detailed information about the device signature certificate is displayed. You can also press <Verify Certificate> on this screen to check whether the certificate is valid.
- The PDF/XPS file contains sender information that the reader of the file can use to validate the reliability of the device signature by matching it with the SHA-1 message digest number. You can verify this information in <Certificate Thumbprint> on this machine.

Ensuring that a device signature is always added when sending

- You can configure the machine so that a device signature is always added to scanned documents that are sent in a particular file format, regardless of the user settings. You can also restrict the file formats used when sending documents, which ensures that no documents can be sent without a device signature. Administrator or DeviceAdmin privileges are required in order to configure these settings. **▶ <Always Add Device Signature to Send>(P. 1234)**

LINKS

- ▶ **Generating the Key and Certificate for Network Communication(P. 867)**
- ▶ **Registering a Key and Certificate for Network Communication(P. 920)**
- ▶ **Registering a User Signature Certificate(P. 897)**

Registering a User Signature Certificate



The key and certificate (user certificate) required when adding a user signature can be registered via the Remote UI. Designate an administrator to register these items. Once they are registered, users who log in with personal authentication can add a digital signature to scanned documents that are sent in a particular file format. ▶ **Adding a Digital Signature(P. 688)**

▶ **The Flow of Adding a User Signature(P. 897)**

▶ **Preparing/Registering the Certificate(P. 898)**

! IMPORTANT

- You may not be able to register some types of keys and certificates. ▶ **System Specifications(P. 1577)**
- The digital user signature certificate has an expiration date. If the PDF file or the XPS file with the digital user signature was created before the expiration date, and the viewer tries to perform verification after the certificate has expired, the digital user signature is no longer valid. It is recommended that you consider the timing of the verification, and have a new digital user signature certificate issued.

NOTE

User Signature Function

- The Digital User Signature mode links with an authentication application to add a digital user signature generated from the digital user signature certificate and key pair inside the machine to a document, which enables the viewer to verify which user signed it. The viewer can verify the user that signed the document, and whether the document has been changed after it was signed.

The Flow of Adding a User Signature

To add a digital user signature to a PDF or XPS file that is created with your machine, you must first install the digital user signature certificate and key pair issued from a certification authority into the machine. The flow of operations is as shown below.

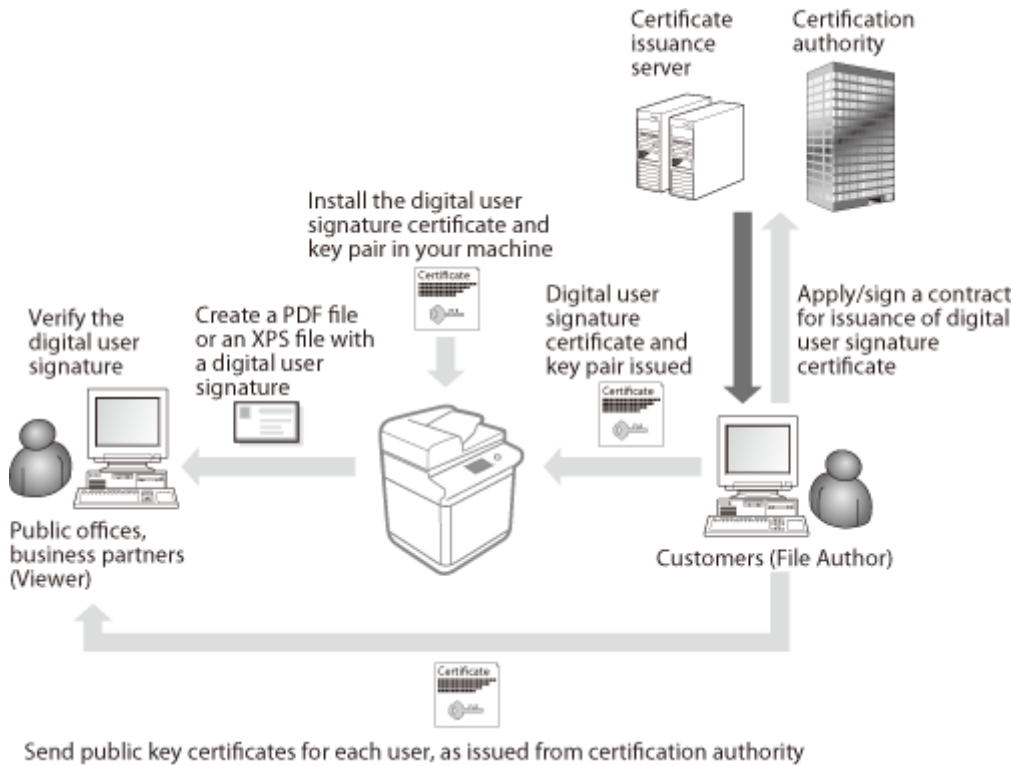

Preparing/Registering the Certificate

1 Have a digital user signature certificate and key pair issued.

If you want to add a digital user signature to be verified within a restricted range to a PDF file or an XPS file:

To add a digital user signature for verification of the validity of documents within a restricted range (such as within a company), you can issue a digital user signature certificate and key pair by installing the IIS (Internet Information Services) module of the Microsoft Windows Server OS in your computer.

IMPORTANT

- This cannot be used for verification of viewers outside the restricted range.

2 Start the Remote UI. Starting the Remote UI(P. 902)

3 Click [Settings/Registration] on the portal page. Remote UI Screen(P. 904)

4 Click [Device Management] ▶ [User Key and Certificate Settings].

5 Click [Install...].

6 Register the certificate.

- 1 Click [Browse...], and specify the file (user certificate) to install.
 - You may not be able to specify the file name if it is too long.
- 2 Enter the password of the private key.
 - In [Private Key Password], enter the password registered to the key.
- 3 Click [Start Installation].

7 Send the public key certificate to the viewer.

- Send the public key certificate issued by the certification authority (the public key included in a key pair) to the viewer to which you are going to send the PDF or XPS file with the digital user signature.

8 After sending the public key, have the viewer verify the digital signature.

- The viewer of the PDF or XPS file with the digital user signature verifies the validity of the digital signature using the public key.

NOTE

- For information on the reliability of and storing the digital user signature certificate in the trusted certification list, and how to verify signatures on the viewer side, see Help for Adobe Acrobat, Adobe Reader, or Microsoft XPS Viewer.

NOTE

Managing the keys and certificates for user signature

You can check the detailed settings or delete keys and certificates on the screen displayed in step 5.

- If you log in with Administrator privileges, the keys and certificates for all user signatures are displayed. For users who do not log in with Administrator privileges, only the key and certificate of the logged in user are displayed.
- Click a login name to display detailed information about the certificate.
- To delete keys and certificates, select the ones that you want to delete, and click [Delete] ► [OK].

LINKS

- [Generating the Key and Certificate for Network Communication\(P. 867\)](#)
- [Registering a Key and Certificate for Network Communication\(P. 920\)](#)
- [Generating a Device Signature Certificate\(P. 896\)](#)

Managing the Machine from a Computer (Remote UI)

961F-0J0

You can remotely operate the machine from your computer's Web browser to perform operations such as checking the printing status, changing the machine settings, or editing the Address Book. This convenient feature enables you to remain at your desk while operating the machine. To perform remote operation, enter the IP address of the machine in your Web browser and open the Remote UI portal page. For more information on the system requirements for the Remote UI, see [▶System Specifications\(P. 1577\)](#) .

How to Use the Remote UI

This section describes the Remote UI login procedure and the features of the Remote UI main screen.

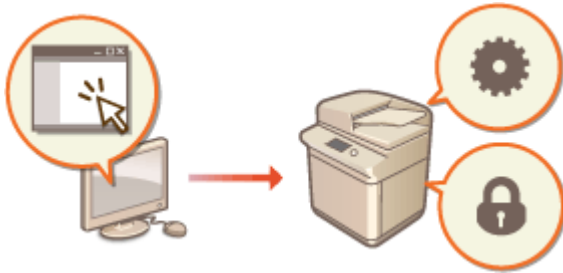

▶Starting the Remote UI(P. 902)

Checking the Status of Waiting Documents and the Machine

This section describes how to check the status of copied, printed, sent, and received documents, as well as error information and the remaining amount of paper.

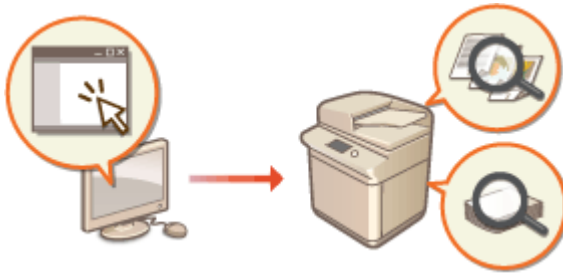

▶Checking the Status and Logs(P. 906)

Other Functions Available Using the Remote UI

This section describes various other convenient functions that can be performed via computer using the Remote UI, such as editing the Address Book, checking files that have been saved on the machine, and backing up the machine settings in case they are needed.



- ▶Turning OFF/Restarting the Machine(P. 911)
- ▶Registering Destinations via the Remote UI(P. 912)
- ▶Sharing an Address List with Specific Users(P. 916)
- ▶Registering User Groups(P. 918)
- ▶Registering a Key and Certificate for Network Communication(P. 920)
- ▶Configuring the Expiration Check Method for Received Certificates(P. 924)
- ▶Generating a Key and Certificate Signing Request (CSR)(P. 926)
- ▶Retrieving/Updating a Certificate from an SCEP Server(P. 929)
- ▶Managing Stored Files(P. 935)
- ▶Managing the Logs(P. 941)

- ▶ **Importing/Exporting the Setting Data(P. 946)**
- ▶ **Backing Up/Restoring Data(P. 965)**
- ▶ **Updating the Firmware(P. 970)**
- ▶ **Updating the Firmware (Distribution)(P. 972)**
- ▶ **Setting Scheduled Updates(P. 975)**
- ▶ **Displaying Messages from the Administrator(P. 977)**
- ▶ **Configuring the Visual Message Function(P. 979)**
- ▶ **Sending E-Mail Notification When an Error Occurs(P. 984)**

IMPORTANT

- Do not access other websites when the browser is accessing the Remote UI of your printer. Do not forget to close the web browser if you step away from the computer or after you finish changing settings.

When using a proxy server

- You cannot access the machine via a proxy server. If a proxy server is used in your environment, configure your Web browser to bypass the proxy server and access the machine directly.

Starting the Remote UI

961F-0J1

To start the Remote UI, enter the IP address of the machine in your Web browser. Check the IP address configured for the machine before performing this operation. [▶ Setting an IP Address\(P. 278\)](#)

For security reasons, you cannot log in to the Remote UI using the default password (7654321) for the Administrator user. Log in to the Remote UI after changing the password of the Administrator user from the control panel.



(Settings/Registration) ▶ <Management Settings> ▶ <User Management> ▶ <Authentication Management> ▶ <Register/Edit Authentication User> ▶ change the password for "Administrator"

! IMPORTANT

- When both the machine and the Active Directory server are set as user authentication devices ([▶ Configuring the User Login Methods and Authentication Devices\(P. 829\)](#)), the time setting of the Active Directory server needs to match that of the machine.

NOTE

Using TLS encryption for communication

- When you want to encrypt the Remote UI communication, configure the TLS key and certificate ([▶ Configuring the Key and Certificate for TLS\(P. 864\)](#)), go to the <Remote UI> setting ([▶ <Remote UI>\(P. 1348\)](#)) and set <Use TLS> to <On>, then turn the machine OFF and back ON.

Logging in to the Remote UI using the default password of the Administrator user

- You can also set to allow logging in to the Remote UI using the default password of the Administrator user. ( (Settings/Registration) ▶ <Management Settings> ▶ <Security Settings> ▶ <Authentication/Password Settings> ▶ <Password Settings> ▶ <Allow Use of Default Password for Remote Access> ▶ <On>)

1 Start the Web browser.

2 Enter the IP address of the machine, and press the [ENTER] key on the computer keyboard.

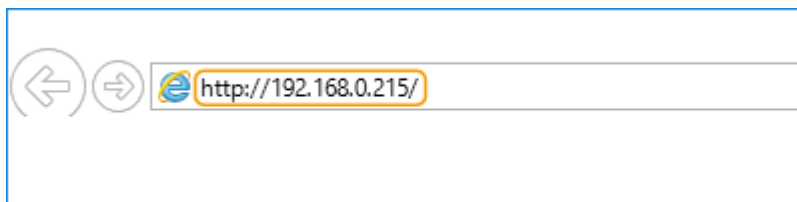

- Enter "http://<IP address of the machine>/" in the address input field.
- When using an IPv6 address, enclose the IP address portion in brackets ([]) (**Example:** http:// [fe80:2e9e:fcff:fe4e:dbce]/).

NOTE

If the Remote UI does not start

- If the login screen is not displayed in step 3 of this procedure, clear the Web browser's cache and enter the IP address again.

If a message related to security is displayed

- A warning message may be displayed if the Remote UI communication is encrypted. If there are no problems with the certificate or TLS settings, you can continue using the Web browser.

3 Log in to the Remote UI.

- Enter a registered user name and password in [User Name] and [Password], select the login destination in [Login Destination], and click [Log In].
- If [Log In (Guest)] is displayed, unregistered users can click this button and log in as general users.

NOTE

- With some user authentication settings, the Remote UI may skip the login screen and display the main screen (portal page) directly. [▶Remote UI Screen\(P. 904\)](#)

If the screen for enabling two-factor authentication appears after login

Acquire the one-time password required for authentication and then log in.

NOTE

- To acquire a one-time password, you must first install an app (Microsoft Authenticator or Google Authenticator) on your mobile device (smartphone, tablet, etc.). You must also match the time on your mobile device to the time on the machine.

- 1 Click [Log In], check the message displayed, and then press [OK].
- 2 Use the app to scan the displayed QR code.
 - ⇒ A one-time password appears.
- 3 Enter the displayed one-time password in [One-Time Password] in the Remote UI, and then click [Verify].

NOTE

- For subsequent logins, you can log in simply by entering the one-time password for the account registered in the mobile app.

4 Check that the Remote UI portal page is displayed. [▶Remote UI Screen\(P. 904\)](#)

IMPORTANT

- When using the Remote UI to operate the machine, do not use the Web browser's [Back] button. The page may not change properly if you use the [Back] button.

Setting the Timeout Time after Logging In to the Remote UI

The user is automatically logged out if no operations are performed for a certain period of time after logging in to the Remote UI. You can set the time until the user is logged out.



Start the Remote UI ▶ [Settings/Registration] ▶ [Network Settings] ▶ [Session Settings] ▶ [Timeout After Logging in to Remote UI] ▶ set the timeout time after login ▶ [OK]

Remote UI Screen

The portal page shown below is displayed when you log in to the Remote UI. This section describes the items displayed on the portal page and the basic operations.

! IMPORTANT

- Some display items and functions are only available if you log in with Administrator privileges.
- If multiple users are operating the Remote UI at the same time or the control panel of the machine is being operated at the same time as the Remote UI, the last operation that is performed is effective.

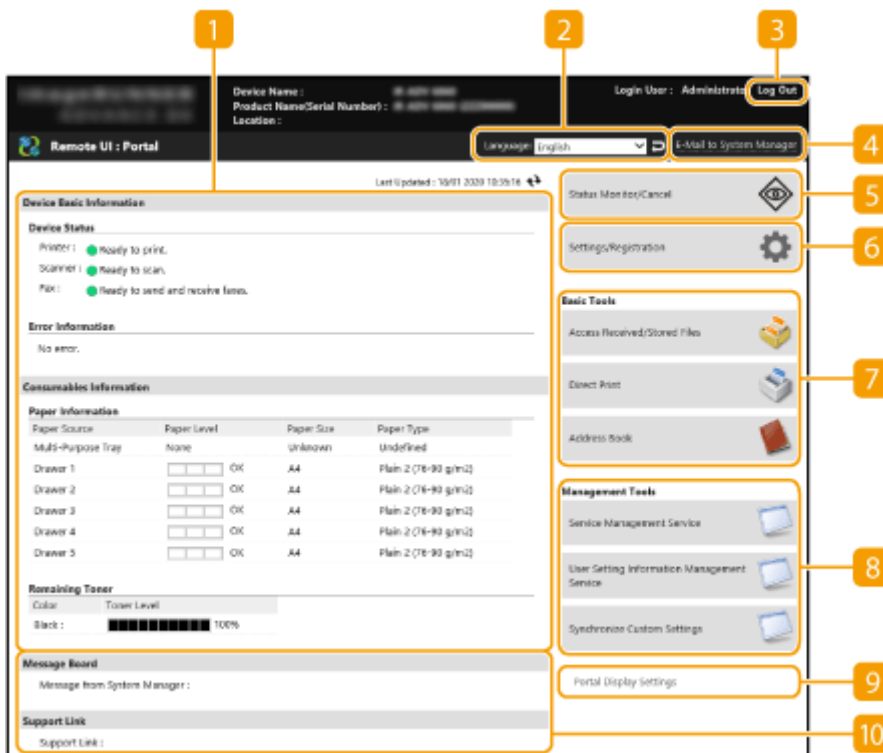

1 Device information

The current machine status is displayed, along with information about errors, consumables, etc.

2 Display language

You can switch the language that is displayed on the Remote UI screen.

3 [Log Out]

Log out from the Remote UI and return to the login page.

4 [E-Mail to System Manager]

Create an e-mail message to send to the administrator. The administrator's e-mail address can be set in [Settings/Registration] ► [User Management] ► [System Manager/Contact Person Information Settings].

5 [Status Monitor/Cancel]

You can check the status of jobs or cancel processing. You can also check detailed information about the amount of remaining toner and paper, etc. ► **Checking the Status and Logs(P. 906)**

6 [Settings/Registration]

You can change the machine settings. You can save the setting details to a computer, or import them from a computer to the machine. ► **Importing/Exporting the Setting Data(P. 946)**

NOTE

- You can use either the control panel or the Remote UI to change most machine settings, but some settings can only be changed using one or the other.

7 [Basic Tools]

You can perform operations such as printing documents or registering/editing destinations.

- **Managing Stored Files(P. 935)**
- **Directly Printing Files without Opening Them(P. 617)**
- **Registering Destinations via the Remote UI(P. 912)**

8 [Management Tools]

You can perform management for items such as MEAP applications (► **MEAP(P. 1557)**) or user setting information (► **Deleting User Setting Information(P. 850)**).

9 [Portal Display Settings]

You can change the order in which the [Basic Tools] and [Management Tools] buttons are displayed on the portal page.

10 Messages/support

Messages from the administrator are displayed, along with links to machine support information. ► **Displaying Messages from the Administrator(P. 977)**

NOTE

- To update the current page with the latest information, click .

LINKS

- **Settings/Registration(P. 1054)**

Checking the Status and Logs

961F-0J2

You can use the Remote UI to check the status of documents that are waiting to be processed, as well as the logs for documents that have been processed. You can also check the status of the machine, such as error information and the remaining amount of consumables.

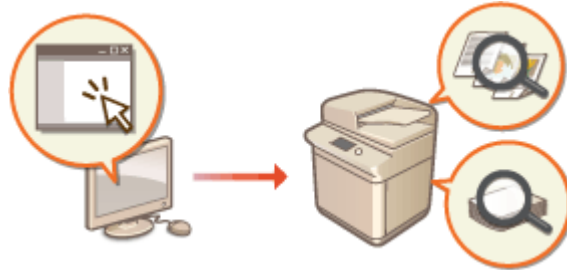

- ▶ **Checking the Status of Copies/Prints(P. 906)**
- ▶ **Checking the Status of Sent/Received Documents(P. 907)**
- ▶ **Checking the Status of Stored Documents(P. 908)**
- ▶ **Checking the Job Log(P. 908)**
- ▶ **Checking the Machine Status(P. 909)**

NOTE

- When personal authentication management is used, you can restrict users from performing operations on the jobs of other users on the <Status Monitor> screen. ▶ **<Restrict Access to Other User Jobs>(P. 1339)**

Checking the Status of Copies/Prints

You can check the status of documents that are waiting to be copied or printed. You can also output a document before the others, or cancel a document.



Start the Remote UI ▶ [Status Monitor/Cancel] ▶ [Job Status] under [Copy/Print]

Date/Time	Job Name	User Name	Status	Job Operation
01/11/2020 10:45:00	ImageMaster Accessory 010 0101 - 01010 - 01010 - 01010 users Guide.pdf	canon.valm	Printing...	Cancel Pause
01/11/2020 10:45:00	ImageMaster Accessory 010 0101 - 01010 - 01010 - 01010 users Guide.pdf	canon.slm	Waiting to print...	Cancel Print Next Pause
01/11/2020 10:44:00	ImageMaster Accessory 010 0101 - 01010 - 01010 - 01010 users Guide.pdf	canon.slm	Waiting to print...	Cancel Print Next Pause

a Function selection

Select the function that you want to check, and click [Display].

b Operation buttons

- [Cancel]: Copying or printing is canceled. The canceled document is deleted and cannot be recovered.
- [Print Next]: The document is output immediately after the current document is complete.
- [Pause]: Documents that are being printed from a computer are paused. You cannot pause documents that are being copied. Press [Resume] to resume printing a document that was paused.

c Document icon

Click the icon to display detailed information about the document.

Checking the Status of Sent/Received Documents

You can check the status of faxes and e-mails that are waiting to be sent, faxes that have been received, and faxes that are waiting to be forwarded. You can also cancel the process for sending and receiving documents.

Start the Remote UI ▶ [Status Monitor/Cancel] ▶ [Job Status] under [Send] or [Receive]

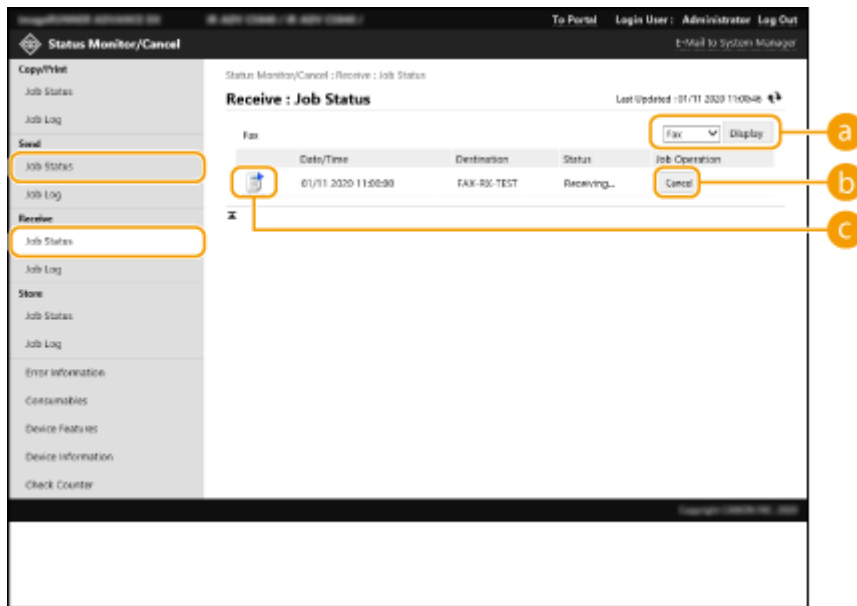

a Function selection

Select the function that you want to check, and click [Display].

b [Cancel]

Document sending or receiving is canceled. The canceled document is deleted and cannot be recovered.

c Document icon

Click the icon to display detailed information about the document.

Checking the Status of Stored Documents

You can check the status of documents that are waiting to be stored. You can also cancel the process for storing documents.



Start the Remote UI ► [Status Monitor/Cancel] ► [Job Status] under [Store]

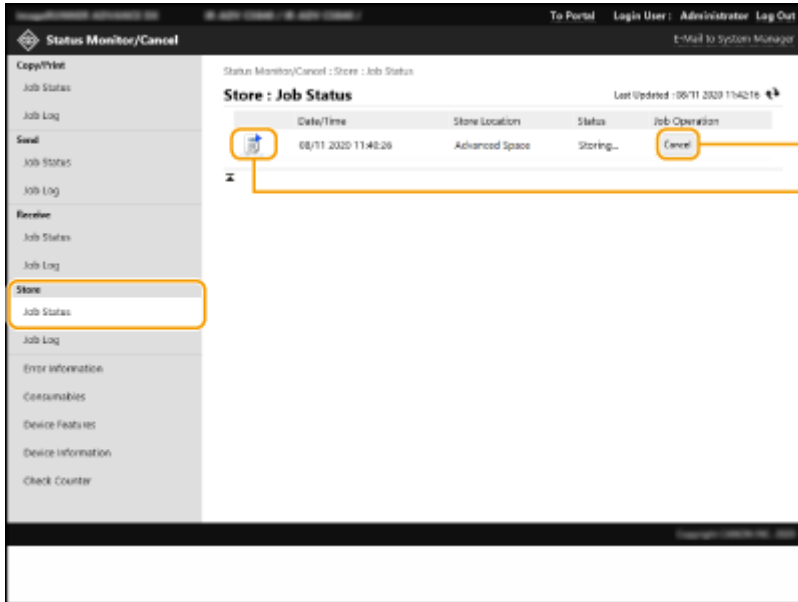

a [Cancel]

Document storing is canceled. The canceled document is deleted and cannot be recovered.

b Document icon

Click the icon to display detailed information about the document.

Checking the Job Log

You can display a log for documents that were copied, printed, sent, received, or stored.



Start the Remote UI ► [Status Monitor/Cancel] ► [Job Log]

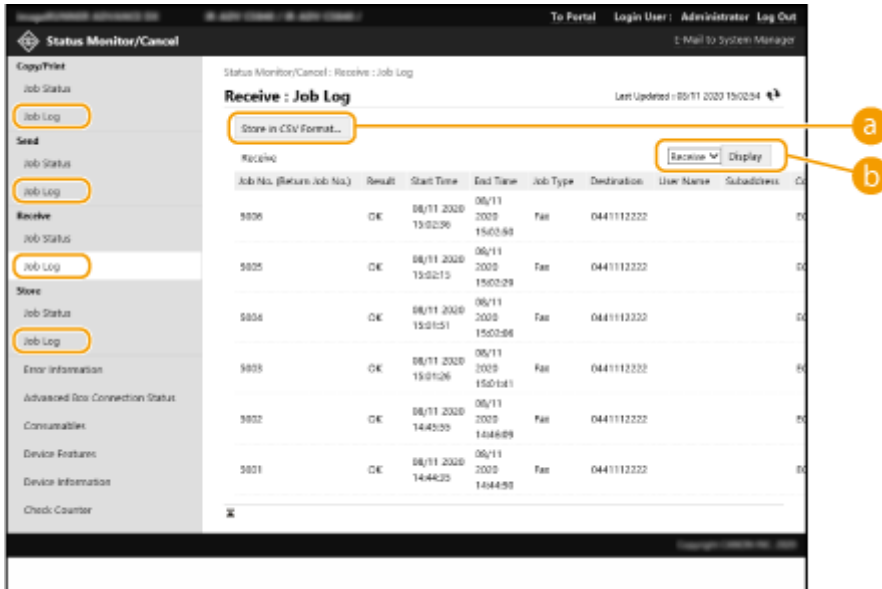

a [Store in CSV Format...]

The log data can be exported and saved as a CSV file (*.csv) on the computer.

b Function selection

Select the function that you want to check, and click [Display]. The displayed functions may vary depending on your machine model and optional equipment.

Checking the Machine Status

You can check a variety of information about the machine, such as error information, the amount of remaining paper and toner, information about attached optional equipment, and the total number of pages that have been printed up to now.



Start the Remote UI ▶ [Status Monitor/Cancel] ▶ Select the item that you want to check

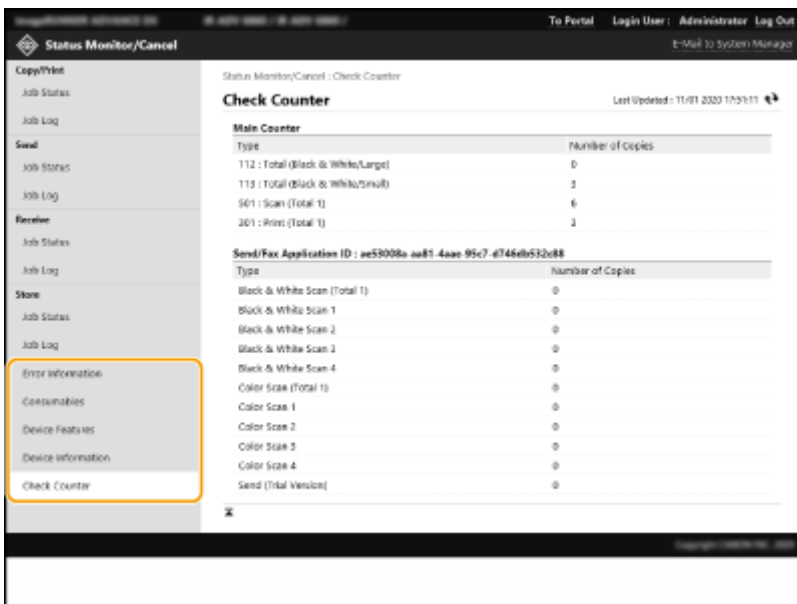

LINKS

▶ **Starting the Remote UI(P. 902)**

Turning OFF/Restarting the Machine

961F-0J3

You can use the Remote UI to shut down or restart the machine.

IMPORTANT

- When the machine is turned OFF or restarted, any documents that are being printed or sent are canceled.

 **Turning OFF the Machine(P. 911)**

 **Restarting the Machine(P. 911)**

Turning OFF the Machine



Start the Remote UI ▶ [Settings/Registration] ▶ [Device Management] ▶ [Remote Shutdown] ▶ [Start]

Restarting the Machine



Start the Remote UI ▶ [Settings/Registration] ▶ [Restart Device] ▶ [Perform Restart] ▶ [OK]

NOTE

If optional equipment is not recognized after restart

- The machine may not recognize optional equipment after it is restarted. If this happens, turn OFF the power of the optional equipment, and then turn it back ON.

LINKS

 **Starting the Remote UI(P. 902)**

 **Turning ON the Machine(P. 35)**

 **Turning OFF the Machine(P. 36)**

Registering Destinations via the Remote UI

961F-0J4

You can use the Remote UI to register destinations in the Address Book. You can also check the registered details and edit the Address Book.

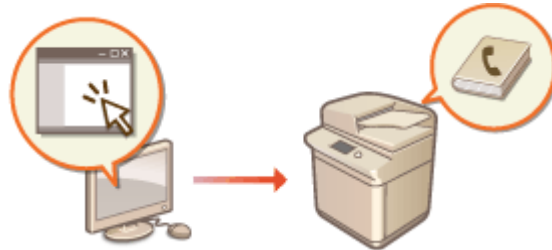

NOTE

- For instructions on sharing an address list, see [▶Sharing an Address List with Specific Users\(P. 916\)](#) .

1 Start the Remote UI. [▶Starting the Remote UI\(P. 902\)](#)

2 Click [Address Book] on the portal page. [▶Remote UI Screen\(P. 904\)](#)

3 Register the destination.

- For more information on address lists, see [▶Registering Destinations in the Address Book\(P. 394\)](#) .

- 1 Click the address list in which to register the destination ([Personal Address List], User Group Address Lists, [Address List 01] to [Address List 10], or [Address List for Administrators]).
 - [Personal Address List] is for the exclusive use of the logged-in user, and is only available when personal authentication management is enabled.
 - [Address List for Administrators] is only available to administrators who log in with Administrator or DeviceAdmin privileges.
 - If the page for entering a PIN is displayed, enter the PIN and click [OK].
 - If you want to share the destination with a registered user group, select a registered User Group Address List.

NOTE

- You can also manage User Group Address Lists by enabling only users with Administrator privileges to register/edit destinations from the Remote UI. [▶<Use User Group Address List>\(P. 1316\)](#)

2 Click [Register New Destination...].

3 Select the destination type and click [Set].

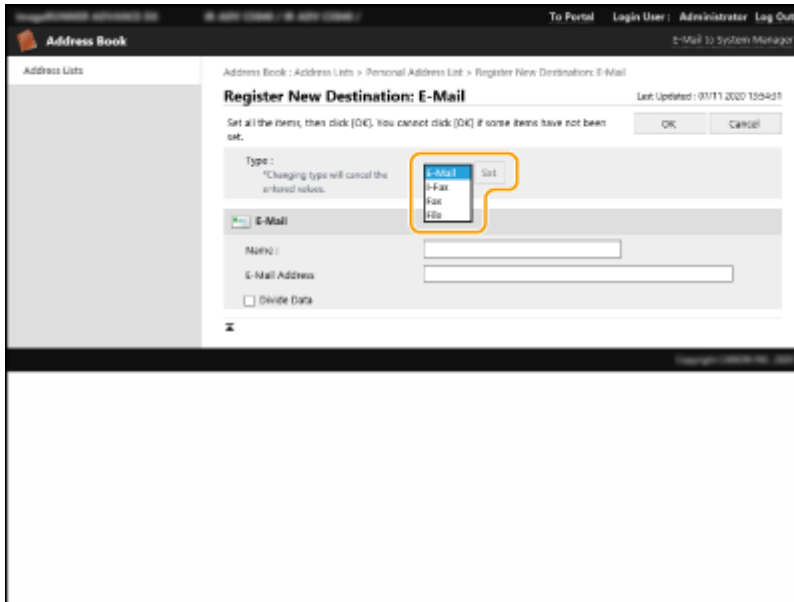

- 4 Register the necessary information and click [OK].
 - The displayed items vary depending on the destination type. For more information on the information to register, see [▶Registering Destinations in the Address Book\(P. 394\)](#) .

■Registering a group destination

For more information on group destinations, see [▶Registering Multiple Destinations as a Group\(P. 405\)](#) .

- 1 Click [Register New Group...].
- 2 Enter a name for the group in [Group Name], and click [Select Destination...] for [Member List].

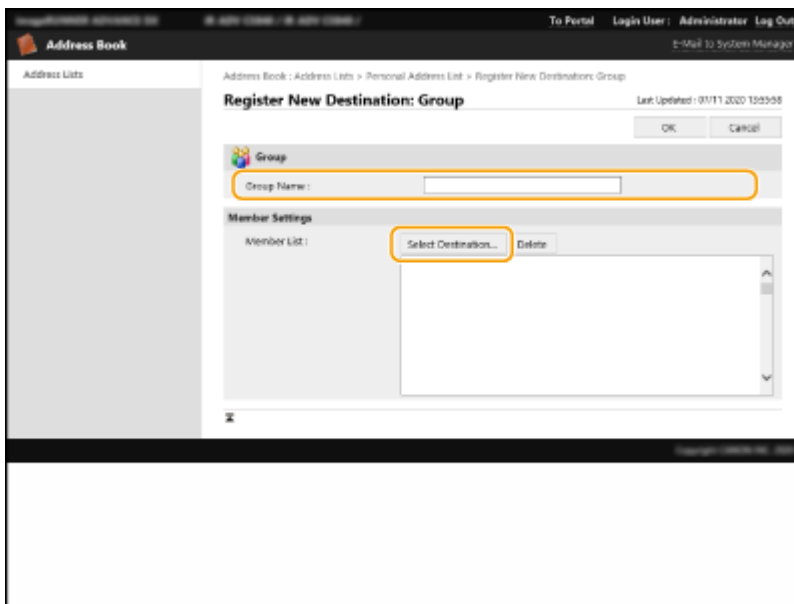

- 3 Select the check box for the destinations that you want to register to the group, and click [OK].
- 4 Click [OK].

■Registering a name for the address list

Click [Register Address List Name...] or [Register/Change Address List Name...], enter the name, and click [OK].

You can set to also change the name of the user group address book when a user group name is changed. Log in to the Remote UI as a user with Administrator privileges, press [Settings/Registration] ▶ [Set

Destination] ► [Personal Address List/User Group Address List Settings], and select the [Apply User Group Name Change to User Group Address List Name] check box. [Apply User Group Name Change to User Group Address List Name] is only available when personal authentication management is enabled.

■ Checking/editing destination details

You can click the [Type] icon or name of a destination to check the details of the destination. To edit the destination, click [Edit], change the registered details, and click [OK].

■ Registering to a user group address list

When using personal authentication management, an address list can be shared between users in the same user group. First, set up the user group that will share the address list, then register the destinations that you want to share.

NOTE

- Users can be registered to a user group to share the address lists in an address book between registered users. ► **Registering User Groups(P. 918)**

- 1 Click the address list in which to register the destination ([User Group Address List 01] to [User Group Address List 50]).
- 2 Click [Public View Settings...].
- 3 Select the check box for [Make Public].
- 4 Select the group in which to share the address list, and click [OK].

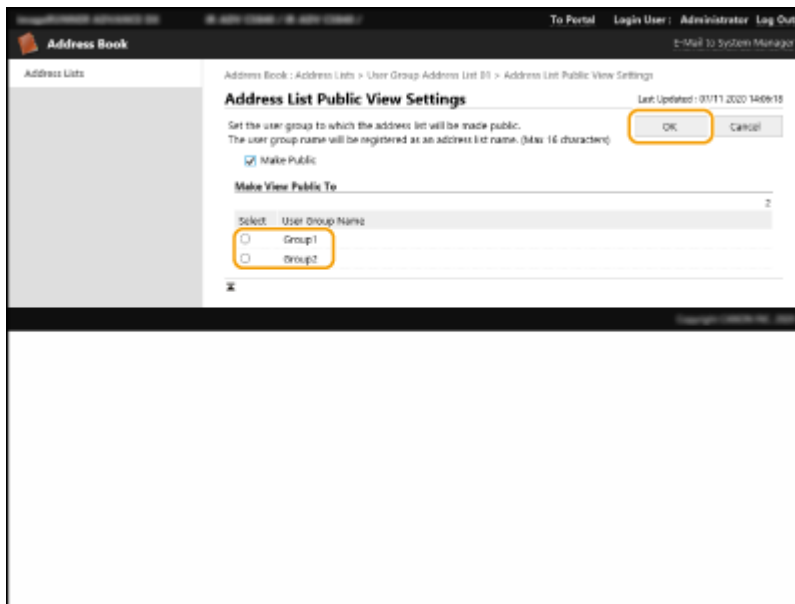

- 5 Click [Register New Destination...] or [Register New Group...].
- 6 Register the necessary information and click [OK].

■ Registering to a one-touch button

- 1 Click [Address List One-Touch].
- 2 Click [Not Registered] or an unregistered one-touch number.
 - [Not Registered] is displayed in [Name] for unregistered one-touch buttons.
 - To display one-touch buttons that are not shown in the list, select the range of numbers in [List Number], then click [Display].

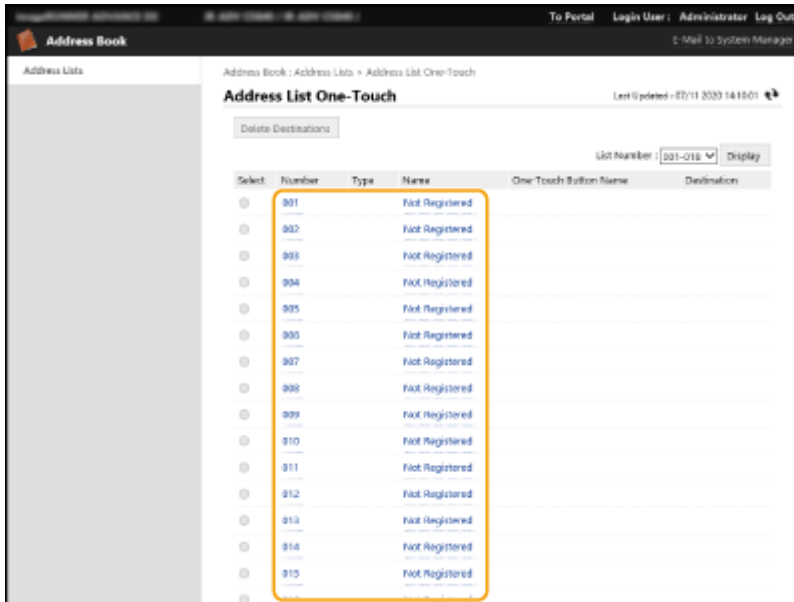

3 Select the destination type and click [Set].

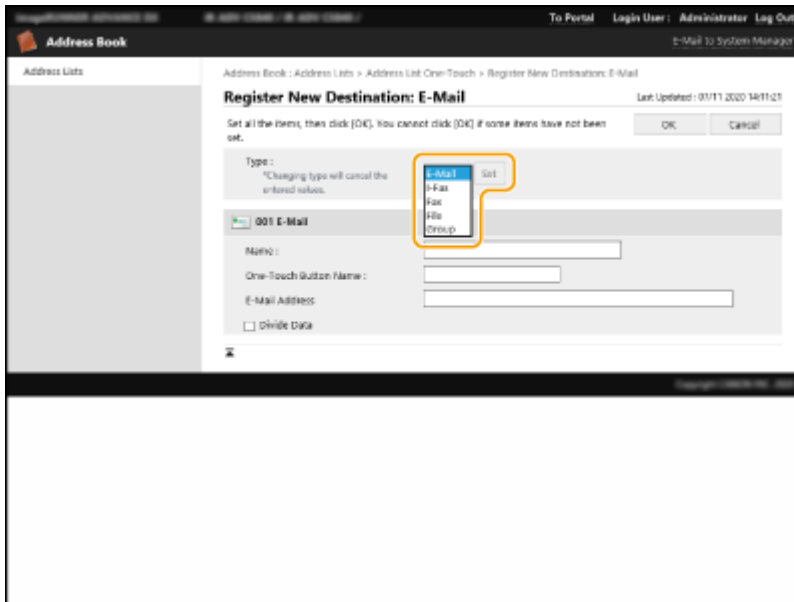

4 Register the necessary information and click [OK].

- For more information on the information to register, see [Registering a Destination in a One-Touch Button\(P. 410\)](#) .

LINKS

- [Registering Destinations\(P. 389\)](#)
- [Restricting Use of the Address Book\(P. 879\)](#)

Sharing an Address List with Specific Users

961F-0J5

You can use a user group address list to share an address list between specific users. This is useful when using a shared address list within the same department.

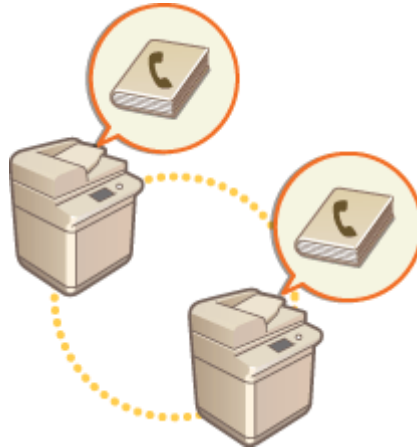

Procedure for Sharing Addresses

Follow the procedure below.

1



Registering Users.

- Register the users to share with. ▶ **Registering User Information in the Local Device(P. 809)**
If you are using Server Authentication, proceed to step 2.



2



Registering a Group to Share

- Register a user group. ▶ **Registering User Groups(P. 918)**



3



Setting the Group Share Destination

- Specify the group created in step 2 in [Public View Settings...] from the address list in which to register the destination. ▶ **Registering Destinations via the Remote UI(P. 912)**

NOTE

- To add new users to an existing group, set the destination group when registering the users in step 1.

Registering User Groups

961F-0J6

Register user groups. User group address lists can be shared between registered user groups.

- 1 Start the Remote UI. ▶ Starting the Remote UI(P. 902)
- 2 Click [Settings/Registration] on the portal page. ▶ Remote UI Screen(P. 904)
- 3 Click [User Management] ▶ [Authentication Management] ▶ [User Group Management].
- 4 Click [Add Group (Local Device Users)...] or [Add Group (Other Users)...].
 - Select [Add Group (Other Users)...] if Server Authentication is set.

■ Adding Groups to a Local Device

- 1 Enter the group ID and user group name.
- 2 Select the users to include in the user group, and click [Add >>].

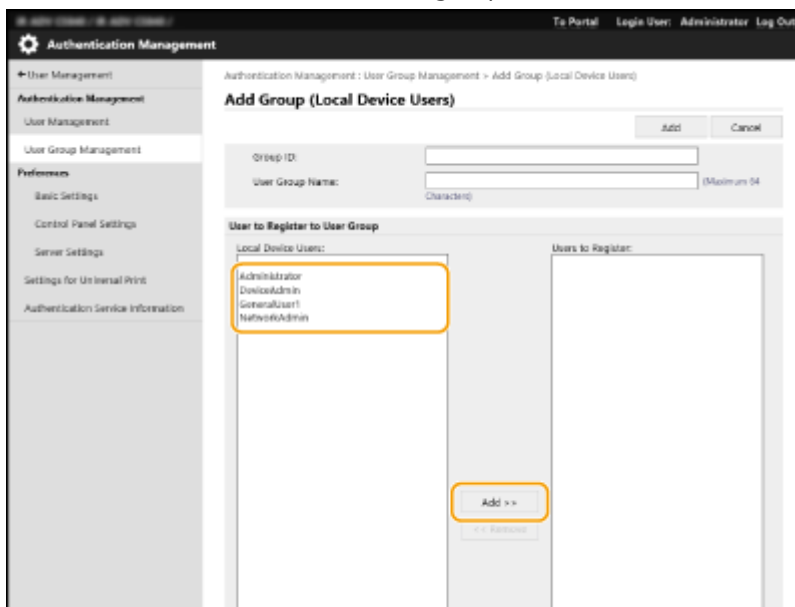

- 3 Click [Add].

■ Adding Groups to an Authentication Server

- 1 Enter the group ID, user group name, attribute name, and attribute value.
- 2 Click [Add].

NOTE

- For [Attribute Name:], enter the "Attribute Name" (such as company name, department or position) managed by the server authentication destination (ActiveDirectory, LDAP server, etc.). For example, enter "company" or "department".
- For [Attributes:], input the values you wish to extract as a group from the values listed for "Attribute Name" in the server. For example, you may enter "Company A" for the company name, and "Sales 1" for the department name.

Registering a Key and Certificate for Network Communication

961F-0J7

You can use the Remote UI to register keys/certificates, CA certificates, and S/MIME certificates to the machine from your computer. Designate an administrator to register these items.



- ▶ [Registering a Key and Certificate\(P. 920\)](#)
- ▶ [Registering a CA Certificate\(P. 921\)](#)
- ▶ [Registering an S/MIME Certificate\(P. 923\)](#)

NOTE

The communication methods listed below use a key/certificate or CA certificate. If you want to use a registered key and certificate in actual communication, you need to specify the key and certificate in the settings for each communication method. However, an X.509 DER format CA certificate does not need to be specified in the settings for each communication method. You can use it simply by registering it to the machine.

- TLS encrypted communication ▶ [Configuring the Key and Certificate for TLS\(P. 864\)](#)
- IPSec ▶ [Configuring the IPSec Settings\(P. 869\)](#)
- IEEE 802.1X ▶ [Configuring the IEEE 802.1X Authentication Settings\(P. 874\)](#)

Registering a Key and Certificate

Keys and certificates (server certificates) can be registered via the Remote UI. For information on the keys and certificates that can be registered on the machine, see ▶ [System Specifications\(P. 1577\)](#) .

- 1** Start the Remote UI. ▶ [Starting the Remote UI\(P. 902\)](#)
- 2** Click [Settings/Registration] on the portal page. ▶ [Remote UI Screen\(P. 904\)](#)
- 3** Click [Device Management] ▶ [Key and Certificate Settings].
- 4** Click [Register Key and Certificate...].
- 5** Click [Install...].
- 6** Install the key and certificate.

- Click [Browse...], specify the files (key and certificate) to install, and click [Start Installation].

7 Register the key and certificate.

- 1 Select the key and certificate that you want to register, and click [Register].
- 2 Enter the key name and password, and click [OK].

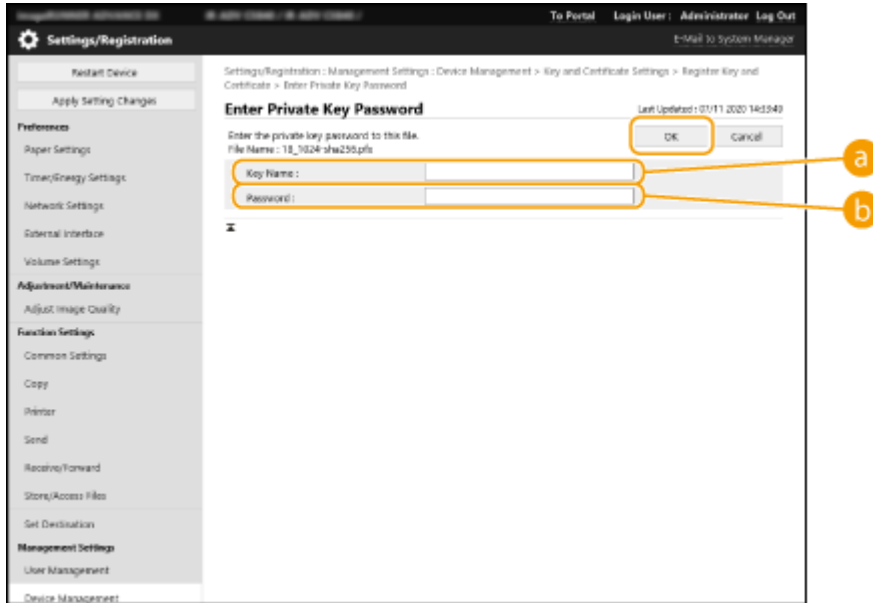

a [Key Name]

Use alphanumeric characters to enter the name of the key that was registered to the machine.



b [Password]

Use alphanumeric characters to enter the password of the private key that is set for the file to register.

NOTE

Managing keys and certificates

You can check the detailed settings or delete keys and certificates on the screen displayed in step 4.

- If  is displayed, the key is corrupted or invalid.
- If  is displayed, the certificate for the key does not exist.
- Click a key name to display detailed information about the certificate. You can also click [Verify Certificate] on this screen to check whether the certificate is valid.
- To delete a key and certificate, select the one that you want to delete, and click [Delete] ► [OK].

Registering a CA Certificate

X.509 DER format CA certificates are preinstalled in the machine. You can register a new CA certificate if it is required by a particular function. For information on the CA certificates that can be registered on the machine, see **System Specifications(P. 1577)** .

- 1 Start the Remote UI. **Starting the Remote UI(P. 902)**

2 Click [Settings/Registration] on the portal page. ▶ Remote UI Screen(P. 904)

3 Click [Device Management] ▶ [CA Certificate Settings].

4 Click [Register CA Certificate...].

5 Click [Install...].

6 Install the CA certificate.

- Click [Browse...], specify the file (CA certificate) to install, and click [Start Installation].

7 Register the CA certificate.

- Select the CA certificate that you want to register, and click [Register...].

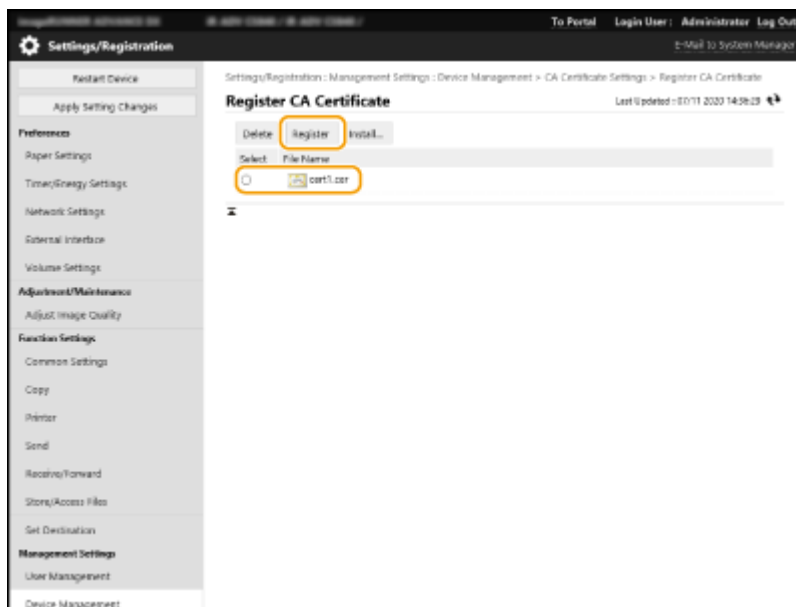

NOTE

Managing CA certificates

You can check the detailed settings or delete CA certificates on the screen displayed in step 4.

- Click  to display detailed information about the CA certificate. You can also click [Verify Certificate] on this screen to check whether the CA certificate is valid.
- To delete a CA certificate, select the one that you want to delete, and click [Delete] ▶ [OK].

Registering an S/MIME Certificate

You can register a public key certificate (S/MIME certificate) to use for encrypting e-mail/I-fax with S/MIME. For information on the S/MIME certificates that can be registered on the machine, see [▶System Specifications\(P. 1577\)](#) . For information on how to configure the S/MIME settings, see [▶<S/MIME Settings>\(P. 1241\)](#) .

- 1 Start the Remote UI.** [▶Starting the Remote UI\(P. 902\)](#)
- 2 Click [Settings/Registration] on the portal page.** [▶Remote UI Screen\(P. 904\)](#)
- 3 Click [Device Management] ▶ [S/MIME Certificate Settings].**
- 4 Click [Register S/MIME Certificate...].**
- 5 Register the S/MIME certificate.**
 - Click [Browse...], specify the file (S/MIME certificate) to register, and click [Register].

NOTE

Managing S/MIME certificates

You can check the detailed settings or delete S/MIME certificates on the screen displayed in step 4.

- Click  to display detailed information about the S/MIME certificate. You can also click [Verify Certificate] on this screen to check whether the S/MIME certificate is valid.
- To delete an S/MIME certificate, select the one that you want to delete, and click [Delete] ▶ [OK].

Configuring the Expiration Check Method for Received Certificates

961F-0J8

There are two methods for verifying whether certificates received from the other party in communication are valid: Comparing with the certificate revocation list (CRL) registered in the machine and querying an OCSP (online certificate status protocol) responder (a server that supports OCSP). Set the method for checking the expiration of certificates according to your environment. This registration can only be performed by the administrator.

- ▶ **Registering a Certificate Revocation List (CRL)(P. 924)**
- ▶ **Configuring the Online Certificate Status Protocol (OCSP)(P. 924)**

Registering a Certificate Revocation List (CRL)

You can use the Remote UI to register a certificate revocation list (CRL). For information on the CRLs that can be registered on the machine, see ▶ **System Specifications(P. 1577)** .

- 1 Start the Remote UI.** ▶ **Starting the Remote UI(P. 902)**
- 2 Click [Settings/Registration] on the portal page.** ▶ **Remote UI Screen(P. 904)**
- 3 Click [Device Management] ▶ [Certificate Revocation List (CRL) Settings].**
- 4 Click [Register CRL...].**
- 5 Register the CRL.**
 - Click [Browse...], specify the file (CRL) to register, and click [Register].

NOTE

Managing CRLs

You can check the detailed settings or delete CRLs on the screen displayed in step 4.

- Click  to display detailed information about it. You can also click [Verify CRL] on this screen to check whether the CRL is valid.
- To delete a CRL, select the one that you want to delete, and click [Delete] ▶ [OK].

Configuring the Online Certificate Status Protocol (OCSP)

You can configure the certificate verification level and the OCSP responder to connect to.

- 1 Start the Remote UI.** ▶ **Starting the Remote UI(P. 902)**

2 Click [Settings/Registration] on the portal page. ▶ Remote UI Screen(P. 904)

3 Click [Device Management] ▶ [OCSP (Online Certificate Status Protocol) Settings].

4 Select the check box for [Use OCSP (Online Certificate Status Protocol)], and configure the online certificate status protocol (OCSP).

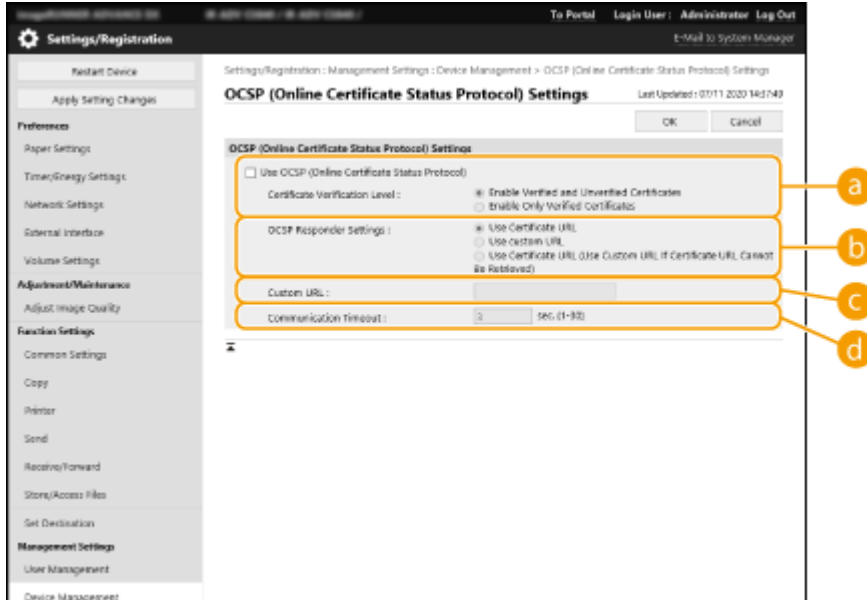

a [Certificate Verification Level]

Set whether to disable certificates in situations such as the following:

- When the machine cannot connect to the OCSP responder
- When a timeout occurs
- When expiration cannot be checked, such as when the result of checking the expiration of a certificate via the OCSP responder is unknown

b [OCSP Responder Settings]

Specify the URL for connecting to the OCSP responder.

c [Custom URL]

When [Use custom URL] or [Use Certificate URL (Use Custom URL If Certificate URL Cannot Be Retrieved)] is selected, enter the URL of the OCSP responder (ASCII code only, maximum 255 characters).

d [Communication Timeout]

Set the time until communication with the OCSP responder times out. The connection is canceled if there is no response from the OCSP responder within the set time.

5 Click [OK].

Generating a Key and Certificate Signing Request (CSR)

961F-0J9

Certificates generated on this machine do not have a CA signature, which may cause communication errors with some communication peers. To request a certificate with a CA signature, certificate signing request (CSR) data is required. A user who logs in with administrator privileges can generate a CSR.

- ▶ **Generating a Key and CSR(P. 926)**
- ▶ **Registering a Certificate to a Key(P. 927)**

Generating a Key and CSR

You can generate a key and CSR on the machine. You can also display the CSR data on the screen and export it as a file.

- 1 Start the Remote UI. ▶Starting the Remote UI(P. 902)**
- 2 Click [Settings/Registration] on the portal page. ▶Remote UI Screen(P. 904)**
- 3 Click [Device Management] ▶ [Key and Certificate Settings].**
- 4 Click [Generate Key...].**
- 5 Click [Key and Certificate Signing Request (CSR)].**
- 6 Configure the necessary items for the key and certificate.**

a [Key Name]

Enter a name for the key. Use a name that will be easy to find when displayed in a list.

b [Signature Algorithm]

Select the hash algorithm to use for the signature.

c [Key Algorithm]

Select the key algorithm, and specify the key length if [RSA] is selected, or specify the key type if [ECDSA] is selected.

d [Country/Region]

Select the country code from the list, or enter it directly.

e [State]/[City]

Enter the location.

f [Organization]/[Organization Unit]

Enter the organization name.

g [Common Name]

Enter the IP address or FQDN.

- When performing IPPS printing in a Windows environment, make sure to enter the machine's IP address.
- A DNS server is required in order to enter the FQDN of the machine. Enter the IP address if a DNS server is not used.

7 Click [OK].

⇒ The CSR data is displayed.

- If you want to save the CSR data to a file, click [Store in File] and specify the save location.

NOTE

- The key that generated the CSR is displayed on the key and certificate list screen, but you cannot use it by itself. To use this key, you need to register the certificate that is later issued based on the CSR. ▶ **Registering a Certificate to a Key(P. 927)**

Registering a Certificate to a Key

You can register the certificate that was applied for and issued based on the CSR.

- 1 Start the Remote UI. ▶ Starting the Remote UI(P. 902)**
- 2 Click [Settings/Registration] on the portal page. ▶ Remote UI Screen(P. 904)**
- 3 Click [Device Management] ▶ [Key and Certificate Settings].**
- 4 In the [Certificate] list, click  for the certificate that you want to register.**

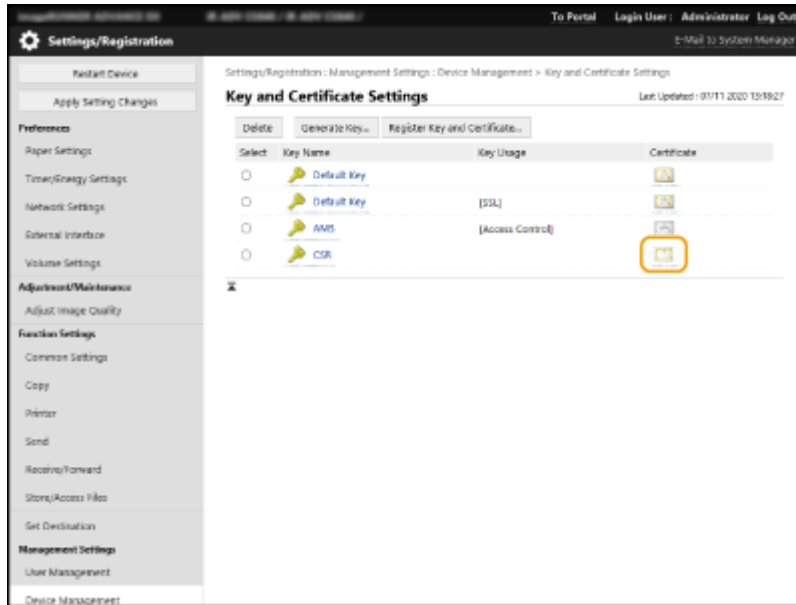

5 Click [Register Certificate...].

6 Register the certificate.

- Click [Browse...], specify the file (certificate) to register, and click [Register].

Retrieving/Updating a Certificate from an SCEP Server

961F-0JA

A request for issuing the certificate required for keys generated with the machine can be sent to an SCEP (Simple Certificate Enrollment Protocol) server that manages certificates. Certificates issued from the SCEP server are automatically registered to the machine. Administrator privileges are required to send a request for issuing a certificate.

- ▶ **Specifying the Communication Settings of the SCEP Server(P. 929)**
- ▶ **Requesting a Certificate to Be Issued(P. 930)**
- ▶ **Requesting a Certificate to Be Issued at the Specified Time(P. 931)**
- ▶ **Checking the Status of Requesting a Certificate to Be Issued(P. 933)**

Specifying the Communication Settings of the SCEP Server

You can specify the settings for communicating with the SCEP server.

- 1 Start the Remote UI. ▶Starting the Remote UI(P. 902)**
- 2 Click [Settings/Registration] on the portal page. ▶Remote UI Screen(P. 904)**
- 3 Click [Device Management] ▶ [Settings for Certificate Issuance Request (SCEP)].**
- 4 Click [Communication Settings].**
- 5 Set the required communication settings.**

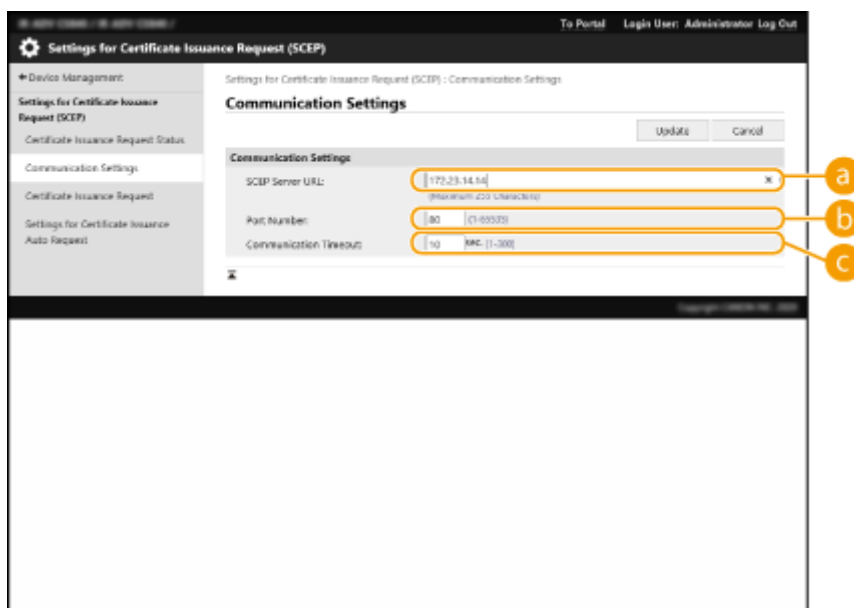

a [SCEP Server URL:]

Specify the URL of the SCEP server to connect to.

b [Port Number:]

Enter the port number to use for communicating with the SCEP server.

c [Communication Timeout:]

Enter the timeout time for communication with the SCEP server. The connection is canceled if there is no response from the SCEP server within the set time.

6 Click [Update].

NOTE

- The settings cannot be updated when [Enable Timer for Certificate Issuance Auto Request] is selected.
 - ▶ **Requesting a Certificate to Be Issued at the Specified Time(P. 931)**
- For information on the supported versions of SCEP, see ▶ **Management Functions(P. 1586)** .

Requesting a Certificate to Be Issued

You can manually request a certificate to be issued.

- 1 Start the Remote UI. ▶ Starting the Remote UI(P. 902)**
- 2 Click [Settings/Registration] on the portal page. ▶ Remote UI Screen(P. 904)**
- 3 Click [Device Management] ▶ [Settings for Certificate Issuance Request (SCEP)].**
- 4 Click [Certificate Issuance Request].**
- 5 Set the items required for requesting a certificate to be issued.**

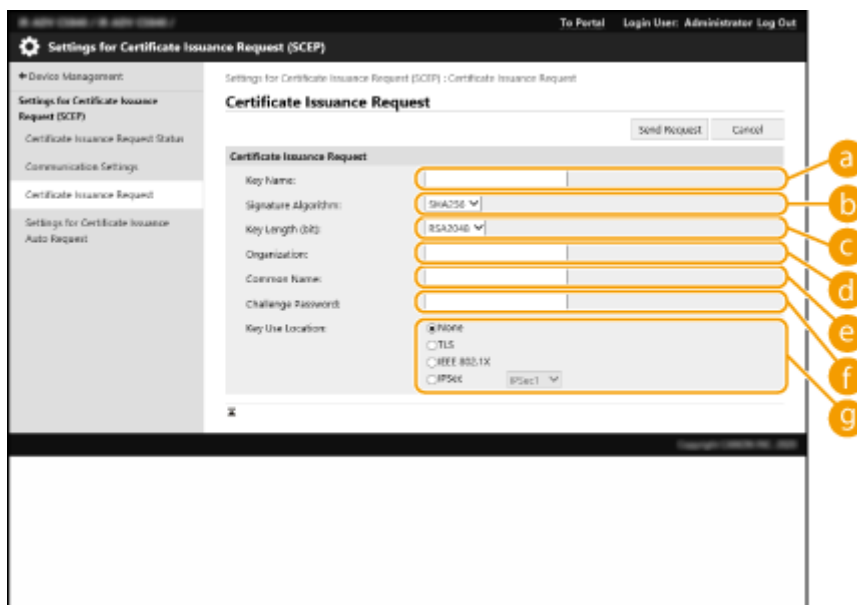

a [Key Name:]

Enter the name for the key. Enter a name that will be easy to find when displayed in a list.

b [Signature Algorithm:]

Select the hash function to use for the signature.

c [Key Length (bit):]

Select the key length.

d [Organization:]

Enter the organization name.

e [Common Name:]

Enter the IP address or FQDN.

- When performing IPPS printing in a Windows environment, make sure to enter the IP address of the machine.
- A DNS server is required to enter the FQDN of the machine. Enter the IP address of the machine if a DNS server is not used.

f [Challenge Password:]

When a password is set on the SCEP server side, enter the challenge password included in the request data (PKCS#9) for requesting a certificate to be issued.

g [Key Use Location:]

Select the destination where the key will be used. When [IPSec] is selected, select the IPSec of the destination from the drop-down list.

NOTE

- When selecting something other than [None], enable the various functions in advance. If a certificate is successfully obtained with the various functions disabled, the certificate is assigned as the destination, but the various functions are not automatically enabled.

6 Click [Send Request].**7 Click [Restart].****NOTE**

- A manual request for issuing a certificate cannot be sent when [Enable Timer for Certificate Issuance Auto Request] is selected. **▶ Requesting a Certificate to Be Issued at the Specified Time (P. 931)**
- The information set here is not saved to the storage of the machine.

Requesting a Certificate to Be Issued at the Specified Time

You can set to automatically request a certificate to be issued at a specified time.

1 Start the Remote UI. ▶ Starting the Remote UI (P. 902)**2 Click [Settings/Registration] on the portal page. ▶ Remote UI Screen (P. 904)**

3 Click [Device Management] ► [Settings for Certificate Issuance Request (SCEP)].

4 Click [Settings for Certificate Issuance Auto Request].

5 Set the items required for requesting a certificate to be issued.

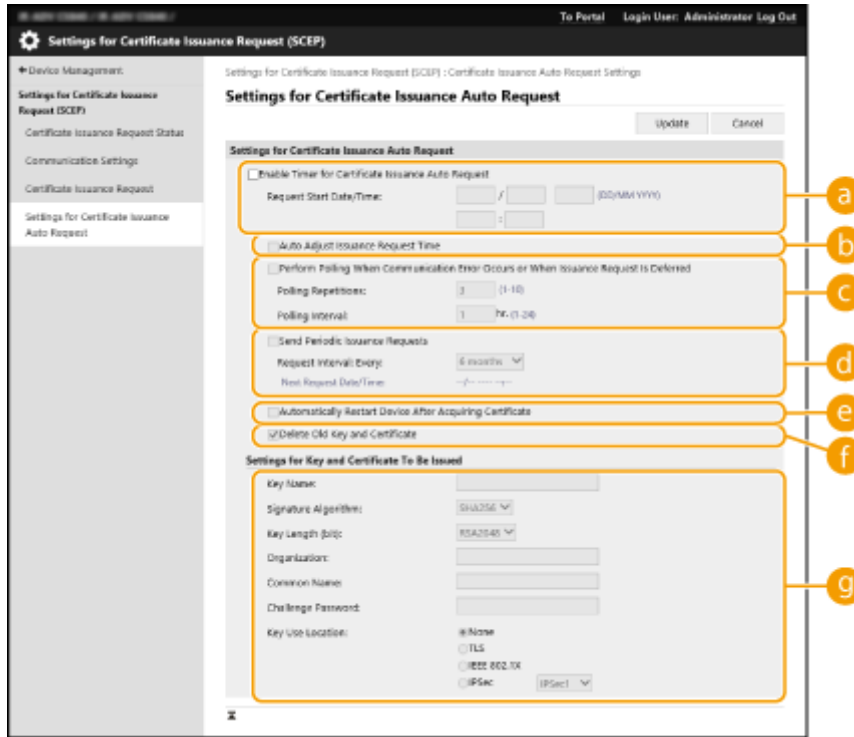

a [Enable Timer for Certificate Issuance Auto Request]

Select this to automatically request a certificate to be issued at a specified time, and specify the start date/time in [Request Start Date/Time:].

b [Auto Adjust Issuance Request Time]

Select this to adjust the time to send the request. This reduces load on the SCEP server when multiple multifunction printers send a request at the same time. The time is randomly adjusted 1 to 600 seconds from the time specified in [Request Start Date/Time:].

c [Perform Polling When Communication Error Occurs or When Issuance Request Is Deferred]

Select this to check the status of the SCEP server when a communication error has occurred or when a certificate issue request is pending. Specify the number of polling times and polling interval.

NOTE

- In the following cases, polling is not performed and an error occurs.
 - When the machine has exceeded the limit of keys and certificates it can hold
 - When an error is included in the retrieved response data
 - When an error occurs on the SCEP server side

d [Send Periodic Issuance Requests]

Select this to periodically send an automatic request for a certificate to be issued, and specify the interval in [Request Interval: Every:].

When an automatic request for a certificate to be issued is performed successfully, the next date/time to issue a request is displayed in [Next Request Date/Time:].

e [Automatically Restart Device After Acquiring Certificate]

Select this to restart the machine after the certificate is retrieved.

! IMPORTANT

- The machine is restarted even during batch importing/exporting.

f [Delete Old Key and Certificate]

Select this to overwrite the old key and certificate.

NOTE

- The key and certificate with the same destination for use are overwritten.
- The default key is not overwritten.

g [Settings for Key and Certificate To Be Issued]

Enter the information for the key to generate. For information on the settings, see step 5 of **Requesting a Certificate to Be Issued(P. 930)** .

6 Click [Update].

Checking the Status of Requesting a Certificate to Be Issued

The certificate requested and issued based on the CSR is registered in the key.



Start the Remote UI ► click [Settings/Registration] ► [Device Management] ► [Certificate Issuance Request Status].

- The following statuses are displayed in [Status].
 - [To Be Processed]: The next date/time to issue a request is displayed in [Request Date/Time].
 - [Processing...]: Polling is being performed.
 - [Error]: An error such as a communication error or key upper limit exceeded error has occurred.
 - [Successful]: The date/time that the certificate was successfully issued is displayed in [Request Date/Time].
- The information displayed in [Details] in [Error] is indicated below.

[Details]	Cause
Deferred	The pending status was returned from the SCEP server.
Key and Certificate Registration Limit Error	The limit to the number of keys and certificates that can be registered in the machine was reached.
Communication Error (TCP ERROR)	Connection to the SCEP server failed/a communication timeout occurred.
Communication Error (TCP ERROR <HTTP status code>)	An HTTP error occurred.
Communication Error (SCEP ERROR Fail Info 0)	Unrecognized or unsupported algorithm.
Communication Error (SCEP ERROR Fail Info 1)	Integrity check (meaning signature verification of the CMS message) failed.

[Details]	Cause
Communication Error (SCEP ERROR Fail Info 2)	Transaction not permitted or supported.
Communication Error (SCEP ERROR Fail Info 3)	The signingTime attribute from the CMS authenticatedAttributes was not sufficiently close to the system time.
Communication Error (SCEP ERROR Fail Info 4)	No certificate could be identified matching the provided criteria.

NOTE

- History for the last 20 certificates is displayed. When the number of certificates exceeds 20, the oldest information is overwritten.
- This setting can be imported/exported with models that support batch importing of this setting. [▶ Importing/Exporting the Setting Data\(P. 946\)](#)
- When performing batch exporting, this setting is included in [Settings/Registration Basic Information]. [▶ Importing/Exporting All Settings\(P. 950\)](#)

LINKS

- ▶ [Configuring the Key and Certificate for TLS\(P. 864\)](#)
- ▶ [Configuring the IEEE 802.1X Authentication Settings\(P. 874\)](#)
- ▶ [Configuring the IPSec Settings\(P. 869\)](#)

Managing Stored Files



You can use the Remote UI to print, send, or delete files that are stored in the Mail Box, or faxes and I-faxes that are temporarily stored in the Fax/I-Fax Inbox.

- ▶ **Managing Files Stored in a Mail Box(P. 935)**
- ▶ **Managing Documents Temporarily Stored in Memory RX Inbox(P. 938)**
- ▶ **Managing Documents Temporarily Stored in Confidential Fax Inbox(P. 939)**

Managing Files Stored in a Mail Box

You can print or send documents that are stored in a Mail Box. You can also edit stored documents by deleting specific pages.

- 1 Start the Remote UI. ▶Starting the Remote UI(P. 902)**
- 2 Click [Access Received/Stored Files] on the portal page. ▶Remote UI Screen(P. 904)**
- 3 On the [Mail Box] page, click the number of the desired Mail Box.**
 - If the page for entering a PIN is displayed, enter the PIN and click [OK].
 - You can also specify a Mail Box by entering its number in [Box Number (00-99)] and clicking [Open...].

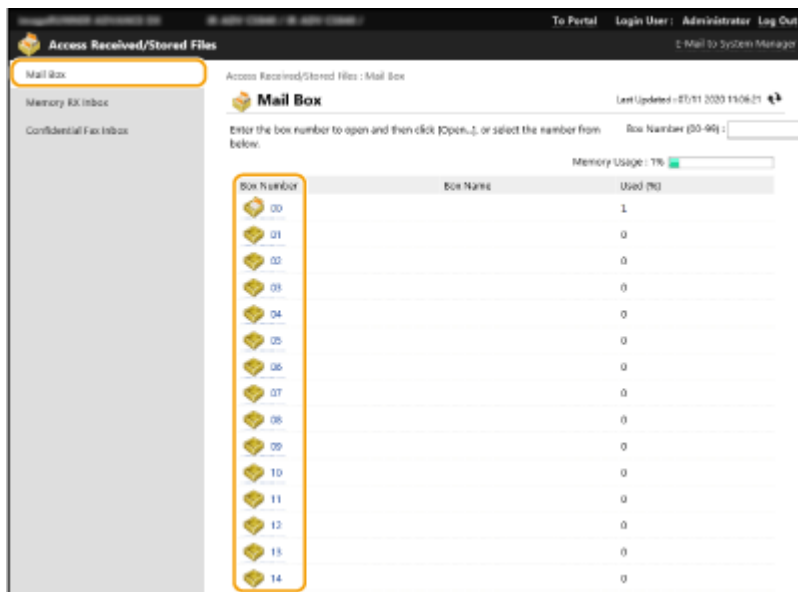

- 4 Specify the file to manage, and perform the desired operation.**
 - You can click the [Type] icon or file name to display the file details.
 - You can click [Print List] to print a list of the files in the Mail Box.

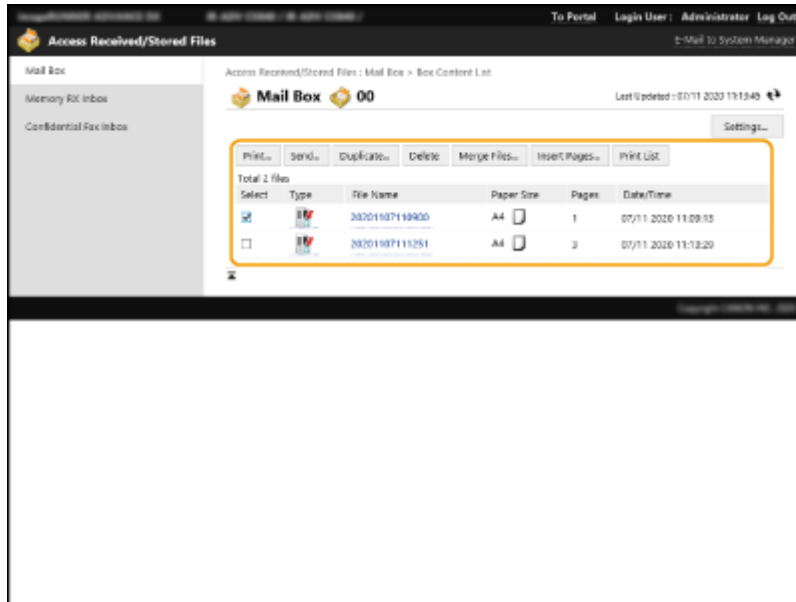

■ Printing a file

- 1 Select the check box for a file that you want to print, and click [Print...].
 - You can select multiple files.
- 2 Click [Start Printing].
 - You can click [Move to Top], [Move Up], [Move Down], or [Move to Bottom] to change the order in which files are printed.
 - You can click [Change Print Settings...] to change the print settings.
 - If you select the check box for [Delete File After Printing], files are automatically deleted after they are printed.

■ Sending a file

- 1 Select the check box for a file that you want to send, and click [Send...].
 - You can select multiple files.
- 2 Click [Select Destination...], select the destination, and click [OK].
 - You can click [Move to Top], [Move Up], [Move Down], or [Move to Bottom] to change the order in which files are sent.
 - You can click [Settings...] in [Set Details] to change the send settings. You can also change detailed settings of the file in [File Settings].
(For detailed information on the settings, see [▶ Scanning\(P. 635\)](#) . However, note that some of the settings included cannot be set in this procedure.)
 - If you select the check box for [Delete File After Sending], files are automatically deleted after they are sent.
- 3 Click [OK].

■ Merging multiple files into one

- 1 Select the check box for all of the files that you want to merge.
- 2 Click [Merge Files...] and enter a file name in [File Name].

- You can click [Move to Top], [Move Up], [Move Down], or [Move to Bottom] to change the order in which files are merged.

3 Click [Start].

■ Inserting a file into another file

- 1** Select the check box for the file that you want to insert the second file into, and click [Insert Pages...].
- 2** Select the file to insert, and click [Next].
- 3** Enter the new file name in [File Name After Insertion], and specify the insertion location (page) in [Select Insertion Location].
 - The file is inserted before the page specified in [Select Insertion Location].
- 4** Click [Insert].

■ Duplicating a file in another Mail Box

- 1** Select the check box for a file that you want to duplicate, and click [Duplicate...].
- 2** Select the number of the destination Mail Box in [Target Box], and click [Start].

■ Changing a file name

- 1** Click a [Type] icon or file name.
- 2** Click [Change File Name...], enter the new name in [File Name], and click [OK].

■ Deleting pages from a file

- 1** Click a [Type] icon or file name.
- 2** Select the check box for the pages that you want to delete, and click [Delete Page] ► [OK].
 - You can also click [Delete Pages Consecutively...] and specify a range of pages to delete.

■ Deleting a file

- 1** Select the check box for the file that you want to delete.
- 2** Click [Delete] ► [OK].

NOTE

To change the settings of a Mail Box

- You can click [Settings...] on the screen displayed in step 4 to change the name and PIN for the selected Mail Box. **► Specifying the Mail Box Settings(P. 737)**

Managing Documents Temporarily Stored in Memory RX Inbox

You can print or forward faxes and I-faxes that are temporarily stored in the Memory RX Inbox using Memory Lock.

- 1 Start the Remote UI.** ▶ Starting the Remote UI(P. 902)
- 2 Click [Access Received/Stored Files] on the portal page.** ▶ Remote UI Screen(P. 904)
- 3 Select [Memory RX Inbox] and click [Memory RX Inbox].**
 - If the page for entering a PIN is displayed, enter the PIN and click [OK].
- 4 Select the document and perform the desired operation.**
 - Click the [Type] icon to display detailed information about the document.

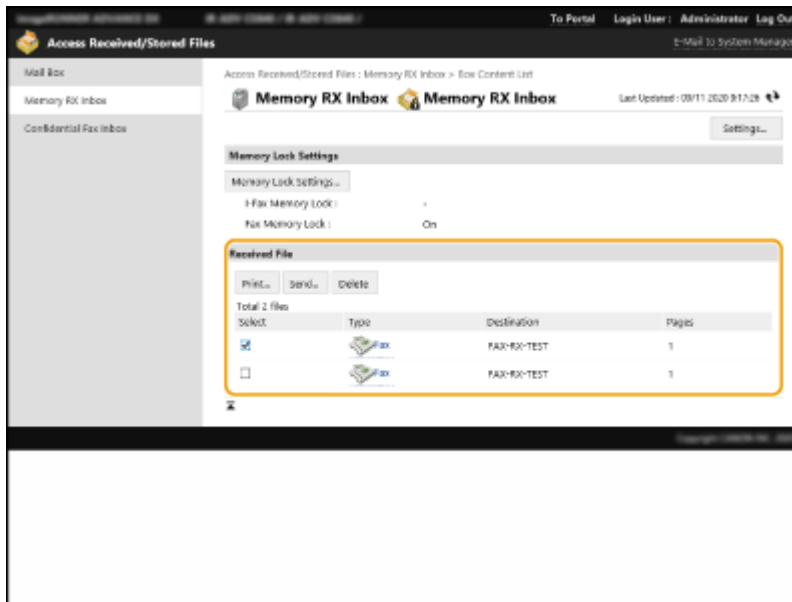

■ Printing a document

- 1** Select the check box for a document that you want to print, and click [Print...].
 - You can select multiple documents.
- 2** Click [Start Printing].
 - Documents are automatically deleted after they are printed.

■ Forwarding a document

- 1** Select the check box for a document that you want to forward, and click [Send...].
 - You can select multiple documents.
- 2** Click [Select Destination], select the destination, and click [OK].

- You can click [Move to Top], [Move Up], [Move Down], or [Move to Bottom] to change the order in which the files are forwarded.
- You can click [Settings...] in [Set Details] to change the send settings. You can also change detailed settings of the file in [File Settings].
(For detailed information on the settings, see **▶ Scanning(P. 635)** . However, note that some of the settings included cannot be set in this procedure.)
- If you select the check box for [Delete File After Sending], documents are automatically deleted after they are forwarded.

3 Click [OK].

■ Deleting a file

- 1** Select the check box for the file that you want to delete.
- 2** Click [Delete] ▶ [OK].

NOTE

To check I-faxes that were divided when received

- Click [Divided Data RX Inbox] on the screen displayed in step 3 to display a list of I-faxes that were divided when received. **▶ Receiving I-Faxes(P. 591)**

To set a PIN for Memory RX Inbox

- You can change the PIN for the Memory RX Inbox by clicking [Settings...] on the screen displayed in step 4 and adding a check mark to [Set PIN].

To configure Memory Lock settings

- You can set whether to receive faxes and I-faxes in the Memory RX Inbox by clicking [Memory Lock Settings...] on the screen displayed in step 4.

Managing Documents Temporarily Stored in Confidential Fax Inbox

You can print or delete faxes and I-faxes that are temporarily stored in the Confidential Fax Inbox.

- 1 Start the Remote UI.** **▶ Starting the Remote UI(P. 902)**
- 2 Click [Access Received/Stored Files] on the portal page.** **▶ Remote UI Screen(P. 904)**
- 3 Select [Confidential Fax Inbox] and click the number of the desired Confidential Fax Inbox.**
 - If the page for entering a PIN is displayed, enter the PIN and click [OK].
 - You can also specify a Confidential Fax Inbox by entering its number in [Box Number (00-49)] and clicking [Open...].
- 4 Select the document and perform the desired operation.**

- Click the [Type] icon to display detailed information about the document.

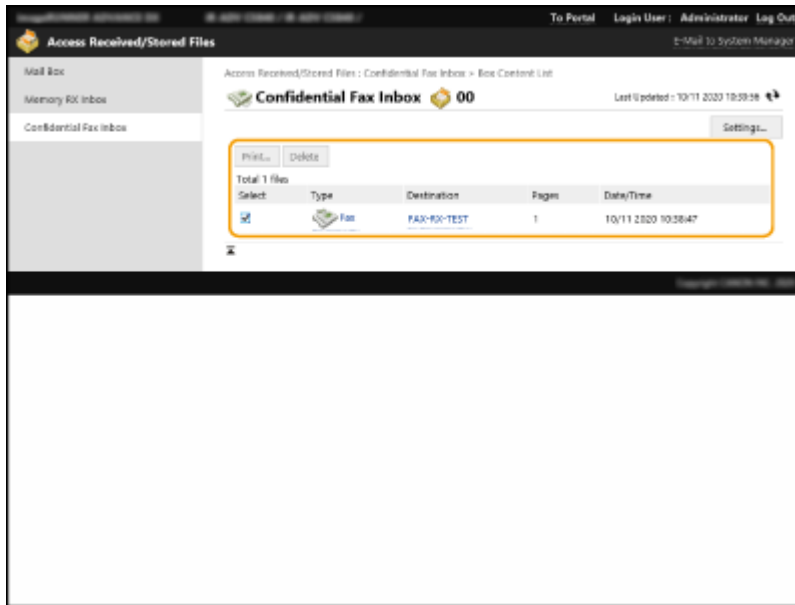

■ Printing a document

- 1 Select the check box for a document that you want to print, and click [Print...].
 - You can select multiple documents.
- 2 Click [Start Printing].
 - If you select the check box for [Delete File After Printing], documents are automatically deleted after they are printed.

■ Deleting a file

- 1 Select the check box for the file that you want to delete.
- 2 Click [Delete] ► [OK].

NOTE

To change the settings of a Confidential Fax Inbox

- You can change the name and PIN for the selected Confidential Fax Inbox by clicking [Settings...] on the screen displayed in step 4.

LINKS

- ▶ Making Simple Edits to Files(P. 724)
- ▶ Saving Received Documents in the Machine (Memory Reception)(P. 566)
- ▶ Keeping Received Documents Private(P. 569)
- ▶ <Set Fax/I-Fax Inbox>(P. 1273)

Managing the Logs

961F-0JE

You can use the logs to check or analyze how the machine is being used. A variety of information about each operation is recorded in the logs, such as the operation date/time, user name, operation type, function type, and operation result. For more information on the types of logs, see [System Specifications\(P. 1577\)](#) . Administrator privileges are required in order to manage the logs.



- ▶ [Starting Log Recording\(P. 941\)](#)
- ▶ [Exporting Logs Automatically\(P. 942\)](#)
- ▶ [Exporting a Log as a File\(P. 943\)](#)
- ▶ [Deleting the Logs\(P. 944\)](#)
- ▶ [Sending Logs via the Syslog Protocol\(P. 944\)](#)

! IMPORTANT

- If Audit Log Collection is enabled and an error occurs in the storage device managed by this function, initialization is automatically performed and then an error screen appears.
- If you can obtain the audit log from before the error occurred, click [Download Audit Log] to obtain the log, and then click [OK].
- If you cannot obtain the audit log from before the error occurred, click [OK].
- When initialization is completed, Audit Log Collection is resumed, and the automatic initialization process is recorded in the log.

Starting Log Recording

Follow the procedure below to start recording logs.



Start the Remote UI ▶ [Settings/Registration] ▶ [Device Management] ▶ [Export/Clear Audit Log] ▶ [Audit Log Information] ▶ Click [Start] for [Audit Log Collection]

NOTE

- If Sleep Mode Energy Use is set to [Low], logs are not collected when the machine enters the Sleep mode.
- When generating a network connection log, mail box authentication log, mail box document operation log, or machine management log, click [Device Management] ▶ [Save Audit Log] ▶ select the check box for [Save Audit Log] ▶ click [OK] ▶ [Apply Setting Changes].

- When generating an Advanced Space operation log, click [Function Settings] ▶ [Store/Access Files] ▶ [Advanced Space Settings] ▶ [Set Details] ▶ select the check box for [Save Operation Log] ▶ click [OK] ▶ [Apply Setting Changes].
- If the power of the machine is turned OFF while collecting logs due to a power outage, etc., collection starts again when the machine restarts, from the log that was being collected before the power turned OFF.
- If you stop log collection while logs are being collected, the logs for the period that log collection was stopped are not collected when log collection is next started.

Exporting Logs Automatically

You can set the machine to automatically export audit logs to a specified folder at a predetermined time each day, or when the number of audit logs reaches 95% of the maximum number (approximately 38,000).

- 1 Start the Remote UI. ▶Starting the Remote UI(P. 902)**
- 2 Click [Settings/Registration] on the portal page. ▶Remote UI Screen(P. 904)**
- 3 Click [Device Management] ▶ [Export/Clear Audit Log] ▶ [Settings for Auto Export Audit Logs].**
- 4 Select the check box for [Use Auto Export] and specify the required settings.**

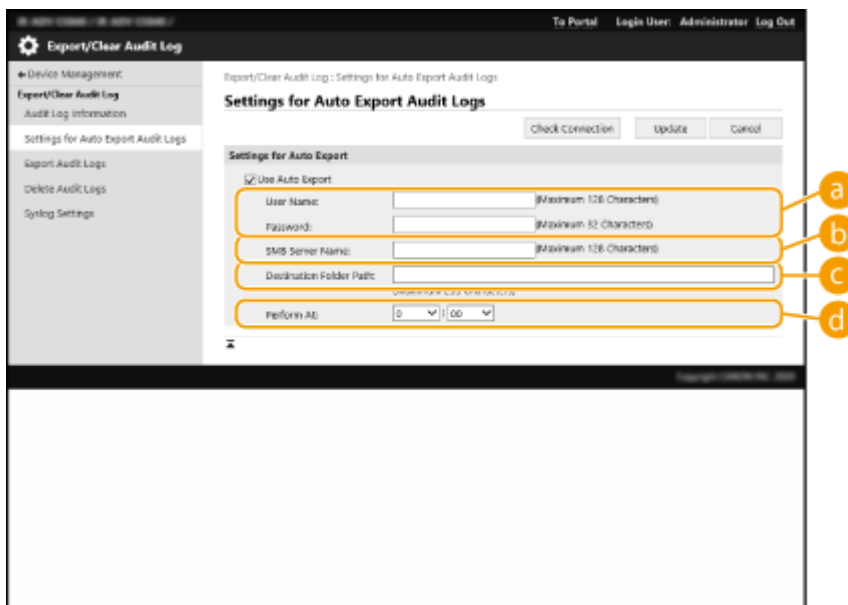

a [User Name:] / [Password:]

Enter the user name and password necessary for logging into a server to which logs are exported.

b [SMB Server Name:]

Enter the host name of the SMB server to export log files to, along with the path that requires authentication.

- \\Host Name
- \\IP Address\Shared Folder Name

c [Destination Folder Path:]

Enter the path for the folder in which to store the log files.

d [Perform At:]

You can specify the time at which to perform exporting.

5 Click [Check Connection], confirm that you can connect, and then click [Update].

- Audit logs will now be automatically exported. The file extension is ".csv."

NOTE

- After automatic exporting of the audit logs has succeeded, the collected audit logs are automatically deleted. Audit logs cannot be deleted manually.
- After automatic exporting and deleting of the audit logs have succeeded, each log is generated. If other log collections do not occur by the next automatic export time, the audit log will not be automatically exported.
- You can also manually export audit logs from the Remote UI. **▶ Exporting a Log as a File(P. 943)**
- If automatic exporting fails, the machine will retry multiple times. An error message is displayed on the control panel of the machine if automatic exporting fails even once.
- Specify an SMB server for Windows Server 2012 or later, or Windows 8 or later.
- If the machine is turned OFF, exporting will not be performed, even at the specified time. Also, it will not be performed when the machine recovers.
- If the machine is in the Sleep mode, it will automatically recover and perform exporting at the specified time.
- Note that if you are using a server that does not support SMB 3.0/3.1 encrypted communication, audit log data travels unencrypted across communication paths while it is being automatically exported.
- Depending on your environment, automatic exporting of logs may be performed later than the specified time.

6 Follow the instructions on the screen to specify the location to store the files.

⇒ The csv files are stored.

Exporting a Log as a File

The various logs can be exported and saved to a computer as CSV files, which can be opened using a CSV file editor or a text editor.

! IMPORTANT

- When exporting logs as files, use TLS or IPsec. **▶ Configuring the IPsec Settings(P. 869)**



Start the Remote UI ▶ [Settings/Registration] ▶ [Device Management] ▶ [Export/Clear Audit Log] ▶ [Export Audit Logs] ▶ [Export] ▶ Follow the on-screen instructions to save the file

- If you want to automatically delete all logs after they are exported, select the check box for [Delete logs from device after export] before clicking [Export]. If you then click [Cancel], exporting is canceled and the logs are deleted, even if they were not finished being exported as files.
- Log collection is stopped while the export process is being performed.

Deleting the Logs

You can delete all of the collected logs.



Start the Remote UI ▶ [Settings/Registration] ▶ [Device Management] ▶ [Export/Clear Audit Log] ▶ [Delete Audit Logs] ▶ [Delete] ▶ [Yes]

NOTE

- If [Settings for Auto Export Audit Logs] is enabled, you cannot manually delete audit logs.

Sending Logs via the Syslog Protocol

Syslog Information can be sent to an SIEM (security information/event management) system. Linking with an SIEM system enables various information analyzed from realtime alert information to be centrally managed.

- 1 Start the Remote UI. ▶ Starting the Remote UI(P. 902)
- 2 Click [Settings/Registration] on the portal page. ▶ Remote UI Screen(P. 904)
- 3 Click [Device Management] ▶ [Export/Clear Audit Log] ▶ [Syslog Settings].
- 4 Select [Use Syslog Send], and specify the required settings.

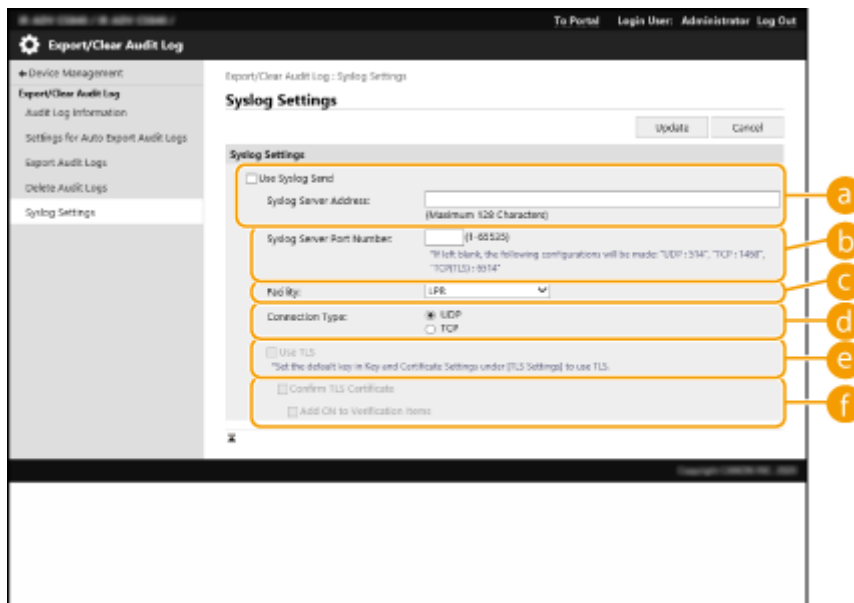

a [Syslog Server Address:]

Specify the address of the Syslog server to connect to. Enter the necessary information, such as IP address and host name, according to your environment.

b [Syslog Server Port Number:]

Enter the port number used by the Syslog server for Syslog communication. If left blank, the port number defined in RFC (UDP: 514, TCP: 1468, TCP (TLS): 6514) is used.

c [Facility:]

Specify the type of log messages to send. Select one of the following: [Local0] to [Local7], [Log Alert], [Log Audit], [Security Messages], or [LPR] defined in RFC.

d [Connection Type:]

Specify the communication type ([UDP]/[TCP]).

e [Use TLS]

Select this to use TLS to encrypt information communicated with the Syslog server.

NOTE

- When [TCP] is selected in [Connection Type:], you can set to use TLS.

f [Confirm TLS Certificate]/[Add CN to Verification Items]

Set whether to verify the TLS server certificate sent when connecting and its CN (Common Name).

5 Click [Update].**NOTE**

- A slight time lag occurs after the error for some audit logs, because Syslog transmission is performed after polling every 30 seconds.
- The supported RFCs are 5424 (Syslog format), 5425 (TLS), and 5426 (UDP).

LINKS

▶ **Starting the Remote UI(P. 902)**

▶ **Configuring the Key and Certificate for TLS(P. 864)**

Importing/Exporting the Setting Data

961F-0JF

Machine data such as Address Book destinations, user setting information, and various setting values can be exported and saved to a computer. Exported data can also be imported into the machine from a computer. Data exported from the machine can be imported into other Canon multifunction printers, making it easier to configure the settings on a new machine, such as when you purchase a replacement. For more information on the setting items that can be imported, see **▶Settings/Registration(P. 1054)** . When importing or exporting, you can specify whether to import or export all of the machine data, or only particular data.



▶**Importing/Exporting All Settings(P. 950)**

▶**Importing/Exporting the Settings Individually(P. 954)**

! IMPORTANT

Designate an administrator to manage operations

- Designate an administrator with Administrator privileges to perform data import/export operations. When data is imported, Address Book information, user settings, network settings, and other data are overwritten, which may prevent some functions from working properly or cause problems with machine operation. Exercise caution when importing data.

Do not turn OFF the machine until importing or exporting is complete

- It may take several minutes for the process to complete. Do not turn OFF the machine before the process is complete. Doing so may result in data loss or cause the machine to malfunction.
- The following functions/processes cannot be carried out while importing/exporting data:
 - Send jobs
 - Forwarding jobs
 - Fax/I-fax jobs
 - Report print jobs
 - Scan and Store in Advanced Space/Network/Memory Media (during scanning or storing)
 - Individual Importing/Individual Exporting
 - Device Information Delivery
 - Mail Box Backup
 - Batch Importing/Batch Exporting
 - Importing/Exporting from/to the iW Function Flow
 - Importing/Exporting Personal button/Shared button
 - Update process for the Register/Update Software function
 - Synchronizing Custom Settings*
 - Operating from the touch panel display of the machine
 - Operating from the Remote UI
 - Retrieving Web page content with the Web Access
 - Displaying the error screen of the Web Access
 - Using the Remote Address Book

- Putting the machine to the sleep mode

* If the settings are being synchronized (including when currently being paused/entering a paused state), the synchronization process of data related to personalized setting values, and group management data is paused.

- Importing/exporting data cannot be performed while the following functions/processes are being carried out:
 - Send jobs
 - Forwarding jobs
 - Fax/I-fax jobs
 - Report print jobs
 - Scan and Store in Advanced Space/Network/Memory Media (during scanning or storing)
 - Individual Importing/Individual Exporting
 - Device Information Delivery
 - Mail Box Backup
 - Batch Importing/Batch Exporting
 - Importing/Exporting from/to the iW Function Flow
 - Importing/Exporting Personal button/Shared button
 - Update process for the Register/Update Software function
 - Synchronizing Custom Settings*
 - Retrieving Web page content with the Web Access
 - Displaying the error screen of the Web Access
 - Using the Remote Address Book
 - Processing the shutdown of the machine
 - Displaying error code

* If the settings are being synchronized (including when currently being paused/entering a paused state), you cannot import/export data related to personalized setting values, and group management data.

Do not import or export in different display languages

- If the display language differs between the exporting machine and the importing machine, the setting values may corrupt, causing malfunction of the machine.

Do not edit exported files.

- Do not open and edit exported XML files, as this may cause the machine to malfunction.

NOTE

When importing to a Canon multifunction printer other than this machine

- Some settings may not be imported. **▶Settings/Registration(P. 1054)**

When using a password to protect the security policy settings

- The security policy settings can only be imported if the security policy setting password on the exporting machine matches that of the importing machine, or if no password has been set for the importing machine. If no password has been set for the importing machine, the password configured for the exporting machine is set to the importing machine.

When synchronizing custom settings

- If synchronization of custom settings (client) is started, the importing and exporting of data subject to synchronization (including the Address Book) become restricted. For information on synchronization of custom settings, see **▶Synchronizing Settings for Multiple Canon Multifunction Printers(P. 988)** . For information on the data subject to synchronization of custom settings, see **▶List of Items That Can Be**

Personalized(P. 357) . For information on conditions and restrictions when importing and exporting during synchronization of custom settings, see **▶Conditions for Removing Restrictions on the Importing/Exporting of Settings and Other Items(P. 948)** .

Importing Data after Starting Synchronization of Custom Settings (Client)

Follow the procedure below to import the data, and then synchronize the data.

- 1 Stop synchronization of custom settings on a client machine. ▶Starting Setting Synchronization(P. 991)**
- 2 To import data for existing users/groups, back up the data, and delete the data for the users/groups that will be imported from the server machine. ▶Specifying Detailed Synchronization Settings (Server Machine or Server/Client Machine)(P. 995)**
- 3 Import the data to add to the client machine that has synchronization stopped.**
- 4 Synchronize the client machine with the server machine.**

Conditions for Removing Restrictions on the Importing/Exporting of Settings and Other Items

Importing/exporting becomes possible if the corresponding conditions are met for the items described below.

Batch Importing/Batch Exporting

	Export	Import
Personal Setting Information	Only possible if both conditions a and b are met	Unavailable
User Group Address List	Only possible if both conditions a and b are met	Unavailable

Individual Importing/Individual Exporting

	Export	Import
Personal Setting Information (all)	Only possible if both conditions a and b are met	Only possible if condition b is met
User Group Address List (all)	Only possible if both conditions a and b are met	Only possible if condition b is met
User Group Address List 01 to User Group Address List 20	Not possible (there is no function for exporting individual Address Books)	Only possible if condition b is met

a : Execution is only possible for 15 minutes following successful preparation for exporting user data during synchronization of custom settings (server).

b: Execution is only possible if the connection destination of the server/client machine is "localhost:8443".

NOTE

- For instructions on preparing to export user data, see [▶Specifying Detailed Synchronization Settings \(Server Machine or Server/Client Machine\)\(P. 995\)](#) . For instructions on importing Address Lists, see [▶Importing Settings Individually\(P. 956\)](#) .

Importing/Exporting All Settings

961F-0JH

You can export all of the setting data from the machine and save it to a computer, and then import it when configuring the settings on a new machine, such as when you purchase a replacement. If you want to configure the same settings on two or more Canon multifunction printers*, you can simply export all settings from one machine and import them all to the others, eliminating the need to configure each machine separately. To perform these operations, log in to the Remote UI with Administrator privileges.

* imageRUNNER ADVANCE series multifunctional printers or other models that support the import/export of all settings

▶ **Exporting All Settings(P. 950)**

▶ **Importing All Settings(P. 952)**

Exporting All Settings

- 1 Start the Remote UI. ▶ Starting the Remote UI(P. 902)**
- 2 Click [Settings/Registration] on the portal page. ▶ Remote UI Screen(P. 904)**
- 3 Click [Data Management] ▶ [Export].**
- 4 Select the check box for [Select All].**

NOTE

- Specific items can also be exported. For information on which Settings/Registration items correspond with which items of the batch export function of the Remote UI, see ▶ **Settings/Registration(P. 1054)** .

- 5 Enter the password in [Encryption Password] ▶ select the security level from [Security Level] click [Start Exporting] ▶ [OK].**
 - The password in [Encryption Password] will be required when importing the exported setting data. Use alphanumeric characters.
 - For confirmation, enter the password again in [Confirm].
 - To encrypt all the settings data, select [Level 2] in [Security Level].

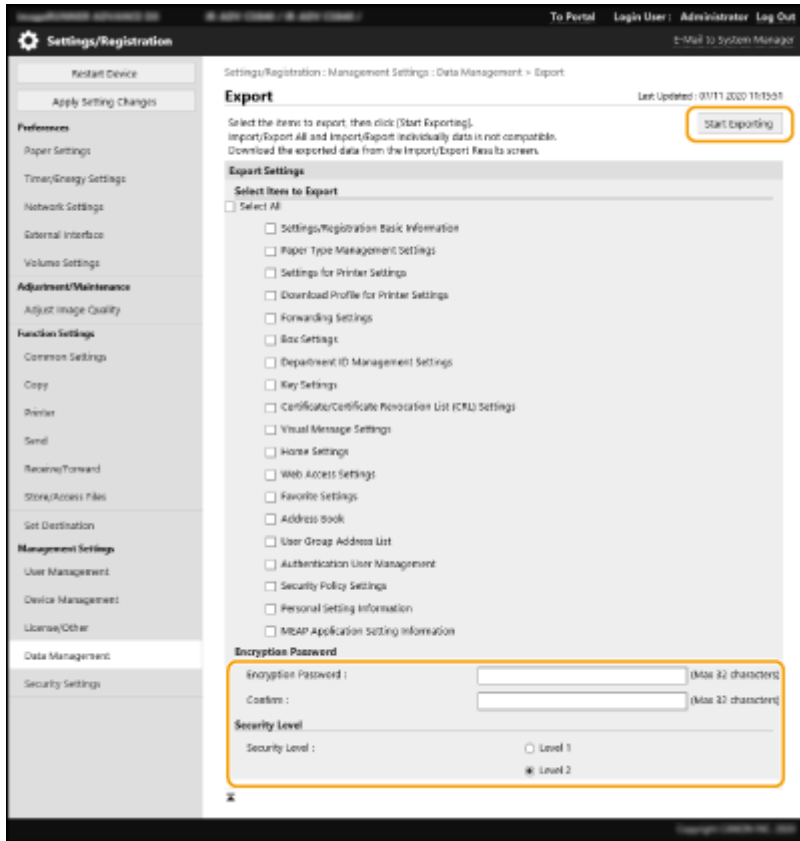

! IMPORTANT

- It may take some time for the screen to change. Do not click [Start Exporting] more than once.
- When importing settings data to another model that does not support the setting in [Security Level], select [Level 1].

6 Click [Check Status].

- If the [Cannot be used when exporting.] message is displayed, do not use the Remote UI to perform the operations.

7 Click [Start Downloading].

8 Follow the on-screen instructions to specify where to save the data.

NOTE

To export all setting data without using a computer

- You can export all setting data to memory media such as a USB memory device. ▶<Export to USB Memory>(P. 1358)

Importing All Settings

You can import all setting data that was exported to a computer. When importing, the previously configured setting values are overwritten. Note, however, that some machine models may not be able to import all setting items. ▶ **Settings/Registration(P. 1054)**

IMPORTANT

Check the System Manager information

- When importing the Department ID Management settings to a different multifunctional printer with Department ID Management enabled, the System Manager information is overwritten, which may prevent you from logging in with the previous System Manager ID and PIN. Before performing this operation, make sure to check the System Manager information that is saved on the exporting machine.

NOTE

When applying security policy settings

- The security policy settings can only be imported if the security policy setting password of the exporting machine matches that of the importing machine, or if no password has been set for the importing machine. If no password has been set for the importing machine, the password configured for the exporting machine is automatically set to the importing machine.

- 1 Start the Remote UI. ▶Starting the Remote UI(P. 902)**
- 2 Click [Settings/Registration] on the portal page. ▶Remote UI Screen(P. 904)**
- 3 Click [Data Management] ▶ [Import].**
- 4 Click [Browse...], and specify the file to import.**
- 5 Enter the password in [Decryption Password], and click [Start Importing] ▶ [OK].**
 - In [Decryption Password], enter the same password that was entered when the setting data was exported.
 - Select the check box for [Create Import/Export Result Report] if you want to output the import results as a CSV file.
 - ▢▶ The data of the selected file is imported into the machine.

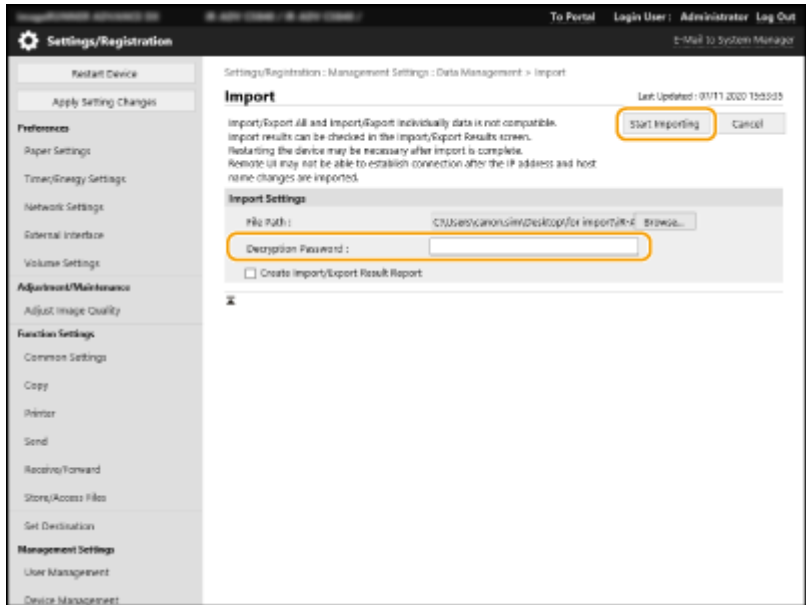

6 Click [OK] ▶ [Check Status].

- The machine may need to be restarted, depending on the imported data. Click [Perform Restart].
- If you select the check box for [Create Import/Export Result Report] in the previous step, click [Settings/Registration] ▶ [Data Management] ▶ [Import/Export Results] ▶ [Create Report] to export the import results.

NOTE

To import all setting data without using a computer

- You can import all setting data from memory media such as a USB memory device. ▶<Import from USB Memory>(P. 1358)
- Only one report file is saved. The next time a batch import is executed, the existing report file is deleted.
- Reports are created in the following language.
 - If the display language of the machine is set to Japanese immediately after the import process: Japanese
 - If the display language of the machine is set to something other than Japanese immediately after the import process: English

Importing/Exporting the Settings Individually

961F-0JJ

You can select particular settings to import or export, such as address lists in the Address Book, or printer settings. Administrator privileges are required in order to perform these operations.

▶ **Exporting Settings Individually(P. 954)**

▶ **Importing Settings Individually(P. 956)**

NOTE

- For information on editing an Address Book CSV file for importing, see ▶ **Address Book Items(P. 960)** .

Exporting Settings Individually

- 1 Start the Remote UI. ▶Starting the Remote UI(P. 902)**
- 2 Click [Settings/Registration] on the portal page. ▶Remote UI Screen(P. 904)**
- 3 Click [Data Management], and select the settings to export.**

■When exporting address lists

- 1** Click [Address Lists] in [Import/Export Individually].
- 2** Click [Export...].
 - If the page for entering a PIN is displayed, enter the PIN and click [OK].
- 3** Configure the necessary settings.

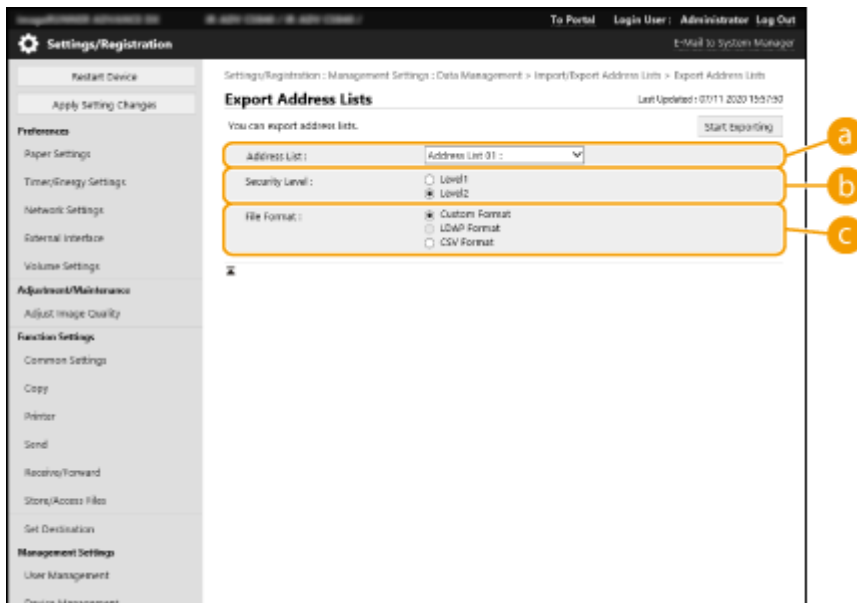

a [Address Lists]

Select the address lists to export. Note that after the address lists are saved, the names of the address lists revert back to the factory defaults.

b [Security Level]

You can set the security level if [Custom Format] is selected in [File Format]. When [Level 1] is selected, you can import to all Canon multifunction printers. When [Level 2] is selected, the password for the address list data is encrypted using a more secure method than [Level 1]. However, the data can only be imported to the machine models that support the [Level 2] setting (models on which the [Security Level] setting is displayed).

c [File Format]

Select the file format of the data to be exported. Select [Custom Format] when you intend to import all information registered in address lists to another Canon multifunction printer, or select [LDAP Format] or [CSV Format] if the file is to be used by a computer application. Note, however, that if [LDAP Format] is selected, only the e-mail addresses and fax numbers are saved.

NOTE**To set a password for exported data**

- Set <Include Password When Exporting Address Book> to <On> (▶<Include Password When Exporting Address Book>(P. 1312)). When this setting is configured, the items for entering the password are displayed on the [Export Address Lists] screen. If a password has been set, the data can only be imported if the correct password is entered.

To edit data exported in the CSV format

- For information on each column in the Address Book, see ▶<Address Book Items(P. 960) .
- Data may not be able to be imported correctly when importing to an old version of the machine.

■When exporting device settings (forwarding settings, Address Book, send function favorite settings)

- 1 Click [Device Settings (Forwarding Settings, Address Book, Send Function Favorite Settings)] in [Import/Export Individually].
- 2 Click [Export...].
- 3 Specify the [Security Level] setting.
 - When [Level 1] is selected, you can import to all Canon multifunction printers. When [Level 2] is selected, the password for the exported data is encrypted using a more secure method than [Level 1]. However, the data can only be imported to a limited selection of Canon multifunction printers.*

* imageRUNNER ADVANCE series multifunctional printers that support the [Security Level] setting

■When exporting Web Access favorites

- 1 Click [Web Access Favorites] in [Import/Export Individually].
- 2 Click [Export...].

■When exporting printer settings

- 1 Click [Printer Settings] in [Import/Export Individually].

2 Click [Export...].

■ **When exporting paper information**

- 1 Click [Paper Information] in [Import/Export Individually].
- 2 Click [Export...].
- 3 Select the paper setting information in [Category].

4 Click [Start Exporting].

5 Follow the on-screen instructions to specify where to save the data.

Importing Settings Individually

- 1 Start the Remote UI. ▶ Starting the Remote UI(P. 902)
- 2 Click [Settings/Registration] on the portal page. ▶ Remote UI Screen(P. 904)
- 3 Click [Data Management], and select the settings to import.

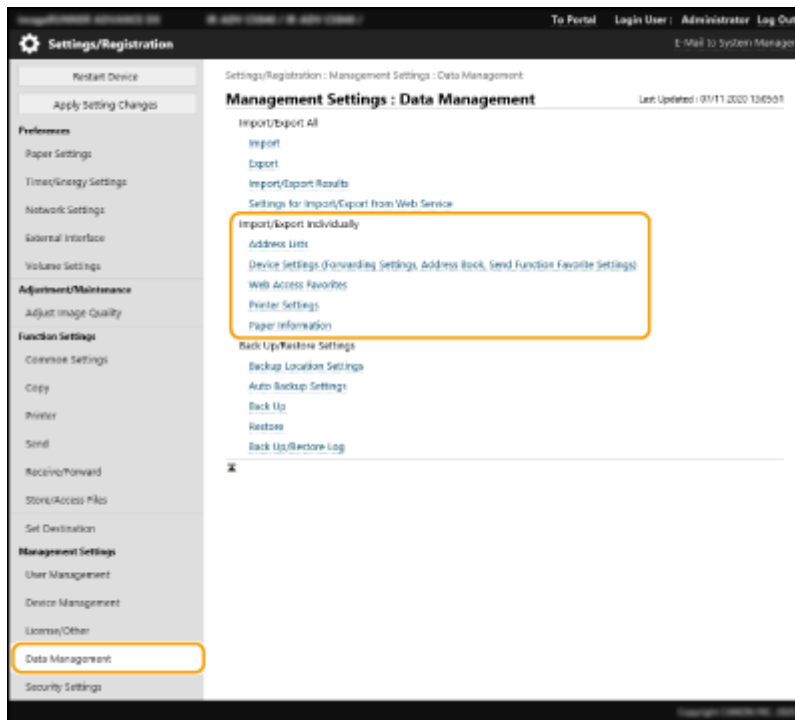

■ When importing address lists

- 1 Click [Address Lists] in [Import/Export Individually].
- 2 Click [Import...].
 - If the page for entering a PIN is displayed, enter the PIN and click [OK].
- 3 Configure the necessary settings.

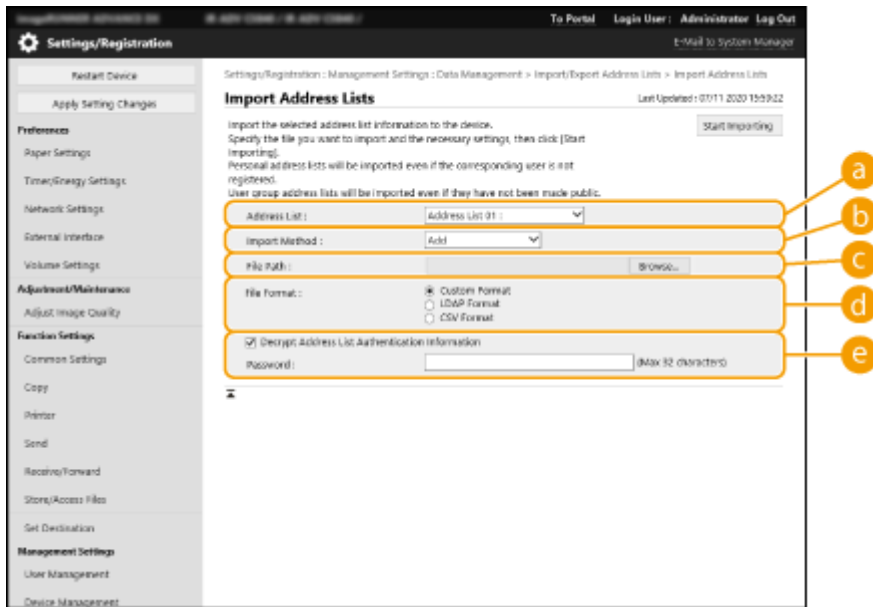

a [Address Lists]

Select the address list that is the import destination.

b [Import Method]

Select [Add] if you want to add the imported destinations without deleting the current address list, or select [Delete and Overwrite] if you want to delete the current address list and overwrite the data with the imported destinations.

c [File Path]

Click [Browse...], and specify the file to import.

d [File Format]

Select the file format of the data to be imported. Select [Custom Format] for files in the dedicated format for Canon multifunction printers (*.abk), select [LDAP Format] for LDAP format files (*.ldif), or select [CSV Format] for CSV format files (*.csv).

e [Decrypt Address List Authentication Information]

When importing encrypted files, select the check box and enter the same password that was entered when the setting data was exported.

■ When importing device settings (forwarding settings, Address Book, send function favorite settings)

- 1 Click [Device Settings (Forwarding Settings, Address Book, Send Function Favorite Settings)] in [Import/Export Individually].
- 2 Click [Import...].

3 Configure the necessary settings.

! IMPORTANT

- The current Address Book is deleted and overwritten with the imported Address Book information.
- When importing, no operations can be performed on the Remote UI until the machine is restarted. In addition, the imported settings become valid after you restart the machine. ▶ **Turning OFF/ Restarting the Machine(P. 911)**

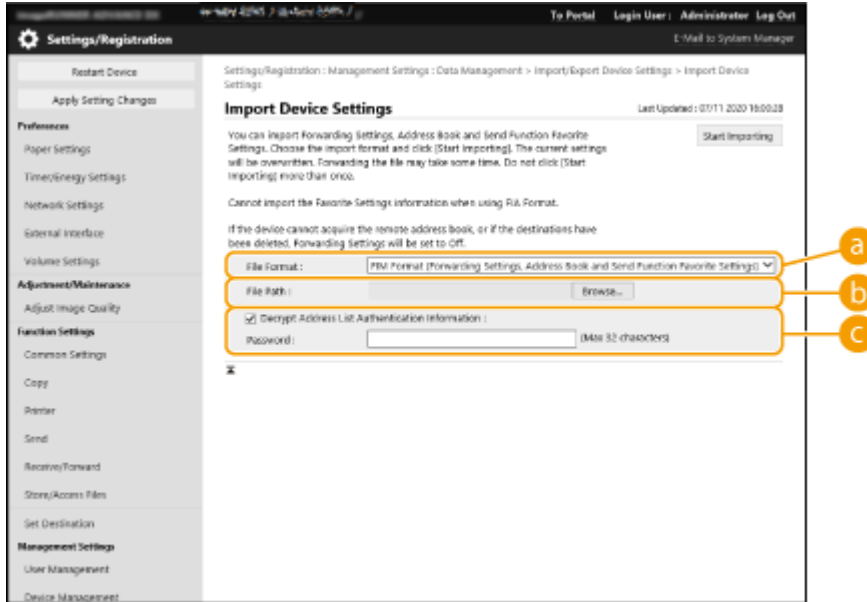

a [File Format]

Select the file format of the setting data to be imported. Note that the file format varies depending on the model of multifunctional printer that exported the data. Check the file to be imported.

b [File Path]

Click [Browse...], and specify the file to import.

c [Decrypt Address List Authentication Information]

When importing encrypted files, select the check box and enter the same password that was entered when the setting data was exported.

■ When importing Web Access favorites

- 1 Click [Web Access Favorites] in [Import/Export Individually].
- 2 Click [Import...].
- 3 Click [Browse...], and specify the setting data to import.
 - Only 20 favorites are imported in the order that they were registered, starting from the top.

■ When importing printer settings

- 1 Click [Printer Settings] in [Import/Export Individually].
- 2 Click [Import...].

- 3 Click [Browse...], and specify the setting data to import.

■ When importing paper information

- 1 Click [Paper Information] in [Import/Export Individually].
- 2 Click [Import...].
- 3 Configure the necessary settings.

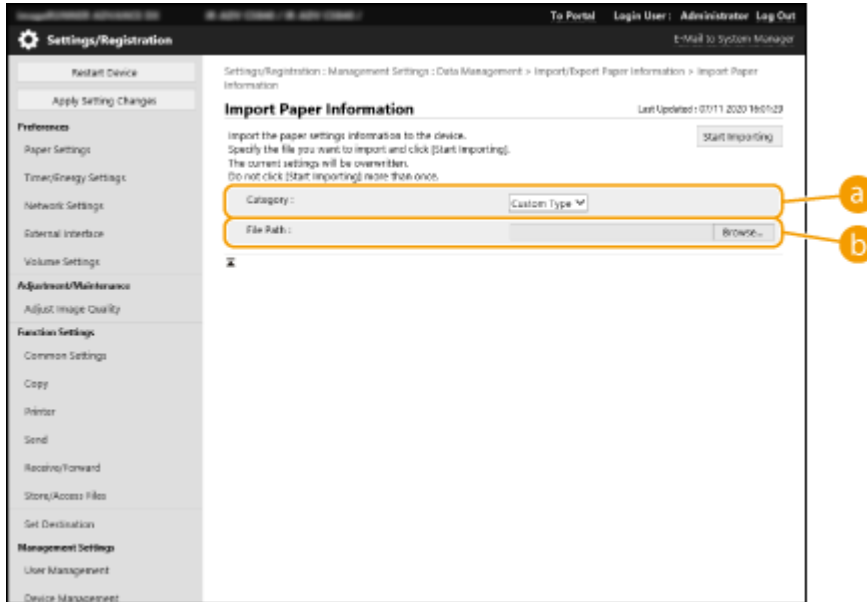

a [Category]

Select the paper setting information.

b [File Path]

Click [Browse...], and specify the file to import.

4 Click [Start Importing] ► [OK].

- The machine may need to be restarted depending on the settings to import. ► **Restarting the Machine(P. 911)**

LINKS

- **Importing/Exporting All Settings(P. 950)**
- **Restricting Use of the Address Book(P. 879)**

Address Book Items

961F-0JK

This section describes each column of the Address Book. Refer to this section when editing CSV files.

Header

Header Name	Required	Notes
# Canon AddressBook CSV version: 0x0002	Yes	Fixed value
# CharSet: UTF-8	Yes	Fixed value
# dn: fixed	Yes (Required for One-touch button Address Book)	Indicates that the destination name is handled as a one-touch button. Entry is only required when the import destination is a one-touch button Address Book. Added when exporting from a one-touch button Address Book, so there is no need to add this item again when importing.
# SubAddressBookName: Address Book name	Yes	Enter the Address Book name after the colon (:), with a space in between. If the Address Book is unnamed, leave the space after the colon (:) blank.
# DB Version: 0x010a	Yes	Fixed value
# Crypto Version: 2	No	Leave this section blank if you are creating a new Address Book CSV file.
# Crypto Attribute: pwd	No	Leave this section blank if you are creating a new Address Book CSV file.

NOTE

- The presence a header relating to "Crypt" in a header indicates that the password attribute is encrypted. However, when entering this information into a newly-created CSV file, or when editing the pwd attribute of an exported CSV file, encryption cannot be performed in a manner that allows the machine to correctly decode. In such cases, delete the corresponding portion from the header.

Body

Attribute Name	Description	Required	Notes
objectclass	Object class (destination type)	Yes	Indicates the type of destination. The required attribute varies according to this value. Enter one of the following. <ul style="list-style-type: none"> For e-mail: email For G3 fax: g3fax For IP fax: ipfax For fax: ifax For file server (SMB, FTP, WebDAV): remotefilesystem For group: groupfids

Managing the Machine

cn	Destination name	No	Enter in UTF-8 character code. Otherwise, the destination name will be left blank.
cnread	Phonetic alphabet	No	Displayed as "phonetic" if the display language is set to "Japanese".
cnshort	One-touch button name	No	Enter in UTF-8 character code. Otherwise, the one-touch button name will be left blank.
subdbid	Address Book number	No	Specify which Address Book to import to in the Remote UI. Not required when writing to a CSV file.
mailaddress	E-mail address	Yes (Required for certain destination types)	This attribute is required for e-mail and I-fax destinations.
dialdata	Fax number	Yes (Required for certain destination types)	This attribute is required for fax destinations. However, it is not required if the destination is an IP fax using a URI.
uri	The URI used with an IP fax	Yes (Required for certain destination types)	Only usable for IP fax destinations. This attribute is required if you do not specify a fax number for an IP fax. For an IP fax destination using a URI, you must also specify the "URI flag" (see below).
url	File server destination host name	Yes (Required for certain destination types)	This attribute is required for file server destinations. You can only use letters and symbols.
path	File path for file server destination	No	You can only use letters and symbols.
protocol	Protocol	Yes (Required for certain destination types)	This attribute is required for file server destinations. Enter one of the following. <ul style="list-style-type: none"> • For SMB: smb • For FTP: ftp • For WebDAV: addonprotocol0225
username	User name used when logging in to a file server destination	Yes (Required for certain destination types)	This attribute is required for FTP file server destinations. The user ID is required to log in to a file sending destination, and therefore is also required for file sending destinations using authentication, such as SMB and WebDAV.
pwd	Password used when logging in to a file server destination	No	This attribute is required for file sending destinations using authentication.
member	A member of a group destination	Yes (Required for certain destination types)	This attribute is required for group destinations.

Managing the Machine

indxid	A serial number allocated to a destination	Yes	This attribute is required if the import destination is a one-touch button Address Book. This number becomes the one-touch button number. In other cases, enter a number from 201 to 1,800.
enablepartial	Setting for dividing data when sending an e-mail	No	Enter either "on" or "off".
sub	Subaddress of a file server destination	No	
faxprotocol	Fax protocol	No	Enter one of the following. <ul style="list-style-type: none"> • g3 • ecm
ecm	Indicates the use of ECM.	No	Enter either "on" or "off".
txstartspeed	Starting transmission speed for faxing	No	Enter one of the following. <ul style="list-style-type: none"> • 2400 • 4800 • 7200 • 9600 • 14400 • 33600
commode	Fax communication mode Setting regarding international sending	No	Enter one of the following. <ul style="list-style-type: none"> • For PSTN domestic line: domestic • For PSTN international line 1: international1 • For PSTN international line 2: international2 • For PSTN international line 3: international3
lineselect	Selected fax line	No	Enter one of the following. Otherwise, "auto" is used. <ul style="list-style-type: none"> • For lines 1 to 4: line1, line2, line3, or line4 • For automatic line specification: auto
uricommode	IP fax communication mode	Yes (Required for certain destination types)	This is the chosen communication mode for IP faxes. This attribute is required if you use IP faxing, and are sending to a fax destination. Enter one of the following. <ul style="list-style-type: none"> • For G3: ip_g3 • For intranet: ip_lsv • For a VoIP gateway: ip_gw
uriflag	The flag for a URI used with an IP fax	Yes (Required for certain destination types)	This attribute is required if the destination is an IP fax, and you use a URI instead of a fax number. Enter either "TRUE" or "FALSE". If you use a URI, enter "TRUE".
pwdinputflag	Setting for requesting password input per transmission	No	Enter either "on" or "off".

ifaxmode	I-Fax mode (simple/full)	No	Enter either "simple" or "full".
transsvcstr1	I-fax relay service text string 1	No	Enter total of up to 40 alphanumeric characters and symbols.
transsvcstr2	I-fax relay service text string 2	No	Enter total of up to 16 alphanumeric characters and symbols.
ifaxdirectmode	I-fax direct sending	No	Enter either "on" or "off".
documenttype	I-fax document type	No	Enter one of the following. <ul style="list-style-type: none"> • To send in color: cl • To send in black and white: bw
bwpapersize	Paper size allowable when sending an I-fax	No	
bwcompressiontype	Compression format used when sending an I-fax	No	
bwpixeltype	Color space allowable when sending an I-fax	No	
bwbitsperpixel	Bit count allowable when sending an I-fax	No	
bwresolution	Resolution allowable when sending an I-fax	No	
clpapersize	Paper size allowable when sending a color I-fax	No	
clcompressiontype	Compression format used when sending a color I-fax	No	Fixed as "jpeg".
clpixeltype	Color space allowable when sending a color I-fax	No	Fixed as "rgb".
clbitsperpixel	Bit count allowable when sending a color I-fax	No	Fixed as "8".
clresolution	Resolution allowable when sending a color I-fax	No	
accesscode	Access code	No	Enter up to seven numbers.
uuid	A UUID for identifying a destination	No	This item is not necessary when creating a new CSV file.
cnreadlang	Phonetic alphabet character code	No	Displayed as "phonetic" if the display language is set to "Japanese". Enter the language code to use. For Japanese (SJIS), enter "ja".
enablesfp	Unused	No	This item is unused, and therefore does not need to be entered.
memberobjectuuid	Used for Personal Address List/User Group Address List	No	
loginusername	Used for Personal Address List/User Group Address List	No	

Managing the Machine

logindomainname	Used for Personal Address List/User Group Address List	No	
usergroupname	Used for Personal Address List/User Group Address List	No	
personalid	Used for Personal Address List/User Group Address List	No	

Backing Up/Restoring Data

You can back up the data saved on the machine to an external storage device or SMB server. If you perform backup before updating the firmware or initializing the settings, you can restore the settings if a problem occurs. Administrator privileges are required in order to perform these operations.

▶ **Backing Up Data(P. 965)**

▶ **Restoring Backup Data(P. 968)**

IMPORTANT

- To restore backed up data, the storage device of the machine needs to have enough available space for the backed up data.
- Data cannot be backed up or restored if more than one external storage device is connected to the machine. Disconnect any unnecessary external storage devices so that only one is connected.
- It may take some time to back up or restore the saved data. Do not turn OFF the machine until the backup or restore process is complete. Doing so may cause the machine to malfunction.
- Data may be lost if a problem occurs with the storage device. Periodically back up/export sensitive data. Please note that Canon is not liable for any damages caused by loss of data.

NOTE

Connecting an external storage device

- When using an external storage device to back up or restore data, it is recommended that you connect it to the USB port at the rear of right side of the main unit (the back of the main unit). ▶ **Parts and Their Functions(P. 19)**
- For more information on the external storage devices that can be used with the machine, see ▶ **System Specifications(P. 1577)** .

Display language during backup/restore process

- If you change the display language and back up or restore data without restarting the machine first, the data may not be backed up or restored properly.

Backing Up Data

IMPORTANT

- Do not change or delete the backed-up data. Doing so may prevent you from being able to restore the data properly.
- Do not perform backup while the machine is being operated via the control panel or the Remote UI.

1 Start the Remote UI. ▶ **Starting the Remote UI(P. 902)**

2 Click [Settings/Registration] on the portal page. ▶ Remote UI Screen(P. 904)

3 Click [Data Management] ▶ [Backup Location Settings].

NOTE

Auto Backup

- You can click [Auto Backup Settings] and configure the machine to automatically back up data on a specified day and time. Follow the on-screen instructions to configure the settings.

4 Configure the necessary settings.

■ When backing up to an external storage device

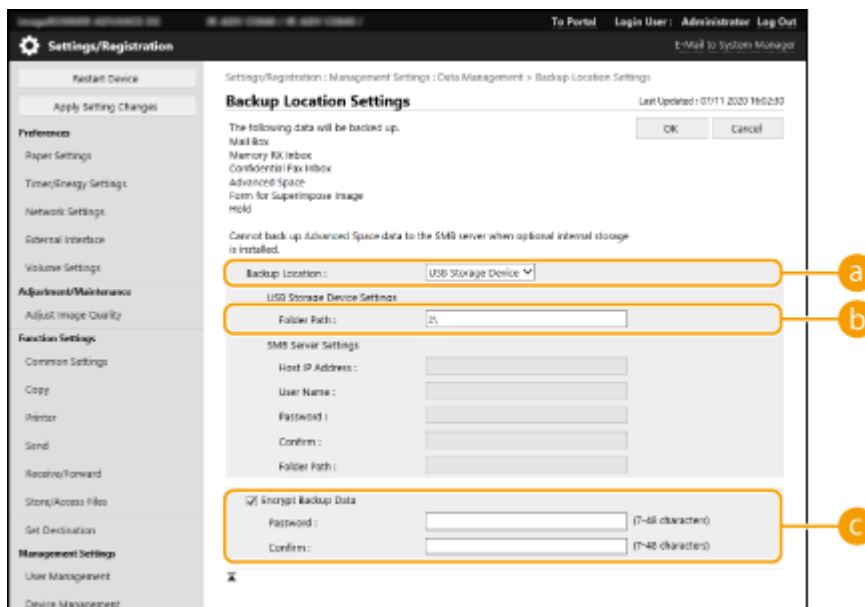

a [Backup Location]

Select [USB Storage Device].

b [Folder Path]

Enter the path to the folder on the external storage device in which to save the backed-up data.

c [Encrypt Backup Data]

If you select the check box and enter a password, you can encrypt the backed-up data. The password specified here will be required when restoring the encrypted backup data.

■ **When backing up to an SMB server**

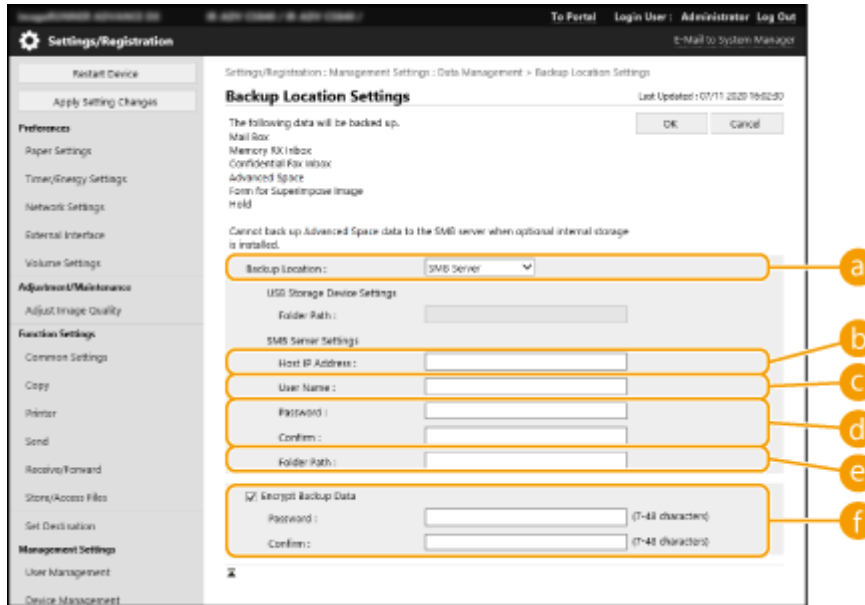

a [Backup Location]

Select [SMB Server].

b [Host IP Address]

Specify the location of the SMB server. Use the following format: \\Name of server\Name of shared folder

c [User Name]

Enter the user name for accessing the SMB server.

d [Password]/[Confirm]

Enter the password for accessing the SMB server. For confirmation, enter the same password again in [Confirm].

e [Folder Path]

If the backup folder is at a level below **b**, add the rest of the path that follows **b**. Make sure that the user limit of the specified folder is set to allow two or more users. If the user limit is set to allow one user, you will not be able to restore the backed-up data properly.

f [Encrypt Backup Data]

If you select the check box and enter a password, you can encrypt the backed-up data. The password specified here will be required when restoring the encrypted backup data.

5 Click [OK].

6 Click [Back Up].

7 Select the backup method, and click [Execute] ► [OK].

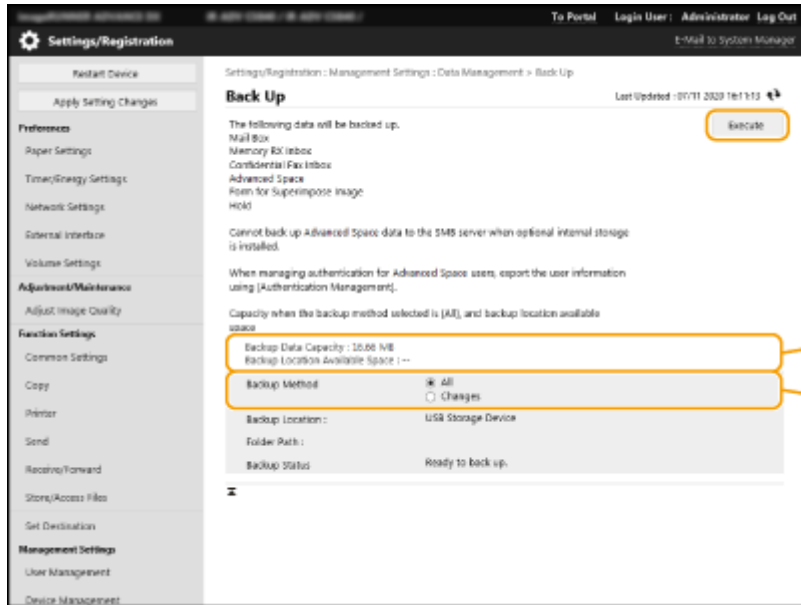

a [Backup Data Capacity]/[Backup Location Available Space]

If [Backup Location Available Space] is not enough for [Backup Data Capacity], set a different backup destination.

b [Backup Method]

Select [All] to perform standard backup. If you only want to back up the data that has been changed since the previous backup, select [Changes].

! IMPORTANT

- Backup can be performed a limited number of times in the same folder. If backup can no longer be performed, specify a different backup destination folder.
- [Changes] for Advanced Space backs up only the data updated or added since all the stored data was backed up. [Changes] always backs up data based on differences from [All] as opposed to the last [Changes] backup.

NOTE

- After performing backup, you can click [Back Up/Restore Log] on the screen displayed in step 7, and check the results of the backup in [Result].
- If the [A server error has occurred.] message is displayed, the network settings may not be configured properly. Check the network settings.
- The backed-up data can be restored not only to the machine but also to upgrades of the same model.

Restoring Backup Data

- 1 Start the Remote UI. ▶Starting the Remote UI(P. 902)**
- 2 Click [Settings/Registration] on the portal page. ▶Remote UI Screen(P. 904)**
- 3 Click [Data Management] ▶ [Restore].**

4 Click [Display Backup Data].

5 Select the backup data to restore, and click [Execute] ► [OK].

- Enter the password if one was set when backing up the data.

6 Click [Restart Main Unit].

- After the machine restarts, the backup data is restored.

 **IMPORTANT**

- The backup data may not be fully restored when certain machine settings are used.

NOTE

Restoring saved data

- Restoration is performed after all of the data stored in the machine, or documents that are being sent, received, or stored, are erased.
- If authentication management is performed for Advanced Space users (► **Setting Advanced Space to Public(P. 321)**), you need to pay particular attention when restoring the backed up data to a different model. For more information, see. ► **Manually Importing User Data(P. 815)**
- After you restore backup data, the machine may print documents automatically.
- If you back up data from an optional storage device and restore it on the standard-equipped storage device, some of the data may not be restored.

Updating the Firmware



New firmware is periodically released to add new functions or resolve issues with existing functions. If new firmware is available, follow the procedure below to update it on the machine. Administrator privileges are required in order to update the firmware.

▶ **Checking the Firmware Version(P. 970)**

▶ **Running the Firmware Update(P. 971)**

! IMPORTANT

- Do not perform the following operations while updating the firmware. Doing so may cause a critical error.
 - Turn OFF the main power
 - Remove the LAN cable
 - Perform communication (such as printing) with the machine from another computer or application^{*1}
 - Configure the sleep settings of your computer^{*2}

*1 When updating the firmware in a network environment, ensure that other users do not perform operations such as printing.

*2 The firmware may not be updated correctly if the computer enters the sleep mode.

NOTE

Preparing to update the firmware

- Download the latest firmware from the Canon website (<https://global.canon/>).
- Back up the machine data and settings in case the firmware update is not performed properly.
 - ▶ **Backing Up/Restoring Data(P. 965)**
 - ▶ **Importing/Exporting the Setting Data(P. 946)**

Note regarding the update process

- The machine restarts several times.
- The update process is interrupted if jobs remain.
- The screen switches several times during the update process. It may take some time for the screen to switch, but do not close the browser until the update process is complete.

Checking the Firmware Version

Check the firmware version of the machine before updating the firmware and after updating the firmware.

1 Start the Remote UI. ▶ Starting the Remote UI(P. 902)

- 2 Click [Status Monitor/Cancel] on the portal page. ▶ Remote UI Screen(P. 904)
- 3 Click [Device Information].
- 4 Check the version shown in [Controller] in [Version Information].

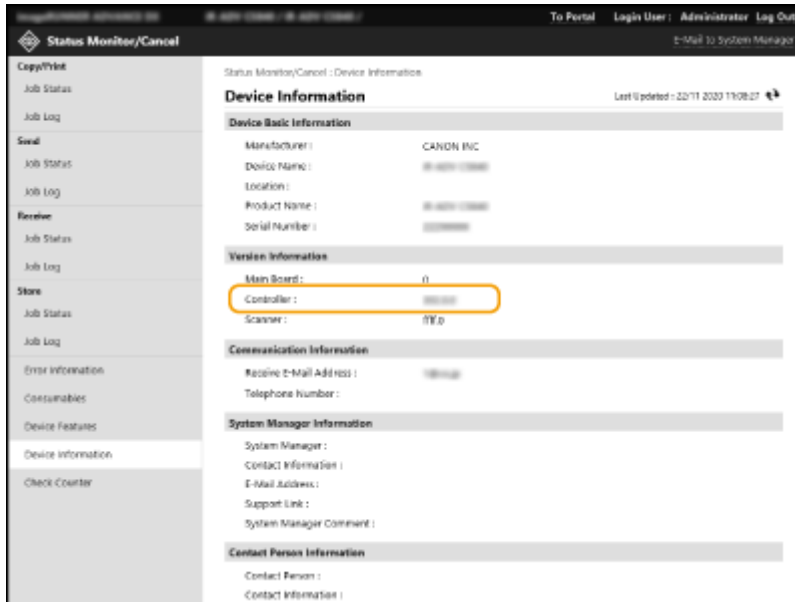

Running the Firmware Update

- 1 Start the Remote UI. ▶ Starting the Remote UI(P. 902)
- 2 Click [Settings/Registration] on the portal page. ▶ Remote UI Screen(P. 904)
- 3 Click [License/Other] ▶ [Register/Update Software].
- 4 Click [Manual Update].
- 5 Click [Browse...], select the firmware update to use, and click [Next].
- 6 Click [Yes].

⇒ When the [The firmware is updated. Restart the device.] message appears, turn the machine OFF and back ON. ▶ Turning OFF/Restarting the Machine(P. 911)

Updating the Firmware (Distribution)

961F-0JS



If the machine has access to the Internet, you can download the latest firmware for the machine from Canon's distribution server. This might be more flexible and convenient than the other update method ([▶Updating the Firmware\(P. 970\)](#)) because both manual and automatic update options are available, enabling you to download the firmware at a specified time or as soon as the latest version is available. Administrator privileges are required in order to perform these operations. This feature may not be available depending on your country or region.

NOTE

Preparing to update the firmware

- Back up the machine data and settings in case the firmware update is not performed properly.
 - ▶[Backing Up/Restoring Data\(P. 965\)](#)
 - ▶[Importing/Exporting the Setting Data\(P. 946\)](#)

1 Start the Remote UI. [▶Starting the Remote UI\(P. 902\)](#)

2 Click [Settings/Registration] on the portal page. [▶Remote UI Screen\(P. 904\)](#)

3 Click [License/Other] ▶ [Register/Update Software].

4 Perform a communication test.

- Test whether you can access the distribution server over the network.

1 Click [Display Logs/Communication Test].

2 Click [Communication Test] ▶ [Yes].

▢▢▢ The results of the communication test are displayed.

- If [Could not connect to distribution server. Check the distribution server and network.] is displayed, check that the LAN cable is connected and the network settings are configured properly. [▶Setting up Using the Setup Guide\(P. 250\)](#)

5 Click [Distributed Update] ▶ [Confirm New Firmware].

6 Configure the necessary settings.

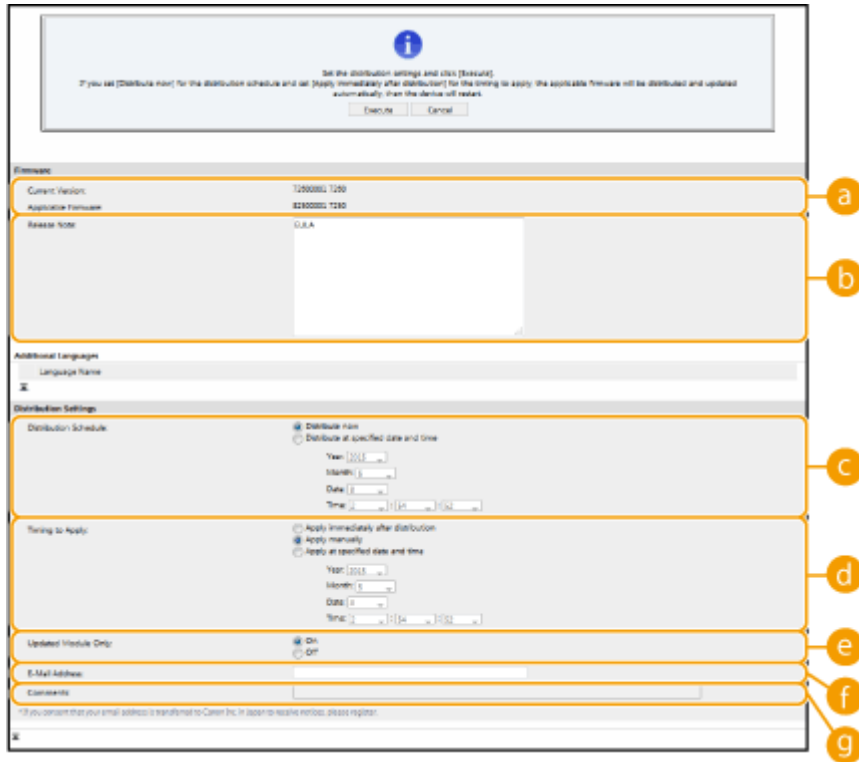

a [Current Version]/[Applicable Firmware]

You can check the current firmware version and new one respectively.

b [Release Note]

Important information is displayed. Make sure to read and understand the contents.

c [Distribution Schedule]

To download the firmware immediately, select [Distribute now]. To automatically download the firmware at a specified date and time, select [Distribute at specified date and time] and specify the date and time in [Year]/[Month]/[Date]/[Time]. You can schedule a time within a week in advance.

d [Timing to Apply]

To automatically apply the firmware immediately after downloading is complete, select [Apply immediately after distribution]. To automatically apply the firmware at a specified date and time, select [Apply at specified date and time] and specify the date and time in [Year]/[Month]/[Date]/[Time]. You can also select [Apply manually] to manually apply the firmware.

e [Updated Module Only]

Select [On] to perform an incremental update (download only the difference between the current and new firmware versions). If you want to download the entire firmware, select [Off]. Note that some firmware versions do not support incremental update.

f [E-Mail Address]

Enter your e-mail address. The distribution server sends the update status to the e-mail address entered here.

g [Comments]

Enter a description or note to add to the e-mail. If you manage multiple machines, enter the device name so that you can easily identify the received update status.

7 Click [Execute] ▶ [OK].

- If the license agreement screen is displayed, check the information and click [I Agree].
- If [Apply immediately after distribution] or [Apply at specified date and time] is selected in the previous step, the machine automatically restarts immediately after the firmware is applied. If [Apply manually] is selected, you need to apply the downloaded firmware manually. ▶ **Applying the Downloaded Firmware(P. 974)**

IMPORTANT

- Changing the distributed update settings again may delete the downloaded firmware or cancel the scheduled settings.

NOTE

Canceling the distribution schedule

- On the screen displayed in step 5, click [Delete Scheduled Distribution] ▶ [Yes].

TIPS

Automatically check for new firmware (scheduled update)

- If you click [Scheduled Update Settings] ▶ [Edit] in step 5, you can set the machine to periodically access the distribution server for new firmware. If new firmware is available, it is downloaded to update the firmware on the machine.

■ Applying the Downloaded Firmware

- 1 Start the Remote UI.** ▶ **Starting the Remote UI(P. 902)**
- 2 Click [Settings/Registration] on the portal page.** ▶ **Remote UI Screen(P. 904)**
- 3 Click [License/Other] ▶ [Register/Update Software].**
- 4 Click [Distributed Update] ▶ [Apply Firmware] ▶ [OK].**

- The machine automatically restarts immediately after the firmware is applied.

NOTE

To delete the firmware

- Click [Delete Firmware] ▶ [OK].

NOTE

Configuring settings via the control panel

- You can also access and configure the distributed update settings by pressing  (Settings/Registration) ▶ <Management Settings> ▶ <License/Other> ▶ <Register/Update Software> ▶ <Update Firmware>. ▶ **<License/Other>(P. 1348)**

Setting Scheduled Updates

961F-0JU



You can set the machine to regularly check for new applicable firmware and automatically update the firmware of the machine.

NOTE

- This operation can only be performed by a user with the required privileges.
- If the downloading of the firmware is not complete, or the downloaded firmware has not been applied, you cannot perform a scheduled update.

- 1 Start the Remote UI.** ▶ Starting the Remote UI(P. 902)
- 2 Click [Settings/Registration] on the portal page.** ▶ Remote UI Screen(P. 904)
- 3 Click [License/Other] ▶ [Register/Update Software].**
- 4 Click [Scheduled Update Settings] ▶ [Edit...].**
- 5 Select the check box for [Enable scheduled update settings], and configure the necessary settings.**

Scheduled Update Settings [Set] [Cancel]

Enable scheduled update settings

Update Schedule: * It may take up to 5 hours to finish checking for updates.

Confirm: [Stability] [Not Set] [Not Set] [00]

Apply at: [Not Set] [00] * Updates are applied after confirmation and downloading are complete.

E-Mail: []

Comments: []

* If you consent that your email address is transferred to Canon Inc. in Japan to receive notices, please register.

a [Update Schedule]

[Confirm]

Select the cycle ([Biweekly] or [Weekly], a day ([Sun] to [Sat]), and the time). The time is displayed in 24-hour notation. The firmware check may take up to 3 hours to complete from the specified time.

[Apply at]

Select the time to apply downloaded firmware.

b [E-Mail]

Enter the e-mail address of the administrator. You can receive e-mails regarding the update status that is sent from the distribution server.

c [Comments]

Enter the comment that will automatically be added to the e-mail. If the model name is entered, you can identify which device status the e-mail is about.

NOTE

- If previously downloaded firmware has not been applied by scheduled update, the next scheduled update is not performed.
- If Scheduled Update is set, a firmware update is applied at the specified time after the new firmware is downloaded from the distribution server. After application is complete, the machine automatically restarts.

6 Click [Set].

Displaying Messages from the Administrator

961F-0JW



You can display messages to users on the touch panel display. Messages can be displayed at the bottom of the touch panel display or in a separate pop-up window, and you can select which display method to use based on the type of message or user. When a message is displayed in a pop-up window, you can also display the same message on the Remote UI portal page. Administrator privileges are required in order to configure these settings.

- 1 Start the Remote UI. ▶ Starting the Remote UI(P. 902)**
- 2 Click [Settings/Registration] on the portal page. ▶ Remote UI Screen(P. 904)**
- 3 Click [License/Other] ▶ [Message Board/Support Link].**
- 4 Enter the message, and click [OK].**

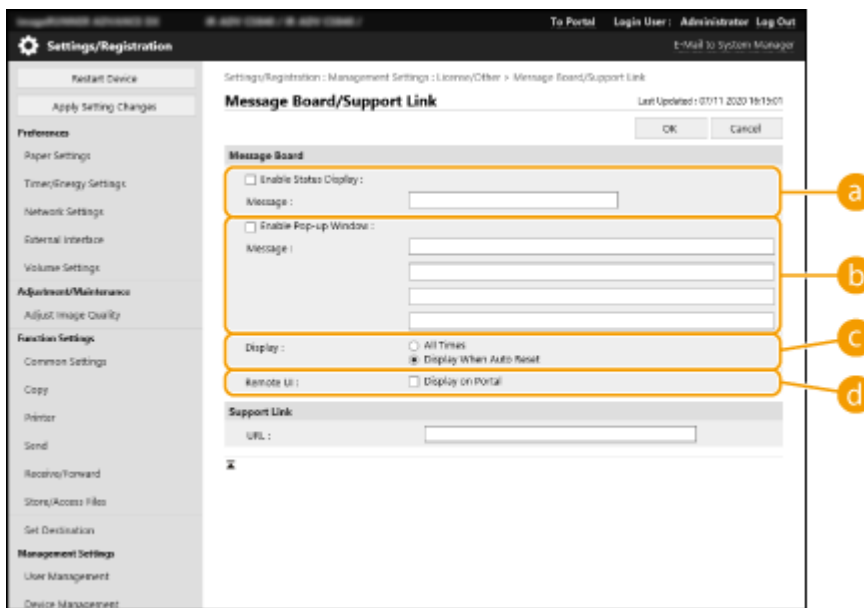

a [Enable Status Display]

To display the message at the bottom of the touch panel display, select the check box and enter the message in [Message]. Use this setting for displaying operational tips and other low-priority messages.

b [Enable Pop-up Window]

To display the message in a pop-up window on the touch panel display, select the check box and enter the message in [Message]. Use this setting for displaying high-priority messages.

c [Display]

Select the display method for the pop-up window.

[All Times]	The pop-up window is displayed continuously, and the machine cannot be operated. Use this setting for messages such as an out-of-service notice.
[Display When Auto Reset]	The pop-up window is displayed when no operations are performed for a specified period of time, or when the machine is restarted. Use this setting for messages such as a maintenance schedule notice.

d [Remote UI]

If you select the check box, the message shown in the pop-up window is also displayed on the Remote UI portal page.

NOTE

Canceling the message display

- Clear the check boxes for [Enable Status Display], [Enable Pop-up Window], and [Remote UI]. If you also want to delete the message contents, remove the text that was entered in the [Message] text boxes.

LINKS

 <Timer/Energy Settings>(P. 1072)

Configuring the Visual Message Function

961F-0JX

The Visual Message function enables you to display simple content and messages on the touch panel display. Displaying messages from the administrator or event notifications, etc. on the touch panel display enables the machine to be used as an information sharing tool in the office.

NOTE

- When the Visual Message function is set, content can be checked from <Visual Message> on the Home, regardless of the timing. The last content displayed is displayed.
- Set a file saved on a file server or in an Advanced Space on the same network as the content to display. [▶ Using as a Simple File Server\(P. 708\)](#)
- You can also set a website on the internet as the content via a proxy server. The proxy settings used for this function are the same as the settings in [▶<Proxy Settings>\(P. 1103\)](#) .
 - If a proxy is set, the specified content may not appear. When this occurs, set an exception address so that the proxy server is not used. [▶Setting Exception Addresses Where a Proxy Server Is Not Used\(P. 982\)](#)
- The content is displayed when printing starts if the forced hold print function is enabled and the [Display When Print Job Starts] check box is selected.

- 1 Start the Remote UI.** [▶Starting the Remote UI\(P. 902\)](#)
- 2 Click [Settings/Registration] on the portal page.** [▶Remote UI Screen\(P. 904\)](#)
- 3 Click [License/Other] ▶ [Visual Message Settings] ▶ [Display Settings].**
- 4 Set the display timing and content.**

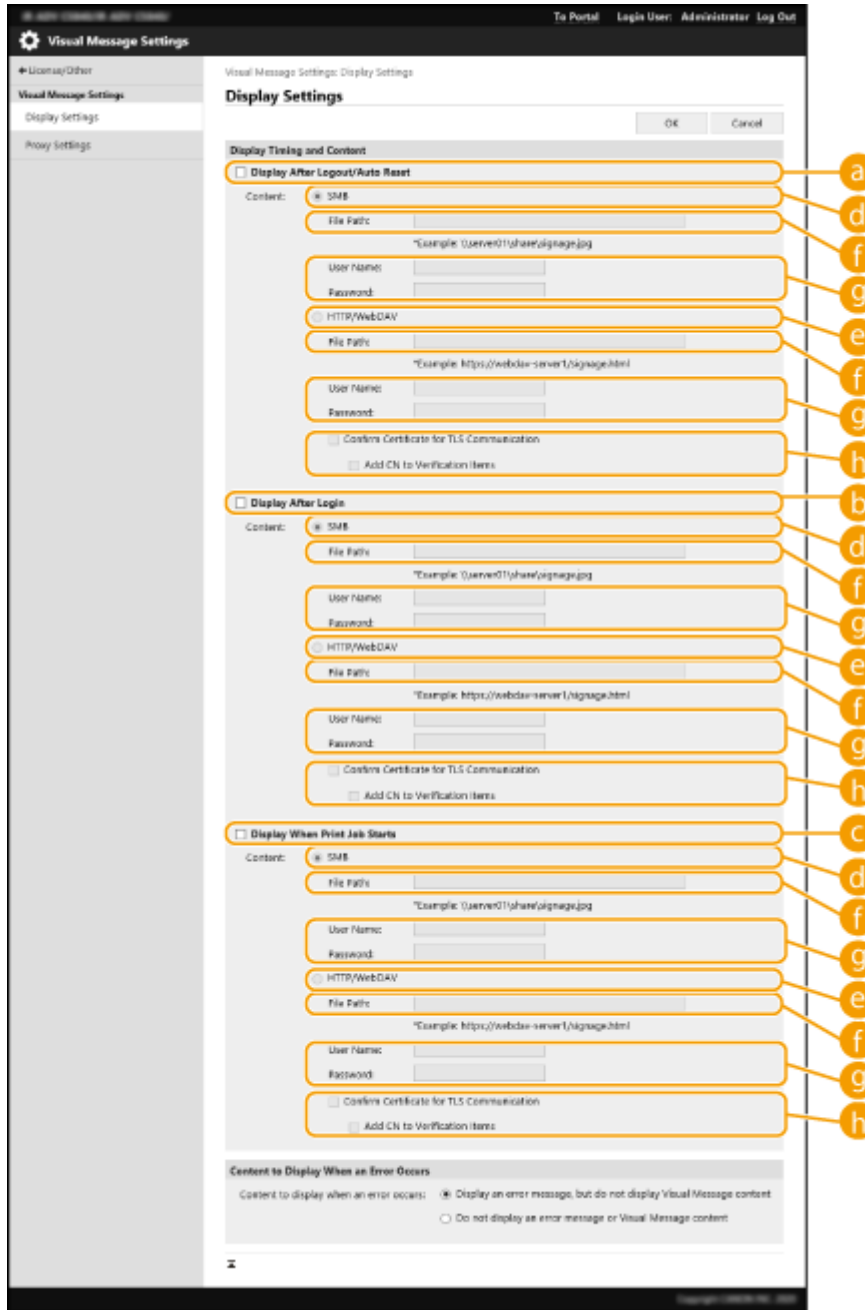

■ **Setting the Display Timing**

a [Display After Logout/Auto Reset]

Select this check box to display the content after logging out or after the auto reset mode activates. The setting to display the content after logging out is enabled when <Login Screen Display Settings> is set to <Display When Device Operation Starts>. To display the content after the auto reset mode activates, set <Auto Reset Time> to 1 minute or longer.

b [Display After Login]

Select this check box to display the content after logging in. This is enabled when <Login Screen Display Settings> is set to <Display When Device Operation Starts>.

c [Display When Print Job Starts]

Select this check box to display the content when printing starts. This is enabled when forced hold printing is set.

■ **Setting the Content for Each Display Timing**

d [SMB]

Select the check box to access the content to display via [SMB].

e [HTTP/WebDAV]

Select the check box to access the content to display via [HTTP/WebDAV].

f [File Path:]

Enter the path to the content to display.

Example:

- **[SMB]** : \\server01\share\signage.jpg
- **[HTTP/WebDAV]** : https://webdav-server1/signage.html

g [User Name:]/[Password:]

Enter the user name and password necessary for logging into the Advanced Space or file server.

h [Confirm Certificate for TLS Communication]/[Add CN to Verification Items]

Set whether to verify the TLS server certificate sent when connecting and its CN (Common Name).

5 Set the screen display for errors.

- If content does not appear for some reason, select whether to display an error message screen.

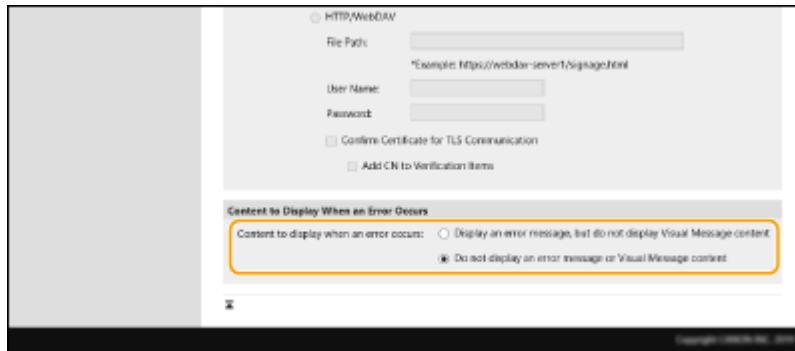

6 Click [OK].

NOTE

- To display the content after the Auto Reset mode initiates, set <Auto Reset Time> to one minute or longer.
- For information on the file formats and data sizes that can be displayed, see **Management Functions(P. 1586)** .
- This setting can only be specified by a user with Administrator privileges.
- This setting is not included in Device Information Distribution. **Distributing the Device Information to Other Canon Multifunction Printers(P. 1005)**
- This setting can be imported/exported. The same setting can be imported to multiple devices (only Canon devices that support the Visual Message function) to display the same notice or information on multiple devices. **Importing/Exporting the Setting Data(P. 946)**
- [File Path:] is imported/exported with this setting. If a file in the Advanced Space is specified and displayed on the exporting machine, perform one of the following operations:
 - Manually copy the file in the Advanced Space of the exporting machine to the Advanced Space of the importing machine.
 - Change [File Path:] to the path where the file exists.
- If you are going to perform login operations, perform them after closing the Visual Message screen. **Logging into the Machine(P. 355)**

- If the Copy Card Reader is attached, the content is not displayed.

Setting Exception Addresses Where a Proxy Server Is Not Used

Specify the proxy settings in the Visual Message function to match the settings in <Proxy Settings>. If a proxy is set, the specified content may not appear. When this occurs, set an exception address so that the proxy server is not used.

- 1 Start the Remote UI.** ▶ **Starting the Remote UI(P. 902)**
- 2 Click [Settings/Registration] on the portal page.** ▶ **Remote UI Screen(P. 904)**
- 3 Click [License/Other] ▶ [Visual Message Settings] ▶ [Proxy Settings].**
- 4 In[Address Without Using Proxy], enter the addresses for which a proxy server will not be used.**
 - You can specify multiple addresses separated by a comma (,).
 - You can specify up to 255 characters (ASCII code only).
- 5 Click [OK].**

Using the Visual Message Function for Greater Convenience

You can post login information (user name and domain name) to the server for users who display content. You can also collect that information and print out linked PDF files in the content for checking.

- 1 Start the Remote UI.** ▶ **Starting the Remote UI(P. 902)**
- 2 Click [Settings/Registration] on the portal page.** ▶ **Remote UI Screen(P. 904)**
- 3 Click [License/Other] ▶ [Visual Message Settings] ▶ [Security Settings].**
- 4 Select the check boxes for the items you want to set.**

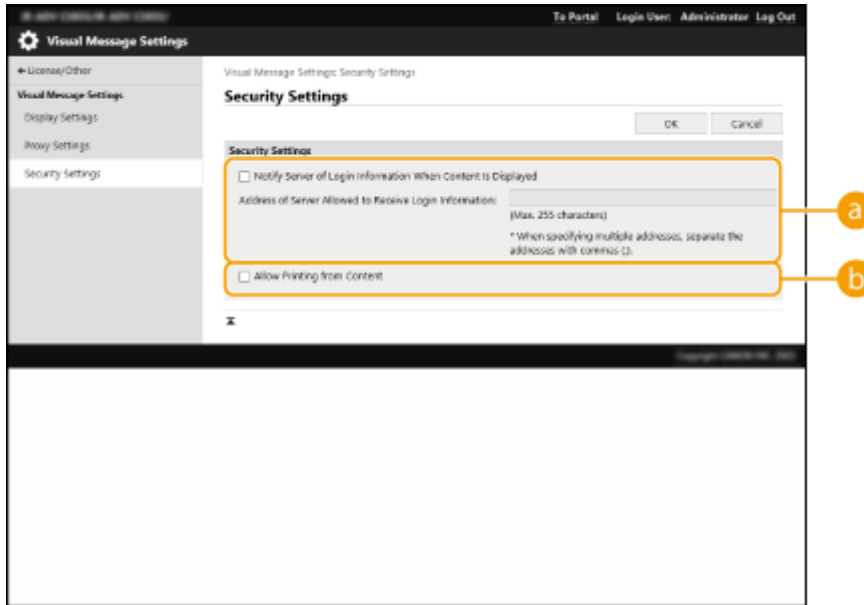

a [Notify Server of Login Information When Content Is Displayed]

Select this check box to post the user information (user name and domain name) to the Web server when the user displays the Visual Message, and enter the Web server path.

b [Allow Printing from Content]

Select this check box to specify the function that prints PDF content included in the HTML displayed in the Visual Message.

5 Click [OK].

LINKS

- ▶<Login Screen Display Settings>(P. 1326)
- ▶<Use User Authentication>(P. 1326)
- ▶<Auto Reset Time>(P. 1074)

Sending E-Mail Notification When an Error Occurs

961F-0JY

You can notify an e-mail address specified in advance when toner needs replacing or a paper jam needs to be cleared, etc.

Specifying the Destination and the Information to Send

- 1** Start the Remote UI. ▶ Starting the Remote UI(P. 902)
- 2** Click [Settings/Registration] on the portal page. ▶ Remote UI Screen(P. 904)
- 3** Click [Device Management] ▶ [E-Mail Notification Settings] ▶ [Add Destination to Notify...].
- 4** Specify settings as necessary.

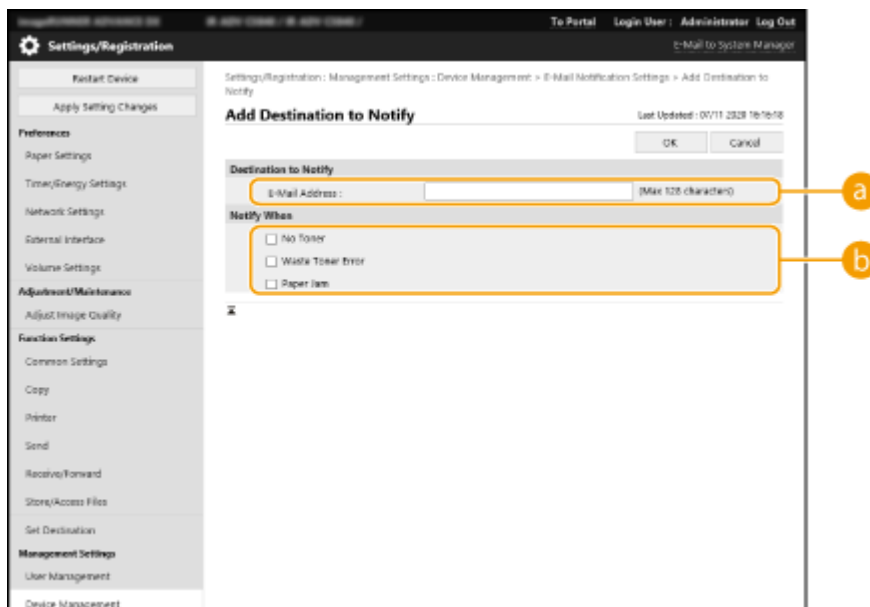

a [Destination to Notify]

Enter the e-mail address.

b [Notify When]

Select the information to send.

NOTE

- You can register up to five destinations.

- 5** Click [OK].

NOTE

- The result of sending the e-mail can be checked in [Status Monitor/Cancel] in [Job Log].
- This setting can only be specified by a user with Administrator privileges.
- This setting is not included in Device Information Distribution. ▶ **Distributing the Device Information to Other Canon Multifunction Printers(P. 1005)**
- This setting can only be imported from/exported to the same series machines. ▶ **Importing/Exporting the Setting Data(P. 946)**
- This setting is included in [Settings/Registration Basic Information] when batch exporting. ▶ **Importing/Exporting All Settings(P. 950)**

Installing System Options

961F-0K0



When using system options, you may need to log in with Administrator privileges to register licenses. To register a license, you will need the number that is printed on the license access number certificate. Make sure you have it with you before you start. You can perform license registration even if the machine is not connected to the network.

1 Perform a communication test.

- Test whether you can register the license over the network.

1 Press  (Settings/Registration).

2 Press <Management Settings> ► <License/Other> ► <Register/Update Software> ► <Software Management Settings>.

3 Press <Test Communication>.

⇒ The <Do you want to test communication?> message is displayed.

4 Press <Yes>.

⇒ The results of the communication test are displayed.

- If <NG> is displayed, check that the LAN cable is connected and the network settings are configured properly. ► **Setting up Using the Setup Guide(P. 250)**
- If you cannot connect to the network, register the license offline. ► **When Registration Cannot Be Performed over the Network(P. 987)**

2 Press  (Settings/Registration).

3 Press <Management Settings> ► <License/Other> ► <Register/Update Software> ► <Install Applications/Options>.

4 Press <License Access Number>, and enter the license access number.

5 Confirm the number, and press <Enable>.



6 Select the function to install, and press <Install>.

- If the license agreement screen is displayed, check the information and press <I Agree>.

- 7** Press  (Settings/Registration) ►  (Settings/Registration) ► <Apply Set. Changes> ► <Yes>.

■ When Registration Cannot Be Performed over the Network

If for some reason the machine is unable to connect to the network, register the license offline. First obtain a license key using a computer connected to the network, then register it by entering it into the machine. To obtain a license key, you will need the number that is printed on the license access number certificate, along with the serial number of the machine.

- 1** Access the license issuing website (<http://www.canon.com/lms/license/>) and obtain the license key.
 - Follow the on-screen instructions and enter the license access number and serial number to obtain the license key.
- 2** Press  (Settings/Registration).
- 3** Press <Management Settings> ► <License/Other> ► <Register License>.
- 4** Enter the license key.
- 5** Press <Enable> ► <OK>.
- 6** Press  (Settings/Registration) ►  (Settings/Registration) ► <Apply Set. Changes> ► <Yes>.

NOTE

Registering a license for a MEAP application

- You may also need to register a license when using a MEAP application. For more information, see  [Installing MEAP Applications\(P. 1559\)](#) .

Confirming the serial number

- The serial number is displayed in the bottom left of the screen when you press the  (Counter/Device Information) or the [Counter/Device Information] key (models with an upright control panel). It can also be confirmed from the Remote UI portal page.

Synchronizing Settings for Multiple Canon Multifunction Printers

961F-0K1

You can synchronize the personalized data of multiple Canon multifunction printers on a network. This enables the address book and Personal button/Shared button, etc. specified and registered on a single machine to be used on other machines that are synchronized. For information on the items subject to synchronization, see [List of Items That Can Be Personalized\(P. 357\)](#)

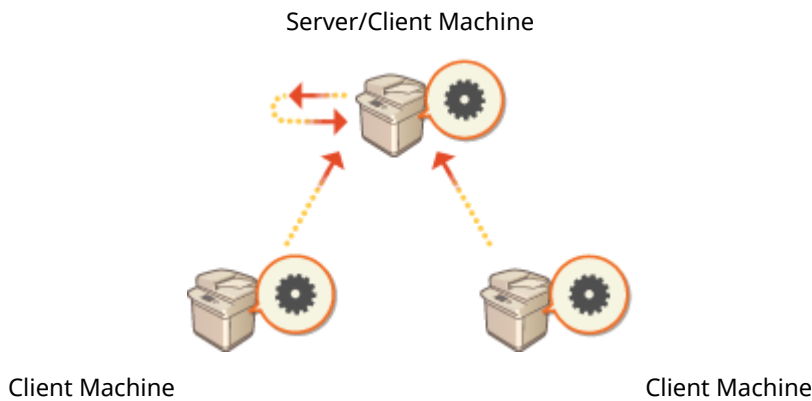

- ▶ [Starting Setting Synchronization\(P. 991\)](#)
- ▶ [Specifying Detailed Synchronization Settings \(Server Machine or Server/Client Machine\)\(P. 995\)](#)
- ▶ [Switching the Machines to Synchronize\(P. 1000\)](#)

NOTE

- Up to 10 machines including the server machine can be synchronized.
- Synchronized values may not be reflected, depending on the optional products and the machine configuration.
- A server machine can either be used as a server machine that does not synchronize its own data, or as both a server and client machine (server/client machine).
- If you do not start client functions on the server machine, data specified on the server machine will not be reflected in client machines.

Procedure for Synchronizing

Specify synchronization as indicated below.

1



Initial Check

- Are the machines to synchronize correctly connected to the network?





Exporting the User Data

- It is recommended that you export the user data for backup purposes. ▶ **Importing/Exporting the Setting Data(P. 946)**



Specifying the Server Machine Settings

- Start synchronization on the server machine. ▶ **Starting Setting Synchronization(P. 991)**



Specifying the Detailed Synchronization Settings

- Specify the detailed synchronization settings on the server machine. ▶ **Specifying Detailed Synchronization Settings (Server Machine or Server/Client Machine) (P. 995)**



Starting Synchronization

- Specify the connection destination on the client machines and start synchronization. ▶ **Starting Setting Synchronization(P. 991)**



Checking Synchronization

- Check the detailed synchronization settings, registered users, and connected machines on the server machine. ▶ **Specifying Detailed Synchronization Settings (Server Machine or Server/Client Machine)(P. 995)**

NOTE

- To change the scope of sharing, etc. after starting synchronization, shut down all the client machines, change the settings on the server machine, and start all the client machines again. ▶ **Specifying Detailed Synchronization Settings (Server Machine or Server/Client Machine)(P. 995)**
- Synchronization starts after the client machines are restarted.
- When a client machine starts and connects to the server machine, the user data registered in both the server machine and client machine is overwritten with the user data in the server machine, and the user data set in the client machine is deleted. To use the user data in a client machine to be connected to, delete the corresponding data from the server machine via <Delete User Data> in <Synchronize Custom Settings (Server)> before starting the client machine.

- If different data exists for the same user in multiple client machines that are started in succession, the user data in the client machine that first connected to the server is used for synchronization.



: Data of user 1



: Other data of user 1



: Data of user 2



: Data of user 3

<p>User data of client machine A</p> <ul style="list-style-type: none"> • The first client machine that connected to the server. • Has the data of user 1 and user 2 registered. 	<p>User data of client machine B</p> <ul style="list-style-type: none"> • Has the other data of user 1 and the data of user 3 registered. 	<p>User data registered in the server machine</p> <ul style="list-style-type: none"> • The data of user 1 registered in the server machine is synchronized using the data of client machine A.

- If a problem occurs in the server machine or a client machine after starting synchronization, the data with [Device-Specific (Not Shared)] set for its scope of sharing in the machine with the problem returns to its default settings and is not restored.
- A machine operating as a server machine will not completely enter sleep mode while one or more machines connected as a client machine are operating.
- If a machine operating as the server machine is also connected as a client machine and is set to connect to localhost via a proxy server, that machine will not completely enter sleep mode.
- To synchronize custom settings between machines, the machine authentication settings and group management settings must be the same. For information on specifying the same authentication settings, see the instructions for the login application. For group management settings, it is recommended that the settings in one machine are exported and imported into the other machines. When Department IDs are used for group management, set the same Department IDs for each machine.
- To synchronize the information regarding the network places for keychains, the order that the network places are registered must be the same in all machines.
- If a machine you are using is an older version, registered shortcuts and keychains may not be synchronized.
- While custom settings are synchronized, **<Action When Maximum Number of Users Exceeded>(P. 1346)** for both client machines and server machines is set to <Delete Oldest User Settings> and cannot be changed.
- Set the correct time in the SNTP settings (**<SNTP Settings>(P. 1097)**) before enabling the server functions in the machine operating as the server machine.
- If synchronization of custom settings (client) is started, the data subject to synchronization (including the Address Book) becomes unable to be imported or exported. For information on importing/exporting settings data, see **<Importing/Exporting the Setting Data(P. 946)** . For information on the data subject to synchronization of custom settings, see **<List of Items That Can Be Personalized(P. 357)** .

Starting Setting Synchronization

961F-0K2

Use the Remote UI to specify the settings for starting synchronization and start synchronization. Administrator privileges are required for registration.

Synchronizing Custom Settings

Specify the settings for the server machine and each client machine. Decide which machine to use as the server machine in advance.

- 1 Start the Remote UI. ▶ Starting the Remote UI(P. 902)
- 2 Click [Synchronize Custom Settings] on the portal page. ▶ Remote UI Screen(P. 904)
- 3 Click [Change Connection Destination...].
- 4 Specify the required settings.

a [Service]

Select [Start] to use the machine as the server machine.

b [Service]

Select [Start] to use the machine as a client machine.

NOTE

- To use the machine as a server/client machine, select [Start] for [Service] in both [Synchronize Custom Settings (Server)] and [Synchronize Custom Settings (Client)].

- 5 If the machine is a client machine, specify the other required settings.

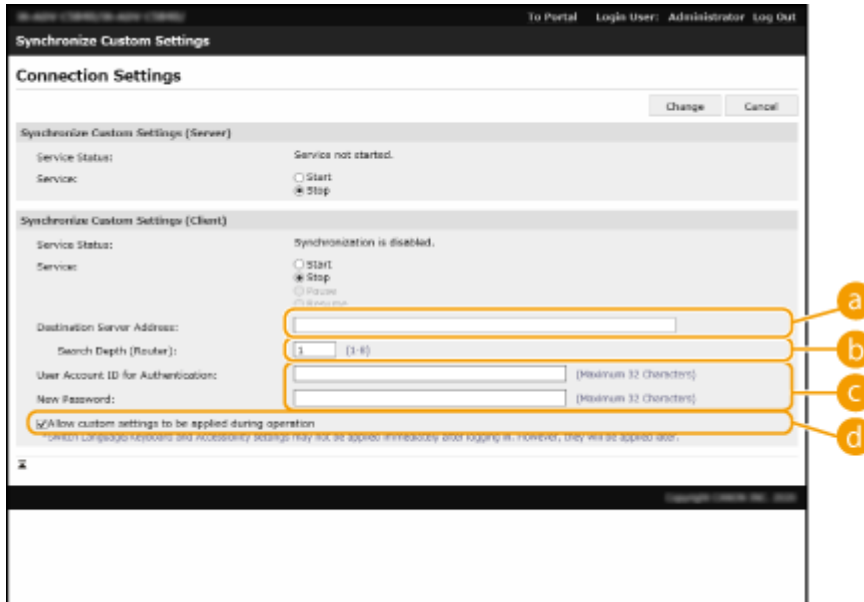

a [Destination Server Address:]

Enter the IP address or host name of the server machine. When specifying the port number, "8443" must be specified. The port number can be omitted. If this is left blank, the server machine is automatically discovered.

- Example settings (IPv4):
Using an IP address: 192.168.18.138
Using a host name: v4.server.canon.com
- Example settings (IPv6):
Using an IP address: fe80::65f0:82cb:b3d6:e6bc
Using a host name: v6.server.canon.com
When specifying the port number: [fe80::65f0:82cb:b3d6:e6bc]:8443

b [Search Depth (Router):]

Enter the number of routers to hop (the number of routers to communicate through). If this value is too small, the server machine may not be discovered with network discovery. If you do not want to communicate through routers, specify "1".

c [User Account ID for Authentication:]/[New Password:]

Enter the ID and password of a user account with Administrator privileges for the machine to use as the server machine.

d [Allow custom settings to be applied during operation]

Select the check box to reflect the <Switch Language/Keyboard>, <Accessibility>, and <Personal SSID and Network Key Settings> settings when it becomes possible if they could not be reflected immediately after logging in.

NOTE

- In the following cases, synchronization can be set without performing step 5.
 - When the machines to synchronize are within the same router.
 - When <Use User Authentication> is set to <On> on the server machine (see **<Use User Authentication>(P. 1326)**) and User Authentication is set as the login service (see **<Changing Login Services(P. 1569)**)
 - When nothing is entered in [User Account ID for Authentication:] on the client machines (the item is null)
 - When the service for synchronizing custom settings is started on the server machine (if the machine is a server/client machine, the setting can be changed by starting the server service and the client service at the same time)

- When there is only one server machine for synchronizing custom settings on the same network
- The client machine cannot connect via search in the following cases. Enter the IPv4 address for the destination server address.
 - If the network settings of the server machine include both IPv4 and IPv6, IPv6 is prioritized, and IPv6 is disabled on the client device
 - If the main line is used for the network settings of the server machine and the sub line is used for the network settings of the client machine
- If the sub line is used for the network settings of the server machine, specify the following settings.
 - Server and client machine: Enter the IP address of the main line or localhost as the address of the destination server.
 - Client machine: Enter the IP address of the sub line of the server machine as the address of the destination server.

6 Click [Change].

7 Restart the machine. ▶Turning OFF/Restarting the Machine(P. 911)



- This operation is not required for a server machine or server/client machine.
- If the machine is a server machine or server/client machine, continue to specify the detailed synchronization settings. ▶**Specifying Detailed Synchronization Settings (Server Machine or Server/Client Machine) (P. 995)**

NOTE

Checking the Communication Log for Synchronization

- You can check the communication log from the screen for synchronizing custom settings. The log can also be downloaded as a file.
- "Warning" is recorded as the level when the server machine cannot communicate temporarily.
- "Error" is recorded as the level when the maximum amount of data that can be registered has been exceeded or authentication with the server machine fails.

Simple Synchronization Settings

- Synchronization of custom settings can be started from the control panel for Canon multifunction printers within the same router.
 - For the server machine:
Press  (Settings/Registration) ▶ <Management Settings> ▶ <Device Management> ▶ set <Synchronize Custom Settings (Server)> to <Enable>.
 - For a client machine:
Press  (Settings/Registration) ▶ <Management Settings> ▶ <Device Management> ▶ set <Synchronize Custom Settings (Client)> to <Enable>.
- If the machine is used as a server/client machine, also set <Synchronize Custom Settings (Client)> to <Enable>.
- User Authentication must be enabled as the authentication method.

Note When Canceling Synchronization

- When a client machine cancels synchronization of custom settings, the client machine will become unable to retrieve the settings for each user registered in the server machine. Therefore note that the personalized data of a machine that was a client machine may not have the latest data after synchronization of custom settings has been canceled.

Specifying Detailed Synchronization Settings (Server Machine or Server/Client Machine)

961F-0K3

You can set the scope of sharing data to synchronize and manage the machines to synchronize. You can also delete user data and back up/restore synchronization data. This setting is only for the server machine or server/client machine.

- 1 Start the Remote UI. ▶ Starting the Remote UI(P. 902)
- 2 Click [Synchronize Custom Settings (Server)] on the portal page. ▶ Remote UI Screen(P. 904)
- 3 Perform the desired operation on the [Synchronize Custom Settings (Server)] screen.

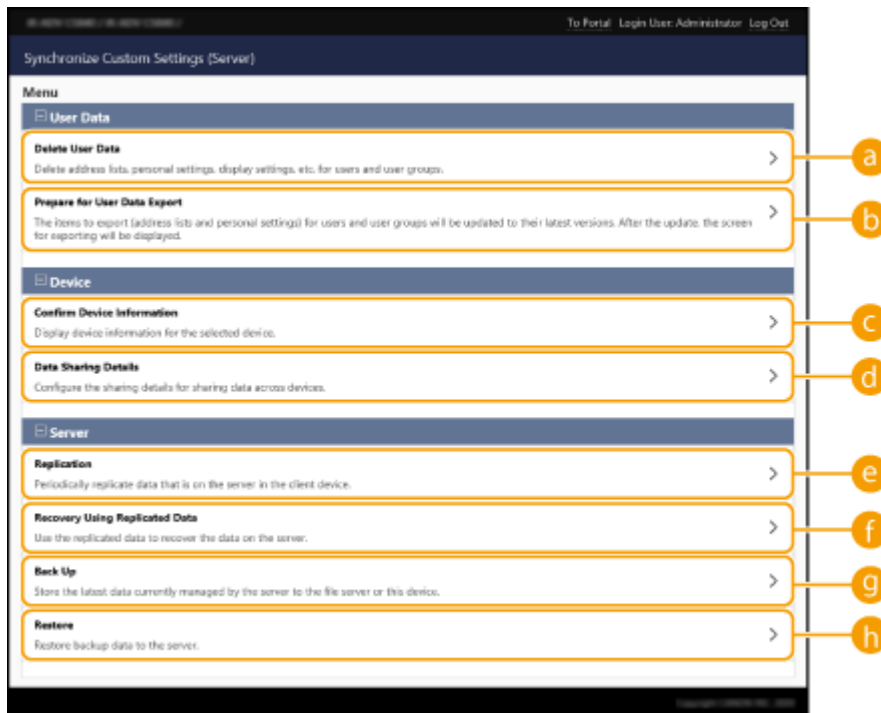

[User Data]

You can delete or update the user data that can be exported from the server machine.

a [Delete User Data]

Deletes user data by searching for a user name or group ID. Search with the search conditions left blank to display all the user data.

NOTE

- If custom setting synchronization (client) is started, the data in the server machine is prioritized when synchronizing the user data registered in both the server machine and client machines. To use the user data in a connected client machine, delete the corresponding user data from the server machine with this setting before starting custom setting synchronization (client).

b [Prepare for User Data Export]

If the server address of both the sever/client machine and the connection destination for custom setting synchronization (client) is localhost:8443, you can specify the user names and group IDs on the server/client machine and set the user data and group data on the client machines to match that of the server machine. In addition, for a period of 15 minutes following the successful execution of this function, you can use some import and export functions, even if custom setting synchronization (client) is in progress.  **Conditions for Removing Restrictions on the Importing/Exporting of Settings and Other Items(P. 948)**

NOTE

- On the user data export preparation screen, if you click [Search] without entering a user name or user group ID, all user names and user group IDs will be displayed.
- The maximum number of user names and user group IDs which can be selected is as follows. Note that users who are logged in via the touch panel display are included in the count.
 - Users: 500
 - User groups: 50
- It is recommended that no users log in during the period between successful execution of [Prepare for User Data Export] and completion of exporting user data. If exporting is performed after a user not specified in [Prepare for User Data Export] logs in following successful completion of [Prepare for User Data Export], user data specified in [Prepare for User Data Export] may be overwritten.

[Device]

Enables you to check the device information that is synchronized and set the scope of data sharing.

[Confirm Device Information]

Displays [Device Name], [Serial Number], and [Location] of synchronized machines. The machines can also be filtered.

[Data Sharing Details]

Set whether to share the synchronized data with all machines or retain settings in individual machines without sharing. For information on the items that are synchronized when [Device-Specific (Not Shared)] is set for all the items, see  **List of Items That Can Be Personalized(P. 357)** .

NOTE

- If this setting is changed from [Shared across All Devices] to [Device-Specific (Not Shared)] after starting operation, the shared data is synchronized on all machines before switching. (All machines will have the same data at first when the setting is switched.)
- If this setting is changed from [Device-Specific (Not Shared)] to [Shared across All Devices] after starting operation, the data in each machine is initialized before synchronization.
- The settings in shared buttons are also initialized when this setting is changed from [Device-Specific (Not Shared)] to [Shared across All Devices].
- The default job settings and setting history of the users registered in the server machine are initialized when [Device-Specific (Not Shared)] is selected for [Data Sharing Details]. Configure these settings again if they were changed from their default values.

[Server]

Enables you to periodically create replication data on another Canon multifunction printer to manage the server machine data and back up the server machine data.

NOTE

Difference between replication and backing up

- Replication involves periodically sending replicated data to the machine set as the replication destination automatically.

- Backing up enables you to save the latest data stored on the server machine. The data can be saved to an SMB server on the network in addition to the storage device of the machine operating as the server machine.

e [Replication]

Enables you to periodically copy the synchronization data stored on the server machine to a Canon multifunction printer. Specify a Canon multifunction printer on the same network as the destination. When the replication settings are correct, replication is executed at the following times.

- When replication is started
- At the interval set on the replication screen
- When the updated data exceeds the specified number
- When a machine with custom setting synchronization (client) started is restarted

NOTE

- When replacing a server machine that has executed the replication function, stop replication before replacing the machine. For more information, see **▶Changing the Server Machine (Server/Client Machine) (When Replication Is Set)(P. 1002)** .
- The backup and restore functions cannot be used while the replication function is executing. Stop replication before executing a backup.
- The [Interval:] setting of the replication function specifies the interval for executing the replication function and does not guarantee the time that the data is backed up. If the replication destination cannot be connected to via the network, the data is not replicated until the next replication.

f [Recovery Using Replicated Data]

Use replicated data stored in another Canon multifunction printer to restore the server machine.

NOTE

- It is recommended that you stop replication on the replication settings screen before performing recovery using replicated data.
- When performing recovery using replicated data, confirm that the time that the data was replicated indicated on the confirmation dialog is the expected time, and select [Yes].

g [Back Up]

Enables you to back up the synchronization data stored on the server machine. You can select [Device] or [Network] as the destination to store the backup data.

NOTE

- Backup data saved to [Device] cannot be restored if the storage device fails.

h [Restore]

Enables you to restore synchronization data that has been backed up.

4 Restart the machine to start synchronization. **▶Turning OFF/Restarting the Machine(P. 911)**

- This operation is not required for the server machine.

! IMPORTANT

- Data backed up to [Device] is automatically deleted when the next backup/restore/replication/recovery from replication data is performed. (The data is deleted even if the next backup/restore operation is performed for a network destination.)
- When recovery/restoration using replicated data is performed on a machine with different network settings (such as IP address, or host name) that will be changed to a server machine, synchronization

of settings cannot be performed because network settings differ, and therefore data changed during this period cannot be reflected. When changing to a new server machine, it is recommended that you use the same network settings as the old server machine.

NOTE

Changing the Scope of Sharing Data after Synchronization Has Been Started

- To change the scope of sharing data after synchronization has been started, stop synchronization on all the client machines, change the scope of sharing, then start synchronization on all the client machines again. **▶Starting Setting Synchronization(P. 991)**

If the Data in a Specific Client Machine Differs from the Server Machine

- If the data is correctly synchronized in multiple client machines but not synchronized in a specific client machine, follow the instructions displayed on the control panel. **▶Countermeasures for Each Message(P. 1425)**
- If the data in a specific client machine differs from the server machine but a message is not displayed, delete the user settings information, and log in again. (**▶Deleting User Setting Information(P. 850)**) If the message <Synchronize Custom Settings: Log in again for synchronization.> is displayed when logging in, log in again.

Check whether replication is executed periodically.

- The replicated data may not be sent due to a reason such as there being a problem in the network connection with the replication destination, the power of the machine specified as the replication destination being turned OFF, or the authentication information having been changed. Log in to the Remote UI as an administrator, select [Synchronize Custom Settings (Server)] ▶ [Server] ▶ click [Replication] ▶ check the displayed message.
 - The following message is displayed if replication has been executed correctly.
[Waiting for replication... To change the [Destination Device for Replication], first perform [Stop Replication], then change device. Last Replication : <yyyy/mm/dd hh:mm>]
 - The following message is displayed if replication has not been executed correctly.
[Could not perform replication after <yyyy/mm/dd hh:mm> because an error occurred. Check the settings for [Destination Device for Replication] and the status of the destination device.]

■ If an error occurs when starting replication

The following messages are displayed if replication does not execute correctly when starting replication.

[The [Address] is incorrect.]

In this case, check whether the machine set as the replication destination is connected to the same network.

[The authentication information is incorrect.]

In this case, check whether the System Manager ID and password of the machine set as the replication destination are set correctly.

[A device that cannot be used as the destination for replication is set. Select a different device.]

In this case, check the network status of the machine set as the replication destination. A machine cannot be set as the replication destination in the following cases.

- If the machine has started custom setting synchronization (server)
- If another server is set as the replication destination
- If the version of the machine is old

- If <Department ID Management> is enabled on the machine

■ If an error code is displayed

If a problem occurs during data backup/restoration, an error code is displayed on the screen after executing the backup and the result field of the execution log. The cause of each error code is indicated below.

DBBU01	Failed to generate the backup file (device).
DBBU05	Failed to generate the backup file (network).
DBBU06	Failed to generate the backup file due to lack of free space.
DBBU08	Cannot find the network destination.
DBBU07	Cannot access the network destination.
DBBU02	Failed to save the backup data.
DBRS01	Failed to restore data from the machine.
DBRS02	Failed to restore data from the network destination.
DBRS08	Cannot find the network destination.
DBRS07	Cannot access the network destination.

NOTE

- If DBBU02 or DBRS02 is displayed, an error with an unidentified cause may have occurred. Check the following.
 - Whether the settings are entered correctly
 - The access privileges for the SMB server
 - The network environment

Switching the Machines to Synchronize

961F-0K4

This section describes the procedure for switching the machines to synchronize after starting synchronization of custom settings.

- ▶ **Changing the Server Machine (Server/Client Machine)(P. 1000)**
- ▶ **Changing the Server Machine (Server/Client Machine) (When Replication Is Set)(P. 1002)**
- ▶ **Changing a Client Machine(P. 1003)**

Changing the Server Machine (Server/Client Machine)

■ Changing a Synchronized Client Machine to the Server Machine

Follow this procedure to change a client machine to the server machine.

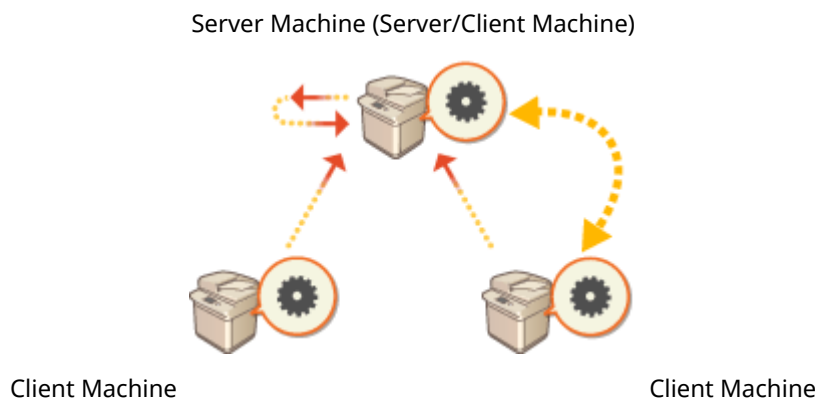

- 1 Stop synchronization in [Synchronize Custom Settings] in the Remote UI of each client machine. ▶ Starting Setting Synchronization(P. 991)**
- 2 Create backup data in [Synchronize Custom Settings (Server)] ▶ [Back Up] ▶ [Network] in the Remote UI of the server machine (server/client machine). ▶ Specifying Detailed Synchronization Settings (Server Machine or Server/Client Machine)(P. 995)**
- 3 Stop synchronization in [Synchronize Custom Settings] in the Remote UI of the server machine (server/client machine). ▶ Starting Setting Synchronization(P. 991)**
- 4 Start synchronization in [Synchronize Custom Settings] in the Remote UI of the new server machine (server/client machine). ▶ Starting Setting Synchronization(P. 991)**
- 5 Restore the backup data from step 2 in [Synchronize Custom Settings (Server)] in the Remote UI of the new server machine (server/client machine). ▶ Specifying Detailed Synchronization Settings (Server Machine or Server/Client Machine)(P. 995)**

6 Change the address of the destination server in [Synchronize Custom Settings] in the Remote UI of each client machine, and start synchronization of custom settings. ▶ Specifying Detailed Synchronization Settings (Server Machine or Server/Client Machine)(P. 995)

- The client machines must be restarted after configuring synchronization.

■ Changing an Unsynchronized Client Machine to the Server Machine

Follow this procedure to change a new machine to the server machine.

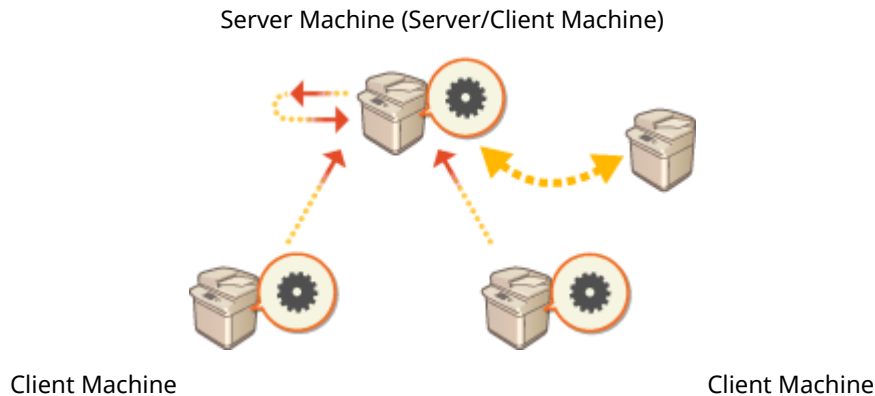

NOTE

- If the machine is used as a server/client machine, it is recommended that you stop [Synchronize Custom Settings (Client)] in advance.

1 Create backup data in [Synchronize Custom Settings (Server)] ▶ [Back Up] ▶ [Network] in the Remote UI of the server machine (server/client machine). ▶ Specifying Detailed Synchronization Settings (Server Machine or Server/Client Machine)(P. 995)

NOTE

- If you cannot access [Synchronize Custom Settings (Server)], use past backup data.

2 Start synchronization in [Synchronize Custom Settings] in the Remote UI of the new server machine (server/client machine). ▶ Starting Setting Synchronization(P. 991)

3 Restore the backup data from step 1 in [Synchronize Custom Settings (Server)] in the Remote UI of the new server machine (server/client machine). ▶ Specifying Detailed Synchronization Settings (Server Machine or Server/Client Machine)(P. 995)

NOTE

- When changing to a new server machine (server/client machine), it is recommended that you use the same network settings (such as IP address and host name) as the old server machine.
- If the network settings (IP address and host name) of the new server machine (server/client machine) differ from the settings of the previous server machine (server/client machine), it is necessary to set the destination server machine (server/client machine) from the client machine again.

Changing the Server Machine (Server/Client Machine) (When Replication Is Set)

■ When Restoring the Replication Data to a New Server Machine

Follow this procedure to restore a server that has had its storage device replaced, etc.

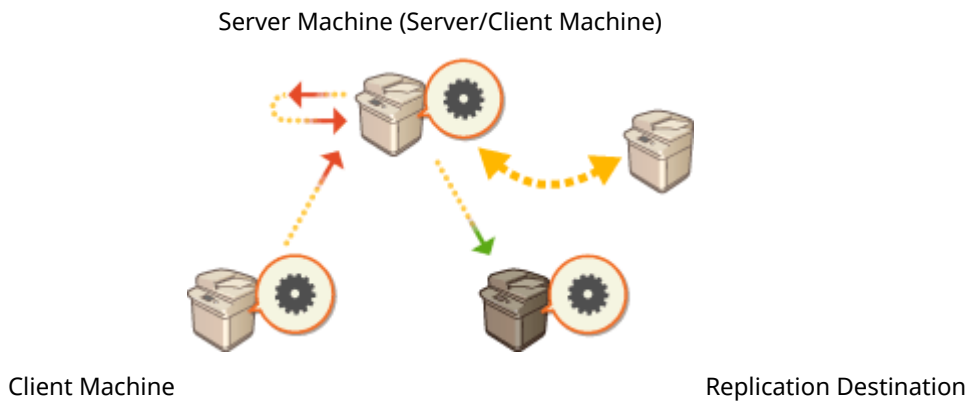

- 1** From the Remote UI of the server machine (server/client machine), click [Synchronize Custom Settings (Server)] ▶ [Replication] ▶ [Stopped] to stop replication.

NOTE

- If synchronization cannot be stopped because the server machine is not working, etc., this step is not necessary.

- 2** From the Remote UI of the new server machine (server/client machine), click [Synchronize Custom Settings (Server)] ▶ [Recovery Using Replicated Data] ▶ specify the machine to use as the replication destination ▶ restore the replication data.

NOTE

- If the IP address and host name of the server machine have not changed, the subsequent steps are not required.

- 3** Stop synchronization in [Synchronize Custom Settings] in the Remote UI of each client machine. ▶ Starting Setting Synchronization(P. 991)

- 4** Change the address of the destination server in [Synchronize Custom Settings] in the Remote UI of each client machine, and start synchronization of custom settings. ▶ Specifying Detailed Synchronization Settings (Server Machine or Server/Client Machine)(P. 995)

- The client machines must be restarted after configuring synchronization.

■ When Using the Machine Set as the Replication Destination as a New Server Machine

Follow this procedure to use the Canon multifunction printer set as the replication destination as a server machine.

Server Machine (Server/Client Machine)

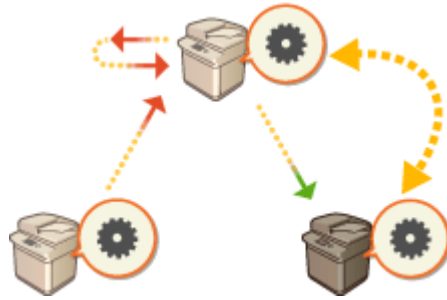

Client Machine

Replication Destination

- 1 From the Remote UI of the server machine (server/client machine), click [Synchronize Custom Settings (Server)] ▶ [Replication] ▶ [Stopped] to stop replication.**

NOTE

- If synchronization cannot be stopped because the server machine is not working, etc., this step is not necessary.

- 2 Start synchronization in [Synchronize Custom Settings] in the Remote UI of the machine set as the replication destination (the new server machine). ▶Starting Setting Synchronization(P. 991)**
- 3 Stop synchronization in [Synchronize Custom Settings] in the Remote UI of each client machine. ▶Starting Setting Synchronization(P. 991)**
- 4 Change the address of the destination server in [Synchronize Custom Settings] in the Remote UI of each client machine, and start synchronization of custom settings. ▶ Specifying Detailed Synchronization Settings (Server Machine or Server/Client Machine)(P. 995)**

- The client machines must be restarted after configuring synchronization.

NOTE

When Replication Cannot Be Stopped on the Server Machine

- If replication could not be stopped from the server machine because the server machine is not working, etc., the machine that was set as the replication destination cannot be set as the replication destination by another server machine. Start synchronization as the server machine in [Synchronize Custom Settings] in the Remote UI for the replication destination machine, then stop synchronization from [Synchronize Custom Settings (Server)]. ▶Starting Setting Synchronization(P. 991)

Changing a Client Machine

Follow this procedure to change a client machine to a new machine.

Server Machine (Server/Client Machine)

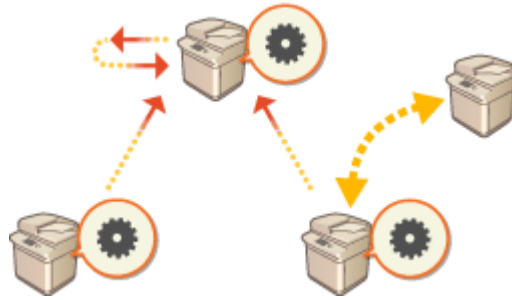

Client Machine

Client Machine

1 Stop synchronization from [Synchronize Custom Settings] in the Remote UI of the target client machine. ▶Starting Setting Synchronization(P. 991)

NOTE

- If the client machine cannot be operated, delete the target client machine in [Synchronize Custom Settings (Server)] ▶ [Confirm Device Information] in the Remote UI of the server machine (server/client machine).

2 Configuring Synchronization on a New Client Machine. ▶Starting Setting Synchronization(P. 991)

NOTE

- If synchronization was not correctly stopped on a client machine or if the client machine was not deleted in [Synchronize Custom Settings (Server)] ▶ [Confirm Device Information] in the Remote UI of the server machine (server/client machine), that client machine will be counted as still in use.

Distributing the Device Information to Other Canon Multifunction Printers

961F-0K5

Various machine settings (device information) can be sent over the network and automatically applied to other Canon multifunction printers. With this function, you can designate a host machine whose registered information (such as the settings in the Settings/Registration menu and address lists) is distributed to other client machines, enabling you to configure the same settings as the host machine. This makes it easier to incorporate new multifunctional printers into your system, and it enables you to operate multiple machines with the same settings, which simplifies management operations even when you increase the number of machines. For more information on the machine information that can be distributed, see [▶Settings/Registration\(P. 1054\)](#) .

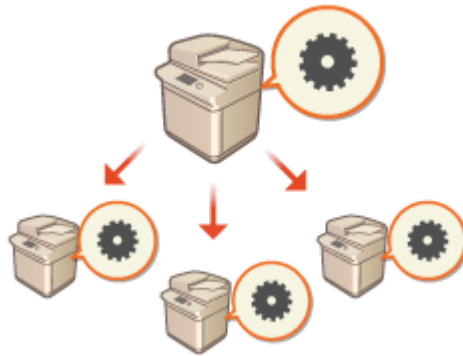

- ▶[Registering the Device Information Destinations\(P. 1007\)](#)
- ▶[Performing User Authentication when Distributing Device Information\(P. 1009\)](#)
- ▶[Distributing the Device Information\(P. 1011\)](#)
- ▶[Checking the Results of Device Information Distribution\(P. 1014\)](#)

NOTE

- If both the host and client machines are imageRUNNER ADVANCE series models, the device information can be distributed. It is also possible to receive some setting information from models other than those in this series. However, some information may not be distributed properly. ▶[<Device Information Distribution Settings>\(P. 1332\)](#)
- Some device information may not be distributed properly when certain optional equipment is attached to the machine.

Configuring the Distribution Settings

Follow the procedure below to perform distribution.



Check the basic configuration.

- Are the host and client machines connected properly over the network?
- Are the TLS key and certificate configured on the client machine?

▶[Configuring the Key and Certificate for TLS\(P. 864\)](#)

NOTE

- When automatically searching for the client machines, make sure that the SLP communication is available between the machines. ▶[Monitoring the Machine From Device Management Systems\(P. 310\)](#)



2



Register the distribution destination of the device information.

- On the host machine, register the client machines that will receive the distributed device information. ▶ **Registering the Device Information Destinations(P. 1007)**
- To perform user authentication when device information is received, configure the necessary settings on the host and client machines. ▶ **Performing User Authentication when Distributing Device Information(P. 1009)**



3



Distribute the device information.

- ▶ **Distributing the Device Information(P. 1011)**



4



On the host and client machines, check the results of device information distribution.

- ▶ **Checking the Results of Device Information Distribution(P. 1014)**

Registering the Device Information Destinations

961F-0K6

On the host machine, register the client machines that will receive the distributed device information. Administrator privileges are required in order to perform registration.

- 1 Press  (Settings/Registration).
- 2 Press <Management Settings> ► <Device Management> ► <Device Information Distribution Settings> ► <Register Destinations>.
- 3 Register the destination client machines.

- 1 Press <Auto Search/Register>.
- 2 Search for the destination client machines.
 - Press <->/<+> for <Search Depth (Router)> to specify the search range, then press <Start Auto Search>.

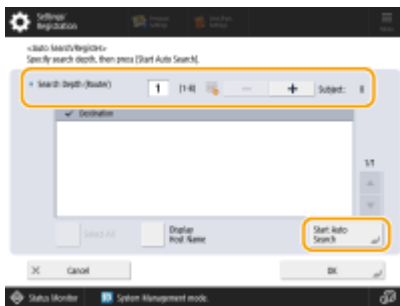

⇒ The multifunctional printers on the network are displayed.

- 3 Select the device information destinations (clients) in <Destination>, and press <OK>.
 - Press <Display Host Name> to display the host names for the multifunctional printers shown in <Destination>.

■ Registering destinations manually

When destinations (clients) cannot be searched automatically, you can register them manually by entering the IP address or domain name.

- 1 Press <Register>.
- 2 Enter the IP address or domain name of a destination (client), and press <OK>.
 - When entering the domain name, make sure to enter the entire name, including the domain, subdomain, and host name.

NOTE

- If a connection cannot be established with a specified destination, or if it is configured not to receive device information, the <Could not retrieve the device information details. Do you want to register the device as a destination?> message is displayed. If you press <Yes>, the destination can be registered but the device information cannot be distributed.

4 Press <OK>.

LINKS

- ▶ **Performing User Authentication when Distributing Device Information(P. 1009)**
- ▶ **Distributing the Device Information(P. 1011)**
- ▶ **Checking the Results of Device Information Distribution(P. 1014)**

Performing User Authentication when Distributing Device Information

961F-0K7

You can prevent a client machine from receiving unauthorized device information by performing user authentication when device information is received. With these settings, it will be necessary to use the personal authentication management function ([▶Configuring the Personal Authentication Management Settings\(P. 806\)](#)) on both the host machine and client machines that send and receive the device information. Administrator privileges are required in order to configure these settings.

- ▶[Configuring the Authentication Information on the Host Machine\(P. 1009\)](#)
- ▶[Starting the Authentication Function on the Client Machine\(P. 1009\)](#)

Configuring the Authentication Information on the Host Machine

On the host machine that distributes the device information, you can set the user name and password used for authentication. You can also specify the domain based on the authentication device.

- 1 Press  (Settings/Registration).
- 2 Press <Management Settings> ▶ <Device Management> ▶ <Device Information Distribution Settings> ▶ <Set MEAP Authentication>.
- 3 Configure the necessary information, and press <OK>.



a <User Name>/<Password>

Enter the user name and password of an administrator with Administrator privileges. Make sure that this administrator is registered as a user on the client machine and on the authentication server used by the client machine.

b <Login Destination>



If the administrator specified in [a](#) is registered on the authentication server, enter the NetBIOS domain name of the authentication server.

Starting the Authentication Function on the Client Machine

You can configure the client machine so that personal authentication is performed when receiving the device information. Make sure that the administrator with the authentication information configured on the host machine ([▶Configuring the Authentication Information on the Host Machine\(P. 1009\)](#)) is registered on the client machine before performing this procedure.

- ▶[Registering User Information in the Local Device\(P. 809\)](#)

🔴 Registering Server Information(P. 823)

- 1** Press  (Settings/Registration).
- 2** Press <Management Settings> ▶ <Device Management> ▶ <Device Information Distribution Settings> ▶ <Use MEAP Authentication When Receive>.
- 3** Select <On>, and press <OK> ▶ <OK>.
- 4** Press  (Settings/Registration) ▶  (Settings/Registration) ▶ <Apply Set. Changes> ▶ <Yes>.

Distributing the Device Information

961F-0K8

You can distribute device information to the client machines that are registered as destinations. You can also specify a time at which to automatically distribute the device information. To perform these operations, log in with Administrator privileges. Also, because TLS encryption is used when distributing device information to the client machines, make sure to configure the TLS settings on the client machines before performing the procedures described below. [▶Configuring the Key and Certificate for TLS\(P. 864\)](#)

IMPORTANT

- If the System Manager ID and PIN of the client machine are different from that of the host machine, the device information cannot be distributed. [▶Changing the System Manager ID and PIN\(P. 840\)](#)
- It may take several minutes to prepare for the device information distribution process, or to update the information after it is received. Do not turn OFF the machine until the preparation or update process is complete. Doing so may cause the machine to malfunction.
- The setting update screen is displayed on the client machine that receives the device information, and no operations can be performed until the update is complete. It is recommended that you distribute the device information at a time when there are no users.

[▶Distributing the Device Information Manually\(P. 1011\)](#)

[▶Distributing Automatically at a Specified Time\(P. 1012\)](#)

Distributing the Device Information Manually

1 Press  (Settings/Registration).

2 Press <Management Settings> ▶ <Device Management> ▶ <Device Information Distribution Settings> ▶ <Manual Distribution>.

3 Press <On> for the information to distribute, and press <Next>.

- If <On> is selected for <Settings/Registration Value>, the screen for setting whether or not to distribute the <Network Settings> device information is displayed. To distribute this information, press <Include> ▶ <OK>.

4 Select the destinations, and press <Start Manual Distribution>.

- ▣ The device information is distributed. When distribution is complete, the distribution results are displayed in <Status>.
- To cancel distribution, press <Cancel>. Note, however, that the distribution process that is currently being performed cannot be canceled. The next and subsequent distribution processes are canceled.

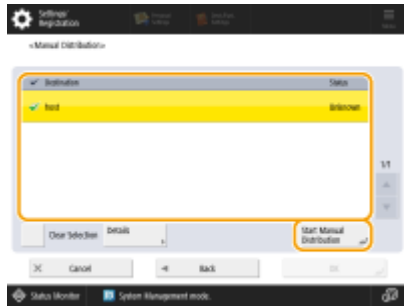

Distributing Automatically at a Specified Time

You can specify a time at which to automatically distribute the device information. By configuring the time so that distribution is performed late at night or on a holiday, you can update the device information without affecting your business operations.

- 1 Press  (Settings/Registration).
- 2 Press <Management Settings> ▶ <Device Management> ▶ <Device Information Distribution Settings> ▶ <Set Auto Distribution>.
- 3 Select <Everyday> or <Specify Days>, then specify the distribution times.
 - For <Everyday>, select a number and enter a time.
 - For <Specify Days>, select a day and enter a time.
- 4 Press <Next>.
- 5 Press <On> for the information to distribute, and press <Next>.
 - If <On> is selected for <Settings/Registration Value>, the screen for setting whether or not to distribute the <Network Settings> device information is displayed. To distribute this information, press <Include> ▶ <OK>.
- 6 Select the destinations, and press <OK>.
 - The device information is set to be distributed automatically at the specified time.

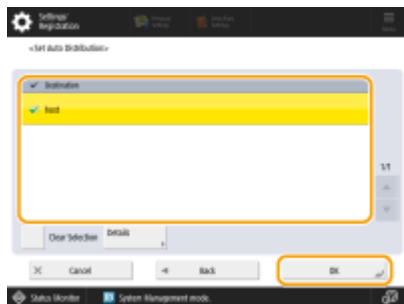

NOTE

Distribution and update of device information

- The device information may not be distributed or updated when the client machine is processing other data.
- If a client machine is unable to receive the automatically distributed device information at the specified time, distribution is not performed again until the next specified time.

Receiving device information from different Canon multifunction printer models

- When the machine is used as a client machine, it can receive device information from different Canon multifunction printer models by setting <Restrict Receiving Device Information> in <Receiving Settings> to <Off>. Note, however, that some of the information may not be distributed correctly.

Selecting the functions to receive device information for

- When the machine is used as a client machine, you can restrict the functions to receive information for by setting <Restrict Receiving for Each Function> in <Receiving Settings> to <Off>.

Restoring the previous device information

- You can perform operations on the client machine to restore the device information that existed before the update was performed. However, you can only restore the information that existed immediately prior to the update. Information older than that cannot be restored. Note also that the settings for <URL Send Settings> in <Set/Register Confidential Fax Inboxes> (▶<Set/Register Confidential Fax Inboxes>(P. 1273)) may be erased if the data for <Settings/Regist. Value> and <Address Book> are not restored at the same time. ▶<Device Information Distribution Settings>(P. 1332)

LINKS

- ▶<Registering the Device Information Destinations>(P. 1007)

Checking the Results of Device Information Distribution

961F-0K9

You can check information such as the date and time that device information was distributed, the results of distribution, and the status of the other machines. For client machines, you can check the reception status of device information. You can also print the details. Administrator privileges are required in order to perform these operations.

1 Press  (Settings/Registration).

2 Press <Management Settings> ▶ <Device Management> ▶ <Device Information Distribution Settings> ▶ <Communication Log>.

3 Check the communication log, and press <OK>.

- The log of previously distributed device information is displayed in a list. <OK> indicates that device information was distributed/received properly. <NG> indicates that distribution was canceled or an error occurred.
- To display the details of an item in the list, select the item and press <Details>.
- To print a Device Information Communication Log Report, press <Print List>.  **Outputting a Communication Result Report(P. 1029)**
- To specify how to print the Device Information Communication Log Report, press <Report Settings>.

Managing Storage Device Data

961F-0KA



Information such as files in the Advanced Space or Mail Box, Address Book data, existing job data, and password information are saved to the storage device of the machine. The machine encrypts this information, preventing it from being read by unauthorized users. The machine is also equipped with the Canon MFP Security Chip, which complies with the FIPS 140-2 Level 2 security standard established by the U.S. government. The Canon MFP Security Chip is certified as a cryptographic module under the Cryptographic Module Validation Program (CMVP) established by the U.S. and Canada, as well as the Japan Cryptographic Module Validation Program (JCMVP). The certification given to the Canon MFP Security Chip ensures that results of the standardized test show the conformity of the test subject with the prescribed standards.

The TPM setting can also be used to encrypt the password information and certificate information managed in the memory.

▶ **Initializing All Data/Settings(P. 1016)**

▶ **Using TPM(P. 1018)**

IMPORTANT

- Storage device data encryption on the machine may not be able to protect data from all unauthorized activity. Exercise caution when managing data.
- Encrypted data cannot be read even if you remove the storage device and install it in another Canon multifunction printer.

NOTE

- This machine generates 256-bit encryption keys using a NIST SP 800-90A random number generation method. For encryption, the machine uses an AES algorithm in accordance with FIPS PUB 197.

Initializing All Data/Settings

961F-0KC



You can restore all of the machine settings to the factory default setting. All of the data remaining on the storage device is overwritten with 0 (null) or other data, which prevents the external disclosure of sensitive data when replacing or disposing of the storage device. Administrator privileges are required in order to perform initialization.

! IMPORTANT

- Before initializing, make sure that there are no documents being processed or waiting to be processed. These documents will be deleted when initialization is performed.
- Do not turn OFF the machine during initialization. Doing so may lead to defects in the memory of the machine.
- Initialization may take 30 minutes or more to complete. The machine cannot be used during the initialization process.
- If you perform **><Initialize All Data/Settings>(P. 1356)** when the Copy Card Reader is attached, it is necessary to reinstall the Copy Card Reader. For more information, contact your dealer or service representative.

NOTE

Before performing initialization

Back up your important data or export it as a file.

- Data saved on the machine **><Backing Up/Restoring Data(P. 965)**
- Machine setting information **><Importing/Exporting the Setting Data(P. 946)**
- User authentication information registered in the local device for personal authentication management **><Registering User Information in the Local Device(P. 809)**
- MEAP application license files **><Managing MEAP Applications(P. 1562)**
- Data stored by MEAP applications (For information on how to back up the data, see the instruction manual for each MEAP application.)

When using a password to protect the security policy settings

- You need to enter the password to initialize the machine settings. **><Using a Password to Protect the Security Policy Settings(P. 793)**

- 1** Press  (Settings/Registration).
- 2** Press **<Management Settings>** ▶ **<Data Management>** ▶ **<Initialize All Data/Settings>**.
- 3** Press **<Yes>**.

- ➡ Initialization is performed. After the process is complete, the machine restarts and the Initialize All Data/Settings Report is printed.
- When the <A security policy is applied to this device.> message is displayed, a password must be entered by the security administrator. For more information, contact your security administrator. ▶ **Applying a Security Policy to the Machine(P. 792)**

NOTE

- Although the job log information can be deleted by initializing all data/settings, the result of printing the Initialize All Data/Settings Report is recorded in the print log. ▶ **Checking the Printing Status and History(P. 602)**

TIPS

- It is also possible to individually select some machine settings and restore their factory default values. ▶ **Settings/Registration(P. 1054)**

Using TPM

If the TPM setting is activated and backed up on to the USB memory, you can safely store in the TPM chip the encryption key (TPM key) that encrypts confidential information such as the password, public key pair for SSL communication, and user certificate that are stored in the machine. Doing so, you can prevent important information for the machine from leaking. Also, you can recover the system if the TPM chip fails by restoring the TPM key.

▶ **Setting TPM(P. 1018)**

▶ **Backing Up the TPM Key(P. 1019)**

▶ **Restoring the TPM Key(P. 1020)**

IMPORTANT

- Before activating the TPM setting, an administrator must confirm that the Administrator password has been changed from its default setting. If the password has not been changed from its default setting, third parties other than an administrator can make backups, which may result in the TPM backup key from being taken away. Since the TPM key can only be backed up once, this will make the TPM key unable to be restored.
- Backup the TPM key immediately on to the USB memory after the TPM setting is activated.
- For security reasons, you can only backup the TPM key once. Manage the password set during the backup so that it is not forgotten.
- The security provided by TPM does not guarantee complete protection of the data and hardware. Note that Canon will not be liable for any failure or damages resulting from the use of this mode.
- You cannot access the machine while backing up or restoring data in the USB memory.
- Do not remove the USB memory while backing up or restoring data. Doing so may cause damage to the USB memory, USB port, or the data inside of the USB memory. Also if the USB memory is removed when restoring, the machine may be damaged.
- To use USB memory, press  (Settings/Registration) ▶ <Preferences> ▶ <External Interface> ▶ <USB Settings> ▶ set <Use MEAP Driver for USB Storage Device> to <Off>.

Setting TPM

This section explains how to activate the TPM setting.

1 Press  (Settings/Registration).

2 Press <Management Settings> ▶ <Data Management> ▶ <TPM Settings>.

3 Press <Yes>.

- Setting changes are reflected after the machine restarts.

NOTE

- If the TPM setting is activated, it may take longer to start the machine.

Backing Up the TPM Key

If the TPM setting is activated and the TPM chip fails, you cannot recover the confidential information since each type of confidential information is uniquely encrypted with the TPM key. Thus, immediately backup when the TPM setting is activated.

For backing up, use the commercially available USB memory.

- 1** Press  (Settings/Registration).
- 2** Press <Management Settings> ▶ <Data Management> ▶ <TPM Settings>.
- 3** Press <Back Up TPM Key>.
- 4** Press <Password>.
- 5** Enter the password ▶ press <OK>.
- 6** Enter the password again on the confirmation screen ▶ press <OK> ▶ <OK>.
- 7** Connect the USB memory to the machine ▶ press <OK>.

- If the error screen appears, follow the instructions on the screen and backup again.

IMPORTANT

- Before backing up, make sure that writing is allowed for the memory media connected to the machine.
- You cannot back up the TPM key for the following cases:
 - The password is incorrect
 - USB memory is not connected
 - Multiple USB storage devices are connected
 - Not enough free space in the connected USB memory
 - TPM key does not exist on the machine
- Use USB memory that meets the following conditions:
 - Not set to read-only
 - Not partitioned
 - Less than 60 GB capacity
 - Not encrypted
- For the backup of the TPM key, it is recommended that you use a USB memory with free space of 10 MB or more.
- Do not connect any other memory media.

- The data on the machine is backed up on the USB memory after it has been encrypted. You cannot manage or browse the backed up data on the computer.
- For information on the USB memory that can be used with the machine and how to use it, see **▶Connecting a USB Memory Device(P. 23)** .

Restoring the TPM Key

If the TPM chip fails, you can use the previously backed up data of the TPM key to restore the TPM key on to the new TPM chip. For information on TPM chip failure, contact your dealer or service representative.

- 1 Press  (Settings/Registration).**
- 2 Press <Management Settings> ▶ <Data Management> ▶ <TPM Settings>.**
- 3 Press <Restore TPM Key>.**
- 4 Press <Password>.**
- 5 Enter the password you specified when backing up ▶ press <OK> ▶ <OK>.**
- 6 Connect the USB memory to the machine ▶ press <OK>.**
 - If an error screen is displayed, follow the instructions on the screen to perform the restoration process again.

IMPORTANT

- Before restoring, make sure that the memory media you used for backing up is connected to the machine.
- Do not connect any other memory media.

- 7 Press <OK> to restart the system.**

IMPORTANT

- Restoring of the TPM key recovers access to the storage device/SRAM that became inaccessible due to TPM chip failure, and does not recover the content of the memory itself.
- If initialization is performed following the steps for "**▶Initializing All Data/Settings(P. 1016)** ," all of the data encrypted by the TPM key is completely erased and the TPM setting becomes inactive.
- You cannot restore the TPM key for the following cases:
 - USB memory is not connected
 - Multiple USB storage devices are connected
 - A TPM key does not exist on the USB memory
 - The TPM key on the USB memory is not correct

- The password set during the backup was not entered

Functions Linked to Cloud Service

961F-OKF

You can check the usage status of the device and the user by linking to cloud service, depending on the model of the machine you are using.

uniFLOW Online Express(P. 1022)

uniFLOW Online Express

By creating "tenants" in the cloud, and registering the user information and devices, you can use the following functions without building a server.

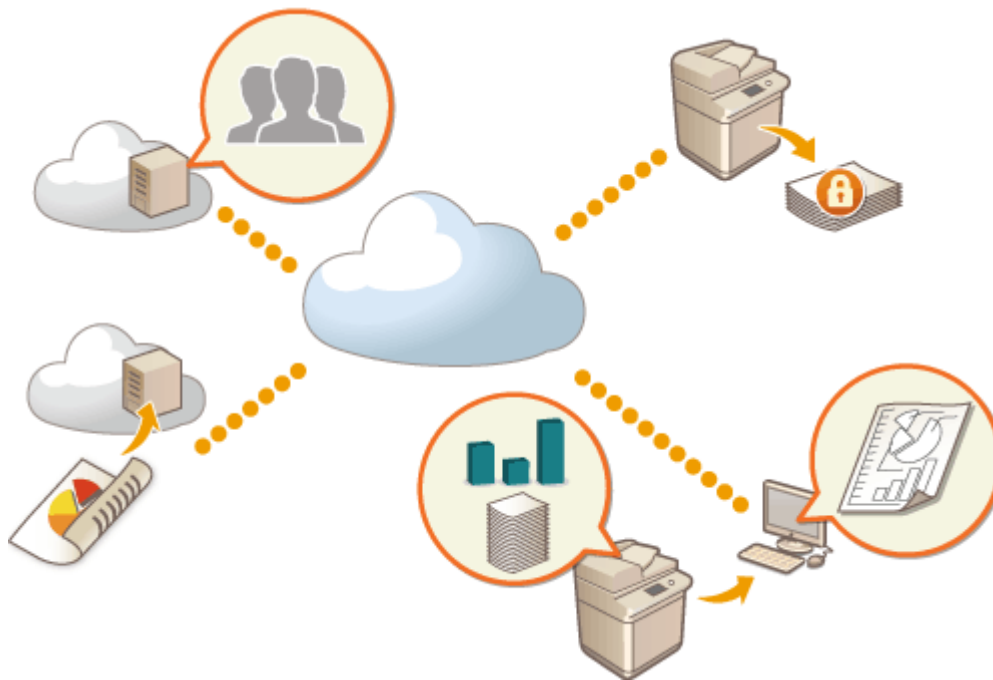

NOTE

- For instructions on creating and accessing a tenant, contact your dealer or service representative.
- For details on uniFLOW Online Express, see " **First Steps Guide** ".

■ "Authentication Function" That Creates a Secure Device Usage Environment

By registering users and devices to uniFLOW Online Express, you can create a secure and personalized print environment without the need for a local server. In this environment, for example, you can help prevent troubles where a user takes away prints left by someone else, or you can customize the device screen only for yourself. The following can be performed using the authentication function of uniFLOW Online Express:

- Managing the user information for the authentication function
- Managing the authentication information such as ID cards and PIN codes
- Switching the authentication method and authentication system*

*For administrators only

■ "Accounting and Reporting Function" That Enables Checking Logs and Costs

This function calculates the usage of devices registered/connected to the same tenant on uniFLOW Online Express, and then creates a report. By linking with the authentication function of uniFLOW Online Express, this function enables you to check the usage log of each user, and create cost tables for each copied/scanned page so that you can calculate/check the cost for each device.

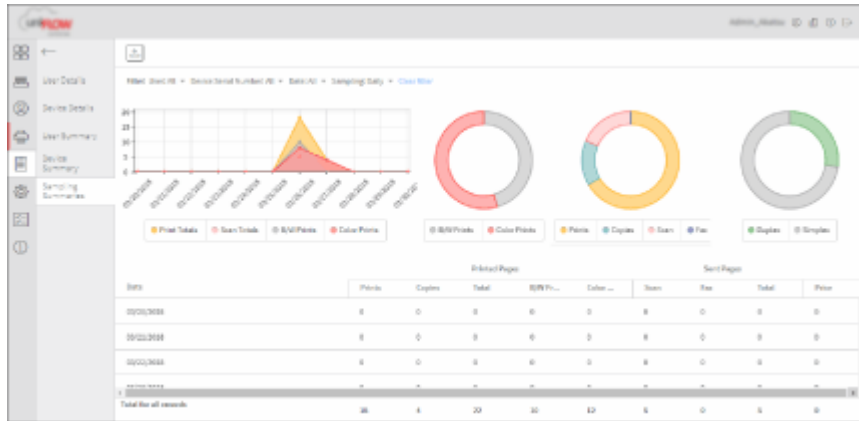

■ "Simple Scan Function" That Sends Scanned Data to an E-Mail Address or in the Cloud

This function enables you to send scanned documents to your e-mail address (Scan to Myself), or directly store them in the external cloud service.

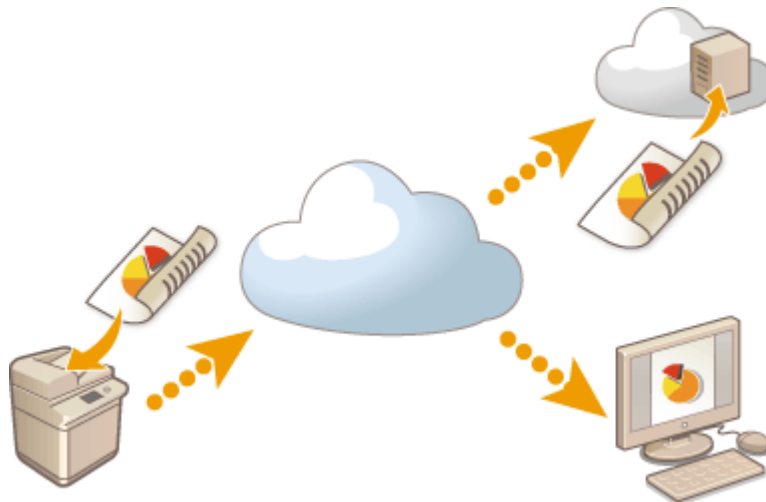

Main Specifications

Authentication Function

User registration method	<ul style="list-style-type: none"> • Linking the Office 365™ account • Uploading in CSV format • Registering users via e-mail • Manual entry
User authentication system	<ul style="list-style-type: none"> • Microsoft Azure Active Directory • Office 365™ integrated with Active Directory Federation Services • Active Directory in your company • Linking with external SNS services (Single Sign-On)
Authentication method	<ul style="list-style-type: none"> • PIN code • ID card

	<ul style="list-style-type: none"> • ID card + PIN code
--	--

Accounting and Reporting Function

Report type	<ul style="list-style-type: none"> • Usage log of each user • Usage log of each device • Copy/print/scan/fax logs of all users • Copy/print/scan/fax logs of all devices (all periods) • Copy/print/scan/fax logs of all devices (specified period)
--------------------	--

Simple Scan Function

Send/store function	Scan to Myself (Sending an e-mail), Scan to Google Drive
File format	TIFF, PDF

Checking the Number of Pages for Copy/Print/Fax/Scan

961F-OKH

On the touch panel display, you can check the total number of pages for copying, faxing, scanning, and printing.

- 1 Press **123** (Counter/Device Information) or the [Counter/Device Information] key (models with an upright control panel).
 - ▶ Items Displayed on the <Home> Screen(P. 335)
 - ▶ Control Panel(P. 33)
- 2 Check the total number of copied, scanned, and printed pages.



(Items shown on the screen may differ depending on your model and options.)

- If you want to check the total number of pages that were scanned and sent, press <Check Send/Fax Counter>.

NOTE

- You can print a list that shows the number of pages used for copying, printing, scanning, and faxing.
 - ▶ **Printing a Report on the Number of Copied and Printed Pages(P. 1026)**
- On this screen, you can also check the counter information for each MEAP application. Press <Check MEAP Counter> on the screen in step 2. If you press <Device Info./Other> ▶ <Check Device Configuration> on the same screen, you can check the options installed in the machine and the version of the security chip for storage device data encryption.
- For information on the count conditions, contact your dealer or service representative.
- For information on the <Monitoring Service>, contact your dealer or service representative.

Printing Reports and Lists

You can print reports and lists to check information such as the total number of copied pages, communication results, and machine settings.

- ▶ **Printing a Report on the Number of Copied and Printed Pages(P. 1026)**
- ▶ **Printing a List of Usage History(P. 1027)**
- ▶ **Outputting a Communication Result Report(P. 1029)**
- ▶ **Printing a List of Settings(P. 1034)**

Printing a Report on the Number of Copied and Printed Pages

Counter Report

You can print a report to check the total number of all copied and printed pages, as well as the total number of scanned pages and faxed pages.



 (Counter/Device Information) or [Counter/Device Information] key (models with an upright control panel) ▶ <Print List> ▶ <Yes>

Page Count List

You can print a list to check the total number of pages* that were copied, printed, and scanned for each Department ID. To print this list, you need to log in with administrator privileges. ▶ **Logging into the Machine(P. 355)**



 (Settings/Registration) ▶ <Management Settings> ▶ <User Management> ▶ <Department ID Management> ▶ <On> ▶ <Page Totals> ▶ <Print List> ▶ Select the items to print ▶ <Start Printing>

NOTE

- Department ID Management must be set in order to calculate the Page Count List for each Department ID. ▶ **Setting the Department ID Management(P. 839)**
- With the Remote UI Page Count List, you can check how many pages have been printed or scanned by individual user names linked to a Department ID. To display the list, ▶ **Starting the Remote UI(P. 902)** ▶ click [Settings/Registration] ▶ [User Management] ▶ [Department ID Management]. However, note that user names will not be displayed if multiple users are allocated to the same Department ID, or if you are using DepartmentID Authentication as the login service.
- The Page Count List can also be saved as a CSV file using the Remote UI. ▶ **Starting the Remote UI(P. 902)** ▶ click [Settings/Registration] ▶ [User Management] ▶ [Department ID Management] ▶ [Store in CSV Format...].

* In this report, the numbers are based on copied or printed sides of the page. For example, the count is 1 if you print on one side of a page, and the count is 2 if you print on both sides of the page.

Printing a List of Usage History

When you press  (Status Monitor), the Status Monitor screen is displayed, allowing you to check the usage history for each function, such as copying, printing, sending e-mail, sending/receiving faxes/I-faxes, storing files in "Advanced Space," etc. From this screen, you can also print the usage history for each function.

NOTE

- If "NG" appears in the "RESULT" column in the printed list, check the three-digit number preceded by "#" to find the reason and solutions.
 - ▶ **Countermeasures for Each Error Code(P. 1469)**
- If  (Settings/Registration) ▶ <Management Settings> ▶ <Device Management> ▶ <Restrict Access to Other User Jobs> is set to <On>, jobs other than those of the logged-in user are displayed as "***" and cannot be operated. If you log in with administrator privileges, the jobs of all users are displayed.

1 Press  (Status Monitor).

2 Display the usage history of each function and print a list.

■ Copy/print log

- 1 Press <Copy/Print> ▶ <Job Log>.
- 2 Select the items you want to print, and press <Print List>.

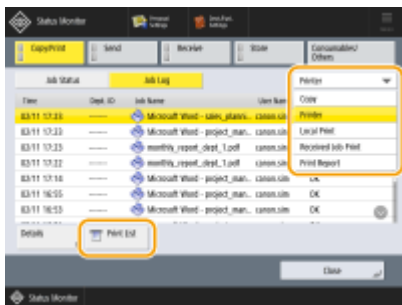

3 Press <Yes>.

■ Sending/receiving log

- 1 Press <Send> or <Receive> ▶ <Job Log>.
- 2 Select <Send> or <Receive> from the list, and press <Communication Management Report>.

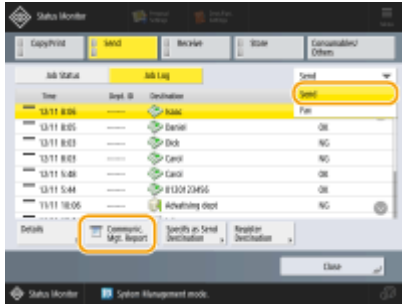

3 Press <Start Printing>.

NOTE

- For documents sent by e-mail, the list indicates the sending results between the machine and the mail server, not between the machine and the destination.
- If you select <Output Spec. No. of Transm.> in step 3, you can specify the number of log results that appear in the list.
- You can specify whether or not to print the list automatically.
 - ▶ **Communication Management Report(P. 1029)**

■ Fax sending/receiving log

- 1 Press <Send> or <Receive> ▶ <Job Log>.
- 2 Select <Fax> from the list, and press <Fax Activity Report>.

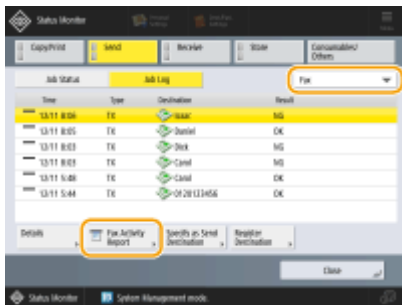

3 Press <Start Printing>.

NOTE

- If you select <Output Spec. No. of Transm.> in step 3, you can specify the number of log results that appear in the list.
- You can specify whether or not to print the list automatically.
 - ▶ **Fax Activity Report(P. 1031)**

■ Storage log

- 1 Press <Store> ▶ <Job Log> ▶ <Print List>.
- 2 Press <Yes>.

NOTE

- There are three types of store locations printed as the protocol. If one of the following conditions is met, the corresponding store location is printed.
 - Memory Media: If the data is stored in a removable media such as USB memory from <Scan and Store>
 - Local: If the data is stored in the Advanced Space of the machine from <Scan and Store>
 - Network: If the data is stored in the Windows server from <Scan and Store>

Outputting a Communication Result Report

You can print a list of results for sending/receiving fax, e-mail, or I-fax, and results for storing items in the file server or Mail Box (machine's temporary storage space). A report is set to be printed automatically or printed only when an error occurs. However, you can change the setting to print only at a specified time or not to print at all. In addition, you can send the report to a specified destination as a CSV file.

NOTE

- If "NG" appears in the "RESULT" column in the printed list, check the three-digit number preceded by "#" to find the reason and solutions.
 - ▶ **Countermeasures for Each Error Code(P. 1469)**
- If  (Settings/Registration) ▶ <Management Settings> ▶ <Device Management> ▶ <Restrict Access to Other User Jobs> is set to <On>, jobs other than those of the logged-in user are displayed as "****" and cannot be operated. If you log in with administrator privileges, the jobs of all users are displayed.

Communication Management Report

You can configure the machine to automatically print the report or send it as a CSV file to destinations registered in the Address Book when the specified number of communication results, including sent or received faxes, e-mails, and I-faxes, as well as items saved in the file server or Mail Box (machine's temporary storage space), is reached. You can also configure the machine to print the report or send it as a CSV file at a specified time.

- 1 Press  (Settings/Registration).
- 2 Press <Function Settings> ▶ <Send> ▶ <Common Settings> ▶ <Communication Management Report>.
- 3 Configure the necessary settings, and press <OK>.



a <Print/Send Every Specified No. of Transm.>

Select this to print/send a report when the specified number of communication results is reached. Set the number of communication results using the numeric keys.

b <Print/Send at Specified Time>

Select this to print/send a report at the specified time. Set the time using the numeric keys.

c <Print Send/Receive Jobs Separately>

Select this to output separate reports for send jobs and receive jobs.

d <Send Destination>

Specify the destination.

NOTE

- Press <Send Destination> ► <To Remote Address Book> to specify the destination to the destinations registered in a remote address book.

► **Local Address Book and Remote Address Book(P. 391)**

! IMPORTANT

- You cannot configure the settings for the Communication Management Report while <Display Job Log> in <Management Settings> is set to <Off>. In addition, if you change <Display Job Log> in <Management Settings> from <Off> to <On>, <Print/Send Every Specified No. of Transm.> and <Print/Send at Specified Time> in the Communication Management Report automatically changes to <Off>. ► **<Display Job Log>(P. 1340)**

NOTE

- For documents sent by e-mail, the report indicates the sending results between the machine and the mail server, not between the machine and the destination.
- You can manually print a Communication Management Report from a list in the usage history.

► **Sending/receiving log(P. 1027)**

When setting to print a report at a specified time



- If a report is set to print at a specified time, the 100 most recent results are printed, with the most recent results first. If the number of results exceeds 100, the older results are not printed.

When setting the machine to send the report as a CSV file at a specified time

- The 2,000 most recent results are exported to a CSV file, which is sent at the specified time. If the number of results exceeds 2,000 by the specified time for file sending, the older results are not exported.

TX Report

You can configure the machine to automatically print the report for sending results, including sent faxes, e-mails, and I-faxes, as well as items saved in the file server or Mail Box (machine's temporary storage space). You can also configure the setting to print the report only when an error occurs. You are required to log in with administrator privileges to print this report.

  (Settings/Registration) ▶ <Function Settings> ▶ <Send> ▶ <Common Settings> ▶ <TX Report> ▶ Set the report ▶ <OK>

NOTE

- Even if you set <Report with TX Image> to <On>, the sent document is not displayed in the report in the following situations.
 - When an encrypted PDF is sent
 - If <Report with Color TX Image> is set to <Off> and the first page sent is a color original
 - The send result is also printed when you send faxes on a Remote Fax client machine.
 - If <Fax TX Report> is set to <For Error Only> or <On>, a Fax TX Report is printed with the TX Report.
 - For documents sent by e-mail, the report indicates the sending results between the machine and the mail server, not between the machine and the destination.
 - Send jobs originating from the fax driver are omitted from this report.
 - If unnecessary streaks or shadows appear around the sent document, use <Erase Original Frame>. 
- Erasing Dark Borders When Scanning (Erase Frame)(P. 662)**
- The TX Report includes the results of forwarding in addition to the results of sending.

Fax Activity Report

You can configure the machine to automatically print a report on fax sending and receiving or send it as a CSV file to destinations registered in the Address Book when the specified number of sent or received faxes is reached. You can also configure the machine to print the report or send it as a CSV file at a specified time.

- 1 Press  (Settings/Registration).
- 2 Press <Function Settings> ▶ <Send> ▶ <Fax Settings> ▶ <Fax Activity Report>.
- 3 Configure the necessary settings, and press <OK>.



a <Print/Send Every Specified No. of Transm.>

Select this to print/send a report when the specified number of communication results is reached. Set the number of communication results using the numeric keys.

b <Print/Send at Specified Time>

Select this to print/send a report at the specified time. Set the time using the numeric keys.

C <Print Send/Receive Jobs Separately>

Select this to output separate reports for send jobs and receive jobs.

d <Send Destination>

Specify the destination.

NOTE

- Press <Send Destination> ▶ <To Remote Address Book> to specify the destination to the destinations registered in a remote address book.
- ▶ **Local Address Book and Remote Address Book(P. 391)**

! IMPORTANT

- You cannot configure the settings for the Fax Activity Report while <Display Job Log> in <Management Settings> is set to <Off>. In addition, if you change <Display Job Log> in <Management Settings> from <Off> to <On>, <Print/Send Every Specified No. of Transm.> and <Print/Send at Specified Time> in the Fax Activity Report automatically changes to <Off>. ▶ **<Display Job Log>(P. 1340)**

NOTE

- You can manually print a Fax Activity Report from a list in the usage history. ▶ **Fax sending/receiving log(P. 1028)**
- The name of the remote party registered in the Address Book is printed when sending to a destination selected from the Address Book. If sending by entering a number with the numeric keys, the Transmitting Subscriber Identification (TSI) is printed if it could be acquired from the recipient.

When setting to print a report at a specified time



- If a report is set to print at a specified time, the 40 most recent results are printed, with the most recent results first. If the number of results exceeds 40, the older results are not printed.

When setting the machine to send the report as a CSV file at a specified time

- The 2,000 most recent results are exported to a CSV file, which is sent at the specified time. If the number of results exceeds 2,000 by the specified time for file sending, the older results are not exported.

Fax TX Report

You can configure the machine to automatically print the report each time a fax is sent. You can also configure the setting to print the report only when an error occurs.

  (Settings/Registration) ▶ <Function Settings> ▶ <Send> ▶ <Fax Settings> ▶ <Fax TX Report> ▶
Set the report ▶ <OK>

NOTE

- A Fax Multi TX Report is printed when <Fax TX Report> is set to <On> and broadcast transmission is performed.
- Even if you set <Report with TX Image> to <On> in the report settings, the image of the sent original does not appear in a report when a fax is directly sent to the destination using direct sending (▶)

Checking the Connection to the Recipient Before Sending (Direct Send)(P. 547)) or manual sending (**Sending Faxes Manually (Manual Sending)(P. 549)**).

- If unnecessary streaks or shadows appear around the sent document, use <Erase Original Frame>. **Erasing Dark Borders When Scanning (Erase Frame)(P. 662)**
- If <TX Report> is set to <For Error Only> or <On>, a TX Report is printed with the Fax TX Report.

Fax RX Report

You can set a Fax RX Report to print automatically every time a fax is received. It is also possible to set the report to print only when an error occurs.



 (Settings/Registration) ▶ <Function Settings> ▶ <Receive/Forward> ▶ <Fax Settings> ▶ <Fax RX Report> ▶ Set the report ▶ <OK>

Confidential Fax Inbox RX Report

You can configure the machine to automatically print the report when a received fax is saved in the Confidential Fax Inbox. You can also configure the setting so that the report is not printed.



 (Settings/Registration) ▶ <Function Settings> ▶ <Receive/Forward> ▶ <Fax Settings> ▶ <Confidential Fax Inbox RX Report> ▶ Set the report ▶ <OK>

NOTE

- Even though <Off> is set in this setting, if **Fax RX Report(P. 1033)** is enabled, a report is printed when a fax is saved in the Confidential Fax Inbox.

Printer Report

You can print a report of printer functions, such as the font list and status.



 (Settings/Registration) ▶ <Function Settings> ▶ <Printer> ▶ <Output Report> ▶ Select the printer function ▶ Follow the on-screen instructions to select the item to be printed

Device Information Communication Log Report

You can configure the machine to automatically print the report when the specified number of results for device information distribution or reception is reached. You can also configure the setting to print the report at a specified time. You are required to log in with administrator privileges to change the report setting.



 (Settings/Registration) ▶ <Management Settings> ▶ <Device Management> ▶ <Device Information Distribution Settings> ▶ <Communication Log> ▶ Report Settings ▶ Set the report ▶ <OK>

NOTE

- When you are logged in with administrator privileges, you can manually print the device information communication history as a list. Press  (Settings/Registration) ▶ <Management Settings> ▶ <Device Management> ▶ <Device Information Distribution Settings> ▶ <Communication Log> ▶ <Print List> ▶ <Yes>.

When setting to print a report at a specified time

- If a report is set to print at a specified time, the 100 most recent results are printed, with the most recent results first. If the number of results exceeds 100, the older results are not printed.

Printing a List of Settings

Information and settings registered in the machine such as registered destinations, send/receive settings, fax settings, forwarding conditions, files in a Mail Box, etc. can be printed as a list.

Address Lists

You can print a list of destinations registered in the Address Book or in one-touch buttons.



 (Settings/Registration) ▶ <Set Destination> ▶ <Address Lists> ▶ Select the address book or one-touch buttons to print ▶ <Print List> ▶ <Yes>

TX/RX User Data List

You can print a list of the settings configured for <Send> and <Receive/Forward> under Settings/Registration.



 (Settings/Registration) ▶ <Function Settings> ▶ <Send> or <Receive/Forward> ▶ <Output Report> ▶ <TX/RX User Data List> ▶ <Yes>

NOTE

- Items that have been changed from their default settings are printed with an asterisk (*) next to them.

Fax User Data List

You can print a list of the settings configured for fax function by using <Send> and <Receive/Forward> under Settings/Registration.



 (Settings/Registration) ▶ <Function Settings> ▶ <Send> or <Receive/Forward> ▶ <Output Report> ▶ <Fax User Data List> ▶ <Yes>

NOTE

- Items that have been changed from their default settings are printed with an asterisk (*) next to them.

Forwarding Settings

You can print a list of the settings configured for fax and I-fax forwarding by using <Receive/Forward> under Settings/Registration. You are required to log in with administrator privileges to print this list.



 (Settings/Registration) ▶ <Function Settings> ▶ <Receive/Forward> ▶ <Common Settings> ▶ <Forwarding Settings> ▶ <Print List> ▶ <Yes>

Mail Box File List

You can print a list of temporarily saved files in a Mail Box on the machine.



<Access Stored Files> ( <Home> Screen(P. 332)) ▶ <Mail Box> ▶ Select the mail box to print ▶ <Print List> ▶ <Yes>

Network Setting List

You can print a list of the settings configured for <Network> in <Preferences> under Settings/Registration.



 (Settings/Registration) ▶ <Preferences> ▶ <Network> ▶ <Output Report> ▶ <Yes>

NOTE

- Items that have been changed from their default settings are printed with an asterisk (*) next to them.
- The following items are automatically generated from unique information of the machine by default and when the settings are initialized, and have an asterisk (*) next to them.

- IPv4 Host Name
- IPv6 Host Name
- mDNS Name (mDNS Settings)
- Current Transmission Speed (Ethernet Driver Settings)

System Information list

You can print a list of information such as MEAP applications and licenses. You are required to log in with administrator privileges to print this list.



 (Settings/Registration) ▶ <Management Settings> ▶ <License/Other> ▶ <MEAP Settings> ▶ <Print System Information> ▶ <Yes>

Device Information Distribution Destination List

You can print a list of devices registered as information distribution destinations. You are required to log in with administrator privileges to print this list.



 (Settings/Registration) ▶ <Management Settings> ▶ <Device Management> ▶ <Device Information Distribution Settings> ▶ <Register Destinations> ▶ <Print List> ▶ <Yes>

LDAP Server Registration List

You can print a list of LDAP server settings registered in the machine. You are required to log in with administrator privileges to print this list.



 (Settings/Registration) ▶ <Set Destination> ▶ <Register LDAP Server> ▶ <Print List> ▶ <Yes>

IPSec Policy List

You can print a list of IPSec policy settings registered in the machine. You are required to log in with administrator privileges to print this list.



 (Settings/Registration) ▶ <Preferences> ▶ <Network> ▶ <TCP/IP Settings> ▶ <IPSec Settings> ▶ <Print List> ▶ <Yes>

NOTE

- Lists can be printed only if A3, B4, A4, 11" x 17", LGL, or LTR (plain, recycled, thin, or color) is loaded in a paper source whose settings in <Other> in <Paper Source Auto Selection> in <Function Settings>

(Settings/Registration) are set to <On>. However, if <Consider Paper Type> for <Copy> is set to <On> in <Paper Source Auto Selection>, you cannot print from a paper source with color paper specified.

▶ **Automatically Selecting the Appropriate Paper Source for a Specific Function (P. 79)**

Checking the Options Installed on This Machine

961F-OKK

You can check the optional equipment and functions installed on this machine.

1 Press **[123]** (Counter/Device Information) or the [Counter/Device Information] key (models with an upright control panel).

- ▶ Items Displayed on the <Home> Screen(P. 335)
- ▶ Control Panel(P. 33)

2 Press <Device Info./Other> ▶ <Check Device Configuration>.

3 Check the optional equipment and functions.



NOTE

- Some of the functions shown are provided as standard.
- You can also check the TPM version.

4 Press <OK>.

Paper Type Management Settings

961F-OKL

You can register and edit detailed information of frequently used paper types as the <Custom Type>.

To register a new paper type, first duplicate the paper type that resembles the new type in order to copy all of the internal operational parameters. This procedure copies the suitable settings to the new paper type from the registered custom paper easily.

You can also improve printing quality and paper feeding trouble by editing the custom paper, depending on the characteristics.

NOTE

- It is necessary to log in as an administrator to register custom paper types or change the settings of registered custom paper types. **▶Logging into the Machine(P. 355)**
- When you register the custom paper type, you cannot specify the paper source. For more information on registering the paper source, see **▶Specifying Paper Size and Type in the Paper Drawer(P. 65)** .
- You can import/export the registered custom paper type information, and share it with another Canon machine. **▶Importing/Exporting the Settings Individually(P. 954)**

▶Registering frequently used paper types(P. 1039)

▶Items that can be specified(P. 1040)

Registering frequently used paper types

1 Press  (Settings/Registration) .

2 Press <Preferences> ▶ <Paper Settings> ▶ <Paper Type Management Settings>.

3 Specify the settings.

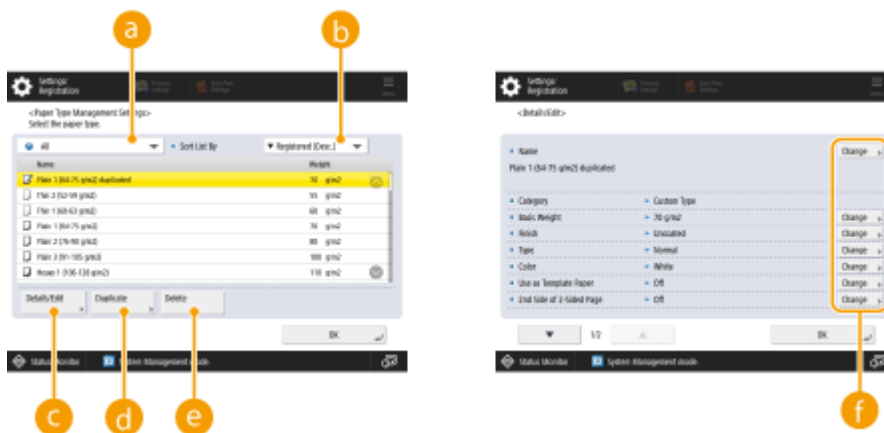

a Paper type drop-down list

Enables you to select the paper type to display.

b <Sort List By>

Enables you to change the display order of the list.

c <Details/Edit>

Displays details for the selected paper type on the <Details/Edit> screen. If you select a custom paper type, you can edit it.

d <Duplicate>

Duplicates the selected paper type as a custom paper type.

e <Delete>

Deletes the selected custom paper type.

f <Change>

Appears on the <Details/Edit> screen for the custom paper type and enables you to change the settings for the selected item.

! IMPORTANT

- You can only edit/delete custom paper types.

4 Press <OK> .

Items that can be specified

The following items can be specified.

■ Name

You can change the name of the custom paper type.

NOTE

- When you register the settings for the custom paper type, make sure to change its name. You cannot change the settings of the default paper types registered in the machine.

■ Basis Weight

You can change the basis weight of the custom paper type.

! IMPORTANT

- If you enter a value that is different from the actual weight of the set paper, paper jams may occur, and the quality of the image may be adversely affected.

■ Finish

You can change the Finish setting of Custom Type you have registered.

! IMPORTANT

- If you select a finishing type which is different from that of the loaded paper, paper jams may occur, and the quality of the image may be adversely affected.

■ Type

You can change the Type setting of Custom Type you have registered.

IMPORTANT

- If you select a paper type which is different from that of the loaded paper, paper jams may occur, and the quality of the image may be adversely affected.

■ Color

You can change the colour of the custom paper type.

IMPORTANT

- If you select a color which is different from that of the loaded paper, paper jams may occur, and the quality of the image may be adversely affected.

■ Use as Template Paper

You can set this mode to <On> to use preprinted paper (paper which has logos already printed on it), such as a letterhead.

IMPORTANT

- The custom paper type with <On> set for <Use as Template Paper> is not automatically selected in the following cases.
 - When the paper type for printing is set to <Auto>
 - If <Paper Source Auto Selection> is set to <On> and <Consider Paper Type> is set to <Off> when copying

NOTE

- Methods for loading paper if <Use as Template Paper> is set to <On>:
 - Paper drawer of the main unit: the side with a logo facing down
 - Paper source other than a paper drawer of the main unit: the side with a logo facing up

■ Adjust Image Position

You can adjust the printed image position, which is misaligned or distorted, by confirming test pages and specifying setting values.  **Adjusting the Image Position(P. 1044)**

■ Adjust Creep Correction

If you want to change the creep (displacement) correction for each page in a booklet, adjust the creep correction width for the registered custom paper type.

NOTE

- For information on creep (displacement), see [▶ Making Booklets \(Booklet Copying\)\(P. 469\)](#) .
- The value you set here becomes the default correction width when the selected paper type is used for saddle stitching with automatic "Adjust Creep (Displacement) Correction".

■ Adjust Gloss

This mode enables you to adjust the glossiness of the custom paper type. You can change the glossiness of a printed image when using plain or coated paper by adjusting the temperature of the fixing unit. Press <+> to increase the gloss, and press <-> to decrease the gloss.

! IMPORTANT

- Depending on the paper, if the value in this mode is increased, a paper jam may occur. If the value is decreased, the quality of the image could be adversely affected or toner may not be applied properly to the image.
- Make sure to change the value in small increments as changing the value abruptly may cause some troubles.

■ Adjust Secondary Transfer Voltage

You can adjust the Secondary Transfer Voltage (the voltage that transfers toner to the paper) when image blurring occurs. [▶ Adjusting the Secondary Transfer Voltage\(P. 1047\)](#)

■ Adjust Lead Edge Secondary Transfer Voltage

If the image on the leading edge is faint or irregular compared to when printing on standard paper, you can change the leading edge secondary transfer voltage (the voltage when transferring the toner image to the paper) of the registered custom paper.

NOTE

- If the entire image becomes fainter or corrupt, rather than only the lead edge, change <Adjust Secondary Transfer Voltage>.
- Adjusting <Adjust Secondary Transfer Voltage> may affect the settings of <Correct Tail End Toner Application> and <Adjust Image Position>. Readjust these settings, if necessary.
- Follow the guidelines below to perform adjustment.
 - <Adjustment Level>: Increasing this in the positive direction increases the effect for lead edge image problems. Increasing the value too high may cause toner to be missing in high density areas.
 - <Correction Amount>: Increasing this in the positive direction increases the distance where control is performed from the lead edge of the paper. The distance increases in +0.1 mm increments.

■ Correct Tail End Toner Application

When curled paper or paper susceptible to curling is used for two-sided copying/printing, toner may not be adequately applied or the color may become faint on the tail end (from the feeding direction) of the paper. For low density images, the color may become fainter or denser. In these cases, change the <Correct Tail End Toner Application> settings of the custom paper type.

NOTE

- If the entire image becomes fainter or corrupt, rather than only the lead edge, change <Adjust Secondary Transfer Voltage>.
- Adjusting <Adjust Lead Edge Secondary Transfer Voltage> may affect the settings of <Correct Tail End Toner Application> and <Adjust Image Position>. Readjust these settings, if necessary.
- Follow the guidelines below to perform adjustment.
 - <Adjustment Level>: Increasing this in the positive direction increases the effect for tail end image problems. Increasing the value too high may cause toner to be missing in high density areas.
 - <Correction Amount>: Increasing this in the positive direction increases the distance where control is performed from the tail end of the paper in the lead edge direction when seen from the tail end of the paper. The distance increases in +0.1 mm increments.
- If performing adjustment does not improve the problem, adjust <Adjust Secondary Transfer Voltage> or <Adj. Lead Edge Sec. Transfer Volt.>. In this case, decreasing the secondary transfer voltage from the current value can have an effect, but adjustment should be performed gradually as it may affect the image.

Adjusting the Image Position

961F-0KR

You can adjust the printed image position, which is misaligned or distorted, by confirming test pages and specifying setting values.

- ▶ **Outputting a Test Page(P. 1044)**
- ▶ **Adjusting Lead Edge Alignment of the Image(P. 1044)**

Outputting a Test Page

Print a test page when adjusting the position of images.

- 1 Press <Change> for <Adjust Image Position>.**
- 2 Press <Output Test Page>.**
- 3 Enter the number of test pages to make ▶ press <Next>.**
- 4 Select a paper source that contains a custom paper type ▶ press <Start Printing>.**

- A test page is printed.

NOTE

- For information on paper that can be used as test pages, see ▶ **Paper Available for 2-Sided Copying/2-Sided Printing(P. 230)** .
- Make sure that a sufficient supply of paper is loaded in the paper source before outputting the test pages.

Adjusting Lead Edge Alignment of the Image

This setting enables you to adjust the image position, by checking whether the register mark and the image at the leading edge toward the feeding direction are aligned on the test page.

- 1 Check the position of the lead edge image on the front side of the test page.**
 - In the example below, adjustment is required because the center line of the register mark is 0.4 mm outside the edge of the test page. Follow the procedure described below to adjust the position of the lead edge image on the front side of the test page.

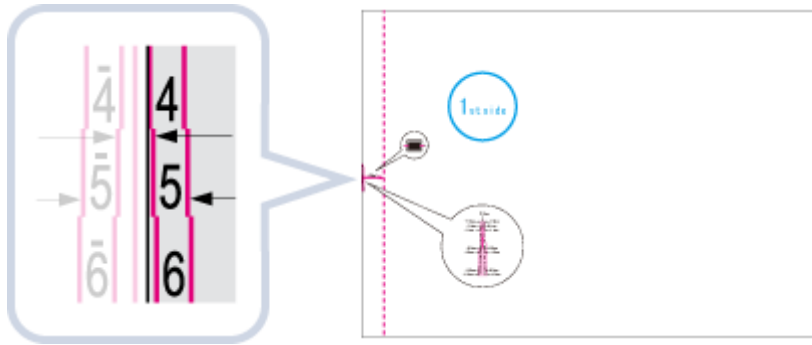

NOTE

- The test page with "1st side" printed on it is the front side.

2 In the <Adjust Image Position> screen, enter the value confirmed on the test page that aligns the center line of the register mark with the edge of the paper.

- In case of the example described above, set 0.4 mm for <Front Side>. Enter the value using <-> and <+>.



a <+>

Press when the center line of the register mark is located outside the edge of the test page (the center line of the register mark is NOT printed). The image is shifted to the backwards as seen from the feeding direction of the paper, according to the entered value.

b <->

Press when the center line of the register mark is located inside of the edge of the test page. The image is shifted to the forwards as seen from the feeding direction of the paper, according to the entered value.

3 Turn over the test page ► check the lead edge image on the back side of the test page.

4 Enter the value confirmed on the test page that aligns the center line of the register mark with the edge of the paper.

- Enter the value using <-> and <+> in <Back Side>.

5 Perform the test page again, and check the image position ► press <OK>.

- Repeat the correction again, if necessary.

! IMPORTANT

- When you open the <Adjust Image Position> screen again after you close that screen by pressing <OK>, the values on screen are returned to <0>. However, the adjusted value is still effective. If you repeat steps, read off the value of register marks from new test page and input the new value.

NOTE

- To restore the accumulated value, press <Restore Initial Settings>.

6 Press <OK>.

Adjusting the Secondary Transfer Voltage

961F-OKS

You can adjust the Secondary Transfer Voltage (the voltage that transfers toner to the paper) when image blurring occurs.

- ▶ **Configuring/Printing the Chart(P. 1047)**
- ▶ **Adjusting the Secondary Transfer Voltage(P. 1048)**

NOTE

- Adjustments made in <Adjust Secondary Transfer Voltage> may affect the <Adjust Image Position> setting. Readjust <Adjust Image Position> as needed.

Configuring/Printing the Chart

To adjust the secondary transfer voltage, first print the chart page.

1 Press <Change> in <Adjust Secondary Transfer Voltage>.

2 Select the secondary transfer voltage adjustment method.

- Press <Do Not Use Scanner> to view the printed chart, identify the optimal patch, and make manual adjustments.
- Press <Use Scanner> to scan the printed chart and have the optimal patch identified and adjustments made automatically.

NOTE:

- If you selected <Use Scanner>, the usable paper sizes are A3, A4, 11" x 17", and LTR.

3 Press <Chart Print Settings>.

4 Specify the settings for the chart to be printed and press <Next>.



a <Chart Print Type>

Select <For Fine Adjustment> to make fine adjustments or <For Coarse Adjustment> if major adjustment is required.

- If you selected <For Fine Adjustment>, a chart is printed with adjustments in increments of ± 1 .

- If you selected <For Coarse Adjustment>, a chart is printed with adjustments in increments based on the status of the machine.

b <Print Side>

Select the side on which the secondary transfer voltage is to be adjusted.

NOTE:

- In any of the following situations, select <Front Side Only>.
 - If <2nd Side of 2-Sided Page> is set to <On> for a custom paper.
 - If you loaded paper in the multi-purpose tray and selected <2nd Side of 2-Sided Page> in <Paper Type>.
- If you selected <2-Sided>, see **▶ Paper Available for 2-Sided Copying/2-Sided Printing(P. 230)** for the papers that can be used for charts.

5 Select the paper source in which the custom paper is loaded ▶ press <OK>.

6 Press <Chart Print> or <Chart Print/Scan>.

- If you selected <Use Scanner> in step 2, press <Start Printing>.
 - ▣▶ The chart is printed.

Adjusting the Secondary Transfer Voltage

Use the printed chart to adjust the secondary transfer voltage. The procedure differs depending on the secondary transfer voltage adjustment method selected in step 2 of " **▶ Configuring/Printing the Chart(P. 1047)** ".

▶ If you selected <Do Not Use Scanner>(P. 1048)

▶ If you selected <Use Scanner>(P. 1049)

■ If you selected <Do Not Use Scanner>

Visually identify the optimal patch in the chart and adjust the secondary transfer voltage.

1 Check the optimal patch in the printed chart.

- With the current settings, chart numbers are printed in magenta.

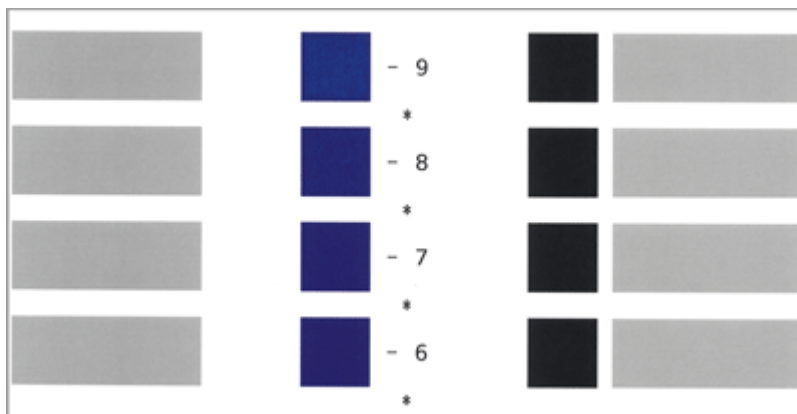

- Check the chart as you sequentially increase from negative values to positive values. When you reach a point where the density within the patch appears uniform (-8 in the example), compare it with a patch with a value that is higher by 2 (-7 and -6 in the example) and select the value you consider to be optimal.

NOTE:

- A side that has a single asterisk (*) printed next to the chart number is the front side.
- Where there is no discernible difference among the selected numbers, choose the middle of the three values (-7 in the example).

2 In the <Adjust Secondary Transfer Voltage> screen, enter the number confirmed in the chart.

- Select <Front Side> or <Back Side> and enter the number using <-> or <+>.

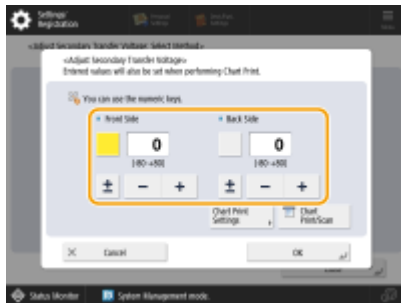

NOTE:

- In either of the following situations, adjust the value for <Back Side>.
 - If <2nd Side of 2-Sided Page> is set to <On> for a custom paper.
 - If you loaded paper in the multi-purpose tray and selected <2nd Side of 2-Sided Page> in <Paper Type>.

3 Press <OK>.

■ If you selected <Use Scanner>

Scan the chart on the scanner to have the optimal patch identified automatically.

1 Place the chart on the platen glass.

- Place the chart while following the on-screen instructions.

2 Close the feeder and press <Start Scanning>.

▢ The chart is scanned.

- If the chart was printed on both sides of the paper, place the other side of the chart on the platen glass and press <Start Scanning> again.

NOTE:

- You may not be able to scan special paper such as colored paper, transparencies, pre-punched paper, or labels. To scan special paper, select <Do Not Use Scanner> and make the adjustment manually.

3 Open the feeder and remove the chart.

4 Press <OK>.

Settings/Registration

Settings/Registration	1054
<Preferences>	1057
<Paper Settings>	1059
<Display Settings>	1063
<Timer/Energy Settings>	1072
<Network>	1080
<TCP/IP Settings>	1092
<IPv4 Settings>	1110
<IPv6 Settings>	1112
<DNS Settings>	1115
<Firewall Settings>	1118
<IPv4 Address Filter>	1120
<IPv6 Address Filter>	1123
<MAC Address Filter>	1126
<Wireless LAN>	1127
<Direct Connection Settings>	1129
<Sub Line Settings>	1134
<Firewall Settings>	1136
<Settings for System Data Communic.>	1139
<External Interface>	1141
<Accessibility>	1143
<Adjustment/Maintenance>	1145
<Adjust Image Quality>	1146
<Adjust Action>	1151
<Maintenance>	1154
<Check Maintenance Method>	1156
<Initialize After Replacing Parts>	1160
<Function Settings>	1161
<Common>	1163
<Paper Feed Settings>	1165
<Paper Output Settings>	1168
<Print Settings>	1172
<Output Report Default Settings>	1178
<Secure Watermark Settings>	1179
<Scan Settings>	1184
<Generate File>	1190

<Set Authentication Method>	1195
<Copy>	1197
<Printer>	1201
Output Report	1205
Custom Settings	1206
UFR II	1212
PCL	1213
PS	1215
Imaging	1217
PDF	1219
XPS	1221
Utility	1223
<Send>	1224
<Output Report>	1225
<Common Settings>	1226
<E-Mail/I-Fax Settings>	1239
<Fax Settings>	1249
<Set Line>	1259
<Remote Fax TX Settings>	1262
<Remote Fax Settings>	1265
<Receive/Forward>	1266
<Output Report>	1267
<Common Settings>	1268
<Set Fax/I-Fax Inbox>	1273
<Fax Settings>	1279
<Store/Access Files>	1282
<Common Settings>	1283
<Scan and Store Settings>	1284
<Access Stored Files Settings>	1286
<Mail Box Settings>	1288
<Settings for All Mail Boxes>	1290
<Box Security Settings>	1291
<Advanced Space Settings>	1292
<Network Settings>	1297
<Memory Media Settings>	1300
<Print>	1301
<Web Access>	1307
<Set Destination>	1310
<Acquire Remote Address Book>	1318
<Make Remote Address Book Open>	1320
<Management Settings>	1321
<User Management>	1322
<Authentication Management>	1325
<Keyboard Authentication>	1330
<Device Management>	1332
<Limited Functions Mode>	1344
<Manage Personal Settings>	1346

<License/Other>	1348
<MEAP Settings>	1353
<Data Management>	1356
<Import/Export>	1358
<Security Settings>	1360
<Authentication/Password Settings>	1363
<Authentication Function Settings>	1364
<Password Settings>	1366
<Encryption Settings>	1371
Volume Settings (Volume Settings)	1373

Settings/Registration

961F-0KU

You can customize the machine based on your environment and needs by configuring settings described in this chapter. To start configuration, press  (Settings/Registration).

This section describes what each item in the Settings/Registration menu can configure. Note that the items available differ depending on the user privileges at login and the devices being used.

- ▶<Preferences>(P. 1057)
- ▶<Adjustment/Maintenance>(P. 1145)
- ▶<Function Settings>(P. 1161)
- ▶<Set Destination>(P. 1310)
- ▶<Management Settings>(P. 1321)
- ▶<Volume Settings (Volume Settings)>(P. 1373)

NOTE

- The sound settings (Adjust Volume) appear when you press <Volume Settings> or the Adjust Volume key (on models with an upright control panel).
- Some of the settings may not be displayed depending on the configuration of optional equipment installed on the machine.
- Some changes may not be reflected immediately, depending on the settings. In this case, it is necessary to perform one of the following.
 - Press <Yes> on the screen confirming whether you want to make changes.
 - Press  (Settings/Registration) ▶ <Apply Set. Changes>.
 - Restart the machine.
- The items that administrators can set differ from those available to general users. The items that can be set also differ depending on the function limitations applied by users with administrator privileges.

■ Lists of Settings

Setting items and values are written under Setting Description. The factory defaults are written in **bold red characters**.

"DeviceAdmin" and "NetworkAdmin"

The "DeviceAdmin" and "NetworkAdmin" items are written for each item in the Settings/Registration table. If the administrator role is specified for the machine, users with Administrator privileges can change all of the settings, while general users are restricted and can change only some of the settings. Meanwhile, users with DeviceAdmin or NetworkAdmin privileges can change certain settings even while those settings are restricted. For those settings, "Yes" or "No" indicates whether the settings can be changed with DeviceAdmin and NetworkAdmin privileges.

"Can be set in Remote UI" and "Device Information Delivery Available"

The "Can be set in Remote UI" and "Device Information Delivery Available" items are written for each item in the Settings/Registration table. "Yes" or "No" indicates if the settings can/cannot be set in the Remote UI or are/are not available for Device Information Distribution.

Import All Function

The "Import All Function" item is written in the Settings/Registration table. Depending on whether a setting item can be batch imported, "A", "B", "C", or "No" is written.

- Meanings of A, B, and C

Case A

Importing all to your machine

Restoring the settings information to your machine for backups.

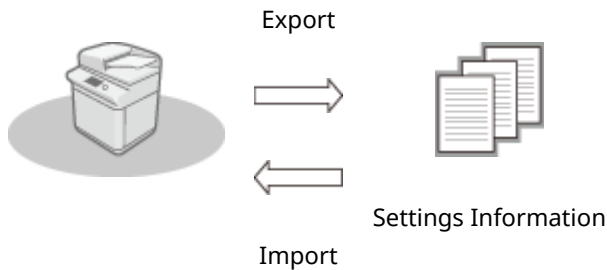

Case B

Importing all to the same model machine

Applies to machines of the same series as this machine.

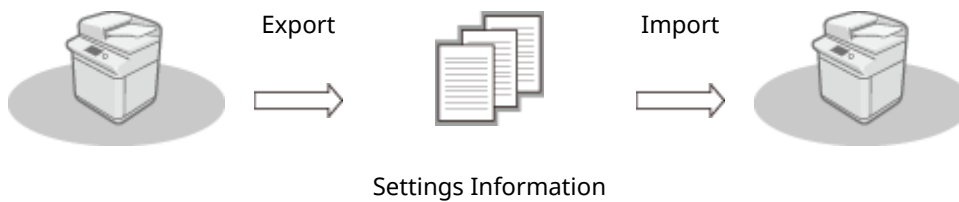

Case C

Importing all to the different model machine

Applies to models that support batch importing.



Name of Item When Exporting with the Remote UI

This section indicates which Settings/Registration items correspond with which items of the batch export function of the Remote UI. "-" is indicated for items that are not imported/exported. **▶Importing/Exporting All Settings(P. 950)**

- **Items Available for Batch Export from Remote UI**
 - Settings/Registration Basic Information
 - Paper Type Management Settings

- Settings for Printer Settings
- Download Profile for Printer Settings
- Forwarding Settings
- Box Settings
- Department ID Management Settings
- Key Settings
- Certificate/Certificate Revocation List (CRL) Settings
- Visual Message Settings
- Home Settings
- Web Access Settings
- Favorite Settings
- Address Book
- User Group Address List
- Authentication User Management
- Security Policy Settings
- Personal Setting Information*
- MEAP Application Setting Information

* For information on the settings that are included in [Personal Setting Information], see **▶List of Items That Can Be Personalized(P. 357)** . Select an item in "Name of Item When Exporting with the Remote UI" listed on the Settings/Registration table when exporting the value (which you set from <Device Settings>) from the Remote UI. **▶<Personal Settings> and <Device Settings>(P. 1056)**

■ <Personal Settings> and <Device Settings>

When User Authentication (**▶Managing Users(P. 803)**) is enabled, <Personal Settings> and <Device Settings> are displayed on the screen after you log in with Administrator privileges by pressing  (Settings/Registration). If you select <Personal Settings> and change the items that can be personalized, settings are registered as the personal settings for the user who is logged into the machine (**▶List of Items That Can Be Personalized(P. 357)**). If you select <Device Settings>, settings are registered as the settings of the machine. If you log in as a user without Administrator privileges, just like when selecting <Personal Settings>, if you change settings that can be personalized, settings are registered as personal settings without being registered as device settings.



<Preferences>

Specify the settings for the machine's operating environment.

- ▶<Paper Settings>(P. 1057)
- ▶<Display Settings>(P. 1057)
- ▶<Timer/Energy Settings>(P. 1057)
- ▶<Network>(P. 1057)
- ▶<External Interface>(P. 1057)
- ▶<Accessibility>(P. 1058)

<Paper Settings>

 (Settings/Registration) ▶ <Preferences>

Specify the settings for the paper used.

- ▶<Paper Settings>(P. 1059)

<Display Settings>

 (Settings/Registration) ▶ <Preferences>

Specify the settings for the touch panel display.

- ▶<Display Settings>(P. 1063)

<Timer/Energy Settings>

 (Settings/Registration) ▶ <Preferences>

Specify the settings for the time, power consumption, etc.

- ▶<Timer/Energy Settings>(P. 1072)

<Network>

 (Settings/Registration) ▶ <Preferences>

Specify the network settings.

- ▶<Network>(P. 1080)

<External Interface>

 (Settings/Registration) ▶ <Preferences>

Specify the settings for external interfaces.

- ▶<External Interface>(P. 1141)

<Accessibility>

 (Settings/Registration) ▶ <Preferences>

Specify the settings for the accessibility functions for people who have difficulty seeing the display or entering data.

 <Accessibility>(P. 1143)

<Paper Settings>

Specify the settings for the paper used.

- ▶ <Paper Settings>(P. 1059)
- ▶ <Paper Size Group for Auto Recognition in Drawer>(P. 1060)
- ▶ <ASR/STMTR Paper Selection>(P. 1060)
- ▶ <Paper Type Management Settings>(P. 1060)
- ▶ <Register Favorite Paper (Multi-Purpose Tray)>(P. 1061)
- ▶ <Multi-Purpose Tray Defaults>(P. 1061)
- ▶ <Register Custom Size>(P. 1062)

NOTE

- For information on the items ("A", "B", "C", and "No") in the "Import All Function" column, see ▶ **Import All Function(P. 1054)** .

<Paper Settings>

 (Settings/Registration) ▶ <Preferences> ▶ <Paper Settings>

You can register the paper size and type for each paper source. This setting enables you to achieve the appropriate print results. ▶ **Specifying Paper Size and Type in the Paper Drawer(P. 65)**

Item	Setting Description	DeviceAdmin	NetworkAdmin	Can be set in Remote UI	Device Information Delivery Available	Import All Function	Name of Item When Exporting with the Remote UI
<Paper Settings>	Paper Source <Set>: <Thin 2 (52-59 g/m2)>, <Thin 1 (60-63 g/m2)>, <Plain 1 (64-75 g/m2)>, <Plain 2 (76-90 g/m2)>, <Plain 3 (91-105 g/m2)>, <Heavy 1 (106-128 g/m2)>, <Heavy 2 (129-150 g/m2)>, <Heavy 3 (151-163 g/m2)>, <Heavy 4 (164-180 g/m2)>, <Heavy 5 (181-220 g/m2)>, <Recycled 1 (64-75 g/m2)>, <Recycled 2 (76-90 g/m2)>, <Pre-Punched 2 (76-90 g/m2)>, <Transparency>, <Color (64-82 g/m2)>, <Letterhead 3> <Custom Size>, <Envelope>, <Unrecognized Standard Size>	Yes	Yes	Yes*1	No	B*2	Settings/Registration Basic Information

*1 <Custom Size> and <Envelope> cannot be set from the Remote UI.

*2 <Custom Size> cannot be imported with the Import All function.

NOTE

- If you have changed the size or type of paper loaded in the paper source, make sure to change this setting as well.

- If you have changed the size or type of paper loaded in the paper source, make sure to change the settings of <Paper Size Group for Auto Recognition in Drawer>.

<Paper Size Group for Auto Recognition in Drawer>

 (Settings/Registration) ▶ <Preferences> ▶ <Paper Settings>

You can set the paper size group for each paper source to make the machine detect the loaded paper size automatically.

Item	Setting Description	DeviceAdmin	NetworkAdmin	Can be set in Remote UI	Device Information Delivery Available	Import All Function	Name of Item When Exporting with the Remote UI
<Paper Size Group for Auto Recognition in Drawer>	<Multi-Purpose Tray>: <A/B Size>, <Inch Size>, <A/K Size> <Paper Drawer>: <All Sizes>, <A/B Size>, <Inch Size>, <A/K Size>	Yes	Yes	No	No	B	Settings/Registration Basic Information

NOTE

- Make sure to set the paper guides to match the paper size. Setting the paper guides incorrectly may result in a paper jam.

<A5R/STMTR Paper Selection>

 (Settings/Registration) ▶ <Preferences> ▶ <Paper Settings>

When A5R or STMTR paper is loaded in the paper drawer, you can set the size to use for the operation.

Item	Setting Description	DeviceAdmin	NetworkAdmin	Can be set in Remote UI	Device Information Delivery Available	Import All Function	Name of Item When Exporting with the Remote UI
<A5R/STMTR Paper Selection>	<A5R>, <STMTR>	Yes	Yes	No	No	B	Settings/Registration Basic Information

NOTE

- This setting is enabled when <All Sizes> is selected in <Paper Size Group for Auto Recognition in Drawer>.

<Paper Type Management Settings>

 (Settings/Registration) ▶ <Preferences> ▶ <Paper Settings>

You can register/edit various customer paper types (user defined paper types), besides the default paper types registered in the machine.  **Paper Type Management Settings(P. 1039)**

Item	Setting Description	DeviceAdmin	NetworkAdmin	Can be set in Remote UI	Device Information Delivery Available	Import All Function	Name of Item When Exporting with the Remote UI
<Paper Type Management Settings>	<Details/Edit> <ul style="list-style-type: none"> <Name>, <Category>, <Basis Weight>, <Finish>, <Type>, <Color>, <Use as Template Paper>, <Adjust Image Position>, <Adjust Creep Correction>, <Adjust Gloss>, <Adj. Secondary Transfer Voltage>, <Adjust Lead Edge Secondary Transfer Voltage>, <Correct Tail End Toner Application> <Duplicate>, <Delete>	Yes	No	Yes	No	C*1	Paper Type Management Settings

*1 <Use as Template Paper>, <Adjust Gloss>, and <Adj. Secondary Transfer Voltage> are categorized as "A".

<Register Favorite Paper (Multi-Purpose Tray)>



 (Settings/Registration) ► <Preferences> ► <Paper Settings>

You can easily specify paper settings by registering paper frequently used in the multi-purpose tray in a button. "Favorite Paper" can be easily recalled from the screen displayed when paper is loaded.  **Registering Frequently Used Paper Size and Type for the Multi-purpose Tray(P. 72)**

Item	Setting Description	DeviceAdmin	NetworkAdmin	Can be set in Remote UI	Device Information Delivery Available	Import All Function	Name of Item When Exporting with the Remote UI
<Register Favorite Paper (Multi-Purpose Tray)>	<P1> to <P30>: <Register/Edit>, <Rename>, <Delete>	Yes	Yes	No	No	B	Settings/Registration Basic Information

<Multi-Purpose Tray Defaults>

 (Settings/Registration) ► <Preferences> ► <Paper Settings>

- You can set the method for selecting the paper to use in the multi-purpose tray. If you always use the same paper size/type in the multi-purpose tray, it is convenient to register the paper in <Use Preset>.  **Fixing the Paper Size and Type to Use with the Multi-Purpose Tray(P. 75)**
- If you use various types of paper in the multi-purpose tray, select <Always Specify>. If you frequently use multiple types of paper, you can eliminate the procedure for selecting the paper type by registering the paper types in advance.  **Registering Frequently Used Paper Size and Type for the Multi-purpose Tray(P. 72)**

Item	Setting Description	DeviceAdmin	NetworkAdmin	Can be set in Remote UI	Device Information Delivery Available	Import All Function	Name of Item When Exporting with the Remote UI
<Multi-Purpose Tray Defaults>	<ul style="list-style-type: none"> • <Use Preset> (<Register>) • <Always Specify> (<Standard>, <Favorite Paper>) 	Yes	Yes	No	No	B	Settings/Registration Basic Information

NOTE

- When the following conditions are met, you can press <Temp. Change Ppr. in MP Tray> on the paper selection screen of <Copy> and <Access Stored Files> to change the paper size/type to load from the multi-purpose tray:
 - If paper is loaded in the multi-purpose tray
 - If this setting is set to <Use Preset>
 - If  <Paper Feed Mode for Printer Driver Jobs with MP Tray>(P. 1203) is set to <Mode A (Prioritize Printer Driver Settings)>

<Register Custom Size>

 (Settings/Registration) ▶ <Preferences> ▶ <Paper Settings>

You can register frequently used free sizes of paper. The paper sizes registered here are displayed on the paper size selection screen for the paper drawer and multi-purpose tray.  **Registering Free Size Paper (Custom Size Paper)(P. 78)**

Item	Setting Description	DeviceAdmin	NetworkAdmin	Can be set in Remote UI	Device Information Delivery Available	Import All Function	Name of Item When Exporting with the Remote UI
<Register Custom Size>	<S1> to <S5>: <Register/Edit>, <Rename>, <Delete>	Yes	Yes	No	Yes	B	Settings/Registration Basic Information

<Display Settings>

Specify the settings for the touch panel display.

- ▶ <Default Screen after Startup/Restoration>(P. 1063)
- ▶ <Default Screen (Status Monitor)>(P. 1064)
- ▶ <Copy Screen Display Settings>(P. 1065)
- ▶ <Display Fax Function>(P. 1065)
- ▶ <Store Location Display Settings>(P. 1065)
- ▶ <Switch Language/Keyboard>(P. 1066)
- ▶ <Display Switch Language/Keyboard Button>(P. 1066)
- ▶ <Use Keyboard Shift Lock Feature>(P. 1066)
- ▶ <Registered Characters for Keyboard>(P. 1067)
- ▶ <Display Remaining Paper Message>(P. 1067)
- ▶ <No. of Copies/Job Duration Status>(P. 1067)
- ▶ <Notify to Clean Original Scanning Area>(P. 1068)
- ▶ <Paper Type Selection Screen Priority>(P. 1068)
- ▶ <Change Default Display for Paper Type List>(P. 1068)
- ▶ <Switch Millimeter/Inch Entry>(P. 1069)
- ▶ <Display Logged-in User Name>(P. 1069)
- ▶ <Display Remaining Toner Error Message>(P. 1069)
- ▶ <Delete Remaining Toner Error>(P. 1070)
- ▶ <IP Address Display Settings>(P. 1070)
- ▶ <Display Scan for Mobile>(P. 1071)
- ▶ <Display Mobile Portal>(P. 1071)
- ▶ <Display QR Code on Mobile Portal>(P. 1071)

NOTE

- For information on the items ("A", "B", "C", and "No") in the "Import All Function" column, see ▶ **Import All Function(P. 1054)** .

Item marked with an asterisk (*)

- Only appears if your machine has a fax function.

<Default Screen after Startup/Restoration>

 (Settings/Registration) ▶ <Preferences> ▶ <Display Settings>

You can set the default screen displayed at startup/restoration.

Item	Setting Description	DeviceAdmin	NetworkAdmin	Can be set in Remote UI	Device Information Delivery Available	Import All Function	Name of Item When Exporting with the Remote UI
<Default Screen after Startup/Restoration>	<Home>, <Copy>, <Fax>*1, <Scan and Send>, <Scan and Store>, <Access Stored Files>, <Fax/I-Fax Inbox>, <Scanner>, <Web Access>, <Tutorial/FAQ>, <Dest./Fwd. Settings>, <Print>, <WSD Scan>, <Scan for Mobile>, <Mobile Portal>, <iW Function Flow>*2, <Scan Lock Analyzer>*2, <uniFLOW Online Setup> The order of the settings may differ from that displayed on the actual machine.	No	No	No	No	C	Settings/Registration Basic Information
	<Open Status Monitor Screen>: <On>, <Off>						

*1 Only appears if your machine has a fax function.

*2 Only appears if you have the option installed.  **Checking the Options Installed on This Machine(P. 1038)**

IMPORTANT

- Depending on the authentication method specified in personal authentication management, the Log In screen may be displayed before the screen set in <Default Screen after Startup/Restoration> is displayed.

NOTE

- When the login service is changed to Department ID Authentication and <Limit Functions> for <Department ID Management> is used, the <Home> screen or the login screen for entering the Department ID/PIN may be displayed before the screen set in <Default Screen after Startup/Restoration>, depending on the settings.

<Default Screen (Status Monitor)>

 (Settings/Registration) ▶ <Preferences> ▶ <Display Settings>

You can change the screen that is displayed when you press  (Status Monitor).

Item	Setting Description	DeviceAdmin	NetworkAdmin	Can be set in Remote UI	Device Information Delivery Available	Import All Function	Name of Item When Exporting with the Remote UI
<Default Screen (Status Monitor)>	<Default Status Type>: <Copy/Print>, <Send>, <Receive>, <Store>, <Consumables/Others>	Yes	Yes	No	No	C	Settings/Registration Basic Information
	<Status/Log>: <Job Status>, <Job Log>						
	<Details> (<Copy/Print>, <Job Status>): <Print>, <Copy>						
	<Details> (<Send>, <Job Status>): <Send>, <Fax>*1						
	<Details> (<Receive>, <Job Status>): <Fax>*1, <Forward>						
	<Details> (<Copy/Print>, <Job Log>): <Copy>, <Printer>, <Local Print>, <Received Job Print>, <Print Report>						
	<Details> (<Send>, <Job Log>): <Send>, <Fax>*1						
	<Details> (<Receive>, <Job Log>): <Receive>, <Fax>*1						

*1 Only appears if your machine has a fax function.

<Copy Screen Display Settings>

 (Settings/Registration) ▶ <Preferences> ▶ <Display Settings>

You can specify the screen that appears when you press <Copy>.  **Changing the Settings Quickly (Express Copy Screen)(P. 516)**

Item	Setting Description	DeviceAdmin	NetworkAdmin	Can be set in Remote UI	Device Information Delivery Available	Import All Function	Name of Item When Exporting with the Remote UI
<Copy Screen Display Settings>	<Regular Copy>, <Express Copy>	Yes	Yes	No	No	C	Settings/Registration Basic Information

<Display Fax Function> *

 (Settings/Registration) ▶ <Preferences> ▶ <Display Settings>

You can set the machine to display the Fax function on the <Home> screen. If you choose to display the Fax function, you can also select whether to display <Fax> in <Scan and Send>. Doing so enables you to send to fax, e-mail, and I-fax destinations at the same time.

Item	Setting Description	DeviceAdmin	NetworkAdmin	Can be set in Remote UI	Device Information Delivery Available	Import All Function	Name of Item When Exporting with the Remote UI
<Display Fax Function>	<On>, <Off>	No	No	No	No	C	Settings/Registration Basic Information
	<Enable Fax in Scan and Send Function>: <On>, <Off>						

<Store Location Display Settings>

 (Settings/Registration) ▶ <Preferences> ▶ <Display Settings>

You can change the destinations that are displayed when you press <Scan and Store> or <Access Stored Files>.

Item	Setting Description	DeviceAdmin	NetworkAdmin	Can be set in Remote UI	Device Information Delivery Available	Import All Function	Name of Item When Exporting with the Remote UI
<Store Location Display Settings>	<Mail Box>: <On>, <Off>	No	No	No	No	C	Settings/Registration Basic Information
	<Advanced Space/Network>: <On>, <Off>						
	<Memory Media>: <On>, <Off>						

<Switch Language/Keyboard>

 (Settings/Registration) ► <Preferences> ► <Display Settings>

You can select the language/keyboard displayed on the touch panel display.

Item	Setting Description	DeviceAdmin	NetworkAdmin	Can be set in Remote UI	Device Information Delivery Available	Import All Function	Name of Item When Exporting with the Remote UI
<Switch Language/Keyboard>	<Language>, <Keyboard Layout>	Yes	Yes	No	No	C	Settings/Registration Basic Information

NOTE

- Some messages may not be displayed properly in the selected language. In this case, restart the machine. Some messages may not change even after the machine is restarted.
- If Server Authentication + Local Device Authentication are set using personal authentication management, and there is a difference between the language set on the machine and the one set in Active Directory, the sender's full name will not appear in e-mail messages sent to the recipient.

<Display Switch Language/Keyboard Button>

 (Settings/Registration) ► <Preferences> ► <Display Settings>

You can display the button that enables you to switch the language and keyboard layout. The button is displayed on the bottom line of the touch panel display.

Item	Setting Description	DeviceAdmin	NetworkAdmin	Can be set in Remote UI	Device Information Delivery Available	Import All Function	Name of Item When Exporting with the Remote UI
<Display Switch Language/Keyboard Button>	<On>, <Off>	Yes	Yes	No	No	C	Settings/Registration Basic Information

<Use Keyboard Shift Lock Feature>

 (Settings/Registration) ► <Preferences> ► <Display Settings>

If you press <Offset> on the keyboard screen, you can enter an uppercase letter. You can specify the shift lock settings for entering uppercase letters continuously or for entering text which begins with an uppercase letter.

Item	Setting Description	DeviceAdmin	NetworkAdmin	Can be set in Remote UI	Device Information Delivery Available	Import All Function	Name of Item When Exporting with the Remote UI
<Use Keyboard Shift Lock Feature>	<On>, <Off>	Yes	Yes	No	Yes	C	Settings/Registration Basic Information

<Registered Characters for Keyboard>

 (Settings/Registration) ▶ <Preferences> ▶ <Display Settings>

You can register strings often used when entering E-Mail/I-Fax destinations using the keyboard.

Item	Setting Description	DeviceAdmin	NetworkAdmin	Can be set in Remote UI	Device Information Delivery Available	Import All Function	Name of Item When Exporting with the Remote UI
<Registered Characters for Keyboard>	<Register/Edit>, <Delete>	Yes	Yes	No	No	C	Settings/Registration Basic Information

<Display Remaining Paper Message>

 (Settings/Registration) ▶ <Preferences> ▶ <Display Settings>

You can set to display a message indicating that the remaining paper loaded in a paper source is low.

Item	Setting Description	DeviceAdmin	NetworkAdmin	Can be set in Remote UI	Device Information Delivery Available	Import All Function	Name of Item When Exporting with the Remote UI
<Display Remaining Paper Message>	<On>, <Off>	Yes	Yes	No	No	C	Settings/Registration Basic Information

<No. of Copies/Job Duration Status>

 (Settings/Registration) ▶ <Preferences> ▶ <Display Settings>

The number of copies specified and the approximate time before the current job completes are displayed on the bottom line of the touch panel display.

Item	Setting Description	DeviceAdmin	NetworkAdmin	Can be set in Remote UI	Device Information Delivery Available	Import All Function	Name of Item When Exporting with the Remote UI
<No. of Copies/Job Duration Status>	<On>, <Off>	Yes	Yes	No	No	C	Settings/Registration Basic Information

NOTE

- The accuracy of the approximate times that appear on the bottom line of the touch panel display may vary, depending on the status of the machine.
- The approximate time does not appear when the wait time is less than one minute.

<Notify to Clean Original Scanning Area>

 (Settings/Registration) ▶ <Preferences> ▶ <Display Settings>

You can set the machine to display the message that prompts you to clean the scanning area when the machine detects stains in the document feed scanning area.

Item	Setting Description	DeviceAdmin	NetworkAdmin	Can be set in Remote UI	Device Information Delivery Available	Import All Function	Name of Item When Exporting with the Remote UI
<Notify to Clean Original Scanning Area>	<On>, <Off>	Yes	Yes	No	No	C	Settings/Registration Basic Information

<Paper Type Selection Screen Priority>

 (Settings/Registration) ▶ <Preferences> ▶ <Display Settings>

You can set whether to prioritize the simple (<Simple>) or detailed (<Detailed>) setting screen when you display the screen to select the paper type.

Item	Setting Description	DeviceAdmin	NetworkAdmin	Can be set in Remote UI	Device Information Delivery Available	Import All Function	Name of Item When Exporting with the Remote UI
<Paper Type Selection Screen Priority>	<Simple>, <Detailed>	Yes	Yes	No	No	C	Settings/Registration Basic Information

<Change Default Display for Paper Type List>

 (Settings/Registration) ▶ <Preferences> ▶ <Display Settings>

Specify the type of list displayed for selecting the paper type and the order in which the list items are shown.

Item	Setting Description	DeviceAdmin	NetworkAdmin	Can be set in Remote UI	Device Information Delivery Available	Import All Function	Name of Item When Exporting with the Remote UI
<Change Default Display for Paper Type List>	<Category>: <All>, <Standard Type>, <Custom Type> <Sort>: <Registered (Asc.)>, <Registered (Desc.)>, <Name (Asc.)>, <Name (Desc.)>, <Weight (Asc.)>, <Weight (Desc.)>	Yes	Yes	No	No	C	Settings/Registration Basic Information

<Switch Millimeter/Inch Entry>

 (Settings/Registration) ▶ <Preferences> ▶ <Display Settings>

You can set whether to enter numeric values in millimeters or inches on the various numeric entry screens.

Item	Setting Description	DeviceAdmin	NetworkAdmin	Can be set in Remote UI	Device Information Delivery Available	Import All Function	Name of Item When Exporting with the Remote UI
<Switch Millimeter/Inch Entry>	<mm>, <Inch>	Yes	Yes	No	Yes	C	Settings/Registration Basic Information

<Display Logged-in User Name>

 (Settings/Registration) ▶ <Preferences> ▶ <Display Settings>

You can select whether to display the user name/display name on the touch panel display.

Item	Setting Description	DeviceAdmin	NetworkAdmin	Can be set in Remote UI	Device Information Delivery Available	Import All Function	Name of Item When Exporting with the Remote UI
<Display Logged-in User Name>	<At Screen Top> (<User Name>, <Display Name>), <At Screen Bottom>, <Off>	No	No	No	No	C	Settings/Registration Basic Information

NOTE

- If DepartmentID Authentication is set as the login service and <Department ID Management> is set to <On>, the Department ID is displayed when <At Screen Bottom> is selected. It is not displayed on the top of the screen.
- If User Authentication is set as the login service, <User Name> is displayed when <At Screen Bottom> is selected.

<Display Remaining Toner Error Message>

 (Settings/Registration) ▶ <Preferences> ▶ <Display Settings>

Displays a warning screen that enables you to identify which color is running low when remaining toner is low. This message is useful, as it enables you to prepare a new toner cartridge in advance, etc.

Item	Setting Description	DeviceAdmin	NetworkAdmin	Can be set in Remote UI	Device Information Delivery Available	Import All Function	Name of Item When Exporting with the Remote UI
<Display Remaining Toner Error Message>	<On>, <Off>	Yes	No	No	No	C	Settings/Registration Basic Information

NOTE

- The following warning screen is displayed.



- If you press <Close> on the warning screen to close the screen, you can perform normal operations. However, the warning screen will appear every time the machine returns from sleep mode or when the main power is turned ON.
- If you have already prepared a new toner cartridge, etc., and the notification becomes unnecessary, perform the <Delete Remaining Toner Error> operation.
- The message indicating the status remains on the bottom of the screen, regardless of this setting.

<Delete Remaining Toner Error>

(Settings/Registration) ▶ <Preferences> ▶ <Display Settings>

You can delete the warning screen which appears when the remaining toner is low if <Display Remaining Toner Error Message> is set to <On>.

Item	Setting Description	DeviceAdmin	NetworkAdmin	Can be set in Remote UI	Device Information Delivery Available	Import All Function	Name of Item When Exporting with the Remote UI
<Delete Remaining Toner Error>	<Yes>, <No>	Yes	Yes	No	No	No	-

NOTE

- The warning screen will appear again when a different color toner becomes low, if <Display Remaining Toner Error Message> is set to <On>.

<IP Address Display Settings>

(Settings/Registration) ▶ <Preferences> ▶ <Display Settings>

You can set whether to display the IP address on the counter information screen.

Item	Setting Description	DeviceAdmin	NetworkAdmin	Can be set in Remote UI	Device Information Delivery Available	Import All Function	Name of Item When Exporting with the Remote UI
<IP Address Display Settings>	<On>, <Off>	No	Yes	No	No	C	Settings/Registration Basic Information

NOTE

- This setting is only valid when <Use IPv4> is set to <On>.

<Display Scan for Mobile>

 (Settings/Registration) ▶ <Preferences> ▶ <Display Settings>

You can set whether to enable the <Scan for Mobile> setting, which sends scanned data to mobile devices such as smartphones and tablets.

Item	Setting Description	DeviceAdmin	NetworkAdmin	Can be set in Remote UI	Device Information Delivery Available	Import All Function	Name of Item When Exporting with the Remote UI
<Display Scan for Mobile>	<On>, <Off>	No	Yes	No	No	C	Settings/Registration Basic Information

<Display Mobile Portal>

 (Settings/Registration) ▶ <Preferences> ▶ <Display Settings>

You can set whether to display <Mobile Portal> on the <Home> screen.

Item	Setting Description	DeviceAdmin	NetworkAdmin	Can be set in Remote UI	Device Information Delivery Available	Import All Function	Name of Item When Exporting with the Remote UI
<Display Mobile Portal>	<On>, <Off>	No	Yes	Yes	No	C	Settings/Registration Basic Information

<Display QR Code on Mobile Portal>

 (Settings/Registration) ▶ <Preferences> ▶ <Display Settings>

You can set whether to display a QR code on the <Mobile Portal> screen. Using a QR code saves you the effort of entering the IPv4 address of the machine.

Item	Setting Description	DeviceAdmin	NetworkAdmin	Can be set in Remote UI	Device Information Delivery Available	Import All Function	Name of Item When Exporting with the Remote UI
<Display QR Code on Mobile Portal>	<On>, <Off>	No	Yes	Yes	No	C	Settings/Registration Basic Information

<Timer/Energy Settings>

Specify the settings for the time, power consumption, etc.

- ▶<Adjust Time>(P. 1072)
- ▶<Date/Time Settings>(P. 1072)
- ▶<Time Format>(P. 1073)
- ▶<Quick Startup Settings for Main Power>(P. 1073)
- ▶<Auto Reset Time>(P. 1074)
- ▶<Restrict Auto Reset Time>(P. 1075)
- ▶<Function After Auto Reset>(P. 1075)
- ▶<Auto Shutdown Time>(P. 1075)
- ▶<Auto Shutdown Weekly Timer>(P. 1076)
- ▶<Auto Sleep Time>(P. 1076)
- ▶<Sleep Mode Energy Use>(P. 1077)
- ▶<Auto Sleep Weekly Timer>(P. 1077)
- ▶<Time Settings for Auto Adjust Gradation>(P. 1078)
- ▶<Sleep Mode Exit Time Settings>(P. 1078)
- ▶<Sleep Mode Eco Exit>(P. 1078)

NOTE

- For information on the items ("A", "B", "C", and "No") in the "Import All Function" column, see ▶<Import All Function>(P. 1054) .

<Adjust Time>

 (Settings/Registration) ▶ <Preferences> ▶ <Timer/Energy Settings>

You can adjust the time in minutes.

Item	Setting Description	DeviceAdmin	NetworkAdmin	Can be set in Remote UI	Device Information Delivery Available	Import All Function	Name of Item When Exporting with the Remote UI
<Adjust Time>	00:00 to 23:59, in one minute increments	Yes	Yes	No	No	No	-

NOTE

- Even if you change the time from 23:59 to 00:00, the date will not be changed.

Date/Time Settings

 (Settings/Registration) ▶ <Preferences> ▶ <Timer/Energy Settings>

Setting the current date and time is very important. For instructions on how to configure the setting, see ▶<Setting the Date/Time>(P. 261) .

Item	Setting Description	DeviceAdmin	NetworkAdmin	Can be set in Remote UI	Device Information Delivery Available	Import All Function	Name of Item When Exporting with the Remote UI
<Date/Time Settings>	Date and Time Setting (12 digit number)	No	No	Yes	No	No	-

Item	Setting Description	DeviceAdmin	NetworkAdmin	Can be set in Remote UI	Device Information Delivery Available	Import All Function	Name of Item When Exporting with the Remote UI
	<Time Zone>: UTC-12:00 to UTC+00:00 to UTC+14:00	No	No	Yes	No	C	Settings/Registration Basic Information
	<Daylight Saving Time>: <On>, <Off>	No	No	Yes	No	C	Settings/Registration Basic Information
	<Start Date> (<Month>/<Day>/<Time> (0 to 23)), <End Date> (<Month>/<Day>/<Time> (0 to 23))	No	No	Yes	No	C	Settings/Registration Basic Information

<Time Format>

 (Settings/Registration) ▶ <Preferences> ▶ <Timer/Energy Settings>

You can set whether to display the time in 24-hour notation or 12-hour notation.

Item	Setting Description	DeviceAdmin	NetworkAdmin	Can be set in Remote UI	Device Information Delivery Available	Import All Function	Name of Item When Exporting with the Remote UI
<Time Format>	<24 Hour> , <12 Hour>	No	No	Yes	No	C	Settings/Registration Basic Information

NOTE

- You can also specify to automatically synchronize the date and time with a server on the network using SNTP.  **Making SNTP Settings(P. 309)**

<Quick Startup Settings for Main Power>

 (Settings/Registration) ▶ <Preferences> ▶ <Timer/Energy Settings>

If you set this function to <On>, you can reduce the time it takes until you can perform operations on the screen and scan originals after the power is turned ON.

Item	Setting Description	DeviceAdmin	NetworkAdmin	Can be set in Remote UI	Device Information Delivery Available	Import All Function	Name of Item When Exporting with the Remote UI
<Quick Startup Settings for Main Power>	<On> , <Off>	No	No	Yes	Yes	C	Settings/Registration Basic Information

NOTE

- When this function is enabled

- Standby power is consumed even when the power is turned OFF.
- A tone sounds when the machine is turned ON, or when the machine is turned OFF if you set <Sleep Mode Tone> in <Other Volume Settings> to <On>. (However, the machine may not be able to start up quickly and the tone may not sound, depending on the status of the machine.)
- Even if this function is set to 'On', the machine does not startup quickly in the following situations:
 - When any of the Wi-Fi network settings is set to 'On'
 - When turning ON the main power of the machine after turning OFF the main power in any of the conditions below
 - More than 110 hours have elapsed after quick startup
 - Operating jobs
 - Jobs are reserved
 - Just after using telephone lines
 - Backing up data
 - Accessing to the machine via network
 - After specifying settings which require restarting the machine
 - Error is occurred
 - Using the Limited Functions mode
 - The power cord is disconnected after turning OFF the main power
 - MEAP applications which do not support quick startup are installed on the machine
 - When turning ON the main power of the machine in 20 seconds after turning OFF the main power
 - When turning ON the main power of the machine after eight hours have passed since the machine was turned OFF
 - When turning ON the main power of the machine after turning OFF the main power from the Remote UI

<Auto Reset Time>

 (Settings/Registration) ▶ <Preferences> ▶ <Timer/Energy Settings>

You can specify the time period in which you are logged out and the touch panel display returns to the default setting automatically.

Item	Setting Description	DeviceAdmin	NetworkAdmin	Can be set in Remote UI	Device Information Delivery Available	Import All Function	Name of Item When Exporting with the Remote UI
<Auto Reset Time>	0 min=Off, 10 to 50 seconds in 10 second increments, 1 to 2 to 9 minutes in one minute increments	Yes	Yes	Yes	Yes	C	Settings/Registration Basic Information

NOTE

- If the login service is being used, the machine automatically logs out the user when the Auto Reset Time elapses.
- The screen displayed after the Auto Reset initiates differs depending on the following settings.
 - Setting 1: The settings in [Visual Message Settings] (when [When to Display] is set to [After Logout/Auto Reset])
 - When Visual Message is not set or after the displayed Visual Message screen is closed, the screen that is specified in Setting 2 is displayed.
 - Setting 2: The settings in <Function After Auto Reset>
 - When <Initial Function> is set, the screen specified in <Default Screen after Startup/Restoration> (Setting 3) is displayed.

- When <Selected Function> is set, the function before the Auto Reset initiates is displayed. (The specified settings and entered values for each function will be cleared.) However, the <Selected Function> settings may not be correctly reflected, and the screen specified in <Default Screen after Startup/Restoration> may be displayed.
- Setting 3: The settings in <Default Screen after Startup/Restoration>

<Restrict Auto Reset Time>

 (Settings/Registration) ▶ <Preferences> ▶ <Timer/Energy Settings>

If you set this function to <On>, general users become unable to set <Auto Reset Time> and <Function After Auto Reset>.

Item	Setting Description	DeviceAdmin	NetworkAdmin	Can be set in Remote UI	Device Information Delivery Available	Import All Function	Name of Item When Exporting with the Remote UI
<Restrict Auto Reset Time>	<On>, <Off>	No	No	Yes	Yes	C	Settings/Registration Basic Information

<Function After Auto Reset>

 (Settings/Registration) ▶ <Preferences> ▶ <Timer/Energy Settings>

You can set whether the default screen set for <Default Screen after Startup/Restoration> in <Preferences> or the immediately previous screen is displayed at startup after the Auto Reset initiates.

Item	Setting Description	DeviceAdmin	NetworkAdmin	Can be set in Remote UI	Device Information Delivery Available	Import All Function	Name of Item When Exporting with the Remote UI
<Function After Auto Reset>	<Initial Function>, <Selected Function>	Yes	Yes	Yes	Yes	C	Settings/Registration Basic Information

NOTE

- If Visual Message is set to be displayed after the Auto Reset mode initiates, the Visual Message screen is displayed first, regardless of this setting.  **Configuring the Visual Message Function(P. 979)**

<Auto Shutdown Time>

 (Settings/Registration) ▶ <Preferences> ▶ <Timer/Energy Settings>

With the Auto Shutdown, if the touch panel display of the machine is idle for a certain period of time after it has entered the Sleep mode, the machine automatically shuts down.

Item	Setting Description	DeviceAdmin	NetworkAdmin	Can be set in Remote UI	Device Information Delivery Available	Import All Function	Name of Item When Exporting with the Remote UI
<Auto Shutdown Time>	0 hr=Off, 1 to 4 to 8 hours in one hour increments	No	No	Yes	Yes	C	Settings/Registration Basic Information

IMPORTANT

- If the optional fax board is installed, the Auto Shutdown will not be performed.
- Even when operating the machine from the Remote UI, the machine automatically shuts down if the touch panel display of the machine is idle for a certain period of time. A malfunction may occur particularly if the machine automatically shuts down while importing. Set <Auto Shutdown Time> to <0> when importing data.

NOTE

- The Auto Shutdown may not be performed, depending on the usage conditions of the machine.

<Auto Shutdown Weekly Timer>

 (Settings/Registration) ▶ <Preferences> ▶ <Timer/Energy Settings>

You can set the time that the machine automatically shuts down each day of the week. If you use this function, you do not have to shut down the machine manually every day.

Item	Setting Description	DeviceAdmin	NetworkAdmin	Can be set in Remote UI	Device Information Delivery Available	Import All Function	Name of Item When Exporting with the Remote UI
<Auto Shutdown Weekly Timer>	Sun to Sat, 00:00 to 23:59, in one minute increments	No	No	Yes	Yes	C	Settings/Registration Basic Information

NOTE

- If both <Auto Shutdown Time> and <Auto Shutdown Weekly Timer> are set, priority is given to <Auto Shutdown Time>.

<Auto Sleep Time>

 (Settings/Registration) ▶ <Preferences> ▶ <Timer/Energy Settings>

You can set the time until the machine automatically enters the Sleep mode if no operations are performed.

Item	Setting Description	DeviceAdmin	NetworkAdmin	Can be set in Remote UI	Device Information Delivery Available	Import All Function	Name of Item When Exporting with the Remote UI
<Auto Sleep Time>	10 secs, 1 min , 2 mins, 10 mins, 15 mins, 20 mins, 30 mins, 40 mins, 50 mins, 1 hr, 90 mins*1, 2 hrs*1	Yes	Yes	Yes	Yes	C	Settings/Registration Basic Information

*1 May not appear on some models.

NOTE

- It is recommended that the default value is used for this setting.

<Sleep Mode Energy Use>

 (Settings/Registration) ► <Preferences> ► <Timer/Energy Settings>

You can set the amount of energy that the machine consumes when it is in the Sleep mode.

Item	Setting Description	DeviceAdmin	NetworkAdmin	Can be set in Remote UI	Device Information Delivery Available	Import All Function	Name of Item When Exporting with the Remote UI
<Sleep Mode Energy Use>	<Low>, <High>	Yes	Yes	Yes	Yes	C	Settings/Registration Basic Information

IMPORTANT

- If the machine is connected to a computer using a USB cable, depending on the timing for entering the sleep mode, the machine may be unable to receive data correctly. Reactivate the machine from the sleep mode, then execute the job again.
- The energy consumption level may be the same as when <High> is set even when <Low> is set, depending on the status of the machine.

NOTE

- When performing wireless communication while <Wireless LAN Settings> is enabled, <Sleep Mode Energy Use> must be manually set to <High>.
- If the energy consumption level is set to <Low>, communication failure may occur, depending on the network utility software you are using. To avoid this, press the Energy Saver key to cancel the Sleep mode before using the machine.

<Auto Sleep Weekly Timer>

 (Settings/Registration) ► <Preferences> ► <Timer/Energy Settings>

You can set the time that the machine automatically enters the Sleep mode each day of the week.

Item	Setting Description	DeviceAdmin	NetworkAdmin	Can be set in Remote UI	Device Information Delivery Available	Import All Function	Name of Item When Exporting with the Remote UI
<Auto Sleep Weekly Timer>	<Sunday> to <Saturday>, 00:00 to 23:59, in one minute increments	Yes	Yes	Yes	Yes	C	Settings/Registration Basic Information

NOTE

- If you set both the <Auto Sleep Time> and <Auto Sleep Weekly Timer>, the <Auto Sleep Time> setting is given priority.

<Time Settings for Auto Adjust Gradation>

 (Settings/Registration) ▶ <Preferences> ▶ <Timer/Energy Settings>

You can automatically perform the automatic gradation adjustment at a set time every day.

Item	Setting Description	DeviceAdmin	NetworkAdmin	Can be set in Remote UI	Device Information Delivery Available	Import All Function	Name of Item When Exporting with the Remote UI
<Time Settings for Auto Adjust Gradation>	<Sunday> to <Saturday>, 00:00 to 23:59, in one minute increments	Yes	Yes	Yes	Yes	C	Settings/Registration Basic Information

<Sleep Mode Exit Time Settings>

 (Settings/Registration) ▶ <Preferences> ▶ <Timer/Energy Settings>

You can set the time at which the machine recovers from the Sleep mode.

Item	Setting Description	DeviceAdmin	NetworkAdmin	Can be set in Remote UI	Device Information Delivery Available	Import All Function	Name of Item When Exporting with the Remote UI
<Sleep Mode Exit Time Settings>	00:00 to 23:59, in one minute increments	Yes	Yes	Yes	Yes	C	Settings/Registration Basic Information

<Sleep Mode Eco Exit>

 (Settings/Registration) ▶ <Preferences> ▶ <Timer/Energy Settings>

When you cancel sleep mode and start the operation, you can activate necessary functions sequentially. The control panel is activated first, followed by other functions activated in response to the user's operations. You can save energy and lower noise by not activating unnecessary functions.

Settings/Registration

Item	Setting Description	DeviceAdmin	NetworkAdmin	Can be set in Remote UI	Device Information Delivery Available	Import All Function	Name of Item When Exporting with the Remote UI
<Sleep Mode Eco Exit>	<On>, <Off>	Yes	Yes	Yes	No	C	Settings/Registration Basic Information

<Network>

Specify the network settings.

- ▶<Output Report>(P. 1080)
- ▶<Confirm Network Connection Setting Changes>(P. 1080)
- ▶<TCP/IP Settings>(P. 1081)
- ▶<SNMP Settings>(P. 1081)
- ▶<Format Host Resources MIB to RFC2790>(P. 1083)
- ▶<Dedicated Port Settings>(P. 1083)
- ▶<Dedicated Port Authentication Method>(P. 1083)
- ▶<Use Spool Function>(P. 1084)
- ▶<Waiting Time for Connection at Startup>(P. 1084)
- ▶<Ethernet Driver Settings>(P. 1084)
- ▶<Sleep Mode Priority Settings>(P. 1085)
- ▶<IEEE 802.1X Settings>(P. 1085)
- ▶<Firewall Settings>(P. 1087)
- ▶<Use Mopria>(P. 1087)
- ▶<Use AirPrint>(P. 1087)
- ▶<Display Errors for AirPrint>(P. 1087)
- ▶<Use IPP Everywhere>(P. 1088)
- ▶<Settings for Universal Print>(P. 1088)
- ▶<Device Position Information Settings>(P. 1089)
- ▶<Select Interface>(P. 1089)
- ▶<Wireless LAN>(P. 1090)
- ▶<Direct Connection Settings>(P. 1090)
- ▶<Sub Line Settings>(P. 1090)
- ▶<Static Routing Settings>(P. 1090)

NOTE

- For information on the items ("A", "B", "C", and "No") in the "Import All Function" column, see ▶<Import All Function>(P. 1054) .

Item marked with an asterisk (*)

- Only appears if you have the option installed. ▶<Checking the Options Installed on This Machine>(P. 1038)

<Output Report>

 (Settings/Registration) ▶ <Preferences> ▶ <Network>

You can print the settings in <Network>. ▶<Printing a List of Settings>(P. 1034)

Item	Setting Description	DeviceAdmin	NetworkAdmin	Can be set in Remote UI	Device Information Delivery Available	Import All Function	Name of Item When Exporting with the Remote UI
<Output Report>	<Yes>, <No>	Yes	Yes	Yes	No	No	-

<Confirm Network Connection Setting Changes>

 (Settings/Registration) ▶ <Preferences> ▶ <Network>

If this setting is set to <On>, you can change network settings. If errors related to network connections occur, an error message appears on the touch panel display of the machine. ▶<Canceling the Network Setting Lock>(P. 266)

Item	Setting Description	DeviceAdmin	NetworkAdmin	Can be set in Remote UI	Device Information Delivery Available	Import All Function	Name of Item When Exporting with the Remote UI
<Confirm Network Connection Setting Changes>	<On>, <Off>	No	Yes	No	Yes	C	Settings/Registration Basic Information

<TCP/IP Settings>

 (Settings/Registration) ▶ <Preferences> ▶ <Network>

Specify the settings that enable the machine to be used on a TCP/IP network.

 <TCP/IP Settings>(P. 1092)

<SNMP Settings>

 (Settings/Registration) ▶ <Preferences> ▶ <Network>

Specify the SNMP settings.  **Monitoring and Controlling via SNMP(P. 303)**

Item	Setting Description	DeviceAdmin	NetworkAdmin	Can be set in Remote UI	Device Information Delivery Available	Import All Function	Name of Item When Exporting with the Remote UI
<Use SNMPv1>	<On>, <Off>	No	Yes	Yes	Yes	C	Settings/Registration Basic Information
<Set Dedicated Community>	<Dedicated Community>: <On>, <Off>	No	Yes	Yes	No	C	Settings/Registration Basic Information
	<MIB Access Permission>: <Read/Write>, <Read Only>	No	Yes	Yes	No	C	Settings/Registration Basic Information
<Set Community Name 1>	<Community Name 1>: <On>, <Off>	No	Yes	Yes	No	C	Settings/Registration Basic Information
	<MIB Access Permission>: <Read/Write>, <Read Only>	No	Yes	Yes	No	C	Settings/Registration Basic Information
	<Community Name>: public	No	Yes	Yes	No	C	Settings/Registration Basic Information
<Set Community Name 2>	<Community Name 2>: <On>, <Off>	No	Yes	Yes	No	C	Settings/Registration Basic Information
	<MIB Access Permission>: <Read/Write>, <Read Only>	No	Yes	Yes	No	C	Settings/Registration Basic Information
	<Community Name>: public2	No	Yes	Yes	No	C	Settings/Registration Basic Information
<Use SNMPv3>	<On>, <Off>	No	Yes	Yes	No	C	Settings/Registration Basic Information

Settings/Registration

Item	Setting Description	DeviceAdmin	NetworkAdmin	Can be set in Remote UI	Device Information Delivery Available	Import All Function	Name of Item When Exporting with the Remote UI
<Administrator Settings>	<Use Administrator>: <On>, <Off>	No	Yes	Yes	No	C	Settings/ Registration Basic Information
	<Encryption Password>	No	Yes	Yes	No	C	Settings/ Registration Basic Information
	<Use Same Password as for Authentication>: <On>, <Off>	No	Yes	Yes	No	C	Settings/ Registration Basic Information
<User Settings>	<User On/Off>: <On>, <Off>	No	Yes	Yes	No	C	Settings/ Registration Basic Information
	<Register> (<User Name>, <MIB Access Permission> (<Read/Write>, <Read Only>), <Security Settings> (<Auth. Yes/Encrypt. Yes>, <Auth. Yes/Encrypt. No>, <Auth. No/Encrypt. No>), <Authentication Algorithm> (<MD5>, <SHA1>, <SHA2-224>, <SHA2-256>, <SHA2-384>, <SHA2-512>), <Authentication Password>, <Encryption Algorithm> (<DES>, <AES>), <Encryption Password>)	No	Yes	Yes	No	C	Settings/ Registration Basic Information
	<Details/Edit> (<User Name>, <MIB Access Permission> (<Read/Write>, <Read Only>), <Security Settings> (<Auth. Yes/Encrypt. Yes>, <Auth. Yes/Encrypt. No>, <Auth. No/Encrypt. No>), <Authentication Algorithm> (<MD5>, <SHA1>, <SHA2-224>, <SHA2-256>, <SHA2-384>, <SHA2-512>), <Authentication Password>, <Encryption Algorithm> (<DES>, <AES>), <Encryption Password>)	No	Yes	Yes	No	C	Settings/ Registration Basic Information
	<Delete>	No	Yes	Yes	No	No	-
<Retrieve Printer Mngt. Information from Host>	<On>, <Off>	No	Yes	Yes	Yes	C	Settings/ Registration Basic Information

Item	Setting Description	DeviceAdmin	NetworkAdmin	Can be set in Remote UI	Device Information Delivery Available	Import All Function	Name of Item When Exporting with the Remote UI
<Reject SNMP Packets While in Sleep Mode>	<On>, <Off>	No	Yes	Yes	No	C	Settings/Registration Basic Information

<Format Host Resources MIB to RFC2790>

 (Settings/Registration) ► <Preferences> ► <Network>

Specify whether the host resources MIB is compliant with the specifications of RFC2790.

Item	Setting Description	DeviceAdmin	NetworkAdmin	Can be set in Remote UI	Device Information Delivery Available	Import All Function	Name of Item When Exporting with the Remote UI
<Format Host Resources MIB to RFC2790>	<On>, <Off>	No	Yes	No	No	C	Settings/Registration Basic Information

<Dedicated Port Settings>

 (Settings/Registration) ► <Preferences> ► <Network>

Specify whether to configure/refer to detailed information of the machine from the Canon drivers or utility software.

Item	Setting Description	DeviceAdmin	NetworkAdmin	Can be set in Remote UI	Device Information Delivery Available	Import All Function	Name of Item When Exporting with the Remote UI
<Dedicated Port Settings>	<On>, <Off>	No	Yes	Yes	Yes	C	Settings/Registration Basic Information

NOTE

- If the setting is set to <Off>, some application that uses dedicated port may not be used.

<Dedicated Port Authentication Method>

 (Settings/Registration) ► <Preferences> ► <Network>

Specify the authentication method for the dedicated port.

Item	Setting Description	DeviceAdmin	NetworkAdmin	Can be set in Remote UI	Device Information Delivery Available	Import All Function	Name of Item When Exporting with the Remote UI
<Dedicated Port Authentication Method>	<Mode 1>, <Mode 2>	No	Yes	Yes	No	C	Settings/Registration Basic Information

NOTE

- If the setting is set to <Mode 2>, communication using a dedicated port uses a secure mode. Accordingly, you may not be able to connect from device management software or drivers, etc.

<Use Spool Function>

 (Settings/Registration) ▶ <Preferences> ▶ <Network>

Specify whether to spool print jobs that are sent to the machine in the storage device of the machine.

Item	Setting Description	DeviceAdmin	NetworkAdmin	Can be set in Remote UI	Device Information Delivery Available	Import All Function	Name of Item When Exporting with the Remote UI
<Use Spool Function>	<On>, <Off>	No	Yes	Yes	Yes	C	Settings/Registration Basic Information

<Waiting Time for Connection at Startup>

 (Settings/Registration) ▶ <Preferences> ▶ <Network>

Specify the waiting time for connecting to a network from when the machine starts.  **Setting the Wait Time When Connecting to a Network(P. 288)**

Item	Setting Description	DeviceAdmin	NetworkAdmin	Can be set in Remote UI	Device Information Delivery Available	Import All Function	Name of Item When Exporting with the Remote UI
<Waiting Time for Connection at Startup>	0 to 300 sec.	No	Yes	Yes	No	C	Settings/Registration Basic Information

<Ethernet Driver Settings>

 (Settings/Registration) ▶ <Preferences> ▶ <Network>

Specify the Ethernet driver settings.  **Making Ethernet Settings(P. 286)**

Item	Setting Description	DeviceAdmin	NetworkAdmin	Can be set in Remote UI	Device Information Delivery Available	Import All Function	Name of Item When Exporting with the Remote UI
<Ethernet Driver Settings>	<Auto Detect>: <On>, <Off>	No	Yes	Yes	No	C	Settings/ Registration Basic Information
	• <Communication Mode> (Off): <Half Duplex>, <Full Duplex>	No	Yes	Yes	No	C	Settings/ Registration Basic Information
	• <Ethernet Type> (Off): <10BASE-T>, <100BASE-TX>, <1000BASE-T>	No	Yes	Yes	No	C	Settings/ Registration Basic Information
	<Current Transmission Speed>: Display Only	No	Yes	Yes	No	No	-
	<MAC Address>: Display only	No	Yes	Yes	No	No	-

<Sleep Mode Priority Settings>

 (Settings/Registration) ▶ <Preferences> ▶ <Network>

Put a priority on either the speed of waking from sleep mode or saving power consumption during sleep mode.

Item	Setting Description	DeviceAdmin	NetworkAdmin	Can be set in Remote UI	Device Information Delivery Available	Import All Function	Name of Item When Exporting with the Remote UI
<Sleep Mode Priority Settings>	<Exit Speed>, <Energy Saving>	No	Yes	Yes	No	C	Settings/Registration Basic Information

<IEEE 802.1X Settings>

 (Settings/Registration) ▶ <Preferences> ▶ <Network>

Specify the settings for IEEE 802.1X.  **Configuring the IEEE 802.1X Authentication Settings(P. 874)**

Item	Setting Description	DeviceAdmin	NetworkAdmin	Can be set in Remote UI	Device Information Delivery Available	Import All Function	Name of Item When Exporting with the Remote UI
<Use IEEE 802.1X>	<On>, <Off>	No	Yes	Yes	No	C	Settings/ Registration Basic Information
<Login Name>	Login Name	No	Yes	Yes	No	C	Settings/ Registration Basic Information

Settings/Registration

Item	Setting Description	DeviceAdmin	NetworkAdmin	Can be set in Remote UI	Device Information Delivery Available	Import All Function	Name of Item When Exporting with the Remote UI
<Verify Authentication Server Certificate>	<On>, <Off>	No	Yes	Yes	No	C	Settings/ Registration Basic Information
<Verify Authentication Server Name>	<On>, <Off>	No	Yes	Yes	No	C	Settings/ Registration Basic Information
<Authentication Server Name>	Authentication Server Name	No	Yes	Yes	No	C	Settings/ Registration Basic Information
<Use TLS>	<On>, <Off>	No	Yes	Yes	No	C	Settings/ Registration Basic Information
<Key and Certificate>	Set as Default Key	No	Yes	Yes	No	No	-
	<Certificate Details> (<Version>, <Serial Number>, <Signature Algorithm>, <Issued To>, <Validity Start Date>, <Validity End Date>, <Issuer>, <Public Key>, <Certificate Thumbprint>, <Issued To (Altn. Name)>, <Verify Certificate>)	No	Yes	Yes	No	No	-
	<Display Use Location> (Key and Certificate)	No	Yes	Yes	No	No	-
<Use TTLS>	<On>, <Off>	No	Yes	Yes	No	C	Settings/ Registration Basic Information
	<ul style="list-style-type: none"> <TTLS Settings (TTLS Protocol)>: <MSCHAPv2>, <PAP> 	No	Yes	Yes	No	C	Settings/ Registration Basic Information
<Use PEAP>	<On>, <Off>	No	Yes	Yes	No	C	Settings/ Registration Basic Information
<User Name>	Name of the user to be authenticated with IEEE802.1X authentication	No	Yes	Yes	No	C	Settings/ Registration Basic Information
<Password>	Password of the user to be authenticated with IEEE802.1X authentication	No	Yes	Yes	No	C	Settings/ Registration Basic Information
<Same User Name as Login Name>	<On>, <Off>	No	Yes	Yes	No	C	Settings/ Registration Basic Information

IMPORTANT

- If you set <IEEE 802.1X Settings> to <On>, the machine will not completely enter the Sleep mode.

<Firewall Settings>

 (Settings/Registration) ▶ <Preferences> ▶ <Network>

Specify the packet filtering settings that permit communication only with devices that have a specific IP address and MAC address.

 <Firewall Settings>(P. 1118)

<Use Mopria>

 (Settings/Registration) ▶ <Preferences> ▶ <Network>

Specify whether to print data directly from mobile devices that support Mopria[®], such as smartphones and tablets.  **Utilizing the Machine through Applications(P. 770)**

Item	Setting Description	DeviceAdmin	NetworkAdmin	Can be set in Remote UI	Device Information Delivery Available	Import All Function	Name of Item When Exporting with the Remote UI
<Use Mopria>	<On>, <Off>	No	Yes	Yes	Yes	C	Settings/Registration Basic Information

<Use AirPrint>

 (Settings/Registration) ▶ <Preferences> ▶ <Network>

Specify whether to print directly from an iPhone, iPad, iPod Touch, or Mac that supports AirPrint.  **Using AirPrint(P. 773)**

Item	Setting Description	DeviceAdmin	NetworkAdmin	Can be set in Remote UI	Device Information Delivery Available	Import All Function	Name of Item When Exporting with the Remote UI
<Use AirPrint>	<On>, <Off>	No	Yes	Yes	Yes	C	Settings/Registration Basic Information

<Display Errors for AirPrint>

 (Settings/Registration) ▶ <Preferences> ▶ <Network>

Specify whether to display an error screen on the control panel if printing cannot be performed as expected due to a problem with the print data when printing with AirPrint.

- If this is set to <On>, an error screen is displayed on the control panel. Cancel the job after checking the error screen.

- If this is set to <Off>, an error screen is not displayed on the control panel but the job remains in the job history with <NG> indicated.

Item	Setting Description	DeviceAdmin	NetworkAdmin	Can be set in Remote UI	Device Information Delivery Available	Import All Function	Name of Item When Exporting with the Remote UI
<Display Errors for AirPrint>	<On>, <Off>	No	Yes	Yes	No	C	Settings/Registration Basic Information

<Use IPP Everywhere>

 (Settings/Registration) ▶ <Preferences> ▶ <Network>

Specify whether to print directly from an IPP Everywhere-compatible Linux machine or Chromebook. [▶ Utilizing the Machine through Applications\(P. 770\)](#)

Item	Setting Description	DeviceAdmin	NetworkAdmin	Can be set in Remote UI	Device Information Delivery Available	Import All Function	Name of Item When Exporting with the Remote UI
<Use IPP Everywhere>	<On>, <Off>	No	Yes	Yes	No	C	Settings/Registration Basic Information

<Settings for Universal Print>

 (Settings/Registration) ▶ <Preferences> ▶ <Network>

Specify the settings for Universal Print. [▶ Printing Using the Microsoft Cloud Service \(Universal Print\)\(P. 627\)](#)

Item	Setting Description	DeviceAdmin	NetworkAdmin	Can be set in Remote UI	Device Information Delivery Available	Import All Function	Name of Item When Exporting with the Remote UI
<Basic Settings>	<Use Universal Print>:On, Off	No	Yes	Yes	No	C	Settings/Registration Basic Information
	<Verify Server Certificate>:On, Off	No	Yes	Yes	No	C	Settings/Registration Basic Information
	<Add CN to Verification Items>:On, Off	No	Yes	Yes	No	C	Settings/Registration Basic Information
	<Printer Name>: OIP_PRINTER	No	Yes	Yes	No	A	Settings/Registration Basic Information

Item	Setting Description	DeviceAdmin	NetworkAdmin	Can be set in Remote UI	Device Information Delivery Available	Import All Function	Name of Item When Exporting with the Remote UI
	<Application ID>: f9fc375c-c7ba-4e5c-b213-23affd792cc1	No	Yes	Yes	No	C	Settings/Registration Basic Information
	<Azure Active Directory Authentication URL>: https://login.microsoftonline.com/organizations/oauth2/v2.0	No	Yes	Yes	No	C	Settings/Registration Basic Information
	<Azure Active Directory Registration URL>: https://register.print.microsoft.com/api/v1.0/register	No	Yes	Yes	No	C	Settings/Registration Basic Information
<Registration Status>	<Not Registered> <Registered> <Checking...>	No	Yes	Yes	No	No	-

<Device Position Information Settings>

 (Settings/Registration) ▶ <Preferences> ▶ <Network>

Specify the device position information settings.  **Using AirPrint(P. 773)**

Item	Setting Description	DeviceAdmin	NetworkAdmin	Can be set in Remote UI	Device Information Delivery Available	Import All Function	Name of Item When Exporting with the Remote UI
<Device Position Information Settings>	<Latitude>: Specify the latitude.	No	Yes	Yes	No	No	-
	<Longitude>: Specify the longitude.	No	Yes	Yes	No	No	-

<Select Interface>

 (Settings/Registration) ▶ <Preferences> ▶ <Network>

Select whether to use a wired LAN or wireless LAN by itself, a wired LAN and wireless LAN simultaneously, or a wired LAN and another wired LAN simultaneously.  **Selecting the Network Connection Method(P. 267)**

Item	Setting Description	DeviceAdmin	NetworkAdmin	Can be set in Remote UI	Device Information Delivery Available	Import All Function	Name of Item When Exporting with the Remote UI
<Select Interface>	<Wired LAN>, <Wireless LAN>*1, <Wired LAN + Wired LAN>, <Wired LAN + Wireless LAN>*1	No	Yes	Yes	No	C	Settings/Registration Basic Information

*1 Only appears if your machine has a Wireless LAN.

NOTE

- If you set this to <Wireless LAN> or <Wired LAN + Wireless LAN>, <Sleep Mode Energy Use> must be manually set to <High>.  <Sleep Mode Energy Use>(P. 1077)

<Wireless LAN> *

 (Settings/Registration) ▶ <Preferences> ▶ <Network>

Specify the wireless LAN settings.

 <Wireless LAN>(P. 1127)

<Direct Connection Settings> *

 (Settings/Registration) ▶ <Preferences> ▶ <Network>

Specify the direct connection settings.

 <Direct Connection Settings>(P. 1129)

<Sub Line Settings>

 (Settings/Registration) ▶ <Preferences> ▶ <Network>

Specify the sub-line settings (wireless LAN or a separate wired LAN) when a wired LAN and a wireless LAN, or a wired LAN and another wired LAN, are both used at the same time.

 <Sub Line Settings>(P. 1134)

<Static Routing Settings>

 (Settings/Registration) ▶ <Preferences> ▶ <Network>

Specify the static routing settings for IPv4 addresses.  <Setting Static Routing>(P. 307)

Settings/Registration

Item	Setting Description	DeviceAdmin	NetworkAdmin	Can be set in Remote UI	Device Information Delivery Available	Import All Function	Name of Item When Exporting with the Remote UI
<Static Routing Settings>	<Use Static Routing>: <On>, <Off>	No	Yes	No	No	C	Settings/Registration Basic Information
	<Edit>, <Delete>	No	Yes	No	No	No	-
	<ul style="list-style-type: none"> <Edit> <Address>(<0.0.0.0>), <Prefix Length>(1 to 32), <Gateway Address>(<0.0.0.0>)	No	Yes	No	No	C	Settings/Registration Basic Information

<TCP/IP Settings>

Specify the settings that enable the machine to be used on a TCP/IP network.

- ▶ <IPv4 Settings>(P. 1092)
- ▶ <IPv6 Settings>(P. 1092)
- ▶ <mDNS Settings>(P. 1116)
- ▶ <Computer Name/Workgroup Name Settings>(P. 1093)
- ▶ <SMB Server Settings>(P. 1093)
- ▶ <Specify SMB Server Version>(P. 1094)
- ▶ <SMB Client Settings>(P. 1094)
- ▶ <Specify SMB Client Version>(P. 1095)
- ▶ <WINS Settings>(P. 1095)
- ▶ <LPD Print Settings>(P. 1096)
- ▶ <RAW Print Settings>(P. 1096)
- ▶ <SNTP Settings>(P. 1097)
- ▶ <FTP Print Settings>(P. 1097)
- ▶ <Use UTF-8 to Display Name of FTP Print Job>(P. 1098)
- ▶ <WSD Settings>(P. 1098)
- ▶ <Use FTP PASV Mode>(P. 1099)
- ▶ <IPP Print Settings>(P. 1099)
- ▶ <Multicast Discovery Settings>(P. 1099)
- ▶ <Sleep Mode Notification Settings>(P. 1100)
- ▶ <Use HTTP>(P. 1100)
- ▶ <Use WebDAV Server>(P. 1101)
- ▶ <TLS Settings>(P. 1101)
- ▶ <Proxy Settings>(P. 1103)
- ▶ <Confirm Auth. Info. When in Auth. Management Mode>(P. 1104)
- ▶ <IPSec Settings>(P. 1104)
- ▶ <SIP Settings>(P. 1108)
- ▶ <TCP/IP Option Settings>(P. 1108)
- ▶ <Use Network Link Scan>(P. 1109)

NOTE

- For information on the items ("A", "B", "C", and "No") in the "Import All Function" column, see ▶ **Import All Function(P. 1054)** .

<IPv4 Settings>

 (Settings/Registration) ▶ <Preferences> ▶ <Network> ▶ <TCP/IP Settings>

Specify the settings that enable you to use the machine in an IPv4 environment.

- ▶ <IPv4 Settings>(P. 1110)

<IPv6 Settings>

 (Settings/Registration) ▶ <Preferences> ▶ <Network> ▶ <TCP/IP Settings>

Specify the settings that enable you to use the machine in an IPv6 environment.

- ▶ <IPv6 Settings>(P. 1112)

<DNS Settings>

 (Settings/Registration) ▶ <Preferences> ▶ <Network> ▶ <TCP/IP Settings>

Specify the Domain Name System (DNS) settings for converting host names (domain names) to IP addresses.

- ▶ <DNS Settings>(P. 1115)

<Computer Name/Workgroup Name Settings>

 (Settings/Registration) ▶ <Preferences> ▶ <Network> ▶ <TCP/IP Settings>

Specify the name of the machine on the network and the name of the workgroup it belongs to. If your environment does not have workgroups, create a workgroup in Windows and enter the name of that workgroup.

Item	Setting Description	DeviceAdmin	NetworkAdmin	Can be set in Remote UI	Device Information Delivery Available	Import All Function	Name of Item When Exporting with the Remote UI
<Computer Name/Workgroup Name Settings>	<Computer Name> (15 characters maximum): Canon***** ("*****" represents the last six digits of a MAC address.)	No	Yes	Yes	No	A	Settings/ Registration Basic Information
	<Workgroup Name> (15 characters maximum): WORKGROUP	No	Yes	Yes	No	A	Settings/ Registration Basic Information
	<Comment> (48 characters maximum)	No	Yes	Yes	No	A	Settings/ Registration Basic Information
	<Use NetBIOS>: <On>, <Off>	No	Yes	Yes	No	A	Settings/ Registration Basic Information

IMPORTANT

- If you set <Use NetBIOS> to <Off>, <WINS Settings> is disabled. Make sure to set <Use NetBIOS> to <On> when using WINS.

<SMB Server Settings>

 (Settings/Registration) ▶ <Preferences> ▶ <Network> ▶ <TCP/IP Settings>

Specify the SMB server settings to open the Advanced Space to the public in a network.  **Setting the SMB Server(P. 294)**

Item	Setting Description	DeviceAdmin	NetworkAdmin	Can be set in Remote UI	Device Information Delivery Available	Import All Function	Name of Item When Exporting with the Remote UI
<SMB Server Settings>	<Use SMB Server>: <On>, <Off>	No	Yes	Yes	No	C	Settings/ Registration Basic Information
	<Use SMB Authentication>: <On>, <Off>	No	Yes	Yes	No	C	Settings/ Registration Basic Information

Item	Setting Description	DeviceAdmin	NetworkAdmin	Can be set in Remote UI	Device Information Delivery Available	Import All Function	Name of Item When Exporting with the Remote UI
	<Authentication Type>: <NTLMv1>, <NTLMv2>	No	Yes	Yes	No	C	Settings/Registration Basic Information
	<Require SMB Signature for Connection>: <On>, <Off>	No	Yes	Yes	No	C	Settings/Registration Basic Information
	<Require Encryption for Connection>: <On>, <Off>	No	Yes	Yes	No	C	Settings/Registration Basic Information

<Specify SMB Server Version>

 (Settings/Registration) ► <Preferences> ► <Network> ► <TCP/IP Settings>

Specify the version of SMB to use with the SMB server.  **Setting the SMB Server(P. 294)**

Item	Setting Description	DeviceAdmin	NetworkAdmin	Can be set in Remote UI	Device Information Delivery Available	Import All Function	Name of Item When Exporting with the Remote UI
<Specify SMB Server Version>	<1.0>: <On>, <Off>	Yes	Yes	Yes	No	C	Settings/Registration Basic Information
	<2.0>: <On>, <Off>	Yes	Yes	Yes	No	C	Settings/Registration Basic Information
	<3.0>: <On>, <Off>	Yes	Yes	Yes	No	C	Settings/Registration Basic Information
	<3.1>: <On>, <Off>	Yes	Yes	Yes	No	C	Settings/Registration Basic Information

IMPORTANT

- Use the same version of SMB with the SMB server and SMB client. SMB cannot be used if the versions differ.

<SMB Client Settings>

 (Settings/Registration) ► <Preferences> ► <Network> ► <TCP/IP Settings>

Specify the settings to use when the machine connects to a network as an SMB client.  **Setting the SMB Client(P. 295)**

Item	Setting Description	DeviceAdmin	NetworkAdmin	Can be set in Remote UI	Device Information Delivery Available	Import All Function	Name of Item When Exporting with the Remote UI
<SMB Client Settings>	<Authentication Type>: <NTLMv1>, <NTLMv2>	No	Yes	Yes	No	C	Settings/Registration Basic Information
	<Require SMB Signature for Connection>: <On>, <Off>	No	Yes	Yes	No	C	Settings/Registration Basic Information
	<Require Encryption for Connection>: <On>, <Off>	No	Yes	Yes	No	C	Settings/Registration Basic Information
	<Timeout>: 3 to 30 to 300 sec.	No	Yes	Yes	No	C	Settings/Registration Basic Information

<Specify SMB Client Version>

 (Settings/Registration) ▶ <Preferences> ▶ <Network> ▶ <TCP/IP Settings>

Specify the version of SMB to use with the SMB client.  **Setting the SMB Client(P. 295)**

Item	Setting Description	DeviceAdmin	NetworkAdmin	Can be set in Remote UI	Device Information Delivery Available	Import All Function	Name of Item When Exporting with the Remote UI
<Specify SMB Client Version>	<1.0>: <On>, <Off>	Yes	Yes	Yes	No	C	Settings/Registration Basic Information
	<2.0>: <On>, <Off>	Yes	Yes	Yes	No	C	Settings/Registration Basic Information
	<3.0>: <On>, <Off>	Yes	Yes	Yes	No	C	Settings/Registration Basic Information
	<3.1>: <On>, <Off>	Yes	Yes	Yes	No	C	Settings/Registration Basic Information

IMPORTANT

- Use the same version of SMB with the SMB server and SMB client. SMB cannot be used if the versions differ.

<WINS Settings>

 (Settings/Registration) ▶ <Preferences> ▶ <Network> ▶ <TCP/IP Settings>

Specify settings for Windows Internet Name Service (WINS).  **Making WINS Settings(P. 297)**

Item	Setting Description	DeviceAdmin	NetworkAdmin	Can be set in Remote UI	Device Information Delivery Available	Import All Function	Name of Item When Exporting with the Remote UI
<WINS Settings>	<WINS Resolution>: <On>, <Off>	No	Yes	Yes	No	C	Settings/Registration Basic Information
	<WINS Server Address> (IP Address)	No	Yes	Yes	No	C	Settings/Registration Basic Information

IMPORTANT

- If you set <Use NetBIOS> to <Off> in <Computer Name/Workgroup Name Settings>, this setting is disabled.

<LPD Print Settings>

 (Settings/Registration) ▶ <Preferences> ▶ <Network> ▶ <TCP/IP Settings>

Specify settings for LPD printing. To use LPD printing, press <On> and set the time until the job is automatically canceled when the print data cannot be received due to a communication error, etc.

Item	Setting Description	DeviceAdmin	NetworkAdmin	Can be set in Remote UI	Device Information Delivery Available	Import All Function	Name of Item When Exporting with the Remote UI
<LPD Print Settings>	<On>, <Off>	No	Yes	Yes	Yes	C	Settings/Registration Basic Information
	<LPD Banner Page>: <On>, <Off>	No	Yes	Yes	Yes	C	Settings/Registration Basic Information
	<RX Timeout>: 1 to 5 to 60 (min.)	No	Yes	Yes	Yes	C	Settings/Registration Basic Information

NOTE

- Banner pages can only be output if the PCL Printer function or PS Printer function is installed.  **System Options(P. 1597)**
- Banner pages are set to be output by print job. Even if <LPD Banner Page> is set to <On>, banner pages are not output for print jobs that are set to not output a banner page.

<RAW Print Settings>

 (Settings/Registration) ▶ <Preferences> ▶ <Network> ▶ <TCP/IP Settings>

Specify settings for RAW printing. To use RAW printing, press <On> and set whether to use bidirectional communication and the time until the job is automatically canceled when the print data cannot be received due to a communication error, etc.

Item	Setting Description	DeviceAdmin	NetworkAdmin	Can be set in Remote UI	Device Information Delivery Available	Import All Function	Name of Item When Exporting with the Remote UI
<RAW Print Settings>	<On>, <Off>	No	Yes	Yes	Yes	C	Settings/Registration Basic Information
	<Bidirectional Communication>: <On>, <Off>	No	Yes	Yes	Yes	C	Settings/Registration Basic Information
	<RX Timeout>: 1 to 5 to 60 (min.)	No	Yes	Yes	Yes	C	Settings/Registration Basic Information

<SNTP Settings>

 (Settings/Registration) ▶ <Preferences> ▶ <Network> ▶ <TCP/IP Settings>

Specify settings for Simple Network Time Protocol (SNTP).  **Making SNTP Settings(P. 309)**

Item	Setting Description	DeviceAdmin	NetworkAdmin	Can be set in Remote UI	Device Information Delivery Available	Import All Function	Name of Item When Exporting with the Remote UI
<SNTP Settings>	<Use SNTP>: <On>, <Off>	No	Yes	Yes	No	C	Settings/Registration Basic Information
	<Polling Interval>: 10 to 1440 to 2880 min.	No	Yes	Yes	No	C	Settings/Registration Basic Information
	<NTP Server Address> (IP Address or Host Name)	No	Yes	Yes	No	C	Settings/Registration Basic Information
	<Check NTP Server>	No	Yes	Yes	No	No	-

<FTP Print Settings>

 (Settings/Registration) ▶ <Preferences> ▶ <Network> ▶ <TCP/IP Settings>

Specify settings for FTP printing. To use FTP printing, press <On>, and set <User Name> and <Password> as necessary.

Item	Setting Description	DeviceAdmin	NetworkAdmin	Can be set in Remote UI	Device Information Delivery Available	Import All Function	Name of Item When Exporting with the Remote UI
<FTP Print Settings>	<Use FTP Printing>: <On>, <Off>	No	Yes	Yes	Yes	C	Settings/Registration Basic Information
	<User Name>: guest	No	Yes	Yes	No	C	Settings/Registration Basic Information

Item	Setting Description	DeviceAdmin	NetworkAdmin	Can be set in Remote UI	Device Information Delivery Available	Import All Function	Name of Item When Exporting with the Remote UI
	<Password>: 7654321	No	Yes	Yes	No	C	Settings/Registration Basic Information

<Use UTF-8 to Display Name of FTP Print Job>

 (Settings/Registration) ▶ <Preferences> ▶ <Network> ▶ <TCP/IP Settings>

Specify whether to use UTF-8 for displaying file names when you perform FTP print.

Item	Setting Description	DeviceAdmin	NetworkAdmin	Can be set in Remote UI	Device Information Delivery Available	Import All Function	Name of Item When Exporting with the Remote UI
<Use UTF-8 to Display Name of FTP Print Job>	<On>, <Off>	No	Yes	Yes	Yes	C	Settings/Registration Basic Information

<WSD Settings>

 (Settings/Registration) ▶ <Preferences> ▶ <Network> ▶ <TCP/IP Settings>

Specify the WSD settings.

- To use WSD (Web Service on Devices) for the print application, set <Use WSD> to <On>.
- To use WSD to retrieve the information for the machine, set <Use WSD Browsing> to <On>.
- To use the WSD Scan function, set <Use WSD Scan> to <On>.  **Using WSD(P. 702)**

Item	Setting Description	DeviceAdmin	NetworkAdmin	Can be set in Remote UI	Device Information Delivery Available	Import All Function	Name of Item When Exporting with the Remote UI
<WSD Settings>	<Use WSD>: <On>, <Off>	No	Yes	Yes	Yes	C	Settings/Registration Basic Information
	<Use WSD Browsing>: <On>, <Off>	No	Yes	Yes	Yes	C	Settings/Registration Basic Information
	<Use WSD Scan>: <On>, <Off>	No	Yes	Yes	Yes	C	Settings/Registration Basic Information

NOTE

- If you set <Use WSD> to <On>, <Use WSD Browsing> and <Use HTTP> are also set to <On>.
- If you set <Use WSD Scan> to <On>, <Use HTTP> is also set to <On>.

<Use FTP PASV Mode>

 (Settings/Registration) ▶ <Preferences> ▶ <Network> ▶ <TCP/IP Settings>

Specify whether to use the FTP PASV mode.  **Setting the PASV Mode of FTP(P. 309)**

Item	Setting Description	DeviceAdmin	NetworkAdmin	Can be set in Remote UI	Device Information Delivery Available	Import All Function	Name of Item When Exporting with the Remote UI
<Use FTP PASV Mode>	<On>, <Off>	No	Yes	Yes	Yes	C	Settings/Registration Basic Information



<IPP Print Settings>

 (Settings/Registration) ▶ <Preferences> ▶ <Network> ▶ <TCP/IP Settings>

Specify settings for IPP printing. To use IPP printing, press <On> and set whether to only allow communication data encrypted with TLS (IPP printing) and whether to use IPP authentication.

Item	Setting Description	DeviceAdmin	NetworkAdmin	Can be set in Remote UI	Device Information Delivery Available	Import All Function	Name of Item When Exporting with the Remote UI
<IPP Print Settings>	<On>, <Off>	No	Yes	Yes	Yes	C	Settings/Registration Basic Information
	<Allow When Using TLS>: <On>, <Off>	No	Yes	Yes	No	C	Settings/Registration Basic Information
	<Use Authentication>: <On>, <Off>	No	Yes	Yes	No	C	Settings/Registration Basic Information

NOTE

- If you set this to <On>, <Use HTTP> is also set to <On>.
- To perform IPPS printing, a key pair to use is required. You can use a preinstalled key pair or an original key pair generated by the machine as the key to use. For information on the key to use and the method for generating an original key pair, see  **Generating the Key and Certificate for Network Communication(P. 867)** or  **Registering a Key and Certificate for Network Communication(P. 920)** . If you select <RSA> for <Key Algorithm> when generating the key to use for network communication, set a key length of <1024> or longer. IPPS printing may not be able to be performed correctly if a key length of <512> is set, depending on the operating system you are using.
- To use the IPP authentication function by setting <Use Authentication> to <On>, the user information of the machine is used as the user and password for IPP authentication. Make sure to register the user information in advance when using the IPP authentication function.  **Registering User Information in the Local Device(P. 809)**

<Multicast Discovery Settings>

 (Settings/Registration) ▶ <Preferences> ▶ <Network> ▶ <TCP/IP Settings>

Specify the multicast discovery settings. Monitoring the Machine From Device Management Systems(P. 310)

Item	Setting Description	DeviceAdmin	NetworkAdmin	Can be set in Remote UI	Device Information Delivery Available	Import All Function	Name of Item When Exporting with the Remote UI
<Multicast Discovery Settings>	<Response>: <On>, <Off>	No	Yes	Yes	Yes	C	Settings/Registration Basic Information
	<Scope Name>	No	Yes	Yes	No	C	Settings/Registration Basic Information

<Sleep Mode Notification Settings>

(Settings/Registration) ▶ <Preferences> ▶ <Network> ▶ <TCP/IP Settings>

Specify settings for multicast sending of the Sleep mode notifications on the network.

Item	Setting Description	DeviceAdmin	NetworkAdmin	Can be set in Remote UI	Device Information Delivery Available	Import All Function	Name of Item When Exporting with the Remote UI
<Sleep Mode Notification Settings>	<Notify>: <On>, <Off>	No	Yes	Yes	Yes	C	Settings/Registration Basic Information
	<Port Number>: 1 to 11427 to 65535	No	Yes	Yes	Yes	C	Settings/Registration Basic Information
	<Number of Routers to Traverse>: 0 to 3 to 254	No	Yes	Yes	Yes	C	Settings/Registration Basic Information
	<Notification Interval>: 60 to 600 to 65535 sec.	No	Yes	Yes	Yes	C	Settings/Registration Basic Information

NOTE

- This setting can only be specified from the Remote UI.

<Use HTTP>

(Settings/Registration) ▶ <Preferences> ▶ <Network> ▶ <TCP/IP Settings>

Enable or disable HTTP setting.

Item	Setting Description	DeviceAdmin	NetworkAdmin	Can be set in Remote UI	Device Information Delivery Available	Import All Function	Name of Item When Exporting with the Remote UI
<Use HTTP>	<On>, <Off>	No	Yes	Yes	Yes	C	Settings/Registration Basic Information

IMPORTANT

- By specifying this setting as <On>, you can open a necessary port. However, it is recommended that you specify it as <Off>, if a port is not used. If you leave the port open, an unauthorized user may access the machine.

NOTE

If you set this to <Off>, the following settings are also set to <Off>.

- <Remote UI>
- <IPP Print Settings>
- <Use WSD Scan> and <Use WSD> in <WSD Settings>
- <Use WebDAV Server>

<Use WebDAV Server>

 (Settings/Registration) ▶ <Preferences> ▶ <Network> ▶ <TCP/IP Settings>

Specify whether to use the WebDAV server.  [Making WebDAV Settings\(P. 298\)](#)

Item	Setting Description	DeviceAdmin	NetworkAdmin	Can be set in Remote UI	Device Information Delivery Available	Import All Function	Name of Item When Exporting with the Remote UI
<Use WebDAV Server>	<On>, <Off>	No	Yes	Yes	Yes	C	Settings/Registration Basic Information

NOTE

- If you set this to <On>, <Use HTTP> is also set to <On>.

<TLS Settings>

 (Settings/Registration) ▶ <Preferences> ▶ <Network> ▶ <TCP/IP Settings>

You can set a key pair, TLS version, and encryption algorithm to use after confirming that a machine uses TLS encrypted communication.  [Configuring the Key and Certificate for TLS\(P. 864\)](#)

Item	Setting Description	DeviceAdmin	NetworkAdmin	Can be set in Remote UI	Device Information Delivery Available	Import All Function	Name of Item When Exporting with the Remote UI
<Key and Certificate>	<Set as Default Key>: <Yes>, <No>	No	Yes	Yes	No	No	-

Settings/Registration

Item	Setting Description	DeviceAdmin	NetworkAdmin	Can be set in Remote UI	Device Information Delivery Available	Import All Function	Name of Item When Exporting with the Remote UI
	<Certificate Details> (<Version>, <Serial Number>, <Signature Algorithm>, <Issued To>, <Validity Start Date>, <Validity End Date>, <Issuer>, <Public Key>, <Certificate Thumbprint>, <Issued To (Altn. Name)>, <Verify Certificate>)	No	Yes	Yes	No	No	-
	<Display Use Location> (Displays what the key pair is being used for)	No	Yes	Yes	No	No	-
<Specify Allowed Versions>	<Maximum Version>: <TLS 1.0>, <TLS 1.1>, <TLS 1.2>, <TLS 1.3>	No	Yes	Yes	No	C	Settings/ Registration Basic Information
	<Minimum Version>: <TLS 1.0>, <TLS 1.1>, <TLS 1.2>, <TLS 1.3>	No	Yes	Yes	No	C	Settings/ Registration Basic Information
<Encryption Algorithm Settings>	<AES-CBC (256-bit)>: <On>, <Off>	No	Yes	Yes	No	C	Settings/ Registration Basic Information
	<AES-GCM (256-bit)>: <On>, <Off>	No	Yes	Yes	No	C	Settings/ Registration Basic Information
	<3DES-CBC>: <On>, <Off>	No	Yes	Yes	No	C	Settings/ Registration Basic Information
	<AES-CBC (128-bit)>: <On>, <Off>	No	Yes	Yes	No	C	Settings/ Registration Basic Information
	<AES-GCM (128-bit)>: <On>, <Off>	No	Yes	Yes	No	C	Settings/ Registration Basic Information
	<CHACHA20-POLY1305>: <On>, <Off>	No	Yes	Yes	No	C	Settings/ Registration Basic Information
<Key Exchange Algorithm Settings>	<RSA>: <On>, <Off>	No	Yes	Yes	No	C	Settings/ Registration Basic Information
	<ECDHE>: <On>, <Off>	No	Yes	Yes	No	C	Settings/ Registration Basic Information
	<X25519>: <On>, <Off>	No	Yes	Yes	No	C	Settings/ Registration Basic Information

Item	Setting Description	DeviceAdmin	NetworkAdmin	Can be set in Remote UI	Device Information Delivery Available	Import All Function	Name of Item When Exporting with the Remote UI
<Signature Algorithm Settings>	<RSA>: <On>, <Off>	No	Yes	Yes	No	C	Settings/ Registration Basic Information
	<ECDSA>: <On>, <Off>	No	Yes	Yes	No	C	Settings/ Registration Basic Information
<HMAC Algorithm Settings>	<SHA1>: <On>, <Off>	No	Yes	Yes	No	C	Settings/ Registration Basic Information
	<SHA256>: <On>, <Off>	No	Yes	Yes	No	C	Settings/ Registration Basic Information
	<SHA384>: <On>, <Off>	No	Yes	Yes	No	C	Settings/ Registration Basic Information

<Proxy Settings>

 (Settings/Registration) ▶ <Preferences> ▶ <Network> ▶ <TCP/IP Settings>

Specify settings for the proxy.  **Setting a Proxy(P. 862)**

Item	Setting Description	DeviceAdmin	NetworkAdmin	Can be set in Remote UI	Device Information Delivery Available	Import All Function	Name of Item When Exporting with the Remote UI
<Proxy Settings>	<Use Proxy>: <On>, <Off>	No	Yes	Yes	No	C	Settings/ Registration Basic Information
	<Server Address> (IP Address or FQDN)	No	Yes	Yes	No	C	Settings/ Registration Basic Information
	<Port Number>: 1 to 80 to 65535	No	Yes	Yes	No	C	Settings/ Registration Basic Information
	<Use Proxy within Same Domain>: <On>, <Off>	No	Yes	Yes	No	C	Settings/ Registration Basic Information
<Set Authentication>	<Use Proxy Authentication>: <On>, <Off>	No	Yes	Yes	No	C	Settings/ Registration Basic Information
	<User Name> (24 characters maximum)	No	Yes	Yes	No	C	Settings/ Registration Basic Information

Item	Setting Description	DeviceAdmin	NetworkAdmin	Can be set in Remote UI	Device Information Delivery Available	Import All Function	Name of Item When Exporting with the Remote UI
	<Password> (24 characters maximum)	No	Yes	Yes	No	C	Settings/Registration Basic Information

<Confirm Auth. Info. When in Auth. Management Mode>

 (Settings/Registration) ▶ <Preferences> ▶ <Network> ▶ <TCP/IP Settings>

Specify whether the machine checks authentication information when you print using the V4 printer driver.

Item	Setting Description	DeviceAdmin	NetworkAdmin	Can be set in Remote UI	Device Information Delivery Available	Import All Function	Name of Item When Exporting with the Remote UI
<Confirm Auth. Info. When in Auth. Management Mode>	<On>, <Off>	No	Yes	Yes	No	C	Settings/Registration Basic Information

NOTE

- If there is no key to use for TLS communication or it is corrupted, this setting is disabled.  [Configuring the Key and Certificate for TLS\(P. 864\)](#)

<IPSec Settings>

 (Settings/Registration) ▶ <Preferences> ▶ <Network> ▶ <TCP/IP Settings>

Specify the IPSec settings.  [Configuring the IPSec Settings\(P. 869\)](#)

Item	Setting Description	DeviceAdmin	NetworkAdmin	Can be set in Remote UI	Device Information Delivery Available	Import All Function	Name of Item When Exporting with the Remote UI
<Use IPSec>	<On>, <Off>	No	Yes	Yes	No	C	Settings/Registration Basic Information
<Receive Non-Policy Packets>	<Allow>, <Reject>	No	Yes	Yes	No	C	Settings/Registration Basic Information
<Policy On/Off>	<On>, <Off>	No	Yes	Yes	No	C	Settings/Registration Basic Information

Settings/Registration

Item	Setting Description	DeviceAdmin	NetworkAdmin	Can be set in Remote UI	Device Information Delivery Available	Import All Function	Name of Item When Exporting with the Remote UI
<Register>	<Policy Name> (24 characters maximum)	No	Yes	Yes	No	C	Settings/Registration Basic Information
<Selector Settings>	<Local Address> (<All IP Addresses>, <IPv4 Address>, <IPv6 Address>, <IPv4 Manual Settings>, <IPv6 Manual Settings>)	No	Yes	Yes	No	C	Settings/Registration Basic Information
	<ul style="list-style-type: none"> <IPv4 Manual Settings> (<Single Address>, <Address Range>(<First Address>, <Last Address>), <Subnet Settings>(<Address>, <Subnet Mask>)) 	No	Yes	Yes	No	C	Settings/Registration Basic Information
	<ul style="list-style-type: none"> <IPv6 Manual Settings> (<Single Address>(<Address>), <Address Range> (<First Address>, <Last Address>), <Specify Prefix> (<Address>, <Prefix Length>)) 	No	Yes	Yes	No	C	Settings/Registration Basic Information
	<ul style="list-style-type: none"> <Prefix Length> (1 to 64 to 128) 	No	Yes	Yes	No	C	Settings/Registration Basic Information
	<Remote Address>(<All IP Addresses>, <All IPv4 Addresses>, <All IPv6 Addresses>, <IPv4 Manual Settings>, <IPv6 Manual Settings>)	No	Yes	Yes	No	C	Settings/Registration Basic Information
	<ul style="list-style-type: none"> <IPv4 Manual Settings>(<Single Address>, <Address Range>(<First Address>, <Last Address>), <Subnet Settings>(<Address>, <Subnet Mask>)) 	No	Yes	Yes	No	C	Settings/Registration Basic Information
	<ul style="list-style-type: none"> <IPv6 Manual Settings> (<Single Address>(<Address>), <Address Range> (<First Address>, <Last Address>), <Specify Prefix> (<Address>, <Prefix Length>)) 	No	Yes	Yes	No	C	Settings/Registration Basic Information
	<ul style="list-style-type: none"> <Prefix Length> (1 to 64 to 128) 	No	Yes	Yes	No	C	Settings/Registration

Settings/Registration

Item	Setting Description	DeviceAdmin	NetworkAdmin	Can be set in Remote UI	Device Information Delivery Available	Import All Function	Name of Item When Exporting with the Remote UI
							Basic Information
	<Port> (<Specify by Port Number>, <Specify by Service Name>)	No	Yes	Yes	No	C	Settings/Registration Basic Information
	<ul style="list-style-type: none"> <Specify by Port Number>(<Local Port>(<All Ports>, <Single Port>), <Remote Port>(<All Ports>, <Single Port>)) 	No	Yes	Yes	No	C	Settings/Registration Basic Information
	<ul style="list-style-type: none"> <Single Port> (1 to 65535) 	No	Yes	Yes	No	C	Settings/Registration Basic Information
	<ul style="list-style-type: none"> <Specify by Service Name> <Service On/Off>: <On>, <Off> 	No	Yes	Yes	No	C	Settings/Registration Basic Information
<IKE Settings>	<IKE Mode>: <Main>, <Aggressive>	No	Yes	Yes	No	C	Settings/Registration Basic Information
	<Validity>: 1 to 480 to 65535 min.	No	Yes	Yes	No	C	Settings/Registration Basic Information
	<Authentication Method>: <Pre-Shared Key Method> (<Shared Key>), <Digital Sig. Method> (<Key and Certificate>)	No	Yes	Yes	No	C	Settings/Registration Basic Information
	<ul style="list-style-type: none"> <Key and Certificate>: <Set as Default Key> 	No	Yes	Yes	No	C	Settings/Registration Basic Information
	<ul style="list-style-type: none"> <Key and Certificate>: <Certificate Details>(<Version>, <Serial Number>, <Signature Algorithm>, <Issued To>, <Validity Start Date>, <Validity End Date>, <Issuer>, <Public Key>, <Certificate Thumbprint>, <Issued To (Altn. Name)>, <Verify Certificate>) 	No	Yes	Yes	No	C	Settings/Registration Basic Information
	<ul style="list-style-type: none"> <Key and Certificate>: <Display Use> 	No	Yes	Yes	No	C	Settings/Registration

Settings/Registration

Item	Setting Description	DeviceAdmin	NetworkAdmin	Can be set in Remote UI	Device Information Delivery Available	Import All Function	Name of Item When Exporting with the Remote UI
	Location>(Displays what the key pair is being used for)						Basic Information
	<Authentication/Encryption Algorithm> (<Auto>, <Manual Settings>)	No	Yes	Yes	No	C	Settings/Registration Basic Information
	<Authentication/Encryption Algorithm>: <Manual Settings> <ul style="list-style-type: none"> <Authentication> <ul style="list-style-type: none"> <SHA1>: <On>, <Off> <SHA2>: <On>, <Off> 	No	Yes	Yes	No	C	Settings/Registration Basic Information
	<ul style="list-style-type: none"> <Encryption> <ul style="list-style-type: none"> <3DES-CBC>: <On>, <Off> <AES-CBC>: <On>, <Off> 	No	Yes	Yes	No	C	Settings/Registration Basic Information
	<ul style="list-style-type: none"> <DH Group> <ul style="list-style-type: none"> <Group 14 (2048)>: <On>, <Off> <ECDH-P256>: <On>, <Off> <ECDH-P384>: <On>, <Off> 	No	Yes	Yes	No	C	Settings/Registration Basic Information
<IPSec Network Settings>	<Validity> <ul style="list-style-type: none"> <Time>: <On>, <Off> 	No	Yes	Yes	No	C	Settings/Registration Basic Information
	<ul style="list-style-type: none"> <On>: (1 to 480 to 65535 min.) 	No	Yes	Yes	No	C	Settings/Registration Basic Information
	<Validity> <ul style="list-style-type: none"> <Size>: <On>, <Off> 	No	Yes	Yes	No	C	Settings/Registration Basic Information
	<ul style="list-style-type: none"> <On>: (0 to 1 to 65535 MB) 	No	Yes	Yes	No	C	Settings/Registration Basic Information
	<PFS>: <On>, <Off>	No	Yes	Yes	No	C	Settings/Registration Basic Information
	<Authentication/Encryption Algorithm>: <Auto>, <Manual Settings>	No	Yes	Yes	No	C	Settings/Registration Basic Information

Settings/Registration

Item	Setting Description	DeviceAdmin	NetworkAdmin	Can be set in Remote UI	Device Information Delivery Available	Import All Function	Name of Item When Exporting with the Remote UI
	<Authentication/Encryption Algorithm>: <Manual Settings> (<ESP>, <ESP (AES-GCM)>, <AH (SHA1)>)	No	Yes	Yes	No	C	Settings/Registration Basic Information
	<ESP> Settings: <ul style="list-style-type: none"> • <ESP Authentication> <SHA1>: <On>, <Off> <NULL>: <On>, <Off> 	No	Yes	Yes	No	C	Settings/Registration Basic Information
	<ul style="list-style-type: none"> • <ESP Encryption> <3DES-CBC>: <On>, <Off> <AES-CBC>: <On>, <Off> <NULL>: <On>, <Off> 	No	Yes	Yes	No	C	Settings/Registration Basic Information
	<ESP (AES-GCM)> Settings: None	No	Yes	Yes	No	C	Settings/Registration Basic Information
	<AH (SHA1)> Settings: None	No	Yes	Yes	No	C	Settings/Registration Basic Information
	<Connection Mode>: Transport (display only)	No	Yes	Yes	No	C	Settings/Registration Basic Information
<Only Allow 256-bit for AES Key Length>	<On>, <Off>	No	Yes	Yes	No	No	-
<Edit>	-	No	Yes	Yes	No	No	-
<Delete>	-	No	Yes	Yes	No	No	-
<Print List>	<Yes>, <No>	No	Yes	Yes	No	No	-

<SIP Settings>

 (Settings/Registration) ► <Preferences> ► <Network> ► <TCP/IP Settings>

Specify the SIP settings. For information on using <SIP Settings>, see the IP FAX Expansion Kit User's Guide.

<TCP/IP Option Settings>

 (Settings/Registration) ► <Preferences> ► <Network> ► <TCP/IP Settings>

Specify the TCP option window scale and MTU size.

Item	Setting Description	DeviceAdmin	NetworkAdmin	Can be set in Remote UI	Device Information Delivery Available	Import All Function	Name of Item When Exporting with the Remote UI
<TCP/IP Option Settings>	<Use Window Scale Option>: <On>, <Off>	No	Yes	Yes	No	C	Settings/Registration Basic Information
	<MTU Size>: 600 to 1500 bytes (600-1500)	No	Yes	Yes	No	C	Settings/Registration Basic Information

NOTE

- This setting can only be specified from the Remote UI.

<Use Network Link Scan>

 (Settings/Registration) ▶ <Preferences> ▶ <Network> ▶ <TCP/IP Settings>

Specify whether to use Network Link Scan.

Item	Setting Description	DeviceAdmin	NetworkAdmin	Can be set in Remote UI	Device Information Delivery Available	Import All Function	Name of Item When Exporting with the Remote UI
<Use Network Link Scan>	<On>, <Off>	No	Yes	Yes	No	C	Settings/Registration Basic Information
	<Use TLS>: <On>, <Off>	No	Yes	Yes	No	C	Settings/Registration Basic Information

<IPv4 Settings>

Specify the settings that enable you to use the machine in an IPv4 environment.

- ▶<Use IPv4>(P. 1110)
- ▶<IP Address Settings>(P. 1110)
- ▶<DHCP Option Settings>(P. 1111)
- ▶<PING Command>(P. 1111)

NOTE

- For information on the items ("A", "B", "C", and "No") in the "Import All Function" column, see ▶<Import All Function>(P. 1054) .

<Use IPv4>

 (Settings/Registration) ▶ <Preferences> ▶ <Network> ▶ <TCP/IP Settings> ▶ <IPv4 Settings>

Set whether to use IPv4. ▶<Setting an IPv4 Address>(P. 279)

Item	Setting Description	DeviceAdmin	NetworkAdmin	Can be set in Remote UI	Device Information Delivery Available	Import All Function	Name of Item When Exporting with the Remote UI
<Use IPv4>	<On>, <Off>	No	Yes	Yes	No	C	Settings/Registration Basic Information

<IP Address Settings>

 (Settings/Registration) ▶ <Preferences> ▶ <Network> ▶ <TCP/IP Settings> ▶ <IPv4 Settings>

Specify the IPv4 address. ▶<Setting an IPv4 Address>(P. 279)

Item	Setting Description	DeviceAdmin	NetworkAdmin	Can be set in Remote UI	Device Information Delivery Available	Import All Function	Name of Item When Exporting with the Remote UI
<IP Address Settings>	<IP Address>: <0.0.0.0>	No	Yes	Yes	No	A	Settings/Registration Basic Information
	<Subnet Mask>: <0.0.0.0>	No	Yes	Yes	No	C	Settings/Registration Basic Information
	<Gateway Address>: <0.0.0.0>	No	Yes	Yes	No	C	Settings/Registration Basic Information
	<DHCP>: <On>, <Off>	No	Yes	Yes	No	C	Settings/Registration Basic Information
	<Auto IP>: <On>, <Off>	No	Yes	Yes	No	C	Settings/Registration Basic Information

<DHCP Option Settings>

 (Settings/Registration) ▶ <Preferences> ▶ <Network> ▶ <TCP/IP Settings> ▶ <IPv4 Settings>

Specify the optional settings for DHCP.  **Using a DHCP Server(P. 292)**

Item	Setting Description	DeviceAdmin	NetworkAdmin	Can be set in Remote UI	Device Information Delivery Available	Import All Function	Name of Item When Exporting with the Remote UI
<DHCP Option Settings>	<Acquire Host Name>: <On>, <Off>	No	Yes	Yes	No	C	Settings/Registration Basic Information
	<DNS Dynamic Update>: <On>, <Off>	No	Yes	Yes	No	C	Settings/Registration Basic Information
	<Acquire DNS Server Address>: <On>, <Off>	No	Yes	Yes	No	C	Settings/Registration Basic Information
	<Acquire Domain Name>: <On>, <Off>	No	Yes	Yes	No	C	Settings/Registration Basic Information
	<Acquire WINS Server Address>: <On>, <Off>	No	Yes	Yes	No	C	Settings/Registration Basic Information
	<Acquire SMTP Server Address>: <On>, <Off>	No	Yes	Yes	No	C	Settings/Registration Basic Information
	<Acquire POP Server Address>: <On>, <Off>	No	Yes	Yes	No	C	Settings/Registration Basic Information
	<Release Address Last Acquired from DHCP Server When Address Cannot Be Acquired>*1: <On>, <Off>	No	Yes	Yes	No	C	Settings/Registration Basic Information

*1 This setting can only be specified from the Remote UI.

<PING Command>

 (Settings/Registration) ▶ <Preferences> ▶ <Network> ▶ <TCP/IP Settings> ▶ <IPv4 Settings>

Tests whether the IPv4 address is set correctly.  **Conducting a Connection Test for an IPv4 Address(P. 280)**

Item	Setting Description	DeviceAdmin	NetworkAdmin	Can be set in Remote UI	Device Information Delivery Available	Import All Function	Name of Item When Exporting with the Remote UI
<PING Command>	<IPv4 Address>: <0.0.0.0>	No	Yes	No	No	No	-

<IPv6 Settings>

Specify the settings that enable you to use the machine in an IPv6 environment.

- ▶<Use IPv6>(P. 1112)
- ▶<Stateless Address Settings>(P. 1112)
- ▶<Manual Address Settings>(P. 1112)
- ▶<Use DHCPv6>(P. 1113)
- ▶<PING Command>(P. 1113)
- ▶<Only Retrieve Stateful Address Prefix>(P. 1113)
- ▶<DHCP Option Settings>(P. 1114)

NOTE

- For information on the items ("A", "B", "C", and "No") in the "Import All Function" column, see ▶<Import All Function>(P. 1054) .

<Use IPv6>

 (Settings/Registration) ▶ <Preferences> ▶ <Network> ▶ <TCP/IP Settings> ▶ <IPv6 Settings>

Specify whether to use IPv6. ▶<Setting an IPv6 Address>(P. 281)

Item	Setting Description	DeviceAdmin	NetworkAdmin	Can be set in Remote UI	Device Information Delivery Available	Import All Function	Name of Item When Exporting with the Remote UI
<Use IPv6>	<On>, <Off>	No	Yes	Yes	No	C	Settings/Registration Basic Information

<Stateless Address Settings>

 (Settings/Registration) ▶ <Preferences> ▶ <Network> ▶ <TCP/IP Settings> ▶ <IPv6 Settings>

Specify the IPv6 stateless address. ▶<Setting an IPv6 Address>(P. 281)

Item	Setting Description	DeviceAdmin	NetworkAdmin	Can be set in Remote UI	Device Information Delivery Available	Import All Function	Name of Item When Exporting with the Remote UI
<Stateless Address Settings>	<Use Stateless Address>: <On>, <Off>	No	Yes	Yes	No	C	Settings/Registration Basic Information

<Manual Address Settings>

 (Settings/Registration) ▶ <Preferences> ▶ <Network> ▶ <TCP/IP Settings> ▶ <IPv6 Settings>

Specify the IPv6 address manually.  **Setting an IPv6 Address(P. 281)**

Item	Setting Description	DeviceAdmin	NetworkAdmin	Can be set in Remote UI	Device Information Delivery Available	Import All Function	Name of Item When Exporting with the Remote UI
<Manual Address Settings>	<Use Manual Address>: <On>, <Off>	No	Yes	Yes	No	A	Settings/Registration Basic Information
	<Manual Address> (IPv6 Address (39 characters maximum))	No	Yes	Yes	No	A	Settings/Registration Basic Information
	<Prefix Length>: 1 to 64 to 128	No	Yes	Yes	No	A	Settings/Registration Basic Information
	<Default Router Address> (39 characters maximum)	No	Yes	Yes	No	A	Settings/Registration Basic Information

<Use DHCPv6>

 (Settings/Registration) ▶ <Preferences> ▶ <Network> ▶ <TCP/IP Settings> ▶ <IPv6 Settings>

Specify whether to obtain the IPv6 address from the DHCP server.  **Setting an IPv6 Address(P. 281)**

Item	Setting Description	DeviceAdmin	NetworkAdmin	Can be set in Remote UI	Device Information Delivery Available	Import All Function	Name of Item When Exporting with the Remote UI
<Use DHCPv6>	<On>, <Off>	No	Yes	Yes	Yes	C	Settings/Registration Basic Information

<PING Command>

 (Settings/Registration) ▶ <Preferences> ▶ <Network> ▶ <TCP/IP Settings> ▶ <IPv6 Settings>

Check whether the IPv6 address is correctly specified.  **Conducting a Connection Test for an IPv6 Address(P. 282)**

Item	Setting Description	DeviceAdmin	NetworkAdmin	Can be set in Remote UI	Device Information Delivery Available	Import All Function	Name of Item When Exporting with the Remote UI
<PING Command>	<IPv6 Address> (39 characters maximum)	No	Yes	No	No	No	-
	<Host Name>	No	Yes	No	No	No	-

<Only Retrieve Stateful Address Prefix>

 (Settings/Registration) ▶ <Preferences> ▶ <Network> ▶ <TCP/IP Settings> ▶ <IPv6 Settings>

Specify whether to obtain only the former half of the stateful address from the DHCP server by using DHCPv6.

Item	Setting Description	DeviceAdmin	NetworkAdmin	Can be set in Remote UI	Device Information Delivery Available	Import All Function	Name of Item When Exporting with the Remote UI
<Only Retrieve Stateful Address Prefix>	<On>, <Off>	Yes	No	Yes	No	C	Settings/Registration Basic Information

<DHCP Option Settings>

 (Settings/Registration) ▶ <Preferences> ▶ <Network> ▶ <TCP/IP Settings> ▶ <IPv6 Settings>

Specify the optional settings for DHCP.  **Using a DHCP Server(P. 292)**

Item	Setting Description	DeviceAdmin	NetworkAdmin	Can be set in Remote UI	Device Information Delivery Available	Import All Function	Name of Item When Exporting with the Remote UI
<DHCP Option Settings>	<Acquire DNS Server Address>: <On>, <Off>	Yes	No	Yes	No	C	Settings/Registration Basic Information
	<Acquire Domain Name>: <On>, <Off>	Yes	No	Yes	No	C	Settings/Registration Basic Information

<DNS Settings>

961F-0L5

Specify the Domain Name System (DNS) settings for converting host names (domain names) to IP addresses.

- ▶<DNS Server Address Settings>(P. 1115)
- ▶<DNS Host Name/Domain Name Settings>(P. 1115)
- ▶<DNS Dynamic Update Settings>(P. 1116)
- ▶<mDNS Settings>(P. 1116)

NOTE

- For information on the items ("A", "B", "C", and "No") in the "Import All Function" column, see ▶<Import All Function>(P. 1054) .

<DNS Server Address Settings>

 (Settings/Registration) ▶ <Preferences> ▶ <Network> ▶ <TCP/IP Settings> ▶ <DNS Settings>

Specify the DNS server address settings. ▶<Making DNS Settings>(P. 289)

Item	Setting Description	DeviceAdmin	NetworkAdmin	Can be set in Remote UI	Device Information Delivery Available	Import All Function	Name of Item When Exporting with the Remote UI
<IPv4>	<Primary DNS Server>	No	Yes	Yes	No	C	Settings/Registration Basic Information
	<Secondary DNS Server>	No	Yes	Yes	No	C	Settings/Registration Basic Information
<IPv6>	<Primary DNS Server>	No	Yes	Yes	No	C	Settings/Registration Basic Information
	<Secondary DNS Server>	No	Yes	Yes	No	C	Settings/Registration Basic Information

<DNS Host Name/Domain Name Settings>

 (Settings/Registration) ▶ <Preferences> ▶ <Network> ▶ <TCP/IP Settings> ▶ <DNS Settings>

Specify the host name and domain name of the machine. ▶<Making DNS Settings>(P. 289)

Item	Setting Description	DeviceAdmin	NetworkAdmin	Can be set in Remote UI	Device Information Delivery Available	Import All Function	Name of Item When Exporting with the Remote UI
<IPv4>	<Host Name>: Canon***** ("*****" represents the last six digits of a MAC address.)	No	Yes	Yes	No	A	Settings/ Registration Basic Information

Item	Setting Description	DeviceAdmin	NetworkAdmin	Can be set in Remote UI	Device Information Delivery Available	Import All Function	Name of Item When Exporting with the Remote UI
	<Domain Name>	No	Yes	Yes	No	A	Settings/ Registration Basic Information
<IPv6>	<Use Same Host Name/ Domain Name as IPv4: <On>, <Off>	No	Yes	Yes	No	A	Settings/ Registration Basic Information
	<Host Name>: Canon***** ("*****" represents the last six digits of a MAC address.)	No	Yes	Yes	No	A	Settings/ Registration Basic Information
	<Domain Name>	No	Yes	Yes	No	A	Settings/ Registration Basic Information

<DNS Dynamic Update Settings>

 (Settings/Registration) ▶ <Preferences> ▶ <Network> ▶ <TCP/IP Settings> ▶ <DNS Settings>

Specify whether to perform the automatic update when the mapping between the host name and IP address is changed on an environment such as DHCP.  **Making DNS Settings(P. 289)**

Item	Setting Description	DeviceAdmin	NetworkAdmin	Can be set in Remote UI	Device Information Delivery Available	Import All Function	Name of Item When Exporting with the Remote UI
<IPv4>	<DNS Dynamic Update>: <On>, <Off>	No	Yes	Yes	No	C	Settings/Registration Basic Information
<IPv6>	<DNS Dynamic Update>: <On>, <Off>	No	Yes	Yes	No	C	Settings/Registration Basic Information
	<Register Stateless Address>: <On>, <Off>	No	Yes	Yes	No	C	Settings/Registration Basic Information
	<Register Manual Address>: <On>, <Off>	No	Yes	Yes	No	C	Settings/Registration Basic Information
	<Register Stateful Address>: <On>, <Off>	No	Yes	Yes	No	C	Settings/Registration Basic Information

<mDNS Settings>

 (Settings/Registration) ▶ <Preferences> ▶ <Network> ▶ <TCP/IP Settings> ▶ <DNS Settings>

Specify settings for using the DNS function on a system that does not have a DNS server.  **Making DNS Settings(P. 289)**

Settings/Registration

Item	Setting Description	DeviceAdmin	NetworkAdmin	Can be set in Remote UI	Device Information Delivery Available	Import All Function	Name of Item When Exporting with the Remote UI
<mDNS Settings>	<Use IPv4 mDNS>: <On>, <Off>	No	Yes	Yes	No	C	Settings/Registration Basic Information
	<mDNS Name> (63 characters maximum)	No	Yes	Yes	No	C	Settings/Registration Basic Information
	<Use IPv6 mDNS>: <On>, <Off>	No	Yes	Yes	No	C	Settings/Registration Basic Information
	<Use Same mDNS Name as IPv4>: <On>, <Off>	No	Yes	Yes	No	C	Settings/Registration Basic Information
	<mDNS Name> (63 characters maximum)	No	Yes	Yes	No	C	Settings/Registration Basic Information

<Firewall Settings>

Specify the packet filtering settings that permit communication only with devices that have a specific IP address and MAC address.

- ▶<IPv4 Address Filter>(P. 1118)
- ▶<IPv6 Address Filter>(P. 1118)
- ▶<MAC Address Filter>(P. 1118)
- ▶<IP Address Block Log>(P. 1118)

NOTE

- For information on the items ("A", "B", "C", and "No") in the "Import All Function" column, see ▶<Import All Function>(P. 1054) .

<IPv4 Address Filter>

 (Settings/Registration) ▶ <Preferences> ▶ <Network> ▶ <Firewall Settings>

Specify the settings for IPv4 address filtering.

- ▶<IPv4 Address Filter>(P. 1120)

<IPv6 Address Filter>

 (Settings/Registration) ▶ <Preferences> ▶ <Network> ▶ <Firewall Settings>

Specify the settings for IPv6 address filtering.

- ▶<IPv6 Address Filter>(P. 1123)

<MAC Address Filter>

 (Settings/Registration) ▶ <Preferences> ▶ <Network> ▶ <Firewall Settings>

Specify the settings for MAC address filtering.

- ▶<MAC Address Filter>(P. 1126)

<IP Address Block Log>

 (Settings/Registration) ▶ <Preferences> ▶ <Network> ▶ <Firewall Settings>

Displays the log for blocking with an IP address filter. ▶<Specifying IP Addresses in Firewall Settings>(P. 855)

Settings/Registration

Item	Setting Description	DeviceAdmin	NetworkAdmin	Can be set in Remote UI	Device Information Delivery Available	Import All Function	Name of Item When Exporting with the Remote UI
<IP Address Block Log>	<Time>, <Type>, <IP Address>, <Port Number>, <Result>, <Display IP Address>	No	Yes	Yes	No	No	-

<IPv4 Address Filter>

Specify the settings for IPv4 address filtering.

- ▶<Outbound Filter>(P. 1120)
- ▶<Inbound Filter>(P. 1121)
- ▶<Always Allow Sending/Receiving Using ICMP>(P. 1122)

NOTE

- For information on the items ("A", "B", "C", and "No") in the "Import All Function" column, see ▶<Import All Function>(P. 1054) .

<Outbound Filter>

 (Settings/Registration) ▶ <Preferences> ▶ <Network> ▶ <Firewall Settings> ▶ <IPv4 Address Filter>

Specify the outbound filter. ▶<Specifying IP Addresses in Firewall Settings>(P. 855)

Item	Setting Description	DeviceAdmin	NetworkAdmin	Can be set in Remote UI	Device Information Delivery Available	Import All Function	Name of Item When Exporting with the Remote UI
<Outbound Filter>	<Use Filter>: <On>, <Off>	No	Yes	Yes	No	C	Settings/Registration Basic Information
	<Default Policy>: <Allow>, <Reject>	No	Yes	Yes	No	C	Settings/Registration Basic Information
	<Register> (Up to 16 IPv4 addresses), <Details/Edit>, <Delete>	No	Yes	Yes	No	C	Settings/Registration Basic Information
	<ul style="list-style-type: none"> • <Register> <Single Address>, <Range Address> (<First Address>, <Last Address>), <Prefix Address> (<Address>, <Prefix Length>), <Port Number>(<Do Not Specify>, <Specify>) • <Specify>(<Port Number>): <Add>, <Delete> 	No	Yes	Yes	No	C	Settings/Registration Basic Information
	<ul style="list-style-type: none"> • <Details/Edit> <Single Address>, <Range Address> (<First Address>, <Last Address>), <Prefix Address> (<Address>, <Prefix Length>), <Port Number>(<Do Not Specify>, <Specify>) 	No	Yes	Yes	No	C	Settings/Registration Basic Information

Item	Setting Description	DeviceAdmin	NetworkAdmin	Can be set in Remote UI	Device Information Delivery Available	Import All Function	Name of Item When Exporting with the Remote UI
	<ul style="list-style-type: none"> <Prefix Length> (1 to 32) 	No	Yes	Yes	No	C	Settings/ Registration Basic Information

<Inbound Filter>

 (Settings/Registration) ▶ <Preferences> ▶ <Network> ▶ <Firewall Settings> ▶ <IPv4 Address Filter>

Specify the inbound filter.  **Specifying IP Addresses in Firewall Settings(P. 855)**

Item	Setting Description	DeviceAdmin	NetworkAdmin	Can be set in Remote UI	Device Information Delivery Available	Import All Function	Name of Item When Exporting with the Remote UI
<Inbound Filter>	<Use Filter>: <On>, <Off>	No	Yes	Yes	No	C	Settings/ Registration Basic Information
	<Default Policy>: <Allow>, <Reject>	No	Yes	Yes	No	C	Settings/ Registration Basic Information
	<Register> (Up to 16 IPv4 addresses), <Details/Edit>, <Delete>	No	Yes	Yes	No	C	Settings/ Registration Basic Information
	<ul style="list-style-type: none"> <Register> <Single Address>, <Range Address> (<First Address>, <Last Address>), <Prefix Address> (<Address>, <Prefix Length>), <Port Number> (<Do Not Specify>, <Specify>) <Specify> (<Port Number>): <Add>, <Delete> 	No	Yes	Yes	No	C	Settings/ Registration Basic Information
	<ul style="list-style-type: none"> <Details/Edit> <Single Address>, <Range Address> (<First Address>, <Last Address>), <Prefix Address> (<Address>, <Prefix Length>), <Port Number> (<Do Not Specify>, <Specify>) 	No	Yes	Yes	No	C	Settings/ Registration Basic Information
	<ul style="list-style-type: none"> <Prefix Length> (1 to 32) 	No	Yes	Yes	No	C	Settings/ Registration Basic Information

<Always Allow Sending/Receiving Using ICMP>

 (Settings/Registration) ▶ <Preferences> ▶ <Network> ▶ <Firewall Settings> ▶ <IPv4 Address Filter>

Specify whether to always allow ICMP communication.

Item	Setting Description	DeviceAdmin	NetworkAdmin	Can be set in Remote UI	Device Information Delivery Available	Import All Function	Name of Item When Exporting with the Remote UI
<Always Allow Sending/Receiving Using ICMP>	<On>, <Off>	No	Yes	Yes	No	C	Settings/Registration Basic Information

<IPv6 Address Filter>

Specify the settings for IPv6 address filtering.

▶<Outbound Filter>(P. 1123)

▶<Inbound Filter>(P. 1124)

▶<Always Allow Sending/Receiving Using ICMPv6>(P. 1124)

NOTE

- For information on the items ("A", "B", "C", and "No") in the "Import All Function" column, see ▶<Import All Function>(P. 1054) .

<Outbound Filter>

 (Settings/Registration) ▶ <Preferences> ▶ <Network> ▶ <Firewall Settings> ▶ <IPv6 Address Filter>

Specify the outbound filter. ▶<Specifying IP Addresses in Firewall Settings>(P. 855)

Item	Setting Description	DeviceAdmin	NetworkAdmin	Can be set in Remote UI	Device Information Delivery Available	Import All Function	Name of Item When Exporting with the Remote UI
<Outbound Filter>	<Use Filter>: <On>, <Off>	No	Yes	Yes	No	C	Settings/Registration Basic Information
	<Default Policy>: <Allow>, <Reject>	No	Yes	Yes	No	C	Settings/Registration Basic Information
	<Register> (Up to 16 IPv6 addresses), <Details/Edit>, <Delete>	No	Yes	Yes	No	C	Settings/Registration Basic Information
	<ul style="list-style-type: none"> <Register> <ul style="list-style-type: none"> <Single Address> (<Address>), <Prefix Address> (<IPv6 Prefix>, <Prefix Length>), <Port Number>(<Do Not Specify>, <Specify>) <Specify>(<Port Number>): <Add>, <Delete> 	No	Yes	Yes	No	C	Settings/Registration Basic Information
<ul style="list-style-type: none"> <Details/Edit> <ul style="list-style-type: none"> <Single Address> (<Address>), <Prefix Address> (<IPv6 Prefix>, <Prefix Length>), <Port Number>(<Do Not Specify>, <Specify>) 	No	Yes	Yes	No	C	Settings/Registration Basic Information	

Item	Setting Description	DeviceAdmin	NetworkAdmin	Can be set in Remote UI	Device Information Delivery Available	Import All Function	Name of Item When Exporting with the Remote UI
	<ul style="list-style-type: none"> <Prefix Length> (1 to 128) 	No	Yes	Yes	No	C	Settings/ Registration Basic Information

<Inbound Filter>

 (Settings/Registration) ► <Preferences> ► <Network> ► <Firewall Settings> ► <IPv6 Address Filter>

Specify the inbound filter.  **Specifying IP Addresses in Firewall Settings(P. 855)**

Item	Setting Description	DeviceAdmin	NetworkAdmin	Can be set in Remote UI	Device Information Delivery Available	Import All Function	Name of Item When Exporting with the Remote UI
<Inbound Filter>	<Use Filter>: <On>, <Off>	No	Yes	Yes	No	C	Settings/ Registration Basic Information
	<Default Policy>: <Allow>, <Reject>	No	Yes	Yes	No	C	Settings/ Registration Basic Information
	<Register> (Up to 16 IPv6 addresses), <Details/Edit>, <Delete>	No	Yes	Yes	No	C	Settings/ Registration Basic Information
	<ul style="list-style-type: none"> <Register> <Single Address> (<Address>), <Prefix Address> (<IPv6 Prefix>, <Prefix Length>), <Port Number> (<Do Not Specify>, <Specify>) <Specify> (<Port Number>): <Add>, <Delete> 	No	Yes	Yes	No	C	Settings/ Registration Basic Information
	<ul style="list-style-type: none"> <Details/Edit> <Single Address> (<Address>), <Prefix Address> (<IPv6 Prefix>, <Prefix Length>), <Port Number> (<Do Not Specify>, <Specify>) 	No	Yes	Yes	No	C	Settings/ Registration Basic Information
	<ul style="list-style-type: none"> <Prefix Length> (1 to 128) 	No	Yes	Yes	No	C	Settings/ Registration Basic Information

<Always Allow Sending/Receiving Using ICMPv6>

 (Settings/Registration) ► <Preferences> ► <Network> ► <Firewall Settings> ► <IPv6 Address Filter>

Settings/Registration

Specify whether to always allow ICMPv6 communication.

Item	Setting Description	DeviceAdmin	NetworkAdmin	Can be set in Remote UI	Device Information Delivery Available	Import All Function	Name of Item When Exporting with the Remote UI
<Always Allow Sending/Receiving Using ICMPv6>	<On>, <Off>	No	Yes	Yes	No	C	Settings/Registration Basic Information

<MAC Address Filter>

Specify the settings for MAC address filtering.

▶<Outbound Filter>(P. 1126)

▶<Inbound Filter>(P. 1126)

NOTE

- For information on the items ("A", "B", "C", and "No") in the "Import All Function" column, see ▶<Import All Function>(P. 1054) .

<Outbound Filter>

 (Settings/Registration) ▶ <Preferences> ▶ <Network> ▶ <Firewall Settings> ▶ <MAC Address Filter>

Specify the outbound filter. ▶<Specifying MAC Addresses in Firewall Settings>(P. 858)

Item	Setting Description	DeviceAdmin	NetworkAdmin	Can be set in Remote UI	Device Information Delivery Available	Import All Function	Name of Item When Exporting with the Remote UI
<Outbound Filter>	<Use Filter>: <On>, <Off>	No	Yes	Yes	No	C	Settings/Registration Basic Information
	<Default Policy>: <Allow>, <Reject>	No	Yes	Yes	No	C	Settings/Registration Basic Information
	<Register> (Up to 100 Mac addresses), <Edit>, <Delete>	No	Yes	Yes	No	C	Settings/Registration Basic Information

<Inbound Filter>

 (Settings/Registration) ▶ <Preferences> ▶ <Network> ▶ <Firewall Settings> ▶ <MAC Address Filter>

Specify the inbound filter. ▶<Specifying MAC Addresses in Firewall Settings>(P. 858)

Item	Setting Description	DeviceAdmin	NetworkAdmin	Can be set in Remote UI	Device Information Delivery Available	Import All Function	Name of Item When Exporting with the Remote UI
<Inbound Filter>	<Use Filter>: <On>, <Off>	No	Yes	Yes	No	C	Settings/Registration Basic Information
	<Default Policy>: <Allow>, <Reject>	No	Yes	Yes	No	C	Settings/Registration Basic Information
	<Register> (Up to 100 Mac addresses), <Edit>, <Delete>	No	Yes	Yes	No	C	Settings/Registration Basic Information

<Wireless LAN>

961F-0LA

Specify the wireless LAN settings.

- ▶<Wireless LAN Settings>(P. 1127)
- ▶<Wireless LAN Information>(P. 1128)
- ▶<Power Save Mode>(P. 1128)

NOTE

- For information on the items ("A", "B", "C", and "No") in the "Import All Function" column, see ▶<Import All Function>(P. 1054) .

<Wireless LAN Settings>

 (Settings/Registration) ▶ <Preferences> ▶ <Network> ▶ <Wireless LAN>

Specify the wireless LAN settings. ▶<Connecting to a Wireless LAN>(P. 270)

Item	Setting Description	DeviceAdmin	NetworkAdmin	Can be set in Remote UI	Device Information Delivery Available	Import All Function	Name of Item When Exporting with the Remote UI
<WPS Push Button Mode>							
<WPS PIN Code Mode>							
<Other (Set Manually)>							
<Select Access Point>	Select the access point and security type from the list	No	Yes	No	No	No	-
	WEP authentication: <Enter Network Key (WEP)> (<WEP Key>: Enter the WEP key)	No	Yes	No	No	No	-
	WPA/WPA2-PSK, WPA2-PSK/WPA3-SAE, WPA3-SAE encryption: <<Enter Network Key>> (<Encryption Key>: Enter the WPA/WPA2-PSK Passphrase)	No	Yes	No	No	No	-
<Enter Manually>	<SSID>: Enter SSID	No	Yes	No	No	No	-
	<Security Settings>: <None>, <WEP>, <WPA/WPA2-PSK>, <WPA/WPA2-EAP>, <WPA2-PSK/WPA3-SAE>, <WPA3-SAE>	No	Yes	No	No	No	-
	<ul style="list-style-type: none"> • <Security Settings> (<WEP>) <IEEE 802.11 Auth.> (<Open System>, <Shared Key>), <WEP Key 1>, <WEP 	No	Yes	No	No	No	-

Item	Setting Description	DeviceAdmin	NetworkAdmin	Can be set in Remote UI	Device Information Delivery Available	Import All Function	Name of Item When Exporting with the Remote UI
	Key 2>, <WEP Key 3>, <WEP Key 4> <ul style="list-style-type: none"> <Security Settings> <Encryption Method> (<Auto>, <AES-CCMP>), <Encryption Key>						

<Wireless LAN Information>

 (Settings/Registration) ▶ <Preferences> ▶ <Network> ▶ <Wireless LAN>

Displays the setting information of wireless LAN.  **Check the settings and information of the wireless LAN(P. 271)**

Item	Setting Description	DeviceAdmin	NetworkAdmin	Can be set in Remote UI	Device Information Delivery Available	Import All Function	Name of Item When Exporting with the Remote UI
<Wireless LAN Information>	<Display All>	No	Yes	Yes	No	No	-
	<Details>	No	Yes	Yes	No	No	-

<Power Save Mode>

 (Settings/Registration) ▶ <Preferences> ▶ <Network> ▶ <Wireless LAN>

Specify whether to set the machine to the power save mode periodically, according to the signals sent by a wireless LAN router.  **Connecting to a Wireless LAN(P. 270)**

Item	Setting Description	DeviceAdmin	NetworkAdmin	Can be set in Remote UI	Device Information Delivery Available	Import All Function	Name of Item When Exporting with the Remote UI
<Power Save Mode>	<On>, <Off>	No	Yes	Yes	No	C	Settings/Registration Basic Information

<Direct Connection Settings>

Specify the direct connection settings.

- ▶<Use Direct Connection>(P. 1129)
- ▶<Direct Connection Type>(P. 1129)
- ▶<Device Name for Wi-Fi Direct>(P. 1130)
- ▶<Time Until Direct Connection Session Is Terminated>(P. 1130)
- ▶<Access Point Mode Settings>(P. 1130)
- ▶<Always Keep Enabled If SSID/Network Key Specified>(P. 1131)
- ▶<IP Address Settings for Direct Connection>(P. 1132)
- ▶<Personal SSID and Network Key Settings>(P. 1132)
- ▶<Use Login Name as User Name for Print Jobs>(P. 1133)

NOTE

- For information on the items ("A", "B", "C", and "No") in the "Import All Function" column, see ▶<Import All Function(P. 1054) .

<Use Direct Connection>

 (Settings/Registration) ▶ <Preferences> ▶ <Network> ▶ <Direct Connection Settings>

Specify whether to use direct connection. ▶<Connecting Directly(P. 766)

Item	Setting Description	DeviceAdmin	NetworkAdmin	Can be set in Remote UI	Device Information Delivery Available	Import All Function	Name of Item When Exporting with the Remote UI
<Use Direct Connection>	<On>, <Off>	No	Yes	Yes	No	C	Settings/Registration Basic Information

<Direct Connection Type>

 (Settings/Registration) ▶ <Preferences> ▶ <Network> ▶ <Direct Connection Settings>

Select the type of direct connection. ▶<Connecting Directly(P. 766)

Item	Setting Description	DeviceAdmin	NetworkAdmin	Can be set in Remote UI	Device Information Delivery Available	Import All Function	Name of Item When Exporting with the Remote UI
<Direct Connection Type>	<Access Point Mode>, <Wi-Fi Direct>	No	Yes	Yes	No	C	Settings/Registration Basic Information

NOTE

- If Wi-Fi Direct is selected, only one mobile device can connect.

<Device Name for Wi-Fi Direct>

 (Settings/Registration) ▶ <Preferences> ▶ <Network> ▶ <Direct Connection Settings>

Specify the device name to use for direct connections (Wi-Fi Direct).

Item	Setting Description	DeviceAdmin	NetworkAdmin	Can be set in Remote UI	Device Information Delivery Available	Import All Function	Name of Item When Exporting with the Remote UI
<Device Name for Wi-Fi Direct>	<Device Name for Wi-Fi Direct (Max 32 characters)>: Device Name	No	Yes	Yes	No	No	-

IMPORTANT

- "-XY_Canon10" (where XY are random letters) is automatically appended to the device name for Wi-Fi Direct, unless the device name is 22 characters or more, in which case "-XY_Canon10" is not appended.

<Time Until Direct Connection Session Is Terminated>

 (Settings/Registration) ▶ <Preferences> ▶ <Network> ▶ <Direct Connection Settings>

Specify the time before communication is automatically terminated when there is a prolonged period of no data transmission/reception while communicating using direct connection.

Item	Setting Description	DeviceAdmin	NetworkAdmin	Can be set in Remote UI	Device Information Delivery Available	Import All Function	Name of Item When Exporting with the Remote UI
<Time Until Direct Connection Session Is Terminated>	0 = None, 1 to 30 to 60 min.	No	Yes	Yes	No	C	Settings/Registration Basic Information

NOTE

- This setting is disabled if <Always Keep Enabled If SSID/Network Key Specified> is set to <On>.

<Access Point Mode Settings>

 (Settings/Registration) ▶ <Preferences> ▶ <Network> ▶ <Direct Connection Settings>

Specify the settings for access point mode.

Item	Setting Description	DeviceAdmin	NetworkAdmin	Can be set in Remote UI	Device Information Delivery Available	Import All Function	Name of Item When Exporting with the Remote UI
<Access Point Mode Settings>	<Use Personal SSID and Network Key>: <On>, <Off>	No	Yes	Yes	No	C	Settings/Registration Basic Information
	<Specify SSID to Use>: <On>, <Off>	No	Yes	Yes	No	C	Settings/Registration Basic Information
	<SSID>: Enter SSID	No	Yes	Yes	No	C	Settings/Registration Basic Information
	<Specify Network Key to Use>: <On>, <Off>	No	Yes	Yes	No	C	Settings/Registration Basic Information
	<Network Key>: Enter the network key	No	Yes	Yes	No	C	Settings/Registration Basic Information

NOTE

When <Use Personal SSID and Network Key> is set to <On>

- Information on the user and SSID/network key when logging in is associated and stored in the machine. Only one mobile device can be connected.

When <Use Personal SSID and Network Key> is set to <Off>

- If both <Specify SSID to Use> and <Specify Network Key to Use> are set to <On>, multiple mobile devices can be connected at the same time. A maximum of five devices can be connected at the same time.
- If either or both <Specify SSID to Use> and <Specify Network Key to Use> are set to <Off>, a random SSID or network key is used to connect each time. Only one mobile device can be connected.

<Always Keep Enabled If SSID/Network Key Specified>

 (Settings/Registration) ► <Preferences> ► <Network> ► <Direct Connection Settings>

If <Specify SSID to Use> and <Specify Network Key to Use> are enabled in <Access Point Mode Settings>, direct connections can be made without pressing <Enable> in <Direct Connection> in <Mobile Portal>.

Item	Setting Description	DeviceAdmin	NetworkAdmin	Can be set in Remote UI	Device Information Delivery Available	Import All Function	Name of Item When Exporting with the Remote UI
<Always Keep Enabled If SSID/Network Key Specified>	<On>, <Off>	No	Yes	Yes	No	C	Settings/Registration Basic Information

NOTE

- The machine can connect with multiple mobile devices at the same time. A maximum of five devices can be connected at the same time.
- If this is set to <On>, the <Time Until Direct Connection Session Is Terminated> setting is disabled.
- If this is set to <On>, the machine will not enter the Sleep mode completely.

<IP Address Settings for Direct Connection>

 (Settings/Registration) ▶ <Preferences> ▶ <Network> ▶ <Direct Connection Settings>

Specify the IP address to distribute to mobile devices connecting using direct connection.

Item	Setting Description	DeviceAdmin	NetworkAdmin	Can be set in Remote UI	Device Information Delivery Available	Import All Function	Name of Item When Exporting with the Remote UI
<IP Address Settings for Direct Connection>	192.168.22.1	No	Yes	Yes	No	C	Settings/Registration Basic Information

NOTE

- The IP address distributed to mobile devices may be up to nine numbers greater than the value of the specified IP address.

<Personal SSID and Network Key Settings>

 (Settings/Registration) ▶ <Preferences> ▶ <Network> ▶ <Direct Connection Settings>

Specify an SSID and network key for each user when logging in and connecting using a direct connection.

- To set an SSID, set <Specify SSID to Use> to <On>, and enter the SSID.
- To set a network key, set <Specify Network Key to Use> to <On>, and enter the network key.
- If <Automatically Enable/Disable Direct Connection at Login/Logout> is set to <On>, direct connections are possible when logging in without pressing <Mobile Portal> ▶ <Direct Connection> ▶ <Enable>.

Item	Setting Description	DeviceAdmin	NetworkAdmin	Can be set in Remote UI	Device Information Delivery Available	Import All Function	Name of Item When Exporting with the Remote UI
<Personal SSID and Network Key Settings>	<Specify SSID to Use>: <On>, <Off>	Yes	Yes	No	No	C	Personal Setting Information
	<SSID>: Enter personal SSID.	Yes	Yes	No	No	C	Personal Setting Information
	<Specify Network Key to Use>: <On>, <Off>	Yes	Yes	No	No	C	Personal Setting Information
	<Network Key>: Enter personal network key.	Yes	Yes	No	No	C	Personal Setting Information
	<Automatically Enable/Disable Direct Connection at Login/Logout>: <On>, <Off>	Yes	Yes	No	No	C	Personal Setting Information

NOTE

- When specifying this setting as an administrator, select <Personal Settings> on the Settings/Registration screen.

<Use Login Name as User Name for Print Jobs>

 (Settings/Registration) ▶ <Preferences> ▶ <Network> ▶ <Direct Connection Settings>

Specify whether to display the login name as the user name of print jobs that are printed using direct connection.

Item	Setting Description	DeviceAdmin	NetworkAdmin	Can be set in Remote UI	Device Information Delivery Available	Import All Function	Name of Item When Exporting with the Remote UI
<Use Login Name as User Name for Print Jobs>	<On>, <Off>	No	Yes	Yes	No	C	Settings/Registration Basic Information

<Sub Line Settings>

Specify the sub-line settings (wireless LAN or a separate wired LAN) when a wired LAN and a wireless LAN, or a wired LAN and another wired LAN, are both used at the same time.

- ▶<IP Address Settings>(P. 1134)
- ▶<Priority Line for Communication with Mobile Devices>(P. 1134)
- ▶<Ethernet Driver Settings>(P. 1135)
- ▶<Firewall Settings>(P. 1135)
- ▶<Settings for System Data Communic.>(P. 1135)

NOTE

- For information on the items ("A", "B", "C", and "No") in the "Import All Function" column, see ▶<Import All Function(P. 1054) .

<IP Address Settings>

 (Settings/Registration) ▶ <Preferences> ▶ <Network> ▶ <Sub Line Settings>

Specify the IPV4 address for the sub line. ▶<Setting the IPv4 Address of the Sub Line(P. 284)>

Item	Setting Description	DeviceAdmin	NetworkAdmin	Can be set in Remote UI	Device Information Delivery Available	Import All Function	Name of Item When Exporting with the Remote UI
<IP Address Settings>	<DHCP>: <On>, <Off>	No	Yes	No	No	C	Settings/Registration Basic Information
	<IP Address>: <0.0.0.0>	No	Yes	No	No	A	Settings/Registration Basic Information
	<Subnet Mask>: <0.0.0.0>	No	Yes	No	No	C	Settings/Registration Basic Information
	<Gateway Address>: <0.0.0.0>	No	Yes	No	No	C	Settings/Registration Basic Information

<Priority Line for Communication with Mobile Devices>

 (Settings/Registration) ▶ <Preferences> ▶ <Network> ▶ <Sub Line Settings>

Select the line to connect mobile devices to when using both a main line and sub line at the same time.

Item	Setting Description	DeviceAdmin	NetworkAdmin	Can be set in Remote UI	Device Information Delivery Available	Import All Function	Name of Item When Exporting with the Remote UI
<Priority Line for Communication with Mobile Devices>	<Main Line>, <Sub Line>	No	Yes	No	No	C	Settings/Registration Basic Information

<Ethernet Driver Settings>

 (Settings/Registration) ▶ <Preferences> ▶ <Network> ▶ <Sub Line Settings>

Specify the Ethernet driver settings for the sub line.  **Making Ethernet Settings(P. 286)**

Item	Setting Description	DeviceAdmin	NetworkAdmin	Can be set in Remote UI	Device Information Delivery Available	Import All Function	Name of Item When Exporting with the Remote UI
<Ethernet Driver Settings>	<Auto Detect>: <On>, <Off>	No	Yes	Yes	No	C	Settings/Registration Basic Information
	<ul style="list-style-type: none"> <Communication Mode> (Off): <Half Duplex>, <Full Duplex> 	No	Yes	Yes	No	C	Settings/Registration Basic Information
	<ul style="list-style-type: none"> <Ethernet Type> (Off): <10BASE-T>, <100BASE-TX>, <1000BASE-T> 	No	Yes	Yes	No	C	Settings/Registration Basic Information
	<Current Transmission Speed>: Display Only	No	Yes	Yes	No	No	-
	<MAC Address>: Display only	No	Yes	Yes	No	No	-

<Firewall Settings>

 (Settings/Registration) ▶ <Preferences> ▶ <Network> ▶ <Sub Line Settings>

Specify the settings for packet filtering to a sub-line (to permit communication only with devices that have a specific IP address).

 **<Firewall Settings>(P. 1136)**

<Settings for System Data Communic.>

 (Settings/Registration) ▶ <Preferences> ▶ <Network> ▶ <Sub Line Settings>

Specify the settings for a DNS and proxy used for specific system data communication over a sub-line.

 **<Settings for System Data Communic.>(P. 1139)**

<Firewall Settings>

Specify the settings for packet filtering to a sub-line (to permit communication only with devices that have a specific IP address).

NOTE

- For information on the items ("A", "B", "C", and "No") in the "Import All Function" column, see [Import All Function\(P. 1054\)](#) .

<IPv4 Address Filter>

 (Settings/Registration) ▶ <Preferences> ▶ <Network> ▶ <Sub Line Settings> ▶ <Firewall Settings>

Specify the settings for IPv4 address filtering in sub-line communication.

<Outbound Filter>

 (Settings/Registration) ▶ <Preferences> ▶ <Network> ▶ <Sub Line Settings> ▶ <Firewall Settings> ▶ <IPv4 Address Filter>

Specify the transmission filter in the sub line settings. [Configuring the Firewall of the Sub Line\(P. 859\)](#)

Item	Setting Description	DeviceAdmin	NetworkAdmin	Can be set in Remote UI	Device Information Delivery Available	Import All Function	Name of Item When Exporting with the Remote UI
<Outbound Filter>	<Use Filter>: <On>, <Off>	No	Yes	Yes	No	C	Settings/Registration Basic Information
	<Default Policy>: <Allow>, <Reject>	No	Yes	Yes	No	C	Settings/Registration Basic Information
	<Register> (Up to 16 IPv4 addresses), <Details/Edit>, <Delete>	No	Yes	Yes	No	C	Settings/Registration Basic Information
	<ul style="list-style-type: none"> <Register> <Single Address>, <Range Address> (<First Address>, <Last Address>), <Prefix Address> (<Address>, <Prefix Length>), <Port Number>(<Do Not Specify>, <Specify>) <Specify>(<Port Number>); <Add>, <Delete> 	No	Yes	Yes	No	C	Settings/Registration Basic Information
<ul style="list-style-type: none"> <Details/Edit> <Single Address>, <Range Address> 	No	Yes	Yes	No	C	Settings/Registration	

Settings/Registration

	(<First Address>, <Last Address>), <Prefix Address> (<Address>, <Prefix Length>), <Port Number>(<Do Not Specify>, <Specify>)						Basic Information
	<ul style="list-style-type: none"> <Prefix Length> (1 to 32) 	No	Yes	Yes	No	C	Settings/Registration Basic Information

<Inbound Filter>

 (Settings/Registration) ▶ <Preferences> ▶ <Network> ▶ <Sub Line Settings> ▶ <Firewall Settings> ▶ <IPv4 Address Filter>

Specify the reception filter in the sub line settings.  **Configuring the Firewall of the Sub Line(P. 859)**

Item	Setting Description	DeviceAdmin	NetworkAdmin	Can be set in Remote UI	Device Information Delivery Available	Import All Function	Name of Item When Exporting with the Remote UI
<Inbound Filter>	<Use Filter>: <On>, <Off>	No	Yes	Yes	No	C	Settings/Registration Basic Information
	<Default Policy>: <Allow>, <Reject>	No	Yes	Yes	No	C	Settings/Registration Basic Information
	<Register> (Up to 16 IPv4 addresses), <Details/Edit>, <Delete>	No	Yes	Yes	No	C	Settings/Registration Basic Information
	<ul style="list-style-type: none"> <Register> <Single Address>, <Range Address> (<First Address>, <Last Address>), <Prefix Address> (<Address>, <Prefix Length>), <Port Number>(<Do Not Specify>, <Specify>) <Specify>(<Port Number>); <Add>, <Delete> 	No	Yes	Yes	No	C	Settings/Registration Basic Information
	<ul style="list-style-type: none"> <Details/Edit> <Single Address>, <Range Address> (<First Address>, <Last Address>), <Prefix Address> (<Address>, <Prefix Length>), <Port Number>(<Do Not Specify>, <Specify>) 	No	Yes	Yes	No	C	Settings/Registration Basic Information
	<ul style="list-style-type: none"> <Prefix Length> (1 to 32) 	No	Yes	Yes	No	C	Settings/Registration

Settings/Registration

								Basic Information
--	--	--	--	--	--	--	--	----------------------

<Settings for System Data Communic.>

961F-0LJ

Specify the settings for a DNS and proxy used for specific system data communication over a sub-line.

▶<DNS Server Address Settings>(P. 1139)

▶<Proxy Settings>(P. 1139)

▶<Select Line to Use>(P. 1140)

NOTE

- For information on the items ("A", "B", "C", and "No") in the "Import All Function" column, see ▶<Import All Function>(P. 1054) .

<DNS Server Address Settings>

 (Settings/Registration) ▶ <Preferences> ▶ <Network> ▶ <Sub Line Settings> ▶ <Settings for System Data Communic.>

Specify the DNS server address settings for the sub line. ▶<Setting the DNS of the Sub Line>(P. 311)

Item	Setting Description	DeviceAdmin	NetworkAdmin	Can be set in Remote UI	Device Information Delivery Available	Import All Function	Name of Item When Exporting with the Remote UI
<DNS Server Address Settings>	<Primary DNS Server>	No	Yes	Yes	No	C	Settings/Registration Basic Information
	<Secondary DNS Server>	No	Yes	Yes	No	C	Settings/Registration Basic Information

<Proxy Settings>

 (Settings/Registration) ▶ <Preferences> ▶ <Network> ▶ <Sub Line Settings> ▶ <Settings for System Data Communic.>

Specify the proxy settings for the sub line. ▶<Setting a Proxy>(P. 862)

Item	Setting Description	DeviceAdmin	NetworkAdmin	Can be set in Remote UI	Device Information Delivery Available	Import All Function	Name of Item When Exporting with the Remote UI
<Proxy Settings>	<Use Proxy>: <On>, <Off>	No	Yes	Yes	No	C	Settings/Registration Basic Information
	<Server Address> (IP Address or FQDN)	No	Yes	Yes	No	C	Settings/Registration Basic Information
	<Port Number>: 1 to 80 to 65535	No	Yes	Yes	No	C	Settings/Registration Basic Information

Settings/Registration

Item	Setting Description	DeviceAdmin	NetworkAdmin	Can be set in Remote UI	Device Information Delivery Available	Import All Function	Name of Item When Exporting with the Remote UI
<Set Authentication>	<Use Proxy Authentication>: <On>, <Off>	No	Yes	Yes	No	C	Settings/Registration Basic Information
	<User Name> (24 characters maximum)	No	Yes	Yes	No	C	Settings/Registration Basic Information
	<Password> (24 characters maximum)	No	Yes	Yes	No	C	Settings/Registration Basic Information

<Select Line to Use>

 (Settings/Registration) ▶ <Preferences> ▶ <Network> ▶ <Sub Line Settings> ▶ <Settings for System Data Communic.>

Specify whether to use the sub-line when communicating with the remote monitoring server or the distribution server.

Item	Setting Description	DeviceAdmin	NetworkAdmin	Can be set in Remote UI	Device Information Delivery Available	Import All Function	Name of Item When Exporting with the Remote UI
<Select Line to Use>	<Main Line>, <Sub Line>	Yes	Yes	Yes	No	C	Settings/Registration Basic Information

<External Interface>

Specify the settings for external interfaces.

NOTE

- For information on the items ("A", "B", "C", and "No") in the "Import All Function" column, see [▶ Import All Function\(P. 1054\)](#) .

<USB Settings>

 (Settings/Registration) ▶ <Preferences> ▶ <External Interface>

Specify the USB connection settings.

<Use as USB Device>

 (Settings/Registration) ▶ <Preferences> ▶ <External Interface> ▶ <USB Settings>

You can set whether to use the machine as a USB device.

Item	Setting Description	DeviceAdmin	NetworkAdmin	Can be set in Remote UI	Device Information Delivery Available	Import All Function	Name of Item When Exporting with the Remote UI
<Use as USB Device>	<On>, <Off>	No	No	Yes	Yes	C	Settings/ Registration Basic Information

NOTE

- If this is set to <Off>, print and scan jobs from a computer connected via USB cable cannot be performed.

<Use MEAP Driver for USB Input Device>

 (Settings/Registration) ▶ <Preferences> ▶ <External Interface> ▶ <USB Settings>

You can set whether to use the MEAP driver for USB input device connections.

Item	Setting Description	DeviceAdmin	NetworkAdmin	Can be set in Remote UI	Device Information Delivery Available	Import All Function	Name of Item When Exporting with the Remote UI
<Use MEAP Driver for USB Input Device>	<On>, <Off>	No	No	Yes	Yes	C	Settings/ Registration Basic Information

 **IMPORTANT**

- Depending on the type of MEAP application that uses device such as a keyboard or card reader, you may need to set this to <On>. To check whether you need to set this to <On>, see the manual for the MEAP application you are using, or contact your dealer or service representative.

<Use MEAP Driver for USB Storage Device>

 (Settings/Registration) ▶ <Preferences> ▶ <External Interface> ▶ <USB Settings>

You can set whether to use the MEAP driver for USB external storage.

Item	Setting Description	DeviceAdmin	NetworkAdmin	Can be set in Remote UI	Device Information Delivery Available	Import All Function	Name of Item When Exporting with the Remote UI
<Use MEAP Driver for USB Storage Device>	<On>, <Off>	No	No	Yes	Yes	C	Settings/ Registration Basic Information

IMPORTANT

- Depending on the type of MEAP application that uses USB external memory device, you may need to set this to <On>. To check whether you need to set this to <On>, see the manual for the MEAP application you are using, or contact your dealer or service representative.

<Use USB Storage Device>

 (Settings/Registration) ▶ <Preferences> ▶ <External Interface> ▶ <USB Settings>

You can set whether to allow the use of USB external storage devices.

Item	Setting Description	DeviceAdmin	NetworkAdmin	Can be set in Remote UI	Device Information Delivery Available	Import All Function	Name of Item When Exporting with the Remote UI
<Use USB Storage Device>	<On>, <Off>	Yes	No	Yes	No	C	Settings/ Registration Basic Information

<Accessibility>

Specify the settings for the accessibility functions for people who have difficulty seeing the display or entering data.

- ▶<Key Repetition Settings>(P. 1143)
- ▶<Reversed Display (Color)>(P. 1143)
- ▶<Enable Screen Magnification>(P. 1143)
- ▶<Use Flick/Pinch Function>(P. 1144)

NOTE

- For information on the items ("A", "B", "C", and "No") in the "Import All Function" column, see ▶<Import All Function>(P. 1054) .

<Key Repetition Settings>

 (Settings/Registration) ▶ <Preferences> ▶ <Accessibility>

You can set the amount of time before characters start repeating when you hold down a key on the touch panel display, as well as the interval between repetitions.

Item	Setting Description	DeviceAdmin	NetworkAdmin	Can be set in Remote UI	Device Information Delivery Available	Import All Function	Name of Item When Exporting with the Remote UI
<Key Repetition Settings>	<Standard>, <Slightly Slow>, <Slow>	Yes	Yes	No	No	C	Settings/Registration Basic Information

<Reversed Display (Color)>

 (Settings/Registration) ▶ <Preferences> ▶ <Accessibility>

You can invert the screen colors of the touch panel display. If you find it hard to view the display even after adjusting the brightness, try specifying this setting.

Item	Setting Description	DeviceAdmin	NetworkAdmin	Can be set in Remote UI	Device Information Delivery Available	Import All Function	Name of Item When Exporting with the Remote UI
<Reversed Display (Color)>	<On>, <Off>	Yes	Yes	No	No	C	Settings/Registration Basic Information

<Enable Screen Magnification>

 (Settings/Registration) ▶ <Preferences> ▶ <Accessibility>

On the <Home> screen and the Basic Features Screen of each function, you can zoom in or out by spreading two fingers apart (zoom in) or pinching two fingers together (zoom out).

Item	Setting Description	DeviceAdmin	NetworkAdmin	Can be set in Remote UI	Device Information Delivery Available	Import All Function	Name of Item When Exporting with the Remote UI
<Enable Screen Magnification>	<On>, <Off>	Yes	Yes	No	No	C	Settings/Registration Basic Information

IMPORTANT

- If <Enable Screen Magnification> is set to <On> and you want to enlarge or reduce the preview image of a scanned document or saved file, use the zoom in/zoom out buttons at the top of the preview screen.

<Use Flick/Pinch Function>

 (Settings/Registration) ▶ <Preferences> ▶ <Accessibility>

You can set whether to use flick and pinch operations.

Item	Setting Description	DeviceAdmin	NetworkAdmin	Can be set in Remote UI	Device Information Delivery Available	Import All Function	Name of Item When Exporting with the Remote UI
<Use Flick/Pinch Function>	<On>, <Off>	Yes	Yes	No	No	C	Settings/Registration Basic Information

NOTE

- The following functions are not affected by this setting.
 - Flick operations on the <Display Image> screen
 - MEAP applications

<Adjustment/Maintenance>

961F-0LR

Specify the settings for adjustments such as the image quality and for the machine's auto cleaning function.

 <Adjust Image Quality>(P. 1145)

 <Adjust Action>(P. 1145)

 <Maintenance>(P. 1145)

<Adjust Image Quality>

 (Settings/Registration) ▶ <Adjustment/Maintenance>

Specify the image quality adjustment for copying and printing.

 <Adjust Image Quality>(P. 1146)

<Adjust Action>

 (Settings/Registration) ▶ <Adjustment/Maintenance>

Specify the settings for adjusting the machine's actions.

 <Adjust Action>(P. 1151)

<Maintenance>

 (Settings/Registration) ▶ <Adjustment/Maintenance>

Specify the settings for the machine's auto cleaning function.

 <Maintenance>(P. 1154)

<Adjust Image Quality>

Specify the image quality adjustment for copying and printing.

- ▶ <Auto Adjust Gradation>(P. 1146)
- ▶ <Correct Density>(P. 1147)
- ▶ <Correct Shading>(P. 1147)
- ▶ <Auto Correct Color Mismatch>(P. 1148)
- ▶ <Full Color Printing Vividness Settings>(P. 1148)
- ▶ <Fine Adjust Zoom>(P. 1148)
- ▶ <Dither Pattern Settings>(P. 1149)
- ▶ <Adjust Toner Volume Used for Color Printing>(P. 1149)
- ▶ <Special Smoothing>(P. 1149)
- ▶ <Register Color Profile>(P. 1150)

NOTE

- For information on the items ("A", "B", "C", and "No") in the "Import All Function" column, see ▶ **Import All Function(P. 1054)** .

<Auto Adjust Gradation>

 (Settings/Registration) ▶ <Adjustment/Maintenance> ▶ <Adjust Image Quality>

If the gradation of the printing is significantly different from the original document, this correction adjusts the printing so that it more closely matches the original document. ▶ **Adjusting Gradation(P. 1378)**

Item	Setting Description	DeviceAdmin	NetworkAdmin	Can be set in Remote UI	Device Information Delivery Available	Import All Function	Name of Item When Exporting with the Remote UI
<Auto Adjust Gradation>	Paper Type Select	Yes	Yes	No	No	No	-
	When <Full Adjust> is set: Paper Select, <Start Printing>, <Start Scanning>						
	When <Quick Adjust> is set: <Start>						
	<Use Feeder When Performing Full Adjust>*1: On , Off <Initialize When Using Full Adjust>: <On>, <Off>						

*1 This item only appears if the 2-Sided Single Pass Feeder is installed.

IMPORTANT

- It is recommended that you select <Full Adjust> when performing an automatic gradation adjustment. Select <Quick Adjust> for a quick, but less complete adjustment between regular full adjustment recalibrations.

NOTE

- Test pages are not counted as part of the copy or print total page counts.

<Correct Density>

 (Settings/Registration) ▶ <Adjustment/Maintenance> ▶ <Adjust Image Quality>

If the density of the printing is significantly different from the original document, this adjusts the scan density to be closer to the original. 

Adjusting Density(P. 1381)

Item	Setting Description	DeviceAdmin	NetworkAdmin	Can be set in Remote UI	Device Information Delivery Available	Import All Function	Name of Item When Exporting with the Remote UI
<Correct Density>	<Copy/Scan and Store (Mail Box)>: <Light>, <Dark> (9 levels) <Black & White Scan for Send/Scan and Store (Other Than Mail Box)>: <Light>, <Dark> (9 levels) <Color Scan for Send/Scan and Store (Other Than Mail Box)>: <Light>, <Dark> (9 levels)	Yes	Yes	No	No	C	Settings/Registration Basic Information

<Correct Shading>

 (Settings/Registration) ▶ <Adjustment/Maintenance> ▶ <Adjust Image Quality>

If the image areas of the printing have uneven density, this correction adjusts the printing so that the density is even.  **Correcting Uneven Density(P. 1382)**

Item	Setting Description	DeviceAdmin	NetworkAdmin	Can be set in Remote UI	Device Information Delivery Available	Import All Function	Name of Item When Exporting with the Remote UI
<Correct Shading>	When <Densitometer Correction> is set: <Start Printing>	Yes	Yes	No	No	No	-
	When <Visual Correction> is set: <Fine Adjust>, <Restore Initial Settings>, <Restore Previous Settings>, <Output Test Page>						
	When <Scanner Correction> is set: Paper Select* ¹ , <Start Printing>, <Start Scanning>* ¹						

*¹ May not appear on some models.

<Auto Correct Color Mismatch>

 (Settings/Registration) ▶ <Adjustment/Maintenance> ▶ <Adjust Image Quality>

If the colors of printing run or blur, color mismatch (color misregistration) may have occurred. This correction adjusts the printing so that color mismatch does not occur.  **Correcting Color Mismatch(P. 1385)**

Item	Setting Description	DeviceAdmin	NetworkAdmin	Can be set in Remote UI	Device Information Delivery Available	Import All Function	Name of Item When Exporting with the Remote UI
<Auto Correct Color Mismatch>	<Start>	Yes	Yes	No	No	No	-

<Full Color Printing Vividness Settings>

 (Settings/Registration) ▶ <Adjustment/Maintenance> ▶ <Adjust Image Quality>

This setting enables you to make colors more saturated when performing color printing.  **Making Colors More Vivid(P. 1386)**

Item	Setting Description	DeviceAdmin	NetworkAdmin	Can be set in Remote UI	Device Information Delivery Available	Import All Function	Name of Item When Exporting with the Remote UI
<Full Color Printing Vividness Settings>	<Standard>, <Level 1>, <Level 2>	Yes	Yes	No	No	A	Settings/Registration Basic Information

NOTE

- This setting is only effective for copy jobs and print jobs of documents (scanned data) stored in mail boxes.

<Fine Adjust Zoom>

 (Settings/Registration) ▶ <Adjustment/Maintenance> ▶ <Adjust Image Quality>

If the size of the image copied is significantly different from the original document, fine adjustment is performed so that the printing more closely matches the size of the original document.  **Adjusting Image Size(P. 1387)**

Item	Setting Description	DeviceAdmin	NetworkAdmin	Can be set in Remote UI	Device Information Delivery Available	Import All Function	Name of Item When Exporting with the Remote UI
<Fine Adjust Zoom>	<X>: -1.0 % to 0 % to +1.0 % (in 0.1 % increments) <Y>: -1.0 % to 0 % to +1.0 % (in 0.1 % increments)	Yes	Yes	No	No	A	Settings/Registration Basic Information

<Dither Pattern Settings>

 (Settings/Registration) ▶ <Adjustment/Maintenance> ▶ <Adjust Image Quality>

Set the dither pattern to produce printed images with smoother gradation and edges.  **Setting the Dither Pattern(P. 1388)**

Item	Setting Description	DeviceAdmin	NetworkAdmin	Can be set in Remote UI	Device Information Delivery Available	Import All Function	Name of Item When Exporting with the Remote UI
<Dither Pattern Settings>	<Pattern 1>, <Pattern 2>, <Pattern 3>, <Pattern 4>	Yes	No	No	No	No	-

<Adjust Toner Volume Used for Color Printing>

 (Settings/Registration) ▶ <Adjustment/Maintenance> ▶ <Adjust Image Quality>

By adjusting the amount of toner used when color printing, you may be able to reduce problems such as streaks and irregularities.  **Reducing Toner Used When Color Printing(P. 1389)**

Item	Setting Description	DeviceAdmin	NetworkAdmin	Can be set in Remote UI	Device Information Delivery Available	Import All Function	Name of Item When Exporting with the Remote UI
<Adjust Toner Volume Used for Color Printing>	<Off>, <Level 1>, <Level 2>	Yes	No	No	No	A	Settings/Registration Basic Information

<Special Smoothing>

 (Settings/Registration) ▶ <Adjustment/Maintenance> ▶ <Adjust Image Quality>

This setting smoothes jagged outlines of dark colour characters, lines, figures, photos, images, and gradations by correcting colour displacement that occurs in the output.

Item	Setting Description	DeviceAdmin	NetworkAdmin	Can be set in Remote UI	Device Information Delivery Available	Import All Function	Name of Item When Exporting with the Remote UI
<Special Smoothing>	<On>, <Off>	Yes	No	No	No	A	Settings/Registration Basic Information

IMPORTANT

- Make sure to set this setting to <Off> when you do not perform the correction. Depending on the types of originals, this function may cause other colour displacement or jagged outlines.

<Register Color Profile>

 (Settings/Registration) ▶ <Adjustment/Maintenance> ▶ <Adjust Image Quality>

For color printing, you can use this setting to match colors to other printer models or to ensure that specific colors are reproduced accurately. ▶

Registering a Color Profile for Printing(P. 1393)

Item	Setting Description	DeviceAdmin	NetworkAdmin	Can be set in Remote UI	Device Information Delivery Available	Import All Function	Name of Item When Exporting with the Remote UI
<Register Color Profile>	<Assign RGB Values to Output Colors in Color Chart>, <Reproduce Colors from Other Device>, <Profile List>	Yes	No	No	No	No	-

<Adjust Action>

Specify the settings for adjusting the machine's actions.

- ▶<Saddle Stitch Staple Repositioning>(P. 1151)
- ▶<Change Fold/Stitch Position>(P. 1151)
- ▶<Adjust Saddle Stitch Fold Position>(P. 1152)
- ▶<Adjust Fold Position>(P. 1152)
- ▶<Time Until Stapling Starts in Stapler Mode>(P. 1152)
- ▶<Start Key Touch Recognition Delay>(P. 1153)

NOTE

- For information on the items ("A", "B", "C", and "No") in the "Import All Function" column, see ▶<Import All Function>(P. 1054) .

Item marked with an asterisk (*)

- Only appears if you have the option installed. ▶<Checking the Options Installed on This Machine>(P. 1038)

<Saddle Stitch Staple Repositioning> *

⚙️ (Settings/Registration) ▶ <Adjustment/Maintenance> ▶ <Adjust Action>

Feeds papers to the saddle sticher unit and staples them several times, and performs the saddle stitch staple repositioning procedure. The machine performs this adjustment procedure if stapling has not been performed after you clear a staple jam or replace the staple cartridge.

Item	Setting Description	DeviceAdmin	NetworkAdmin	Can be set in Remote UI	Device Information Delivery Available	Import All Function	Name of Item When Exporting with the Remote UI
<Saddle Stitch Staple Repositioning>	<Start>	Yes	Yes	No	No	No	-

! IMPORTANT

- Make sure to remove all output booklets from the booklet tray before performing the saddle stitch staple repositioning procedure.

NOTE

- Paper that is required for the saddle stitch staple repositioning procedure is automatically fed to the saddle sticher unit by the machine.
- 305 mm x 457 mm, A3, B4, A4R, 11" x 17", LGL, LTRR, or custom paper sizes equivalent to these paper sizes can be used. (Make the paper source to which transparencies are registered unavailable.)

<Change Fold/Stitch Position> *

⚙️ (Settings/Registration) ▶ <Adjustment/Maintenance> ▶ <Adjust Action>

If you notice that the saddle stitch position of the paper is not exactly in the middle of the booklet, you can make adjustments to the saddle stitch position to compensate for this error. Adjust the folding position of the paper and the saddle stitch position at the same time. **▶ Adjusting the Saddle Stitch Position(P. 1390)**

Item	Setting Description	DeviceAdmin	NetworkAdmin	Can be set in Remote UI	Device Information Delivery Available	Import All Function	Name of Item When Exporting with the Remote UI
<Change Fold/Stitch Position>	-2.00 mm to 0.00 mm to +2.00 mm (in 0.25 mm increments)	Yes	Yes	No	No	No	-

<Adjust Saddle Stitch Fold Position> *

 (Settings/Registration) ▶ <Adjustment/Maintenance> ▶ <Adjust Action>

If you notice that the folds of the paper are not exactly in the middle of the booklet, you can make adjustments to the fold placement to compensate for this error. This mode enables you to adjust the folding position without changing the stapling position. **▶ Adjusting the Saddle Stitch Folding Position(P. 1391)**

Item	Setting Description	DeviceAdmin	NetworkAdmin	Can be set in Remote UI	Device Information Delivery Available	Import All Function	Name of Item When Exporting with the Remote UI
<Adjust Saddle Stitch Fold Position>	-2.00 mm to 0.00 mm to +2.00 mm (in 0.25 mm increments)	Yes	Yes	No	No	No	-

<Adjust Fold Position> *

 (Settings/Registration) ▶ <Adjustment/Maintenance> ▶ <Adjust Action>

You can adjust the paper folding position. **▶ Adjusting the Saddle Stitch Folding Position(P. 1391)**

Item	Setting Description	DeviceAdmin	NetworkAdmin	Can be set in Remote UI	Device Information Delivery Available	Import All Function	Name of Item When Exporting with the Remote UI
<Adjust Fold Position>	-2.00 mm to 0.00 mm to +2.00 mm (in 0.25 mm increments)	Yes	Yes	No	No	No	-

<Time Until Stapling Starts in Stapler Mode> *

 (Settings/Registration) ▶ <Adjustment/Maintenance> ▶ <Adjust Action>

You can set the time until stapling is performed after inserting paper when using manual stapling.

Item	Setting Description	DeviceAdmin	NetworkAdmin	Can be set in Remote UI	Device Information Delivery Available	Import All Function	Name of Item When Exporting with the Remote UI
<Time Until Stapling Starts in Stapler Mode>	1 to 3 to 5 second	Yes	Yes	No	No	C	Settings/Registration Basic Information

<Start Key Touch Recognition Delay>

 (Settings/Registration) ▶ <Adjustment/Maintenance> ▶ <Adjust Action>

Adjust the touch time required to begin startup processing.

Item	Setting Description	DeviceAdmin	NetworkAdmin	Can be set in Remote UI	Device Information Delivery Available	Import All Function	Name of Item When Exporting with the Remote UI
<Start Key Touch Recognition Delay>	-1 to 0 to +7	No	No	No	No	C	Settings/Registration Basic Information

NOTE

- This setting does not appear on models with an upright control panel.

<Maintenance>

Specify the settings for the machine's auto cleaning function.

- ▶<Clean Inside Main Unit>(P. 1154)
- ▶<Clean Feeder>(P. 1154)
- ▶<Original Scanning Area Cleaning Method>(P. 1154)
- ▶<Check Maintenance Method>(P. 1155)
- ▶<Initialize After Replacing Parts>(P. 1155)

NOTE

- For information on the items ("A", "B", "C", and "No") in the "Import All Function" column, see ▶<Import All Function>(P. 1054) .

<Clean Inside Main Unit>

 (Settings/Registration) ▶ <Adjustment/Maintenance> ▶ <Maintenance>

If streaks appear on printed paper, part of the image is missing, or dappling or spotting occurs, execute <Clean Inside Main Unit>.

Item	Setting Description	DeviceAdmin	NetworkAdmin	Can be set in Remote UI	Device Information Delivery Available	Import All Function	Name of Item When Exporting with the Remote UI
<Clean Inside Main Unit>	Start Cleaning	Yes	Yes	No	No	No	-

<Clean Feeder>

 (Settings/Registration) ▶ <Adjustment/Maintenance> ▶ <Maintenance>

If streaks appear on originals scanned with the feeder or paper that is printed, execute <Clean Feeder>. ▶<Cleaning the Feeder>(P. 88)

Item	Setting Description	DeviceAdmin	NetworkAdmin	Can be set in Remote UI	Device Information Delivery Available	Import All Function	Name of Item When Exporting with the Remote UI
<Clean Feeder>	Start Cleaning	Yes	Yes	No	No	No	-

<Original Scanning Area Cleaning Method>

 (Settings/Registration) ▶ <Adjustment/Maintenance> ▶ <Maintenance>

Start the video that shows how to clean the platen glass.

Item	Setting Description	DeviceAdmin	NetworkAdmin	Can be set in Remote UI	Device Information Delivery Available	Import All Function	Name of Item When Exporting with the Remote UI
<Original Scanning Area Cleaning Method>	Displays the Cleaning Method	Yes	Yes	No	No	No	-

NOTE

- This item only appears if the 2-Sided Single Pass Feeder is installed.

<Check Maintenance Method>

 (Settings/Registration) ▶ <Adjustment/Maintenance> ▶ <Maintenance>

For information on how to replace consumables and remove jammed paper, see the sample video.

 <Check Maintenance Method>(P. 1156)

<Initialize After Replacing Parts>

 (Settings/Registration) ▶ <Adjustment/Maintenance> ▶ <Maintenance>

You must initialize the printer after replacing parts. Initialize the printer for each replaced part.

 <Initialize After Replacing Parts>(P. 1160)

<Check Maintenance Method>

For information on how to replace consumables and remove jammed paper, see the sample video.

- ▶<Replace Toner Cartridge>(P. 1156)
- ▶<Replace Waste Toner Container>(P. 1156)
- ▶<Load Staples (Staples)>(P. 1157)
- ▶<Load Staples (Saddle Staples)>(P. 1157)
- ▶<Replace Drum Unit>(P. 1157)
- ▶<Replace Fixing Assembly>(P. 1158)
- ▶<Replace ITB Unit>(P. 1158)
- ▶<Replace Secondary Transfer Outer Roller>(P. 1158)
- ▶<Replace ADF Maintenance Kit>(P. 1159)
- ▶<Remove Jammed Paper (Example)>(P. 1159)

NOTE

- For information on the items ("A", "B", "C", and "No") in the "Import All Function" column, see ▶<Import All Function(P. 1054) .

<Replace Toner Cartridge>

 (Settings/Registration) ▶ <Adjustment/Maintenance> ▶ <Maintenance> ▶ <Check Maintenance Method>

Plays the sample video explaining the method for replacing toner cartridges. You can play this sample video even when replacement is not necessary, so that you may understand the process in advance.

Item	Setting Description	DeviceAdmin	NetworkAdmin	Can be set in Remote UI	Device Information Delivery Available	Import All Function	Name of Item When Exporting with the Remote UI
<Replace Toner Cartridge>	Displays the toner cartridge replacement method	Yes	Yes	No	No	No	-

<Replace Waste Toner Container>

 (Settings/Registration) ▶ <Adjustment/Maintenance> ▶ <Maintenance> ▶ <Check Maintenance Method>

Plays the sample video explaining the method for replacing the waste toner container. You can play this sample video even when replacement is not necessary, so that you may understand the process in advance.

Item	Setting Description	DeviceAdmin	NetworkAdmin	Can be set in Remote UI	Device Information Delivery Available	Import All Function	Name of Item When Exporting with the Remote UI
<Replace Waste Toner Container>	Displays the waste toner container replacement method	Yes	Yes	No	No	No	-

<Load Staples (Staples)>

 (Settings/Registration) ▶ <Adjustment/Maintenance> ▶ <Maintenance> ▶ <Check Maintenance Method>

Plays the sample video explaining the method for loading staples. You can play this sample video even when replacement is not necessary, so that you may understand the process in advance.

Item	Setting Description	DeviceAdmin	NetworkAdmin	Can be set in Remote UI	Device Information Delivery Available	Import All Function	Name of Item When Exporting with the Remote UI
<Load Staples (Staples)>	Displays the staple cartridge replacement method	Yes	Yes	No	No	No	-

<Load Staples (Saddle Staples)>

 (Settings/Registration) ▶ <Adjustment/Maintenance> ▶ <Maintenance> ▶ <Check Maintenance Method>

Plays the sample video explaining the method for loading saddle stitch staples. You can play this sample video even when replacement is not necessary, so that you may understand the process in advance.

Item	Setting Description	DeviceAdmin	NetworkAdmin	Can be set in Remote UI	Device Information Delivery Available	Import All Function	Name of Item When Exporting with the Remote UI
<Load Staples (Saddle Staples)>	Displays the saddle staples cartridge replacement method	Yes	Yes	No	No	No	-

<Replace Drum Unit>

 (Settings/Registration) ▶ <Adjustment/Maintenance> ▶ <Maintenance> ▶ <Check Maintenance Method>

Plays the sample video explaining the method for replacing drum units. You can play this sample video even when replacement is not necessary, so that you may understand the process in advance.

Item	Setting Description	DeviceAdmin	NetworkAdmin	Can be set in Remote UI	Device Information Delivery Available	Import All Function	Name of Item When Exporting with the Remote UI
<Replace Drum Unit>	Displays the drum unit replacement method	Yes	Yes	No	No	No	-

<Replace Fixing Assembly>

 (Settings/Registration) ▶ <Adjustment/Maintenance> ▶ <Maintenance> ▶ <Check Maintenance Method>

Plays the sample video indicating the replacement method for the fixing assembly. You can play this sample video even when replacement is not necessary, so that you may understand the process in advance.

Item	Setting Description	DeviceAdmin	NetworkAdmin	Can be set in Remote UI	Device Information Delivery Available	Import All Function	Name of Item When Exporting with the Remote UI
<Replace Fixing Assembly>	Displays the fixing assembly replacement method	Yes	Yes	No	No	No	-

<Replace ITB Unit>

 (Settings/Registration) ▶ <Adjustment/Maintenance> ▶ <Maintenance> ▶ <Check Maintenance Method>

Plays the sample video indicating the replacement method for the ITB unit. You can play this sample video even when replacement is not necessary, so that you may understand the process in advance.

Item	Setting Description	DeviceAdmin	NetworkAdmin	Can be set in Remote UI	Device Information Delivery Available	Import All Function	Name of Item When Exporting with the Remote UI
<Replace ITB Unit>	Displays the ITB unit replacement method	Yes	Yes	No	No	No	-

<Replace Secondary Transfer Outer Roller>

 (Settings/Registration) ▶ <Adjustment/Maintenance> ▶ <Maintenance> ▶ <Check Maintenance Method>

Plays the sample video indicating the replacement method for the secondary transfer outer roller. You can play this sample video even when replacement is not necessary, so that you may understand the process in advance.

Item	Setting Description	DeviceAdmin	NetworkAdmin	Can be set in Remote UI	Device Information Delivery Available	Import All Function	Name of Item When Exporting with the Remote UI
<Replace Secondary Transfer Outer Roller>	Displays the secondary transfer outer roller replacement method	Yes	Yes	No	No	No	-

<Replace ADF Maintenance Kit>

 (Settings/Registration) ▶ <Adjustment/Maintenance> ▶ <Maintenance> ▶ <Check Maintenance Method>

Plays the sample video indicating the replacement method for the ADF Maintenance Kit. You can play this sample video even when replacement is not necessary, so that you may understand the process in advance.

Item	Setting Description	DeviceAdmin	NetworkAdmin	Can be set in Remote UI	Device Information Delivery Available	Import All Function	Name of Item When Exporting with the Remote UI
<Replace ADF Maintenance Kit>	Displays the maintenance screen for Replacing the ADF Maintenance Kit	Yes	Yes	No	No	No	-

<Remove Jammed Paper (Example)>

 (Settings/Registration) ▶ <Adjustment/Maintenance> ▶ <Maintenance> ▶ <Check Maintenance Method>

Plays the sample video explaining the method for removing jammed paper. You can play this sample video even when paper is not jammed, so that you may understand the process in advance.

Item	Setting Description	DeviceAdmin	NetworkAdmin	Can be set in Remote UI	Device Information Delivery Available	Import All Function	Name of Item When Exporting with the Remote UI
<Remove Jammed Paper (Example)>	Displays the method for clearing paper jams	Yes	Yes	No	No	No	-

<Initialize After Replacing Parts>

You must initialize the printer after replacing parts. Initialize the printer for each replaced part.

- ▶<ITB Unit>(P. 1160)
- ▶<Secondary Transfer Outer Roller>(P. 1160)
- ▶<ADF Maintenance Kit>(P. 1160)

<ITB Unit>

 (Settings/Registration) ▶ <Adjustment/Maintenance> ▶ <Maintenance> ▶ <Initialize After Replacing Parts>

After replacing the ITB unit, execute <ITB Unit> to perform initialization.

Item	Setting Description	DeviceAdmin	NetworkAdmin	Can be set in Remote UI	Device Information Delivery Available	Import All Function	Name of Item When Exporting with the Remote UI
<ITB Unit>	Yes, No	Yes	Yes	No	No	No	-

<Secondary Transfer Outer Roller>

 (Settings/Registration) ▶ <Adjustment/Maintenance> ▶ <Maintenance> ▶ <Initialize After Replacing Parts>

After replacing the secondary transfer outer roller, execute <Secondary Transfer Outer Roller> to perform initialization.

Item	Setting Description	DeviceAdmin	NetworkAdmin	Can be set in Remote UI	Device Information Delivery Available	Import All Function	Name of Item When Exporting with the Remote UI
<Secondary Transfer Outer Roller>	Yes, No	Yes	Yes	No	No	No	-

<ADF Maintenance Kit>

 (Settings/Registration) ▶ <Adjustment/Maintenance> ▶ <Maintenance> ▶ <Initialize After Replacing Parts>

After replacing the ADF pickup roller and ADF separation pad, execute <ADF Maintenance Kit> to perform initialization.

Item	Setting Description	DeviceAdmin	NetworkAdmin	Can be set in Remote UI	Device Information Delivery Available	Import All Function	Name of Item When Exporting with the Remote UI
<ADF Maintenance Kit>	Yes, No	Yes	Yes	No	No	No	-

<Function Settings>

961F-0R1

Specify the function settings for copying, printing, faxing, and other operations.

- ▶<Common>(P. 1161)
- ▶<Copy>(P. 1161)
- ▶<Printer>(P. 1161)
- ▶<Send>(P. 1161)
- ▶<Receive/Forward>(P. 1161)
- ▶<Store/Access Files>(P. 1162)
- ▶<Print>(P. 1162)
- ▶<Web Access>(P. 1162)

<Common>

 (Settings/Registration) ▶ <Function Settings>

Specify settings that are common to all the functions, such as Paper Feed Settings, Paper Output Settings, Print Settings, Scan Settings, and Generate File.

- ▶<Common>(P. 1163)

<Copy>

 (Settings/Registration) ▶ <Function Settings>

Specify the settings for the copy function.

- ▶<Copy>(P. 1197)

<Printer>

 (Settings/Registration) ▶ <Function Settings>

Specify the settings for the printer functions.

- ▶<Printer>(P. 1201)

<Send>

 (Settings/Registration) ▶ <Function Settings>

Specify the settings for the send function.

- ▶<Send>(P. 1224)

<Receive/Forward>

 (Settings/Registration) ▶ <Function Settings>

Specify the settings for the receive and forwarding functions.

 **<Receive/Forward>(P. 1266)**

<Store/Access Files>

 (Settings/Registration) ► <Function Settings>

Specify the settings used when you store scanned originals or use the stored files.

 **<Store/Access Files>(P. 1282)**

<Print>

 (Settings/Registration) ► <Function Settings>

Specify the settings for the print function.

 **<Print>(P. 1301)**

<Web Access>

 (Settings/Registration) ► <Function Settings>

Specify the settings for the web browser function.

 **<Web Access>(P. 1307)**

<Common>

Specify settings that are common to all the functions, such as Paper Feed Settings, Paper Output Settings, Print Settings, Scan Settings, and Generate File.

- ▶ <Paper Feed Settings>(P. 1163)
- ▶ <Paper Output Settings>(P. 1163)
- ▶ <Print Settings>(P. 1163)
- ▶ <Scan Settings>(P. 1163)
- ▶ <Generate File>(P. 1163)
- ▶ <Set Authentication Method>(P. 1164)

<Paper Feed Settings>

 (Settings/Registration) ▶ <Function Settings> ▶ <Common>

Specify the Paper Feed Settings that are common to all the functions.

- ▶ <Paper Feed Settings>(P. 1165)

<Paper Output Settings>

 (Settings/Registration) ▶ <Function Settings> ▶ <Common>

Specify the Paper Output Settings that are common to all the functions.

- ▶ <Paper Output Settings>(P. 1168)

<Print Settings>

 (Settings/Registration) ▶ <Function Settings> ▶ <Common>

Specify the Print Settings that are common to all the functions.

- ▶ <Print Settings>(P. 1172)

<Scan Settings>

 (Settings/Registration) ▶ <Function Settings> ▶ <Common>

Specify the Scan Settings that are common to all the functions.

- ▶ <Scan Settings>(P. 1184)

<Generate File>

 (Settings/Registration) ▶ <Function Settings> ▶ <Common>

Specify the Generate File settings that are common to all the functions.

 <Generate File>(P. 1190)

<Set Authentication Method>

 (Settings/Registration) ▶ <Function Settings> ▶ <Common>

Specify the settings for the authentication methods that are common to all the functions.

 <Set Authentication Method>(P. 1195)

<Paper Feed Settings>

Specify the Paper Feed Settings that are common to all the functions.

- ▶<Paper Source Auto Selection>(P. 1165)
- ▶<Paper Source Auto Selection Based on Color>(P. 1165)
- ▶<Switch Feed Method>(P. 1166)
- ▶<Suspended Job Timeout>(P. 1167)

NOTE

- For information on the items ("A", "B", "C", and "No") in the "Import All Function" column, see ▶<Import All Function(P. 1054) .

<Paper Source Auto Selection>

 (Settings/Registration) ▶ <Function Settings> ▶ <Common> ▶ <Paper Feed Settings>

You can configure the paper source that will be used when copying/printing with <Select Paper> set to <Auto>. This setting also functions when the paper in the current paper source runs out during copying/printing. ▶<Automatically Selecting the Appropriate Paper Source for a Specific Function (P. 79)>

Item	Setting Description	DeviceAdmin	NetworkAdmin	Can be set in Remote UI	Device Information Delivery Available	Import All Function	Name of Item When Exporting with the Remote UI
<Paper Source Auto Selection>	<Copy>, <Printer>, <Access Stored Files>, <Receive/Fax>, <Other> <Optimal Productivity>*1: <On>, <Off>	Yes	Yes	Yes	No	B	Settings/Registration Basic Information
	• <MP Tray>: <On>, <Off>	Yes	Yes	Yes	No	B	Settings/Registration Basic Information
	• Other: <On>, <Off>	Yes	Yes	Yes	No	B	Settings/Registration Basic Information
	<Copy>: <Consider Color>: <On>, <Off>	Yes	Yes	Yes	No	B	Settings/Registration Basic Information
	<Copy>: <Consider Paper Type>: <On>, <Off>	Yes	Yes	Yes	No	B	Settings/Registration Basic Information
	<Printer>: <Use Group>: <On>, <Off>	Yes	Yes	Yes	No	B	Settings/Registration Basic Information

*1 May not appear on some models.

<Paper Source Auto Selection Based on Color>

 (Settings/Registration) ▶ <Function Settings> ▶ <Common> ▶ <Paper Feed Settings>

The paper drawer to use is automatically set according to the setting in <Select Color> when copying. If the original was scanned with <Auto (Color/B&W)> set, the color mode selected for scanning is used.

Item	Setting Description	DeviceAdmin	NetworkAdmin	Can be set in Remote UI	Device Information Delivery Available	Import All Function	Name of Item When Exporting with the Remote UI
<Paper Source Auto Selection Based on Color>	<MP Tray> and Other: <Color>, <Black & White>	Yes	Yes	Yes	No	No	-

NOTE

- A setting other than <Black & White> is set for <Color>.
- This setting is only valid for copying.
- This setting is only valid when <Consider Color> in <Paper Source Auto Selection> is set to <On>.
- In the following cases, the paper source set in <Color> is automatically selected, regardless of the color mode specified when copying.
 - When the Merge Job Blocks mode is set
 - When the Different Size Originals mode and Job Build mode are set together

<Switch Feed Method>

 (Settings/Registration) ▶ <Function Settings> ▶ <Common> ▶ <Paper Feed Settings>



When regularly using paper with logos such as letterheads, while printing in both one-sided and two-sided, you can set this setting to <Print Side Priority> to print the first page on the front side for both one-sided and two-sided, without having to change the paper orientation.  **Loading Preprinted Paper(P. 60)**

Item	Setting Description	DeviceAdmin	NetworkAdmin	Can be set in Remote UI	Device Information Delivery Available	Import All Function	Name of Item When Exporting with the Remote UI
<Switch Feed Method>	<MP Tray> and Other: <Speed Priority>, <Print Side Priority>	Yes	Yes	Yes	No	B	Settings/Registration Basic Information

IMPORTANT

- The settings for Automatic Paper Selection and Auto Drawer Switching are disabled for paper sources with <Print Side Priority> set. The print speed is also slower when performing one-sided printing.

NOTE

- <Print Side Priority> is only enabled when paper that can be printed on both sides is set ( **Paper Available for 2-Sided Copying/2-Sided Printing(P. 230)**). For other paper, the message <Load paper.> appears and the paper is not fed, or the <Print Side Priority> setting is disabled.
- For instructions on loading paper, see  **Loading Preprinted Paper(P. 60)** .

<Suspended Job Timeout>

 (Settings/Registration) ▶ <Function Settings> ▶ <Common> ▶ <Paper Feed Settings>

If this setting is set to <On> and a job is suspended due to a lack of paper, etc., the machine automatically prints the next job after the specified time period.

Item	Setting Description	DeviceAdmin	NetworkAdmin	Can be set in Remote UI	Device Information Delivery Available	Import All Function	Name of Item When Exporting with the Remote UI
<Suspended Job Timeout>	<On>, <Off>	Yes	Yes	Yes	Yes	C	Settings/Registration Basic Information
	0 to 5 to 999min.	Yes	Yes	Yes	Yes	C	Settings/Registration Basic Information

NOTE

- If a job is suspended because paper has run out during the job, the next job is not processed even after the designated suspension time elapses.
- To automatically delete suspended jobs, see  <Auto Delete Suspended Jobs>(P. 1176) .

<Paper Output Settings>

Specify the Paper Output Settings that are common to all the functions.

- ▶<Output Tray Settings>(P. 1168)
- ▶<Use Optional Output Tray>(P. 1169)
- ▶<Offset Jobs>(P. 1169)
- ▶<Job Separator Between Jobs>(P. 1169)
- ▶<Job Separator Between Copies>(P. 1170)
- ▶<Action When Too Many Sheets to Staple>(P. 1170)
- ▶<Enable Offset for Single-Sheet Print Jobs>(P. 1171)

NOTE

- For information on the items ("A", "B", "C", and "No") in the "Import All Function" column, see ▶<Import All Function>(P. 1054) .

Item marked with an asterisk (*)

- Only appears if you have the option installed.

<Output Tray Settings> *

 (Settings/Registration) ▶ <Function Settings> ▶ <Common> ▶ <Paper Output Settings>

You can set the tray to output to for each function. ▶<Specifying the Output Tray for Preprinted Paper>(P. 81)

Item	Setting Description	DeviceAdmin	NetworkAdmin	Can be set in Remote UI	Device Information Delivery Available	Import All Function	Name of Item When Exporting with the Remote UI
<Output Tray Settings>	<Tray A>: <Copy>, <Access Stored Files>, <Printer>, <Receive>, <Other>, <IP Fax 1>, <Fax 1>, <Fax 2> <Tray B>: <Copy>, <Access Stored Files>, <Printer>, <Receive>, <Other>, <IP Fax 1>, <Fax 1>, <Fax 2> <Tray C>: <Copy>, <Access Stored Files>, <Printer>, <Receive>, <Other>, <IP Fax 1>, <Fax 1>, <Fax 2> <Tray D>*1: <Copy>, <Access Stored Files>, <Printer>, <Receive>, <Other>, <IP Fax 1>, <Fax 1>, <Fax 2>	Yes	Yes	Yes	No	A	Settings/Registration Basic Information

*1 May not appear on some models.

<Use Optional Output Tray> *

 (Settings/Registration) ▶ <Function Settings> ▶ <Common> ▶ <Paper Output Settings>

Specify whether to use the tray of the optional equipment as the output tray.

Item	Setting Description	DeviceAdmin	NetworkAdmin	Can be set in Remote UI	Device Information Delivery Available	Import All Function	Name of Item When Exporting with the Remote UI
<Use Optional Output Tray>	<Output Tray 1>: <On>, <Off> <Output Tray 2>: <On>, <Off>	Yes	No	No	No	A	Settings/Registration Basic Information

NOTE

- The output trays which can be used vary depending on the optional equipment attached, such as the finisher. For more information, see  **Optional Equipment(P. 173)** .

<Offset Jobs> *

 (Settings/Registration) ▶ <Function Settings> ▶ <Common> ▶ <Paper Output Settings>

This enables you to shift the output for each job when multiple jobs are printed consecutively.

Item	Setting Description	DeviceAdmin	NetworkAdmin	Can be set in Remote UI	Device Information Delivery Available	Import All Function	Name of Item When Exporting with the Remote UI
<Offset Jobs>	<On>, <Off>	Yes	Yes	Yes	Yes	C	Settings/Registration Basic Information

<Job Separator Between Jobs>

 (Settings/Registration) ▶ <Function Settings> ▶ <Common> ▶ <Paper Output Settings>

This enables you to insert the specified paper at the start of each job when multiple jobs are printed consecutively.

Item	Setting Description	DeviceAdmin	NetworkAdmin	Can be set in Remote UI	Device Information Delivery Available	Import All Function	Name of Item When Exporting with the Remote UI
<Job Separator Between Jobs>	<On>, <Off>	Yes	Yes	Yes	No	C	Settings/Registration Basic Information
	<Change> (Select Paper Source)	Yes	Yes	Yes	No	C	Settings/Registration Basic Information

<Job Separator Between Copies>

 (Settings/Registration) ▶ <Function Settings> ▶ <Common> ▶ <Paper Output Settings>

This enables you to insert the specified paper each number of copy sets to divide the sets. If you set this, paper is inserted when printing with Collate (Page Order), Offset, or Staple.

Item	Setting Description	DeviceAdmin	NetworkAdmin	Can be set in Remote UI	Device Information Delivery Available	Import All Function	Name of Item When Exporting with the Remote UI
<Job Separator Between Copies>	<On>, <Off>	Yes	Yes	Yes	No	C	Settings/Registration Basic Information
	<Copies> (1 to 10 to 9999)	Yes	Yes	Yes	No	C	Settings/Registration Basic Information
	<Change> (Select Paper Source)	Yes	Yes	Yes	No	C	Settings/Registration Basic Information

IMPORTANT

- You cannot insert job separation sheets between copy sets if you are using the Group, Group Sort, Booklet, Saddle Stitch, or Fold mode. Note that the available functions and papers differ depending on your model and the installed options.

<Action When Too Many Sheets to Staple> *

 (Settings/Registration) ▶ <Function Settings> ▶ <Common> ▶ <Paper Output Settings>

You can specify the procedure to perform when there are too many sheets to staple.

Item	Setting Description	DeviceAdmin	NetworkAdmin	Can be set in Remote UI	Device Information Delivery Available	Import All Function	Name of Item When Exporting with the Remote UI
<Action When Too Many Sheets to Staple>	<Corner/Double>: <Print without Stapling>, <Cancel Printing> <Saddle Stitch>: <Print without Stapling>, <Cancel Printing> <Eco (Staple-Free)>: <Print without Stapling>, <Cancel Printing>	Yes	Yes	No	No	B	Settings/Registration Basic Information

NOTE

- For information on printing using stapling, see  **Finishing with the Stapler(P. 462)** .

<Enable Offset for Single-Sheet Print Jobs> *

 (Settings/Registration) ▶ <Function Settings> ▶ <Common> ▶ <Paper Output Settings>

Specifying <On> in this setting allows you to output single-page print jobs with the sheet offset in the following situations:

- Shift is specified when job is received
- Printing of multiple copies is specified when job is received

Item	Setting Description	DeviceAdmin	NetworkAdmin	Can be set in Remote UI	Device Information Delivery Available	Import All Function	Name of Item When Exporting with the Remote UI
<Enable Offset for Single-Sheet Print Jobs>	<On>, <Off>	Yes	Yes	Yes	No	C	Settings/Registration Basic Information

NOTE

- This setting is disabled for copy jobs.

<Print Settings>

Specify the Print Settings that are common to all the functions.

- ▶ <Print Priority>(P. 1172)
- ▶ <Text/Photo Priority When Recognized as B&W by ACS>(P. 1172)
- ▶ <Conversion Color by Specific Color for Two Colors Print>(P. 1173)
- ▶ <Output Report Default Settings>(P. 1174)
- ▶ <Register Characters for Page Numbering/ Watermark>(P. 1174)
- ▶ <Copy Set Numbering Option Settings>(P. 1174)
- ▶ <Forced Print of Recognition Information>(P. 1175)
- ▶ <Secure Watermark Settings>(P. 1176)
- ▶ <Quickly Exit Sleep Mode for Print Job>(P. 1176)
- ▶ <Auto Delete Suspended Jobs>(P. 1176)
- ▶ <Speed/Image Quality Priority for Superfine (1200 dpi)>(P. 1177)

NOTE

- For information on the items ("A", "B", "C", and "No") in the "Import All Function" column, see ▶ **Import All Function(P. 1054)** .

<Print Priority>

 (Settings/Registration) ▶ <Function Settings> ▶ <Common> ▶ <Print Settings>

A job that has a higher set priority can be set to print after the job currently being processed is complete.

Item	Setting Description	DeviceAdmin	NetworkAdmin	Can be set in Remote UI	Device Information Delivery Available	Import All Function	Name of Item When Exporting with the Remote UI
<Print Priority>	<Copy>: 1, 2, 3	Yes	Yes	Yes	Yes	C	Settings/Registration Basic Information
	<Printer>: 1, 2, 3	Yes	Yes	Yes	Yes	C	Settings/Registration Basic Information
	<Access Stored File>, <Receive/Fax>, <Other>: 1, 2, 3	Yes	Yes	Yes	Yes	C	Settings/Registration Basic Information

NOTE

- If the same printing priority has been specified for multiple functions, printing starts with the first processed print job.
- Priority printing does not take place until the current job is complete. However, if the current job is paused, the printing of another job may start, depending on its settings.

<Text/Photo Priority When Recognized as B&W by ACS>

 (Settings/Registration) ▶ <Function Settings> ▶ <Common> ▶ <Print Settings>

You can set the quality to use when an original is detected to be black-and-white with auto color selection.

Item	Setting Description	DeviceAdmin	NetworkAdmin	Can be set in Remote UI	Device Information Delivery Available	Import All Function	Name of Item When Exporting with the Remote UI
<Text/Photo Priority When Recognized as B&W by ACS>	<Text Priority>, <Photo Priority>	Yes	Yes	Yes	Yes	B	Settings/Registration Basic Information

NOTE

- If you set <Text Priority> in this setting and your original is determined as black-and-white by the <Auto (Color/B&W)> mode in <Select Color>, the original is processed as if you selected <Text> as the original type setting, even if you select a mode other than <Text> for <Original Type> in <Copy>.

<Conversion Color by Specific Color for Two Colors Print>

 (Settings/Registration) ▶ <Function Settings> ▶ <Common> ▶ <Print Settings>



You can select the specified color to use when printing using the two-color mode, which prints in black and a specified color. The two-color mode can be set for copying or printing. This setting is reflected in both the two-color mode for printing and the two-color mode for copying.

- All Chromatic Colors: When specifying the color to use for all chromatic colors other than black in the original (or image data).
- Approximate Colors Only: When using the color for only the specified color (or approximate color) and using black for all other chromatic colors in the original (or image data).

■ Example Replaced Colors and Settings

When the two-color mode is specified for an original (or image data) including the following colors, the colors are replaced as indicated below.

- Colors included in the original (or image data): Red, orange, blue, black
- Red specified for the two-color mode

Original (or image data)	"All Chromatic Colors"	"Approximate Colors Only"
		
Red	Red	Red
Orange	Red	Red
Blue	Red	Black
Black	Black	Black

Item	Setting Description	DeviceAdmin	NetworkAdmin	Can be set in Remote UI	Device Information Delivery Available	Import All Function	Name of Item When Exporting with the Remote UI
<Conversion Color by Specific Color for Two Colors Print>	<All Chromatic Colors>, <Approximate Colors Only>	Yes	Yes	Yes	No	C	Settings/Registration Basic Information

<Output Report Default Settings>

 (Settings/Registration) ▶ <Function Settings> ▶ <Common> ▶ <Print Settings>

Specify the default settings used when reports such as the TX Report and Communication Management Report are printed.

 <Output Report Default Settings>(P. 1178)



<Register Characters for Page Numbering/Watermark>

 (Settings/Registration) ▶ <Function Settings> ▶ <Common> ▶ <Print Settings>

You can register/edit/delete user-defined text for <Page Numbering>/<Watermark>. It is useful if you always use the same text or watermark for <Watermark> in <Secure Watermark>, and <Page Numbering> and <Watermark> in the Copy/User Inbox function.

Item	Setting Description	DeviceAdmin	NetworkAdmin	Can be set in Remote UI	Device Information Delivery Available	Import All Function	Name of Item When Exporting with the Remote UI
<Register Characters for Page Numbering/Watermark>	<Register>, <Edit>, <Delete>	Yes	Yes	Yes	Yes	C	Settings/Registration Basic Information

NOTE

- For information on <Watermark> in <Secure Watermark>, and <Page Numbering> and <Watermark>, see  **Attaching Numbers and Symbols to Copies(P. 465)** and  **Embedding the "TOP SECRET" Text (Secure Watermark)(P. 510)** .
- You can register up to 30 user-defined text strings for watermarks and page numbers.

<Copy Set Numbering Option Settings>

 (Settings/Registration) ▶ <Function Settings> ▶ <Common> ▶ <Print Settings>

In addition to Copy Set Numbering, you can add User Name, Date, and Text on the printout.

Item	Setting Description	DeviceAdmin	NetworkAdmin	Can be set in Remote UI	Device Information Delivery Available	Import All Function	Name of Item When Exporting with the Remote UI
<Copy Set Numbering Option Settings>	Select Option	Yes	No	Yes	Yes	B	Settings/Registration Basic Information

Settings/Registration

Item	Setting Description	DeviceAdmin	NetworkAdmin	Can be set in Remote UI	Device Information Delivery Available	Import All Function	Name of Item When Exporting with the Remote UI
	<Number Option>: <On>, <Off>						
	<ul style="list-style-type: none"> <ID/User Name>: <On>, <Off> <Date>: <On>, <Off> <Text>: <On>, <Off> 	Yes	No	Yes	Yes	B	Settings/Registration Basic Information
	Date Settings (<dd/mm/yyyy>, <yyyy/mm/dd>, <mm/dd/yyyy>, <yyyy.mm.dd>, <mm.dd.yyyy>, <dd.mm.yyyy>)	Yes	No	Yes	Yes	B	Settings/Registration Basic Information
	Set Characters (<Enter>, Select from the registered characters)	Yes	No	Yes	Yes	B	Settings/Registration Basic Information
	Alignment Settings (<Align Left>, <Align Center>, <Align Right>)	Yes	No	Yes	Yes	B	Settings/Registration Basic Information

<Forced Print of Recognition Information>

 (Settings/Registration) ▶ <Function Settings> ▶ <Common> ▶ <Print Settings>

You can force to print the user ID, date, IP address, or serial number of the machine on the printout.  **Printing User Information on Documents(P. 891)**

Item	Setting Description	DeviceAdmin	NetworkAdmin	Can be set in Remote UI	Device Information Delivery Available	Import All Function	Name of Item When Exporting with the Remote UI
<Forced Print of Recognition Information>	<On>, <Off>	Yes	No	Yes	No	B	Settings/Registration Basic Information
	<Target Function>: <Copy> (<On>, <Off>), <Printer> (<On>, <Off>), <Access Stored Files> (<On>, <Off>)	Yes	No	Yes	No	B	Settings/Registration Basic Information
	<Position>: <Top Left>, <Top Right>, <Bottom Left>, <Bottom Right>	Yes	No	Yes	No	B	Settings/Registration Basic Information

Item	Setting Description	DeviceAdmin	NetworkAdmin	Can be set in Remote UI	Device Information Delivery Available	Import All Function	Name of Item When Exporting with the Remote UI
	<Orig Content Orient.>: <Upright Image>, <Sideways Image>	Yes	No	Yes	No	B	Settings/Registration Basic Information
	<Set Details>	Yes	No	Yes	No	B	Settings/Registration Basic Information

NOTE

- IPv6 addresses cannot be printed.

<Secure Watermark Settings>

 (Settings/Registration) ▶ <Function Settings> ▶ <Common> ▶ <Print Settings>

Specify the settings for the Secure Watermark function.

 <Secure Watermark Settings>(P. 1176)

<Quickly Exit Sleep Mode for Print Job>

 (Settings/Registration) ▶ <Function Settings> ▶ <Common> ▶ <Print Settings>

If you perform LPD/RAW printing while the machine is in sleep mode, it may take some time to start printing. If this setting is set to <On>, this time can be reduced.

Item	Setting Description	DeviceAdmin	NetworkAdmin	Can be set in Remote UI	Device Information Delivery Available	Import All Function	Name of Item When Exporting with the Remote UI
<Quickly Exit Sleep Mode for Print Job>	<On>, <Off>	Yes	No	Yes	No	C	Settings/Registration Basic Information

<Auto Delete Suspended Jobs>

 (Settings/Registration) ▶ <Function Settings> ▶ <Common> ▶ <Print Settings>

If this setting is set to <On> and a job is suspended due to a paper jam, etc., the machine automatically deletes the job after the specified time period.

Item	Setting Description	DeviceAdmin	NetworkAdmin	Can be set in Remote UI	Device Information Delivery Available	Import All Function	Name of Item When Exporting with the Remote UI
<Auto Delete Suspended Jobs>	<On>, <Off>	No	No	Yes	No	C	Settings/Registration Basic Information
	0 to 5 to 999 min.	No	No	Yes	No	C	Settings/Registration Basic Information

NOTE

- To retain a suspended job without automatically deleting it, see  <Suspended Job Timeout>(P. 1167) .

<Speed/Image Quality Priority for Superfine (1200 dpi)>

 (Settings/Registration) ▶ <Function Settings> ▶ <Common> ▶ <Print Settings>

This item specifies whether to give priority to speed or image quality when printing in Superfine.

Item	Setting Description	DeviceAdmin	NetworkAdmin	Can be set in Remote UI	Device Information Delivery Available	Import All Function	Name of Item When Exporting with the Remote UI
<Speed/Image Quality Priority for Superfine (1200 dpi)>	<Speed Priority>, <Quality Priority>	Yes	Yes	Yes	No	B	Settings/Registration Basic Information

<Output Report Default Settings>

Specify the default settings used when reports such as the TX Report and Communication Management Report are printed.

NOTE

- For information on the items ("A", "B", "C", and "No") in the "Import All Function" column, see [Import All Function\(P. 1054\)](#) .

<2-Sided Printing>

 (Settings/Registration) ▶ <Function Settings> ▶ <Common> ▶ <Print Settings> ▶ <Output Report Default Settings>

Specify whether to print the report on both sides of the paper.

Item	Setting Description	DeviceAdmin	NetworkAdmin	Can be set in Remote UI	Device Information Delivery Available	Import All Function	Name of Item When Exporting with the Remote UI
<2-Sided Printing>	<On>, <Off>	Yes	Yes	Yes	Yes	C	Settings/Registration Basic Information

<Secure Watermark Settings>

Specify the settings for the Secure Watermark function.

- ▶<Forced Secure Watermark>(P. 1179)
- ▶<Printer Driver Secure Watermark>(P. 1179)
- ▶<Adjust Background/Character Contrast>(P. 1180)

NOTE

- For information on the items ("A", "B", "C", and "No") in the "Import All Function" column, see ▶<Import All Function>(P. 1054) .

<Forced Secure Watermark>

 (Settings/Registration) ▶ <Function Settings> ▶ <Common> ▶ <Print Settings> ▶ <Secure Watermark Settings>

Secure Watermark enables you to prevent information leakage. These functions can be set by administrator so that it is always reflected on the output by the general users. ▶<Embedding Invisible Text (Forced Secure Watermark)>(P. 893)

Item	Setting Description	DeviceAdmin	NetworkAdmin	Can be set in Remote UI	Device Information Delivery Available	Import All Function	Name of Item When Exporting with the Remote UI
<Forced Secure Watermark>	<Copy>, <Access Stored Files>, <Printer>: <Do Not Set>, <Set>	Yes	No	Yes	No	C	Settings/Registration Basic Information

<Printer Driver Secure Watermark>

 (Settings/Registration) ▶ <Function Settings> ▶ <Common> ▶ <Print Settings> ▶ <Secure Watermark Settings>

When printing from a printer driver, you can select the functions set here for each job.

Item	Setting Description	DeviceAdmin	NetworkAdmin	Can be set in Remote UI	Device Information Delivery Available	Import All Function	Name of Item When Exporting with the Remote UI
<Printer Driver Secure Watermark>	<Do Not Set>, <Set>	Yes	No	Yes	No	C	Settings/Registration Basic Information

IMPORTANT

- If <Printer Driver Secure Watermark> and <Forced Secure Watermark> are set for a printer at the same time, Forced Secure Watermark is given priority.

NOTE

- If a login service has been set, the user name/Department ID of the user who logged in is printed.
- The watermark <CONFIDENTIAL> is printed if a login service is not set.
- To use this function, specify the following settings in the printer driver in advance. For details, see the help for the printer driver.

<Adjust Background/Character Contrast>

 (Settings/Registration) ▶ <Function Settings> ▶ <Common> ▶ <Print Settings> ▶ <Secure Watermark Settings>

Adjusts the relative contrast of the hidden text and the background. The Secure Watermark effect can be tested by making a copy of a sample print. The following settings are specified here.

- <Relative Contrast>: Adjusts the relative contrast of the hidden text and the background.
- <Standard Value Settings>: Sets the density of the background.
- <Latent Area Density>: Sets the density of the text.

For C3900 Series

After pressing <Adjust Background/Character Contrast>, select <Standard> or <For Printer 1200 dpi> as the setting.

Item	Setting Description	DeviceAdmin	NetworkAdmin	Can be set in Remote UI	Device Information Delivery Available	Import All Function	Name of Item When Exporting with the Remote UI
<Black>	<Relative Contrast> <ul style="list-style-type: none"> • If you select <Standard>: -7 to -2 to +7 • If you select <For Printer 1200 dpi>: -7 to -2 to +7 	Yes	No	No	No	A	Settings/Registration Basic Information
	<Sample Print>	Yes	No	No	No	No	-
	<ul style="list-style-type: none"> • <Print Settings> <Background Pattern>: <None>, <Arabesque>, <Fans>, <Polka Dots>, <Stars>, <Mesh>, <Clouds>, <Cherry Blossoms>, <Leaves> 	Yes	No	No	No	No	-
	<ul style="list-style-type: none"> • <Print Settings> <Size>: <Small>, <Medium>, <Large> 	Yes	No	No	No	No	-
	<ul style="list-style-type: none"> • <Print Settings> <Print Vertically>: <On>, <Off> 	Yes	No	No	No	No	-
	<ul style="list-style-type: none"> • <Print Settings> <White Letters on Colored Background>: <On>, <Off> 	Yes	No	No	No	No	-

Settings/Registration

Item	Setting Description	DeviceAdmin	NetworkAdmin	Can be set in Remote UI	Device Information Delivery Available	Import All Function	Name of Item When Exporting with the Remote UI
	<Initialize>: <Yes>, <No>	Yes	No	No	No	No	-
	<Standard Value Settings> <ul style="list-style-type: none"> If you select <Standard>: 1 to 28 to 64 If you select <For Printer 1200 dpi>: 1 to 28 to 64 	Yes	No	No	No	A	Settings/Registration Basic Information
	<Latent Area Density> <ul style="list-style-type: none"> If you select <Standard>: 1 to 13 to 36 If you select <For Printer 1200 dpi>: 1 to 13 to 36 	Yes	No	No	No	A	Settings/Registration Basic Information
<Cyan>	<Relative Contrast> <ul style="list-style-type: none"> If you select <Standard>: -7 to -2 to +7 If you select <For Printer 1200 dpi>: -7 to -2 to +7 	Yes	No	No	No	A	Settings/Registration Basic Information
	<Sample Print>	Yes	No	No	No	No	-
	<ul style="list-style-type: none"> <Print Settings> <Background Pattern>: <None>, <Arabesque>, <Fans>, <Polka Dots>, <Stars>, <Mesh>, <Clouds>, <Cherry Blossoms>, <Leaves> 	Yes	No	No	No	No	-
	<ul style="list-style-type: none"> <Print Settings> <Size>: <Small>, <Medium>, <Large> 	Yes	No	No	No	No	-
	<ul style="list-style-type: none"> <Print Settings> <Print Vertically>: <On>, <Off> 	Yes	No	No	No	No	-
	<ul style="list-style-type: none"> <Print Settings> <White Letters on Colored Background>: <On>, <Off> 	Yes	No	No	No	No	-
	<Initialize>: <Yes>, <No>	Yes	No	No	No	No	-
	<Standard Value Settings> <ul style="list-style-type: none"> If you select <Standard>: 1 to 28 to 64 If you select <For Printer 1200 dpi>: 1 to 28 to 64 	Yes	No	No	No	A	Settings/Registration Basic Information
	<Latent Area Density> <ul style="list-style-type: none"> If you select <Standard>: 1 to 15 to 36 If you select <For Printer 1200 dpi>: 1 to 15 to 36 	Yes	No	No	No	A	Settings/Registration Basic Information

Settings/Registration

Item	Setting Description	DeviceAdmin	NetworkAdmin	Can be set in Remote UI	Device Information Delivery Available	Import All Function	Name of Item When Exporting with the Remote UI
<Magenta>	<Relative Contrast> <ul style="list-style-type: none"> If you select <Standard>: -7 to -1 to +7 If you select <For Printer 1200 dpi>: -7 to -1 to +7 	Yes	No	No	No	A	Settings/Registration Basic Information
	<Sample Print>	Yes	No	No	No	No	-
	<Print Settings> <Background Pattern>: <None> , <Arabesque>, <Fans>, <Polka Dots>, <Stars>, <Mesh>, <Clouds>, <Cherry Blossoms>, <Leaves>	Yes	No	No	No	No	-
	<Print Settings> <Size>: <Small>, <Medium> , <Large>	Yes	No	No	No	No	-
	<Print Settings> <Print Vertically>: <On>, <Off>	Yes	No	No	No	No	-
	<Print Settings> <White Letters on Colored Background>: <On>, <Off>	Yes	No	No	No	No	-
	<Initialize>: <Yes>, <No>	Yes	No	No	No	No	-
	<Standard Value Settings> <ul style="list-style-type: none"> If you select <Standard>: 1 to 24 to 64 If you select <For Printer 1200 dpi>: 1 to 24 to 64 	Yes	No	No	No	A	Settings/Registration Basic Information
	<Latent Area Density> <ul style="list-style-type: none"> If you select <Standard>: 1 to 14 to 36 If you select <For Printer 1200 dpi>: 1 to 14 to 36 	Yes	No	No	No	A	Settings/Registration Basic Information

IMPORTANT

- Load A3, A4, LTR, or 11" x 17" size plain or heavy paper when making sample prints.

NOTE

Sample Print

- The sample print includes the hidden text and the background for each relative contrast value.
- The area within the frame on the sample print is the output sample for the currently set relative contrast value.

Relative Contrast

- Adjust the relative contrast while comparing the difference between the set standard value and the current latent area density, by referring to the sample print.
- If you increase the value for the relative contrast, the background gets denser, and if you decrease the value, the background gets lighter. When you select <White Letters on Colored Bkground.>, if you increase the value for the relative contrast, the text becomes denser, and if you decrease the value, the text becomes lighter.

<Print Settings>

- If you select <White Letters on Colored Bkground.>, set the standard value for the density of the text and the latent area density for the density of the background.

<Standard Value Settings>

- If you increase the value for the standard value, the background gets denser, and if you decrease the value, the background gets lighter. When <White Letters on Colored Bkground.> is selected, if you increase the standard value, the text gets denser, and if you decrease the value, the text gets lighter.
- When changing the adjustment area on the sample print for the relative contrast, specify settings for <Standard Value Settings>.
- If you changed the standard value, adjust <Latent Area Density> so that the density of the inner square set in the standard value for the standard value sample print gets closer.
- To set a background density that differs from the most even secure watermark image in the standard value sample print, it is necessary to adjust <Latent Area Density> to a density close to the background density.

<Latent Area Density>

- If you increase the value for <Latent Area Density>, the text becomes denser, and if you decrease the value, the text becomes lighter. When <White Letters on Colored Bkground.> is selected, if you increase the value in <Latent Area Density>, the background gets denser, and if you decrease the value, the background gets lighter.

<Scan Settings>

Specify the Scan Settings that are common to all the functions.

- ▶<Timing to Raise Feeder Tray>(P. 1184)
- ▶<Feeder Jam Recovery Method>(P. 1184)
- ▶<Set Detection of Feeder Multi. Sheet Feed as Default>(P. 1185)
- ▶<Scanner Noise Settings>(P. 1185)
- ▶<Streak Prevention>(P. 1186)
- ▶<Speed/Image Quality Priority for B&W Scan>(P. 1186)
- ▶<LTRR/STMT Original Selection>(P. 1186)
- ▶<Remote Scan Gamma Value>(P. 1187)
- ▶<Auto Online>(P. 1187)
- ▶<Auto Offline>(P. 1188)
- ▶<Auto Set Different Size Originals When Using Feeder>(P. 1188)
- ▶<Original Thickness Defaults for Scan from Feeder>(P. 1189)

NOTE

- For information on the items ("A", "B", "C", and "No") in the "Import All Function" column, see ▶<Import All Function>(P. 1054) .

<Timing to Raise Feeder Tray>

 (Settings/Registration) ▶ <Function Settings> ▶ <Common> ▶ <Scan Settings>

You can select the timing for raising the feeder tray when scanning originals using functions such as Scan and Store, and Copy.

Item	Setting Description	DeviceAdmin	NetworkAdmin	Can be set in Remote UI	Device Information Delivery Available	Import All Function	Name of Item When Exporting with the Remote UI
<Timing to Raise Feeder Tray>	<When Start Is Pressed>, <When Original Is Placed>	Yes	Yes	Yes	No	B	Settings/Registration Basic Information

NOTE

- This item only appears if the 2-Sided Single Pass Feeder is installed.

<Feeder Jam Recovery Method>

 (Settings/Registration) ▶ <Function Settings> ▶ <Common> ▶ <Scan Settings>

You can select whether scanning will start again from the first page of the original or the page of the original in which scanning was interrupted if a paper jam occurs in the feeder.

Item	Setting Description	DeviceAdmin	NetworkAdmin	Can be set in Remote UI	Device Information Delivery Available	Import All Function	Name of Item When Exporting with the Remote UI
<Feeder Jam Recovery Method>	<From 1st Page>, <From Suspnd. Original>	Yes	Yes	Yes	No	B	Settings/Registration Basic Information

IMPORTANT





- Direct sending of faxes does not support this setting. If a paper jam occurs while performing direct sending, the job will be canceled. In this case, set the job again.
- Depending on the location of a paper jam, it can be difficult to determine whether document scanning has been completed. If you have set <From Suspnd. Original> for <Feeder Jam Recovery Method> and you do not find until which page the document has been scanned, it is recommended that you cancel the job, and then execute it again.

NOTE

- Select one of the following.
 - <From 1st Page>: Place the originals in the feeder again, and then restart scanning from the first page of the document. The originals will be fed automatically until the page of the document in which scanning is interrupted.
 - <From Suspended Original>: Place the originals that were not scanned because of a paper jam in the feeder, and then start scanning all the remaining originals again.

<Set Detection of Feeder Multi. Sheet Feed as Default>

 (Settings/Registration) ▶ <Function Settings> ▶ <Common> ▶ <Scan Settings>

You can specify the default setting of <Detect Feeder Multi Sheet Fd.> for each function.  **Basic Copy Operations(P. 420)**  **Basic Operations for Scanning Originals(P. 640)**  **Sending I-Faxes(P. 583)**  **Basic Operations for Sending Faxes(P. 524)**

Item	Setting Description	DeviceAdmin	NetworkAdmin	Can be set in Remote UI	Device Information Delivery Available	Import All Function	Name of Item When Exporting with the Remote UI
<Set Detection of Feeder Multi. Sheet Feed as Default>	<On>, <Off>	Yes	Yes	Yes	No	C	Settings/Registration Basic Information

NOTE

- This item only appears if the 2-Sided Single Pass Feeder is installed.

<Scanner Noise Settings>

 (Settings/Registration) ▶ <Function Settings> ▶ <Common> ▶ <Scan Settings>

You can set whether priority is given to scanning speed or to noise reduction when the original is scanned from the feeder.

Item	Setting Description	DeviceAdmin	NetworkAdmin	Can be set in Remote UI	Device Information Delivery Available	Import All Function	Name of Item When Exporting with the Remote UI
<Scanner Noise Settings>	<Speed Priority>, <Quiet>	Yes	Yes	Yes	No	B	Settings/Registration Basic Information

<Streak Prevention>

 (Settings/Registration) ▶ <Function Settings> ▶ <Common> ▶ <Scan Settings>

You can set whether to detect and prevent streaks when scanning originals.

Item	Setting Description	DeviceAdmin	NetworkAdmin	Can be set in Remote UI	Device Information Delivery Available	Import All Function	Name of Item When Exporting with the Remote UI
<Streak Prevention>	<On>, <Off>	Yes	Yes	Yes	No	B	Settings/Registration Basic Information

NOTE

- When <On> is selected, extremely thin lines may be detected as streaks.

<Speed/Image Quality Priority for B&W Scan>

 (Settings/Registration) ▶ <Function Settings> ▶ <Common> ▶ <Scan Settings>

You can set whether priority is given to scanning speed or to image quality when performing black and white scanning.

Item	Setting Description	DeviceAdmin	NetworkAdmin	Can be set in Remote UI	Device Information Delivery Available	Import All Function	Name of Item When Exporting with the Remote UI
<Speed/Image Quality Priority for B&W Scan>	<Fax/I-Fax Send Jobs>: <Speed Priority>, <Quality Priority> <All Send Jobs Except Fax/I-Fax Jobs>: <Speed Priority>, <Quality Priority>	Yes	Yes	Yes	No	B	Settings/Registration Basic Information

<LTRR/STMT Original Selection>

 (Settings/Registration) ▶ <Function Settings> ▶ <Common> ▶ <Scan Settings>

You can forcibly designate the way the machine handles LTRR and STMT originals that are placed on the platen glass.

Item	Setting Description	DeviceAdmin	NetworkAdmin	Can be set in Remote UI	Device Information Delivery Available	Import All Function	Name of Item When Exporting with the Remote UI
<LTRR/STMT Original Selection>	<Select Manually>, <Use LTRR Format >, <Use STMT Format>	Yes	Yes	Yes	Yes	B	Settings/Registration Basic Information

<Remote Scan Gamma Value>

 (Settings/Registration) ▶ <Function Settings> ▶ <Common> ▶ <Scan Settings>

You can set the gamma value to use when scanning color documents into your computer through the Network Scan function. Select the gamma value most suited to your computer settings so that you can print the document with the optimal density.

Item	Setting Description	DeviceAdmin	NetworkAdmin	Can be set in Remote UI	Device Information Delivery Available	Import All Function	Name of Item When Exporting with the Remote UI
<Remote Scan Gamma Value>	<Gamma 1.0>, <Gamma 1.4>, < Gamma 1.8 >, <Gamma 2.2>	Yes	Yes	Yes	Yes	B	Settings/Registration Basic Information

<Auto Online>

 (Settings/Registration) ▶ <Function Settings> ▶ <Common> ▶ <Scan Settings>

Set this to <On> to automatically enable the remote scanner function when you press <Scanner> ( <Home> Screen(P. 332)).

Item	Setting Description	DeviceAdmin	NetworkAdmin	Can be set in Remote UI	Device Information Delivery Available	Import All Function	Name of Item When Exporting with the Remote UI
<Auto Online>	<On>, < Off >	Yes	No	No	Yes	C	Settings/Registration Basic Information

IMPORTANT

- When the remote scanner function is enabled, you cannot use <Copy> and <Scan and Store>.

NOTE

- You can specify the time period in which you are logged out and the touch panel display returns to the default setting automatically.

<Auto Offline>

 (Settings/Registration) ▶ <Function Settings> ▶ <Common> ▶ <Scan Settings>

If the machine is connected to a network that is online, scanning is not possible with <Copy> or <Scan and Store>. If you set <Auto Offline> to <On>, the machine automatically goes offline when the time set in <Auto Reset Time> in <Preferences> (Settings/Registration) has elapsed.

Item	Setting Description	DeviceAdmin	NetworkAdmin	Can be set in Remote UI	Device Information Delivery Available	Import All Function	Name of Item When Exporting with the Remote UI
<Auto Offline>	<On>, <Off>	Yes	No	No	Yes	C	Settings/Registration Basic Information

NOTE

- If <Auto Reset Time> is set to <0>, the machine automatically goes offline after approximately two minutes.
- You can specify the time period in which you are logged out and the touch panel display returns to the default setting automatically.

<Auto Set Different Size Originals When Using Feeder>

 (Settings/Registration) ▶ <Function Settings> ▶ <Common> ▶ <Scan Settings>

You can set whether to automatically use the Different Size Originals mode when scanning with the feeder.

Item	Setting Description	DeviceAdmin	NetworkAdmin	Can be set in Remote UI	Device Information Delivery Available	Import All Function	Name of Item When Exporting with the Remote UI
<Auto Set Different Size Originals When Using Feeder>	<Scan and Store (Mail Box)/Copy>: <On>, <Off> <Scan and Store (Excluding Mail Box)/Send>: <On>, <Off> <Fax>: <On>, <Off>	Yes	Yes	Yes	No	A	Settings/Registration Basic Information

IMPORTANT

- You cannot combine all of the following modes at the same time.
 - <Different Size Originals>
 - <Shift>
 - <Select Paper>:<Auto>

NOTE

- The N on 1, Booklet, Perfect Binding, and Repeat Images modes are processed with the paper size detected by the feeder for the first page.

<Original Thickness Defaults for Scan from Feeder>

 (Settings/Registration) ▶ <Function Settings> ▶ <Common> ▶ <Scan Settings>

You can set to use one of two modes when scanning with the feeder: using a fixed paper weight or enabling the user to specify the paper weight each time.

Item	Setting Description	DeviceAdmin	NetworkAdmin	Can be set in Remote UI	Device Information Delivery Available	Import All Function	Name of Item When Exporting with the Remote UI
<Original Thickness Defaults for Scan from Feeder>	<Fixed><Thin (63 g/m2 or less)>, <Normal>, <Thick (158 g/m2 or more)>, <Always Specify>	Yes	Yes	Yes	No	B	Settings/Registration Basic Information

NOTE

- This item only appears if the 2-Sided Single Pass Feeder is installed.

<Generate File>

Specify the Generate File settings that are common to all the functions.

- ▶ <Image Quality Level for Limited Color/Compact>(P. 1190)
- ▶ <PDF (Limited Color) Resolution Settings>(P. 1190)
- ▶ <OCR (Text Searchable) Settings>(P. 1191)
- ▶ <Trace & Smooth Settings>(P. 1191)
- ▶ <OOXML Settings>(P. 1192)
- ▶ <Include Background Images in Word File>(P. 1193)
- ▶ <Specify Minimum PDF Version>(P. 1193)
- ▶ <Format PDF to PDF/A>(P. 1193)
- ▶ <Optimize PDF for Web>(P. 1194)
- ▶ <256-bit AES Settings for Encrypted PDF>(P. 1194)

NOTE

- For information on the items ("A", "B", "C", and "No") in the "Import All Function" column, see ▶ **Import All Function(P. 1054)** .

<Image Quality Level for Limited Color/Compact>

 (Settings/Registration) ▶ <Function Settings> ▶ <Common> ▶ <Generate File>

When using <Scan and Send> or <Scan and Store>, you can set the image quality level in the file format when PDF(Compact/Low Color) or XPS(Compact) is selected.

Item	Setting Description	DeviceAdmin	NetworkAdmin	Can be set in Remote UI	Device Information Delivery Available	Import All Function	Name of Item When Exporting with the Remote UI
<Image Quality Level for Limited Color/Compact>	<Data Size Priority>, <Normal>, <Quality Priority>	Yes	Yes	Yes	Yes	C	Settings/Registration Basic Information

IMPORTANT

- This setting is disabled when sending a fax or I-fax.
- If you set both <OCR (European Languages)> and <Compact> for the file format, this setting is disabled.

NOTE

- If you scan an original with many colors when <Text> is selected for the original type, the data size and image quality will vary following compression, according to the selected image level. However, if the original is in monochrome or has few colors, it does not matter which image level you select.

<PDF (Limited Color) Resolution Settings>

 (Settings/Registration) ▶ <Function Settings> ▶ <Common> ▶ <Generate File>

If you select PDF (Low Color) as the file format when using <Scan and Send> or <Scan and Store>, you can create a smaller PDF file by lowering the resolution.

Item	Setting Description	DeviceAdmin	NetworkAdmin	Can be set in Remote UI	Device Information Delivery Available	Import All Function	Name of Item When Exporting with the Remote UI
<PDF (Limited Color) Resolution Settings>	<100x100 dpi>, <200x200 dpi>, <300x300 dpi>	Yes	Yes	Yes	Yes	C	Settings/Registration Basic Information

NOTE

- This function is applied when <Original Type> is set to <Text>, even if <Image Quality Level for Limited Color/Compact> is set to <Quality Priority>.  <Image Quality Level for Limited Color/Compact>(P. 1190)

<OCR (Text Searchable) Settings>

 (Settings/Registration) ▶ <Function Settings> ▶ <Common> ▶ <Generate File>

If you select <OCR (Text Searchable)> for <PDF>, <XPS>, or <OOXML> as the file format, you can set the Smart Scan setting, and set the number of characters used for the Auto (OCR) in File Name. Smart Scan is a mode that determines the text direction and rotates the data, so that the document will be in the correct orientation when viewing the document on a computer. Auto (OCR) in File Name is a mode that automatically uses the first text scanned by OCR in the document as its file name. Auto (OCR) in File Name is specified in <File Name> in <Options> on the Scan and Send screen.  **Setting a File Name(P. 693)**

Item	Setting Description	DeviceAdmin	NetworkAdmin	Can be set in Remote UI	Device Information Delivery Available	Import All Function	Name of Item When Exporting with the Remote UI
<OCR (Text Searchable) Settings>	<Smart Scan>: <On>, <Off>	Yes	Yes	Yes	Yes	C	Settings/Registration Basic Information
	<Max Number of Char. for File Name>: 1 to 24	Yes	Yes	Yes	Yes	C	Settings/Registration Basic Information

NOTE

- You cannot use the Auto (OCR) in File Name mode and the Encrypted PDF mode at the same time when sending a file.

<Trace & Smooth Settings>

 (Settings/Registration) ▶ <Function Settings> ▶ <Common> ▶ <Generate File>

You can change the recognition rate of line drawings of the original when creating a file with outline graphics.

Item	Setting Description	DeviceAdmin	NetworkAdmin	Can be set in Remote UI	Device Information Delivery Available	Import All Function	Name of Item When Exporting with the Remote UI
<Trace & Smooth Settings>	<Outline Graphics>: <On>, <Off>	Yes	Yes	Yes	Yes	C	Settings/Registration Basic Information
	<Graphics Recognition Level>: <Normal>, <Moderate>, <High>	Yes	Yes	Yes	Yes	C	Settings/Registration Basic Information
	<Background Image Level>: <Data Size Priority>, <Normal>, <Quality Priority>	Yes	Yes	Yes	Yes	C	Settings/Registration Basic Information

NOTE

- If you increase the value in <Graphics Recognition Level>, the data size also increases. It is recommended that you first use <Normal>, and if desirable results are not obtained, try increasing the recognition level to <Moderate> or <High>.
- This setting is disabled when sending a fax or I-fax.

<OOXML Settings>

 (Settings/Registration) ▶ <Function Settings> ▶ <Common> ▶ <Generate File>

You can specify the background image level, color image recognition level, and color image line width recognition when creating files with Office Open XML file format.

Item	Setting Description	DeviceAdmin	NetworkAdmin	Can be set in Remote UI	Device Information Delivery Available	Import All Function	Name of Item When Exporting with the Remote UI
<OOXML Settings>	<Background Image Level>: <Quality Priority>, <Standard>, <Data Size Priority>	Yes	Yes	Yes	Yes	C	Settings/Registration Basic Information
	<Color Image Recognition Level>: <High>, <Standard>, <Do Not Recognize>	Yes	Yes	Yes	Yes	C	Settings/Registration Basic Information
	<Color Image Line Width Recognition>: <On>, <Off>	Yes	Yes	Yes	Yes	C	Settings/Registration Basic Information

NOTE

- This setting is disabled when sending a fax or I-fax.
- Color image settings are only valid with PowerPoint.

<Include Background Images in Word File>

 (Settings/Registration) ▶ <Function Settings> ▶ <Common> ▶ <Generate File>

When generating Word files from scanned originals, you can delete the image detected as the background in the Word files. It becomes easier to edit Word files because unnecessary images are deleted.

Item	Setting Description	DeviceAdmin	NetworkAdmin	Can be set in Remote UI	Device Information Delivery Available	Import All Function	Name of Item When Exporting with the Remote UI
<Include Background Images in Word File>	<On>, <Off>	Yes	Yes	Yes	No	C	Settings/Registration Basic Information

<Specify Minimum PDF Version>

 (Settings/Registration) ▶ <Function Settings> ▶ <Common> ▶ <Generate File>

You can specify the minimum version to assign when generating PDF files.

Item	Setting Description	DeviceAdmin	NetworkAdmin	Can be set in Remote UI	Device Information Delivery Available	Import All Function	Name of Item When Exporting with the Remote UI
<Specify Minimum PDF Version>	<Do Not Specify>, <1.5>, <1.6>, <1.7>	Yes	Yes	Yes	Yes	C	Settings/Registration Basic Information

NOTE

- Depending on the functions set for the PDF files, the version assigned may be higher than that specified with this setting.

<Format PDF to PDF/A>

 (Settings/Registration) ▶ <Function Settings> ▶ <Common> ▶ <Generate File>

You can create PDF files compliant with PDF/A-1b. This is suited for long-term storage because it guarantees that the visual quality of the PDF does not change with the machine or viewing software.

Item	Setting Description	DeviceAdmin	NetworkAdmin	Can be set in Remote UI	Device Information Delivery Available	Import All Function	Name of Item When Exporting with the Remote UI
<Format PDF to PDF/A>	<On>, <Off>	Yes	Yes	Yes	Yes	C	Settings/Registration Basic Information

NOTE

- This setting is linked with the following default settings:
 - <File Format> in <Scan and Send>

- <File Format> in <Scan and Store>
- <File Format> in <Send> in <Access Stored Files>
- <File Format> in <Forwarding Settings>
- This setting is disabled when sending a fax or I-fax.
- The following PDF functions cannot be set if <Format PDF to PDF/A> is set to <On>.
 - Encryption
 - Visible Signature

<Optimize PDF for Web>

 (Settings/Registration) ▶ <Function Settings> ▶ <Common> ▶ <Generate File>

You can create a PDF that displays only the pages that are already downloaded even when a file is still being downloaded.

Item	Setting Description	DeviceAdmin	NetworkAdmin	Can be set in Remote UI	Device Information Delivery Available	Import All Function	Name of Item When Exporting with the Remote UI
<Optimize PDF for Web>	<On>, <Off>	Yes	Yes	Yes	Yes	C	Settings/Registration Basic Information

NOTE

- This setting is disabled when sending a fax or I-fax.
- If you set <Optimize PDF for Web> to <On>, this setting can be used with one of the following settings:
 - Device Signatures
 - User Signatures

<256-bit AES Settings for Encrypted PDF>

 (Settings/Registration) ▶ <Function Settings> ▶ <Common> ▶ <Generate File>

When generating an encrypted PDF file, you can select <Acrobat 3.0 or Later/40-bit RC4>, <Acrobat 6.0 or Later/128-bit RC4>, <Acrobat 7.0 or Later/128-bit AES>, or <Acrobat 10.0 or Equivalent/256-bit AES> as the PDF encryption level. If you want to use <Acrobat 9.0 or Equivalent/256-bit AES> rather than <Acrobat 10.0 or Equivalent/256-bit AES> as the encryption level, use this setting to change the selections you can make.

Item	Setting Description	DeviceAdmin	NetworkAdmin	Can be set in Remote UI	Device Information Delivery Available	Import All Function	Name of Item When Exporting with the Remote UI
<256-bit AES Settings for Encrypted PDF>	<Acrobat 9.0 or Equivalent>, <Acrobat 10.0 or Equivalent>	Yes	Yes	Yes	Yes	C	Settings/Registration Basic Information

NOTE

- This setting is disabled when sending a fax or I-fax.

<Set Authentication Method>

Specify the settings for the authentication methods that are common to all the functions.

- ▶<Information Used for LDAP Server Authentication>(P. 1195)
- ▶<Information Used for SMTP Server Authentication>(P. 1195)
- ▶<Information Used for File TX/Browsing Authentication>(P. 1196)

NOTE

- For information on the items ("A", "B", "C", and "No") in the "Import All Function" column, see ▶<Import All Function>(P. 1054) .

<Information Used for LDAP Server Authentication>

 (Settings/Registration) ▶ <Function Settings> ▶ <Common> ▶ <Set Authentication Method>

You can specify the authentication method for accessing an LDAP server.

Item	Setting Description	DeviceAdmin	NetworkAdmin	Can be set in Remote UI	Device Information Delivery Available	Import All Function	Name of Item When Exporting with the Remote UI
<Information Used for LDAP Server Authentication>	<Device Settings>, <Device Login Auth. Info.>, <Register Info. for Each User>	Yes	No	Yes	No	C	Settings/Registration Basic Information

NOTE

- When <Device Settings> is set
 - The information set in ▶<Registering the LDAP Server>(P. 299) is used.
- When <Device Login Authentication Information> is set
 - The authentication information used when logging into the machine is used.
- When <Registered Information for Each User> is set
 - The authentication information of the LDAP server is registered for each user.
- <Device Login Authentication Information> is available only when using the same authentication information for logging in to the machine and accessing the LDAP server, and when using a login service which supports Integrated Authentication. For information whether the login service you are using supports Integrated Authentication, contact your dealer or service representative.
- When <Registered Information for Each User> is selected, each user sets the user name and password used for LDAP authentication on the Send Basic Features screen ▶  ▶ <Register/Edit Information for Each User> ▶ <LDAP Server Authentication Information>.





<Information Used for SMTP Server Authentication>

 (Settings/Registration) ▶ <Function Settings> ▶ <Common> ▶ <Set Authentication Method>





You can specify the authentication method for accessing an SMTP server.

Item	Setting Description	DeviceAdmin	NetworkAdmin	Can be set in Remote UI	Device Information Delivery Available	Import All Function	Name of Item When Exporting with the Remote UI
<Information Used for SMTP Server Authentication>	<Device Settings>, <Register Info. for Each User>	Yes	No	Yes	No	C	Settings/Registration Basic Information

NOTE

- If you select <Device Settings>
 - Uses the information that was set in <Authent./Encryption> ( **Setting E-mail/I-Fax Communication(P. 316)**).
- If you select <Register Info. for Each User>
 - Registers and uses SMTP server authentication information for each user.
- If <Register Info. for Each User> is selected, each user has to press <Scan and Send>   <Register/Edit Information for Each User>  set the user name and password used for SMTP authentication in <SMTP Server Authentication Information>.





<Information Used for File TX/Browsing Authentication>

 (Settings/Registration)  <Function Settings>  <Common>  <Set Authentication Method>

You can specify the authentication method for accessing a file server.

Item	Setting Description	DeviceAdmin	NetworkAdmin	Can be set in Remote UI	Device Information Delivery Available	Import All Function	Name of Item When Exporting with the Remote UI
<Information Used for File TX/Browsing Authentication>	<Standard>, <Device Login Auth. Info.>, <Register Info. for Each User>	Yes	No	Yes	No	C	Settings/Registration Basic Information

NOTE

- <Device Login Authentication Information> is only valid for SMB and WebDAV.
- When <Normal> is set
 - The information set in  **Registering Destinations in the Address Book(P. 394)** is used.
- When <Device Login Authentication Information> is set
 - The authentication information used when logging into the machine is used.
- When <Registered Information for Each User> is set
 - The authentication information of the file server is registered for each user.
- When <Registered Information for Each User> is selected, each user sets the user name and password used for file server authentication on the Send Basic Features screen   <Register/Edit Information for Each User>  <Authentication Information for File TX/Browsing>.

<Copy>

Specify the settings for the copy function.

- ▶ <Register/Edit Favorite Settings>(P. 1197)
- ▶ <Display Confirmation for Favorite Settings>(P. 1197)
- ▶ <Change Default Settings>(P. 1197)
- ▶ <Register Options Shortcuts>(P. 1198)
- ▶ <Auto Collate>(P. 1198)
- ▶ <Auto Recognize Original Orientation>(P. 1199)
- ▶ <Select Color Settings for Copy>(P. 1199)
- ▶ <Speed Priority for Copying from Feeder>(P. 1200)
- ▶ <Job Separator Between Groups>(P. 1200)

NOTE

- For information on the items ("A", "B", "C", and "No") in the "Import All Function" column, see ▶ **Import All Function(P. 1054)** .

<Register/Edit Favorite Settings>

 (Settings/Registration) ▶ <Function Settings> ▶ <Copy>

You can register a combination of settings frequently used when copying to a single button. You can also assign a name to the button. ▶ **Registering a Combination of Frequently Used Functions(P. 367)**

Item	Setting Description	DeviceAdmin	NetworkAdmin	Can be set in Remote UI	Device Information Delivery Available	Import All Function	Name of Item When Exporting with the Remote UI
<Register/Edit Favorite Settings>	<M1> to <M9>:<Register>, <Rename>, <Delete>, <Check Content>	Yes	Yes	No	No	C	Favorite Settings

<Display Confirmation for Favorite Settings>

 (Settings/Registration) ▶ <Function Settings> ▶ <Copy>

You can select whether to display a confirmation screen when recalling "Favorite Settings."

Item	Setting Description	DeviceAdmin	NetworkAdmin	Can be set in Remote UI	Device Information Delivery Available	Import All Function	Name of Item When Exporting with the Remote UI
<Display Confirmation for Favorite Settings>	<On>, <Off>	Yes	Yes	No	No	C	Settings/Registration Basic Information

<Change Default Settings>

 (Settings/Registration) ▶ <Function Settings> ▶ <Copy>

You can change the settings registered as default for the <Copy> function. [▶ Customizing the Basic Features Screen\(P. 370\)](#)

Item	Setting Description	DeviceAdmin	NetworkAdmin	Can be set in Remote UI	Device Information Delivery Available	Import All Function	Name of Item When Exporting with the Remote UI
<Change Default Settings>	<Register>, <Initialize>	Yes	Yes	No	No	C	Favorite Settings

<Register Options Shortcuts>

 (Settings/Registration) ▶ <Function Settings> ▶ <Copy>

You can register/change modes in the shortcut keys displayed on the Copy Basic Features screen. This feature is useful when you want to register functions frequently used from <Options> and <Favorite Settings>. [▶ Customizing the Basic Features Screen\(P. 370\)](#)

Item	Setting Description	DeviceAdmin	NetworkAdmin	Can be set in Remote UI	Device Information Delivery Available	Import All Function	Name of Item When Exporting with the Remote UI
<Register Options Shortcuts>	Shortcut 1: Each mode, <Finishing>	Yes	Yes	No	No	C	Favorite Settings
	Shortcut 2: Each mode, <2-Sided>	Yes	Yes	No	No	C	Favorite Settings
	Shortcut 3: Each mode, <Density>	Yes	Yes	No	No	C	Favorite Settings
	Shortcut 4: Each mode, <Original Type>	Yes	Yes	No	No	C	Favorite Settings
	Shortcut 5: Each mode, <Copy ID Card>	Yes	Yes	No	No	C	Favorite Settings

NOTE

- Shortcuts are registered separately for <Regular Copy> and <Express Copy>.
- <Regular Copy> and <Express Copy> can be switched in [▶ <Copy Screen Display Settings>\(P. 1065\)](#) .
- Five shortcuts can be registered to <Regular Copy> and six shortcuts can be registered to <Express Copy>.

<Auto Collate>

 (Settings/Registration) ▶ <Function Settings> ▶ <Copy>

If this setting is set to <On>, the machine can automatically switch to <Collate (Page Order)> for the finishing mode when originals are placed in the feeder. You can also set <Offset> if an optional product that supports the Offset mode is attached to the machine. This is useful when making multiple sets of copies, because you do not need to remember to select the Finishing mode.

Item	Setting Description	DeviceAdmin	NetworkAdmin	Can be set in Remote UI	Device Information Delivery Available	Import All Function	Name of Item When Exporting with the Remote UI
<Auto Collate>	<On>, <Off>	Yes	Yes	No	Yes	B	Settings/Registration Basic Information
<Offset at Same Time> (Available when <Auto Collate> is set to <On>)	<On>, <Off>	-	-	-	-	B	Settings/Registration Basic Information

NOTE

- When an output tray that does not support the Offset mode is selected in the output tray settings, the copies will not be output to the output tray according to the specified settings if <Offset> is enabled. Perform one of the procedures below to solve this problem.
 - Disable <Offset at Same Time> in the auto collate settings.
 - Specify an output tray that supports the Offset mode in the output tray settings. ▶<Output Tray Settings> *(P. 1168)
 - Manually disable <Collate> before executing the job.

<Auto Recognize Original Orientation>

 (Settings/Registration) ▶ <Function Settings> ▶ <Copy>

When this setting is set to <On>, the image to copy is automatically rotated 90 degrees according to the orientation of the paper if the orientation of the original differs from the orientation of the paper that is loaded in the machine.

Item	Setting Description	DeviceAdmin	NetworkAdmin	Can be set in Remote UI	Device Information Delivery Available	Import All Function	Name of Item When Exporting with the Remote UI
<Auto Recognize Original Orientation>	<On>, <Off>	Yes	Yes	No	Yes	C	Settings/Registration Basic Information

NOTE

- In the following cases, Auto Orientation is not performed even if you select <On>:
 - If you are enlarging A4 or A5 originals onto A3 copy paper
 - If <Different Size Originals> is enabled and <Select Paper> is set to <Auto>
- Only the images of standard size originals up to A4 size can be rotated when the copy ratio is set to 100%.

<Select Color Settings for Copy>

 (Settings/Registration) ▶ <Function Settings> ▶ <Copy>

You can restrict the use of the color mode in <Select Color> when copying.

Item	Setting Description	DeviceAdmin	NetworkAdmin	Can be set in Remote UI	Device Information Delivery Available	Import All Function	Name of Item When Exporting with the Remote UI
<Select Color Settings for Copy>	<Use Auto (Color/Black & White)>: <On>, <Off>	Yes	No	Yes	Yes	C	Settings/Registration Basic Information
	<Use Full Color>: <On>, <Off>	Yes	No	Yes	Yes	C	Settings/Registration Basic Information
	<Use Single Color>: <On>, <Off>	Yes	No	Yes	No	C	Settings/Registration Basic Information
	<Use Two Colors>: <On>, <Off>	Yes	No	Yes	No	C	Settings/Registration Basic Information

<Speed Priority for Copying from Feeder>

 (Settings/Registration) ▶ <Function Settings> ▶ <Copy>

You can give a priority to speed over accuracy when copying from feeder.

Item	Setting Description	DeviceAdmin	NetworkAdmin	Can be set in Remote UI	Device Information Delivery Available	Import All Function	Name of Item When Exporting with the Remote UI
<Speed Priority for Copying from Feeder>	<On>, <Off>	Yes	Yes	No	No	B	Settings/Registration Basic Information

<Job Separator Between Groups>

 (Settings/Registration) ▶ <Function Settings> ▶ <Copy>

When copying two copies or more with <Group (Same Pages)> in <Finishing>, you can insert sheets between each page group. If you select <On>, select a paper source.

Item	Setting Description	DeviceAdmin	NetworkAdmin	Can be set in Remote UI	Device Information Delivery Available	Import All Function	Name of Item When Exporting with the Remote UI
<Job Separator Between Groups>	<On>, <Off> <Change> (Select Paper Source)	Yes	Yes	No	No	B	Settings/Registration Basic Information

<Printer>

Specify the settings for the printer functions.

- ▶<Output Report>(P. 1201)
- ▶<Printer Settings>(P. 1201)
- ▶<Restrict Printer Jobs>(P. 1202)
- ▶<PDL Selection (Plug and Play)>(P. 1202)
- ▶<Paper Feed Mode for Printer Driver Jobs with MP Tray>(P. 1203)
- ▶<Envelope Flap Length Settings>(P. 1203)
- ▶<PS Password Settings>(P. 1204)
- ▶<Paper Feed Mode When Using PCL Emulation>(P. 1204)

NOTE

- For information on the items ("A", "B", "C", and "No") in the "Import All Function" column, see ▶<Import All Function(P. 1054) .

<Output Report>

 (Settings/Registration) ▶ <Function Settings> ▶ <Printer>

You can print reports for the machine settings.

Item	Setting Description	DeviceAdmin	NetworkAdmin	Can be set in Remote UI	Device Information Delivery Available	Import All Function	Name of Item When Exporting with the Remote UI
<Output Report>	▶<Output Report(P. 1205)	-	-	-	-	-	-

<Printer Settings>

 (Settings/Registration) ▶ <Function Settings> ▶ <Printer>

Specify the printer settings.

- For more information, see Setting the Machine (PS/PCL/UFR II Printer).

Item	Setting Description	DeviceAdmin	NetworkAdmin	Can be set in Remote UI	Device Information Delivery Available	Import All Function	Name of Item When Exporting with the Remote UI
<Custom Settings>	▶<Custom Settings(P. 1206)	-	-	-	-	-	-
<UFR II>	▶<UFR II(P. 1212)	-	-	-	-	-	-
<PCL>*1	▶<PCL(P. 1213)	-	-	-	-	-	-

Item	Setting Description	DeviceAdmin	NetworkAdmin	Can be set in Remote UI	Device Information Delivery Available	Import All Function	Name of Item When Exporting with the Remote UI
<PS>*1	PS(P. 1215)	-	-	-	-	-	-
<Imaging>	Imaging(P. 1217)	-	-	-	-	-	-
<PDF>	PDF(P. 1219)	-	-	-	-	-	-
<XPS>	XPS(P. 1221)	-	-	-	-	-	-
<Utility>	Utility(P. 1223)	-	-	-	-	-	-

*1 Indicates items that appear only when the appropriate optional product is available for use or the appropriate setting is specified.

<Restrict Printer Jobs>

 (Settings/Registration) ▶ <Function Settings> ▶ <Printer>

If this setting is set to <On>, you can restrict jobs from the printer driver.

Item	Setting Description	DeviceAdmin	NetworkAdmin	Can be set in Remote UI	Device Information Delivery Available	Import All Function	Name of Item When Exporting with the Remote UI
<Restrict Printer Jobs>	<On>, <Off>	Yes	No	Yes	Yes	C	Settings for Printer Settings
	When <On> is selected: <ul style="list-style-type: none"> <Select Jobs to Allow>: <Reserved Jobs> 	Yes	No	Yes	Yes	C	Settings for Printer Settings

<PDL Selection (Plug and Play)>

 (Settings/Registration) ▶ <Function Settings> ▶ <Printer>

Select default Page Description Language (PDL).

Item	Setting Description	DeviceAdmin	NetworkAdmin	Can be set in Remote UI	Device Information Delivery Available	Import All Function	Name of Item When Exporting with the Remote UI
<PDL Selection (Plug and Play)>	<UFR II>, <PCL6>*1, <PS3>*1, <UFR II (V4)>, <Fax>*1, <PCL6 (V4)>*1	Yes	No	Yes	No	C	Settings for Printer Settings

*1 Indicates items that appear only when the appropriate optional product is available for use or the appropriate setting is specified.

<Paper Feed Mode for Printer Driver Jobs with MP Tray>

 (Settings/Registration) ▶ <Function Settings> ▶ <Printer>

You can set whether to prioritize the printer driver settings or the paper settings in the machine when printing a job with the multi-purpose tray specified as the paper source. In addition, if you prioritized the settings in the machine, set the paper feed mode for when free size paper is set in the multi-purpose tray.

Item	Setting Description	DeviceAdmin	NetworkAdmin	Can be set in Remote UI	Device Information Delivery Available	Import All Function	Name of Item When Exporting with the Remote UI
<Paper Feed Mode for Printer Driver Jobs with MP Tray>	<Mode A (Prioritize Printer Driver Settings)>, <Mode B (Flexible If Free Size Is Selected)>, <Mode C (Feed Only If Paper Settings Match)>	Yes	Yes	Yes	No	C	Settings/Registration Basic Information

NOTE

- When the following conditions are met, you can press <Temp. Change Ppr. in MP Tray> on the paper selection screen of <Copy> and <Access Stored Files> to change the paper size/type to load from the multi-purpose tray:
 - If paper is loaded in the multi-purpose tray
 - If this setting is set to <Mode A (Prioritize Printer Driver Settings)>
 - If  <Multi-Purpose Tray Defaults>(P. 1061) is set to <Use Preset>
- If the paper size specified in the printer driver greatly differs from the paper size set in the multi-purpose tray, an error message is displayed.
- Take note of the following when free size paper is set for <Mode A (Prioritize Printer Driver Settings)>.
 - When printing on envelopes, be sure to specify the paper type on the printer driver. If it is not specified, printing may not be performed.
 - A paper jam or another printing problem may occur if the paper type is not specified when printing on other type of paper.

<Envelope Flap Length Settings>

 (Settings/Registration) ▶ <Function Settings> ▶ <Printer>

You can set the flap length when Nagagata 3 envelopes are loaded vertically (with the flap on the far side) in the multi-purpose tray.

Item	Setting Description	DeviceAdmin	NetworkAdmin	Can be set in Remote UI	Device Information Delivery Available	Import All Function	Name of Item When Exporting with the Remote UI
<Envelope Flap Length Settings>	0 to 30.0 mm	Yes	Yes	No	Yes	B	Settings for Printer Settings

NOTE

- In order to change this setting,  <Paper Feed Mode for Printer Driver Jobs with MP Tray>(P. 1203) must be set to <Mode A (Prioritize Printer Driver Settings)>.
- This setting is applied in the following cases:
 - If Nagagata 3 envelope is specified in the printer driver
 - If the multi-purpose tray is set as the paper source when sending the job from the printer driver
 - If <Paper Feed Mode for Printer Driver Jobs with MP Tray> is set to <Mode A (Prioritize Printer Driver Settings)>

<PS Password Settings>

 (Settings/Registration) ► <Function Settings> ► <Printer>

You can specify the password that restricts the use of the control command prepared by the PS printer.

Item	Setting Description	DeviceAdmin	NetworkAdmin	Can be set in Remote UI	Device Information Delivery Available	Import All Function	Name of Item When Exporting with the Remote UI
<PS Password Settings>	<SystemParamsPassword>, <StartJobPassword>	No	No	Yes	No	C	Settings for Printer Settings

NOTE

- <SystemParamsPassword> is a password that allows changes to the system parameter, and <StartJobPassword> is a password that allows startjob, exitserver operator to perform. For more information, check PostScript language specifications.

<Paper Feed Mode When Using PCL Emulation>

 (Settings/Registration) ► <Function Settings> ► <Printer>

You can set the paper source used for the PCL5 PaperSource command.

Item	Setting Description	DeviceAdmin	NetworkAdmin	Can be set in Remote UI	Device Information Delivery Available	Import All Function	Name of Item When Exporting with the Remote UI
<Paper Feed Mode When Using PCL Emulation>	<Mode 0>, <Mode 1>, <Mode 2>	No	No	Yes	No	C	Settings/Registration Basic Information

NOTE

- For details on each setting, see Setting the Machine (PS/PCL/UFR II Printer).

Output Report

961F-ORF

NOTE

- For information on the items ("A", "B", "C", and "No") in the "Import All Function" column, see [▶ Import All Function\(P. 1054\)](#) .

Item	Setting Description	DeviceAdmin	NetworkAdmin	Can be set in Remote UI	Device Information Delivery Available	Import All Function	Name of Item When Exporting with the Remote UI
<PCL>							
<Configuration Page>	<Yes>, <No>	Yes	Yes	Yes	No	No	-
	<Yes>, <No>	Yes	Yes	Yes	No	No	-
<PS>							
<Configuration Page>	<Yes>, <No>	Yes	Yes	Yes	No	No	-
	<Yes>, <No>	Yes	Yes	Yes	No	No	-
<RGB Test Page>	<Yes>, <No>	Yes	Yes	Yes	No	No	-
<CMYK Test Page>	<Yes>, <No>	Yes	Yes	Yes	No	No	-
<RGB Color Chart>	<Yes>, <No>	Yes	Yes	Yes	No	No	-
<CMYK Color Chart>	<Yes>, <No>	Yes	Yes	Yes	No	No	-

Custom Settings

961F-ORH

NOTE

- For information on the items ("A", "B", "C", and "No") in the "Import All Function" column, see [Import All Function\(P. 1054\)](#) .

Item	Setting Description	DeviceAdmin	NetworkAdmin	Can be set in Remote UI	Device Information Delivery Available	Import All Function	Name of Item When Exporting with the Remote UI
<Number of Copies>	1 to 9999	Yes	Yes	Yes	Yes	C	Settings for Printer Settings
<2-Sided Printing>	<On>, <Off>	Yes	Yes	Yes	Yes	C	Settings for Printer Settings
<Paper Feed>							
<Default Paper Feed Source>	<Auto>, <MP Tray>, <Drawer 1> to <Drawer n>*1	Yes	Yes	Yes	No	B	Settings for Printer Settings
<Default Paper Size>	<A4>, <A3>, <A5>, <A6>, <B4>, <B5>, <8K>, <16K>, <Letter>, <Legal>, <11x17>, <Statement>, <Executive>, <Env. NAGAGATA 3>, <Env. NAGAGATA 4>, <Env. NAGAGATA 40>, <Env. YOGATANAGA3>, <Env. KAKUGATA 2>, <Env. No. 10>, <Envelope ISO-C5>, <Envelope DL>, <Envelope Monarch>, <305x457 mm>, <320x450 mm (SRA3)>	Yes	Yes	Yes	No	B	Settings for Printer Settings
<Default Paper Type>	<Thin 2>, <Thin 1>, <Plain 1>, <Plain 2>, <Plain 3>, <Heavy 1>, <Heavy 2>, <Heavy 3>, <Heavy 4>, <Heavy 5>, <Heavy 6>, <Heavy 7>, <Color>, <Recycled 1>, <Recycled 2>, <Recycled 3>, <Pre-Punched 1>, <Pre-Punched 2>, <Transparency>, <Tracing>, <Labels>, <Bond>, <Letterhead 1>, <Letterhead 2>, <Letterhead 3>, <Letterhead 4>, <Letterhead 5>, <Letterhead 6>, <Letterhead 7>, <1-Sided Coated 1>, <1-Sided Coated 2>, <1-Sided Coated 3>, <1-Sided Coated 4>, <2-Sided Coated 1>, <2-Sided Coated 2>, <2-Sided Coated 3>, <2-Sided Coated 4>, <Envelope>	Yes	Yes	Yes	No	B	Settings for Printer Settings

Settings/Registration

Item	Setting Description	DeviceAdmin	NetworkAdmin	Can be set in Remote UI	Device Information Delivery Available	Import All Function	Name of Item When Exporting with the Remote UI
<Paper Size Override>	<On>, <Off>	Yes	Yes	Yes	Yes	C	Settings for Printer Settings
<Paper Output>							
<Finishing>	<Finishing>: <Off>, <Collate>, <Group>, <Rotate+Collate>* ² , <Rotate+Group>* ² , <Offset+Collate>* ^{2*3} , <Offset+Group>* ² , <Staple+Collate>* ^{2*4} , <Staple + Group>* ^{2*4} , <Eco(Stpl-Fr) + Collate>* ^{2*5} , <Eco(Stpl-Fr) + Group>* ^{2*5} <Offset Copies>: 1 to 9999 <Binding Position>: <Corner (Upper-L)>, <Double (Top)>, <Corner (Upper-R)>, <Double (Right)>, <Corner (Lower-R)>, <Double (Bottom)>, <Corner (Lower-L)>, <Double (Left)>	Yes	Yes	Yes	Yes	C	Settings for Printer Settings
<Punch>	<Punch>: <On>, <Off> <Punch Position>: <Left>, <Right>, <Top>, <Bottom> <Punch Type>: <Finisher (2 Hole)>, <Finisher (4 Hole)>	Yes	Yes	Yes	Yes	C	Settings for Printer Settings
<Fold>* ²	<Fold>: <On>, <Off> <Fold Type>: <Saddle Fold> <Saddle Fold Sheet Together>: 1 to 3 sheets	Yes	Yes	Yes	No	C	Settings for Printer Settings
<Print Quality>							
<Density>* ²	<Cyan>: -8 to +8; 0 <Magenta>: -8 to +8; 0 <Yellow>: -8 to +8; 0 <Black>: -8 to +8; 0	Yes	Yes	Yes	Yes	C	Settings for Printer Settings
<Density (Fine Adjust)>* ²	<Cyan>: <High>: -8 to +8; 0 <Medium>: -8 to +8; 0 <Low>: -8 to +8; 0 <Magenta>: <High>: -8 to +8; 0 <Medium>: -8 to +8; 0 <Low>: -8 to +8; 0 <Yellow>: <High>: -8 to +8; 0 <Medium>: -8 to +8; 0 <Low>: -8 to +8; 0 <Black>: <High>: -8 to +8; 0 <Medium>: -8 to +8; 0	Yes	Yes	Yes	Yes	C	Settings for Printer Settings

Settings/Registration

Item	Setting Description	DeviceAdmin	NetworkAdmin	Can be set in Remote UI	Device Information Delivery Available	Import All Function	Name of Item When Exporting with the Remote UI
	<Low>: -8 to +8; 0						
<Toner Save>	<On>, <Off>	Yes	Yes	Yes	Yes	C	Settings for Printer Settings
<Resolution>	<1200 dpi>, <600 dpi>	Yes	Yes	Yes	Yes	B	Settings for Printer Settings
	<On>, <Off>	Yes	Yes	Yes	Yes	B	Settings for Printer Settings
<Sharpness>	-3 to +3; 0	Yes	Yes	Yes	No	B	Settings for Printer Settings
<Sharpness (Photo)>	-1 to +3; +2	Yes	Yes	Yes	No	C	Settings for Printer Settings
<Trapping>	<Trapping>: <On>, <Off> <Trapping Width>: <Upper>: 0 to 3; 1 pixel <Lower>: 0 to 3; 1 pixel <Left>: 0 to 3; 1 pixel <Right>: 0 to 3; 1 pixel <Trapping Density>: <Cyan>: 0 to 100; 100 % <Magenta>: 0 to 100; 100 % <Yellow>: 0 to 100; 100 %	Yes	Yes	Yes	Yes	B	Settings for Printer Settings
<Toner Volume Correction>	<Normal>, <Grad. Priority>, <Text Priority>	Yes	Yes	Yes	Yes	C	Settings for Printer Settings
<Line Control>	<Res. Priority>, <Grad. Priority>	Yes	Yes	Yes	Yes	C	Settings for Printer Settings
<Width Adjustment>	<Width Adjustment>: <On>, <Off> <Horizontal>*2: <Off>, <Level 1>, <Level 2> <Vertical>*2: <Off>, <Level 1>, <Level 2> <Target Color>*2: <All>, <Black Only>	Yes	Yes	Yes	Yes	B	Settings for Printer Settings
<Advanced Smoothing>	<Advanced Smoothing>: <Off>, <Level 1>, <Level 2> <Apply to Graphics>: <On>, <Off> <Apply to Text>: <On>, <Off>	Yes	Yes	Yes	Yes	C	Settings for Printer Settings
<Gradation Smoothing>	<Gradation Smoothing>: <Off>, <Level 1>, <Level 2> <Apply to Graphics>: <On>, <Off>	Yes	Yes	Yes	Yes	C	Settings for Printer Settings

Settings/Registration

Item	Setting Description	DeviceAdmin	NetworkAdmin	Can be set in Remote UI	Device Information Delivery Available	Import All Function	Name of Item When Exporting with the Remote UI
	<Apply to Images>: <On>, <Off>						
<Enhance Text for B&W Print>	<On>, <Off>	Yes	Yes	Yes	No	C	Settings for Printer Settings
<Layout>							
<Binding Location>	<Long Edge>, <Short Edge>	Yes	Yes	Yes	Yes	C	Settings for Printer Settings
<Gutter>	-50.0 mm to +50.0 mm; 0.0 mm	Yes	Yes	Yes	Yes	C	Settings for Printer Settings
<Offset Short Edge (Front)>	-50.0 mm to +50.0 mm; 0.0 mm	Yes	Yes	Yes	Yes	C	Settings for Printer Settings
<Offset Long Edge (Front)>	-50.0 mm to +50.0 mm; 0.0 mm	Yes	Yes	Yes	Yes	C	Settings for Printer Settings
<Offset Short Edge (Back)>	-50.0 mm to +50.0 mm; 0.0 mm	Yes	Yes	Yes	Yes	C	Settings for Printer Settings
<Offset Long Edge (Back)>	-50.0 mm to +50.0 mm; 0.0 mm	Yes	Yes	Yes	Yes	C	Settings for Printer Settings
<Auto Error Skip>	<On>, <Off>	Yes	Yes	Yes	Yes	C	Settings for Printer Settings
<Timeout>	<Timeout>: <On>, <Off> <Timeout>: 5 seconds to 300 seconds; 15 seconds	Yes	Yes	Yes	Yes	C	Settings for Printer Settings
<Print After Completing RIP>	<On>, <Off>	Yes	Yes	Yes	Yes	C	Settings for Printer Settings
<Booklet>	<Booklet>: <On>, <Off> <Book Opening>*2: <Left Opening>, <Right Opening>	Yes	Yes	Yes	Yes	C	Settings for Printer Settings
<Saddle Stitch>*2	<On>, <Off>	Yes	Yes	Yes	Yes	C	Settings for Printer Settings
<Creep Correction>*2	<Off>, <Auto>, <Correction Width>	Yes	Yes	Yes	Yes	C	Settings for Printer Settings

Settings/Registration

Item	Setting Description	DeviceAdmin	NetworkAdmin	Can be set in Remote UI	Device Information Delivery Available	Import All Function	Name of Item When Exporting with the Remote UI
<Transparency Interleaving>*2	<Off>, <Blank>, <Printed>	Yes	Yes	Yes	Yes	C	Settings for Printer Settings
<Copy Set Numbering>*2							
<Copy Set Numbering>	<On>, <Off>	Yes	Yes	Yes	Yes	C	Settings for Printer Settings
<Print Position>*2	<5 Locations>, <Top Left>, <Bottom Left>, <Top Right>, <Bottom Right>, <Full Surface>	Yes	Yes	Yes	Yes	C	Settings for Printer Settings
<Starting Number>*2	1 to 9999; 1	Yes	Yes	Yes	Yes	C	Settings for Printer Settings
<Number Size>*2	<Small (12 point)>, <Medium (24 point)>, <Large (36 point)>	Yes	Yes	Yes	Yes	C	Settings for Printer Settings
<Density>*2	1 to 5; 3	Yes	Yes	Yes	Yes	C	Settings for Printer Settings
<Color>*2	<Yellow>, <Magenta>, <Cyan>, <Black>, <Red>, <Green>, <Blue>	Yes	Yes	Yes	Yes	B	Settings for Printer Settings
<Number Position Vertical>*2 <Number Position Horizontal>*2	-8 mm to +8 mm; 0 mm	Yes	Yes	Yes	Yes	C	Settings for Printer Settings
<Personality>*2	<Auto>, <PS>, <PCL>, <Imaging>, <PDF>, <XPS>	Yes	Yes	Yes	No	C	Settings for Printer Settings
<Mode Priority>*2	<None>, <PS>, <PCL>, <PDF>, <XPS>	Yes	Yes	Yes	No	C	Settings for Printer Settings
<Auto Select>*2	<PS>: <On>, <Off> <PCL>: <On>, <Off> <XPS>: <On>, <Off> <Imaging>: <On>, <Off> <PDF>: <On>, <Off>	Yes	Yes	Yes	No	C	Settings for Printer Settings
<Color Mode>	<Auto (Color/B&W)>, <Black & White>	Yes	Yes	Yes	Yes	C	Settings for Printer Settings
<Compressed Image Output>	<Output>, <Display Error>	Yes	Yes	Yes	Yes	C	Settings for Printer Settings
<Initialize>	<Yes>, <No>	Yes	Yes	No	No	No	-

Settings/Registration

*1 Note that the number of drawers displayed differs depending on your model and the installed options.

*2 Indicates items that appear only when the appropriate optional product is available for use or the appropriate setting is specified.

*3 Copies: 1 to 9999

*4 Staple Position (Staple+Collate, Staple + Group):

Corner (Upper-L), Double (Top), Corner (Upper-R), Double (Right), Corner (Lower-R), Double (Bottom), Corner (Lower-L), Double (Left).

*5 Staple Position (Eco(Stpl-Fr) + Collate, Eco (Stpl-Fr) + Group):

Corner (Upper-L), Corner (Upper-R), Corner (Lower-R), Corner (Lower-L).

UFR II

961F-0RJ

NOTE

- For information on the items ("A", "B", "C", and "No") in the "Import All Function" column, see [▶ Import All Function\(P. 1054\)](#) .

Item	Setting Description	DeviceAdmin	NetworkAdmin	Can be set in Remote UI	Device Information Delivery Available	Import All Function	Name of Item When Exporting with the Remote UI
<Halftones>	<Text>: <Resolution>, <Gradation>, <Error Diffusion> <Graphics>: <Resolution>, <Gradation>, <Error Diffusion> <Image>: <Resolution>, <Gradation>, <Error Diffusion>	Yes	Yes	Yes	Yes	B	Settings for Printer Settings
<Matching Method>	<General>, <Perceptual>, <Colorimetric>, <Vivid Photo>, <Download Profile>	Yes	Yes	Yes	No	C	Settings for Printer Settings
<Gray Compensation>	<Text>: <On>, <Off> <Graphics>: <On>, <Off> <Image>: <On>, <Off>	Yes	Yes	Yes	Yes	B	Settings for Printer Settings
<Paper Save>	<On>, <Off>	Yes	Yes	Yes	Yes	C	Settings for Printer Settings

NOTE

- For information on the items ("A", "B", "C", and "No") in the "Import All Function" column, see [▶ Import All Function\(P. 1054\)](#) .

Item	Setting Description	DeviceAdmin	NetworkAdmin	Can be set in Remote UI	Device Information Delivery Available	Import All Function	Name of Item When Exporting with the Remote UI
<Paper Save>	<On>, <Off>	Yes	Yes	Yes	Yes	C	Settings for Printer Settings
<Orientation>	<Portrait>, <Landscape>	Yes	Yes	Yes	Yes	C	Settings for Printer Settings
	<Internal>, <Soft/External>	Yes	Yes	No	No	C	Settings for Printer Settings
	0 to 104; 0 (If the Font Source setting is Internal.) 1 to 999; 1 (If the Font Source setting is Soft/External.)	Yes	Yes	Yes	No	C	Settings for Printer Settings
<Point Size>*1	4.00 to 999.75 <point>; 12.00 <point>	Yes	Yes	Yes	No	C	Settings for Printer Settings
<Pitch>*1	0.44 to 99.99 <dpi>; 10.00 <dpi>	Yes	Yes	Yes	No	C	Settings for Printer Settings
<Form Lines>	5 to 128 <lines>; 64 <lines>	Yes	Yes	Yes	No	C	Settings for Printer Settings
<Character Code>	<ARABIC8>, <DESKTOP>, <GREEK8>, <HEBREW7>, <HEBREW8>, <ISO4>, <ISO6>, <ISO11>, <ISO15>, <ISO17>, <ISO21>, <ISO60>, <ISO69>, <ISOCYR>, <ISOGRK>, <ISOHEB>, <ISOL1>, <ISOL2>, <ISOL5>, <ISOL6>, <ISOL9>, <LEGAL>, <MATH8>, <MCTEXT>, <MSPUBL>, <PC8>, <PC8DN>, <PC8GRK>, <PC8TK>, <PC775>, <PC850>, <PC851>, <PC852>, <PC858>, <PC862>, <PC864>, <PC866>, <PC1004>, <PIFONT>, <PSMATH>, <PSTEXT>, <ROMAN8>, <ROMAN9>, <VNINTL>, <VNMATH>, <VNUS>, <WIN30>, <WINARB>, <WINBALT>, <WINCYR>, <WINGRK>, <WINL1>, <WINL2>, <WINL5>	Yes	Yes	Yes	Yes	C	Settings for Printer Settings

Settings/Registration

Item	Setting Description	DeviceAdmin	NetworkAdmin	Can be set in Remote UI	Device Information Delivery Available	Import All Function	Name of Item When Exporting with the Remote UI
<Custom Paper>	<On>, <Off>	Yes	Yes	Yes	No	C	Settings for Printer Settings
<Unit of Measure>*1	<Millimeters>, <inches>	Yes	Yes	Yes	No	C	Settings for Printer Settings
<X dimension>*1	98.0 mm to 1200.0 mm; 457.2 mm	Yes	Yes	Yes	No	B	Settings for Printer Settings
<Y dimension>*1	98.0 mm to 320.0 mm; 320.0 mm	Yes	Yes	Yes	No	B	Settings for Printer Settings
<Append CR to LF>	<Yes>, <No>	Yes	Yes	Yes	Yes	C	Settings for Printer Settings
<Enlarge A4 Print Width>	<On>, <Off>	Yes	Yes	Yes	Yes	C	Settings for Printer Settings
<Halftones>	<Text>: <Resolution>, <Gradation>, <Error Diffusion> <Graphics>: <Resolution>, <Gradation>, <Error Diffusion> <Image>: <Resolution>, <Gradation>, <Error Diffusion>	Yes	Yes	Yes	Yes	B	Settings for Printer Settings
<Matching Method>	<General>, <Perceptual>, <Colorimetric>, <Vivid Photo>, <Download Profile>	Yes	Yes	Yes	No	C	Settings for Printer Settings
<Gray Compensation>	<Text>: <On>, <Off> <Graphics>: <On>, <Off> <Image>: <On>, <Off>	Yes	Yes	Yes	Yes	B	Settings for Printer Settings
<BarDIMM>	<Enable>, <Disable>	Yes	Yes	Yes	Yes	C	Settings for Printer Settings
<FreeScale>*1	<Off>, <->, < >, <#>, <\$>, </>, < >, <?>, <{>, <}>, < >	Yes	Yes	Yes	Yes	C	Settings for Printer Settings

*1 Indicates items that appear only when the appropriate optional product is available for use or the appropriate setting is specified.

NOTE

- For information on the items ("A", "B", "C", and "No") in the "Import All Function" column, see [Import All Function\(P. 1054\)](#) .

Item	Setting Description	DeviceAdmin	NetworkAdmin	Can be set in Remote UI	Device Information Delivery Available	Import All Function	Name of Item When Exporting with the Remote UI
<Paper Save>	<On>, <Off>	Yes	Yes	Yes	No	C	Settings for Printer Settings
<Job Timeout>	0 to 3600 seconds; 0 second	Yes	Yes	Yes	Yes	C	Settings for Printer Settings
<Print PS Errors>	<On>, <Off>	Yes	Yes	Yes	Yes	C	Settings for Printer Settings
<Line Refinement>	<On>, <On (Slim)>, <Off>	Yes	Yes	Yes	No	C	Settings for Printer Settings
<Pure Black Text>	<On>, <Off>	Yes	Yes	Yes	Yes	C	Settings for Printer Settings
<Pure Black Graphics>	<On>, <Off>	Yes	Yes	Yes	No	C	Settings for Printer Settings
<Black Overprint>*1	<On>, <Off>	Yes	Yes	Yes	Yes	C	Settings for Printer Settings
<Matching Mode>	<RGB Input>: <ICC Profile>, <D. Link Profile>/<CMYK Input>: <ICC Profile>, <D. Link Profile>	Yes	Yes	Yes	No	No	Settings for Printer Settings
<RGB Source Profile>	<sRGB>, <Gamma 1.5>, <Gamma 1.8>, <Gamma 2.4>, <None>, <Download Profile>	Yes	Yes	Yes	No	No	-
<CMYK Simulation Profile>	<JapanColor(Canon)>, <US Web Ctd(Canon)>, <Euro Standard>, <None>, <Download Profile>	Yes	Yes	Yes	No	No	-
<Use Grayscale Profile>	<On>, <Off>	Yes	Yes	Yes	No	No	-
<Output Profile>	<Text>: <Normal>, <Photo>, <TR Normal>, <TR Photo>, <Download Profile> <Graphics>: <Normal>, <Photo>, <TR Normal>, <TR Photo>, <Download Profile> <Image>: <Normal>, <Photo>, <TR Normal>, <TR Photo>, <Download Profile>	Yes	Yes	Yes	No	No	-

Settings/Registration

Item	Setting Description	DeviceAdmin	NetworkAdmin	Can be set in Remote UI	Device Information Delivery Available	Import All Function	Name of Item When Exporting with the Remote UI
<Matching Method>	<Perceptual>, <Saturation>, <Colorimetric>	Yes	Yes	Yes	Yes	C	Settings for Printer Settings
<Device Link Profile>	<RGB Input>: <Download Profile>/<CMYK Input>: <Download Profile>	Yes	Yes	Yes	No	No	Settings for Printer Settings
<Halftones>	<Text>: <Resolution>, <Gradation>, <Error Diffusion> <Graphics>: <Resolution>, <Gradation>, <Error Diffusion> <Image>: <Resolution>, <Gradation>, <Error Diffusion>	Yes	Yes	Yes	Yes	B	Settings for Printer Settings
<Brightness>*1	85% to 115%; 100%	Yes	Yes	Yes	Yes	C	Settings for Printer Settings
<Composite Overprint>	<On>, <Off>	Yes	Yes	Yes	Yes	C	Settings for Printer Settings
<Grayscale Conversion>*1	<sRGB>, <NTSC>, <Uniform RGB>	Yes	Yes	Yes	Yes	C	Settings for Printer Settings

*1 Indicates items that appear only when the appropriate optional product is available for use or the appropriate setting is specified.

Imaging

961F-ORR

NOTE

- For information on the items ("A", "B", "C", and "No") in the "Import All Function" column, see [▶ Import All Function\(P. 1054\)](#) .

Item	Setting Description	DeviceAdmin	NetworkAdmin	Can be set in Remote UI	Device Information Delivery Available	Import All Function	Name of Item When Exporting with the Remote UI
<Image Orientation>	<Auto>, <Vertical>, <Horizontal>	Yes	Yes	Yes	Yes	C	Settings for Printer Settings
<Zoom Mode>	<Off>, <Auto>	Yes	Yes	Yes	Yes	C	Settings for Printer Settings
<Print Position>	<Auto>, <Center>, <Top Left>	Yes	Yes	Yes	Yes	C	Settings for Printer Settings
<Show Warnings>	<On>, <Off>	Yes	Yes	Yes	Yes	C	Settings for Printer Settings
<Enlarge Print Area>	<On>, <Off>	Yes	Yes	Yes	Yes	C	Settings for Printer Settings
<Matching Method>	<General>, <Perceptual>, <Colorimetric>, <Vivid Photo>, <Download Profile>	Yes	Yes	Yes	No	C	Settings for Printer Settings
<Photo Correct. (Color Only)>							
<Photo Optimizer PRO>	<On>, <Off>	Yes	Yes	Yes	No	C	Settings for Printer Settings
<Red-Eye Correction>	<Red-Eye Correction>: <On>, <Off>	Yes	Yes	Yes	No	C	Settings for Printer Settings
	<Red-Eye Correction Level>: <Weak>, <Standard>, 						
<Face Brightener>	<Face Brightener>: <On>, <Off>	Yes	Yes	Yes	No	C	Settings for Printer Settings
	<Face Brightener Level>: <Weak>, <Standard>, 						
<Halftones>	<Resolution>, <Gradation>, <Error Diffusion>	Yes	Yes	Yes	Yes	B	Settings for Printer Settings
<Gray Compensation>	<On>, <Off>	Yes	Yes	Yes	Yes	B	Settings for Printer Settings

Settings/Registration

Item	Setting Description	DeviceAdmin	NetworkAdmin	Can be set in Remote UI	Device Information Delivery Available	Import All Function	Name of Item When Exporting with the Remote UI
<Grayscale Conversion>*1	<sRGB>, <NTSC>, <Uniform RGB>	Yes	Yes	Yes	Yes	C	Settings for Printer Settings

*1 Indicates items that appear only when the appropriate optional product is available for use or the appropriate setting is specified.

NOTE

- For information on the items ("A", "B", "C", and "No") in the "Import All Function" column, see [Import All Function\(P. 1054\)](#) .

Item	Setting Description	DeviceAdmin	NetworkAdmin	Can be set in Remote UI	Device Information Delivery Available	Import All Function	Name of Item When Exporting with the Remote UI
<Paper Save>	<On>, <Off>	Yes	Yes	Yes	No	C	Settings for Printer Settings
<Enlarge/Reduce to Fit Size>	<On>, <Off>	Yes	Yes	Yes	Yes	C	Settings for Printer Settings
<Enlarge Print Area>	<On>, <Off>	Yes	Yes	Yes	Yes	C	Settings for Printer Settings
<N on 1>	<Off>, <2 on 1>, <4 on 1>, <6 on 1>, <8 on 1>, <9 on 1>, <16 on 1>	Yes	Yes	Yes	Yes	C	Settings for Printer Settings
<Comment Print>	<Off>, <Auto>	Yes	Yes	Yes	Yes	C	Settings for Printer Settings
<Line Refinement>	<On>, <On (Slim)>, <Off>	Yes	Yes	Yes	No	C	Settings for Printer Settings
<Pure Black Text>	<On>, <Off>	Yes	Yes	Yes	Yes	C	Settings for Printer Settings
<Pure Black Graphics>	<On>, <Off>	Yes	Yes	Yes	No	C	Settings for Printer Settings
<Black Overprint>*1	<On>, <Off>	Yes	Yes	Yes	Yes	C	Settings for Printer Settings
<Matching Mode>	<RGB Input>: <ICC Profile>, <D. Link Profile>/<CMYK Input>: <ICC Profile>, <D. Link Profile>	Yes	Yes	Yes	No	C	Settings for Printer Settings
<RGB Source Profile>	<sRGB>, <Gamma 1.5>, <Gamma 1.8>, <Gamma 2.4>, <None>, <Download Profile>	Yes	Yes	Yes	No	No	-
<CMYK Simulation Profile>	<JapanColor(Canon)>, <US Web Ctd(Canon)>, <Euro Standard>, <None>, <Download Profile>	Yes	Yes	Yes	No	No	-
<Use Grayscale Profile>	<On>, <Off>	Yes	Yes	Yes	No	No	-
<Output Profile>	<Text>: <Normal>, <Photo>, <TR Normal>, <TR Photo>, <Download Profile>	Yes	Yes	Yes	No	No	-

Settings/Registration

Item	Setting Description	DeviceAdmin	NetworkAdmin	Can be set in Remote UI	Device Information Delivery Available	Import All Function	Name of Item When Exporting with the Remote UI
	<Graphics>: <Normal>, <Photo>, <TR Normal>, <TR Photo>, <Download Profile> <Image>: <Normal>, <Photo>, <TR Normal>, <TR Photo>, <Download Profile>						
<Matching Method>	<Perceptual>, <Saturation>, <Colorimetric>	Yes	Yes	Yes	Yes	C	Settings for Printer Settings
<Device Link Profile>	<RGB Input>: <Download Profile>/<CMYK Input>: <Download Profile>	Yes	Yes	Yes	No	No	Settings for Printer Settings
<Halftones>	<Text>: <Resolution>, <Gradation>, <Error Diffusion> <Graphics>: <Resolution>, <Gradation>, <Error Diffusion> <Image>: <Resolution>, <Gradation>, <Error Diffusion>	Yes	Yes	Yes	Yes	B	Settings for Printer Settings
<Brightness>*1	85% to 115%; 100%	Yes	Yes	Yes	Yes	C	Settings for Printer Settings
<Composite Overprint>	<On>, <Off>	Yes	Yes	Yes	Yes	C	Settings for Printer Settings
<Grayscale Conversion>*1	<sRGB>, <NTSC>, <Uniform RGB>	Yes	Yes	Yes	Yes	C	Settings for Printer Settings

*1 Indicates items that appear only when the appropriate optional product is available for use or the appropriate setting is specified.

NOTE

- For information on the items ("A", "B", "C", and "No") in the "Import All Function" column, see [Import All Function\(P. 1054\)](#) .

Item	Setting Description	DeviceAdmin	NetworkAdmin	Can be set in Remote UI	Device Information Delivery Available	Import All Function	Name of Item When Exporting with the Remote UI
<Paper Save>	<On>, <Off>	Yes	Yes	Yes	Yes	C	Settings for Printer Settings
<Matching Method>	<General>, < Perceptual>, <Colorimetric>, <Vivid Photo>, <Download Profile>	Yes	Yes	Yes	Yes	C	Settings for Printer Settings
<Photo Correct. (Color Only)>							
<Photo Optimizer PRO>	<On>, <Off>	Yes	Yes	Yes	No	C	Settings for Printer Settings
<Red-Eye Correction>	<Red-Eye Correction>: <On>, <Off>	Yes	Yes	Yes	No	C	Settings for Printer Settings
	<Red-Eye Correction Level>*1: <Weak>, <Standard>, 						
<Face Brightener>	<Face Brightener>: <On>, <Off>	Yes	Yes	Yes	No	C	Settings for Printer Settings
	<Face Brightener Level>*1: <Weak>, <Standard>, 						
<Halftones>	<Text>: <Gradation>, <Resolution>, <Error Diffusion> <Graphics>: <Gradation>, <Resolution>, <Error Diffusion> <Image>: <Gradation>, <Resolution>, <Error Diffusion>	Yes	Yes	Yes	Yes	B	Settings for Printer Settings
<Gray Compensation>	<Text>: <On>, <Off> <Graphics>: <On>, <Off> <Image>: <On>, <Off>	Yes	Yes	Yes	Yes	B	Settings for Printer Settings
<Grayscale Conversion>*1	<Text>: <sRGB>, <NTSC>, <Uniform RGB> <Graphics>: <sRGB>, <NTSC>, <Uniform RGB>	Yes	Yes	Yes	Yes	C	Settings for Printer Settings

Settings/Registration

Item	Setting Description	DeviceAdmin	NetworkAdmin	Can be set in Remote UI	Device Information Delivery Available	Import All Function	Name of Item When Exporting with the Remote UI
	<Image>: <sRGB>, <NTSC>, <Uniform RGB>						

*1 Indicates items that appear only when the appropriate optional product is available for use or the appropriate setting is specified.

Utility

961F-ORW

NOTE

- For information on the items ("A", "B", "C", and "No") in the "Import All Function" column, see [▶ Import All Function\(P. 1054\)](#) .

Item	Setting Description	DeviceAdmin	NetworkAdmin	Can be set in Remote UI	Device Information Delivery Available	Import All Function	Name of Item When Exporting with the Remote UI
<Initialize PCL Storage>*1	<Yes>, <No>	Yes	Yes	No	No	No	-
<Initialize PS Storage>*1	<Yes>, <No>	Yes	Yes	No	No	No	-
<Reset Printer>	<Yes>, <No>	Yes	Yes	No	No	No	-

*1 Indicates items that appear only when the appropriate optional product is available for use or the appropriate setting is specified.

<Send>

Specify the settings for the send function.

- ▶<Output Report>(P. 1224)
- ▶<Common Settings>(P. 1224)
- ▶<E-Mail/I-Fax Settings>(P. 1224)
- ▶<Fax Settings>(P. 1224)

NOTE

Item marked with an asterisk (*)

- Only appears if your machine has a fax function.

<Output Report>

 (Settings/Registration) ▶ <Function Settings> ▶ <Send>

This prints a list of the registration details for the send/receive settings and fax settings.

- ▶<Output Report>(P. 1225)

<Common Settings>

 (Settings/Registration) ▶ <Function Settings> ▶ <Send>

Specify the settings common to the send function.

- ▶<Common Settings>(P. 1226)

<E-Mail/I-Fax Settings>

 (Settings/Registration) ▶ <Function Settings> ▶ <Send>

Specify the settings for sending E-mail and I-Faxes.

- ▶<E-Mail/I-Fax Settings>(P. 1239)

<Fax Settings> *

 (Settings/Registration) ▶ <Function Settings> ▶ <Send>

Specify the fax send settings.

- ▶<Fax Settings>(P. 1249)

<Output Report>

This prints a list of the registration details for the send/receive settings and fax settings.

▶<TX/RX User Data List>(P. 1225)

▶<Fax User Data List>(P. 1225)

NOTE

- For information on the items ("A", "B", "C", and "No") in the "Import All Function" column, see ▶<Import All Function>(P. 1054) .

Item marked with an asterisk (*)

- Only appears if your machine has a fax function.

<TX/RX User Data List>

 (Settings/Registration) ▶ <Function Settings> ▶ <Send> ▶ <Output Report>

You can print a list of the send/receive settings registered in the machine. ▶<Printing Reports and Lists>(P. 1026)

Item	Setting Description	DeviceAdmin	NetworkAdmin	Can be set in Remote UI	Device Information Delivery Available	Import All Function	Name of Item When Exporting with the Remote UI
<TX/RX User Data List>	<Yes>, <No>	Yes	Yes	Yes	No	No	-

<Fax User Data List> *

 (Settings/Registration) ▶ <Function Settings> ▶ <Send> ▶ <Output Report>

You can print a list of the fax settings registered in the machine. ▶<Printing Reports and Lists>(P. 1026)

Item	Setting Description	DeviceAdmin	NetworkAdmin	Can be set in Remote UI	Device Information Delivery Available	Import All Function	Name of Item When Exporting with the Remote UI
<Fax User Data List>	<Yes>, <No>	Yes	Yes	Yes	No	No	-

<Common Settings>

Specify the settings common to the send function.

- ▶<Register Favorite Settings>/<Edit Favorite Settings>(P. 1226)
- ▶<Display Confirmation for Favorite Settings>(P. 1227)
- ▶<Default Screen>(P. 1227)
- ▶<Restrict Address Book Use>(P. 1227)
- ▶<Change Default Settings>(P. 1228)
- ▶<Register Options Shortcuts>(P. 1228)
- ▶<TX Report>(P. 1228)
- ▶<Communication Management Report>(P. 1229)
- ▶<TX Terminal ID>(P. 1230)
- ▶<Delete Failed TX Jobs>(P. 1231)
- ▶<Retry Times>(P. 1231)
- ▶<Data Compression Ratio>(P. 1231)
- ▶<YCbCr TX Gamma Value>(P. 1232)
- ▶<Use Divided Chunk Send for WebDAV TX>(P. 1232)
- ▶<Confirm TLS Certificate for WebDAV TX>(P. 1233)
- ▶<Confirm TLS Certificate for FTPS TX>(P. 1233)
- ▶<Limit New Destination>(P. 1234)
- ▶<Always Add Device Signature to Send>(P. 1234)
- ▶<Limit E-Mail to Send to Myself>(P. 1235)
- ▶<Restrict File TX to Personal Folder>(P. 1235)
- ▶<Personal Folder Specification Method>(P. 1236)
- ▶<Restrict Resending from Log>(P. 1236)
- ▶<Archive TX Document>(P. 1237)
- ▶<Display Notification When Job Is Accepted>(P. 1237)
- ▶<Job to Cancel When Stop is Pressed>(P. 1237)

NOTE

- For information on the items ("A", "B", "C", and "No") in the "Import All Function" column, see ▶<Import All Function>(P. 1054) .

Item marked with an asterisk (*)

- Only appears if your machine has a fax function.

<Register Favorite Settings>/<Edit Favorite Settings>

 (Settings/Registration) ▶ <Function Settings> ▶ <Send> ▶ <Common Settings>

You can register frequently used settings in a button of the machine for later use when scanning. You can also assign a name to a button and enter a comment. You can also delete or rename registered settings. ▶<Registering a Combination of Frequently Used Functions>(P. 367)

Item	Setting Description	DeviceAdmin	NetworkAdmin	Can be set in Remote UI	Device Information Delivery Available	Import All Function	Name of Item When Exporting with the Remote UI
<Register Favorite Settings>	Confirm Settings	Yes	Yes	No	Yes	C	Favorite Settings
	Select Location: <M1> to <M18>	Yes	Yes	No	Yes	C	Favorite Settings
	<Show Comments>: <On>, <Off>	Yes	Yes	No	Yes	C	Settings/Registration Basic Information
	<Name>, <Comment>	Yes	Yes	No	Yes	C	Favorite Settings
<Edit Favorite Settings>	Select the Button: <M1> to <M18>	Yes	Yes	No	Yes* ¹	C	Favorite Settings Settings/Registration Basic Information
	<Show Comments>: <On>, <Off>						

Item	Setting Description	DeviceAdmin	NetworkAdmin	Can be set in Remote UI	Device Information Delivery Available	Import All Function	Name of Item When Exporting with the Remote UI
	<Delete>, <Check Content>, <Rename>						
	<Shortcut 2>: <Different Size Originals>, Each mode, <Unassigned>						

*1 <Show Comments>: No

<Display Confirmation for Favorite Settings>

 (Settings/Registration) ▶ <Function Settings> ▶ <Send> ▶ <Common Settings>

You can select whether to display a confirmation screen when recalling "Favorite Settings."

Item	Setting Description	DeviceAdmin	NetworkAdmin	Can be set in Remote UI	Device Information Delivery Available	Import All Function	Name of Item When Exporting with the Remote UI
<Display Confirmation for Favorite Settings>	<On>, <Off>	Yes	Yes	No	No	C	Settings/Registration Basic Information

<Default Screen>

 (Settings/Registration) ▶ <Function Settings> ▶ <Send> ▶ <Common Settings>

You can specify the screen to display when <Scan and Send> or  (Reset) is pressed.

Item	Setting Description	DeviceAdmin	NetworkAdmin	Can be set in Remote UI	Device Information Delivery Available	Import All Function	Name of Item When Exporting with the Remote UI
<Default Screen>	<Standard>, <One-Touch>, <Favorite Settings>, <Address Book>	Yes	Yes	No	No	C	Settings/Registration Basic Information

<Restrict Address Book Use>

 (Settings/Registration) ▶ <Function Settings> ▶ <Send> ▶ <Common Settings>

You can select whether to hide the Address Book and one-touch buttons on the Scan Basic Features screen, etc., as well as whether to restrict use of the Address Book.

Item	Setting Description	DeviceAdmin	NetworkAdmin	Can be set in Remote UI	Device Information Delivery Available	Import All Function	Name of Item When Exporting with the Remote UI
<Restrict Address Book Use>	<On>, <Off>	Yes	Yes	No	No	C	Settings/Registration Basic Information

<Change Default Settings>

 (Settings/Registration) ▶ <Function Settings> ▶ <Send> ▶ <Common Settings>

You can change the settings registered as default for the <Scan and Send> function.

Item	Setting Description	DeviceAdmin	NetworkAdmin	Can be set in Remote UI	Device Information Delivery Available	Import All Function	Name of Item When Exporting with the Remote UI
<Change Default Settings>	<Register>, <Initialize>	Yes	Yes	No	No	C	Favorite Settings

<Register Options Shortcuts>

 (Settings/Registration) ▶ <Function Settings> ▶ <Send> ▶ <Common Settings>

You can register modes in the shortcut keys displayed on the <Scan and Send> screen. This feature is useful when you want to register frequently used functions.  **Customizing the Basic Features Screen(P. 370)**

Item	Setting Description	DeviceAdmin	NetworkAdmin	Can be set in Remote UI	Device Information Delivery Available	Import All Function	Name of Item When Exporting with the Remote UI
<Register Options Shortcuts>	<Shortcut 1>: <2-Sided Original>, Each mode, <Unassigned> <Shortcut 2>: <Different Size Originals>, Each mode, <Unassigned>	Yes	Yes	No	No	C	Favorite Settings

<TX Report>

 (Settings/Registration) ▶ <Function Settings> ▶ <Send> ▶ <Common Settings>

A TX Report is a report that enables you to check whether documents were sent correctly to their intended destinations. The machine can be set to print this report automatically after documents are sent or only when a transmission error occurs. You can also specify the setting to print the first part of the document as part of the report to remind you of the document's contents.  **TX Report(P. 1030)**

- <Allow Printing from Options> can be set if <For Error Only> or <Off> is selected. If you set <Allow Printing from Options> to <On>, you can set whether to print a TX report from <Options> for each job.

Item	Setting Description	DeviceAdmin	NetworkAdmin	Can be set in Remote UI	Device Information Delivery Available	Import All Function	Name of Item When Exporting with the Remote UI
<TX Report>	<For Error Only>, <On>, <Off>	Yes	No	Yes	Yes	C	Settings/ Registration Basic Information
	When <On> is selected: <Allow Printing from Options>: <On>, <Off> <Report with TX Image>: <On>, <Off> <Report with Color TX Image>: <On>, <Off>						
	When <On> is selected: <Report with TX Image>: <On>, <Off> <Report with Color TX Image>: <On>, <Off>						
	When <Off> is selected: <Allow Printing from Options>: <On>, <Off> <Report with TX Image>: <On>, <Off> <Report with Color TX Image>: <On>, <Off>						

NOTE

- This setting links with the <TX Report> setting in <Options> for each function.

<Communication Management Report>

 (Settings/Registration) ► <Function Settings> ► <Send> ► <Common Settings>

You can print or send document sending/receiving logs as a report. The machine can be set to print or send this report when a specified number of communications (100 to 1,000) is reached or at a specified time. The send/receive reports can also be printed or sent separately.  **Communication Management Report(P. 1029)**

- When the report is sent as data, it is sent in the CSV file format.

Item	Setting Description	DeviceAdmin	NetworkAdmin	Can be set in Remote UI	Device Information Delivery Available	Import All Function	Name of Item When Exporting with the Remote UI
<Communication Management Report>	<Print/Send Every Specified No. of Transm.>: <Print>, <Send>, <Off>	Yes	No	Yes	Yes	C	Settings/ Registration Basic Information

Item	Setting Description	DeviceAdmin	NetworkAdmin	Can be set in Remote UI	Device Information Delivery Available	Import All Function	Name of Item When Exporting with the Remote UI
	Number of transmissions: 100 to 1000						
	<Print/Send at Specified Time>: <Print>, <Send>, < Off >						
	Specify Print Time: 00:00 to 23:59						
	<Print Send/Receive Jobs Separately>: On, Off <Send Destination>						



<TX Terminal ID>

 (Settings/Registration) ▶ <Function Settings> ▶ <Send> ▶ <Common Settings>

You can select whether to add the sender information to the top of a sent document when sending a fax/I-fax. Information such as the fax number, name, and I-fax address of the machine is printed, enabling the recipient to check who sent the document.

Item	Setting Description	DeviceAdmin	NetworkAdmin	Can be set in Remote UI	Device Information Delivery Available	Import All Function	Name of Item When Exporting with the Remote UI
<TX Terminal ID>	< Print >, <Do Not Print>	Yes	Yes	Yes	Yes	C	Settings/Registration Basic Information
	<Print Position>: <Inside>, < Outside >						
	<Display Destination Unit Name>: < On >, <Off>						
	<Telephone No. Mark>: < Fax >, <TEL>						

NOTE

- The information registered in <Register Unit Telephone Number> and <Register Unit Name> is printed as the sender information.  **Fax Line Settings(P. 314)**
- When printing the sender's name instead of the unit name, register the name in  <Register Sender Name (TTI)>(P. 1251) and specify it from <Sender Name (TTI)>.  **Faxing(P. 519)**

Models with an optional fax function

- The settings of the server machine are used when sending remote faxes.

<Delete Failed TX Jobs>

 (Settings/Registration) ► <Function Settings> ► <Send> ► <Common Settings>

You can select whether to automatically delete a document from memory when the sending/saving error occurs. Selecting <Off> enables you to resend/resave the documents that failed to send/save.

Item	Setting Description	DeviceAdmin	NetworkAdmin	Can be set in Remote UI	Device Information Delivery Available	Import All Function	Name of Item When Exporting with the Remote UI
<Delete Failed TX Jobs>	<On>, <Off>	Yes	Yes	Yes	Yes	C	Settings/Registration Basic Information

NOTE

- If this mode is set to <Off>, the status of any job with a forwarding error will be saved in <Job Status> on the <Status Monitor> screen.

<Retry Times>

 (Settings/Registration) ► <Function Settings> ► <Send> ► <Common Settings>

You can set the number of times that the machine tries to automatically resend data when the data cannot be sent because the recipient is busy sending or receiving, or when an error occurs.

Item	Setting Description	DeviceAdmin	NetworkAdmin	Can be set in Remote UI	Device Information Delivery Available	Import All Function	Name of Item When Exporting with the Remote UI
<Retry Times>	0 to 3 to 5 times	Yes	Yes	Yes	Yes	C	Settings/Registration Basic Information

NOTE

- This setting is disabled when sending faxes.

<Data Compression Ratio>

 (Settings/Registration) ► <Function Settings> ► <Send> ► <Common Settings>

You can set the compression ratio for color/grayscale scanned data.

Item	Setting Description	DeviceAdmin	NetworkAdmin	Can be set in Remote UI	Device Information Delivery Available	Import All Function	Name of Item When Exporting with the Remote UI
<Data Compression Ratio>	<High Ratio>, < Normal >, <Low Ratio>	Yes	Yes	Yes	Yes	C	Settings/Registration Basic Information

NOTE

- If you want to select compact or trace & smooth for the PDF file format or select compact for the XPS file format, it is recommended that you set <Data Compression Ratio> to <Normal> or <Low Ratio>. If you set it to <High Ratio>, images may be output in low quality even if you select <Quality Priority> in <Generate File> ▶ <Image Quality Level for Limited Color/Compact>.
- This setting is disabled when sending faxes.

<YCbCr TX Gamma Value>

 (Settings/Registration) ▶ <Function Settings> ▶ <Send> ▶ <Common Settings>

If you are sending a document in color or grayscale, you can specify the gamma value to use when converting scanned RGB image data to YCbCr. You can reproduce the image with the optimal image quality at the recipient by setting an appropriate gamma value.

Item	Setting Description	DeviceAdmin	NetworkAdmin	Can be set in Remote UI	Device Information Delivery Available	Import All Function	Name of Item When Exporting with the Remote UI
<YCbCr TX Gamma Value>	<Gamma 1.0>, <Gamma 1.4>, <Gamma 1.8> , <Gamma 2.2>	Yes	Yes	Yes	Yes	C	Settings/Registration Basic Information

IMPORTANT

- This setting is disabled for the following file formats:
 - PDF (Compact)
 - XPS (Compact)
 - PDF (Trace&Smooth)

NOTE

- This setting is disabled when sending to a mail box.
- This setting is disabled when sending faxes.

<Use Divided Chunk Send for WebDAV TX>

 (Settings/Registration) ▶ <Function Settings> ▶ <Send> ▶ <Common Settings>

You can divide data into chunks when sending with WebDAV. Chunked encoding is a function for sending a file with an unknown size by dividing it into chunks of a known length. It enables the sending time to be reduced because it is not necessary to calculate the size of the file before sending it.

Item	Setting Description	DeviceAdmin	NetworkAdmin	Can be set in Remote UI	Device Information Delivery Available	Import All Function	Name of Item When Exporting with the Remote UI
<Use Divided Chunk Send for WebDAV TX>	<On>, <Off>	Yes	Yes	Yes	Yes	C	Settings/Registration Basic Information

IMPORTANT

- You may not be able to send files with chunked encoding, depending on certain conditions for the WebDAV server and proxy server.

<Confirm TLS Certificate for WebDAV TX>

 (Settings/Registration) ▶ <Function Settings> ▶ <Send> ▶ <Common Settings>

You can check whether the TLS server certificate is valid when sending with WebDAV. You can verify the validity of the certificate and reliability of the certificate chain, as well as confirm the CN (Common Name).

Item	Setting Description	DeviceAdmin	NetworkAdmin	Can be set in Remote UI	Device Information Delivery Available	Import All Function	Name of Item When Exporting with the Remote UI
<Confirm TLS Certificate for WebDAV TX>	<On>, <Off>	No	No	Yes	No	C	Settings/Registration Basic Information
	When <On> is selected: <CN>: On, Off						

IMPORTANT

- If you do not verify the certificate, TLS communication is performed, even with an invalid certificate.

NOTE

- If there is a problem with the certificate, WebDAV sending will fail.

<Confirm TLS Certificate for FTPS TX>

 (Settings/Registration) ▶ <Function Settings> ▶ <Send> ▶ <Common Settings>

You can check whether the TLS server certificate is valid when sending with FTPS. You can verify the validity of the certificate and reliability of the certificate chain, as well as confirm the CN (Common Name).

Item	Setting Description	DeviceAdmin	NetworkAdmin	Can be set in Remote UI	Device Information Delivery Available	Import All Function	Name of Item When Exporting with the Remote UI
<Confirm TLS Certificate for FTPS TX>	<On>, <Off>	No	No	Yes	No	C	Settings/Registration Basic Information

Item	Setting Description	DeviceAdmin	NetworkAdmin	Can be set in Remote UI	Device Information Delivery Available	Import All Function	Name of Item When Exporting with the Remote UI
	When <On> is selected: <CN>: On, Off						

<Limit New Destination>

 (Settings/Registration) ▶ <Function Settings> ▶ <Send> ▶ <Common Settings>

When sending faxes and scanned data, the available destinations can be limited to the following three ways, to ensure that users cannot specify the destination by entering text.

- Destinations registered in the address book and one-touch buttons
- Destinations set in <Favorite Settings> and <Send to Myself>
- Destinations that can be searched for with an LDAP server

Item	Setting Description	DeviceAdmin	NetworkAdmin	Can be set in Remote UI	Device Information Delivery Available	Import All Function	Name of Item When Exporting with the Remote UI
<Limit New Destination>	<Fax>*1: <On>, <Off>	Yes	No	Yes	Yes	C	Settings/Registration Basic Information
	<E-Mail>: <On>, <Off>						
	<I-Fax>: <On>, <Off>						
	<File>: <On>, <Off>						

*1 Only appears if your machine has a fax function.

<Always Add Device Signature to Send>

 (Settings/Registration) ▶ <Function Settings> ▶ <Send> ▶ <Common Settings>

You can select whether to always add a device signature to sent PDF/XPS files.

Item	Setting Description	DeviceAdmin	NetworkAdmin	Can be set in Remote UI	Device Information Delivery Available	Import All Function	Name of Item When Exporting with the Remote UI
<Always Add Device Signature to Send>	<On>, <Off>	Yes	No	Yes	Yes	C	Settings/Registration Basic Information
	When <On> is selected:						

Item	Setting Description	DeviceAdmin	NetworkAdmin	Can be set in Remote UI	Device Information Delivery Available	Import All Function	Name of Item When Exporting with the Remote UI
	<Restrict File Formats>: <On>, <Off>						

NOTE

- If you set <Restrict File Formats> to <On>, files other than PDF/XPS files cannot be sent.

<Limit E-Mail to Send to Myself>

 (Settings/Registration) ▶ <Function Settings> ▶ <Send> ▶ <Common Settings>

You can limit the destination that can be specified when sending e-mail to the e-mail address of the user that is logged in. This setting enables you to prevent information leaks due to transmission to a wrong destination.

Item	Setting Description	DeviceAdmin	NetworkAdmin	Can be set in Remote UI	Device Information Delivery Available	Import All Function	Name of Item When Exporting with the Remote UI
<Limit E-Mail to Send to Myself>	<On>, <Off>	Yes	No	Yes	Yes	C	Settings/Registration Basic Information

IMPORTANT

- This setting applies to users with the GeneralUser role.

<Restrict File TX to Personal Folder>

 (Settings/Registration) ▶ <Function Settings> ▶ <Send> ▶ <Common Settings>

You can limit the destination that can be specified when saving to a file server to the dedicated folder of the user that is logged in. This setting enables you to prevent information leaks due to transmission to a wrong destination.

Item	Setting Description	DeviceAdmin	NetworkAdmin	Can be set in Remote UI	Device Information Delivery Available	Import All Function	Name of Item When Exporting with the Remote UI
<Restrict File TX to Personal Folder>	<On>, <Off>	Yes	No	Yes	Yes	C	Settings/Registration Basic Information

IMPORTANT

- This setting applies to users with the GeneralUser role.

<Personal Folder Specification Method>

 (Settings/Registration) ▶ <Function Settings> ▶ <Send> ▶ <Common Settings>

A Personal folder is an individual folder that can be used by the user logged in with personal authentication management. Shared folders and file servers can be specified and used as a Personal folder.  **Configuring Personal Folders(P. 846)**

Item	Setting Description	DeviceAdmin	NetworkAdmin	Can be set in Remote UI	Device Information Delivery Available	Import All Function	Name of Item When Exporting with the Remote UI
<Personal Folder Specification Method>	<Home Folder>, <Register for Each User>, <Use Login Server>	Yes	No	Yes	Yes	C	Settings/ Registration Basic Information
	When <Home Folder> is selected: <Set>, <Use Authentication Info. of Each User>						
	<Set>: <Protocol>(<Windows (SMB)>, <WebDAV>), <Host Name>, <Folder Path>						
	When <Use Login Server> is selected: <Use Authentication Info. of Each User>						

NOTE

- A Personal folder is a folder shared by the following screens.
 - <Scan and Send>
 - <Network> in <Scan and Store>
 - <Network> in <Access Stored Files>

<Restrict Resending from Log> *

 (Settings/Registration) ▶ <Function Settings> ▶ <Send> ▶ <Common Settings>

You can select whether to prevent users from recalling the logs for the destinations and scan settings specified in the past. Selecting <On> hides the <Previous Settings> buttons from both the Fax Basic Features screen and the Scan Basic Features screen.

Item	Setting Description	DeviceAdmin	NetworkAdmin	Can be set in Remote UI	Device Information Delivery Available	Import All Function	Name of Item When Exporting with the Remote UI
<Restrict Resending from Log>	<On>, <Off>	No	No	Yes	No	C	Settings/Registration Basic Information

<Archive TX Document> *

 (Settings/Registration) ▶ <Function Settings> ▶ <Send> ▶ <Common Settings>

You can save a copy of a sent fax in a pre-specified destination (e-mail or file server, etc.).  **Saving a Copy of a Sent Document(P. 562)**

Item	Setting Description	DeviceAdmin	NetworkAdmin	Can be set in Remote UI	Device Information Delivery Available	Import All Function	Name of Item When Exporting with the Remote UI
<Archive TX Document>	<Use TX Document Archiving>: <On>, <Off> When <On> is selected: <Backup Location>: Select Addresses, Address Details, Register Addresses <Folder Name>: <Sender Information>, <Date>, <Off (Do Not Create)> <File Format>: <TIFF>, <PDF>	Yes	No	Yes	Yes	C	Settings/Registration Basic Information

<Display Notification When Job Is Accepted>

 (Settings/Registration) ▶ <Function Settings> ▶ <Send> ▶ <Common Settings>

You can select whether to display a screen prompting you to check the communication status after sending/saving documents using <Fax> or <Scan and Send> ( **<Home> Screen(P. 332)**).

Item	Setting Description	DeviceAdmin	NetworkAdmin	Can be set in Remote UI	Device Information Delivery Available	Import All Function	Name of Item When Exporting with the Remote UI
<Display Notification When Job Is Accepted>	<On>, <Off>	Yes	Yes	No	Yes	C	Settings/Registration Basic Information

<Job to Cancel When Stop is Pressed>

 (Settings/Registration) ▶ <Function Settings> ▶ <Send> ▶ <Common Settings>

Select the send job to cancel when the Stop key is pressed while a send job of the Fax function or the Scan and Send function is being processed. You can select either <Latest Received Job> or <Job Being Sent>.

Item	Setting Description	DeviceAdmin	NetworkAdmin	Can be set in Remote UI	Device Information Delivery Available	Import All Function	Name of Item When Exporting with the Remote UI
<Job to Cancel When Stop is Pressed>	<Latest Received Job>, <Job Being Sent>	Yes	No	Yes	Yes	C	Settings/Registration Basic Information

NOTE

- If you selected <Job Being Sent> and the machine has multiple fax lines that are currently being used for sending, the last of those jobs is canceled.

<E-Mail/I-Fax Settings>

Specify the settings for sending E-mail and I-Faxes.

- ▶ <Register Unit Name>(P. 1239)
- ▶ <Communication Settings>(P. 1239)
- ▶ <Specify Port Number for SMTP TX/POP RX>(P. 1241)
- ▶ <S/MIME Settings>(P. 1241)
- ▶ <Confirm TLS Certificate for SMTP TX>(P. 1242)
- ▶ <Confirm TLS Certificate for POP RX>(P. 1243)
- ▶ <Maximum Data Size for Sending>(P. 1243)
- ▶ <Default Subject>(P. 1244)
- ▶ <Specify Authentication User for Reply-To>(P. 1244)
- ▶ <Allow Unregistered Users to Send E-Mail>(P. 1244)
- ▶ <Specify Authentication User as Sender for E-Mail>(P. 1245)
- ▶ <Specify Authentication User as Sender for I-Fax>(P. 1245)
- ▶ <Full Mode TX Timeout>(P. 1246)
- ▶ <Print MDN/DSN upon Receipt>(P. 1246)
- ▶ <Use Send via Server>(P. 1246)
- ▶ <Allow MDN Not via Server>(P. 1247)
- ▶ <Restrict TX Destination Domain>(P. 1247)
- ▶ <Auto Complete for Entering E-Mail Addresses>(P. 1247)
- ▶ <Auto Add Specified Domain to Dest. Without Domain>(P. 1248)

NOTE

- For information on the items ("A", "B", "C", and "No") in the "Import All Function" column, see ▶ **Import All Function(P. 1054)** .

<Register Unit Name>

 (Settings/Registration) ▶ <Function Settings> ▶ <Send> ▶ <E-Mail/I-Fax Settings>

You can register the name of your company or department as the unit name. The registered name is displayed/printed at the recipient as the sender information when you send an e-mail/I-fax.

Item	Setting Description	DeviceAdmin	NetworkAdmin	Can be set in Remote UI	Device Information Delivery Available	Import All Function	Name of Item When Exporting with the Remote UI
<Register Unit Name>	Register Unit Name	Yes	Yes	Yes	No	C	Settings/Registration Basic Information

NOTE

- The registered unit name is used as the e-mail address display name, in the format "unit name <e-mail address>".
- You can enter up to 24 characters for the unit name.
- The e-mail address used in the login service appears in the From field on the recipient's machine for e-mail messages and I-fax documents. ▶ **Registering User Information in the Local Device(P. 809)**
- If you press <E-Mail/I-Fax Settings> ▶ set <Specify Authentication User as Sender for E-Mail> and <Specify Authentication User as Sender for I-Fax> to <On>, the e-mail and I-fax address registered for the login user is displayed as the sender's name in the From field for the recipient, regardless of the login service being used.

<Communication Settings>

 (Settings/Registration) ▶ <Function Settings> ▶ <Send> ▶ <E-Mail/I-Fax Settings>

You can specify the settings for a mail server and an authentication method that you are using for e-mails/I-faxes. **Setting E-mail/I-Fax Communication(P. 316)**

Item	Setting Description	DeviceAdmin	NetworkAdmin	Can be set in Remote UI	Device Information Delivery Available	Import All Function	Name of Item When Exporting with the Remote UI
<Communication Settings>	<SMTP RX>: <On>, <Off>	Yes	Yes	Yes	Yes	C	Settings/Registration Basic Information
	<POP>: <On>, <Off>	Yes	Yes	Yes	Yes	C	Settings/Registration Basic Information
	<SMTP Server>: Enter the SMTP Server	Yes	Yes	Yes	No	C	Settings/Registration Basic Information
	<E-Mail Address>: Enter the E-Mail Address	Yes	Yes	Yes	No	A	Settings/Registration Basic Information
	<POP Server>: Enter the POP Server	Yes	Yes	Yes	No	C	Settings/Registration Basic Information
	<POP Login Name>: Enter the POP Login Name	Yes	Yes	Yes	No	A	Settings/Registration Basic Information
	<POP Password>: Enter the POP Password	Yes	Yes	Yes	No	A	Settings/Registration Basic Information
	<POP Interval>: 0 to 99 minutes	Yes	Yes	Yes	No	C	Settings/Registration Basic Information
	<Authent./Encryption>	Yes	Yes	Yes	No	No	-
	<POP Auth. Method>: <Standard>, <APOP>, <POP AUTH>	Yes	Yes	Yes	Yes	C	Settings/Registration Basic Information
	<POP Authentication Before Sending>: <On>, <Off>	Yes	Yes	Yes	No	C	Settings/Registration Basic Information
	<SMTP Authentication (SMTP AUTH)>: <On>, <Off>	Yes	Yes	Yes	No	C	Settings/Registration Basic Information
	<Allow TLS (SMTP RX)>: <Always TLS>, <On>, <Off>	Yes	Yes	Yes	No	C	Settings/Registration Basic Information
	<Allow TLS (POP)>: <On>, <Off>	Yes	Yes	Yes	No	C	Settings/Registration Basic Information

Item	Setting Description	DeviceAdmin	NetworkAdmin	Can be set in Remote UI	Device Information Delivery Available	Import All Function	Name of Item When Exporting with the Remote UI
	<Allow TLS (SMTP TX)>: <On>, <Off>	Yes	Yes	Yes	No	C	Settings/Registration Basic Information
	<Display Auth. Screen When Sending>: <On>, <Off>	Yes	Yes	Yes	No	C	Settings/Registration Basic Information

IMPORTANT

- If you set shorter than 10 minutes (excluding '0 min') for <POP Interval>, the machine will not completely enter the Sleep mode.

NOTE

- The machine can only receive I-faxes and communication error notices.

<Specify Port Number for SMTP TX/POP RX>

 (Settings/Registration) ▶ <Function Settings> ▶ <Send> ▶ <E-Mail/I-Fax Settings>

You can change the port number of the SMTP and POP.

Item	Setting Description	DeviceAdmin	NetworkAdmin	Can be set in Remote UI	Device Information Delivery Available	Import All Function	Name of Item When Exporting with the Remote UI
<Specify Port Number for SMTP TX/POP RX>	<SMTP TX>, <POP RX>	Yes	Yes	Yes	Yes	C	Settings/Registration Basic Information
	<SMTP TX>: 1 to 25 to 65535 <POP RX>: 1 to 110 to 65535						

<S/MIME Settings>

 (Settings/Registration) ▶ <Function Settings> ▶ <Send> ▶ <E-Mail/I-Fax Settings>

You can set S/MIME. If you set S/MIME, you can add a digital signature or encrypt the e-mail when using the e-mail/I-fax function.

■ Setting E-Mail Encryption

- Press  (Settings/Registration).
- Press <Function Settings> ▶ <Send> ▶ <E-Mail/I-Fax Settings> ▶ <S/MIME Settings>.

3 Set encryption and the digital signature.

4 Press <OK>.

NOTE

- It is necessary to register the public key certificate of the recipient in advance. [▶ Generating the Key and Certificate for Network Communication\(P. 867\)](#)

Item	Setting Description	DeviceAdmin	NetworkAdmin	Can be set in Remote UI	Device Information Delivery Available	Import All Function	Name of Item When Exporting with the Remote UI
<S/MIME Settings>	<Encryption Settings>: <Always Encrypt>, <Only Encrypt If Certificate>, <Do Not Encrypt> <Add Digital Signatures>: <On>, <Off>	Yes	No	Yes	Yes	C	Settings/Registration Basic Information
	When Encryption is selected: <Encryption Algorithm>: <3DES>, <AES128>, <AES256> <Signature Algorithm>: <SHA1>, <SHA256>, <SHA384>, <SHA512> <Verify Signature upon Receipt>: <On>, <Off> <Print Signature upon Receipt>: <On>, <Off>						

<Confirm TLS Certificate for SMTP TX>

 (Settings/Registration) ▶ <Function Settings> ▶ <Send> ▶ <E-Mail/I-Fax Settings>

You can check whether the TLS server certificate is valid when sending with SMTP. You can verify the validity of the certificate and reliability of the certificate chain, as well as confirm the CN (Common Name).

Item	Setting Description	DeviceAdmin	NetworkAdmin	Can be set in Remote UI	Device Information Delivery Available	Import All Function	Name of Item When Exporting with the Remote UI
<Confirm TLS Certificate for SMTP TX>	<On>, <Off>	No	No	Yes	No	C	Settings/Registration Basic Information
	When <On> is selected: <CN>: On, Off						

IMPORTANT

- If you do not verify the certificate, TLS communication is performed, even with an invalid certificate.

NOTE

- If there is a problem with the certificate, SMTP sending will fail.

<Confirm TLS Certificate for POP RX>

 (Settings/Registration) ▶ <Function Settings> ▶ <Send> ▶ <E-Mail/I-Fax Settings>

You can check whether the TLS server certificate is valid when receiving with POP. You can verify the validity of the certificate and reliability of the certificate chain, as well as confirm the CN (Common Name).

Item	Setting Description	DeviceAdmin	NetworkAdmin	Can be set in Remote UI	Device Information Delivery Available	Import All Function	Name of Item When Exporting with the Remote UI
<Confirm TLS Certificate for POP RX>	<On>, <Off>	No	No	Yes	No	C	Settings/Registration Basic Information
	When <On> is selected: <CN>: On, Off						

! IMPORTANT

- If you do not verify the certificate, TLS communication is performed, even with an invalid certificate.

NOTE

- If there is a problem with the certificate, POP receiving will fail.

<Maximum Data Size for Sending>

 (Settings/Registration) ▶ <Function Settings> ▶ <Send> ▶ <E-Mail/I-Fax Settings>

You can set the maximum data size for outgoing e-mail messages and I-fax documents. If an e-mail message exceeds this data size limit, it is split up into several e-mail messages before being sent. However, if an I-fax transmission exceeds the data size limit, it is handled as an error, and not sent.

Item	Setting Description	DeviceAdmin	NetworkAdmin	Can be set in Remote UI	Device Information Delivery Available	Import All Function	Name of Item When Exporting with the Remote UI
<Maximum Data Size for Sending>	0 to 3 to 99 MB	Yes	No	Yes	Yes	C	Settings/Registration Basic Information

NOTE

- If you enter '0' MB as the data size, there is no size limit on the data that is sent.
- Set the maximum data size for sending lower than the data limit for the mail server.

<Default Subject>

 (Settings/Registration) ► <Function Settings> ► <Send> ► <E-Mail/I-Fax Settings>

You can set the subject to specify automatically if you do not enter a subject when sending an e-mail/I-fax.

Item	Setting Description	DeviceAdmin	NetworkAdmin	Can be set in Remote UI	Device Information Delivery Available	Import All Function	Name of Item When Exporting with the Remote UI
<Default Subject>	Enter the Subject, Attached Image	Yes	No	Yes	Yes	C	Settings/Registration Basic Information

<Specify Authentication User for Reply-To>

 (Settings/Registration) ► <Function Settings> ► <Send> ► <E-Mail/I-Fax Settings>

You can select whether to set the e-mail address of a user who logs in to the machine with personal authentication management as the reply-to address when sending an e-mail/I-fax.

Item	Setting Description	DeviceAdmin	NetworkAdmin	Can be set in Remote UI	Device Information Delivery Available	Import All Function	Name of Item When Exporting with the Remote UI
<Specify Authentication User for Reply-To>	<On>, <Off>	Yes	No	Yes	No	C	Settings/Registration Basic Information

NOTE

- If logging in using User Authentication, the login name appears in <100> of the Sender Name (TTI) list. If <On> is selected, the login name in <100> is automatically set as the <Sender Name (TTI)> in <Options>.
- If you enter an e-mail address as the reply-to destination in <Options> when sending an e-mail message or I-fax document, that e-mail address is given priority, even if <Specify Authentication User for Reply-To> is set to <On>.

<Allow Unregistered Users to Send E-Mail>

 (Settings/Registration) ► <Function Settings> ► <Send> ► <E-Mail/I-Fax Settings>

When the machine is in use with personal authentication management, you can select whether to allow the sending of an e-mail from a user whose e-mail address is not registered in the machine. If <Off> is selected, users with their e-mail addresses registered can only send e-mails.

Item	Setting Description	DeviceAdmin	NetworkAdmin	Can be set in Remote UI	Device Information Delivery Available	Import All Function	Name of Item When Exporting with the Remote UI
<Allow Unregistered Users to Send E-Mail>	<On>, <Off>	Yes	No	Yes	Yes	C	Settings/Registration Basic Information

NOTE

- If you set <Specify Authentication User as Sender for E-Mail> and <Specify Authentication User as Sender for I-Fax> to <Off>, the address registered in the Device Information settings is displayed at the receiving end.

<Specify Authentication User as Sender for E-Mail>

 (Settings/Registration) ▶ <Function Settings> ▶ <Send> ▶ <E-Mail/I-Fax Settings>

Specify whether the E-mail addresses of users who log in using personal authentication management are set as the sender (From) on the E-mail recipient's system.

Item	Setting Description	DeviceAdmin	NetworkAdmin	Can be set in Remote UI	Device Information Delivery Available	Import All Function	Name of Item When Exporting with the Remote UI
<Specify Authentication User as Sender for E-Mail>	<From Header>: <On>, <Off> <Return-Path Header> : <On>, <Off>	Yes	No	Yes	No	C	Settings/Registration Basic Information

NOTE

- Depending on the destination environment, it may not be possible to send E-mail unless the From Header and Return-Path Header match.

<Specify Authentication User as Sender for I-Fax>

 (Settings/Registration) ▶ <Function Settings> ▶ <Send> ▶ <E-Mail/I-Fax Settings>

Specify whether the E-mail addresses of users who log in using personal authentication management are set as the sender (From) on the I-Fax recipient's system.

Item	Setting Description	DeviceAdmin	NetworkAdmin	Can be set in Remote UI	Device Information Delivery Available	Import All Function	Name of Item When Exporting with the Remote UI
<Specify Authentication User as Sender for I-Fax>	<From Header>: <On>, <Off> <Return-Path Header> : <On>, <Off>	Yes	No	Yes	No	C	Settings/Registration Basic Information

NOTE

- Depending on the destination environment, it may not be possible to send E-mail unless the From Header and Return-Path Header match.

<Full Mode TX Timeout>

 (Settings/Registration) ▶ <Function Settings> ▶ <Send> ▶ <E-Mail/I-Fax Settings>

You can set the time before sending operations automatically terminate if an MDN (notification e-mail confirming the transmission result) is not received from the recipient when sending an I-fax in the <Full> mode.

Item	Setting Description	DeviceAdmin	NetworkAdmin	Can be set in Remote UI	Device Information Delivery Available	Import All Function	Name of Item When Exporting with the Remote UI
<Full Mode TX Timeout>	1 to 24 to 99 hr.	Yes	No	Yes	Yes	C	Settings/Registration Basic Information

<Print MDN/DSN upon Receipt>

 (Settings/Registration) ▶ <Function Settings> ▶ <Send> ▶ <E-Mail/I-Fax Settings>

In I-fax Full Mode, e-mail messages are sent to the machine from the recipient and the mail server, notifying you whether I-faxes are sent to destinations successfully or not. You can select whether to print these notification e-mails when the machine receives them.

Item	Setting Description	DeviceAdmin	NetworkAdmin	Can be set in Remote UI	Device Information Delivery Available	Import All Function	Name of Item When Exporting with the Remote UI
<Print MDN/DSN upon Receipt>	<On>, <Off>	Yes	No	Yes	Yes	C	Settings/Registration Basic Information

NOTE

- I-fax delivery can also be confirmed in the TX Report.  **TX Report(P. 1030)**

<Use Send via Server>

 (Settings/Registration) ▶ <Function Settings> ▶ <Send> ▶ <E-Mail/I-Fax Settings>

You can select whether to allow users to change the setting of <Send via Server> when sending I-faxes.

Item	Setting Description	DeviceAdmin	NetworkAdmin	Can be set in Remote UI	Device Information Delivery Available	Import All Function	Name of Item When Exporting with the Remote UI
<Use Send via Server>	<On>, <Off>	Yes	No	Yes	Yes	C	Settings/Registration Basic Information

NOTE

- For I-fax, if <Send via Server> is set to <Off>, there is no size limit on the data that is sent, even if you enter the maximum data size for sending.

<Allow MDN Not via Server>

 (Settings/Registration) ▶ <Function Settings> ▶ <Send> ▶ <E-Mail/I-Fax Settings>

The machine receiving the I-fax can send an MDN (a notification e-mail for checking the sending result) to the IP address of the sending machine without going through a mail server.

Item	Setting Description	DeviceAdmin	NetworkAdmin	Can be set in Remote UI	Device Information Delivery Available	Import All Function	Name of Item When Exporting with the Remote UI
<Allow MDN Not via Server>	<On>, <Off>	Yes	No	Yes	Yes	C	Settings/Registration Basic Information

<Restrict TX Destination Domain>

 (Settings/Registration) ▶ <Function Settings> ▶ <Send> ▶ <E-Mail/I-Fax Settings>

You can set to only allow sending to addresses in a specified domain when sending an e-mail or I-fax.

Item	Setting Description	DeviceAdmin	NetworkAdmin	Can be set in Remote UI	Device Information Delivery Available	Import All Function	Name of Item When Exporting with the Remote UI
<Restrict TX Destination Domain>	<Restrict Sending to Domains>: <On>, <Off>	Yes	No	Yes	Yes* ¹	C	Settings/Registration Basic Information
	When <On> is selected: <Register>, <Details/Edit>, <Delete>						

*1 <Details/Edit>: No, <Delete>: No

<Auto Complete for Entering E-Mail Addresses>

 (Settings/Registration) ▶ <Function Settings> ▶ <Send> ▶ <E-Mail/I-Fax Settings>

You can set to automatically display e-mail addresses registered in the Address Book or an LDAP server based on the initial characters of an e-mail address entry.

Item	Setting Description	DeviceAdmin	NetworkAdmin	Can be set in Remote UI	Device Information Delivery Available	Import All Function	Name of Item When Exporting with the Remote UI
<Auto Complete for Entering E-Mail Addresses>	<Off>, <Address Book (Local)>, <LDAP Server>	Yes	No	No	No	C	Settings/Registration Basic Information

NOTE

- E-mail addresses that are stored with an access number do not appear.

<Auto Add Specified Domain to Dest. Without Domain>

 (Settings/Registration) ► <Function Settings> ► <Send> ► <E-Mail/I-Fax Settings>

You can register frequently used domain names in advance to eliminate the need to enter a domain when specifying an address because a domain name with @ is automatically appended. If you want to send to "123@example.com", register the domain name "example.com". If you specify an address that already includes a domain with this setting on, the domains in this setting are invalid.

Item	Setting Description	DeviceAdmin	NetworkAdmin	Can be set in Remote UI	Device Information Delivery Available	Import All Function	Name of Item When Exporting with the Remote UI
<Auto Add Specified Domain to Dest. Without Domain>	<Domain Name> <When Sending E-Mail>: <On>, <Off> <When Sending I-Fax>: <On>, <Off>	Yes	No	No	No	C	Settings/Registration Basic Information

NOTE

- Note the following when importing the Address Book to another device.
 - Since this setting follows the settings of the device you are using, the domain may differ from that assigned by the device. Check this setting before using it with another device.
 - If you import addresses without domain information to a device that does not have this setting, you may not be able to send because the addresses are invalid.

<Fax Settings>

Specify the fax send settings.

- ▶ <Register Favorite Settings>/<Edit Favorite Settings>(P. 1249)
- ▶ <Display Confirmation for Favorite Settings>(P. 1250)
- ▶ <Default Screen>(P. 1250)
- ▶ <Restrict Address Book Use>(P. 1250)
- ▶ <Change Default Settings>(P. 1251)
- ▶ <Register Options Shortcuts>(P. 1251)
- ▶ <Register Sender Name (TTI)>(P. 1251)
- ▶ <Use Authentication User Name as Sender Name>(P. 1252)
- ▶ <ECM TX>(P. 1252)
- ▶ <Set Pause Time>(P. 1253)
- ▶ <Auto Redial>(P. 1253)
- ▶ <Check Dial Tone Before Sending>(P. 1254)
- ▶ <Fax TX Report>(P. 1254)
- ▶ <Fax Activity Report>(P. 1254)
- ▶ <Set Line>(P. 1255)
- ▶ <TX Start Speed>(P. 1255)
- ▶ <R-Key Setting>(P. 1256)
- ▶ <Confirm Entered Fax Number>(P. 1256)
- ▶ <Allow Fax Driver TX>(P. 1256)
- ▶ <Confirm Before Sending When Fax Dest. Included>(P. 1256)
- ▶ <Restrict Sequential Broadcast When Fax Dest. Included>(P. 1257)
- ▶ <Remote Fax TX Settings>(P. 1257)
- ▶ <Remote Fax Settings>(P. 1257)
- ▶ <Auto Adjust Communication Speed When Using VoIP>(P. 1257)

NOTE

- For information on the items ("A", "B", "C", and "No") in the "Import All Function" column, see ▶ **Import All Function(P. 1054)** .

Item marked with an asterisk (*)

- Only appears if you have the option installed. ▶ **Checking the Options Installed on This Machine(P. 1038)**

<Register Favorite Settings>/<Edit Favorite Settings>

 (Settings/Registration) ▶ <Function Settings> ▶ <Send> ▶ <Fax Settings>

You can register frequently used settings in a button of the machine for later use when sending a fax. You can also assign a name to a button and enter a comment. You can also delete or rename registered settings. ▶ **Registering a Combination of Frequently Used Functions(P. 367)**

Item	Setting Description	DeviceAdmin	NetworkAdmin	Can be set in Remote UI	Device Information Delivery Available	Import All Function	Name of Item When Exporting with the Remote UI
<Register Favorite Settings>	Confirm Settings	Yes	Yes	No	No	C	Favorite Settings
	Select Location: <M1> to <M18>	Yes	Yes	No	No	C	Favorite Settings
	<Show Comments>: <On>, <Off>	Yes	Yes	No	No	C	Settings/Registration Basic Information
	<Name>, <Comment>	Yes	Yes	No	No	C	Favorite Settings
<Edit Favorite Settings>	Select the Button: <M1> to <M18>	Yes	Yes	No	No	C	Favorite Settings Settings/Registration Basic Information

Item	Setting Description	DeviceAdmin	NetworkAdmin	Can be set in Remote UI	Device Information Delivery Available	Import All Function	Name of Item When Exporting with the Remote UI
	<Show Comments>: <On>, <Off>						
	<Delete>, <Check Content>, <Rename>						

<Display Confirmation for Favorite Settings>

 (Settings/Registration) ▶ <Function Settings> ▶ <Send> ▶ <Fax Settings>

You can select whether to display a confirmation screen when recalling "Favorite Settings."

Item	Setting Description	DeviceAdmin	NetworkAdmin	Can be set in Remote UI	Device Information Delivery Available	Import All Function	Name of Item When Exporting with the Remote UI
<Display Confirmation for Favorite Settings>	<On>, <Off>	Yes	Yes	No	No	C	Settings/Registration Basic Information

<Default Screen>

 (Settings/Registration) ▶ <Function Settings> ▶ <Send> ▶ <Fax Settings>

You can specify the screen to display when <Fax> or  (Reset) is pressed.

Item	Setting Description	DeviceAdmin	NetworkAdmin	Can be set in Remote UI	Device Information Delivery Available	Import All Function	Name of Item When Exporting with the Remote UI
<Default Screen>	<Standard>, <Address Book>, <Favorite Settings>	Yes	Yes	No	No	C	Settings/Registration Basic Information

<Restrict Address Book Use>

 (Settings/Registration) ▶ <Function Settings> ▶ <Send> ▶ <Fax Settings>

You can select whether to hide the Address Book and one-touch buttons on the Fax Basic Features screen, etc., as well as whether to restrict use of the Address Book.

Item	Setting Description	DeviceAdmin	NetworkAdmin	Can be set in Remote UI	Device Information Delivery Available	Import All Function	Name of Item When Exporting with the Remote UI
<Restrict Address Book Use>	<On>, <Off>	Yes	Yes	No	No	C	Settings/Registration Basic Information

<Change Default Settings>

 (Settings/Registration) ▶ <Function Settings> ▶ <Send> ▶ <Fax Settings>

You can change the settings registered as default for the <Fax> function.

Item	Setting Description	DeviceAdmin	NetworkAdmin	Can be set in Remote UI	Device Information Delivery Available	Import All Function	Name of Item When Exporting with the Remote UI
<Change Default Settings>	<Register>, <Initialize>	Yes	Yes	No	No	C	Favorite Settings

<Register Options Shortcuts>

 (Settings/Registration) ▶ <Function Settings> ▶ <Send> ▶ <Fax Settings>

You can register modes in the shortcut keys displayed on the <Fax> screen.  **Customizing the Basic Features Screen(P. 370)**

Item	Setting Description	DeviceAdmin	NetworkAdmin	Can be set in Remote UI	Device Information Delivery Available	Import All Function	Name of Item When Exporting with the Remote UI
<Register Options Shortcuts>	<Shortcut 1>: <Density>, Each mode, <Unassigned>	Yes	Yes	No	No	C	Favorite Settings
	<Shortcut 2>: <Original Type>, Each mode, <Unassigned>						
	<Shortcut 3>: <2-Sided Original>, Each mode, <Unassigned>						
	<Shortcut 4>: <Different Size Originals>, Each mode, <Unassigned>						

<Register Sender Name (TTI)>

 (Settings/Registration) ▶ <Function Settings> ▶ <Send> ▶ <Fax Settings>

You can register any name as the sender name, such as the section or department's name, or an individual's name, and edit/delete registered names. The registered name is printed on paper at the recipient as the sender information when you send a fax.

Item	Setting Description	DeviceAdmin	NetworkAdmin	Can be set in Remote UI	Device Information Delivery Available	Import All Function	Name of Item When Exporting with the Remote UI
<Register Sender Name (TTI)>	<Register/Edit>, <Delete>	Yes	Yes	Yes	No	C	Settings/Registration Basic Information

NOTE

- You can store up to 99 sender names (01 to 99).

<Use Authentication User Name as Sender Name>

 (Settings/Registration) ▶ <Function Settings> ▶ <Send> ▶ <Fax Settings>

If logging in with personal authentication management, the login name appears in <100> on the <Sender Name (TTI)> screen. If <On> is selected, the login name in <100> is used as the default setting for the sender name.

Item	Setting Description	DeviceAdmin	NetworkAdmin	Can be set in Remote UI	Device Information Delivery Available	Import All Function	Name of Item When Exporting with the Remote UI
<Use Authentication User Name as Sender Name>	<On>, <Off>	Yes	No	No	Yes	C	Settings/Registration Basic Information

NOTE

- If this setting is set to <Off>, the user name in <0> is used as the default setting for the sender name. For instructions on registering a user name, see [Fax Line Settings\(P. 314\)](#) .

<ECM TX>

 (Settings/Registration) ▶ <Function Settings> ▶ <Send> ▶ <Fax Settings>

You can set whether to use ECM in the fax transmission protocol. ECM checks for fax data errors and corrects them.

Item	Setting Description	DeviceAdmin	NetworkAdmin	Can be set in Remote UI	Device Information Delivery Available	Import All Function	Name of Item When Exporting with the Remote UI
<ECM TX>	<On>, <Off>	Yes	Yes	Yes	Yes	C	Settings/Registration Basic Information

IMPORTANT

- If the communication speed appears to be extremely slow, you may be able to improve the speed by setting to <Off>.

- Even when you set ECM, errors can sometimes occur due to a poor telephone line connection.

NOTE

- The conditions for successful ECM transmission are indicated below.
 - ECM transmission is enabled with this setting
 - The destination supports ECM
 - <ECM TX> was set to <On> when registering the destination address to the Address Book **▶ Registering Destinations in the Address Book(P. 394)**

<Set Pause Time>

 (Settings/Registration) ▶ <Function Settings> ▶ <Send> ▶ <Fax Settings>

You can set the number of seconds to pause when sending faxes. Some overseas dialing may not be successful when dialing the international access code, country code, and the destination's telephone number all at once. In such cases, inserting a pause after the international access code can make it easier to connect.

Item	Setting Description	DeviceAdmin	NetworkAdmin	Can be set in Remote UI	Device Information Delivery Available	Import All Function	Name of Item When Exporting with the Remote UI
<Set Pause Time>	1 to 4 to 15 sec.	Yes	Yes	Yes	Yes	C	Settings/Registration Basic Information

NOTE

- Pauses entered at the end of dialed fax numbers are always 10 seconds long.

<Auto Redial>

 (Settings/Registration) ▶ <Function Settings> ▶ <Send> ▶ <Fax Settings>

Auto Redial enables the machine to automatically redial the recipient's fax number if the recipient cannot be reached due to a busy line, or if a sending error occurs. If you activate this setting, you can set how many times the machine redials, the redial interval, and whether the document should be resent when there is an error.

Item	Setting Description	DeviceAdmin	NetworkAdmin	Can be set in Remote UI	Device Information Delivery Available	Import All Function	Name of Item When Exporting with the Remote UI
<Auto Redial>*1	<p><On>, <Off></p> <p><Set Details>: <Redial Times>: 1 to 2 to 10 times <Redial Interval>: 2 to 99 minutes <Redial When TX Error>: <Error and 1st Page>, <All Pages>, <Off></p>	Yes	Yes	Yes	Yes	C	Settings/Registration Basic Information

*1 Indicates items that may not be displayed on the Settings/Registration screen or that may have different default setting, depending on the region.

<Check Dial Tone Before Sending>

 (Settings/Registration) ▶ <Function Settings> ▶ <Send> ▶ <Fax Settings>

If you are sending a fax from your machine at the same time another fax machine (made by a company other than Canon) is trying to send you a fax, your fax may end up being redirected to that fax machine, instead of the original destination you had intended. Activating this setting enables you to avoid such sending problems.

Item	Setting Description	DeviceAdmin	NetworkAdmin	Can be set in Remote UI	Device Information Delivery Available	Import All Function	Name of Item When Exporting with the Remote UI
<Check Dial Tone Before Sending>*1	<On>, <Off>	Yes	Yes	Yes	Yes	C	Settings/Registration Basic Information

*1 Indicates items that may not be displayed on the Settings/Registration screen or that may have different default setting, depending on the region.

<Fax TX Report>

 (Settings/Registration) ▶ <Function Settings> ▶ <Send> ▶ <Fax Settings>

A Fax TX Report is a report that enables you to check whether faxes were sent correctly to their intended destinations. The machine can be set to print this report automatically after documents are sent or only when a transmission error occurs. You can also specify the setting to print the first part of the document as part of the report to remind you of the document's content.  **Fax TX Report(P. 1032)**

Item	Setting Description	DeviceAdmin	NetworkAdmin	Can be set in Remote UI	Device Information Delivery Available	Import All Function	Name of Item When Exporting with the Remote UI
<Fax TX Report>	<For Error Only>, <On>, <Off>	Yes	No	Yes	Yes	C	Settings/Registration Basic Information
	When <For Error Only> is selected: <Report with TX Image>: <On>, <Off>						
	When <On> is selected: <Report with TX Image>: <On>, <Off>						

<Fax Activity Report>

 (Settings/Registration) ▶ <Function Settings> ▶ <Send> ▶ <Fax Settings>

You can print or send fax document sending/receiving logs as a report. The machine can be set to print or send this report when a specified number of communications (40 to 1,000) is reached or at a specified time. The send/receive reports can also be printed or sent separately.  **Fax Activity Report(P. 1031)**

- When the report is sent as data, it is sent in the CSV file format.

Item	Setting Description	DeviceAdmin	NetworkAdmin	Can be set in Remote UI	Device Information Delivery Available	Import All Function	Name of Item When Exporting with the Remote UI
<Fax Activity Report>	<Print/Send Every Specified No. of Transm.>: <Print>, <Send>, <Off>	Yes	No	Yes	Yes	C	Settings/ Registration Basic Information
	Number of transmissions: 40 to 1000						
	<Print/Send at Specified Time>: <Print>, <Send>, <Off>						
	Specify Print Time: 00:00 to 23:59						
	<Print Send/Receive Jobs Separately>: On, Off <Send Destination>						

<Set Line>

 (Settings/Registration) ► <Function Settings> ► <Send> ► <Fax Settings>

Specify the fax line settings.

 <Set Line>(P. 1259)

<TX Start Speed>

 (Settings/Registration) ► <Function Settings> ► <Send> ► <Fax Settings>

You can change the send start speed. This setting is useful when there is difficulty initiating the sending of a document due to a poor line condition.

Item	Setting Description	DeviceAdmin	NetworkAdmin	Can be set in Remote UI	Device Information Delivery Available	Import All Function	Name of Item When Exporting with the Remote UI
<TX Start Speed>	< 33600 bps >, <14400 bps>, <9600 bps>, <7200 bps>, <4800 bps>, <2400 bps>	Yes	No	Yes	Yes	C	Settings/Registration Basic Information

NOTE

- If your document transmission is slow in starting, this may mean that the telephone lines in your area are in poor condition. Select a slower speed. You can select <33600 bps>, <14400 bps>, <9600 bps>, <7200 bps>, <4800 bps>, or <2400 bps>.
- Set  <Auto Adjust Communication Speed When Using VoIP>(P. 1257) to <On> to send and receive faxes more accurately when the line or other party is prone to errors. The communication speed is limited to <14400 bps> or slower, which reduces errors. If <Auto Adjust Communication Speed When Using VoIP> is set to <Off>, the speed returns to the value displayed in <TX Start Speed>.

<R-Key Setting>

 (Settings/Registration) ▶ <Function Settings> ▶ <Send> ▶ <Fax Settings>

If your machine is connected through a PBX (Private Branch Exchange), it is necessary to set the access method. You can set the PBX type to <Prefix> or <Hooking>. If you register the outside line access number in the R-key, you can easily access the outside line.

Item	Setting Description	DeviceAdmin	NetworkAdmin	Can be set in Remote UI	Device Information Delivery Available	Import All Function	Name of Item When Exporting with the Remote UI
<R-Key Setting>	<PSTN>, <PBX> When <PBX> is selected: <Prefix> (20 digits maximum), <Hooking>	Yes	No	Yes	Yes	C	Settings/Registration Basic Information

<Confirm Entered Fax Number>

 (Settings/Registration) ▶ <Function Settings> ▶ <Send> ▶ <Fax Settings>

To prevent sending a fax to an incorrect destination, you can select whether to display an entry confirmation screen when entering a fax number.

Item	Setting Description	DeviceAdmin	NetworkAdmin	Can be set in Remote UI	Device Information Delivery Available	Import All Function	Name of Item When Exporting with the Remote UI
<Confirm Entered Fax Number>	<On>, <Off>	Yes	No	Yes	Yes	C	Settings/Registration Basic Information

<Allow Fax Driver TX>

 (Settings/Registration) ▶ <Function Settings> ▶ <Send> ▶ <Fax Settings>

You can select whether to allow sending a fax from a computer.

Item	Setting Description	DeviceAdmin	NetworkAdmin	Can be set in Remote UI	Device Information Delivery Available	Import All Function	Name of Item When Exporting with the Remote UI
<Allow Fax Driver TX>	<On>, <Off>	Yes	No	Yes	Yes	C	Settings/Registration Basic Information

<Confirm Before Sending When Fax Dest. Included>

 (Settings/Registration) ▶ <Function Settings> ▶ <Send> ▶ <Fax Settings>

You can select whether to display a destination confirmation screen when sending to destinations containing faxes. This helps prevent you from sending a fax to an incorrect destination.

Item	Setting Description	DeviceAdmin	NetworkAdmin	Can be set in Remote UI	Device Information Delivery Available	Import All Function	Name of Item When Exporting with the Remote UI
<Confirm Before Sending When Fax Dest. Included>	<On>, <Off>	No	No	Yes	No	C	Settings/ Registration Basic Information
	When <On> is selected: <Only for Seq. Broadcast>, <All>						

<Restrict Sequential Broadcast When Fax Dest. Included>

 (Settings/Registration) ► <Function Settings> ► <Send> ► <Fax Settings>

You can select whether to restrict sending to multiple destinations containing faxes at the same time.

Item	Setting Description	DeviceAdmin	NetworkAdmin	Can be set in Remote UI	Device Information Delivery Available	Import All Function	Name of Item When Exporting with the Remote UI
<Restrict Sequential Broadcast When Fax Dest. Included>	<On>, <Off>	No	No	Yes	No	C	Settings/Registration Basic Information

<Remote Fax TX Settings> *

 (Settings/Registration) ► <Function Settings> ► <Send> ► <Fax Settings>

Specify the settings on the client machine for the Remote Fax function.

 <Remote Fax TX Settings>(P. 1262)

<Remote Fax Settings>

 (Settings/Registration) ► <Function Settings> ► <Send> ► <Fax Settings>

Specify the settings on the server machine for the Remote Fax function.

 <Remote Fax Settings>(P. 1265)

<Auto Adjust Communication Speed When Using VoIP>

 (Settings/Registration) ► <Function Settings> ► <Send> ► <Fax Settings>

You can send and receive faxes more accurately when the line or other party is prone to errors.

Item	Setting Description	DeviceAdmin	NetworkAdmin	Can be set in Remote UI	Device Information Delivery Available	Import All Function	Name of Item When Exporting with the Remote UI
<Auto Adjust Communication Speed When Using VoIP>	<On>, <Off>	Yes	Yes	Yes	No	C	Settings/Registration Basic Information

NOTE

- If you set this to <On>, the communication speed is limited to <14400 bps> or slower in the following settings, which reduces errors. If you set this to <Off>, the speeds return to their original values.
 - <Sending Speed> for destinations registered in the Address Book or one-touch buttons **▶ Registering Destinations in the Address Book(P. 394)**
 - The transmission speed set in <TX Start Speed> **▶<TX Start Speed>(P. 1255)**
 - The reception speed set in <RX Start Speed> **▶<RX Start Speed>(P. 1280)**

<Set Line>

Specify the fax line settings.

▶<Line 1> to <Line n>(P. 1259)

▶<Select TX Line>(P. 1261)

NOTE

- For information on the items ("A", "B", "C", and "No") in the "Import All Function" column, see ▶<Import All Function>(P. 1054) .

Item marked with an asterisk (*)

- Only appears if you have the option installed. ▶<Checking the Options Installed on This Machine>(P. 1038)

<Line 1> to <Line n>

 (Settings/Registration) ▶ <Function Settings> ▶ <Send> ▶ <Fax Settings> ▶ <Set Line>

Specify settings such as the fax number and unit name for each line.

NOTE

- The number of lines displayed differs depending on the following:
 - The options installed
 - The <No. of TX Lines> setting (Remote Fax client machines only)

<Register Unit Telephone Number>

 (Settings/Registration) ▶ <Function Settings> ▶ <Send> ▶ <Fax Settings> ▶ <Set Line> ▶ <Line 1> to <Line n>

You can register the fax number to use when the fax is used on the machine. The registered fax number is printed on paper at the recipient as the sender information when you send a fax. ▶<Fax Line Settings>(P. 314)

Item	Setting Description	DeviceAdmin	NetworkAdmin	Can be set in Remote UI	Device Information Delivery Available	Import All Function	Name of Item When Exporting with the Remote UI
<Register Unit Telephone Number>	Enter the User Telephone No.	Yes	No	Yes	No	A	Settings/Registration Basic Information

<Register Unit Name>

 (Settings/Registration) ▶ <Function Settings> ▶ <Send> ▶ <Fax Settings> ▶ <Set Line> ▶ <Line 1> to <Line n>

You can register the name of your company or department as the unit name. The registered name is printed on paper at the recipient as the sender information when you send a fax. ▶<Fax Line Settings>(P. 314)

Item	Setting Description	DeviceAdmin	NetworkAdmin	Can be set in Remote UI	Device Information Delivery Available	Import All Function	Name of Item When Exporting with the Remote UI
<Register Unit Name>	Enter the Unit Name	Yes	No	Yes	No	A	Settings/ Registration Basic Information

<Select Line Type>

 (Settings/Registration) ▶ <Function Settings> ▶ <Send> ▶ <Fax Settings> ▶ <Set Line> ▶ <Line 1> to <Line n>

You can set the type of telephone line connected to the machine. If this setting is incorrect, you will be unable to communicate with other machines. Be sure to check the type of telephone line that you are using, and make the correct setting.  **Fax Line Settings(P. 314)**

Item	Setting Description	DeviceAdmin	NetworkAdmin	Can be set in Remote UI	Device Information Delivery Available	Import All Function	Name of Item When Exporting with the Remote UI
<Select Line Type>	<Pulse>, <Tone>	Yes	No	Yes	No	C	Settings/ Registration Basic Information

<Edit Line Name for Select Line Screen> *

 (Settings/Registration) ▶ <Function Settings> ▶ <Send> ▶ <Fax Settings> ▶ <Set Line> ▶ <Line 1> to <Line n>

You can register the line name of a button displayed on the <Select Line> screen.  **Fax Line Settings(P. 314)**

Item	Setting Description	DeviceAdmin	NetworkAdmin	Can be set in Remote UI	Device Information Delivery Available	Import All Function	Name of Item When Exporting with the Remote UI
<Edit Line Name for Select Line Screen>	Enter the Line Name	Yes	No	No	No	C	Settings/ Registration Basic Information

<Default Address List When Selecting Line> *

 (Settings/Registration) ▶ <Function Settings> ▶ <Send> ▶ <Fax Settings> ▶ <Set Line> ▶ <Line 1> to <Line n>

You can specify the type of address list that you want to display as the default setting when you use <Address Book> on the Fax Basic Features screen. This setting is only effective when you select the line to use on the <Select Line> screen.  **Fax Line Settings(P. 314)**

Item	Setting Description	DeviceAdmin	NetworkAdmin	Can be set in Remote UI	Device Information Delivery Available	Import All Function	Name of Item When Exporting with the Remote UI
<Default Address List When Selecting Line>	<Address List 1> to <Address List 10>, <All Address Lists>	Yes	No	No	No	C	Settings/ Registration Basic Information

<Select TX Line> *

 (Settings/Registration) ▶ <Function Settings> ▶ <Send> ▶ <Fax Settings> ▶ <Set Line>

You can set the priority of a line to use for sending faxes as well as select a line that is not allowed to use.

Item	Setting Description	DeviceAdmin	NetworkAdmin	Can be set in Remote UI	Device Information Delivery Available	Import All Function	Name of Item When Exporting with the Remote UI
<Select TX Line>	<Line 1> : <Priority TX>, <Prohibit TX> <Line n>*1 : <Priority TX>, <Prohibit TX>	Yes	No	Yes	No	C	Settings/Registration Basic Information

*1 The number of lines displayed differs depending on the options installed.

IMPORTANT

- Even if you set <Line 1> to <Prohibit TX>, Line 1 is still used for fax information services.

NOTE

- If you select another line in <Options>, that setting takes priority.

<Remote Fax TX Settings>

961F-0S4

Specify the settings on the client machine for the Remote Fax function.

- ▶<Remote Fax Server Address>(P. 1262)
- ▶<TX Timeout>(P. 1262)
- ▶<No. of TX Lines>(P. 1262)
- ▶<Select Priority Line>(P. 1263)
- ▶<Use IP Fax>(P. 1263)
- ▶<IP Fax Communication Mode Settings>(P. 1263)

NOTE

- For information on the items ("A", "B", "C", and "No") in the "Import All Function" column, see ▶<Import All Function>(P. 1054) .

<Remote Fax Server Address>

 (Settings/Registration) ▶ <Function Settings> ▶ <Send> ▶ <Fax Settings> ▶ <Remote Fax TX Settings>

Specify the IP address or host name of the remote fax server machine.

Item	Setting Description	DeviceAdmin	NetworkAdmin	Can be set in Remote UI	Device Information Delivery Available	Import All Function	Name of Item When Exporting with the Remote UI
<Remote Fax Server Address>	Enter the IP address or host name	Yes	Yes	Yes	No	C	Settings/Registration Basic Information

<TX Timeout>

 (Settings/Registration) ▶ <Function Settings> ▶ <Send> ▶ <Fax Settings> ▶ <Remote Fax TX Settings>

If the remote fax server machine does not respond for the time set for the TX Timeout, the remote fax job is canceled.

Item	Setting Description	DeviceAdmin	NetworkAdmin	Can be set in Remote UI	Device Information Delivery Available	Import All Function	Name of Item When Exporting with the Remote UI
<TX Timeout>	1 to 24 to 99 hour (one hour increments)	Yes	Yes	Yes	Yes	C	Settings/Registration Basic Information

<No. of TX Lines>

 (Settings/Registration) ▶ <Function Settings> ▶ <Send> ▶ <Fax Settings> ▶ <Remote Fax TX Settings>

You can set the number of lines you can select when sending remote faxes. Set the number of lines to the same number of telephone lines connected to the Remote Fax server machine.

Item	Setting Description	DeviceAdmin	NetworkAdmin	Can be set in Remote UI	Device Information Delivery Available	Import All Function	Name of Item When Exporting with the Remote UI
<No. of TX Lines>	1 to 4 Line	Yes	Yes	Yes	No	C	Settings/Registration Basic Information

<Select Priority Line>

 (Settings/Registration) ▶ <Function Settings> ▶ <Send> ▶ <Fax Settings> ▶ <Remote Fax TX Settings>

You can specify the line to use when sending remote faxes.

Item	Setting Description	DeviceAdmin	NetworkAdmin	Can be set in Remote UI	Device Information Delivery Available	Import All Function	Name of Item When Exporting with the Remote UI
<Select Priority Line>	<Auto>, <Line 1> to <Line n>*1, <Priority TX>, <Prohibit TX>	Yes	Yes	Yes	No	C	Settings/Registration Basic Information

*1 Displays according to the number of lines set in <No. of TX Lines>.

<Use IP Fax>

 (Settings/Registration) ▶ <Function Settings> ▶ <Send> ▶ <Fax Settings> ▶ <Remote Fax TX Settings>

You can select whether to use IP faxes.

Item	Setting Description	DeviceAdmin	NetworkAdmin	Can be set in Remote UI	Device Information Delivery Available	Import All Function	Name of Item When Exporting with the Remote UI
<Use IP Fax>	<On>, <Off>	Yes	Yes	Yes	No	C	Settings/Registration Basic Information

<IP Fax Communication Mode Settings>

 (Settings/Registration) ▶ <Function Settings> ▶ <Send> ▶ <Fax Settings> ▶ <Remote Fax TX Settings>

You can specify the communication mode to use when sending IP faxes.

Item	Setting Description	DeviceAdmin	NetworkAdmin	Can be set in Remote UI	Device Information Delivery Available	Import All Function	Name of Item When Exporting with the Remote UI
<IP Fax Communication Mode Settings>	<Use Intranet>: <On>, <Off>	Yes	Yes	Yes	No	C	Settings/Registration Basic Information

Settings/Registration

Item	Setting Description	DeviceAdmin	NetworkAdmin	Can be set in Remote UI	Device Information Delivery Available	Import All Function	Name of Item When Exporting with the Remote UI
	<Use VoIP Gateway>: <On>, <Off>						

<Remote Fax Settings>

961F-0S5

Specify the settings on the server machine for the Remote Fax function.

NOTE

- For information on the items ("A", "B", "C", and "No") in the "Import All Function" column, see [▶ Import All Function\(P. 1054\)](#) .

<Use Remote Fax>

 (Settings/Registration) ▶ <Function Settings> ▶ <Send> ▶ <Fax Settings> ▶ <Remote Fax Settings>

You can specify whether to use the machine as a server machine for the Remote Fax function.

Item	Setting Description	DeviceAdmin	NetworkAdmin	Can be set in Remote UI	Device Information Delivery Available	Import All Function	Name of Item When Exporting with the Remote UI
<Use Remote Fax>	<On>, <Off>	Yes	Yes	Yes	No	C	Settings/Registration Basic Information

IMPORTANT

- If you want to use the machine as a Remote Fax server machine, press <Network> ▶ set <Dedicated Port Settings> to <On>.

<Receive/Forward>

Specify the settings for the receive and forwarding functions.

- ▶<Output Report>(P. 1266)
- ▶<Common Settings>(P. 1266)
- ▶<Fax Settings>(P. 1266)

NOTE

Item marked with an asterisk (*)

- Only appears if your machine has a fax function.

<Output Report>

 (Settings/Registration) ▶ <Function Settings> ▶ <Receive/Forward>

This prints a list of the registration details for the send/receive settings and fax settings.

- ▶<Output Report>(P. 1267)

<Common Settings>

 (Settings/Registration) ▶ <Function Settings> ▶ <Receive/Forward>

Specify the settings common to the receive and forwarding functions.

- ▶<Common Settings>(P. 1268)

<Fax Settings> *

 (Settings/Registration) ▶ <Function Settings> ▶ <Receive/Forward>

Specify the settings for receiving and forwarding faxes.

- ▶<Fax Settings>(P. 1279)

<Output Report>

961F-0S7

This prints a list of the registration details for the send/receive settings and fax settings.

▶<TX/RX User Data List>(P. 1225)

▶<Fax User Data List>(P. 1225)

NOTE

- For information on the items ("A", "B", "C", and "No") in the "Import All Function" column, see ▶<Import All Function>(P. 1054) .

Item marked with an asterisk (*)

- Only appears if your machine has a fax function.

<TX/RX User Data List>

 (Settings/Registration) ▶ <Function Settings> ▶ <Receive/Forward> ▶ <Output Report>

You can print a list of the send/receive settings registered in the machine. ▶<TX/RX User Data List>(P. 1034)

Item	Setting Description	DeviceAdmin	NetworkAdmin	Can be set in Remote UI	Device Information Delivery Available	Import All Function	Name of Item When Exporting with the Remote UI
<TX/RX User Data List>	<Yes>, <No>	Yes	Yes	Yes	No	No	-

<Fax User Data List> *

 (Settings/Registration) ▶ <Function Settings> ▶ <Receive/Forward> ▶ <Output Report>

You can print a list of the fax settings registered in the machine. ▶<Fax User Data List>(P. 1035)

Item	Setting Description	DeviceAdmin	NetworkAdmin	Can be set in Remote UI	Device Information Delivery Available	Import All Function	Name of Item When Exporting with the Remote UI
<Fax User Data List>	<Yes>, <No>	Yes	Yes	Yes	No	No	-

<Common Settings>

Specify the settings common to the receive and forwarding functions.

- ▶ <Print on Both Sides>(P. 1268)
- ▶ <Select Drawer>(P. 1268)
- ▶ <Reduce Fax RX Size>(P. 1269)
- ▶ <2 on 1 Log>(P. 1269)
- ▶ <Print RX Page Footer>(P. 1270)
- ▶ <YCbCr RX Gamma Value>(P. 1270)
- ▶ <Interrupt and Print RX Jobs>(P. 1271)
- ▶ <Use Forwarding Settings>(P. 1271)
- ▶ <Handle Files with Forwarding Errors>(P. 1271)
- ▶ <Forwarding Settings>(P. 1272)
- ▶ <Set Fax/I-Fax Inbox>(P. 1272)
- ▶ <Always Send Notice for RX Errors>(P. 1272)

NOTE

- For information on the items ("A", "B", "C", and "No") in the "Import All Function" column, see ▶ **Import All Function(P. 1054)** .

<Print on Both Sides>

 (Settings/Registration) ▶ <Function Settings> ▶ <Receive/Forward> ▶ <Common Settings>

You can select whether to print received documents on both sides of paper.

Item	Setting Description	DeviceAdmin	NetworkAdmin	Can be set in Remote UI	Device Information Delivery Available	Import All Function	Name of Item When Exporting with the Remote UI
<Print on Both Sides>	<On>, <Off>	Yes	Yes	Yes	Yes	C	Settings/Registration Basic Information

<Select Drawer>

 (Settings/Registration) ▶ <Function Settings> ▶ <Receive/Forward> ▶ <Common Settings>

You can set how the machine prints documents when there is no paper matching the size of the received document. There are four printing methods.

- <Switch A>
The image is printed over two sheets of paper that have the same combined size as the received document.
- <Switch B>
The image is printed with blank space on paper that has the same width as the received document.
- <Switch C>
The image is reduced and printed on paper that differs in width from the received document.
- <Switch D>
The image is printed on paper that is larger in size than the received document.

Item	Setting Description	DeviceAdmin	NetworkAdmin	Can be set in Remote UI	Device Information Delivery Available	Import All Function	Name of Item When Exporting with the Remote UI
<Select Drawer>	Switch A: <On>, <Off> Switch B: <On>, <Off> Switch C: <On>, <Off> Switch D: <On>, <Off>	Yes	Yes	Yes	Yes	C	Settings/Registration Basic Information

<Reduce Fax RX Size>

 (Settings/Registration) ▶ <Function Settings> ▶ <Receive/Forward> ▶ <Common Settings>

You can select whether to reduce received documents so that the whole document is printed within the printable area of the paper.

Item	Setting Description	DeviceAdmin	NetworkAdmin	Can be set in Remote UI	Device Information Delivery Available	Import All Function	Name of Item When Exporting with the Remote UI
<Reduce Fax RX Size>	<On>, <Off> <ul style="list-style-type: none"> • <Reduction Mode>: <Auto>, <Fixed> • <Reduction %>: 75 to 90% to 97% • <Reduction Direction>: <Vertical & Horizontal>, <Vertical Only> 	Yes	Yes	Yes	Yes	C	Settings/Registration Basic Information

NOTE

- If this setting is set to <Off>, the image size of the received file is not reduced to fit the size of the paper. If the size of the image exceeds the printable area, the image is divided into equal sections and printed onto separate sheets of paper.
- If you select <Auto> in <Reduction Mode>, the image size is automatically reduced by a suitable reduction ratio. This ratio can range from the value set for <Reduction %>, up to 100% of the received document size.

<2 on 1 Log>

 (Settings/Registration) ▶ <Function Settings> ▶ <Receive/Forward> ▶ <Common Settings>

If this setting is set to <On>, you can print received documents with the 2 on 1 layout.

Item	Setting Description	DeviceAdmin	NetworkAdmin	Can be set in Remote UI	Device Information Delivery Available	Import All Function	Name of Item When Exporting with the Remote UI
<2 on 1 Log>	<On>, <Off>	Yes	Yes	Yes	Yes	C	Settings/Registration Basic Information

NOTE

- This mode is only available under the following conditions:
 - You must select the same paper drawer for printing two consecutive pages of a received document.
 - The paper in the selected paper drawer must be large enough for two consecutive pages to be printed out.
- If you set <2 on 1 Log> to <On>, documents are printed with a dotted line in the middle. If you print the document with sender information, the dotted line is not printed in the area where the sender information is located.

<Print RX Page Footer>

 (Settings/Registration) ▶ <Function Settings> ▶ <Receive/Forward> ▶ <Common Settings>

You can select whether to print information, such as reception time and page number, at the bottom of received documents.

Item	Setting Description	DeviceAdmin	NetworkAdmin	Can be set in Remote UI	Device Information Delivery Available	Import All Function	Name of Item When Exporting with the Remote UI
<Print RX Page Footer>	<Print>, <Do Not Print>	Yes	Yes	Yes	Yes	C	Settings/Registration Basic Information

NOTE

- When an e-mail without a body is received, the From information and Subject information (up to 24 characters for each) is printed at the top of the first page of the attachment file.

<YCbCr RX Gamma Value>

 (Settings/Registration) ▶ <Function Settings> ▶ <Receive/Forward> ▶ <Common Settings>

You can print received I-fax documents in the appropriate quality.

Item	Setting Description	DeviceAdmin	NetworkAdmin	Can be set in Remote UI	Device Information Delivery Available	Import All Function	Name of Item When Exporting with the Remote UI
<YCbCr RX Gamma Value>	<Gamma 1.0>, <Gamma 1.4>, <Gamma 1.8>, <Gamma 2.2>	Yes	Yes	Yes	Yes	C	Settings/Registration Basic Information

NOTE

- This setting is disabled when receiving faxes.

<Interrupt and Print RX Jobs>

 (Settings/Registration) ▶ <Function Settings> ▶ <Receive/Forward> ▶ <Common Settings>

You can set to suspend other jobs to print faxes/I-faxes when the machine receives them.

Item	Setting Description	DeviceAdmin	NetworkAdmin	Can be set in Remote UI	Device Information Delivery Available	Import All Function	Name of Item When Exporting with the Remote UI
<Interrupt and Print RX Jobs>	<On>, <Off>	No	No	Yes	No	C	Settings/Registration Basic Information

<Use Forwarding Settings>

 (Settings/Registration) ▶ <Function Settings> ▶ <Receive/Forward> ▶ <Common Settings>

You can select whether to forward received documents to other destinations such as the Confidential Fax Inbox of the machine and an external file server. If you select <On>, specify the forwarding conditions in <Forwarding Settings>.

Item	Setting Description	DeviceAdmin	NetworkAdmin	Can be set in Remote UI	Device Information Delivery Available	Import All Function	Name of Item When Exporting with the Remote UI
<Use Forwarding Settings>	<On>, <Off>	Yes	No	Yes	No	C	Settings/Registration Basic Information

<Handle Files with Forwarding Errors>

 (Settings/Registration) ▶ <Function Settings> ▶ <Receive/Forward> ▶ <Common Settings>

You can set how the machine handles documents that fail to be forwarded.

Item	Setting Description	DeviceAdmin	NetworkAdmin	Can be set in Remote UI	Device Information Delivery Available	Import All Function	Name of Item When Exporting with the Remote UI
<Handle Files with Forwarding Errors>	<Always Print>, <Store/Print>, <Off>	Yes	No	Yes	Yes	C	Settings/Registration Basic Information

NOTE

- If you press <Common Settings> ▶ set <Delete Failed TX Jobs> to <Off>, the documents with forwarding errors will be saved on the <Status Monitor> screen, and the documents will not be processed according to the settings you specified here.
- If you select <Store/Print> when Memory Lock is set, the documents with forwarding errors will be saved.
- If you select <Store/Print> when Memory Lock is not set, the documents with forwarding errors will be printed.

<Forwarding Settings>

 (Settings/Registration) ▶ <Function Settings> ▶ <Receive/Forward> ▶ <Common Settings>

You can specify the conditions for forwarding received documents. You can also set to forward all incoming documents to a specified destination without specifying any conditions.  **Forwarding Received Documents Automatically(P. 571)**

Item	Setting Description	DeviceAdmin	NetworkAdmin	Can be set in Remote UI	Device Information Delivery Available	Import All Function	Name of Item When Exporting with the Remote UI
<Forwarding Settings>	<Receive Method:>, <Validate/Invalidate>, <Delete>, <Register>, <Forward without Conditions>, <Details/Edit>, <E-Mail Priority>, <Print List>, <Search>, <Clear>	Yes	No	Yes	Yes* ¹	No* ²	Forwarding Settings

*¹ <Register>, <Delete>, <Details/Edit>, <Print List>, <Forward without Conditions>, <Search>: No

*² <Register>, <Forward without Conditions>, <Details/Edit>: C

<Set Fax/I-Fax Inbox>

 (Settings/Registration) ▶ <Function Settings> ▶ <Receive/Forward> ▶ <Common Settings>

Specify the Fax/I-Fax Inbox settings.

 **<Set Fax/I-Fax Inbox>(P. 1273)**

<Always Send Notice for RX Errors>

 (Settings/Registration) ▶ <Function Settings> ▶ <Receive/Forward> ▶ <Common Settings>

You can select whether to notify the sender that an I-fax was not received successfully.

Item	Setting Description	DeviceAdmin	NetworkAdmin	Can be set in Remote UI	Device Information Delivery Available	Import All Function	Name of Item When Exporting with the Remote UI
<Always Send Notice for RX Errors>	<On>, <Off>	Yes	No	Yes	Yes	C	Settings/Registration Basic Information

<Set Fax/I-Fax Inbox>

Specify the Fax/I-Fax Inbox settings.

- ▶<Set/Register Confidential Fax Inboxes>(P. 1273)
- ▶<Memory RX Inbox PIN>(P. 1274)
- ▶<Use Fax Memory Lock>(P. 1275)
- ▶<Use I-Fax Memory Lock>(P. 1275)
- ▶<Memory Lock Start Time>(P. 1275)
- ▶<Memory Lock End Time>(P. 1276)
- ▶<Divided Data RX Timeout>(P. 1277)
- ▶<Forward Temporarily Stored File to Memory RX Inbox>(P. 1278)

NOTE

- For information on the items ("A", "B", "C", and "No") in the "Import All Function" column, see ▶<Import All Function(P. 1054) .

Item marked with an asterisk (*)

- Only appears if your machine has a fax function.

<Set/Register Confidential Fax Inboxes>

⚙️ (Settings/Registration) ▶ <Function Settings> ▶ <Receive/Forward> ▶ <Common Settings> ▶ <Set Fax/I-Fax Inbox>

You can assign a name for each Confidential Fax Inbox as well as set a PIN.

■ Setting/Registering Confidential Fax Inboxes

- 1 Press ⚙️ (Settings/Registration).
- 2 Press <Function Settings> ▶ <Receive/Forward> ▶ <Common Settings>.
- 3 Press <Set Fax/I-Fax Inbox>.
- 4 Press <Set/Register Confidential Fax Inboxes>.
- 5 Select the box number ▶ specify each setting, and press <OK>.



- a** <Register Box Name>
Register a name for the box.
- b** <PIN>

Enter the PIN for the box.

c <Initialize>

Initializes the box.

d <URL Send Settings>

Enables the URL for a box with documents saved can be sent via e-mail or checked on the Remote UI screen.

! IMPORTANT

- Since there is no way to check a registered PIN, make sure that you write down the PIN that you enter, and keep it in a safe place.

Item	Setting Description	DeviceAdmin	NetworkAdmin	Can be set in Remote UI	Device Information Delivery Available	Import All Function	Name of Item When Exporting with the Remote UI
<Set/Register Confidential Fax Inboxes>	<Box No.>: 00 to 49	Yes	Yes	No	Yes	C	Box Settings
	<Register Box Name>	Yes	Yes	No	Yes*1	C	Box Settings
	<PIN>	Yes	Yes	No	Yes	C	Box Settings
	<URL Send Settings>	Yes	Yes	No	Yes*1	C	Box Settings
	<Initialize>	Yes	Yes	No	Yes	No	-

*1 Indicates items that are not delivered if a PIN is set.

<Memory RX Inbox PIN>

 (Settings/Registration) ▶ <Function Settings> ▶ <Receive/Forward> ▶ <Common Settings> ▶ <Set Fax/I-Fax Inbox>

You can set a PIN for the Memory RX Inbox.

Item	Setting Description	DeviceAdmin	NetworkAdmin	Can be set in Remote UI	Device Information Delivery Available	Import All Function	Name of Item When Exporting with the Remote UI
<Memory RX Inbox PIN>	<Set>: <PIN>, <Confirm>	Yes	No	No	No	C	Box Settings

! IMPORTANT

- Since there is no way to check a registered PIN, make sure that you write down the PIN that you enter, and keep it in a safe place.

<Use Fax Memory Lock> *

 (Settings/Registration) ▶ <Function Settings> ▶ <Receive/Forward> ▶ <Common Settings> ▶ <Set Fax/I-Fax Inbox>

You can select whether to save received fax documents in the Memory RX Inbox.  **Saving Received Documents in the Machine (Memory Reception)(P. 566)**

Item	Setting Description	DeviceAdmin	NetworkAdmin	Can be set in Remote UI	Device Information Delivery Available	Import All Function	Name of Item When Exporting with the Remote UI
<Use Fax Memory Lock>	<On>, <Off>	Yes	No	Yes	Yes	C	Settings/Registration Basic Information

<Use I-Fax Memory Lock>

 (Settings/Registration) ▶ <Function Settings> ▶ <Receive/Forward> ▶ <Common Settings> ▶ <Set Fax/I-Fax Inbox>

You can select whether to save received I-fax documents in the Memory RX Inbox.  **Saving Received Documents in the Machine (Memory Reception)(P. 566)**

Item	Setting Description	DeviceAdmin	NetworkAdmin	Can be set in Remote UI	Device Information Delivery Available	Import All Function	Name of Item When Exporting with the Remote UI
<Use I-Fax Memory Lock>	<On>, <Off>	Yes	No	Yes	Yes	C	Settings/Registration Basic Information

<Memory Lock Start Time>

 (Settings/Registration) ▶ <Function Settings> ▶ <Receive/Forward> ▶ <Common Settings> ▶ <Set Fax/I-Fax Inbox>

You can specify the time to activate the Memory Reception function. The machine will automatically switch to the Memory Reception mode at the specified time.

■ Setting the Start Time for Memory Reception

- 1 Press  (Settings/Registration).
- 2 Press <Function Settings> ▶ <Receive/Forward> ▶ <Common Settings>.
- 3 Press <Set Fax/I-Fax Inbox>.
- 4 Press <Memory Lock Start Time>, and specify the required settings.



- a <Everyday>**
Set the time that memory reception starts.
- b <Specify Days>**
Set the day of the week and time that memory reception starts.
- c <Off>**
Select this when you do not want to set a memory reception start time.

NOTE

- You can set <Everyday> for the memory reception start time and <Specify Days> for the memory reception end time (or vice-versa).

Item	Setting Description	DeviceAdmin	NetworkAdmin	Can be set in Remote UI	Device Information Delivery Available	Import All Function	Name of Item When Exporting with the Remote UI
<Memory Lock Start Time>	<Everyday> (1 to 5), <Specify Days> (<Sun> to <Sat>, 1 to 5), <Off>	Yes	No	Yes	Yes	C	Settings/Registration Basic Information

<Memory Lock End Time>

 (Settings/Registration) ▶ <Function Settings> ▶ <Receive/Forward> ▶ <Common Settings> ▶ <Set Fax/I-Fax Inbox>

You can specify the time to deactivate the Memory Reception function. The machine will automatically cancel the Memory Reception mode at the specified time.

■ Setting the End Time for Memory Reception

- 1 Press  (Settings/Registration).
- 2 Press <Function Settings> ▶ <Receive/Forward> ▶ <Common Settings>.
- 3 Press <Set Fax/I-Fax Inbox>.
- 4 Press <Memory Lock End Time>, and specify the required settings.



- a <Everyday>**
Set the time that memory reception ends.
- b <Specify Days>**
Set the day of the week and time that memory reception ends.
- c <Off>**
Select this when you do not want to set a memory reception end time.

NOTE

- You can set <Everyday> for the memory reception start time and <Specify Days> for the memory reception end time (or vice-versa).

Item	Setting Description	DeviceAdmin	NetworkAdmin	Can be set in Remote UI	Device Information Delivery Available	Import All Function	Name of Item When Exporting with the Remote UI
<Memory Lock End Time>	<Everyday> (1 to 5), <Specify Days> (<Sun> to <Sat>, 1 to 5), <Off>	Yes	No	Yes	Yes	C	Settings/Registration Basic Information

<Divided Data RX Timeout>

(Settings/Registration) ▶ <Function Settings> ▶ <Receive/Forward> ▶ <Common Settings> ▶ <Set Fax/I-Fax Inbox>

You can specify the time before reception is canceled when receiving a divided I-fax and the subsequent data cannot be received. Data received by the specified time is printed.

Item	Setting Description	DeviceAdmin	NetworkAdmin	Can be set in Remote UI	Device Information Delivery Available	Import All Function	Name of Item When Exporting with the Remote UI
<Divided Data RX Timeout>	0 to 24 to 99 hr.	Yes	No	Yes	Yes	C	Settings/Registration Basic Information

NOTE

- If you delete divided data, it cannot be combined to form a complete document, even if the remaining divided data is received later.
- Divided data cannot be printed as a regular image unless it has been combined.

<Forward Temporarily Stored File to Memory RX Inbox>

 (Settings/Registration) ▶ <Function Settings> ▶ <Receive/Forward> ▶ <Common Settings> ▶ <Set Fax/I-Fax Inbox>

You can specify whether to automatically forward received documents to the Memory RX Inbox if they cannot be printed due to an error, etc.  **Saving Received Documents in the Machine (Memory Reception)(P. 566)**

Item	Setting Description	DeviceAdmin	NetworkAdmin	Can be set in Remote UI	Device Information Delivery Available	Import All Function	Name of Item When Exporting with the Remote UI
<Forward Temporarily Stored File to Memory RX Inbox>	<Yes>, <No>	Yes	Yes	No	No	No	-

<Fax Settings>

961F-05A

Specify the settings for receiving and forwarding faxes.

- ▶<ECM RX>(P. 1279)
- ▶<Fax RX Report>(P. 1279)
- ▶<Confidential Fax Inbox RX Report>(P. 1280)
- ▶<RX Start Speed>(P. 1280)
- ▶<RX Password>(P. 1280)

NOTE

- For information on the items ("A", "B", "C", and "No") in the "Import All Function" column, see ▶Import All Function(P. 1054) .

<ECM RX>

⚙ (Settings/Registration) ▶ <Function Settings> ▶ <Receive/Forward> ▶ <Fax Settings>

You can receive faxes using the Error Correction Mode (ECM).

Item	Setting Description	DeviceAdmin	NetworkAdmin	Can be set in Remote UI	Device Information Delivery Available	Import All Function	Name of Item When Exporting with the Remote UI
<ECM RX>	<On>, <Off>	Yes	Yes	Yes	Yes	C	Settings/Registration Basic Information

! IMPORTANT

- To perform a communication using ECM, ECM needs to be set in both the sending machine and this machine.
- Even when you set ECM, errors can sometimes occur due to a poor telephone line connection.

<Fax RX Report>

⚙ (Settings/Registration) ▶ <Function Settings> ▶ <Receive/Forward> ▶ <Fax Settings>

A Fax RX Report is a report that enables you to check whether faxes were received correctly. The machine can be set to print this report automatically after documents are received or only when a reception error occurs. ▶Fax RX Report(P. 1033)

Item	Setting Description	DeviceAdmin	NetworkAdmin	Can be set in Remote UI	Device Information Delivery Available	Import All Function	Name of Item When Exporting with the Remote UI
<Fax RX Report>	<For Error Only>, <On>, <Off>	Yes	Yes	Yes	Yes	C	Settings/Registration Basic Information

<Confidential Fax Inbox RX Report>

 (Settings/Registration) ▶ <Function Settings> ▶ <Receive/Forward> ▶ <Fax Settings>

A Confidential Fax Inbox RX Report is a report that enables you to check whether documents were received in the Confidential Fax Inbox correctly. The machine can be set to print this report automatically after documents are received.  **Confidential Fax Inbox RX Report(P. 1033)**

Item	Setting Description	DeviceAdmin	NetworkAdmin	Can be set in Remote UI	Device Information Delivery Available	Import All Function	Name of Item When Exporting with the Remote UI
<Confidential Fax Inbox RX Report>	<On>, <Off>	Yes	Yes	Yes	Yes	C	Settings/Registration Basic Information

<RX Start Speed>

 (Settings/Registration) ▶ <Function Settings> ▶ <Receive/Forward> ▶ <Fax Settings>

You can change the receive start speed. This setting is useful when there is difficulty initiating the receiving of a document due to a poor line condition.

Item	Setting Description	DeviceAdmin	NetworkAdmin	Can be set in Remote UI	Device Information Delivery Available	Import All Function	Name of Item When Exporting with the Remote UI
<RX Start Speed>	<33600 bps>, <14400 bps>, <9600 bps>, <7200 bps>, <4800 bps>, <2400 bps>	Yes	No	Yes	Yes	C	Settings/Registration Basic Information

NOTE

- Set  **<Auto Adjust Communication Speed When Using VoIP>(P. 1257)** to <On> to send and receive faxes more accurately when the line or other party is prone to errors. The communication speed is limited to <14400 bps> or slower, which reduces errors. If <Auto Adjust Communication Speed When Using VoIP> is set to <Off>, the speed returns to the value displayed in <RX Start Speed>.

<RX Password>

 (Settings/Registration) ▶ <Function Settings> ▶ <Receive/Forward> ▶ <Fax Settings>

You can set an ITU-T standard password. If a subaddress is not set in a document that was received from another party using the ITU-T standard, a reception password check takes place. If the password found does not match the password set with this setting, or if a password is not attached to the document, the document is not received.

Settings/Registration

Item	Setting Description	DeviceAdmin	NetworkAdmin	Can be set in Remote UI	Device Information Delivery Available	Import All Function	Name of Item When Exporting with the Remote UI
<RX Password>	<Set>: <Password>, <Confirm>	Yes	No	Yes	No	C	Settings/Registration Basic Information

IMPORTANT

- Priority is given to the subaddress password if the received document is set with a subaddress, even if an RX password is set.

NOTE

- ITU-T stands for International Telecommunication Union-Telecommunication Standardization Sector, which is the group that makes recommendations toward the standardization of worldwide telecommunications.

<Store/Access Files>

Specify the settings used when you store scanned originals or use the stored files.

- ▶<Common Settings>(P. 1282)
- ▶<Mail Box Settings>(P. 1282)
- ▶<Advanced Space Settings>(P. 1282)
- ▶<Network Settings>(P. 1282)
- ▶<Memory Media Settings>(P. 1282)

<Common Settings>

 (Settings/Registration) ▶ <Function Settings> ▶ <Store/Access Files>

Specify the common settings used when you store scanned originals or use the stored files.

- ▶<Common Settings>(P. 1283)

<Mail Box Settings>

 (Settings/Registration) ▶ <Function Settings> ▶ <Store/Access Files>

Specify the mail box settings.

- ▶<Mail Box Settings>(P. 1288)

<Advanced Space Settings>

 (Settings/Registration) ▶ <Function Settings> ▶ <Store/Access Files>

Specify the Advanced Space settings.

- ▶<Advanced Space Settings>(P. 1292)

<Network Settings>

 (Settings/Registration) ▶ <Function Settings> ▶ <Store/Access Files>

Specify the network settings used when you store scanned originals or use the stored files.

- ▶<Network Settings>(P. 1297)

<Memory Media Settings>

 (Settings/Registration) ▶ <Function Settings> ▶ <Store/Access Files>

Specify the memory device settings.

- ▶<Memory Media Settings>(P. 1300)

<Common Settings>

Specify the common settings used when you store scanned originals or use the stored files.

- ▶<Scan and Store Settings>(P. 1283)
- ▶<Access Stored Files Settings>(P. 1283)
- ▶<Limit Box PIN to 7 Digits/Restrict Access>(P. 1283)

NOTE

- For information on the items ("A", "B", "C", and "No") in the "Import All Function" column, see ▶<Import All Function>(P. 1054) .

<Scan and Store Settings>

 (Settings/Registration) ▶ <Function Settings> ▶ <Store/Access Files> ▶ <Common Settings>

Specify the common settings used when you store scanned originals.

- ▶<Scan and Store Settings>(P. 1284)

<Access Stored Files Settings>

 (Settings/Registration) ▶ <Function Settings> ▶ <Store/Access Files> ▶ <Common Settings>

Specify the common settings used when you use stored files.

- ▶<Access Stored Files Settings>(P. 1286)

<Limit Box PIN to 7 Digits/Restrict Access>

 (Settings/Registration) ▶ <Function Settings> ▶ <Store/Access Files> ▶ <Common Settings>

If you set this setting to <On>, users are forced to set a seven-digit PIN, thus enhancing security. The PIN for User Inboxes can set using at least one digit.

Item	Setting Description	DeviceAdmin	NetworkAdmin	Can be set in Remote UI	Device Information Delivery Available	Import All Function	Name of Item When Exporting with the Remote UI
<Limit Box PIN to 7 Digits/Restrict Access>	<On>, <Off>	Yes	No	Yes	No	C	Settings/Registration Basic Information

<Scan and Store Settings>

Specify the common settings used when you store scanned originals.

 <Register/Edit Favorite Settings>(P. 1197)

 <Change Default Settings>(P. 1197)

NOTE

- For information on the items ("A", "B", "C", and "No") in the "Import All Function" column, see  **Import All Function(P. 1054)** .

<Register/Edit Favorite Settings>

 (Settings/Registration) ▶ <Function Settings> ▶ <Store/Access Files> ▶ <Common Settings> ▶ <Scan and Store Settings>

You can register frequently used settings in a button of the machine for later use when saving. You can also assign your favorite name to a button and check registered settings.  **Registering a Combination of Frequently Used Functions(P. 367)**

■ When Registering Settings

Begin by specifying the settings you want to register. Use the procedure below to register the settings for a preset state by pressing  (Settings/Registration).

- 1 Press <Scan and Store>.  <Home> Screen(P. 332)
- 2 Press the location to save to and select a mail box.
- 3 Press <Scan>.
- 4 Specify the scan settings to register.

Item	Setting Description	DeviceAdmin	NetworkAdmin	Can be set in Remote UI	Device Information Delivery Available	Import All Function	Name of Item When Exporting with the Remote UI
<Register/Edit Favorite Settings>	<Register>, <Rename>, <Delete>, <Check Content> (<M1> to <M9>)	Yes	Yes	No	No	C	Favorite Settings

<Change Default Settings>

 (Settings/Registration) ▶ <Function Settings> ▶ <Store/Access Files> ▶ <Common Settings> ▶ <Scan and Store Settings>

You can change the settings registered as default for the <Scan and Store> function.

■ When Registering Settings

Begin by specifying the settings you want to register. Use the procedure below to register the settings for a preset state by pressing  (Settings/Registration).

- 1** Press <Scan and Store>.  <Home> Screen(P. 332)
- 2** Press the location to save to and select a mail box.
- 3** Press <Scan>.
- 4** Specify the scan settings to register.

Item	Setting Description	DeviceAdmin	NetworkAdmin	Can be set in Remote UI	Device Information Delivery Available	Import All Function	Name of Item When Exporting with the Remote UI
<Change Default Settings>	<Register>, <Initialize>	Yes	Yes	No	No	C	Favorite Settings

<Access Stored Files Settings>

Specify the common settings used when you use stored files.

 <Register/Edit Favorite Settings>(P. 1286)

 <Change Default Settings>(P. 1286)

NOTE

- For information on the items ("A", "B", "C", and "No") in the "Import All Function" column, see  **Import All Function(P. 1054)** .

<Register/Edit Favorite Settings>

 (Settings/Registration) ▶ <Function Settings> ▶ <Store/Access Files> ▶ <Common Settings> ▶ <Access Stored Files Settings>

You can register frequently used settings in a button of the machine for later use when printing. You can also assign your favorite name to a button and check registered settings.  **Registering a Combination of Frequently Used Functions(P. 367)**

■ When Registering Settings

Begin by specifying the settings you want to register. Use the procedure below to register the settings for a preset state by pressing  (Settings/Registration).

- 1 Press <Access Stored Files>.  <Home> Screen(P. 332)
- 2 Press the location of the file to use and select a mail box.
- 3 Select a file and press <Print>.
- 4 Specify the print settings to register.

Item	Setting Description	DeviceAdmin	NetworkAdmin	Can be set in Remote UI	Device Information Delivery Available	Import All Function	Name of Item When Exporting with the Remote UI
<Register/Edit Favorite Settings>	<Register>, <Rename>, <Delete>, <Check Content> (<M1> to <M9>)	Yes	Yes	No	No	C	Favorite Settings

<Change Default Settings>

 (Settings/Registration) ▶ <Function Settings> ▶ <Store/Access Files> ▶ <Common Settings> ▶ <Access Stored Files Settings>

You can change the settings registered as default for the <Access Stored Files> function.

■ When Registering Settings

Begin by specifying the settings you want to register. Use the procedure below to register the settings for a preset state by pressing  (Settings/Registration).

- 1** Press <Access Stored Files>.  <Home> Screen(P. 332)
- 2** Press the location of the file to use and select a mail box.
- 3** Select a file and press <Print>.
- 4** Specify the print settings to register.

Item	Setting Description	DeviceAdmin	NetworkAdmin	Can be set in Remote UI	Device Information Delivery Available	Import All Function	Name of Item When Exporting with the Remote UI
<Change Default Settings>	<Register>, <Initialize>	Yes	Yes	No	No	C	Favorite Settings

<Mail Box Settings>

Specify the mail box settings.

- ▶<Set/Register Mail Boxes>(P. 1288)
- ▶<Settings for All Mail Boxes>(P. 1288)
- ▶<Box Security Settings>(P. 1289)

NOTE

- For information on the items ("A", "B", "C", and "No") in the "Import All Function" column, see ▶<Import All Function>(P. 1054) .

<Set/Register Mail Boxes>

 (Settings/Registration) ▶ <Function Settings> ▶ <Store/Access Files> ▶ <Mail Box Settings>

You can set a PIN and name for a Mail Box as well as specify the period of time before files in a Mail Box are automatically deleted. ▶<Specifying the Mail Box Settings>(P. 737)

Item	Setting Description	DeviceAdmin	NetworkAdmin	Can be set in Remote UI	Device Information Delivery Available	Import All Function	Name of Item When Exporting with the Remote UI
<Set/Register Mail Boxes>	<Box No.>: 00 to 99	Yes	Yes	Yes	No	C	Box Settings
	<Register Box Name>	Yes	Yes	Yes	No	C	Box Settings
	<PIN>	Yes	Yes	Yes	No	C	Box Settings
	<Time Until File Auto Delete>: 0 = Off/1, 2, 3, 6, 12 hr./1, 2, 3, 7, 30 days	Yes	Yes	Yes	No	C	Box Settings
	<URL Send Settings>*1	Yes	Yes	Yes	No	C	Box Settings
	<Print When Storing from Printer Driver>: <On>, <Off>	Yes	Yes	Yes	No	C	Box Settings
	<Initialize>	Yes	Yes	Yes	No	No	-

*1 May not appear on some models.

<Settings for All Mail Boxes>

 (Settings/Registration) ▶ <Function Settings> ▶ <Store/Access Files> ▶ <Mail Box Settings>

Specify settings that are applied collectively to all mail boxes.

- ▶<Settings for All Mail Boxes>(P. 1290)

<Box Security Settings>

 (Settings/Registration) ▶ <Function Settings> ▶ <Store/Access Files> ▶ <Mail Box Settings>

Specify the mail box security settings.

 <Box Security Settings>(P. 1291)

<Settings for All Mail Boxes>

Specify settings that are applied collectively to all mail boxes.

▶<Time Until File Auto Delete>(P. 1290)

▶<Print When Storing from Printer Driver>(P. 1290)

NOTE

- For information on the items ("A", "B", "C", and "No") in the "Import All Function" column, see ▶<Import All Function>(P. 1054) .

<Time Until File Auto Delete>

 (Settings/Registration) ▶ <Function Settings> ▶ <Store/Access Files> ▶ <Mail Box Settings> ▶ <Settings for All Mail Boxes>

You can specify the period of time before files in boxes are automatically deleted.

Item	Setting Description	DeviceAdmin	NetworkAdmin	Can be set in Remote UI	Device Information Delivery Available	Import All Function	Name of Item When Exporting with the Remote UI
<Time Until File Auto Delete>	0 = Off/1, 2, 3, 6, 12 hr./1, 2, 3, 7, 30 days	Yes	No	No	No	No	-

<Print When Storing from Printer Driver>

 (Settings/Registration) ▶ <Function Settings> ▶ <Store/Access Files> ▶ <Mail Box Settings> ▶ <Settings for All Mail Boxes>

You can select whether to print a file upon saving from a computer.

Item	Setting Description	DeviceAdmin	NetworkAdmin	Can be set in Remote UI	Device Information Delivery Available	Import All Function	Name of Item When Exporting with the Remote UI
<Print When Storing from Printer Driver>	<On>, <Off>	Yes	No	Yes	No	No	-

<Box Security Settings>

Specify the mail box security settings.

NOTE

- For information on the items ("A", "B", "C", and "No") in the "Import All Function" column, see [Import All Function\(P. 1054\)](#) .

<Display Print When Storing from Printer Driver>

 (Settings/Registration) ▶ <Function Settings> ▶ <Store/Access Files> ▶ <Mail Box Settings> ▶ <Box Security Settings>

If you set this setting to <Off>, the settings for <Print When Storing from Printer Driver> cannot be changed.

Item	Setting Description	DeviceAdmin	NetworkAdmin	Can be set in Remote UI	Device Information Delivery Available	Import All Function	Name of Item When Exporting with the Remote UI
<Display Print When Storing from Printer Driver>	<On>, <Off>	Yes	No	Yes	Yes	C	Settings/Registration Basic Information

<Advanced Space Settings>

Specify the Advanced Space settings.

- ▶ <Unified Advanced Space Settings>(P. 1292)
- ▶ <Open to Public>(P. 1292)
- ▶ <WebDAV Server Settings>(P. 1293)
- ▶ <Allow to Create Personal Space>(P. 1293)
- ▶ <Delete All Personal Spaces>(P. 1293)
- ▶ <Initialize Shared Space>(P. 1294)
- ▶ <Prohibit Writing from External>(P. 1294)
- ▶ <Authentication Management>(P. 1295)
- ▶ <File Formats Allowed for Storing>(P. 1295)
- ▶ <Save Operation Log>(P. 1295)

NOTE

- For information on the items ("A", "B", "C", and "No") in the "Import All Function" column, see ▶ **Import All Function(P. 1054)** .

<Unified Advanced Space Settings>

 (Settings/Registration) ▶ <Function Settings> ▶ <Store/Access Files> ▶ <Advanced Space Settings>

You can batch specify the settings necessary to use the Advanced Space. ▶ **Setting Advanced Space to Public(P. 321)**

Item	Setting Description	DeviceAdmin	NetworkAdmin	Can be set in Remote UI	Device Information Delivery Available	Import All Function	Name of Item When Exporting with the Remote UI
<Unified Advanced Space Settings>	_*1	No	Yes	No	-	-	-

*1 Sets all of the following items that are required to use the Advanced Space.

- <Open to Public>
- <Authentication Management>
- <Allow to Create Personal Space>
- <Prohibit Writing from External>
- <File Formats Allowed for Storing>
- <WebDAV Server Settings>
- <SMB Server Settings>

<Open to Public>

 (Settings/Registration) ▶ <Function Settings> ▶ <Store/Access Files> ▶ <Advanced Space Settings>

You can specify how to open the Advanced Space to the public. The machine can be opened externally as either an SMB or WebDAV server.

Item	Setting Description	DeviceAdmin	NetworkAdmin	Can be set in Remote UI	Device Information Delivery Available	Import All Function	Name of Item When Exporting with the Remote UI
<Open to Public>	<Off>, <By WebDAV>, <By SMB>	Yes	Yes	Yes	No	C	Settings/Registration Basic Information

<WebDAV Server Settings>

 (Settings/Registration) ▶ <Function Settings> ▶ <Store/Access Files> ▶ <Advanced Space Settings>

You can specify the security settings to use when opening the machine externally as a WebDAV server.

Item	Setting Description	DeviceAdmin	NetworkAdmin	Can be set in Remote UI	Device Information Delivery Available	Import All Function	Name of Item When Exporting with the Remote UI
<WebDAV Server Settings>	<Authentication Type>: <Basic>, <Off> <Use TLS>: <On>, <Off>	No	Yes	Yes	No	C	Settings/Registration Basic Information

<Allow to Create Personal Space>

 (Settings/Registration) ▶ <Function Settings> ▶ <Store/Access Files> ▶ <Advanced Space Settings>

You can select whether to allow a Personal Space to be created in the Advanced Space.

Item	Setting Description	DeviceAdmin	NetworkAdmin	Can be set in Remote UI	Device Information Delivery Available	Import All Function	Name of Item When Exporting with the Remote UI
<Allow to Create Personal Space>	<On>, <Off>	Yes	Yes	Yes	No	C	Settings/Registration Basic Information

<Delete All Personal Spaces>

 (Settings/Registration) ▶ <Function Settings> ▶ <Store/Access Files> ▶ <Advanced Space Settings>

You can delete all Personal Spaces in the Advanced Space.

Item	Setting Description	DeviceAdmin	NetworkAdmin	Can be set in Remote UI	Device Information Delivery Available	Import All Function	Name of Item When Exporting with the Remote UI
<Delete All Personal Spaces>	<Yes>, <No>	Yes	Yes	Yes	No	No	-

<Initialize Shared Space>

 (Settings/Registration) ▶ <Function Settings> ▶ <Store/Access Files> ▶ <Advanced Space Settings>

You can delete all folders and files stored in the Shared Space of the Advanced Space.

Item	Setting Description	DeviceAdmin	NetworkAdmin	Can be set in Remote UI	Device Information Delivery Available	Import All Function	Name of Item When Exporting with the Remote UI
<Initialize Shared Space>	<Yes>, <No>	Yes	Yes	Yes	No	No	-

NOTE

- Users with Administrator privileges can delete single folders or all folders in the Shared Space from the Remote UI.



Start the Remote UI ▶ [Settings/Registration] ▶ [Function Settings] ▶ [Store/Access Files] ▶ [Delete Shared Space]

<Prohibit Writing from External>

 (Settings/Registration) ▶ <Function Settings> ▶ <Store/Access Files> ▶ <Advanced Space Settings>

For users that accessed the machine via a computer or another imageRUNNER ADVANCE series machine, you can select whether to prohibit those users from creating a folder or saving a file in the Advanced Space opened externally.

Item	Setting Description	DeviceAdmin	NetworkAdmin	Can be set in Remote UI	Device Information Delivery Available	Import All Function	Name of Item When Exporting with the Remote UI
<Prohibit Writing from External>	<On>, <Off>	Yes	Yes	Yes	No	C	Settings/Registration Basic Information

NOTE

- Restrictions for the following operations are canceled when this setting is set to <Off>.
 - Creating folders
 - Renaming folders
 - Deleting folders
 - Storing documents
 - Renaming documents
 - Deleting documents
 - Moving/duplicating documents and folders

IMPORTANT

- Even if this setting is set to <On>, you can send a document to the Advanced Space of the machine using <Scan and Send> if a user with Administrator privileges specifies the address of the machine on the network (the loopback addresses). Specify the following IP address and host name for the loopback address.
 - IPv4: 127.0.0.1
 - IPv6: 0:0:0:0:0:0:0:1 or ::1
 - Host name: localhost\

<Authentication Management>

 (Settings/Registration) ▶ <Function Settings> ▶ <Store/Access Files> ▶ <Advanced Space Settings>

You can select whether to manage the authentication of users who access the Advanced Space. To allow a Personal Space to be created, you need to set this setting to <On>.

Item	Setting Description	DeviceAdmin	NetworkAdmin	Can be set in Remote UI	Device Information Delivery Available	Import All Function	Name of Item When Exporting with the Remote UI
<Authentication Management>	<On>, <Off>	Yes	Yes	Yes	No	C	Settings/Registration Basic Information

<File Formats Allowed for Storing>

 (Settings/Registration) ▶ <Function Settings> ▶ <Store/Access Files> ▶ <Advanced Space Settings>

You can set the file formats allowed for saving in the Advanced Space.

Item	Setting Description	DeviceAdmin	NetworkAdmin	Can be set in Remote UI	Device Information Delivery Available	Import All Function	Name of Item When Exporting with the Remote UI
<File Formats Allowed for Storing>	<Dev. Supported Formats>, <Common Office Formats>, <All>	Yes	Yes	Yes	No	C	Settings/Registration Basic Information

<Save Operation Log>

 (Settings/Registration) ▶ <Function Settings> ▶ <Store/Access Files> ▶ <Advanced Space Settings>

You can select whether to create operation logs for the Advanced Space. If you have operation logs performed to the Advanced Space, you can check and trace the recorded user operations using the Remote UI. In addition, the logs can be saved to a computer in the CSV format.  **Managing the Logs(P. 941)**

Settings/Registration

Item	Setting Description	DeviceAdmin	NetworkAdmin	Can be set in Remote UI	Device Information Delivery Available	Import All Function	Name of Item When Exporting with the Remote UI
<Save Operation Log>	<On>, <Off>	Yes	Yes	Yes	No	C	Settings/Registration Basic Information

<Network Settings>

Specify the network settings used when you store scanned originals or use the stored files.

- ▶<Network Place Settings>(P. 1297)
- ▶<Protocol for External Reference>(P. 1297)
- ▶<Confirm TLS Certificate for Network Access>(P. 1298)
- ▶<Personal Folder Specification Method>(P. 1298)

NOTE

- For information on the items ("A", "B", "C", and "No") in the "Import All Function" column, see ▶<Import All Function>(P. 1054) .

<Network Place Settings>

 (Settings/Registration) ▶ <Function Settings> ▶ <Store/Access Files> ▶ <Network Settings>

You can register the Advanced Space of another imageRUNNER ADVANCE series machine or a Windows server as an external reference. ▶<Connecting to the Other Devices>(P. 326)

Item	Setting Description	DeviceAdmin	NetworkAdmin	Can be set in Remote UI	Device Information Delivery Available	Import All Function	Name of Item When Exporting with the Remote UI
<Network Place Settings>	<Register> (<Name>, <Protocol>, <Location>), <Edit> (<Name>, <Protocol>, <Location>), <Details>, <Delete>	Yes	Yes	Yes	No	C	Settings/Registration Basic Information

<Protocol for External Reference>

 (Settings/Registration) ▶ <Function Settings> ▶ <Store/Access Files> ▶ <Network Settings>

You can select the protocol to use when accessing the Advanced Space of another imageRUNNER ADVANCE series machine or a Windows server which is opened externally. ▶<Connecting to the Other Devices>(P. 326)

Item	Setting Description	DeviceAdmin	NetworkAdmin	Can be set in Remote UI	Device Information Delivery Available	Import All Function	Name of Item When Exporting with the Remote UI
<Protocol for External Reference>	<SMB>: <On>, <Off> <WebDAV>: <On>, <Off>	Yes	Yes	Yes	No	C	Settings/Registration Basic Information

<Confirm TLS Certificate for Network Access>

 (Settings/Registration) ▶ <Function Settings> ▶ <Store/Access Files> ▶ <Network Settings>

You can confirm whether the TLS server certificate is valid when accessing the Advanced Space of another imageRUNNER ADVANCE series machine or a Windows server. You can verify the validity of the certificate and reliability of the certificate chain, as well as confirm the CN (Common Name).

 **Connecting to the Other Devices(P. 326)**

Item	Setting Description	DeviceAdmin	NetworkAdmin	Can be set in Remote UI	Device Information Delivery Available	Import All Function	Name of Item When Exporting with the Remote UI
<Confirm TLS Certificate for Network Access>	<On>, <Off>	No	No	Yes	No	C	Settings/Registration Basic Information
	When <On> is selected: <ul style="list-style-type: none"> <Add Items to Verify>: <CN>: <On>, <Off> 	No	No	Yes	No	C	Settings/Registration Basic Information

<Personal Folder Specification Method>

 (Settings/Registration) ▶ <Function Settings> ▶ <Store/Access Files> ▶ <Network Settings>

A Personal folder is an individual folder that can be used by the user logged in with personal authentication management. Shared folders and file servers can be specified and used as a Personal folder.  **Configuring Personal Folders(P. 846)**

Item	Setting Description	DeviceAdmin	NetworkAdmin	Can be set in Remote UI	Device Information Delivery Available	Import All Function	Name of Item When Exporting with the Remote UI
<Personal Folder Specification Method>	<Home Folder>, <Register for Each User>, <Use Login Server>	No	No	Yes	No	C	Settings/Registration Basic Information
	When <Home Folder> is selected: <ul style="list-style-type: none"> <Set>, <Use Authentication Info. of Each User> 						
	<Set>: <Protocol>(<Windows (SMB)>, <WebDAV>), <Host Name>, <Folder Path>						
	When <Use Login Server> is selected: <ul style="list-style-type: none"> <Use Authentication Info. of Each User> 						

NOTE

- A Personal folder is a folder shared by the following screens.
 - <Scan and Send>
 - <Network> in <Scan and Store>
 - <Network> in <Access Stored Files>

<Memory Media Settings>

Specify the memory device settings.

▶<Use Scan/Print Function>(P. 1300)

▶<Select Option When Connecting Memory Media>(P. 1300)

NOTE

- For information on the items ("A", "B", "C", and "No") in the "Import All Function" column, see ▶<Import All Function>(P. 1054) .

<Use Scan/Print Function>

 (Settings/Registration) ▶ <Function Settings> ▶ <Store/Access Files> ▶ <Memory Media Settings>

Specifying this setting enables you to save documents stored in memory media, as well as print files in memory media. ▶<Restricting the Use of Memory Media>(P. 889)

Item	Setting Description	DeviceAdmin	NetworkAdmin	Can be set in Remote UI	Device Information Delivery Available	Import All Function	Name of Item When Exporting with the Remote UI
<Use Scan/Print Function>	<Use Scan Function>: <On>, <Off>	Yes	No	Yes	Yes	C	Settings/Registration Basic Information
	<Use Print Function>: <On>, <Off>	Yes	No	Yes	Yes	C	Settings/Registration Basic Information

<Select Option When Connecting Memory Media>

 (Settings/Registration) ▶ <Function Settings> ▶ <Store/Access Files> ▶ <Memory Media Settings>

You can set whether to display shortcuts to available functions when memory media is connected. ▶<Inserting a memory media>(P. 739)

Item	Setting Description	DeviceAdmin	NetworkAdmin	Can be set in Remote UI	Device Information Delivery Available	Import All Function	Name of Item When Exporting with the Remote UI
<Select Option When Connecting Memory Media>	<On>, <Off>	Yes	Yes	No	No	C	Settings/Registration Basic Information

<Print>

Specify the settings for the print function.

- ▶ <Forced Hold>(P. 1301)
- ▶ <Job Storage Period>(P. 1301)
- ▶ <Delete Job After Printing>(P. 1302)
- ▶ <Only Allow Encrypted Print Jobs>(P. 1302)
- ▶ <Include Domain as User Recognition Condition>(P. 1302)
- ▶ <Display Other User Jobs>(P. 1302)
- ▶ <Restrict Deletion of Other User Jobs>(P. 1303)
- ▶ <Match Case for User Name>(P. 1303)
- ▶ <Job List Display Settings>(P. 1303)
- ▶ <Held Jobs Warning Settings>(P. 1304)
- ▶ <PIN Settings for Secure Print Jobs>(P. 1304)
- ▶ <Enable Auto Print Function When Logging In>(P. 1305)
- ▶ <Auto Print User Jobs When Logging In>(P. 1306)

NOTE

- For information on the items ("A", "B", "C", and "No") in the "Import All Function" column, see ▶ **Import All Function(P. 1054)** .

<Forced Hold>

 (Settings/Registration) ▶ <Function Settings> ▶ <Print>

Specify the settings for the forced hold printing. ▶ **Configuring the Forced Hold Printing Settings(P. 886)**

Item	Setting Description	DeviceAdmin	NetworkAdmin	Can be set in Remote UI	Device Information Delivery Available	Import All Function	Name of Item When Exporting with the Remote UI
<Forced Hold>	<On>, <Off> When <On> is selected: <ul style="list-style-type: none"> • <Validate/ Invalidate>, <Register>, <Details/Edit>, <Delete> 	Yes	Yes	Yes	No	C	Settings/Registration Basic Information

<Job Storage Period>

 (Settings/Registration) ▶ <Function Settings> ▶ <Print>

Specify the time period for storing jobs.

Item	Setting Description	DeviceAdmin	NetworkAdmin	Can be set in Remote UI	Device Information Delivery Available	Import All Function	Name of Item When Exporting with the Remote UI
<Job Storage Period>	10, 20, 30 min., 1, 2, 3, 6, 12 hr., 1, 2, 3 days	Yes	Yes	No	No	C	Settings/Registration Basic Information

<Delete Job After Printing>

 (Settings/Registration) ► <Function Settings> ► <Print>

Specify whether to delete jobs after they are printed.

Item	Setting Description	DeviceAdmin	NetworkAdmin	Can be set in Remote UI	Device Information Delivery Available	Import All Function	Name of Item When Exporting with the Remote UI
<Delete Job After Printing>	<On>, <Off>	Yes	Yes	Yes	No	C	Settings/Registration Basic Information

<Only Allow Encrypted Print Jobs>

 (Settings/Registration) ► <Function Settings> ► <Print>

You can set the machine to only receive encrypted secure print jobs from computers.

Item	Setting Description	DeviceAdmin	NetworkAdmin	Can be set in Remote UI	Device Information Delivery Available	Import All Function	Name of Item When Exporting with the Remote UI
<Only Allow Encrypted Print Jobs>	<On>, <Off>	Yes	Yes	Yes	No	C ^{*1}	Settings/Registration Basic Information

*1 If the license for encrypted secure printing is validated.

<Include Domain as User Recognition Condition>

 (Settings/Registration) ► <Function Settings> ► <Print>

Specify whether to determine print jobs of a login user by "user name + domain name" or only "user name". Depending on your environment, if print jobs are not correctly determined as My Jobs, they can be correctly determined as jobs of the login user by selecting <Off> and excluding "domain name".

Item	Setting Description	DeviceAdmin	NetworkAdmin	Can be set in Remote UI	Device Information Delivery Available	Import All Function	Name of Item When Exporting with the Remote UI
<Include Domain as User Recognition Condition>	<On>, <Off>	Yes	Yes	Yes	No	C	Settings/Registration Basic Information

<Display Other User Jobs>

 (Settings/Registration) ► <Function Settings> ► <Print>

Specify whether to display the jobs from users other than the authorized user.

Item	Setting Description	DeviceAdmin	NetworkAdmin	Can be set in Remote UI	Device Information Delivery Available	Import All Function	Name of Item When Exporting with the Remote UI
<Display Other User Jobs>	<On>, <Off>	Yes	Yes	Yes	No	C	Settings/Registration Basic Information

<Restrict Deletion of Other User Jobs>

 (Settings/Registration) ► <Function Settings> ► <Print>

Specify whether to allow jobs of users other than the authorized user to be deleted when the jobs of users other than the authorized user are displayed.

Item	Setting Description	DeviceAdmin	NetworkAdmin	Can be set in Remote UI	Device Information Delivery Available	Import All Function	Name of Item When Exporting with the Remote UI
<Restrict Deletion of Other User Jobs>	<On>, <Off>	Yes	Yes	Yes	No	C	Settings/Registration Basic Information

<Match Case for User Name>

 (Settings/Registration) ► <Function Settings> ► <Print>

Specify whether to set the machine to distinguish uppercase and lowercase characters for user names.

Item	Setting Description	DeviceAdmin	NetworkAdmin	Can be set in Remote UI	Device Information Delivery Available	Import All Function	Name of Item When Exporting with the Remote UI
<Match Case for User Name>	<On>, <Off>	Yes	Yes	Yes	No	C	Settings/Registration Basic Information

NOTE

- This setting is applied to the whole user names including domain names.
- It is recommended that this is set together with <User Management> in <Authentication Management> ► <Match Case for User Name> ► <Management Settings>.

<Job List Display Settings>

 (Settings/Registration) ► <Function Settings> ► <Print>

Specify the job types to be included in the job list, and the job type to be selected by default.

Item	Setting Description	DeviceAdmin	NetworkAdmin	Can be set in Remote UI	Device Information Delivery Available	Import All Function	Name of Item When Exporting with the Remote UI
<Job List Display Settings>	<Personal>: <On>, <Off> <Shared>: <On>, <Off> <Group>: <On>, <Off> When two or more of personal/shared/group are set to <On>: <ul style="list-style-type: none"> <Personal>, <Shared>, <Group> 	Yes	Yes	No	No	C	Settings/Registration Basic Information

NOTE

- You cannot specify <On> for <Group> only in <Job List Display Settings>. Either <Personal> or <Shared> must also be set to <On>.

<Held Jobs Warning Settings>

 (Settings/Registration) ► <Function Settings> ► <Print>

Specify the method for sending Job Hold alerts.

Item	Setting Description	DeviceAdmin	NetworkAdmin	Can be set in Remote UI	Device Information Delivery Available	Import All Function	Name of Item When Exporting with the Remote UI
<Held Jobs Warning Settings>	<Display Warning on Job List Screen>: <On>, <Off> <Display Warning When Starting to Print>: <On>, <Off> When <On> is selected: <ul style="list-style-type: none"> <If Print Jobs with Specified Number of Pages or More Are Included>: <On>, <Off> (1 to 100 to 9999) <If 1-Sided Print Jobs Are Included>: <On>, <Off> <If Color Print Jobs Are Included>: <On>, <Off> 	Yes	Yes	Yes	No	C	Settings/Registration Basic Information

<PIN Settings for Secure Print Jobs>

 (Settings/Registration) ► <Function Settings> ► <Print>

You can set whether to require a PIN to be entered when printing, displaying images, or deleting with the Secured Print function.

Item	Setting Description	DeviceAdmin	NetworkAdmin	Can be set in Remote UI	Device Information Delivery Available	Import All Function	Name of Item When Exporting with the Remote UI
<PIN Settings for Secure Print Jobs>	<Require PIN for Printing/Displaying User Jobs>: <On>, <Off> <Require PIN for Job Deletion>: <On>, <Off>	Yes	Yes	Yes	No	C	Settings/Registration Basic Information

NOTE

- For the Encrypted Secure Print function, you can set whether to require a PIN to be entered when deleting. In addition, it is necessary to enter a PIN to print a document/display the preview regardless of the values specified in <Require PIN for Printing/Displaying User Jobs>.

<Enable Auto Print Function When Logging In>

 (Settings/Registration) ► <Function Settings> ► <Print>

You can set whether to allow forced hold print jobs to be automatically printed when each user logs in.

Item	Setting Description	DeviceAdmin	NetworkAdmin	Can be set in Remote UI	Device Information Delivery Available	Import All Function	Name of Item When Exporting with the Remote UI
<Enable Auto Print Function When Logging In>	<On>, <Off>	Yes	Yes	Yes	No	C	Settings/Registration Basic Information

IMPORTANT

- This setting is disabled if any of the following settings is specified.
 - <Use User Authentication> is <Off>
 - <Enable Use of Personal Settings> is <Off>
 - <Use ACCESS MANAGEMENT SYSTEM> is <On>
 - <Only Allow Encrypted Print Jobs> is <On>
 - <Personal> for <Job List Display Settings> is <Off>
 - <Display Warning When Starting to Print> for <Held Jobs Warning Settings> is <On>

NOTE

- Changing this setting from <Off> to <On> automatically sets <Auto Print User Jobs When Logging In> to <On> for all users. This means that users' own jobs will automatically be printed when they log in, without them having to change any settings.

<Auto Print User Jobs When Logging In>

 (Settings/Registration) ▶ <Function Settings> ▶ <Print>

You can set whether to automatically print forced hold print jobs after logging in.  **Automatically Printing Forced Hold Print Jobs after Logging In(P. 610)**

Item	Setting Description	DeviceAdmin	NetworkAdmin	Can be set in Remote UI	Device Information Delivery Available	Import All Function	Name of Item When Exporting with the Remote UI
<Auto Print User Jobs When Logging In>	<On>, <Off>	Yes	Yes	No	No	No	-

IMPORTANT

- This setting is disabled if any of the following settings is specified.
 - <Use User Authentication> is <Off>
 - <Enable Auto Print Function When Logging In> is <Off>
 - <Enable Use of Personal Settings> is <Off>
 - <Use ACCESS MANAGEMENT SYSTEM> is <On>
 - <Only Allow Encrypted Print Jobs> is <On>
 - <Personal> for <Job List Display Settings> is <Off>
 - <Display Warning When Starting to Print> for <Held Jobs Warning Settings> is <On>

NOTE

- When you change <Enable Auto Print Function When Logging In> from <Off> to <On>, this setting is automatically set to <On>.

<Web Access>

961F-0SY

Specify the settings for the Web Access function.

- For details, see "Web Access" on the online manual website. **Web Access**

NOTE

- For information on the items ("A", "B", "C", and "No") in the "Import All Function" column, see [Import All Function\(P. 1054\)](#) .

Item	Setting Description	DeviceAdmin	NetworkAdmin	Can be set in Remote UI	Device Information Delivery Available	Import All Function	Name of Item When Exporting with the Remote UI
<Settings>							
<Security>							
<TLS Version Settings>	<Attempt All Versions>, <TLS 1.3>, <TLS 1.2>, <TLS 1.1>, <TLS 1.0>	Yes	Yes	No	No	C	Web Access Settings
<Use JavaScript>	<On>, <Off>	Yes	Yes	No	No	C	Web Access Settings
<Display Mixed HTTPS/HTTP Pg>	<On>, <Off>	Yes	Yes	No	No	C	Web Access Settings
<Server Address to Exempt from Warning>	(NULL)	Yes	Yes	No	No	C	Web Access Settings
<Server Address to Allow for Sharing Info>	(NULL)	Yes	Yes	No	No	C	Web Access Settings
<Server Addr. to Allow for Simple PDF Print>	(NULL)	Yes	Yes	No	No	C	Web Access Settings
<Restrict Share Device Information>	<On>, <Off>	Yes	Yes	No	No	C	Web Access Settings
<Display Warning When No Root Certificate>	<On>, <Off>	Yes	Yes	No	No	C	Web Access Settings
<Display Warning When No Match for Cert. CN>	<On>, <Off>	Yes	Yes	No	No	C	Web Access Settings
<Displ Warning when Entering Secured Page>	<On>, <Off>	Yes	Yes	No	No	C	Web Access Settings
<Displ. Warning when Leaving Secured Page>	<On>, <Off>	Yes	Yes	No	No	C	Web Access Settings
<Cache>							

Settings/Registration

Item	Setting Description	DeviceAdmin	NetworkAdmin	Can be set in Remote UI	Device Information Delivery Available	Import All Function	Name of Item When Exporting with the Remote UI
<Use Cache>	<On>, <Off>	Yes	Yes	No	No	C	Web Access Settings
<Clear Cache>	<Yes>, <No>	Yes	Yes	No	No	No	-
<Cookie>							
<Cookie Handling>	<Accept>, <Block>	Yes	Yes	No	No	C	Web Access Settings
<Delete Cookies>	<Yes>, <No>	Yes	Yes	No	No	No	-
<Local Storage>							
<Clear Local Storage>	<Yes>, <No>	Yes	Yes	No	No	No	-
<Privacy Policy and Regulations>							
<Restrict URL Entry>	<On>, <Off>	Yes	Yes	No	No	C	Web Access Settings
<Restrict Add/Edit Favorites>	<On>, <Off>	Yes	Yes	No	No	No	-
<Restrict Storing in Mail Box/Printing>	<On>, <Off>	Yes	Yes	No	No	C	Web Access Settings
<Restrict File Upload>	<On>, <Off>	Yes	Yes	No	No	C	Web Access Settings
<Hide Screen Top Display>	<On>, <Off>	Yes	Yes	No	No	C	Web Access Settings
<Hide Buttons in Toolbar>	<On>, <Off>	Yes	Yes	No	No	C	Web Access Settings
<Hide Address in Toolbar>	<On>, <Off>	Yes	Yes	No	No	C	Web Access Settings
<Hide Web Access Button>	<On>, <Off>	Yes	Yes	No	No	C	Web Access Settings
<Proxy Settings>							
<Use a proxy server>	(Display Only)	Yes	Yes	No	No	No	-
<Proxy Server Address>	(Display Only)	Yes	Yes	No	No	No	-
<Port Number>	(Display Only)	Yes	Yes	No	No	No	-
<Use proxy auth.>	(Display Only)	Yes	Yes	No	No	No	-
<Address Without Using Proxy>	(NULL)	Yes	Yes	No	No	C	Web Access Settings
<Use HTTP1.1 for proxy connection>	<On>, <Off>	Yes	Yes	No	No	C	Web Access Settings

Settings/Registration

Item	Setting Description	DeviceAdmin	NetworkAdmin	Can be set in Remote UI	Device Information Delivery Available	Import All Function	Name of Item When Exporting with the Remote UI
<Exit Sleep Mode When Displ. Web Access Scrn>							
<Scanner>	<On>, <Off>	Yes	Yes	No	No	C	Web Access Settings
<Printer>	<On>, <Off>	Yes	Yes	No	No	C	Web Access Settings
<User Agent>							
<User Agent>	User Agent Information <Restore Initial Settings>	Yes	Yes	No	No	C	Web Access Settings
<Version>							
<About>	(Display Only)	Yes	Yes	No	No	No	-

<Set Destination>

Specify the settings for registering destinations and the address book.

- ▶ <Address Lists>(P. 1310)
- ▶ <Register Destinations>(P. 1310)
- ▶ <Rename Address List>(P. 1311)
- ▶ <Register One-Touch>(P. 1311)
- ▶ <Change Default Display of Address Book>(P. 1311)
- ▶ <Address Book PIN>(P. 1312)
- ▶ <Manage Address Book Access Numbers>(P. 1312)
- ▶ <Include Password When Exporting Address Book>(P. 1312)
- ▶ <Register LDAP Server>(P. 1313)
- ▶ <Auto Search When Using LDAP Server>(P. 1313)
- ▶ <Confirm TLS Certificate for LDAP Server Access>(P. 1313)
- ▶ <Change Default LDAP Search Conditions>(P. 1314)
- ▶ <Register/Edit LDAP Search Attribute>(P. 1314)
- ▶ <Settings for Search by Name When Using LDAP Server>(P. 1315)
- ▶ <Acquire Remote Address Book>(P. 1316)
- ▶ <Make Remote Address Book Open>(P. 1316)
- ▶ <Use Personal Address List>(P. 1316)
- ▶ <Use User Group Address List>(P. 1316)

NOTE

- For information on the items ("A", "B", "C", and "No") in the "Import All Function" column, see ▶ **Import All Function(P. 1054)** .

<Address Lists>

 (Settings/Registration) ▶ <Set Destination>

You can print a list of destinations registered in the Address Book or one-touch buttons. ▶ **Printing a List of Settings(P. 1034)**

Item	Setting Description	DeviceAdmin	NetworkAdmin	Can be set in Remote UI	Device Information Delivery Available	Import All Function	Name of Item When Exporting with the Remote UI
<Address Lists>	<Address List 1> to <Address List 10>, <One-Touch>, <Address List for Admin.>, <Print List>	Yes	Yes	Yes	No	No	-

IMPORTANT

- Even if you set ▶ **<Manage Address Book Access Numbers>(P. 1312)** to <On>, all destinations including those stored with access numbers are printed.

<Register Destinations>

 (Settings/Registration) ▶ <Set Destination>

You can register destinations to the address book of the machine. ▶ **Registering Destinations in the Address Book(P. 394)**

Item	Setting Description	DeviceAdmin	NetworkAdmin	Can be set in Remote UI	Device Information Delivery Available	Import All Function	Name of Item When Exporting with the Remote UI
<Register Destinations>	<Register New Destination>, <Details/Edit>, <Delete>, <Search by Name>	Yes	Yes	Yes*1	Yes*2	C	Address Book

*1 <Server to Search>: No

*2 <Personal Address List>, <User Group Address List>: No

<Rename Address List>

 (Settings/Registration) ▶ <Set Destination>

You can rename each address list.

Item	Setting Description	DeviceAdmin	NetworkAdmin	Can be set in Remote UI	Device Information Delivery Available	Import All Function	Name of Item When Exporting with the Remote UI
<Rename Address List>	<Address List 1> to <Address List 10>, <Rename>	Yes	Yes	Yes	Yes	C	Address Book

<Register One-Touch>

 (Settings/Registration) ▶ <Set Destination>

You can register destinations to the one-touch buttons of the machine.  **Registering a Destination in a One-Touch Button(P. 410)**

Item	Setting Description	DeviceAdmin	NetworkAdmin	Can be set in Remote UI	Device Information Delivery Available	Import All Function	Name of Item When Exporting with the Remote UI
<Register One-Touch>	<001> to <200>, <Register/Edit>, <Delete>	Yes	Yes	Yes	Yes	C	Address Book

<Change Default Display of Address Book>

 (Settings/Registration) ▶ <Set Destination>

You can specify the type of the Address Book to display when you press <Address Book> on the Fax Basic Features screen or the Scan and Send Basic Features screen.

Item	Setting Description	DeviceAdmin	NetworkAdmin	Can be set in Remote UI	Device Information Delivery Available	Import All Function	Name of Item When Exporting with the Remote UI
<Change Default Display of Address Book>	<Local>, <LDAP Server>, <Remote>	Yes	Yes	No	No	C	Settings/Registration Basic Information

<Address Book PIN>

 (Settings/Registration) ▶ <Set Destination>

You can set a PIN for the Address Book.  **Restricting Use of the Address Book(P. 879)**

Item	Setting Description	DeviceAdmin	NetworkAdmin	Can be set in Remote UI	Device Information Delivery Available	Import All Function	Name of Item When Exporting with the Remote UI
<Address Book PIN>	<Set>: <PIN>: Enter the PIN (7 digits maximum) <Confirm>	No	No	Yes	Yes	C	Settings/Registration Basic Information

<Manage Address Book Access Numbers>

 (Settings/Registration) ▶ <Set Destination>

You can select whether to allow users to set an access number for a destination when registering in the Address Book.  **Restricting Use of the Address Book(P. 879)**

Item	Setting Description	DeviceAdmin	NetworkAdmin	Can be set in Remote UI	Device Information Delivery Available	Import All Function	Name of Item When Exporting with the Remote UI
<Manage Address Book Access Numbers>	<On>, <Off>	No	No	Yes	Yes	C	Settings/Registration Basic Information

<Include Password When Exporting Address Book>

 (Settings/Registration) ▶ <Set Destination>

If you set this setting to <On>, you can select whether to include the passwords registered for destinations when exporting the Address Book using the Remote UI.

Item	Setting Description	DeviceAdmin	NetworkAdmin	Can be set in Remote UI	Device Information Delivery Available	Import All Function	Name of Item When Exporting with the Remote UI
<Include Password When Exporting Address Book>	<On>, <Off>	No	No	Yes	Yes	C	Settings/Registration Basic Information

NOTE

- You can set whether to export the following passwords:
 - The password for subaddress transmission set in fax destinations
 - The authentication password set for file server destinations (including the Advanced Space that is opened externally)

<Register LDAP Server>

 (Settings/Registration) ▶ <Set Destination>

You can specify the settings of an LDAP server, such as a server name and server address, you are using when searching for or registering destinations.  **Registering the LDAP Server(P. 299)**

Item	Setting Description	DeviceAdmin	NetworkAdmin	Can be set in Remote UI	Device Information Delivery Available	Import All Function	Name of Item When Exporting with the Remote UI
<Register LDAP Server>	<Register>, <Details/Edit>, <Delete>, <Print List>	Yes	Yes	Yes	No	B*1	Settings/Registration Basic Information

*1 <Delete>, <Print List>: No

<Auto Search When Using LDAP Server>

 (Settings/Registration) ▶ <Set Destination>

If you set this setting to <On>, you can immediately start searches when accessing an LDAP server from the control panel of the machine.

Item	Setting Description	DeviceAdmin	NetworkAdmin	Can be set in Remote UI	Device Information Delivery Available	Import All Function	Name of Item When Exporting with the Remote UI
<Auto Search When Using LDAP Server>	<On>, <Off>	Yes	Yes	No	Yes	C	Settings/Registration Basic Information

NOTE

- Automatic searches are only performed for the first LDAP server registered, which is displayed on the top of the LDAP server drop-down list.

<Confirm TLS Certificate for LDAP Server Access>

 (Settings/Registration) ▶ <Set Destination>

You can select whether to verify TLS certificates when connected to an LDAP server.

Item	Setting Description	DeviceAdmin	NetworkAdmin	Can be set in Remote UI	Device Information Delivery Available	Import All Function	Name of Item When Exporting with the Remote UI
<Confirm TLS Certificate for LDAP Server Access>	<On>, <Off>	Yes	No	Yes	No	C	Settings/Registration Basic Information
	When <On> is selected: <CN>: On, Off						

<Change Default LDAP Search Conditions>

 (Settings/Registration) ► <Set Destination>

You can register frequently used search conditions as the default settings for searching an LDAP server.

■ Registering the Default Search Conditions for Each LDAP Server

- 1 Press  (Settings/Registration).
- 2 Press <Set Destination> ► <Change Default LDAP Search Conditions> ► <Register>.
 - To restore the default search conditions, press <Initialize>.
- 3 Configure the search conditions.
- 4 Press <OK>.

NOTE

- You may have to set up the LDAP servers beforehand, depending on the network environment.
- Searching by organization/organizational unit may not be possible, depending on the information registered in an LDAP server.
- You can add other search attributes.  <Register/Edit LDAP Search Attribute>(P. 1314)

Item	Setting Description	DeviceAdmin	NetworkAdmin	Can be set in Remote UI	Device Information Delivery Available	Import All Function	Name of Item When Exporting with the Remote UI
<Change Default LDAP Search Conditions>	<Register>, <Initialize>	Yes	Yes	No	No	C	Personal Setting Information

<Register/Edit LDAP Search Attribute>

 (Settings/Registration) ► <Set Destination>

You can add search items to use when searching an LDAP server.

■ LDAP Search Attributes

- 1 Press  (Settings/Registration).

- 2 Press <Set Destination> ► <Register/Edit LDAP Search Attribute>.
- 3 Select <Not Registered 1> or <Not Registered 2>, and press <Register/Edit>.
 - To edit a search attribute, select a registered attribute, and press <Register/Edit>.
 - To delete a search attribute, press <Delete>.
- 4 Specify <Display Name> and <Attribute Name>, and press <OK> ► <Close>.

NOTE

- You cannot edit or delete names, <E-Mail>, <Fax>, <Organization> or <Organization Unit>.
- <Register/Edit> and <Delete> can only be performed for <Not Registered 1> and <Not Registered 2>.

Item	Setting Description	DeviceAdmin	NetworkAdmin	Can be set in Remote UI	Device Information Delivery Available	Import All Function	Name of Item When Exporting with the Remote UI
<Register/Edit LDAP Search Attribute>	<Name>, <E-Mail>, <Fax>, <Organization>, <Organization Unit>, <Not Registered 1>, <Not Registered 2>: <Register/Edit>, <Delete>	Yes	Yes	Yes	No	B	Settings/ Registration Basic Information

<Settings for Search by Name When Using LDAP Server>

 (Settings/Registration) ► <Set Destination>

You can specify the attribute used when searching an LDAP server for destinations by name using "Search by Name."

■ Configuring to "Search by Name" for LDAP Searches

- 1 Press  (Settings/Registration).
- 2 Press <Set Destination> ► <Settings for Search by Name When Using LDAP Server>.
- 3 Set <Name Type for Search Attribute> and <Filter>, and press <OK>.

Item	Setting Description	DeviceAdmin	NetworkAdmin	Can be set in Remote UI	Device Information Delivery Available	Import All Function	Name of Item When Exporting with the Remote UI
<Settings for Search by Name When Using LDAP Server>	<Name Type for Search Attribute>: cn , commonname, fullName, displayName, sn, givenName, Custom <Filter>:	Yes	No	No	No	C	Settings/ Registration Basic Information

	Contains, Does Not Contain, Equals, Differs from, Begins with , Ends with						
--	---	--	--	--	--	--	--

<Acquire Remote Address Book>

 (Settings/Registration) ► <Set Destination>

Specify the settings for acquiring a remote address book.

 <Acquire Remote Address Book>(P. 1318)

<Make Remote Address Book Open>

 (Settings/Registration) ► <Set Destination>

Specify the settings for making a remote address book public.

 <Make Remote Address Book Open>(P. 1320)

<Use Personal Address List>

 (Settings/Registration) ► <Set Destination>

You can select whether to use a personal Address Book of a user who logs in to the machine with personal authentication management.

Item	Setting Description	DeviceAdmin	NetworkAdmin	Can be set in Remote UI	Device Information Delivery Available	Import All Function	Name of Item When Exporting with the Remote UI
<Use Personal Address List>	<On>, <Off>	Yes	No	Yes	No	C	Settings/Registration Basic Information

<Use User Group Address List>

 (Settings/Registration) ► <Set Destination>

You can restrict the use of <User Group Address List>. However, when an administrator accesses the machine from the Remote UI, they can register/edit <User Group Address List> regardless of this setting.

Item	Setting Description	DeviceAdmin	NetworkAdmin	Can be set in Remote UI	Device Information Delivery Available	Import All Function	Name of Item When Exporting with the Remote UI
<Use User Group Address List>	<On>, <On (Browse Only)>, <Off>	Yes	No	Yes	No	C	Settings/Registration Basic Information

NOTE

Settings/Registration

- You can set to also change the name of the user group address book when a user group name is changed. Log in to the Remote UI as a user with Administrator privileges, press [Settings/Registration] ▶ [Set Destination] ▶ [Personal Address List/User Group Address List Settings] ▶ select the [Apply User Group Name Change to User Group Address List Name] check box.

<Acquire Remote Address Book>

Specify the settings for acquiring a remote address book.

- ▶<Acquire Address Book>(P. 1318)
- ▶<Remote Address Book Server Address>(P. 1318)
- ▶<Communication Timeout>(P. 1318)
- ▶<Fax TX Line Auto Select Adjustment>(P. 1319)

NOTE

- For information on the items ("A", "B", "C", and "No") in the "Import All Function" column, see ▶<Import All Function>(P. 1054) .

Item marked with an asterisk (*)

- Only appears if your machine has a fax function.

<Acquire Address Book>

 (Settings/Registration) ▶ <Set Destination> ▶ <Acquire Remote Address Book>

You can specify whether to use the Address book of another imageRUNNER ADVANCE series machine on the network as the Remote Address Book.

Item	Setting Description	DeviceAdmin	NetworkAdmin	Can be set in Remote UI	Device Information Delivery Available	Import All Function	Name of Item When Exporting with the Remote UI
<Acquire Address Book>	<On>, <Off>	Yes	Yes	Yes	Yes	C	Settings/Registration Basic Information

<Remote Address Book Server Address>

 (Settings/Registration) ▶ <Set Destination> ▶ <Acquire Remote Address Book>

You can specify the IP address or the host name of a device that opens the Remote Address Book externally. The IP address can be specified using IPv4 or IPv6.

Item	Setting Description	DeviceAdmin	NetworkAdmin	Can be set in Remote UI	Device Information Delivery Available	Import All Function	Name of Item When Exporting with the Remote UI
<Remote Address Book Server Address>	Enter the IP Address or Host Name	Yes	Yes	Yes	No	C	Settings/Registration Basic Information

<Communication Timeout>

 (Settings/Registration) ▶ <Set Destination> ▶ <Acquire Remote Address Book>

You can set the communication timeout. When a device opening a Remote Address Book does not respond within the specified time, the machine stops trying to obtain destinations from the device.

Item	Setting Description	DeviceAdmin	NetworkAdmin	Can be set in Remote UI	Device Information Delivery Available	Import All Function	Name of Item When Exporting with the Remote UI
<Communication Timeout>	15 to 30 to 120 sec.	Yes	Yes	Yes	Yes	C	Settings/Registration Basic Information

<Fax TX Line Auto Select Adjustment> *

 (Settings/Registration) ▶ <Set Destination> ▶ <Acquire Remote Address Book>

You can set whether to automatically select the fax line instead of using the line registered to the destination, when sending a fax to a destination obtained from a Remote Address Book.

Item	Setting Description	DeviceAdmin	NetworkAdmin	Can be set in Remote UI	Device Information Delivery Available	Import All Function	Name of Item When Exporting with the Remote UI
<Fax TX Line Auto Select Adjustment>	< On >, <Off>	Yes	Yes	Yes	Yes	C	Settings/Registration Basic Information

<Make Remote Address Book Open>

961F-0U2

Specify the settings for making a remote address book public.

NOTE

- For information on the items ("A", "B", "C", and "No") in the "Import All Function" column, see [▶ Import All Function\(P. 1054\)](#) .

<Make Address Book Open>

 (Settings/Registration) ▶ <Set Destination> ▶ <Make Remote Address Book Open>

You can select whether to open the Address Book of this machine to another imageRUNNER ADVANCE series machine on a network.

Item	Setting Description	DeviceAdmin	NetworkAdmin	Can be set in Remote UI	Device Information Delivery Available	Import All Function	Name of Item When Exporting with the Remote UI
<Make Address Book Open>	<On>, <Off>	Yes	Yes	Yes	No	C	Settings/Registration Basic Information

<Management Settings>

Specify the settings for operating and managing the machine, including user and hardware management and the security settings.

- ◂<User Management>(P. 1321)
- ◂<Device Management>(P. 1321)
- ◂<License/Other>(P. 1321)
- ◂<Data Management>(P. 1321)
- ◂<Security Settings>(P. 1321)

<User Management>

 (Settings/Registration) ▶ <Management Settings>

Specify the settings for managing the users of the machine.

- ◂<User Management>(P. 1322)

<Device Management>

 (Settings/Registration) ▶ <Management Settings>

Specify the settings for managing the hardware and optional equipment.

- ◂<Device Management>(P. 1332)

<License/Other>

 (Settings/Registration) ▶ <Management Settings>

Specify the settings for registering licenses and for the software that can be used on the machine.

- ◂<License/Other>(P. 1348)

<Data Management>

 (Settings/Registration) ▶ <Management Settings>

Specify the data management settings, including how to import, export, and initialize settings data.

- ◂<Data Management>(P. 1356)

<Security Settings>

 (Settings/Registration) ▶ <Management Settings>

Specify the settings for enhancing the machine's security.

- ◂<Security Settings>(P. 1360)

<User Management>

Specify the settings for managing the users of the machine.

- ▶<Authentication Management>(P. 1322)
- ▶<System Manager Information Settings>(P. 1322)
- ▶<Department ID Management>(P. 1322)

NOTE

- For information on the items ("A", "B", "C", and "No") in the "Import All Function" column, see ▶<Import All Function>(P. 1054) .

<Authentication Management>

 (Settings/Registration) ▶ <Management Settings> ▶ <User Management>

Specify the settings for managing the users of the machine using the authentication application.

- ▶<Authentication Management>(P. 1325)

<System Manager Information Settings>

 (Settings/Registration) ▶ <Management Settings> ▶ <User Management>

Set the System Manager information for the machine. ▶<Changing the System Manager ID and PIN>(P. 840)

Item	Setting Description	DeviceAdmin	NetworkAdmin	Can be set in Remote UI	Device Information Delivery Available	Import All Function	Name of Item When Exporting with the Remote UI
<System Manager Information Settings>	<System Manager ID>: 7654321 (Seven digits maximum) <System Manager PIN>: 7654321 (Seven digits maximum) <System Manager> <E-Mail Address> <Contact Information> <Comment>	No	No	Yes	Yes	C	Department ID Management Settings

<Department ID Management>

 (Settings/Registration) ▶ <Management Settings> ▶ <User Management>

Select whether to manage users in groups by assigning users to Department IDs. ▶<Configuring the Department ID Management Settings>(P. 842)

Settings/Registration

Item	Setting Description	DeviceAdmin	NetworkAdmin	Can be set in Remote UI	Device Information Delivery Available	Import All Function	Name of Item When Exporting with the Remote UI
<Department ID Management>	<On>, <Off>	No	No	Yes	Yes	C	Department ID Management Settings
<Register PIN>	<Register>, <Edit>, <Delete>, <Limit Functions>*1	No	No	Yes	Yes	C	Department ID Management Settings
	When <Register>/<Edit> is selected: <Department ID>, <PIN>, <Turn Limit On/Off and Set Page Limit>	No	No	Yes	Yes	C	Department ID Management Settings
	When <Turn Limit On/Off and Set Page Limit> is selected: <ul style="list-style-type: none"> • <Total Print Limit>: <On>, <Off> Page Limit (0 to 999999) • <Total Color Print Limit>: <On>, <Off> Page Limit (0 to 999999) • <Total Black & White Print Limit>: <On>, <Off> Page Limit (0 to 999999) • <Color Copy Limit>: <On>, <Off> Page Limit (0 to 999999) • <Black & White Copy Limit>: <On>, <Off> Page Limit (0 to 999999) • <Color Scan Limit>: <On>, <Off> Page Limit (0 to 999999) • <Black & White Scan Limit>: <On>, <Off> Page Limit (0 to 999999) • <Color Print Limit>: <On>, <Off> Page Limit (0 to 999999) • <Black & White Print Limit>: <On>, <Off> Page Limit (0 to 999999) 	No	No	Yes	Yes	C	Department ID Management Settings
<Page Totals>	<Clear>, <Print List>, <Clear All Totals>, <Large 2 Count Management>	No	No	Yes	No	No	-
<Allow Printer Jobs with Unknown IDs>	<On>, <Off>	No	No	Yes	Yes	C	Department ID Management Settings

Settings/Registration

Item	Setting Description	DeviceAdmin	NetworkAdmin	Can be set in Remote UI	Device Information Delivery Available	Import All Function	Name of Item When Exporting with the Remote UI
<Allow Remote Scan Jobs with Unknown IDs>	<On>, <Off>	No	No	Yes	Yes	C	Department ID Management Settings
<Allow Black & White Copy/Print Jobs>*1	<On>, <Off>	No	No	Yes	Yes	C	Department ID Management Settings
<Allow Black & White Printer Jobs>	<On>, <Off>	No	No	Yes	Yes	C	Department ID Management Settings

*1 Indicates items that appear only if DepartmentID Authentication is set as the login service.

<Authentication Management>

Specify the settings for managing the users of the machine using the authentication application.

- ▶ <Change Password>(P. 1325)
- ▶ <Register/Edit Authentication User>(P. 1325)
- ▶ <Use User Authentication>(P. 1326)
- ▶ <Keyboard Authentication>(P. 1326)
- ▶ <Login Screen Display Settings>(P. 1326)
- ▶ <Functions to Restrict>(P. 1327)
- ▶ <Restrict Job from Remote Device without User Auth.>(P. 1327)
- ▶ <Default Role When Registering User>(P. 1328)
- ▶ <Match Case for User Name>(P. 1328)
- ▶ <Allow Use of @ in User Name>(P. 1328)

NOTE

- For information on the items ("A", "B", "C", and "No") in the "Import All Function" column, see ▶ **Import All Function(P. 1054)** .

<Change Password>

 (Settings/Registration) ▶ <Management Settings> ▶ <User Management> ▶ <Authentication Management>

The users registered in the machine can change their own login password.

Item	Setting Description	DeviceAdmin	NetworkAdmin	Can be set in Remote UI	Device Information Delivery Available	Import All Function	Name of Item When Exporting with the Remote UI
<Change Password>	(32 characters maximum)	Yes	Yes	Yes	No	C	Authentication User Management

NOTE

- This item only appears when User Authentication is used and a user has logged in with privileges other than Administrator.
- If the user logged in with Administrator privileges, this item changes the password in ▶ **<Register/Edit Authentication User>(P. 1325)** .

<Register/Edit Authentication User>

 (Settings/Registration) ▶ <Management Settings> ▶ <User Management> ▶ <Authentication Management>

Select to register users in the machine and specify the user information, such as the password and privilege level. ▶ **Registering User Information in the Local Device(P. 809)**

Item	Setting Description	DeviceAdmin	NetworkAdmin	Can be set in Remote UI	Device Information Delivery Available	Import All Function	Name of Item When Exporting with the Remote UI
<Register/Edit Authentication User>	<Register>, <Details/Edit>, <Delete>	No	No	Yes	No	C	Authentication User Management

<Use User Authentication>

 (Settings/Registration) ▶ <Management Settings> ▶ <User Management> ▶ <Authentication Management>

Select whether to enable the personal authentication management function. You can also select which login methods to use for user authentication.

 **<Configuring the User Login Methods and Authentication Devices(P. 829)>**

Item	Setting Description	DeviceAdmin	NetworkAdmin	Can be set in Remote UI	Device Information Delivery Available	Import All Function	Name of Item When Exporting with the Remote UI
<Use User Authentication>	<p><On>, <Off> When <On> is selected:</p> <ul style="list-style-type: none"> • <Picture Login>*1: <On>, <Off> • <Keyboard Authentication>: <On>, <Off> 	No	No	Yes	Yes	C	Settings/ Registration Basic Information

*1 Indicates items that appear only when the appropriate optional equipment is available for use.

<Keyboard Authentication>

 (Settings/Registration) ▶ <Management Settings> ▶ <User Management> ▶ <Authentication Management>

Specify the keyboard authentication settings.

 **<Keyboard Authentication>(P. 1330)>**

<Login Screen Display Settings>

 (Settings/Registration) ▶ <Management Settings> ▶ <User Management> ▶ <Authentication Management>

Specify when to display the login screen by selecting either "when you start using the machine" or "after a function button is pressed." If "after a function button is pressed" is selected, you can specify the functions that require user login.  **<Specifying When to Display the Login Screen(P. 835)>**

Item	Setting Description	DeviceAdmin	NetworkAdmin	Can be set in Remote UI	Device Information Delivery Available	Import All Function	Name of Item When Exporting with the Remote UI
<Login Screen Display Settings>	<Displ When Dev Operation Start>, <Display When Func Is Selected>	No	No	Yes	No	C	Settings/ Registration Basic Information
	<p>When <Display When Func Is Selected> is selected:</p> <ul style="list-style-type: none"> • <Require Authentication For>: <Functions>, <Color Copy/Print> (<None (No Authentication)> 	No	No	Yes	No	C	Settings/ Registration Basic Information

Item	Setting Description	DeviceAdmin	NetworkAdmin	Can be set in Remote UI	Device Information Delivery Available	Import All Function	Name of Item When Exporting with the Remote UI
	<p>Required)>, <Full Color>, <Full Color/Two Colors>, <Full Color/Two Colors/Single Color></p> <ul style="list-style-type: none"> <Require Authentication in Settings/Registration For>*1: <All Items>, <Administrator Items Only> 	No	No	Yes	No	C	Settings/Registration Basic Information

*1 Indicates items that appear only if ACCESS MANAGEMENT SYSTEM is enabled.

NOTE

- If you change this setting, <**Restrict Access to Other User Jobs**>(P. 1339) may be set to <On>. For more information, see <**Specifying When to Display the Login Screen**>(P. 835) .

<Functions to Restrict>

(Settings/Registration) ► <Management Settings> ► <User Management> ► <Authentication Management>

Select whether to restrict use of particular functions when personal authentication management is enabled. <**Configuring the User Login Methods and Authentication Devices**>(P. 829)

Item	Setting Description	DeviceAdmin	NetworkAdmin	Can be set in Remote UI	Device Information Delivery Available	Import All Function	Name of Item When Exporting with the Remote UI
<Functions to Restrict>	<p><Print from Drivers without AMS Printer Driver Add-in>: <Restrict>, <Do Not Restrict></p>	No	No	Yes	No	C	Settings/Registration Basic Information
	<p><Remote Scan>: <Restrict>, <Do Not Restrict></p>	No	No	Yes	No	C	Settings/Registration Basic Information

<Restrict Job from Remote Device without User Auth.>

(Settings/Registration) ► <Management Settings> ► <User Management> ► <Authentication Management>

Select whether to apply personal authentication management to printing, faxing, and remote scanning via a computer. <**Using Personal Authentication to Manage Printing/Faxing/Remote Scanning via a Computer**>(P. 837)

Item	Setting Description	DeviceAdmin	NetworkAdmin	Can be set in Remote UI	Device Information Delivery Available	Import All Function	Name of Item When Exporting with the Remote UI
<Restrict Job from Remote Device without User Auth.>	<On>, <Off>	No	No	Yes	No	C	Settings/Registration Basic Information

<Default Role When Registering User>

 (Settings/Registration) ▶ <Management Settings> ▶ <User Management> ▶ <Authentication Management>

Select the role to apply to users in situations such as when no privileges are set.  **Configuring the User Login Methods and Authentication Devices(P. 829)**

Item	Setting Description	DeviceAdmin	NetworkAdmin	Can be set in Remote UI	Device Information Delivery Available	Import All Function	Name of Item When Exporting with the Remote UI
<Default Role When Registering User>	<Administrator>, <GeneralUser>, <DeviceAdmin>, <NetworkAdmin>, <PowerUser>* ¹ , <LimitedUser>* ¹	No	No	Yes	Yes	C	Settings/Registration Basic Information

*1 Indicates items that appear only if ACCESS MANAGEMENT SYSTEM is enabled.

<Match Case for User Name>

 (Settings/Registration) ▶ <Management Settings> ▶ <User Management> ▶ <Authentication Management>

Select whether user names are case-sensitive.

Item	Setting Description	DeviceAdmin	NetworkAdmin	Can be set in Remote UI	Device Information Delivery Available	Import All Function	Name of Item When Exporting with the Remote UI
<Match Case for User Name>	<On>, <Off>	No	No	Yes	No	C	Settings/Registration Basic Information

NOTE

- It is recommended that this is set together with <Function Settings> ▶ <Print> ▶ <Match Case for User Name>.

<Allow Use of @ in User Name>

 (Settings/Registration) ▶ <Management Settings> ▶ <User Management> ▶ <Authentication Management>

Select whether to allow "@" to be used in user names.

Settings/Registration

Item	Setting Description	DeviceAdmin	NetworkAdmin	Can be set in Remote UI	Device Information Delivery Available	Import All Function	Name of Item When Exporting with the Remote UI
<Allow Use of @ in User Name>	<On>, <Off>	No	No	Yes	No	C	Settings/Registration Basic Information

<Keyboard Authentication>

Specify the keyboard authentication settings.

- ▶<Number of Caches for Login Users>(P. 1330)
- ▶<Display Button to Change Password on Settings Menu>(P. 1330)
- ▶<Use Numeric Keys for Authentication>(P. 1330)
- ▶<Restrict Password Reuse>(P. 1331)
- ▶<Settings for Password Change Prohibition Period>(P. 1331)

NOTE

- For information on the items ("A", "B", "C", and "No") in the "Import All Function" column, see ▶<Import All Function>(P. 1054) .

<Number of Caches for Login Users>

 (Settings/Registration) ▶ <Management Settings> ▶ <User Management> ▶ <Authentication Management> ▶ <Keyboard Authentication>

Select whether to display the names of users who previously logged in in a drop-down list on the login screen. Select <0> to hide the login history, and select <1> to display only the name of the user who logged in most recently. ▶<Configuring the User Login Methods and Authentication Devices>(P. 829)

Item	Setting Description	DeviceAdmin	NetworkAdmin	Can be set in Remote UI	Device Information Delivery Available	Import All Function	Name of Item When Exporting with the Remote UI
<Number of Caches for Login Users>	<0>, <1>, <Max (Maximum No. for Device)>	No	No	Yes	Yes	C	Settings/Registration Basic Information

<Display Button to Change Password on Settings Menu>

 (Settings/Registration) ▶ <Management Settings> ▶ <User Management> ▶ <Authentication Management> ▶ <Keyboard Authentication>

Select whether to allow users to change passwords by using  on the top right corner of the login screen. ▶<Configuring the User Login Methods and Authentication Devices>(P. 829)

Item	Setting Description	DeviceAdmin	NetworkAdmin	Can be set in Remote UI	Device Information Delivery Available	Import All Function	Name of Item When Exporting with the Remote UI
<Display Button to Change Password on Settings Menu>	<On>, <Off>	No	No	Yes	Yes	C	Settings/Registration Basic Information

<Use Numeric Keys for Authentication>

 (Settings/Registration) ▶ <Management Settings> ▶ <User Management> ▶ <Authentication Management> ▶ <Keyboard Authentication>

If the user name and password are comprised of numbers only, authentication can be performed with numeric key entry only.

Item	Setting Description	DeviceAdmin	NetworkAdmin	Can be set in Remote UI	Device Information Delivery Available	Import All Function	Name of Item When Exporting with the Remote UI
<Use Numeric Keys for Authentication>	<On>, <Off>	No	No	Yes	No	C	Settings/Registration Basic Information

<Restrict Password Reuse>

 (Settings/Registration) ▶ <Management Settings> ▶ <User Management> ▶ <Authentication Management> ▶ <Keyboard Authentication>

Specify whether to prohibit the re-use of a password that has already been used.

Item	Setting Description	DeviceAdmin	NetworkAdmin	Can be set in Remote UI	Device Information Delivery Available	Import All Function	Name of Item When Exporting with the Remote UI
<Restrict Password Reuse>	<On>, <Off> When <On> is set: <ul style="list-style-type: none"> <Number of Prohibited Last Passwords>: 1 to 24 	Yes	Yes	Yes	No	C	Settings/Registration Basic Information

<Settings for Password Change Prohibition Period>

 (Settings/Registration) ▶ <Management Settings> ▶ <User Management> ▶ <Authentication Management> ▶ <Keyboard Authentication>

You can specify the period for which password changes are prohibited.

Item	Setting Description	DeviceAdmin	NetworkAdmin	Can be set in Remote UI	Device Information Delivery Available	Import All Function	Name of Item When Exporting with the Remote UI
<Settings for Password Change Prohibition Period>	<On>, <Off> When <On> is set: <ul style="list-style-type: none"> <Prohibition Period>: 1 to 179 	Yes	Yes	Yes	No	C	Settings/Registration Basic Information

<Device Management>

Specify the settings for managing the hardware and optional equipment.

- ▶<Device Information Settings>(P. 1332)
- ▶<Device Information Distribution Settings>(P. 1332)
- ▶<Limited Functions Mode>(P. 1335)
- ▶<Confirm Device Signature Certificate>(P. 1336)
- ▶<Confirm User Signature Certificate>(P. 1336)
- ▶<Certificate Settings>(P. 1336)
- ▶<Display Job Status Before Authentication>(P. 1339)
- ▶<Restrict Access to Other User Jobs>(P. 1339)
- ▶<Display Job Log>(P. 1340)
- ▶<Save Audit Log>(P. 1340)
- ▶<Retrieve Network Authentication Log>(P. 1341)
- ▶<Store Key Operation Log>(P. 1341)
- ▶<Restrict Service Representative Access>(P. 1341)
- ▶<Synchronize Custom Settings (Client)>(P. 1342)
- ▶<Synchronize Custom Settings (Server)>(P. 1342)
- ▶<Manage Personal Settings>(P. 1342)
- ▶<Prohibit Initialization of Administrator Password>(P. 1343)
- ▶<Restrict Special Mode Operations>(P. 1343)

NOTE

- For information on the items ("A", "B", "C", and "No") in the "Import All Function" column, see ▶<Import All Function>(P. 1054) .

Item marked with an asterisk (*)

- Only appears if you have the option installed. ▶<Checking the Options Installed on This Machine>(P. 1038)

<Device Information Settings>

 (Settings/Registration) ▶ <Management Settings> ▶ <Device Management>

Enter the name and the installation location to identify the machine.

Item	Setting Description	DeviceAdmin	NetworkAdmin	Can be set in Remote UI	Device Information Delivery Available	Import All Function	Name of Item When Exporting with the Remote UI
<Device Information Settings>	<Device Name>	No	No	Yes	No	A	Settings/Registration Basic Information
	<Location>	No	No	Yes	No	A	Settings/Registration Basic Information

<Device Information Distribution Settings>

 (Settings/Registration) ▶ <Management Settings> ▶ <Device Management>

Set the machine to send various machine settings (device information) over the network and automatically apply to other Canon multifunction printers. ▶<Distributing the Device Information to Other Canon Multifunction Printers>(P. 1005)

Settings/Registration

Item	Setting Description	DeviceAdmin	NetworkAdmin	Can be set in Remote UI	Device Information Delivery Available	Import All Function	Name of Item When Exporting with the Remote UI
<Transmitting Settings>							
<Register Destinations>	<Auto Search/Register>, <Register>, <Details>, <Delete>, <Print List>	No	No	No	No	B*1	Settings/Registration Basic Information
	<Auto Search/Register>: • <Search Depth (Router)>: 1 to 8	No	No	No	No	No	-
	• <Display Host Name>: <On>, <Off>	No	No	No	No	No	-
	• <Start Auto Search>	No	No	No	No	No	-
<Set Auto Distribution>	<Everyday> (1 to 5), <Specify Days> (<Sun> to <Sat>, 1 to 5), <Off>	No	No	No	No	B	Settings/Registration Basic Information
	<Settings/Registration Value>: <On>, <Off> • <Network Settings>: <Include>, <Exclude>	No	No	No	No	B	Settings/Registration Basic Information
	<Department ID>: <On>, <Off>	No	No	No	No	B	Settings/Registration Basic Information
	<Address Book>: <On>, <Off>	No	No	No	No	B	Settings/Registration Basic Information
	<Web Access Favorites>: <On>, <Off>	No	No	No	No	B	Settings/Registration Basic Information
	<Printer Settings>: <On>, <Off>	No	No	No	No	B	Settings/Registration Basic Information
	<Paper Information>: <On>, <Off>	No	No	No	No	B	Settings/Registration Basic Information
	<iW Function Flow>*2: <On>, <Off>	No	No	No	No	B	Settings/Registration Basic Information
<Manual Distribution>	<Settings/Registration Value>: <On>, <Off>	No	No	No	No	No	-

Settings/Registration

Item	Setting Description	DeviceAdmin	NetworkAdmin	Can be set in Remote UI	Device Information Delivery Available	Import All Function	Name of Item When Exporting with the Remote UI
	<ul style="list-style-type: none"> <Network Settings>: <Include>, <Exclude> 						
	<Department ID>: <On>, <Off>	No	No	No	No	No	-
	<Address Book>: <On>, <Off>	No	No	No	No	No	-
	<Web Access Favorites>: <On>, <Off>	No	No	No	No	No	-
	<Printer Settings>: <On>, <Off>	No	No	No	No	No	-
	<Paper Information>: <On>, <Off>	No	No	No	No	No	-
	<iW Function Flow>*2: <On>, <Off>	No	No	No	No	No	-
<Set MEAP Authentication>	<User Name>, <Password>, <Login Destination>	No	No	No	No	C	Settings/Registration Basic Information
<Receiving Settings>							
<Restrict Receiving Device Information>	<On>, <Off>	No	No	No	No	C	Settings/Registration Basic Information
<Restore Data>	<Settings/Regist. Value>, <Department ID>, <Address Book>, <Web Access Favorites>, <Printer Settings>, <Paper Information>	No	No	No	No	No	-
<Restrict Receiving for Each Function>	<Settings/Registration Value>: <On>, <Off>	No	No	No	No	C	Settings/Registration Basic Information
	<Department ID>: <On>, <Off>	No	No	No	No	C	Settings/Registration Basic Information
	<Address Book>: <On>, <Off>	No	No	No	No	C	Settings/Registration Basic Information
	<Web Access Favorites>: <On>, <Off>	No	No	No	No	C	Settings/Registration

Settings/Registration

Item	Setting Description	DeviceAdmin	NetworkAdmin	Can be set in Remote UI	Device Information Delivery Available	Import All Function	Name of Item When Exporting with the Remote UI
							Basic Information
	<Printer Settings>: <On>, <Off>	No	No	No	No	C	Settings/Registration Basic Information
	<Paper Information>: <On>, <Off>	No	No	No	No	C	Settings/Registration Basic Information
	<iW Function Flow>*2: <On>, <Off>	No	No	No	No	C	Settings/Registration Basic Information
<Set Paper Information>	<All>, <Basic Only>	No	No	No	No	C	Settings/Registration Basic Information
<Use MEAP Authentication When Receiving>	<On>, <Off>	No	No	No	No	C	Settings/Registration Basic Information
<Communication Log>	<Details>, <Print List>, <Report Settings>	No	No	No	No	No	-
	<Report Settings> <ul style="list-style-type: none"> • <Auto Print (100 Transmissions)>: <On>, <Off> 	No	No	No	No	C	Settings/Registration Basic Information
	<ul style="list-style-type: none"> • <Specify Print Time>: <On> (00:00 to 23:59), <Off> 	No	No	No	No	C	Settings/Registration Basic Information
	<ul style="list-style-type: none"> • <Separate Report Type>: <On>, <Off> 	No	No	No	No	C	Settings/Registration Basic Information

*1 Imports the registered distribution destination.

*2 Indicates items that appear only when the appropriate optional equipment is available for use.

<Limited Functions Mode>

 (Settings/Registration) ▶ <Management Settings> ▶ <Device Management>

Specify the settings used to restrict the use of optional equipment.

 <Limited Functions Mode>(P. 1344)

<Confirm Device Signature Certificate>

 (Settings/Registration) ▶ <Management Settings> ▶ <Device Management>

Check the detailed settings of a device signature certificate. You can also check whether the certificate is valid.

Item	Setting Description	DeviceAdmin	NetworkAdmin	Can be set in Remote UI	Device Information Delivery Available	Import All Function	Name of Item When Exporting with the Remote UI
<Confirm Device Signature Certificate>	<Version>, <Serial Number>, <Signature Algorithm>, <Issued To>, <Validity Start Date>, <Validity End Date>, <Issuer>, <Public Key>, <Certificate Thumbprint>, <Issued To (Altn. Name)>, <Verify Certificate>	Yes	Yes	Yes	No	No	-

<Confirm User Signature Certificate> *

 (Settings/Registration) ▶ <Management Settings> ▶ <Device Management>





Check the detailed settings of a user signature certificate available for the logged-in user. You can also check whether the certificate is valid.

Item	Setting Description	DeviceAdmin	NetworkAdmin	Can be set in Remote UI	Device Information Delivery Available	Import All Function	Name of Item When Exporting with the Remote UI
<Confirm User Signature Certificate>	<Version>, <Serial Number>, <Signature Algorithm>, <Issued To>, <Validity Start Date>, <Validity End Date>, <Issuer>, <Public Key>, <Certificate Thumbprint>, <Issued To (Altn. Name)>, <Verify Certificate>	Yes	Yes	Yes	No	No	-

<Certificate Settings>

 (Settings/Registration) ▶ <Management Settings> ▶ <Device Management>

You can manage the keys/certificates, CA certificates, or certification revocation list (CRL) used in the machine. You can also set the Online Certificate Status Protocol (OCSP).

-  **Generating the Key and Certificate for Network Communication(P. 867)**
-  **Generating a Device Signature Certificate(P. 896)**
-  **Registering a User Signature Certificate(P. 897)**
-  **Generating a Key and Certificate Signing Request (CSR)(P. 926)**
-  **Configuring the Expiration Check Method for Received Certificates(P. 924)**

Settings/Registration

Item	Setting Description	DeviceAdmin	NetworkAdmin	Can be set in Remote UI	Device Information Delivery Available	Import All Function	Name of Item When Exporting with the Remote UI
<Generate Key>							
<Generate Network Communication Key>	<Key Name>	Yes	Yes	Yes	No	No	-
	<Signature Algorithm>: <SHA256>, <SHA384>, <SHA512>	Yes	Yes	Yes	No	No	-
	<Key Algorithm>: <RSA>, <ECDSA>	Yes	Yes	Yes	No	No	-
	<ul style="list-style-type: none"> When <RSA> is selected: <Key Length (bit)>: <512>, <1024>, <2048>, <4096> 	Yes	Yes	Yes	No	No	-
	<ul style="list-style-type: none"> When <ECDSA> is selected <Key Type>: <P256>, <P384>, <P521> 	Yes	Yes	Yes	No	No	-
	<Validity Start Date>: Date, Month, Year (01/01/2000 - 31/12/2037)	Yes	Yes	Yes	No	No	-
	<Validity End Date>: Date, Month, Year (01/01/2000 - 31/12/2037)	Yes	Yes	Yes	No	No	-
	<Country/Region>: Country/Region name and code	Yes	Yes	Yes	No	No	-
	<State>	Yes	Yes	Yes	No	No	-
	<City>	Yes	Yes	Yes	No	No	-
	<Organization>	Yes	Yes	Yes	No	No	-
	<Organization Unit>	Yes	Yes	Yes	No	No	-
<Common Name> (IP address of the machine or FQDN (41 characters maximum))	Yes	Yes	Yes	No	No	-	
<Generate/Update Device Signature Key>	<Yes>, <No>	Yes	Yes	Yes	No	C	Key Settings
<Generate/Update Key for Access Control>	<Yes>, <No>	Yes	Yes	Yes	No	No	-
<Key and Certificate List>							

Settings/Registration

Item	Setting Description	DeviceAdmin	NetworkAdmin	Can be set in Remote UI	Device Information Delivery Available	Import All Function	Name of Item When Exporting with the Remote UI
<Key and Certificate List for Users>*1	<Certificate Details>: (<Version>, <Serial Number>, <Signature Algorithm>, <Issued To>, <Validity Start Date>, <Validity End Date>, <Issuer>, <Public Key>, <Certificate Thumbprint>, <Issued To (Altn. Name)>, <Verify Certificate>)	Yes	Yes	Yes	No	C*2*3	Certificate/ Certificate Revocation List (CRL) Settings
	<Delete>	Yes	Yes	Yes	No	No	-
<Key and Certificate List for This Device>*1	<Certificate Details>: (<Version>, <Serial Number>, <Signature Algorithm>, <Issued To>, <Validity Start Date>, <Validity End Date>, <Issuer>, <Public Key>, <Certificate Thumbprint>, <Issued To (Altn. Name)>, <Verify Certificate>)	Yes	Yes	Yes	No	C*2*3	Certificate/ Certificate Revocation List (CRL) Settings
	<Delete>	Yes	Yes	Yes	No	No	-
	<Display Use Location> (Key and Certificate)	Yes	Yes	Yes	No	C	Certificate/ Certificate Revocation List (CRL) Settings
<CA Certificate List>	<Certificate Details>: (<Version>, <Serial Number>, <Signature Algorithm>, <Issued To>, <Validity Start Date>, <Validity End Date>, <Issuer>, <Public Key>, <Certificate Thumbprint>, <Issued To (Altn. Name)>, <Verify Certificate>)	Yes	Yes	Yes	No	C*2	Certificate/ Certificate Revocation List (CRL) Settings
	<Delete>	Yes	Yes	Yes	No	No	-
<Certificate Revocation List (CRL)>	<CRL Details>: <Version>, <Signature Algorithm>, <Valid From>, <Next Update>, <Issuer>, <Serial No. List>	Yes	Yes	Yes	No	C*2	Certificate/ Certificate Revocation List (CRL) Settings
	<Delete>	Yes	Yes	Yes	No	No	-
<Register Key and Certificate>	<Register>	Yes	Yes	Yes	No	No	-
	<Delete>	Yes	Yes	Yes	No	No	-
<Register CA Certificate>	<Register>	Yes	Yes	Yes	No	No	-
	<Delete>	Yes	Yes	Yes	No	No	-

Settings/Registration

Item	Setting Description	DeviceAdmin	NetworkAdmin	Can be set in Remote UI	Device Information Delivery Available	Import All Function	Name of Item When Exporting with the Remote UI
<OCSP (Online Certificate Status Protocol) Settings>	<Use OCSP (Online Certificate Status Protocol)>: <On>, <Off> When <On> is selected: <ul style="list-style-type: none"> • <Certificate Verification Level>: <Enable Unverified Certificates>: <On>, <Off> • <OCSP Responder Settings>: <ul style="list-style-type: none"> • <URL>: <Retrieve from Certificate>, <Custom>, <Retrieve from Cert. + Custom> • <Custom URL> • <Communication Timeout>: 1 to 3 to 30 sec. 	Yes	Yes	Yes	No	C	Settings/Registration Basic Information

*1 Indicates items that appear only when the appropriate optional equipment is available for use.

*2 Supports only algorithms that can be imported from the Remote UI.

*3 Keys and certificates are exported in the PKCS#12 format.

<Display Job Status Before Authentication>

 (Settings/Registration) ▶ <Management Settings> ▶ <Device Management>

Select whether to restrict access to the <Status Monitor> screen when using a login service.

Item	Setting Description	DeviceAdmin	NetworkAdmin	Can be set in Remote UI	Device Information Delivery Available	Import All Function	Name of Item When Exporting with the Remote UI
<Display Job Status Before Authentication>	<On>, <Off>	No	No	Yes	No	C	Settings/Registration Basic Information

<Restrict Access to Other User Jobs>

 (Settings/Registration) ▶ <Management Settings> ▶ <Device Management>

Select whether to restrict users from performing operations on the jobs of other users on the <Status Monitor> screen when User Authentication is used.

Item	Setting Description	DeviceAdmin	NetworkAdmin	Can be set in Remote UI	Device Information Delivery Available	Import All Function	Name of Item When Exporting with the Remote UI
<Restrict Access to Other User Jobs>	<Copy/Print>: <On>, <Off> <Send>: <On>, <Off> <Receive>: <On>, <Off> <Store>: <On>, <Off>	No	No	Yes	No	C	Settings/Registration Basic Information

NOTE

- If you change <Login Screen Display Settings>(P. 1326) , this setting may be set to <On>. For more information, see <Specifying When to Display the Login Screen(P. 835) .

<Display Job Log>

(Settings/Registration) ► <Management Settings> ► <Device Management>

Select whether to display job logs on the <Status Monitor> screen. You can also select whether to allow device management software to retrieve job logs from the machine. <Basic Screens on the Touch Panel Display(P. 332)>

Item	Setting Description	DeviceAdmin	NetworkAdmin	Can be set in Remote UI	Device Information Delivery Available	Import All Function	Name of Item When Exporting with the Remote UI
<Display Job Log>	<On>, <Off>	No	No	Yes	No	C	Settings/Registration Basic Information
	When <Off> is selected: <ul style="list-style-type: none"> <Retrieve Job Log with Management Software>: <Allow>, <Do Not Allow> 	No	No	Yes	No	C	Settings/Registration Basic Information

<Save Audit Log>

(Settings/Registration) ► <Management Settings> ► <Device Management>

Select whether to start log recording. <Starting Log Recording(P. 941)>

Item	Setting Description	DeviceAdmin	NetworkAdmin	Can be set in Remote UI	Device Information Delivery Available	Import All Function	Name of Item When Exporting with the Remote UI
<Save Audit Log>	<On>, <Off>	No	No	Yes	No	C	Settings/Registration Basic Information

IMPORTANT

- If this is set to <On>, the  <Adjust Time>(P. 1072) setting cannot be used.

NOTE

- For information on the types of logs, see  <System Specifications>(P. 1577) .

<Retrieve Network Authentication Log>

 (Settings/Registration) ▶ <Management Settings> ▶ <Device Management>

Select whether to start log recording for authentication performed when the machine is accessed via the network, such as when printing from a computer or accessing the Advanced Space.

Item	Setting Description	DeviceAdmin	NetworkAdmin	Can be set in Remote UI	Device Information Delivery Available	Import All Function	Name of Item When Exporting with the Remote UI
<Retrieve Network Authentication Log>	<On>, <Off>	No	No	Yes	No	C	Settings/Registration Basic Information

<Store Key Operation Log>

 (Settings/Registration) ▶ <Management Settings> ▶ <Device Management>

Select whether to save a log of the key operations performed by users. By analyzing the stored logs, you can survey how the machine is being used.

Item	Setting Description	DeviceAdmin	NetworkAdmin	Can be set in Remote UI	Device Information Delivery Available	Import All Function	Name of Item When Exporting with the Remote UI
<Store Key Operation Log>	<On>, <Off>	No	No	Yes	No	C	Settings/Registration Basic Information

NOTE

- When the log is output, PINs, passwords, and information obfuscated by the settings for <Restrict Access to Other User Jobs>, etc., are output as masked characters. Therefore, confidential information cannot be leaked externally.
- For information on interpreting and outputting saved logs, contact your dealer or service representative.

<Restrict Service Representative Access>

 (Settings/Registration) ▶ <Management Settings> ▶ <Device Management>

You can set the machine to restrict changes in user information or security-related settings when the machine is inspected or repaired by your dealer or service representative.

Item	Setting Description	DeviceAdmin	NetworkAdmin	Can be set in Remote UI	Device Information Delivery Available	Import All Function	Name of Item When Exporting with the Remote UI
<Restrict Service Representative Access>	<On>, <Off (Auth. Needed)>, <Off>	No	No	Yes	No	C	Settings/Registration Basic Information

NOTE

- Even when this is not set to <On>, you can check the audit log for past operations if the service representative has changed user information or security-related settings.

<Synchronize Custom Settings (Client)>

 (Settings/Registration) ▶ <Management Settings> ▶ <Device Management>

You can synchronize the personalized data of multiple Canon multifunction printers on a network. Even for the server machine, it is necessary to enable this setting if you wish to operate the machine as the client machine.  **Starting Setting Synchronization(P. 991)**

Item	Setting Description	DeviceAdmin	NetworkAdmin	Can be set in Remote UI	Device Information Delivery Available	Import All Function	Name of Item When Exporting with the Remote UI
<Synchronize Custom Settings (Client)>	Before synchronizing: <Enable>, <Pause> After synchronizing: <Disable>, <Resume>	No	No	Yes	No	No	-

<Synchronize Custom Settings (Server)>

 (Settings/Registration) ▶ <Management Settings> ▶ <Device Management>

You can synchronize the personalized data of multiple Canon multifunction printers on a network. However, it is also necessary to enable this setting in a single machine to function as the server for the multifunction printers performing synchronization.  **Starting Setting Synchronization(P. 991)**

Item	Setting Description	DeviceAdmin	NetworkAdmin	Can be set in Remote UI	Device Information Delivery Available	Import All Function	Name of Item When Exporting with the Remote UI
<Synchronize Custom Settings (Server)>	Before synchronizing: <Enable> After synchronizing: <Disable>	No	No	Yes	No	A	Settings/Registration Basic Information

<Manage Personal Settings>

 (Settings/Registration) ▶ <Management Settings> ▶ <Device Management>

Specify the preferences (Personal Settings) for each user.

 <Manage Personal Settings>(P. 1346)

<Prohibit Initialization of Administrator Password>

 (Settings/Registration) ▶ <Management Settings> ▶ <Device Management>

Specify whether to restrict operations of <Initialize Admin. Password>.

Item	Setting Description	DeviceAdmin	NetworkAdmin	Can be set in Remote UI	Device Information Delivery Available	Import All Function	Name of Item When Exporting with the Remote UI
<Prohibit Initialization of Administrator Password>	<On>, <Off>	No	No	No	No	No	-

NOTE

- For information on using <Initialize Admin. Password>, see  **Logging in as an Administrator(P. 259)** .

<Restrict Special Mode Operations>

 (Settings/Registration) ▶ <Management Settings> ▶ <Device Management>

Select whether to restrict use of Special Mode, which is provided for the purpose of maintenance by service representatives.

Item	Setting Description	DeviceAdmin	NetworkAdmin	Can be set in Remote UI	Device Information Delivery Available	Import All Function	Name of Item When Exporting with the Remote UI
<Restrict Special Mode Operations>	<On>, <Off>	No	No	No	No	No	-

<Limited Functions Mode>

Specify the settings used to restrict the use of optional equipment.

- ▶<Finisher Tray A>(P. 1344)
- ▶<Finisher Tray A/B>(P. 1344)
- ▶<Finisher Saddle Stitch Unit>(P. 1344)
- ▶<Finisher Puncher>(P. 1345)

NOTE

- For information on the items ("A", "B", "C", and "No") in the "Import All Function" column, see ▶<Import All Function>(P. 1054) .

<Finisher Tray A>

 (Settings/Registration) ▶ <Management Settings> ▶ <Device Management> ▶ <Limited Functions Mode>

Select whether to disable Output Tray A of the finisher.

Item	Setting Description	DeviceAdmin	NetworkAdmin	Can be set in Remote UI	Device Information Delivery Available	Import All Function	Name of Item When Exporting with the Remote UI
<Finisher Tray A>	<On>, <Off>	Yes	No	No	No	No	-

<Finisher Tray A/B>

 (Settings/Registration) ▶ <Management Settings> ▶ <Device Management> ▶ <Limited Functions Mode>

Select whether to disable Output Tray A/B of the finisher.

Item	Setting Description	DeviceAdmin	NetworkAdmin	Can be set in Remote UI	Device Information Delivery Available	Import All Function	Name of Item When Exporting with the Remote UI
<Finisher Tray A/B>	<On>, <Off>	Yes	No	No	No	No	-

<Finisher Saddle Stitch Unit>

 (Settings/Registration) ▶ <Management Settings> ▶ <Device Management> ▶ <Limited Functions Mode>

Select whether to disable the saddle stitcher unit of the finisher.

Item	Setting Description	DeviceAdmin	NetworkAdmin	Can be set in Remote UI	Device Information Delivery Available	Import All Function	Name of Item When Exporting with the Remote UI
<Finisher Saddle Stitch Unit>	<On>, <Off>	Yes	No	No	No	No	-

<Finisher Puncher>

 (Settings/Registration) ▶ <Management Settings> ▶ <Device Management> ▶ <Limited Functions Mode>

Select whether to disable the puncher unit that is installed in the finisher.

Item	Setting Description	DeviceAdmin	NetworkAdmin	Can be set in Remote UI	Device Information Delivery Available	Import All Function	Name of Item When Exporting with the Remote UI
<Finisher Puncher>	<On>, <Off>	Yes	No	No	No	No	-

<Manage Personal Settings>

Specify the preferences (Personal Settings) for each user.

- ▶<Enable Use of Personal Settings>(P. 1346)
- ▶<Action When Maximum Number of Users Exceeded>(P. 1346)
- ▶<Use Default Screen After Startup/Restoration>(P. 1347)
- ▶<Home Management Settings for Personal Use>(P. 1347)

NOTE

- For information on the items ("A", "B", "C", and "No") in the "Import All Function" column, see ▶<Import All Function>(P. 1054) .

<Enable Use of Personal Settings>

 (Settings/Registration) ▶ <Management Settings> ▶ <Device Management> ▶ <Manage Personal Settings>

Select whether to enable users that are logged into the machine to use the Personalization function, such as the display language, accessibility settings, and the screen to display after startup/restoration.

Item	Setting Description	DeviceAdmin	NetworkAdmin	Can be set in Remote UI	Device Information Delivery Available	Import All Function	Name of Item When Exporting with the Remote UI
<Enable Use of Personal Settings>	<On>, <Off>	No	No	No	No	C	Settings/Registration Basic Information

<Action When Maximum Number of Users Exceeded>

 (Settings/Registration) ▶ <Management Settings> ▶ <Device Management> ▶ <Manage Personal Settings>

Select how the machine processes personal settings for users or groups (user setting information) when the number for which the machine can save various settings exceeds the limit.

Item	Setting Description	DeviceAdmin	NetworkAdmin	Can be set in Remote UI	Device Information Delivery Available	Import All Function	Name of Item When Exporting with the Remote UI
<Action When Maximum Number of Users Exceeded>	<Delete Oldest User Settings>, <Discard New User Settings>	No	No	No	No	C	Settings/Registration Basic Information

NOTE

- For information on the data deleted when <Delete Oldest User Settings> is specified, see ▶<List of Items That Can Be Personalized>(P. 357) .
- To completely erase data manually instead of deleting it automatically, follow the procedure described in ▶<Deleting User Setting Information>(P. 850) .

- For information on the limit of user or group personal settings (user setting information) that the machine can save, see **System Specifications(P. 1577)** .

<Use Default Screen After Startup/Restoration>

 (Settings/Registration) ▶ <Management Settings> ▶ <Device Management> ▶ <Manage Personal Settings>

Select whether to enable each user to set the screen displayed on startup/restoration.

Item	Setting Description	DeviceAdmin	NetworkAdmin	Can be set in Remote UI	Device Information Delivery Available	Import All Function	Name of Item When Exporting with the Remote UI
<Use Default Screen After Startup/Restoration>	<On>, <Off>	No	No	No	No	C	Settings/Registration Basic Information

<Home Management Settings for Personal Use>

 (Settings/Registration) ▶ <Management Settings> ▶ <Device Management> ▶ <Manage Personal Settings>

Specify whether Personal buttons can be registered and edited in the <Home> screen.

Item	Setting Description	DeviceAdmin	NetworkAdmin	Can be set in Remote UI	Device Information Delivery Available	Import All Function	Name of Item When Exporting with the Remote UI
<Home Management Settings for Personal Use>	<Allow Registration/Editing of Personal Buttons>: <On>, <Off> <Allow Use of Move Buttons When Customizing for Personal Use>: <On>, <Off> <Allow Use of Home Screen Layout Settings When Customizing for Personal Use>: <On>, <Off> <Allow Use of Wallpaper Settings When Customizing for Personal Use>: <On>, <Off>	No	No	No	No	C	Settings/Registration Basic Information

<License/Other>

Specify the settings for registering licenses and for the software that can be used on the machine.

- ▶<Register License>(P. 1348)
- ▶<MEAP Settings>(P. 1348)
- ▶<Remote UI>(P. 1348)
- ▶<Delete Message Board Contents>(P. 1349)
- ▶<Visual Message Settings>(P. 1349)
- ▶<Remote Operation Settings>(P. 1350)
- ▶<Use ACCESS MANAGEMENT SYSTEM>(P. 1351)
- ▶<Register/Update Software>(P. 1351)
- ▶<Start Setup Guide>(P. 1351)
- ▶<Allow Use of Print Function from Mobile>(P. 1352)
- ▶<Allow Jobs to Be Performed from Mobile Device>(P. 1352)

NOTE

- For information on the items ("A", "B", "C", and "No") in the "Import All Function" column, see ▶<Import All Function>(P. 1054) .

<Register License>

 (Settings/Registration) ▶ <Management Settings> ▶ <License/Other>

Enter the license key for a system option that can be used on the machine. ▶<Installing System Options>(P. 986)

Item	Setting Description	DeviceAdmin	NetworkAdmin	Can be set in Remote UI	Device Information Delivery Available	Import All Function	Name of Item When Exporting with the Remote UI
<Register License>	24 characters maximum	No	No	No	No	No	-

<MEAP Settings>

 (Settings/Registration) ▶ <Management Settings> ▶ <License/Other>

Specify the MEAP settings.

- ▶<MEAP Settings>(P. 1353)

<Remote UI>

 (Settings/Registration) ▶ <Management Settings> ▶ <License/Other>

Select whether to use the Remote UI to operate the machine and change settings.

Item	Setting Description	DeviceAdmin	NetworkAdmin	Can be set in Remote UI	Device Information Delivery Available	Import All Function	Name of Item When Exporting with the Remote UI
<Remote UI>	<On>, <Off>	No	No	No	Yes	C	Settings/Registration Basic Information
	When <On> is selected: <ul style="list-style-type: none"> <Use TLS>: <On>, <Off> 	No	No	Yes	No	C	Settings/Registration Basic Information

<Delete Message Board Contents>

 (Settings/Registration) ▶ <Management Settings> ▶ <License/Other>

Select to delete messages from the administrator that are displayed on the control panel.

Item	Setting Description	DeviceAdmin	NetworkAdmin	Can be set in Remote UI	Device Information Delivery Available	Import All Function	Name of Item When Exporting with the Remote UI
<Delete Message Board Contents>	<Yes>, <No>	No	No	No	No	No	-

IMPORTANT

- When <OK> is displayed on a message board, press <OK> to operate the machine. To clear a message board without <OK> displayed, you need to use the Remote UI.

<Visual Message Settings>

 (Settings/Registration) ▶ <Management Settings> ▶ <License/Other>

Specify the Visual Message settings.  **Configuring the Visual Message Function(P. 979)**

Item	Setting Description	DeviceAdmin	NetworkAdmin	Can be set in Remote UI	Device Information Delivery Available	Import All Function	Name of Item When Exporting with the Remote UI
<Display Settings>	<Display Timing and Content> <ul style="list-style-type: none"> Display timing: <Display After Logout/Auto Reset>, <Display After Login>, <Display When Print Job Starts> Content: <SMB>, <HTTP/WebDAV> When <SMB> is selected: <ul style="list-style-type: none"> <File Path:> <User Name:> 	No	No	Yes	No	C	Visual Message Settings

Item	Setting Description	DeviceAdmin	NetworkAdmin	Can be set in Remote UI	Device Information Delivery Available	Import All Function	Name of Item When Exporting with the Remote UI
	<Password:> When <HTTP/WebDAV> is selected: <File Path:> <User Name:> <Password:> <Confirm Certificate for TLS Communication>: On, Off <Add CN to Verification Items>: On, Off						
	<Content to Display When an Error Occurs>: <Display an error message, but do not display Visual Message content> , <Do not display an error message or Visual Message content>	No	No	Yes	No	C	Visual Message Settings
<Proxy Settings>	<Address Without Using Proxy>	No	No	Yes	No	C	Visual Message Settings

NOTE

- This setting can only be specified from the Remote UI.

<Remote Operation Settings>

 (Settings/Registration) ▶ <Management Settings> ▶ <License/Other>

Select whether to enable the Remote Operation function. This function enables you to specify settings and process jobs from a computer by displaying the screen of the touch panel display on the computer screen.

Item	Setting Description	DeviceAdmin	NetworkAdmin	Can be set in Remote UI	Device Information Delivery Available	Import All Function	Name of Item When Exporting with the Remote UI
<Remote Operation Settings>	<On>, <Off>	No	No	Yes	No	C	Settings/Registration Basic Information
	When <On> is selected: <ul style="list-style-type: none"> <Password>: 8 characters maximum (Only alphanumeric characters) 	No	No	Yes	No	C	Settings/Registration Basic Information

NOTE

- When remote operation is performed, the following settings cannot be changed or executed.
 - <Time Until File Auto Delete> in <Set/Register Mail Boxes>(P. 1288)
 - <Initialize> in <Set/Register Mail Boxes>(P. 1288)
 - <Time Until File Auto Delete>(P. 1290)
 - <Job Storage Period>(P. 1301)

<Use ACCESS MANAGEMENT SYSTEM>

(Settings/Registration) ▶ <Management Settings> ▶ <License/Other>

Select whether to use ACCESS MANAGEMENT SYSTEM. **Using ACCESS MANAGEMENT SYSTEM(P. 849)**

Item	Setting Description	DeviceAdmin	NetworkAdmin	Can be set in Remote UI	Device Information Delivery Available	Import All Function	Name of Item When Exporting with the Remote UI
<Use ACCESS MANAGEMENT SYSTEM>	<On>, <Off>	No	No	Yes	No	C	Settings/Registration Basic Information

<Register/Update Software>

(Settings/Registration) ▶ <Management Settings> ▶ <License/Other>

You can install system options/MEAP applications in the machine. **Installing System Options(P. 986)**

Item	Setting Description	DeviceAdmin	NetworkAdmin	Can be set in Remote UI	Device Information Delivery Available	Import All Function	Name of Item When Exporting with the Remote UI
<Register/Update Software>	<Install Applications/Options>, <Update Firmware>, <Software Management Settings>, <Scheduled Update>	No	No	Yes	No	No	-

<Start Setup Guide>

(Settings/Registration) ▶ <Management Settings> ▶ <License/Other>

You can follow the wizard instructions to configure the machine's initial settings. **Setting up Using the Setup Guide(P. 250)**

Item	Setting Description	DeviceAdmin	NetworkAdmin	Can be set in Remote UI	Device Information Delivery Available	Import All Function	Name of Item When Exporting with the Remote UI
<Start Setup Guide>	<Start>	No	No	No	No	No	-

<Allow Use of Print Function from Mobile>

 (Settings/Registration) ▶ <Management Settings> ▶ <License/Other>

If this setting is set to <On>, you can perform operations from a mobile device for documents stored in <Print>.

Item	Setting Description	DeviceAdmin	NetworkAdmin	Can be set in Remote UI	Device Information Delivery Available	Import All Function	Name of Item When Exporting with the Remote UI
<Allow Use of Print Function from Mobile>	<On>, <Off>	No	No	No	No	C*1	Settings/Registration Basic Information

*1 Only for machines that support the Hold function.

<Allow Jobs to Be Performed from Mobile Device>

 (Settings/Registration) ▶ <Management Settings> ▶ <License/Other>

Specifying <On> in this setting enables you to copy and scan, send e-mail and operate faxes from a mobile device.

NOTE

- If this is set to <On> to enable the mobile authentication function.  appears in the login screen.
- If <Authenticate with PIN Code for Scan Jobs> is set to <On>, the PIN shown on this machine must be entered when jobs are executed.

Item	Setting Description	DeviceAdmin	NetworkAdmin	Can be set in Remote UI	Device Information Delivery Available	Import All Function	Name of Item When Exporting with the Remote UI
<Allow Jobs to Be Performed from Mobile Device>	<On>, <Off> When <On> is selected: <ul style="list-style-type: none"> • <Authenticate with PIN Code for Scan Jobs>: <On>, <Off> 	Yes	Yes	No	No	C	Settings/Registration Basic Information

<MEAP Settings>

Specify the MEAP settings.

- ▶<Print System Information>(P. 1353)
- ▶<Use TLS>(P. 1353)
- ▶<Confirm TLS Certificate Using MEAP Application>(P. 1354)
- ▶<Use DNS Caching>(P. 1354)
- ▶<Use Proxy Settings of This Device>(P. 1354)
- ▶<Add X-FRAME-OPTIONS to HTTP Header>(P. 1355)

NOTE

- For information on the items ("A", "B", "C", and "No") in the "Import All Function" column, see ▶<Import All Function>(P. 1054) .

<Print System Information>

 (Settings/Registration) ▶ <Management Settings> ▶ <License/Other> ▶ <MEAP Settings>

You can print information for MEAP applications and certain system applications as a report. ▶<Printing a List of Settings>(P. 1034)

Item	Setting Description	DeviceAdmin	NetworkAdmin	Can be set in Remote UI	Device Information Delivery Available	Import All Function	Name of Item When Exporting with the Remote UI
<Print System Information>	<Yes>, <No>	No	No	No	No	No	-

<Use TLS>

 (Settings/Registration) ▶ <Management Settings> ▶ <License/Other> ▶ <MEAP Settings>

Select whether to use TLS communication when a MEAP application is used by accessing the machine via a Web browser.

Item	Setting Description	DeviceAdmin	NetworkAdmin	Can be set in Remote UI	Device Information Delivery Available	Import All Function	Name of Item When Exporting with the Remote UI
<Use TLS>	<On>, <Off>	No	No	Yes	No	C	Settings/Registration Basic Information

NOTE

- You need to configure the key and certificate before setting this setting to <On>. ▶<Configuring the Key and Certificate for TLS>(P. 864)
- Changes made for this setting are also applied to <Use TLS> in ▶<Remote UI>(P. 1348) .

<Confirm TLS Certificate Using MEAP Application>

 (Settings/Registration) ▶ <Management Settings> ▶ <License/Other> ▶ <MEAP Settings>

Select whether to verify TLS server certificates and their common names (CN) when TLS communication is used for a MEAP application.

Item	Setting Description	DeviceAdmin	NetworkAdmin	Can be set in Remote UI	Device Information Delivery Available	Import All Function	Name of Item When Exporting with the Remote UI
<Confirm TLS Certificate Using MEAP Application>	<On>, <Off> When <On> is selected: <ul style="list-style-type: none"> <Add Items to Verify>: <CN>: On, Off 	No	No	Yes	No	C	Settings/ Registration Basic Information

<Use DNS Caching>

 (Settings/Registration) ▶ <Management Settings> ▶ <License/Other> ▶ <MEAP Settings>

Select whether to save DNS information from successful searches via a MEAP application to memory. You can also set an expiration date if you choose to save information temporarily.

Item	Setting Description	DeviceAdmin	NetworkAdmin	Can be set in Remote UI	Device Information Delivery Available	Import All Function	Name of Item When Exporting with the Remote UI
<Use DNS Caching>	<On (Unlimited Use)>, <On (Specify Period)>, <Off> When <On (Specify Period)> is selected: <ul style="list-style-type: none"> <Period of Validity>: 1 to 60 to 120 sec. 	No	No	Yes	No	C	Settings/ Registration Basic Information

<Use Proxy Settings of This Device>

 (Settings/Registration) ▶ <Management Settings> ▶ <License/Other> ▶ <MEAP Settings>

Select whether to use the proxy settings of the machine with MEAP applications.  [Setting a Proxy\(P. 862\)](#)

Item	Setting Description	DeviceAdmin	NetworkAdmin	Can be set in Remote UI	Device Information Delivery Available	Import All Function	Name of Item When Exporting with the Remote UI
<Use Proxy Settings of This Device>	<On>, <Off>	No	No	Yes	No	C	Settings/Registration Basic Information

<Add X-FRAME-OPTIONS to HTTP Header>

 (Settings/Registration) ▶ <Management Settings> ▶ <License/Other> ▶ <MEAP Settings>

When the HTTP server returns a response, it appends X-FRAME-OPTIONS to the header to prevent contents created by other servers from overlapping.

Item	Setting Description	DeviceAdmin	NetworkAdmin	Can be set in Remote UI	Device Information Delivery Available	Import All Function	Name of Item When Exporting with the Remote UI
<Add X-FRAME-OPTIONS to HTTP Header>	<On>, <Off>	No	No	Yes	No	C	Settings/Registration Basic Information

<Data Management>

Specify the data management settings, including how to import, export, and initialize settings data.

 <Import/Export>(P. 1356)

 <Initialize All Data/Settings>(P. 1356)

 <TPM Settings>(P. 1356)

NOTE

- For information on the items ("A", "B", "C", and "No") in the "Import All Function" column, see  **Import All Function(P. 1054)** .

<Import/Export>

 (Settings/Registration) ▶ <Management Settings> ▶ <Data Management>

Specify the settings for importing/exporting settings data.

 <Import/Export>(P. 1358)

<Initialize All Data/Settings>

 (Settings/Registration) ▶ <Management Settings> ▶ <Data Management>

Select to restore all of the machine settings to the factory default values and completely erase the data stored in the machine. It is not normally necessary to use this setting, but it is useful to erase personal or confidential information when disposing of the machine.  **Initializing All Data/Settings(P. 1016)**

Item	Setting Description	DeviceAdmin	NetworkAdmin	Can be set in Remote UI	Device Information Delivery Available	Import All Function	Name of Item When Exporting with the Remote UI
<Initialize All Data/Settings>	<Yes>, <No>	No	No	No	No	No	-

<TPM Settings>

 (Settings/Registration) ▶ <Management Settings> ▶ <Data Management>

If the TPM setting is activated, you can safely store in the TPM chip encryption key (TPM key) that encrypts confidential information such as the password, public key pair for TLS communication, and user certificate stored in the machine. Doing so, you can prevent important information for the machine from leaking. Also, you can recover the system if the TPM chip fails by restoring the TPM key.  **Using TPM(P. 1018)**

Item	Setting Description	DeviceAdmin	NetworkAdmin	Can be set in Remote UI	Device Information Delivery Available	Import All Function	Name of Item When Exporting with the Remote UI
<TPM Settings>	<Use TPM>: <On>, <Off>	No	No	No	No	C*1	Settings/Registration Basic Information

Settings/Registration

Item	Setting Description	DeviceAdmin	NetworkAdmin	Can be set in Remote UI	Device Information Delivery Available	Import All Function	Name of Item When Exporting with the Remote UI
	<Back Up TPM Key> • <Password>: (12 characters maximum) <Restore TPM Key>	No	No	No	No	No	-

*1 If <TPM Settings> is set to <On>, make sure to back up the TPM key in the import destination machine.

<Import/Export>

Specify the settings for importing/exporting settings data.

- ▶<Import from USB Memory>(P. 1358)
- ▶<Export to USB Memory>(P. 1358)
- ▶<Import Result Report>(P. 1359)
- ▶<Restrict Import/Export from Web Service>(P. 1359)

NOTE

- For information on the items ("A", "B", "C", and "No") in the "Import All Function" column, see ▶<Import All Function>(P. 1054) .

<Import from USB Memory>

 (Settings/Registration) ▶ <Management Settings> ▶ <Data Management> ▶ <Import/Export>

You can import all the settings information from a USB memory device.

Item	Setting Description	DeviceAdmin	NetworkAdmin	Can be set in Remote UI	Device Information Delivery Available	Import All Function	Name of Item When Exporting with the Remote UI
<Import from USB Memory>	<Store Import Result in Device>: <On>, <Off> <Store Import Result in USB>: <On>, <Off> <Decryption Password>	No	No	No	No	No	-

NOTE

- If USB memory is already connected to the machine, that USB memory will be recognized as the media to use for importing, even if you connect new USB memory. Press  ▶ remove the connected USB memory ▶ insert the desired USB memory.

<Export to USB Memory>

 (Settings/Registration) ▶ <Management Settings> ▶ <Data Management> ▶ <Import/Export>

You can export all the settings information into a USB memory device.

Item	Setting Description	DeviceAdmin	NetworkAdmin	Can be set in Remote UI	Device Information Delivery Available	Import All Function	Name of Item When Exporting with the Remote UI
<Export to USB Memory>	<Encryption Password>	No	No	No	No	No	-

NOTE

- You cannot select which settings to export when exporting to USB memory. All settings are batch exported.
- If USB memory is already connected to the machine, that USB memory will be recognized as the media to use for exporting, even if you connect new USB memory. Press  remove the connected USB memory ► insert the desired USB memory.

<Import Result Report>

 (Settings/Registration) ► <Management Settings> ► <Data Management> ► <Import/Export>

Select to print a report of import results.

Item	Setting Description	DeviceAdmin	NetworkAdmin	Can be set in Remote UI	Device Information Delivery Available	Import All Function	Name of Item When Exporting with the Remote UI
<Import Result Report>	<Yes>, <No>	No	No	No	No	No	-

NOTE

- Reports are printed in the following language.
 - If the display language of the machine is set to Japanese immediately after the import process: Japanese
 - If the display language of the machine is set to something other than Japanese immediately after the import process: English

<Restrict Import/Export from Web Service>

 (Settings/Registration) ► <Management Settings> ► <Data Management> ► <Import/Export>

Select whether to restrict import and export operations with Web applications other than the Remote UI.

Item	Setting Description	DeviceAdmin	NetworkAdmin	Can be set in Remote UI	Device Information Delivery Available	Import All Function	Name of Item When Exporting with the Remote UI
<Restrict Import/Export from Web Service>	<On>, <Off>	No	No	Yes	No	C	Settings/Registration Basic Information

<Security Settings>

Specify the settings for enhancing the machine's security.

- ▶<Authentication/Password Settings>(P. 1360)
- ▶<Encryption Settings>(P. 1360)
- ▶<System Verification Settings>(P. 1360)
- ▶<Recommended Security Set. for Usage Environment>(P. 1361)

<Authentication/Password Settings>

 (Settings/Registration) ▶ <Management Settings> ▶ <Security Settings>

Specify the settings for enhancing the effective security of the password and the authentication function.

- ▶<Authentication/Password Settings>(P. 1363)

<Encryption Settings>

 (Settings/Registration) ▶ <Management Settings> ▶ <Security Settings>

Specify the settings for enhancing the effective encryption security.

- ▶<Encryption Settings>(P. 1371)

<System Verification Settings>

 (Settings/Registration) ▶ <Management Settings> ▶ <Security Settings>

Specify whether to use the system verification and protection functions.

- <Verify System at Startup>: Verifies the integrity of the firmware and MEAP applications when the machine starts up.
- <McAfee Embedded Control>: Improves system reliability while the machine is running by using the McAfee Embedded Control to prevent unauthorized program modification or execution. This is only available when <Verify System at Startup> is <On>.

Item	Setting Description	DeviceAdmin	NetworkAdmin	Can be set in Remote UI	Device Information Delivery Available	Import All Function	Name of Item When Exporting with the Remote UI
<System Verification Settings>	<Verify System at Startup>: <On>, <Off>	No	No	Yes	No	C	Settings/Registration Basic Information
	<McAfee Embedded Control>: <On>, <Off>	No	No	Yes	No	C	Settings/Registration Basic Information

IMPORTANT

- With <Verify System at Startup>, the machine is restarted when you change the setting from <Off> ► <On> or when you press <OK> without changing the setting from <On>. To maintain the <On> setting without restarting the machine, press <No> in the confirmation screen, and then press <Cancel> in the <System Verification Settings> screen.

NOTE

When <Verify System at Startup> is set to <On>

- Startup takes longer than when it is set to <Off> because system verification is performed.
- The following events and results are recorded to the device management log.  **Managing the Logs(P. 941)**

Event	Firmware verification, MEAP application verification
Result	Success, Failure

- If an error code appears on the screen when you switch the machine on, contact your dealer or service representative.

When <McAfee Embedded Control> is set to <On>

- The machine takes several minutes to restart after you specify this setting for the first time.
- <System Verif. Mntr.> appears in the <Home> screen, and you can use this to check the log entries for unauthorized operation, etc.

<Recommended Security Set. for Usage Environment>

 (Settings/Registration) ► <Management Settings> ► <Security Settings>

You can now specify all the recommended security settings for your usage environment simply by selecting the machine's environment type. See "Security Settings Navigator" for the available environment types. **Security Settings Navigator**

IMPORTANT:

- If any of the machine's security policy settings have been specified, <Recommended Security Set. for Usage Environment> cannot be used.

Item	Setting Description	DeviceAdmin	NetworkAdmin	Can be set in Remote UI	Device Information Delivery Available	Import All Function	Name of Item When Exporting with the Remote UI
<Recommended Security Set. for Usage Environment>	<1. Intranet And Internet Connection> <2. Direct Internet Connection> <3. Internet Connection Prohibited> <4. Private (Home) Network> <5. Public Network> <6. Highly Confidential Info. Environment> <Clear>	Yes	Yes	Yes	No	C	Visual Message Settings

NOTE

- If you change the machine to the recommended security settings for each type, functions you want to use may become unavailable or other problems may occur. In this case, you can undo the changes and restore the previous security settings. If you manually changed settings that were changed with <Recommended Security Set. for Usage Environment>, the changes are not retained. The machine returns to the state before executing <Recommended Security Set. for Usage Environment>.

<Authentication/Password Settings>

961F-0UJ

Specify the settings for enhancing the effective security of the password and the authentication function.

 <Authentication Function Settings>(P. 1363)

 <Password Settings>(P. 1363)

<Authentication Function Settings>

 (Settings/Registration) ▶ <Management Settings> ▶ <Security Settings> ▶ <Authentication/Password Settings>

Specify the settings for enhancing the effective security of the authentication function.

 <Authentication Function Settings>(P. 1364)

<Password Settings>

 (Settings/Registration) ▶ <Management Settings> ▶ <Security Settings> ▶ <Authentication/Password Settings>

Specify the settings for enhancing the effective security of the password.

 <Password Settings>(P. 1366)

<Authentication Function Settings>

Specify the settings for enhancing the effective security of the authentication function.

▶<Prohibit Authentication Using Department ID and PIN>(P. 1364)

▶<Lockout Settings>(P. 1364)

NOTE

- For information on the items ("A", "B", "C", and "No") in the "Import All Function" column, see ▶<Import All Function(P. 1054) .

<Prohibit Authentication Using Department ID and PIN>

 (Settings/Registration) ▶ <Management Settings> ▶ <Security Settings> ▶ <Authentication/Password Settings> ▶ <Authentication Function Settings>

Select whether to prohibit authentication with a Department ID and PIN when operating from the printer/scanner. If <On> is selected, authentication with System Manager ID and PIN is also prohibited when operating from a device management software.

Item	Setting Description	DeviceAdmin	NetworkAdmin	Can be set in Remote UI	Device Information Delivery Available	Import All Function	Name of Item When Exporting with the Remote UI
<Prohibit Authentication Using Department ID and PIN>	<On>, <Off>	Yes	Yes	Yes	No	C	Settings/Registration Basic Information

IMPORTANT

- Jobs that are restricted by this setting are forcibly canceled on the machine.

<Lockout Settings>

 (Settings/Registration) ▶ <Management Settings> ▶ <Security Settings> ▶ <Authentication/Password Settings> ▶ <Authentication Function Settings>

Select whether to block users from logging in for a specified period of time after a certain number of consecutive invalid login attempts. This setting does not apply to authentication with a Department ID or PIN, or authentication for the Mail Box.

Item	Setting Description	DeviceAdmin	NetworkAdmin	Can be set in Remote UI	Device Information Delivery Available	Import All Function	Name of Item When Exporting with the Remote UI
<Lockout Settings>	<Enable Lockout>: <On>, <Off>	No	No	Yes	No	C	Settings/Registration Basic Information
	When <On> is selected: <ul style="list-style-type: none"> <Lockout Threshold>: 1 to 10 times 	No	No	Yes	No	C	Settings/Registration Basic Information

Settings/Registration

Item	Setting Description	DeviceAdmin	NetworkAdmin	Can be set in Remote UI	Device Information Delivery Available	Import All Function	Name of Item When Exporting with the Remote UI
	<ul style="list-style-type: none"> • <Lockout Period>: 1 to 60 min. 						

NOTE

- Users may be blocked from logging in before a specified number of consecutive invalid login attempts if login operations are performed on Windows or other operating systems, or from applications that use FTP, IPP, SNMPv3, SMB, or WebDAV.

<Password Settings>

Specify the settings for enhancing the effective security of the password.

- ▶ <Prohibit Caching of Authentication Password>(P. 1366)
- ▶ <Display Warning When Default Password Is in Use>(P. 1366)
- ▶ <Allow Use of Default Password for Remote Access>(P. 1367)
- ▶ <Minimum Length Settings>(P. 1367)
- ▶ <Validity Period Settings>(P. 1367)
- ▶ <Prohibit Use of 3 or More Identical Consecutive Char.>(P. 1368)
- ▶ <Use at Least 1 Uppercase Character>(P. 1368)
- ▶ <Use at Least 1 Lowercase Character>(P. 1369)
- ▶ <Use at Least 1 Digit>(P. 1369)
- ▶ <Use at Least 1 Symbol>(P. 1370)

NOTE

- For information on the items ("A", "B", "C", and "No") in the "Import All Function" column, see ▶ **Import All Function(P. 1054)** .

<Prohibit Caching of Authentication Password>

 (Settings/Registration) ▶ <Management Settings> ▶ <Security Settings> ▶ <Authentication/Password Settings> ▶ <Password Settings>

Select whether to prohibit caching of a password that is entered at login.

Item	Setting Description	DeviceAdmin	NetworkAdmin	Can be set in Remote UI	Device Information Delivery Available	Import All Function	Name of Item When Exporting with the Remote UI
<Prohibit Caching of Authentication Password>	<On>, <Off>	No	No	Yes	No	C	Settings/Registration Basic Information

NOTE

- Passwords are not saved to the timeline of unauthenticated users or guest users, regardless of this setting.

<Display Warning When Default Password Is in Use>

 (Settings/Registration) ▶ <Management Settings> ▶ <Security Settings> ▶ <Authentication/Password Settings> ▶ <Password Settings>

Select whether to display the screen for changing the password when the Administrator logs in to the machine using the default user name and password.

Item	Setting Description	DeviceAdmin	NetworkAdmin	Can be set in Remote UI	Device Information Delivery Available	Import All Function	Name of Item When Exporting with the Remote UI
<Display Warning When Default Password Is in Use>	<On>, <Off>	No	No	Yes	No	C	Settings/Registration Basic Information

NOTE

- If the password has expired, the screen for changing the password appears, regardless of this setting.

<Allow Use of Default Password for Remote Access>

 (Settings/Registration) ▶ <Management Settings> ▶ <Security Settings> ▶ <Authentication/Password Settings> ▶ <Password Settings>

Select whether to allow the default password to be used when logging in from the Remote UI.

Item	Setting Description	DeviceAdmin	NetworkAdmin	Can be set in Remote UI	Device Information Delivery Available	Import All Function	Name of Item When Exporting with the Remote UI
<Allow Use of Default Password for Remote Access>	<On>, <Off>	No	No	Yes	No	C	Settings/Registration Basic Information

<Minimum Length Settings>

 (Settings/Registration) ▶ <Management Settings> ▶ <Security Settings> ▶ <Authentication/Password Settings> ▶ <Password Settings>

You can set the minimum number of characters required when registering a password to prevent the simplification of passwords. When a password length is set, a user cannot be registered with a blank password.

Item	Setting Description	DeviceAdmin	NetworkAdmin	Can be set in Remote UI	Device Information Delivery Available	Import All Function	Name of Item When Exporting with the Remote UI
<Minimum Length Settings>	<On> (1 to 32 Characters), <Off>	No	No	Yes	No	C	Settings/Registration Basic Information

NOTE

- This setting applies to personal authentication management, not to Department ID and PIN.
- Password restriction settings are valid for passwords that are registered/edited after the restrictions are set. When a password that is already registered exceeds the restrictions for these settings, a screen prompting to change the password is displayed when user authentication is performed.

<Validity Period Settings>

 (Settings/Registration) ▶ <Management Settings> ▶ <Security Settings> ▶ <Authentication/Password Settings> ▶ <Password Settings>

You can set a password expiration period to force users to periodically change their password, in order to prevent the simplification of passwords.

Item	Setting Description	DeviceAdmin	NetworkAdmin	Can be set in Remote UI	Device Information Delivery Available	Import All Function	Name of Item When Exporting with the Remote UI
<Validity Period Settings>	<On> (1 to 180 days), <Off>	No	No	Yes	No	C	Settings/Registration Basic Information

NOTE

- This setting applies to personal authentication management, not to Department ID and PIN.
- Password restriction settings are valid for passwords that are registered/edited after the restrictions are set. When a password that is already registered exceeds the restrictions for these settings, a screen prompting to change the password is displayed when user authentication is performed.

<Prohibit Use of 3 or More Identical Consecutive Char.>

 (Settings/Registration) ► <Management Settings> ► <Security Settings> ► <Authentication/Password Settings> ► <Password Settings>

You can restrict passwords so that the same character cannot be used consecutively three or more times.

Item	Setting Description	DeviceAdmin	NetworkAdmin	Can be set in Remote UI	Device Information Delivery Available	Import All Function	Name of Item When Exporting with the Remote UI
<Prohibit Use of 3 or More Identical Consecutive Char.>	<On>, <Off>	No	No	Yes	No	C	Settings/Registration Basic Information

NOTE

- This setting applies to personal authentication management, not to Department ID and PIN.
- Password restriction settings are valid for passwords that are registered/edited after the restrictions are set. When a password that is already registered exceeds the restrictions for these settings, a screen prompting to change the password is displayed when user authentication is performed.

<Use at Least 1 Uppercase Character>

 (Settings/Registration) ► <Management Settings> ► <Security Settings> ► <Authentication/Password Settings> ► <Password Settings>

You can restrict passwords so that only passwords which include at least one uppercase character can be registered.

Item	Setting Description	DeviceAdmin	NetworkAdmin	Can be set in Remote UI	Device Information Delivery Available	Import All Function	Name of Item When Exporting with the Remote UI
<Use at Least 1 Uppercase Character>	<On>, <Off>	No	No	Yes	No	C	Settings/Registration Basic Information

NOTE

- This setting applies to personal authentication management, not to Department ID and PIN.
- Password restriction settings are valid for passwords that are registered/edited after the restrictions are set. When a password that is already registered exceeds the restrictions for these settings, a screen prompting to change the password is displayed when user authentication is performed.

<Use at Least 1 Lowercase Character>

 (Settings/Registration) ► <Management Settings> ► <Security Settings> ► <Authentication/Password Settings> ► <Password Settings>

You can restrict passwords so that only passwords which include at least one lowercase character can be registered.

Item	Setting Description	DeviceAdmin	NetworkAdmin	Can be set in Remote UI	Device Information Delivery Available	Import All Function	Name of Item When Exporting with the Remote UI
<Use at Least 1 Lowercase Character>	<On>, <Off>	No	No	Yes	No	C	Settings/Registration Basic Information

NOTE

- This setting applies to personal authentication management, not to Department ID and PIN.
- Password restriction settings are valid for passwords that are registered/edited after the restrictions are set. When a password that is already registered exceeds the restrictions for these settings, a screen prompting to change the password is displayed when user authentication is performed.

<Use at Least 1 Digit>

 (Settings/Registration) ► <Management Settings> ► <Security Settings> ► <Authentication/Password Settings> ► <Password Settings>

You can restrict passwords so that only passwords which include at least one number can be registered.

Item	Setting Description	DeviceAdmin	NetworkAdmin	Can be set in Remote UI	Device Information Delivery Available	Import All Function	Name of Item When Exporting with the Remote UI
<Use at Least 1 Digit>	<On>, <Off>	No	No	Yes	No	C	Settings/Registration Basic Information

NOTE

- This setting applies to personal authentication management, not to Department ID and PIN.
- Password restriction settings are valid for passwords that are registered/edited after the restrictions are set. When a password that is already registered exceeds the restrictions for these settings, a screen prompting to change the password is displayed when user authentication is performed.

<Use at Least 1 Symbol>

 (Settings/Registration) ▶ <Management Settings> ▶ <Security Settings> ▶ <Authentication/Password Settings> ▶ <Password Settings>

You can restrict passwords so that only passwords which include at least one symbol can be registered.

Item	Setting Description	DeviceAdmin	NetworkAdmin	Can be set in Remote UI	Device Information Delivery Available	Import All Function	Name of Item When Exporting with the Remote UI
<Use at Least 1 Symbol>	<On>, <Off>	No	No	Yes	No	C	Settings/Registration Basic Information

NOTE

- This setting applies to personal authentication management, not to Department ID and PIN.
- Password restriction settings are valid for passwords that are registered/edited after the restrictions are set. When a password that is already registered exceeds the restrictions for these settings, a screen prompting to change the password is displayed when user authentication is performed.

<Encryption Settings>

Specify the settings for enhancing the effective encryption security.

🔴<Prohibit Use of Weak Encryption>(P. 1371)

🔴<Format Encryption Method to FIPS 140-2>(P. 1371)

NOTE

- For information on the items ("A", "B", "C", and "No") in the "Import All Function" column, see 🔴**Import All Function(P. 1054)** .

<Prohibit Use of Weak Encryption>

⚙️ (Settings/Registration) ▶ <Management Settings> ▶ <Security Settings> ▶ <Encryption Settings>

Select whether to restrict the use of weak encryption, or a key and certificate with weak encryption. 🔴**Management Functions(P. 1586)**

Item	Setting Description	DeviceAdmin	NetworkAdmin	Can be set in Remote UI	Device Information Delivery Available	Import All Function	Name of Item When Exporting with the Remote UI
<Prohibit Use of Weak Encryption>	<On>, <Off> <On> is selected: <ul style="list-style-type: none"> <Prohibit Use of Key/Certificate with Weak Encryption>: <On>, <Off> 	No	No	Yes	No	C	Settings/Registration Basic Information

NOTE

- This setting applies to functions such as IPSec, TLS, Kerberos, S/MIME, wireless LAN, and SNMPv3.
- The machine may not be able to communicate with devices that only support weak encryption.
- Even if the use of weak encryption is restricted, it may be allowed depending on the certificate (root certificate).
- For information on the algorithms prohibited when this setting is set to <On>, see 🔴**System Specifications(P. 1577)** .

<Format Encryption Method to FIPS 140-2>

⚙️ (Settings/Registration) ▶ <Management Settings> ▶ <Security Settings> ▶ <Encryption Settings>

Specify whether to make the function using encryption comply with FIPS 140-2.

Item	Setting Description	DeviceAdmin	NetworkAdmin	Can be set in Remote UI	Device Information Delivery Available	Import All Function	Name of Item When Exporting with the Remote UI
<Format Encryption Method to FIPS 140-2>	<On>, <Off>	No	No	Yes	No	C	Settings/Registration Basic Information

NOTE

- This setting is available for TLS and MEAP applications.
- This setting is not available for TLS communication using the machine's touch panel Web Access function.
- This setting is only available for MEAP applications that use a FIPS provider.
- For information on the algorithms prohibited when this setting is set to <On>, see [▶System Specifications\(P. 1577\)](#) .

Volume Settings (Volume Settings)

Specify the settings for tones emitted by the machine, such as the tone for sending or receiving a fax and the confirmation tones notifying you of the machine's status.

- For detailed information on the settings, see [▶Setting Sounds\(P. 384\)](#) .

NOTE

- The item for sound settings (volume adjustment) appears when you press <Volume Settings> or the Volume Settings key (on machines with an upright control panel).
- For information on the items ("A", "B", "C", and "No") in the "Import All Function" column, see [▶Import All Function\(P. 1054\)](#) .

■ Settings for Machines with a Fax Function

Item	Setting Description	DeviceAdmin	NetworkAdmin	Can be set in Remote UI	Device Information Delivery Available	Import All Function	Name of Item When Exporting with the Remote UI
<Alarm Volume>	0 to 4 to 8	Yes	Yes	Yes	Yes	C	Settings/ Registration Basic Information
<Monitor Volume>	0 to 4 to 8	Yes	Yes	Yes	Yes	C	Settings/ Registration Basic Information
<Memory RX/TX End Tone>	<On>, <Off>	Yes	Yes	Yes	No	C	Settings/ Registration Basic Information
<Memory RX/TX Error Tone>	<On>, <Off>	Yes	Yes	Yes	No	C	-Settings/ Registration Basic Information
<Other Volume Settings>	<Entry Tone>: 0 to 2 to 3 <Invalid Entry Tone>: 0 to 3 <Restock Supplies Tone>: 0 to 3 <Forgot Original Tone>: 0 to 3 <Error Tone>: 0 to 2 to 3 <Job Done Tone>: 0 to 2 to 3 <Sleep Mode Tone>*1: 0 to 3 <Login Tone>: 0 to 2 to 3 <Non-Empty Toner Rplcd. Tone>*2: 0 to 2 to 3	Yes	Yes	Yes	Yes	C	Settings/ Registration Basic Information

*1 May appear as <Energy Saver/Sleep Tone> on some models.

*2 May not appear on some models.

■ Settings for Machines without a Fax Function

Item	Setting Description	DeviceAdmin	NetworkAdmin	Can be set in Remote UI	Device Information Delivery Available	Import All Function	Name of Item When Exporting with the Remote UI
<Volume Settings>	<Entry Tone>: 0 to 2 to 3 <Invalid Entry Tone>: 0 to 3 <Restock Supplies Tone>: 0 to 3 <Forgot Original Tone>: 0 to 3 <Error Tone>: 0 to 2 to 3 <Job Done Tone>: 0 to 2 to 3 <Sleep Mode Tone>*1: 0 to 3 <Login Tone>: 0 to 2 to 3 <Non-Empty Toner Rplcd. Tone>*2: 0 to 2 to 3	Yes	Yes	Yes	Yes	C	Settings/ Registration Basic Information

*1 May appear as <Energy Saver/Sleep Tone> on some models.

*2 May not appear on some models.

Adjusting Print and Finish Quality

Adjusting Print and Finish Quality	1376
Adjusting Gradation	1378
Adjusting Density	1381
Correcting Uneven Density	1382
Correcting Color Mismatch	1385
Making Colors More Vivid	1386
Adjusting Image Size	1387
Setting the Dither Pattern	1388
Reducing Toner Used When Color Printing	1389
Adjusting the Saddle Stitch Position	1390
Adjusting the Saddle Stitch Folding Position	1391
Adjusting the Paper Folding Position	1392
Registering a Color Profile for Printing	1393

Adjusting Print and Finish Quality

961F-0UU

Adjust the settings below if printing results are not satisfactory, or if you want to adjust the paper folding position.

■ Gradation Adjustment

If color gradation reproducibility has become so poor that the printed gradation differs markedly from the print data, make adjustments to improve color gradation reproducibility.

▶ Adjusting Gradation(P. 1378)

■ Density Correction

If the density of the printing is significantly different from the original document, this adjusts the scan density to be closer to the original.

▶ Adjusting Density(P. 1381)

■ Shading Correction

If the image areas of the printing have uneven density, this correction adjusts the printing so that the density is even.

▶ Correcting Uneven Density(P. 1382)

■ Color Mismatch Correction

If the colors of printing run or blur, color mismatch (color misregistration) may have occurred. The problem may be improved by performing color mismatch correction.

▶ Correcting Color Mismatch(P. 1385)

■ Vividness Setting

You can increase the saturation of colors for color printing.

▶ Making Colors More Vivid(P. 1386)

■ Image Size Adjustment

If the size of the image copied is slightly different from the original, fine adjustment is performed so that the printed size more closely matches the size of the original.

▶ Adjusting Image Size(P. 1387)

■ Dither Pattern Setting

A dither pattern suitable for an image is set to enable the gradations and curves in the image to be reproduced as smoothly as possible in the print.

▶ Setting the Dither Pattern(P. 1388)

■ Color Profile Registration

Use this setting to match colors to other printer models or to ensure that specific colors are reproduced accurately.

▶ Registering a Color Profile for Printing(P. 1393)

■ Saddle Stitch Position Adjustment

If the saddle stitch position of the paper is not exactly in the middle of the booklet, you can make adjustments to the saddle stitch position.

▶ Adjusting the Saddle Stitch Position(P. 1390)

■ Saddle Stitch Folding Position Adjustment

You can adjust the saddle stitch folding position during booklet printing.

▶ Adjusting the Saddle Stitch Folding Position(P. 1391)

■ Paper Folding Position Adjustment

You can adjust the paper fold position when configuring the fold function.

▶ Adjusting the Paper Folding Position(P. 1392)

Adjusting Gradation

961F-0UW

If color gradation reproducibility has become so poor that the gradation in the printed or copied image differs markedly from the print data or original document, gradation adjustment may improve the problem. There are two types of adjustments: **Full Adjustment(P. 1378)** and **Quick Adjustment(P. 1380)**.

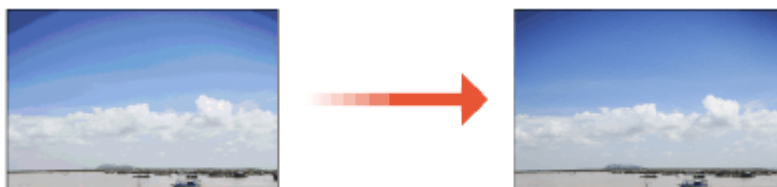

NOTE

- Adjustments may not be performed effectively if there is not sufficient toner.
 - Checking the Remaining Toner Level(P. 128)**
- If the machine is running without having executed <Full Adjust> or <Quick Adjust> once, it may take time to print the first sheet after turning the power ON.

Full Adjustment

Correct the gradation of an image accurately and optimize reproducibility during printing. Optimized information will be retained until the next accurate correction.

! IMPORTANT

- You can use the following paper sizes/types.
 - Size: A3, A4, 11" x 17", LTR
 - Type: Thin 1 to 2, Plain 1 to 3, Recycled 1 to 3, Heavy 1 to 7

NOTE

If the colors in the printed image differ from those in the original

- Adjust the gradation in the steps below according to the paper and settings used for printing.

To print on heavy paper

- Use thin, plain, or recycled paper and adjust with <Thin/Plain/Recycled>.
- Use heavy paper and adjust with <Heavy>.

If both of the following apply:

- To print in Superfine on thin, plain, or recycled paper
 - If <Speed/Image Quality Priority for Superfine (1200 dpi)> is set to <Quality Priority> **Quick Adjustment(P. 1380)** **<Speed/Image Quality Priority for Superfine (1200 dpi)>(P. 1177)**
- Use thin, plain, or recycled paper and adjust with <Thin/Plain/Recycled>.
 - Use thin, plain, or recycled paper and adjust with <Thin/Plain/Recycled(1200dpi)>.

1 Press  (Settings/Registration) ▶ <Adjustment/Maintenance> ▶ <Adjust Image Quality> ▶ <Auto Adjust Gradation>.

2 Select the paper to adjust, and press <Full Adjust>.

NOTE:

Changing the Settings for Adjustment

- You can change the settings for adjustment, such as whether the feeder is used during full adjustment. ▶ **Changing the Settings for Adjustment(P. 1380)**
- <Thin/Plain/Recycled(1200dpi)> can only be selected when <Speed/Image Quality Priority for Superfine (1200 dpi)> is set to <Quality Priority>. ▶ **<Speed/Image Quality Priority for Superfine (1200 dpi)>(P. 1177)**

3 Select the paper source in which the paper you selected in step 2 is loaded, and press <OK>.

4 Press <Start Printing>.

⇒ A test page is printed.

5 Scan the test page.

- If the paper source selected in step 3 contains one of the paper types listed below, use the platen glass for scanning even when <Use Feeder When Performing Full Adjust> is set to On.
 - Thin 1, Thin 2, Heavy 6, Heavy 7

■ Scanning Using the Feeder

1 Place the test pages in the feeder.

- Place the test pages in the feeder.

2 Press <Start Scanning>.

⇒ The test pages are scanned and full adjustment is completed.

■ Scanning Using the Platen Glass

1 Place the test page on the platen glass.

- Place the test page as indicated by the on-screen instructions.

2 Close the feeder and press <Start Scanning>.

⇒ The machine starts scanning the test page.

3 Open the feeder, and remove the test page.

4 Repeat steps 4 (Press <Start Printing>) and 5 (Scan the test page) above for full adjustment.

⇒ To complete adjustment, follow the on-screen instructions to print and then scan the test page multiple times.

Quick Adjustment

This adjustment maintains the optimized status that was acquired by <Full Adjust>. If the result of this adjustment is not satisfactory, perform <Full Adjust>.

1 Press  (Settings/Registration) ► <Adjustment/Maintenance> ► <Adjust Image Quality> ► <Auto Adjust Gradation>.

2 <Thin/Plain/Recycled> ► Press <Quick Adjust>.

NOTE:

- The adjustment is applied to all paper types.

3 Press <Start>.

Changing the Settings for Adjustment

You can change the settings for adjustment, such as whether the feeder is used during full adjustment.

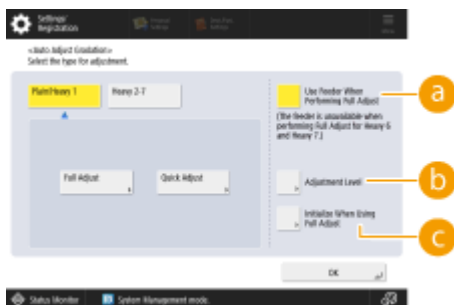

a <Use Feeder When Performing Full Adjust>

Select On to use the feeder when scanning the test page or Off to use the platen glass.

b <Initialize When Using Full Adjust>

Enables you to set whether to use default settings for gradation adjustment.

IMPORTANT

- Since this may cause poor color balance, make sure to perform auto gradation adjustment (full adjustment) after changing the settings.

Adjusting Density

If the density of the printing is significantly different from the original document, follow the procedure below to adjust the scan density to be closer to the original.



1 Press  (Settings/Registration) ► <Adjustment/Maintenance> ► <Adjust Image Quality> ► <Correct Density>.

2 Adjust the density.

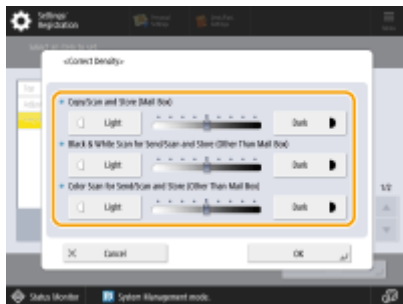

(Items shown on the screen may differ depending on your model and options.)

- When set to the <Dark> side, areas printed with the maximum density are increased. When set to the <Light> side, filled areas, text, and lines may be printed like halftones with dots missing. This setting should mainly be used to adjust the intermediate densities.

3 Press <OK>.

LINKS

- ▶ Basic Copy Operations(P. 420)
- ▶ Basic Operations for Sending Faxes(P. 524)
- ▶ Basic Operations for Scanning Originals(P. 640)

Correcting Uneven Density

961F-0W0

If the density is uneven when printing, perform <Correct Shading>. There are various methods for correcting the density: **▶Correction with a Densitometer(P. 1382)** using a commercial measuring instrument, **▶Visual Correction(P. 1383)** , and **▶Scanner Correction(P. 1383)** .



NOTE

- Adjustments may not be performed effectively if there is not sufficient toner.
▶Checking the Remaining Toner Level(P. 128)

Correction with a Densitometer

Measure a test page you have output with a commercial densitometer and enter the measured density values to correct the density of halftone areas.

- 1** Press  (Settings/Registration) ▶ <Adjustment/Maintenance> ▶ <Adjust Image Quality> ▶ <Correct Shading> ▶ <Densitometer Correction>.
- 2** Press <Start Printing>.
 - ⇒ A test page is printed.
- 3** Measure the test page with a densitometer.
 - Measure marks 1 to 7 printed on the test page, and make a note of the density values that are detected.
- 4** Press <Fine Adjust>, and then enter the density values.
 - Enter the density values you measured and made a note of in step 3 in 1 to 7.
 - Press <Fine Adjust> for each color and enter the density for all the colors.
- 5** Press <OK>.
- 6** Press <Output Test Page> ▶ <Start Printing>.
 - ⇒ A test page after correction is output.
- 7** If there is no problem with the test page, press <Store and Finish>.

- If the density of the test page after correction is uneven, perform the procedure indicated in **Visual Correction(P. 1383)** .

Visual Correction

Visually measure a test page you have output to perform correction using the density adjustment values you determine. Use this procedure when you do not have a densitometer or when correction is not effective.

1 Press  (Settings/Registration) ▶ <Adjustment/Maintenance> ▶ <Adjust Image Quality> ▶ <Correct Shading> ▶ <Visual Correction>.

2 Press <Output Test Page> ▶ <Start Printing>.

⇒ A test page is printed.

3 Visually check the test page to determine the density adjustment values.

NOTE

- The range of marks printed may be -6 to +6 or -5 to +5, depending on the paper size used for the test page.

4 Press <Fine Adjust>, and then enter the density values.

- Enter the density values according to the results that you visually checked in step 3 from -6 to +6 (or -5 to +5).
- Enter a plus value to increase the density, or a minus value to decrease the density.
- Press <Fine Adjust> for each color and enter the density for all the colors.

5 Press <OK>.

6 Press <Output Test Page> ▶ <Start Printing>.

⇒ A test page after correction is output.

7 If there is no problem with the test page, press <Store and Finish>.

Scanner Correction

You can perform density correction by scanning a test page that you have output. The machine automatically determines density correction values and corrects irregularities.

1 Press  (Settings/Registration) ▶ <Adjustment/Maintenance> ▶ <Adjust Image Quality> ▶ <Correct Shading> ▶ <Scanner Correction>.

2 Select the paper to use and press <OK>.

3 Press <Start Printing>.

⇒ A test page is printed.

4 Place the test page on the platen glass.

- Place the test page as indicated by the on-screen instructions.

5 Close the feeder and press <Start Scanning>.

⇒ The test page is scanned.

6 Open the feeder and remove the test page.

Correcting Color Mismatch

961F-0W1

If the print positions slightly shift for the respective colors, use the following procedure to perform color print mismatch correction.

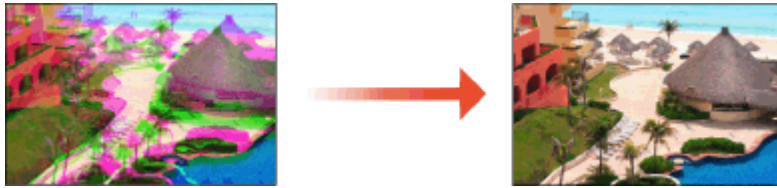

- 1** Press  (Settings/Registration) ▶ <Adjustment/Maintenance> ▶ <Adjust Image Quality> ▶ <Auto Correct Color Mismatch>.
- 2** Press <Start>.

Making Colors More Vivid

961F-0W2

If you want to obtain color printouts with increased saturation of colors as compared to the print data, use the following procedure to configure the necessary settings.



- 1** Press  (Settings/Registration) ▶ <Adjustment/Maintenance> ▶ <Adjust Image Quality> ▶ <Full Color Printing Vividness Settings>.
- 2** Select the level.
 - <Standard> prints with the same color as the original.
 - <Level 1> prints with more saturated colors than the original. <Level 2> prints with even more saturated colors.
- 3** Press <OK>.

Adjusting Image Size

961F-0W3

If the size of the copied image slightly differs from the original, use the following procedure to make fine adjustment of the image size. You can adjust the magnification of the horizontal width and vertical width, respectively.

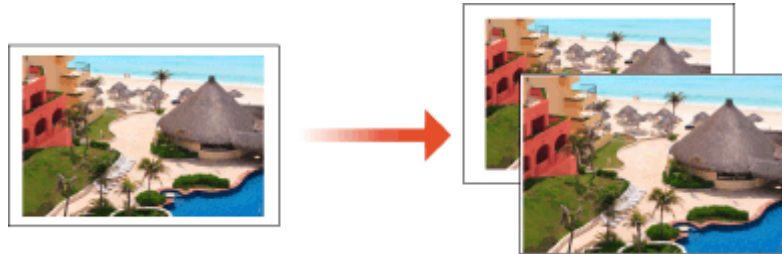

1 Press  (Settings/Registration) ► <Adjustment/Maintenance> ► <Adjust Image Quality> ► <Fine Adjust Zoom>.

2 Adjust the image size.



- Set the magnification of <X> for horizontal width adjustment, and the magnification of <Y> for vertical width adjustment.

3 Press <OK>.

LINKS

 [Basic Copy Operations\(P. 420\)](#)

Setting the Dither Pattern

961F-0W4

Dithering is a technique for reproducing color and density using groups of small dots. The source data for drawing these dots is called a dither pattern. Using a dither pattern suitable for the image to print enables the gradations and curves of the printed image to be reproduced more smoothly.

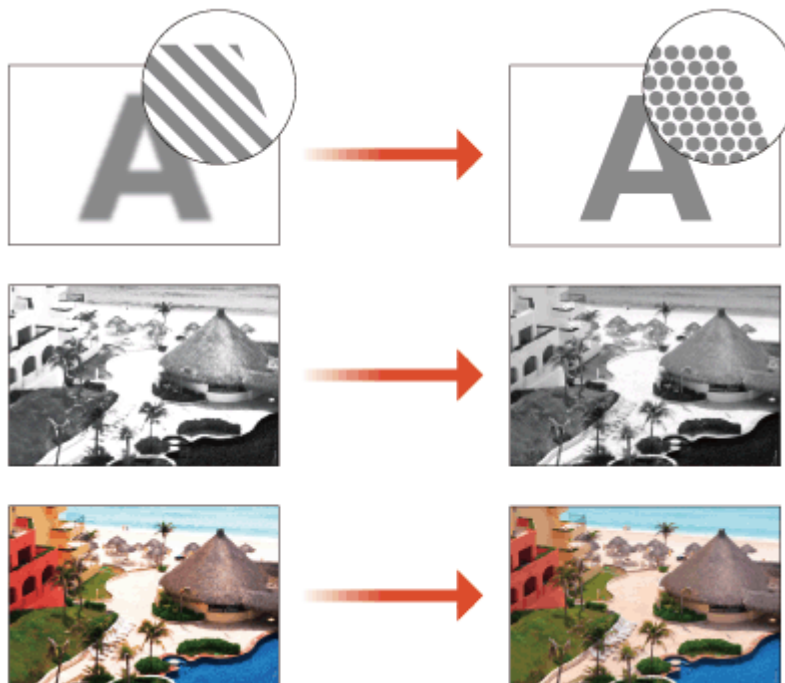

1 Press  (Settings/Registration) ▶ <Adjustment/Maintenance> ▶ <Adjust Image Quality> ▶ <Dither Pattern Settings>.

2 Select the dither pattern.

- <Pattern 1>: The default setting.
- <Pattern 2>: This setting enhances reproduction of highlight areas of black-and-white images.
- <Pattern 3>: This setting enhances reproduction of halftones in color images.
- <Pattern 4>: This setting enhances reproduction of edge areas of the printed image.

3 Press <OK>.

4 Press <Yes>, and perform auto gradation adjustment (full adjustment).

IMPORTANT

- Since this may cause poor color balance, make sure to perform auto gradation adjustment (full adjustment) after changing the settings. ▶ **Adjusting Gradation(P. 1378)**

Reducing Toner Used When Color Printing

961F-0W5

Fixing of excessive toner onto paper may cause color print failures such as generation of afterimages of highly dense characters or lines. Reducing the amount of toner to be fixed may improve this failure.



NOTE

- This function may improve the following failures.
 - Toner scattering around deep color areas of printed images
 - Poor toner fixing in a low-temperature environment
 - Darkening of images printed on transparencies at the time of projection
 - Bleed-through appearing when copying originals from 2-sided printing
- This function is enabled when in the <Copy>, <Print>, or <Access Stored Files> menu, <Use Full Color> is selected under <Select Color> or <Use Auto (Color/Black & White)> is selected, that is, when the current print mode is recognized as full color.
- Use of this function may give an adverse effect on color printing quality.

1 Press  (Settings/Registration) ▶ <Adjustment/Maintenance> ▶ <Adjust Image Quality> ▶ <Adjust Toner Volume Used for Color Printing>.

2 Select the toner volume setting and press <OK>.

- <Off> prints with the standard toner volume.
- <Level 1> prints deep color areas with a bit smaller toner volume than the standard volume.
- <Level 2> generally prints with a reduced toner volume.

Adjusting the Saddle Stitch Position

961F-0W7

If you are performing saddle stitch printing using the optional booklet finisher, and you notice that the folds of the paper are not exactly in the middle of the booklet, you can make adjustments to compensate for this error. Adjust the folding position of the paper and the saddle stitch position at the same time.



- 1 Press  (Settings/Registration) ► <Adjustment/Maintenance> ► <Adjust Action> ► <Change Fold/Stitch Position>.
- 2 Select the paper size you want to adjust.
- 3 Adjust the saddle stitch position.



- 4 Press <OK> ► <Close>.

LINKS

- ▶ Basic Copy Operations(P. 420)
- ▶ Making Booklets(P. 468)
- ▶ Optional Equipment(P. 173)

Adjusting the Saddle Stitch Folding Position

961F-0W8

If you are using the optional booklet finisher, and you notice that the folds of the paper are not exactly in the middle of the booklet, use this setting to adjust the saddle stitch fold placement.



- 1 Press  (Settings/Registration) ► <Adjustment/Maintenance> ► <Adjust Action> ► <Adjust Saddle Stitch Fold Position>.
- 2 Adjust the folding position.



- 3 Press <OK>.

LINKS

- ▶ Basic Copy Operations(P. 420)
- ▶ Making Booklets(P. 468)
- ▶ Optional Equipment(P. 173)

Adjusting the Paper Folding Position

961F-0W9

When you are folding paper using an option with a fold function and the fold position is not where you intended, you can make fine adjustments to the fold position.



- 1 Press  (Settings/Registration) ▶ <Adjustment/Maintenance> ▶ <Adjust Action> ▶ <Adjust Fold Position>.
- 2 Select the paper size you want to adjust.
- 3 Adjust the folding position.



- 4 Press <OK>.

LINKS

- ▶ Basic Copy Operations(P. 420)
- ▶ Making Booklets(P. 468)
- ▶ Optional Equipment(P. 173)

Registering a Color Profile for Printing

961F-0YK

Registering a color profile on the machine allows the registered colors to be reproduced during printing. Administrator or DeviceAdmin privileges are required to specify these settings.

- ▶ **Registering Specific Colors(P. 1393)**
- ▶ **Reproducing Colors from Another Machine(P. 1394)**
- ▶ **Printing Using a Registered Profile (Windows) (P. 1396)**

NOTE

- You can register up to 9 profiles.
- Always perform auto gradation adjustment (full adjustment) before using the machine. ▶ **Adjusting Gradation(P. 1378)**

Registering Specific Colors

You can register specific colors to be reproduced using a chart. You cannot use registered profiles with the PS, PDF, or Imaging (CMYK) page description languages or file formats.

- 1** Download the “Color Chart for Assigning RGB Values to Output Colors in Color Chart” from the online manual Web site.
- 2** Print the chart with the machine.
 - 1** Open the chart and display the print setting screen of the printer driver.
 - 2** Select the machine and click [Details] or [Properties].
 - 3** On the [Basic Settings] tab, select [A4] or [Letter] for [Page Size] and [1-sided Printing] for [1-sided/2-sided/Booklet Printing].
 - 4** Clear the [Manual Scaling] check box on the [Page Setup] tab.
 - 5** Select the [Manual Color Settings] check box on the [Quality] tab, and click [Color Settings].
 - 6** On the [Matching] tab, select [No Driver Matching] in [Matching Mode], clear the [Application Color Matching Priority] check box, and then click [OK].
 - 7** Click [Print] or [OK].
 - ⇒ The chart is printed.
- 3** Press  (Settings/Registration) ▶ <Adjustment/Maintenance> ▶ <Adjust Image Quality> ▶ <Register Color Profile> ▶ <Assign RGB Values to Output Colors in Color Chart>.
- 4** Create a profile to register the colors you want to reproduce.
 - Select one of the existing registered profiles and press <Duplicate>. Next, enter the profile name and press <OK>.

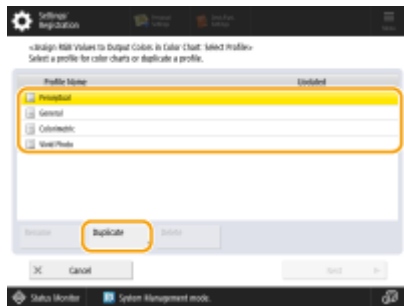

5 Select the created profile and press <Next>.

6 Press <Add>.

- To edit the registered colors, press <Edit>.
- To edit the registered colors, press <Delete>.

7 Enter the values for the color to be registered.

- Enter the RGB values for the color you want to create in <Target RGB> and enter the <Sheet No.>, <Row>, and <Column> for that color from the chart printed in step 2.
- You cannot register a color that has the same values for R, G, and B.
E.g.: White (R,G,B)=(255,255,255), Black (R,G,B)=(0,0,0)
- You cannot register an additional color with RGB values that are already registered.



8 Press <OK>.

- ⇒ The output color is added.
- You can register up to 168 colors.

9 Press <OK>.

- ⇒ The output color information is registered in the profile.

NOTE

- The registered profile will be enabled by performing one of the following operations:
 - Press  (Settings/Registration) ►  (Settings/Registration) ► <Apply Set. Changes> ► <Yes>.
 - Restart the machine. ► **Restarting the Machine(P. 911)**

Reproducing Colors from Another Machine

You can register colors to be reproduced that are used on another Canon machine. This function may not be available on some models, such as those not equipped with feeders.

1 Download “Color Chart for Reproducing Colors from Other Device” for the machine chart from the online manual Web site.

2 Print the chart with the machine.

- 1 Open the chart and display the print setting screen of the printer driver.
- 2 Select the machine and click [Details] or [Properties].
- 3 On the [Basic Settings] tab, select [A4] or [Letter] for [Page Size] and [1-sided Printing] for [1-sided/2-sided/Booklet Printing].
- 4 Select the [Manual Scaling] check box on the [Page Setup] tab, and set it to 100%.
- 5 Select the [Manual Color Settings] checkbox on the [Quality] tab, and click [Color Settings].
- 6 On the [Matching] tab, select [No Driver Matching] in [Matching Mode], clear the [Application Color Matching Priority] check box, and then click [OK].
- 7 Click [Print] or [OK].
 ⇒ The chart is printed.

3 Download "Color Chart for Reproducing Colors from Other Device" for the other machine chart from the online manual Web site.

4 Print the chart on the other machine showing the colors to be reproduced.

- 1 Open the chart and display the print setting screen of the printer driver.
- 2 Select the other machine, and click [Details] or [Properties].
- 3 On the [Basic Settings] tab, select [A4] or [Letter] for [Page Size] and [1-sided Printing] for [1-sided/2-sided/Booklet Printing].
- 4 Clear the [Manual Scaling] check box on the [Page Setup] tab.
- 5 On the other machine, print using the settings on this machine for the color to be reproduced.



5 Press (Settings/Registration) ▶ <Adjustment/Maintenance> ▶ <Adjust Image Quality> ▶ <Register Color Profile> ▶ <Reproduce Colors from Other Device>.

6 Load the respective charts into the feeder stacked so that the 4 sheets from the other machine are on the bottom and the 4 sheets from this machine are on the top, and then press <Start Scanning>.

7 When scanning is complete, enter the <Profile Name> and press <OK>.

- The registration of a profile is completed.
- You cannot register the name of a profile that has already been registered.

NOTE

- The registered profile will be enabled by performing one of the following operations:
 - Press  (Settings/Registration) ▶  (Settings/Registration) ▶ <Apply Set. Changes> ▶ <Yes>.
 - Restart the machine.  **Restarting the Machine(P. 911)**

Printing Using a Registered Profile **Windows**

If you want to print using a registered profile, perform the following operations in the printer driver.

- 1** Open a document and display the print setting screen of the printer driver.
- 2** Select the machine, and click [Details] or [Properties].
- 3** Select the [Manual Color Settings] check box on the [Quality] tab, and click [Color Settings].
- 4** On the [Matching] tab, select [No Driver Matching] in [Matching Mode], clear the [Application Color Matching Priority] check box, and then click [OK].
- 5** Select a registered profile in [Matching Method], and click [OK].

■ When using PS Printer

- 1** Open a document and display the print setting screen of the printer driver.
- 2** Select the machine, and click [Details] or [Properties].
- 3** On the [Color] tab, select [Device Link Profile] in [RGB Matching Mode].
- 4** Select a registered profile in [RGB Input (Light+ClrSpace)], and click [OK].

Troubleshooting

Troubleshooting	1398
If the Machine Does Not Operate	1400
Cannot Print	1402
Problems with Printing Results	1403
Problems with Faxes	1407
Problems with Scanning	1409
Problems with the Network	1411
Problems with Security	1415
Problems with MEAP	1416
Other Problems	1418
A Message or a Number Starting with "#" (an Error Code) Is Displayed	1421
A Message Saying to Contact a Local Authorized Canon Dealer Is Displayed	1422
Countermeasures for Each Message	1425
Countermeasures for Each Error Code	1469

Troubleshooting

961F-0WA

If a problem occurs while you are using the machine, check this chapter before contacting your dealer or service representative.

■ What kind of problem do you have?



▶ If the Machine Does Not Operate(P. 1400)



▶ Cannot Print(P. 1402)



▶ Problems with Printing Results(P. 1403)



▶ Problems with Faxes(P. 1407)



▶ Problems with Scanning(P. 1409)



▶ Problems with the Network(P. 1411)



▶ A Message or a Number Starting with "#" (an Error Code) Is Displayed(P. 1421)



▶ Problems with Security(P. 1415)



▶ Problems with MEAP(P. 1416)



▶ Other Problems(P. 1418)

■ **When a paper jam/staple jam* occurs**

The procedures for clearing paper jams and staple jams* are described in [▶About the Machine\(P. 17\)](#) .

* Machines with a stapling function only

If the Machine Does Not Operate

961F-0WC

If a problem occurs while you are using the machine, check the following before contacting your dealer or service representative.

- ▶ **Check This First(P. 1400)**
- ▶ **If the machine does not respond to computer operations(P. 1400)**
- ▶ **When the authentication screen (login screen) is displayed(P. 1401)**

Check This First



→ Is a message displayed on the touch panel display?

- A message is displayed on the touch panel display when an error or a problem occurs while operating the machine.
 - ▶ **A Message or a Number Starting with "#" (an Error Code) Is Displayed(P. 1421)**

→ Has the Main Power indicator gone out?

- If the Main Power indicator does not light up even though the power switch is ON, check the power plug.

→ Is the machine in the Sleep mode?

- When the machine is in the Sleep mode, the touch panel display turns off. Touch the touch panel display to cancel the Sleep mode.
- On machines with an upright control panel,  (Energy Saver) lights in the Sleep mode. Press  (Energy Saver) to cancel the Sleep mode.

→ Is the machine connected to a computer correctly?

- Check the network connection of the machine and the computer.
 - ▶ **Setting up the Network Environment(P. 263)**

If the machine does not respond to computer operations

→ Restart the machine.

- If the machine does not respond even though its power is turned ON, turn the power OFF (▶ **Turning OFF the Machine(P. 36)**). Confirm that the power cord is connected correctly, wait 10 or more seconds after the main power indicator turns off, and then turn the power back ON (▶ **Turning ON the Machine(P. 35)**).

→ Check whether the driver is installed correctly.

- For information on installing the driver, see ▶ **Installing Drivers(P. 313)** .

→ **Check whether the IP address of the machine is correct.**

- Check the IP address settings, and change them if they are incorrect. For information on the settings, see **▶Setting up Using the Setup Guide(P. 250)** .

When the authentication screen (login screen) is displayed

→ **Log in as a registered user.**

- When the authentication screen (login screen) is displayed, you must log in as a registered user to continue operating the machine.
▶Logging into the Machine(P. 355)

Cannot Print

961F-0WE

Check This First

→ Is the Processing/Data indicator (on the control panel) flashing or lit?

- If it is flashing or lit, there is a document that is being processed or waiting to be processed. Wait for the processing to finish or select the document that you want to prioritize from the screen for checking the printing status.
 - ▶ **Checking the Printing Status and History(P. 602)**
 - ▶ **Printing Documents Retained in the Machine (Forced Hold Printing)(P. 608)**

→ Is a message displayed on the touch panel display?

- A message is displayed on the touch panel display when an error or a problem occurs while operating the machine.
 - ▶ **A Message or a Number Starting with "#" (an Error Code) Is Displayed(P. 1421)**

→ Is <Auto Select> set to <No>?

- To switch to the appropriate operation mode, change all items or the items you are using to <Yes>. For more details, see Setting the Machine (PS/PCL/UFR II Printer) via the online manual site.

→ Is forced hold printing enabled?

- If it is enabled, documents may not be printed, depending on their settings.
 - ▶ **Configuring the Forced Hold Printing Settings(P. 886)**

→ Are you printing via a print server using the LPR command?

- When continuously printing PDF data using the LPR command, execute one job at a time at the interval set in <Timeout>. For more details, see Setting the Machine (PS/PCL/UFR II Printer) via the online manual site.

Problems with Printing Results

961F-0WF

- ▶ The printed image is displaced or skewed.(P. 1403)
- ▶ Images are uneven or faint.(P. 1403)
- ▶ Black streaks appear.(P. 1403)
- ▶ White streaks appear.(P. 1403)
- ▶ Bleedthrough occurs.(P. 1404)
- ▶ Images are not printed on the intended side of the paper.(P. 1404)
- ▶ Images are not printed in the intended size.(P. 1404)
- ▶ The orientation does not match on both sides of the paper when using two-sided printing.(P. 1405)
- ▶ Printed paper curls(P. 1406)

The printed image is displaced or skewed.

→ Are the paper guides misaligned?

- Match the paper guides with the paper loaded in the paper source.

Images are uneven or faint.

→ Is the paper damp?

- Replace the paper with paper that is not damp.

→ Are the gradation and density set appropriately?

- Perform gradation adjustment.
 - ▶ **Adjusting Gradation(P. 1378)**

Black streaks appear.

→ Is the document feed scanning area dirty?

- Clean the document feed scanning area.
 - ▶ **Cleaning the Feeder(P. 88)**

White streaks appear.

→ The dust-proof glass may be dirty.

- Clean the dust-proof glass.
 - ▶ **Regular Cleaning(P. 84)**

→ Is the document feed scanning area dirty?

- Clean the document feed scanning area.
 - ▶ **Cleaning the Feeder(P. 88)**

Bleedthrough occurs.

→ Is the density of backgrounds set appropriately?

- By using the BleedReduce setting in <Background Density> and <Original Type>, you can prevent copying of bleed-through on the original.
 - ▶ **Basic Copy Operations(P. 420)**
 - ▶ **Selecting the Type of Original for Copying(P. 434)**

Images are not printed on the intended side of the paper.

→ Is the orientation of the loaded paper correct?

- Check the orientation and side of the paper that is facing up. Load the paper again if it is incorrectly orientated.
 - ▶ **Loading Paper(P. 46)**

Images are not printed in the intended size.

→ Do the original size and size of the paper that is loaded match?

- Replace the paper that is loaded with paper of the size you want to print on.
- Match [Output Size] in the printer driver with the size of paper to print on.

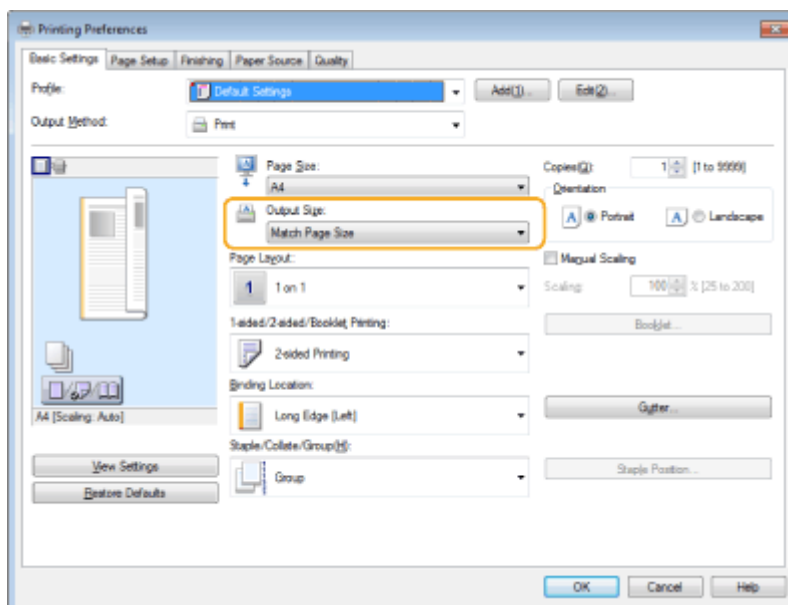

The orientation does not match on both sides of the paper when using two-sided printing.

→ Are the settings for two-sided printing correct?

- Follow the procedure below to check the print settings.

- 1 Select the orientation of the original on the print settings screen of the application.
- 2 On the [Basic Settings] screen of the driver, set [Orientation] to the same orientation you set in step 1.

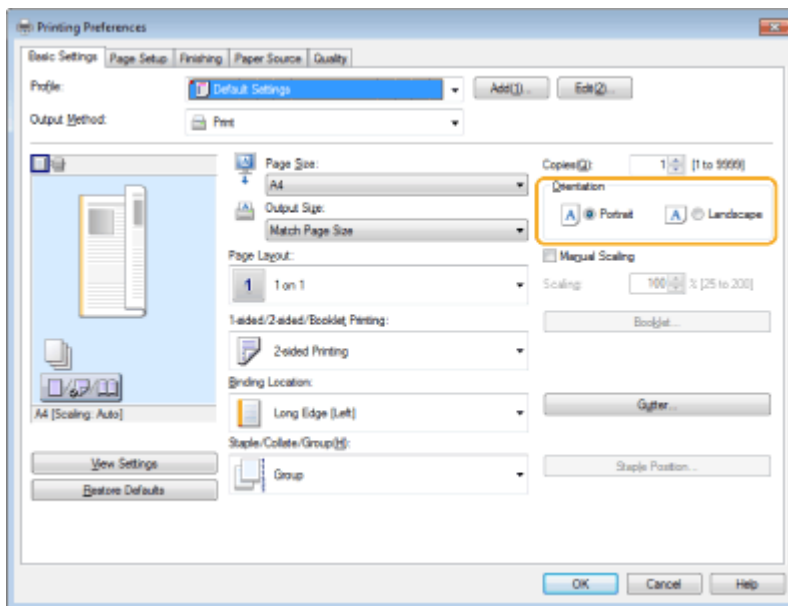

- 3 While checking the print preview, set [Page Layout] ► [Page Order] ► [1-sided/2-sided/Booklet Printing] ► [Binding Location].

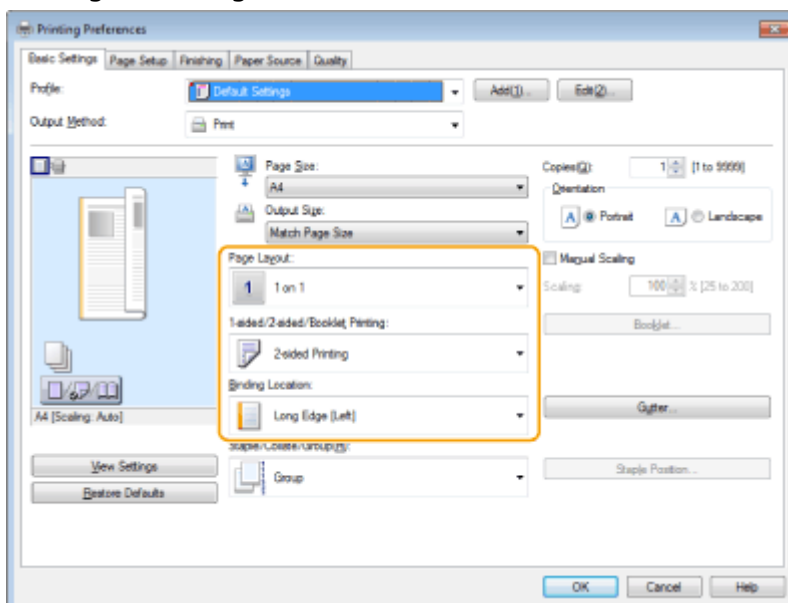

NOTE

- [Page Order] is displayed when [Page Layout] is set to [2 on 1] or higher.

Printed paper curls

→ Is the paper damp?

- Replace the paper with paper that is not damp.

→ Changing the custom paper settings may remedy this problem.

- This problem may be remedied by registering the curled paper as a custom type and setting a lower value for <Adjust Gloss>.
 - ▶ **Paper Type Management Settings(P. 1039)**

Problems with Faxes

961F-0WH

- ▶ **Faxes cannot be sent or forwarded.(P. 1407)**
- ▶ **Cannot receive faxes.(P. 1407)**

Faxes cannot be sent or forwarded.

→ If no faxes can be sent

- Call the destination fax from the machine to check whether the phone line is connected in the wrong location.

If the dial tone of the phone line cannot be heard

The modular cable (phone line for faxing) is disconnected or inserted in the wrong location. Check the modular cable and insert it in the correct location.

- ▶ **Parts and Their Functions(P. 19)**

If voice guidance is played or if the machine cannot connect to the destination fax machine (you cannot hear the fax tone)

There may be a problem with the other party or the service provider. Contact the other party.

→ If faxes cannot be forwarded

- Check the forwarding destination registered in the address book or one-touch button, and change it if it is incorrect.
 - ▶ **Editing the Registered Destinations in the Address Book(P. 408)**
 - ▶ **Editing the Registered Destinations in One-Touch Buttons(P. 413)**

→ If you are using an optical line or an IP phone line

- Communication errors may occur, depending on the line quality. For more information, contact your service provider. You may be able to reduce communication errors by lowering the transmission speed in  (Settings/Registration) ▶ <TX Start Speed>. You can also set the transmission speed for each destination from the preferences for the address book or one-touch buttons.
 - ▶ **<TX Start Speed>(P. 1255)**
 - ▶ **Registering Destinations in the Address Book(P. 394)**
- You can also use <Auto Adjust Communication Speed When Using VoIP> to limit the communication speed to reduce errors.
 - ▶ **<Auto Adjust Communication Speed When Using VoIP>(P. 1257)**

Cannot receive faxes.

→ Does the machine have sufficient free memory?

- Delete unnecessary documents in the memory of the machine.
 - ▶ **Saving Received Documents in the Machine (Memory Reception)(P. 566)**

→ Check the number preceded by "#", and refer to the appropriate countermeasure.

- If fax reception or transmission fails, a number (error code) preceded by "#" is displayed on the touch panel display or in a communication management report. You can refer to the necessary countermeasures according to the error code.
 - ▶ **Countermeasures for Each Error Code(P. 1469)**

Problems with Scanning

961F-0WJ

- ▶ Cannot send documents to a server using the scan and send function.(P. 1409)
- ▶ Cannot send scanned documents via e-mail.(P. 1409)
- ▶ Black streaks appear in scanned documents.(P. 1409)
- ▶ Bleedthrough occurs in scanned documents.(P. 1409)

Cannot send documents to a server using the scan and send function.

→ Are the server settings such as the password correct?

- If the login password, etc. of the server (computer) has been changed, make sure to also change the settings registered in the address book or one-touch buttons.
 - ▶ **Editing the Registered Destinations in the Address Book(P. 408)**
 - ▶ **Editing the Registered Destinations in One-Touch Buttons(P. 413)**

Cannot send scanned documents via e-mail.

→ Is the information for the destination correct?

- Change the settings registered in the address book or one-touch buttons.
 - ▶ **Editing the Registered Destinations in the Address Book(P. 408)**
 - ▶ **Editing the Registered Destinations in One-Touch Buttons(P. 413)**

→ Are the settings for the SMTP server or DNS server correct?

- If no e-mail can be sent, set the SMTP server and DNS server correctly. Also, if the port number for SMTP Send or receiving with POP are different from the default, specify the correct port numbers in ▶ **<Specify Port Number for SMTP TX/POP RX>(P. 1241)** .
 - ▶ **Setting E-mail/I-Fax Communication(P. 316)**
 - ▶ **Making DNS Settings(P. 289)**

Black streaks appear in scanned documents.

→ Is the document feed scanning area dirty?

- Clean the document feed scanning area.
 - ▶ **Cleaning the Feeder(P. 88)**

Bleedthrough occurs in scanned documents.

→ Is the background density set appropriately?

- Set the background density to <Auto>.

▶ **Adjusting Density(P. 660)**

Problems with the Network

961F-0WK

▶ **Problems with Connections(P. 1411)**

▶ **Problems with Wireless Connections(P. 1412)**

Problems with Connections

→ Cannot set up the network.

- Check whether <Confirm Network Connection Setting Changes> is set to <On>.
 - ▶ **<Confirm Network Connection Setting Changes>(P. 1080)**

→ An unintended destination is dialed up.

- If a dial-up router is on the network to which the machine is connected, the machine connects to a destination other than the intended destination, depending on the settings of the machine or dial-up router. This may result in subscriber line charges and call charges. Check the following.
- If the dial-up router does not have to send packets via broadcast, change the router settings to ensure that it sends packets via a method other than broadcast. If it is necessary to allow broadcasting with the dial-up router, check whether an unnecessary destination is set.
- Check whether the host name and IP address of the file server and mail server, etc. set in the machine are correct.
- If the DNS server is on an external server, use the IP address instead of the host name for the destination, even when connecting to devices on the same network as the machine.
- If the DNS server is on the network that the machine is connected to, check whether the information for devices connected to an external network is registered on the DNS server, and whether it is correct.

→ Cannot recognize the machine from a computer.

- If the IP address of the computer where the Remote UI and utility software are executed is not allowed for sending and receiving in <Firewall Settings>, the information for the machine cannot be displayed on the computer. Check whether the settings are correct.
 - ▶ **Specifying IP Addresses in Firewall Settings(P. 855)**
- When using Canon device management software, set <Set Dedicated Community> to <On>, and select <Read/Write> for <MIB Access Permission>. Also set <Dedicated Port Settings> to <On>.
 - ▶ **Monitoring and Controlling via SNMP(P. 303)**
- The machine cannot be recognized when utility software is used to access the machine with a community name other than the SNMP community name set in the machine. Check the SNMP community name.
 - ▶ **Monitoring and Controlling via SNMP(P. 303)**
- If the message "An error has occurred." is displayed in the Web browser and the Remote UI cannot be started, invalid cache data may remain. Clear the cache of the Web browser.
- If the machine enters the Sleep mode, it may not be able to be recognized from a computer. Cancel the Sleep mode or change <Sleep Mode Energy Use> to <High>.
 - ▶ **Exiting Sleep Mode(P. 387)**
 - ▶ **<Sleep Mode Energy Use>(P. 1077)**

Problems with Wireless Connections

→ Cannot connect wireless LAN and wired LAN at the same time.

- You cannot connect wireless LAN and wired LAN at the same time. USB and wireless LAN or USB and wired LAN can be used at the same time.



→ The Remote UI is not displayed.

- Are <Use HTTP> and <Remote UI> set to <On>?
 - ▶ <Use HTTP>(P. 1100)
 - ▶ Starting the Remote UI(P. 902)
- If you are connected with wireless LAN, restart the Remote UI after checking whether the IP address is set correctly.
 - ▶ Conducting a Connection Test for an IPv4 Address(P. 280)
 - ▶ Conducting a Connection Test for an IPv6 Address(P. 282)
- If you are connected with wired LAN, restart the Remote UI after checking whether the IP address is set correctly and the cable is connected correctly.
 - ▶ Connecting to a Wired LAN(P. 269)
 - ▶ Starting the Remote UI(P. 902)
- Are you using a proxy server? If so, add the IP address of the machine in "Exceptions" (addresses to not use a proxy for) in the proxy server settings of the Web browser.
- Is communication with computers restricted in the firewall? If the Remote UI cannot be displayed because the settings are incorrect, set <IPv4 Address Filter>, <IPv6 Address Filter>, or <MAC Address Filter> to <Off> from the control panel of the machine.
 - ▶ Restricting Communication by Using Firewalls(P. 854)
 - ▶ <IPv4 Address Filter>(P. 1120)
 - ▶ <IPv6 Address Filter>(P. 1123)
 - ▶ <MAC Address Filter>(P. 1126)

→ Cannot connect to the network.

- The IP address may have failed to be set. Set the IP address again.
 - ▶ Setting an IP Address(P. 278)
- If you are connected with wireless LAN, check whether the machine can connect to the network.
 - ▶ If you cannot connect to a wireless LAN(P. 1413)

→ If you do not know the IP address that was set.

- Press  (Counter/Device Information) or the [Counter/Device Information] key (models with an upright control panel) and check the IP address.
 - ▶ Items Displayed on the <Home> Screen(P. 335)
 - ▶ Control Panel(P. 33)
- If you want to know the details of the settings or change the settings, press  (Settings/Registration) and check the IP address.
 - ▶ Setting an IP Address(P. 278)

→ **Cannot change from wired LAN to wireless LAN or wireless LAN to wired LAN.**

- Did you also switch the LAN setting from the control panel of the machine? You cannot change the connection method of the machine unless you do so.
▶ **Selecting the Network Connection Method(P. 267)**

→ **If you do not know the SSID and network key of the wireless LAN router to connect to or the SSID is not displayed on the screen.**

- Check whether the SSID is displayed on the wireless LAN router or its box.
▶ **Checking the SSID and Network Key(P. 277)**

→ **The SSID of the wireless LAN router to connect to is not displayed in the list of access points.**

- Check whether the SSID of the wireless LAN router that you made a note of is correct.
▶ **Checking the SSID and Network Key(P. 277)**
- If the SSID of the wireless LAN router is not disclosed (if it is using the stealth function*), set the wireless LAN router to disclose the SSID.
* This function prevents the SSID of a wireless LAN router from being automatically detected.
- Check whether the machine is connected to the network.
▶ **If you cannot connect to a wireless LAN(P. 1413)**

If you cannot connect to a wireless LAN



Check the status of the computer.

- Is setup of the computer and wireless LAN router complete?
- Are any of cables of the wireless LAN router (power cable, LAN cable, etc.) disconnected?
- Is the wireless LAN router turned ON?

If the problem is still not resolved:

- Turn all the devices off, and then on again.
- After waiting a while, check whether you can connect to the network.



Check whether the machine is turned ON.

If the machine is turned ON, turn it OFF, and then ON again.



Check the installation location of the machine and wireless LAN router.

- Are the machine and wireless LAN router too far away from each other?
- Is there an obstacle such as a wall between the machine and wireless LAN router?
- Are there any devices that emit electromagnetic waves nearby, such as a microwave or digital cordless telephone?

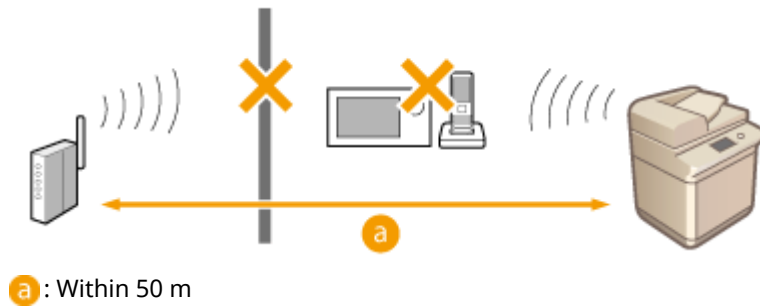

Specify the following settings again.

- ▶ Setting Up the Connection Using WPS Push Button Mode(P. 272)
- ▶ Setting Up the Connection Using WPS PIN Code Mode(P. 273)
- ▶ Setting Up Connection by Selecting a Wireless Router(P. 274)
- ▶ Setting Up a Connection by Specifying Detailed Settings(P. 275)

NOTE

If settings require manual entry

- If the wireless LAN router is set as follows, perform manual entry (▶ Setting Up a Connection by Specifying Detailed Settings(P. 275)):
 - ANY rejection* is enabled.
 - An automatically generated WEP key (hexadecimal) is set.
 - The stealth function is enabled.
- * A wireless LAN router function for refusing connections if the device trying to connect has "ANY" or "blank" set for the SSID.

If it is necessary to change the settings on the wireless LAN router side

- If the wireless LAN router is set as follows, change the settings on the router side:
 - MAC address filtering is set.
 - WEP is selected or WPA/WPA2 encryption is set for the TKIP when communicating only with IEEE 802.11n.

Problems with Security

961F-OWL

- ▶ The settings in <Settings/Registration> are not restored even though the check box is deselected in the security policy settings.(P. 1415)
- ▶ Cannot import security policy settings.(P. 1415)
- ▶ A security administrator password entry screen is displayed even though no password is set.(P. 1415)

The settings in <Settings/Registration> are not restored even though the check box is deselected in the security policy settings.

- Items changed with security policy settings applied are not restored simply by deselecting the check box. Deselect the check box, and change the corresponding settings from the  (Settings/Registration) button, or from <Settings/Registration> in the Remote UI.

Cannot import security policy settings.

- Have you set a different security policy password from the source device? Remove the password in the destination device or set the same password as the source device.
 - ▶ **Using a Password to Protect the Security Policy Settings(P. 793)**

A security administrator password entry screen is displayed even though no password is set.

- If you import security policy settings, the same password is set for the destination device if a security policy password is set in the source device. Check the password of the source device.

Problems with MEAP

961F-OWR

- ▶ Automatic retrieval of domain information and service information retrieval fail when Windows Server firewall is set.(P. 1416)
- ▶ User authentication fails when Windows Server firewall is set.(P. 1416)
- ▶ Cannot log in to Active Directory.(P. 1416)
- ▶ Startup is slow.(P. 1417)
- ▶ Login is slow.(P. 1417)

Automatic retrieval of domain information and service information retrieval fail when Windows Server firewall is set.

→ DNS server* communication is blocked by the firewall.

- Stop blocking the default port 53.

* A DNS server usually performs communication with the UDP protocol using port 53, but the data may be processed with the TCP protocol if it exceeds a certain size.

User authentication fails when Windows Server firewall is set.

→ Communication using LDAP server authentication is blocked by the firewall.

- Stop blocking port 389.

* Communication is performed with the TCP protocol using port 389 by default. If you have changed the port, stop blocking the new port.

Cannot log in to Active Directory.

→ Did you perform user registration before installing Active Directory?

- After installation, accounts are automatically generated in the "Users" folder, but since a user logon name is not set, you cannot log in to the Active Directory of User Authentication because the user information cannot be retrieved even if a key is generated. Perform the following operations to change the settings.

- 1** Start the "Active Directory Users and Computers." management tool of Active Directory.
- 2** Right-click the user registered before installing Active Directory.
- 3** Select [Properties] from the pop-up menu.
- 4** Select the [Account] tab, specify [User logon name], and click [OK].
- 5** Right-click the user you changed the settings for.
- 6** Select [Reset Password] from the pop-up menu.
- 7** Enter the new password in the [Reset Password] dialog box, and click [OK].

Startup is slow.

- A host that name resolution cannot be performed for (an address that cannot be identified) is set in the SRV record retrieved with automatic domain retrieval.
- The DNS server set in the machine is not found or cannot communicate. Check the settings and communication environment.
- If a standby time for network connections is set on the machine, change the setting.
 - ▶ **Setting the Wait Time When Connecting to a Network(P. 288)**

Login is slow.

- Check whether the domain name specified in the DNS server that is set can perform name resolution (or whether the address can be identified), and make changes if necessary.
- The DNS server set in the machine is not found or cannot communicate. Check the settings and communication environment.
- Multiple domain controllers manage the specified domain. Login may be slow because User Authentication performs the authentication process for all domain controllers until login succeeds. Check the domain controller and make changes if necessary.

Other Problems

961F-OWS

- ▶ **Cannot press a button, select an item, or an item is not displayed.(P. 1418)**
- ▶ **Some settings imported from another device are not reflected.(P. 1418)**
- ▶ **Log files are garbled.(P. 1418)**
- ▶ **Log events are not recorded even though log collection was started.(P. 1418)**
- ▶ **The setting for long-strip originals is not displayed.(P. 1419)**
- ▶ **The setting for K-size paper is not displayed.(P. 1419)**
- ▶ **The Advanced Space is open to public via SMB, but it cannot connect.(P. 1419)**
- ▶ **The Advanced Space is open to public via WebDAV, but it cannot connect via WebDAV.(P. 1419)**

Cannot press a button, select an item, or an item is not displayed.

- Some settings can only be used by the administrator. They cannot be used by general users.
 - ▶ **Settings/Registration(P. 1054)**
- The system administrator limits the functions that general users can use to prevent unauthorized use, and restricts the use of functions.
- The functions that can be used with User Authentication are managed by the administrator. These functions can be used by logging in using an ID with access privileges.
 - ▶ **Logging into the Machine(P. 355)**
- Functions cannot be used because the optional equipment or system options that they require are not installed.
- The buttons displayed on the screen have been changed. Press ◀ or ▶ at the bottom of the screen to switch the display, or press <Options> and search for the desired button. For a Basic Features screen, press <Options> and search for the desired button.
 - ▶ **Customizing the <Home> Screen(P. 363)**
 - ▶ **Customizing the Basic Features Screen(P. 370)**
- The settings are managed with security policy settings. To change the settings, it is necessary to log in to the Remote UI with administrator privileges.
 - ▶ **Configuring the Security Policy Settings(P. 795)**

Some settings imported from another device are not reflected.

- If a security policy is set, settings that violate the security policy cannot be imported.

Log files are garbled.

- When opening CSV files with Microsoft Excel, the content may not be recognized as text strings and may become garbled as a result. If this happens, open the files with a CSV file editor or text editor.

Log events are not recorded even though log collection was started.

- Results may not be reflected in a log file if it is retrieved immediately after log collection is started. Since it takes some time to collect logs, retrieve the log file again after waiting a while.

The setting for long-strip originals is not displayed.

- You can use long-strip originals by changing the machine settings. For more information, contact your dealer or service representative.

The setting for K-size paper is not displayed.

- You can use K-size paper by changing the machine settings. For more information, contact your dealer or service representative.

The Advanced Space is open to public via SMB, but it cannot connect.

- Check the SMB Authentication Settings for the SMB Server and Authentication Management for the Advanced Space.
 - ▶ **Making SMB Settings(P. 294)**
 - ▶ **Setting Advanced Space to Public(P. 321)**
- For information regarding SMB Server and Advanced Space authentication settings, see the following table:

 (Settings/Registration)			Authentication	
Preferences → Network → TCP/IP Settings → SMB Server Settings		Function Settings → Store/Access Files → Advanced Space Settings → Authentication Management	Log In Using Touch Panel Display	Log In Using Client Computer
Use SMB Server	Use SMB Authentication			
On	On	On	Required	Required
On	Off	On	Required	No access
On	Off	Off	Not required	Not required
On	On	Off	Not required	Required

The Advanced Space is open to public via WebDAV, but it cannot connect via WebDAV.

- Check the ON/OFF setting for the WebDAV Server, Authentication Management for the Advanced Space, and Authentication Type for the WebDAV Server.
 - ▶ **Making WebDAV Settings(P. 298)**
 - ▶ **Setting Advanced Space to Public(P. 321)**
- For information regarding WebDAV Server and Advanced Space authentication settings, see the following table:

 (Settings/Registration)			Authentication	
Preferences → Network → TCP/IP Settings → Use WebDAV Server	Function Settings → Store/Access Files → Advanced Space Settings		Log In Using Touch Panel Display	Log In Using Client Computer
	Authentication Management	WebDAV Server Settings → Authentication Type		
On	On	Basic	Required	Required
On	On	Off	Required	No access
On	Off	Basic	Not required	Not required
On	Off	Off	Not required	Not required

A Message or a Number Starting with "#" (an Error Code) Is Displayed

961F-0WU

If a message is displayed on the screen of the machine or the Remote UI, or a number starting with "#" (an error code) is displayed on the details screen for job log or a communication management report, refer to the following to check the remedy.

- ▶ **A Message Saying to Contact a Local Authorized Canon Dealer Is Displayed(P. 1422)**
- ▶ **Countermeasures for Each Message(P. 1425)**
- ▶ **Countermeasures for Each Error Code(P. 1469)**

A Message Saying to Contact a Local Authorized Canon Dealer Is Displayed

961F-0WW

If the machine cannot operate normally due to a problem, a message is displayed on the touch panel display. Check the reference according to the displayed message.

- ▶ When a message saying to contact a your dealer or service representative is displayed(P. 1422)
- ▶ When the <Limited Function Mode> button is displayed(P. 1423)
- ▶ When the <This function is currently unavailable. You can use other functions from [Home].> message is displayed(P. 1423)
- ▶ When the <Color printing is currently unavailable.> message is displayed(P. 1424)

When a message saying to contact a your dealer or service representative is displayed

1 Restart the machine.

- Press the power switch to turn the power OFF (▶Turning OFF the Machine(P. 36)), wait for longer than 10 seconds after the Main Power indicator turns off, and then turn the power ON again (▶Turning ON the Machine(P. 35)).

! IMPORTANT

- Note that data waiting to be processed is erased when you turn the power OFF.

2 If the message is still displayed, prepare the following information.

- Product name
- The dealer or service representative where you purchased the machine
- The problem (the specific operation you performed and the result and symptom, etc.)
- Code displayed on the touch panel display
Multiple codes may be displayed.



3 Turn the power of the machine OFF, pull out the power plug, and contact your dealer or service representative.

! WARNING

- Do not connect or disconnect the power cord with wet hands, as this may result in electrical shock.

CAUTION

- Always grasp the power plug when disconnecting the power cord. Pulling on the power cord may expose or snap the core wire, or otherwise damage the power cord. If the power cord is damaged, this could cause current to leak, resulting in a fire or electrical shock.

When the <Limited Function Mode> button is displayed

You can continue to use the machine before resolving the problem by limiting functions.

1 Press <Limited Function Mode>.

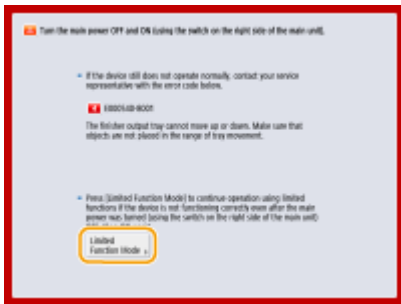

2 Press <Yes> to restart the machine.

- The machine is restarted with the Limited Functions mode.
- When the problem is resolved, the message prompting you to contact your local authorized Canon dealer disappears from the bottom left of the screen.

Functions available when the Print function is limited:

Fax, Scan, Scanner, Web Access, Tutorial/FAQ, MEAP Application, Quick Menu, Status Monitor, Remote UI

Functions available when the Scan function is limited:

Access Stored Files, Fax/I-Fax Inbox, Print, Web Access, Tutorial/FAQ, MEAP Application, Quick Menu, Status Monitor, Remote UI

NOTE

- Depending on the error, the process for storing system information is performed after the error occurs. Do not turn OFF the machine until the process is complete.

When the <This function is currently unavailable. You can use other functions from [Home].> message is displayed

This message is displayed when you select a restricted function while in limited function mode or if the Print or Scan function is restricted. Select a different function from the <Home> screen. For the available functions, see ( **When the <Limited Function Mode> button is displayed(P. 1423)**).

When the <Color printing is currently unavailable.> message is displayed

You cannot use the color printing function because use of it is restricted. However, you can use the black and white printing function. Change the settings related to printing or copying as necessary.

Countermeasures for Each Message

961F-0WX

If an error occurs during scanning or printing, or if a problem occurs with the network connection or settings, a message appears on the machine display or the Remote UI screen. For details about each message and solutions to the problems, refer to the messages below. Also, if a six-digit number is displayed when you are logging in, see **▶If a six-digit number is displayed when you are logging in(P. 1462)** .

23 MEMORY FULL

There is insufficient memory to register overlay forms and external characters, etc.

- Cancel printing (**▶Canceling Printing(P. 600)**), initialize the printer to increase the free memory, and then try printing again. However, note that initializing the printer will erase all the print data in the memory of the machine. For more details, see Setting the Machine (PS/PCL/UFR II Printer) via the online manual Web site.
- Press <Skip Error>, and continue printing. However, the data that could not be registered due to a lack of memory will not be printed.

27 JOB REJECT

The specified emulation does not exist.

- Specify emulation that the machine supports. For more details, see Setting the Machine (PS/PCL/UFR II Printer) via the online manual Web site.
- Press <Skip Error> to skip the printing that an error occurred for. You can perform the following printing.

33 WORK FULL

Could not print because the dedicated work memory was insufficient.

- Cancel printing (**▶Canceling Printing(P. 600)**), initialize the printer to increase the free memory, and then try printing again. However, note that initializing the printer will erase all the data in the memory of the machine. For more details, see Setting the Machine (PS/PCL/UFR II Printer) via the online manual Web site.
- Press <Skip Error>, and continue printing. However, the data for which an error was displayed will not be printed correctly. Also note that registered data such as overlay forms and macros may be deleted.

52 IMAGEMODE REJECT

Data that cannot be processed was sent while printing an image.

- Press <Skip Error> to skip the printing that an error occurred for. However, the data for which an error was displayed will not be printed.
- Perform printing again using a printer driver that supports the data format of the image.

The Active Directory site information is invalid. Contact the system manager.

The site information of Active Directory is not set correctly.

- Check whether [Timing of Site Information Retrieval:] and [Site Access Range:] are set correctly in [Use of Access Mode within Sites:].

Could not verify CRL.

Could not confirm the CA certificate of the certificate authority that issued the certificate revocation list (CRL).

- Register the CA certificate of the certificate authority that issued the certificate revocation list (CRL).
 ▶ **Registering a CA Certificate(P. 921)**

D1 Replot Buffer Full

Could not redraw because data could not be registered to the replot buffer.

- Press <Skip Error>, and continue printing. However, the data that caused the error will not be printed correctly. For information on the replot buffer, see Print.

D1 Div. Print. Bffr Full

Could not perform divided printing because data could not be registered to the buffer for divided printing.

- Cancel printing (▶ **Canceling Printing(P. 600)**), set <Divide Mode> to <No> and <Enlarge/Reduce> to <Auto> in the HP-GL setup menu, specify the output paper size, and perform printing again. However, the data will be enlarged/reduced when printed. For more details, see Print.
- Press <Skip Error>, and continue printing. However, the data that could not be registered will not be printed correctly. For information on divided printing, see Print.

D1 Polygon Buffer Full

Could not draw because data could not be registered to the polygon buffer.

- Press <Skip Error>, and continue printing. However, the data that could not be registered will not be printed correctly. For information on the polygon buffer, see Print.

D0-nn error (nn is two alphanumeric characters)

The printer stopped operating normally due to an unknown problem.

- Restart the machine. Press the power switch to turn OFF the machine (▶ **Turning OFF the Machine(P. 36)**). When 10 or more seconds have elapsed after the main power indicator turned off, turn ON the machine again (▶ **Turning ON the Machine(P. 35)**). If the message is still displayed after restarting the machine, make a note of the message and contact your dealer or service representative.

Could not send the new PIN via e-mail. Check the settings.

Could not send an e-mail for resetting the PIN.

- Check whether an e-mail address is set.
- Check the e-mail settings and network settings.

FF FONT FULL

Could not register font information in the font table because there were too many fonts to register.

- Cancel printing (▶ **Canceling Printing(P. 600)**), initialize the printer to increase the free memory, and then try printing again. However, note that initializing the printer will erase all the data in the memory of the machine. For more details, see Setting the Machine (PS/PCL/UFR II Printer) via the online manual Web site.

- Press <Skip Error>, and continue printing. However, the data that could not be registered will not be printed correctly.

FM DL SIZE ERROR n (n is a single alphanumeric character)

The printer stopped operating normally due to an unknown problem.

- Restart the machine. If the message is still displayed after restarting the machine, make a note of the message and contact your dealer or service representative.

FM DL SCALE ERROR n (n is a single alphanumeric character)

The printer stopped operating normally due to an unknown problem.

- Restart the machine. If the message is still displayed after restarting the machine, make a note of the message and contact your dealer or service representative.

FM DL FONT MEMORY FULL

The printer stopped operating normally due to an unknown problem.

- Restart the machine. If the message is still displayed after restarting the machine, make a note of the message and contact your dealer or service representative.

FM FILE ACCESS ERROR

The printer stopped operating normally due to an unknown problem.

- Restart the machine. If the message is still displayed after restarting the machine, make a note of the message and contact your dealer or service representative.

FM SC WORK MEM. ERROR n (n is a single alphanumeric character)

The printer stopped operating normally due to an unknown problem.

- Restart the machine. If the message is still displayed after restarting the machine, make a note of the message and contact your dealer or service representative.

FM ALIGNMENT ERROR

The printer stopped operating normally due to an unknown problem.

- Restart the machine. If the message is still displayed after restarting the machine, make a note of the message and contact your dealer or service representative.

FM FONT PARSE ERROR

The printer stopped operating normally due to an unknown problem.

- Restart the machine. If the message is still displayed after restarting the machine, make a note of the message and contact your dealer or service representative.

FM FONT MEMORY FULL

The printer stopped operating normally due to an unknown problem.

- Restart the machine. If the message is still displayed after restarting the machine, make a note of the message and contact your dealer or service representative.

FM WORK MEMORY ERROR

The printer stopped operating normally due to an unknown problem.

- Restart the machine. If the message is still displayed after restarting the machine, make a note of the message and contact your dealer or service representative.

IEEE 802.1X error. Set the correct authentication information.

The client authentication information is not set correctly.

- Check whether the authentication method and authentication information (key and certificate, user name and password, and CA certificate) are set correctly.

IEEE 802.1X error. No reply from the destination.

An error occurred while communicating with the authenticator.

- Check whether the authenticator (LAN switch) and RADIUS server are set correctly.

IEEE 802.1X error. Cannot analyze the certificate.

Failed to analyze the server certificate sent from the RADIUS server.

- Check the content of the server certificate of the RADIUS server.

IEEE 802.1X error. The certificate is incorrect.

An error occurred when using the server certificate sent from the RADIUS server as a CA certificate for validation.

- Check the content of the server certificate of the RADIUS server and the CA certificate registered in the machine.
 ▶ **Registering a CA Certificate(P. 921)**

IEEE 802.1X error. The certificate has expired.

The server certificate sent from the RADIUS server has expired.

- Check the expiration date of the server certificate of the RADIUS server.

IEEE 802.1X error. Change the authentication password.

The password has expired.

- Set a new password.

IEEE 802.1X error. Check the authentication settings.

The authentication method set in the machine and the authentication method set in the RADIUS server do not match.

- Check the authentication method set in the machine and the RADIUS server, and set the correct authentication method.

Set the IP address.

The IP address of the machine is not set.

- Set the IP address in <TCP/IP Settings>, and restart the machine.
 **Setting an IP Address(P. 278)**

Cannot set PDF (Format to PDF/A) as default. All other settings have been set.

You tried to register a default value for <Scan and Send>, <Scan and Store>, or <Access Stored File>, while the <Format PDF to PDF/A> settings for the <PDF> file format was changed.

- You cannot register default settings if you change the <Format PDF to PDF/A> setting for the <PDF> file format. Register default settings after changing settings other than the <Format PDF to PDF/A> setting.

TLS Error

The WebDAV server does not support TLS encrypted communication.

- Set TLS on the WebDAV server side, according to your environment.

The proxy server does not support TLS encrypted communication.

- If the WebDAV client connects to the internet via a proxy, set TLS on the proxy server side.



Cannot delete the default key because it is in use by TLS or other settings. Check the settings.

The key and certificate you are trying to delete is being used in TLS encrypted communications or the Restrict Receiving for Each Function mode of Device Information Distribution.



- Set all TLS settings to <Off> to stop TLS encrypted communication. Also set all settings in <Restrict Receiving for Each Function> to <On>.
 **<Device Information Distribution Settings>(P. 1332)**

TCP/IP Error

Could not automatically retrieve the address with DHCP and Auto IP.

- If the address cannot be automatically retrieved with DHCP and Auto IP, <IP Address> in <IPv4 Settings> is set to 0.0.0.0. Set the correct IPv4 address. In addition, if you selected <Wired LAN + Wireless LAN> or <Wired LAN + Wired LAN> in <Select Interface>, correctly configure the IPv4 address of the sub line.
 **Setting an IPv4 Address(P. 279)**
 **<IP Address Settings>(P. 1110)** (<Sub Line Settings>)

0.0.0.0 is set as a fixed IPv4 address in <IP Address> in <IPv4 Settings>.

- Set the correct IPv4 address.
 **Setting an IPv4 Address(P. 279)**
 **<IP Address Settings>(P. 1110)** (<Sub Line Settings>)

The IPv6 address is not set correctly.

- Check the following. It may take several minutes until the stateless address is decided.
- Check whether <Use IPv6> is set to <On> in <IPv6 Settings>.
- When using a stateless address or DHCPv6, check whether each address has been retrieved.
- If the address has not been retrieved, check the settings of the router and the DHCPv6 server.
 **Setting an IPv6 Address(P. 281)**

The address of the DNS server is not set correctly.

- Check whether the address of the DNS server is set correctly in <IPv4> or <IPv6>.
 - ▶ **Making DNS Settings(P. 289)**

Could not send to the TCP/IP protocol stack.

- Check whether the IPv4 address or IPv6 address is set correctly in <IPv4 Settings> or <IPv6 Settings>. In addition, if you selected <Wired LAN + Wireless LAN> or <Wired LAN + Wired LAN> in <Select Interface>, correctly configure the IPv4 address of the sub line.
 - ▶ **Setting an IPv4 Address(P. 279)**
 - ▶ **Setting an IPv6 Address(P. 281)**

Out of resources. Wait a moment, then try again.

TCP/IP resources were insufficient while continuously sending or after continuously sending with FTP or Windows (SMB).

- Try again after waiting a while.

Check the TCP/IP.

The TCP/IP of the machine is not operating.

- Check the IP address, DHCP, and Auto IP settings in <TCP/IP Settings>.
 - ▶ **Setting an IPv4 Address(P. 279)**
- If you selected <Wired LAN + Wireless LAN> or <Wired LAN + Wired LAN> in <Select Interface>, check the settings for the IP address and DHCP in <Sub Line Settings>.
 - ▶ **<IP Address Settings>(P. 1110)** (<Sub Line Settings>)

Check the TCP/IP. (Main Line)

The IP address of the main line is set to "0.0.0.0".

- Set a different IP address.
 - ▶ **Setting an IPv4 Address(P. 279)**

Check the TCP/IP. (Sub Line)

The IP address of the sub line is set to "0.0.0.0".

- Set a different IP address.
 - ▶ **Setting the IPv4 Address of the Sub Line(P. 284)**

Universal Print: A server communication error occurred.

The machine is not connected to the network correctly.

- Check the machine and network settings, and try connecting again.

Could not communicate because a server error occurred.

- Check whether the server is operating normally.

Communication with the server is blocked due to firewall settings.

- Configure the firewall settings to allow communication.

Universal Print: Could not authenticate with server.

An error has occurred during server authentication.

- Restart the machine. If the message still appears after restarting the machine, make a note of the message and contact your dealer or service representative.

Universal Print: The certificate has expired.

The expiration date of the certificate has expired.

- Delete this machine from Azure Active Directory and the computer, re-register the machine, and then update the certificate.

Universal Print: An internal error occurred.

The printer stopped operating normally due to an unknown problem.

- Restart the machine. If the message still appears after restarting the machine, make a note of the message and contact your dealer or service representative.

Universal Print: The printer is not registered.

This machine was deleted from Azure Active Directory and could not be communicated with.

- Re-register this machine in Azure Active Directory.

Check the wired LAN adapter connected to the USB port.

Multiple USB-LAN adapters are connected, or the USB-LAN adapter is not connected/recognized.

- Check the connection of the USB-LAN adapter.
 - ▶ **Connecting to a Wired LAN for the Sub Line(P. 269)**
- If you reconnected the USB-LAN adapter, restart the machine.
 - ▶ **Front Side(P. 20)**

XPS Print Range Error

There are no pages that can be processed in the specified range for printing.

- Specify a correct page range.

XPS Image Data Error

Failed to extend the image data.

- Replace the image data in the XPS file and try printing again.

XPS Spool Memory Full

There is insufficient memory to process the XPS data.

- Restart the machine and try printing again. If you still cannot print, divide the pages into multiple files and print them separately.

XPS Data Error

An invalid command is specified due to corrupt data, etc. and processing cannot continue.

- Perform printing again using XPS data in a format supported by the machine.

XPS Unsupport Image Err

An unsupported data format is included.

- Convert the data to the TIFF or JPEG format and try printing again.

XPS Font Error

Failed to analyze the font data.

- Replace the font data in the XPS file and try printing again.

XPS Page Data Error

Cannot generate pages because the descriptions are incorrect.

- Perform printing again using XPS data in a format supported by the machine.

XPS Memory Full

There is insufficient memory to process the XPS data.

- Press <Skip Error>, and continue printing. However, pages that include the data that caused the error may not be printed correctly.

You do not have privileges to access the XXX page.

You tried to log in as a user without the required privileges.

- Log in as a user with the required privileges.

The account has expired. Contact the system manager.

The certificate may have expired.

- Confirm the expiration date of for the certificate registered in the machine. If the certificate has expired, register a certificate within the validity period.

▶ **Registering a Key and Certificate for Network Communication(P. 920)**

The expiration date of the account has expired.

- Confirm the expiration date of the corresponding account.

Access point connection error. Check Wireless LAN Information.

The access point could not be found.

- Check the wireless LAN settings.
▶ **Check the settings and information of the wireless LAN(P. 271)**

AP Mode: Ended due to an error.

No data was sent or received between the machine and the connected mobile device for over three minutes.

- Check the connection between the machine and the mobile device.

AP Mode: Ended because no other device could be found.

Cannot find a mobile device capable of connection.

- Check the network settings of the mobile device, and then connect by holding it near the machine. Depending on your mobile device, the machine may not operate correctly. If you cannot successfully connect, contact your dealer or service representative.

AP Mode: Max no. of devices that can connect has been reached.

Cannot connect because the number of mobile devices which can connect simultaneously has reached the upper limit.

- Disconnect any unnecessary mobile devices, or wait until other mobile devices have disconnected.

AP Mode: Connected to other devices.

Cannot connect because the machine is already connected to another device.

- Wait until the connection to the other device has terminated.

Cannot start this application because system resources (memory, threads, sockets, file descriptors, disk space, or screen size) required to start the application may not be available. <Resources>

The application cannot be used because the required system resources, such as memory and disk space, may not be able to be secured.

- You may be able to use the desired application by closing other applications.

Cannot download application logs because application logs do not exist.

The application log does not exist.

- The operation cannot be performed because the log does not exist. Use the [Back] button to return to the previous page.

The contents of the file for the application to install are incorrect or information is missing. Check the file.

The application could not be installed because the content of the specified file is invalid or information is insufficient.

- An application cannot be installed if the content of the file is invalid. Check the content of the file, and if there is no problem, contact the developer of the application or the support department for the application.

The contents of the file for the license to install are incorrect or information is missing. Check the file.

The license file could not be installed because the content of the specified file is invalid or information is insufficient.

- A license file cannot be installed if the content of the file is invalid. Check the content of the file, and if there is no problem, contact the developer of the application or the support department for the application.

Could not delete application logs because an error occurred.

The log could not be deleted because an unknown error occurred.

- Use the [Back] button to return to the previous page.

Could not download application logs because an error occurred.

The log could not be downloaded because an unknown error occurred.

- Use the [Back] button to return to the previous page.

Could not delete authentication information because an error occurred.

The authentication information could not be deleted because an unknown error occurred.

- Contact your dealer or service representative.

Could not set authentication information because an error occurred.

The authentication information could not be set because an unspecified error occurred.

- Contact your dealer or service representative.

An error occurred. Contact the system manager.

The selected user has already been deleted.

- Log in as the Administrator and register the button again.

An unexpected system error occurred.

- Check the operations and log in again. If you still cannot log in, consult your system administrator.

No response.

Could not send because an error occurred in the server.

- Check whether the server is operating normally.

The machine is not connected to the network correctly.

- Check the machine and network settings, and try connecting again.
 **Setting up the Network Environment(P. 263)**

Could not send e-mail or an I-fax because an error occurred in TCP/IP.

- Check the machine and network settings, and try connecting again.
 **Setting up the Network Environment(P. 263)**

The waste toner is nearly full. Replacement is not yet needed.

The waste toner container is almost full.

- You can continue printing for a while, but you should have a new one available so that you can make replacement as soon as it is needed. If you decide to replace the waste toner container at the time when this message is displayed, press the icon at the bottom right of the screen to display a motion video to give the instructions for waste toner container replacement. Follow these instructions to replace the waste toner container.

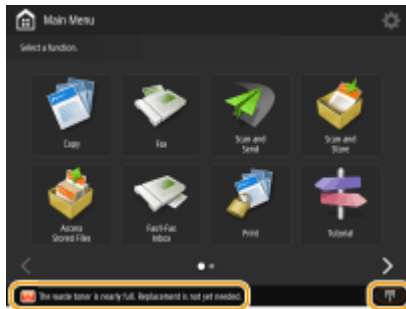

Replace the waste toner container.

The waste toner container is full, so printing is not possible any longer.

- Follow the instructions on the screen to replace the waste toner container.



Cannot recall the settings because the function for the button does not exist.

A personal button or shared button that includes a function not supported by the machine was used.

- If you have imported personal buttons/shared buttons registered in another imageRUNNER ADVANCE series device, buttons not supported by the machine may be included. Register the personal buttons/shared buttons again in the machine.

Cannot recall the settings because the function for the button is disabled. Enable the function, then try again.

The operation could not be executed by pressing the button because the function to use has been stopped.

- Press the button after enabling the function that was stopped to be used.

Synchronize Custom Settings: Log in again for synchronization.

There is an inconsistency between the synchronization data of the server machine and that of the client machine synchronizing custom settings.

- Log out, and then log in again.

Synchronize Custom Settings: Some settings are restricted.

The client machine was synchronizing custom settings, but the server machine is turned OFF or is not operating normally.

- Turn the server machine ON.
- If the server machine is operating normally, check that its network cable is connected before checking the network settings.

NOTE

- Data may not be able to be synchronized correctly while this message is displayed, but can be synchronized after the problem is resolved.

Synchronize Custom Settings: An error occurred.

An error occurred during synchronization startup.

- Confirm that the address of the destination server is correct for the synchronization of custom settings (client).
- If the synchronization of custom settings (client) is complete, restart synchronization.
- Restart the machine.
- If the problem is not resolved even after restarting the machine, check the followings.
 1. You can ping the IP address set for the destination
 2. The address of the destination server is correctly displayed

Synchronize Custom Settings: Enabling synchronization...

Processing to begin synchronization of custom settings is being performed.

- Wait until processing is complete.

Synchronize Custom Settings: Server authentication error.

Authentication with the server machine could not be achieved.

- Check that the authentication user ID and new password for the synchronization of custom settings (client) are the same as the authentication user ID and password with administrator privileges in the server machine.
- If the synchronization of custom settings (client) is complete, restart synchronization.
- Restart the machine.

Synchronize Custom Settings: Cannot find the server.

The server machine for synchronization of custom settings could not be found using Auto Search.

- Confirm that the server machine is turned ON.
- If the server machine is operating normally, check that its network cable is connected before checking the network settings.
- Confirm the usable conditions for Auto Search. **▶Starting Setting Synchronization(P. 991)**
- Without using Auto Search, manually specify the server address of the destination for the synchronization of custom settings (client), and the search depth (router).
- If the synchronization of custom settings (client) is complete, restart synchronization.

- Restart the machine.

Synchronize Custom Settings: Cannot identify the server.

Multiple server machines for the synchronization of custom settings were found using Auto Search.

- Manually specify the server machine or shut down all unnecessary server machines that are currently running so that only one remains.

When specifying the server machine manually

- Without using Auto Search, manually specify the server address of the destination for the synchronization of custom settings (client), and the search depth (router). [▶Starting Setting Synchronization\(P. 991\)](#)

When shutting down unnecessary servers that are currently running

- Even if the network settings of the server machine include both IPv4 and IPv6, if IPv6 is prioritized and the client machine disables IPv6, the client machine cannot connect via search. Enter the IPv4 address for the destination server address.
- If the synchronization of custom settings (client) is complete, restart synchronization and then restart the machine.

Check the covers.

The cover of optional equipment is open.

- Check whether the covers of optional equipment are closed.

An error occurred when auto exporting the audit log.

The data could not be exported because a server error occurred.

- Check that the server is functioning normally.

The machine is not connected to the network correctly.

- Check the settings of the machine and the network, and try connecting again.

The automatic export settings are incorrect.

- Check that the automatic export settings are correct ([▶Exporting Logs Automatically\(P. 942\)](#)).

Failed to generate Device Signature Key. Set the e-mail address in Communication Settings.

To use device signatures, you must first configure the e-mail address of the machine.

- Configure the e-mail address of the machine ([▶Setting E-mail/I-Fax Communication\(P. 316\)](#)), and then generate a key for device signatures ([▶Generating a Device Signature Certificate\(P. 896\)](#)).

The function may be stopped. Buttons could not be imported.

When importing data, buttons with functions not supported by the machine were included.

- Check whether all the buttons have been imported to the machine.

Routing registration failed. Check Static Routing Settings.

There is an entry that routing table registration failed for in the static routing settings.

- Check the registered destination address and gateway address, and specify the correct settings.

▶ **Setting Static Routing(P. 307)**

Remove the original from the platen glass.

An original remains on the platen glass.

- Remove the original from the platen glass, and place another original.

Original scanning area (feeder) is dirty.

The document feed scanning area (on the feeder side) is dirty.

- Clean the document feed scanning area.
▶ **Cleaning the Feeder(P. 88)**

Original scanning area (thin glass strip) is dirty.

The document feed scanning area (the long and thin glass strip) is dirty.

- Clean the document feed scanning area.
▶ **Cleaning the Feeder(P. 88)**

Return the originals to their correct order, then press the [Start] key.

Scanning stopped because an unknown problem occurred in the feeder.

- Scan the original again from the first page.
- If the message "Originals may have been fed diagonally. Check the following:" is displayed, follow the message to clear the jam. If the original was mistakenly detected as a stapled document, press <Set Sensor of Diagonally Fed Originals to Off Temporarily> and scan the document again from the first page.

Return the originals to their correct order, then press the [Start] key. (The data size of the scanned original exceeds the limit. Settings will be automatically corrected and the originals will be scanned again.)

Scanning was canceled because the data of the scanned document exceeded the maximum size that can be handled by the machine.

- Scan the original again from the first page. If you still cannot scan the original, you may be able to scan by lowering the setting in <Sharpness>, and setting <Original Type> to <Text>.

The device is currently being used by another user. Wait a while, and then try to perform the operation again.

You cannot use the machine when it is being used by another user.

- Try again after waiting a while.

The number of search results exceeds the limit. Change search conditions, then try again.

Destinations exceeding the maximum number of search results were found.

- Narrow the search conditions and try searching again.
- Increase the maximum number of search results in <Max Addresses to Search> in <Register LDAP Server>.
▶ **Registering the LDAP Server(P. 299)**

The search condition includes characters that cannot be used with the selected server.

"\" is used in the search conditions.

- Remove the "\" from the search conditions and try searching again.

If an uneven number of "(" or ")" are included or an "*" is included inside parentheses, search conditions are not established.

- Set a correct combination of characters, and try searching again.

If <LDAP Server Version and Character Code> is set to <ver.2 (JIS)>, only ASCII code (0x20 to 0x7E) characters can be used.

- Remove the invalid characters and try searching again.

An error occurred when verifying.

The certificate is invalid.

- Register the correct certificate and specify the settings again.
 - ▶ **Configuring the Key and Certificate for TLS(P. 864)**
 - ▶ **Registering a Key and Certificate for Network Communication(P. 920)**

This CRL is invalid.

The certificate revocation list (CRL) may be corrupt, or a signing algorithm not supported by the machine may be used.

- Register the correct certificate revocation list (CRL).
 - ▶ **Registering a Certificate Revocation List (CRL)(P. 924)**

This CRL has expired.

The start date for the certificate revocation list (CRL) may be set to a date in the future.

- Check the start date of the certificate registered in the machine. If the start date is set to a date in the future, use the certificate on a day after that date.
 - ▶ **Registering a Certificate Revocation List (CRL)(P. 924)**

The date and time set on the machine may be incorrect.

- Check the date and time setting of the machine.
 - ▶ **Setting the Date/Time(P. 261)**

This application does not support the security policy function.

The MEAP application you tried to start may not operate according to the security policy settings of the machine.

- Check the security functions of the application to see whether it can be used.

Cannot register because the algorithm of this key is not supported.

You tried to register the key and certificate file of an unsupported encryption algorithm.

- Register the key and certificate file of a supported encryption algorithm.
 - ▶ **Registering a Key and Certificate(P. 920)**
 - ▶ **System Specifications(P. 1577)**

Cannot set as the default key because this key is corrupted or invalid.

The key specified for the machine cannot be set because it is corrupted.

- Register the key again.
 - ▶ **Registering a Key and Certificate for Network Communication(P. 920)**
 - ▶ **Registering a Key and Certificate(P. 920)**

This certificate has been revoked.

The certificate is included in the certificate revocation list (CRL).

- Register a new certificate.
 - ▶ **Registering a Key and Certificate for Network Communication(P. 920)**

This certificate is invalid.

The certificate is invalid.

- Register the correct certificate and specify the settings again.
 - ▶ **Configuring the Key and Certificate for TLS(P. 864)**
 - ▶ **Registering a Key and Certificate for Network Communication(P. 920)**

This certificate has expired.

The certificate may have expired.

- Check the expiration date of the certificate registered in the machine. If the certificate has expired, register a valid certificate.
 - ▶ **Registering a Key and Certificate for Network Communication(P. 920)**

The date and time set on the machine may be incorrect.

- Check the date and time setting of the machine.
 - ▶ **Setting the Date/Time(P. 261)**

Cannot print this job.

The job was canceled because there are too many sheets to staple.

- Check the maximum number of sheets of paper that can be stapled together, and execute the job again.
- You can specify the procedure to perform when there are too many sheets to staple at once.
 - ▶ **<Action When Too Many Sheets to Staple>(P. 1170)**

The specified application cannot be installed on this device.

You cannot install applications other than Enhanced System Applications.

- Specify the application to install again.

No response from the server. Check the settings.

The specified server may have a problem such as not being specified correctly, not being turned on, or having insufficient resources.

- Try specifying the server again after waiting a while. If there is still no response from the server, select another server.

Cannot start searching because the server version settings are incorrect. Check the settings.

A different server LDAP version is set in the LDAP server and the machine.

- Change the setting in <LDAP Server Version and Character Code> in <Register LDAP Server> to "ver.2" to match the LDAP server.
 ▶ **Registering the LDAP Server(P. 299)**

Check the server.

You tried to access the server without using a proxy.

- Check whether the WebDAV server settings are correct.
- Check whether the proxy settings are correct.
 ▶ **Setting a Proxy(P. 862)**

Access to the destination is not allowed.

- Check whether the WebDAV server settings are correct.

You tried to access the server via a proxy without using TLS encrypted communication.

- Set <Use Divided Chunk Send for WebDAV TX> to <Off>.
 ▶ **<Use Divided Chunk Send for WebDAV TX>(P. 1232)**

The proxy server failed to communicate with an upstream server.

- Check whether the WebDAV server and proxy server settings are correct.

An HTTP protocol version not supported by the WebDAV server was used in a request from the WebDAV client.

- Check whether the WebDAV server settings are correct.

The disk space of the WebDAV server is insufficient for the request from the WebDAV client.

- Make sufficient disk space for the request available on the WebDAV server.

The appropriate paper size, A4, is not available.

Paper of the optimal size selected with Automatic Paper Selection has not been loaded.

- Load paper of the displayed size.

<Paper Source Auto Selection> is set to <Off>.

- Specify the paper drawer manually.
- Set a paper source loaded with the optimal paper size to <On> in <Paper Source Auto Selection>.
 ▶ **<Paper Source Auto Selection>(P. 1165)**

Paper of a type that cannot be selected with Automatic Paper Selection is loaded.

- Specify the paper drawer manually.
- If you are copying, select the <Consider Paper Type> check box in <Paper Source Auto Selection>.
 ▶ **<Paper Source Auto Selection>(P. 1165)**

Sub line was disconnected due to a subnet mask conflict.

The network addresses of the main line and sub line conflict.

- Check the IP address and subnet mask settings of the main line and sub line.
 ▶ **Setting an IP Address(P. 278)**

There are too many subdirectories.

The maximum number of characters was exceeded because the number of levels was too deep.

- The destination cannot be specified. Specify another destination.

Remove all the output paper.

Paper has accumulated in the output tray.

- Remove all paper from the output tray.

Cannot install this application because an applet included in the specified application has exceeded the area that can be displayed in the device panel.

The application could not be installed because its applet exceeds the area that can be displayed on the screen of the machine.

- Install the applet for an application that can fit in the display area of the machine.

The following information is missing in file for the specified application. Check the file. <Missing information>

The application cannot be installed because the required information is not included in the file.

- An application cannot be installed if the content of the file is invalid. Check the content of the file, and if there is no problem, contact the developer of the application or the support department for the application regarding the information displayed on the screen.

The specified application does not support this device.

The specified application cannot be installed to the machine.

- Some applications can only be installed to certain devices. Install an application that is supported by the machine.

The contents of the specified file are incorrect or information is missing. Check the file.

The specified file is not a license file.

- Check whether the specified file is a license file.

The specified file contains insufficient information.

- Check the content of the file.

Cannot find the specified application. It may have been uninstalled by another user.

The specified application is not installed to the machine.

- Use the [Back] button to return to the previous page.

The contents of the specified file may be incorrect.

You tried to register a button by specifying a different file when importing.

- Register the correct file and try importing again.

The specified license does not match this device. Specify an installable license.

The specified license file cannot be installed to the machine.

- Specify a license file that can be installed.

The default key is not set. Check TLS Settings.

The key and certificate (TLS server certificate) are not registered.

- To use TLS encrypted communication, first register the key to be used.
 - ▶ **Configuring the Key and Certificate for TLS(P. 864)**

The default key is not set. Check the Key and Certificate List settings in Certificate Settings.

The key and certificate (TLS server certificate) are not registered.

- Register a key and certificate for performing TLS encrypted communication.
 - ▶ **Generating the Key and Certificate for Network Communication(P. 867)**
 - ▶ **Registering a Key and Certificate(P. 920)**

The combination of the allowed version and selected algorithm is inappropriate. Enter settings again.

The selected settings cannot be used together.

- Set a valid combination.
 - ▶ **Configuring the Key and Certificate for TLS(P. 864)**

A wired LAN adapter that cannot be used has been connected.

A USB-LAN adapter that cannot be used with the machine is connected.

- For information on the USB-LAN adapters that can be used, contact your dealer or service representative.
 - ▶ **Connecting to a Wired LAN for the Sub Line(P. 269)**

Could not verify the certificate.

The CA certificate of a certificate authority could not be confirmed.

- Register a CA certificate issued by a certificate authority.

The internal storage needs to be replaced. (Call service rep.)

The storage device has failed. Alternatively, a storage device is not installed.

- Contact your dealer or service representative.

Could not perform the job because the scanned originals were all blank pages.

The scanned document was determined to contain blank pages only.

- If the document does not contain blank pages only, check the setting for skipping blank pages.
 - ▶ **Skipping Blank Pages When Printing(P. 507)**

Remove the paper from the booklet tray.

Paper remains in the booklet tray.

- Remove the paper remaining in the booklet tray. Printing starts automatically.

Cannot connect.

Failed to perform proxy authentication.

- Check whether the proxy settings are correct.
 - ▶ **Setting a Proxy(P. 862)**

Cannot edit/delete the paper because it is being used for other settings in Settings/Registration.

You tried to edit or delete paper that was registered in another setting via <Paper Type Management Settings>.

- The paper is registered as "Favorite Paper" in <Register Favorite Paper (Multi-Purpose Tray)> and <Multi-Purpose Tray Defaults>. Cancel the registration.
 - ▶ **Registering Frequently Used Paper Size and Type for the Multi-purpose Tray(P. 72)**
- The paper is set as a target for automatic gradation adjustment or automatic color tone adjustment. To edit or delete paper via <Paper Type Management Settings>, it is necessary to set another type of paper as a target for correction and perform gradation correction again.
 - ▶ **Adjusting Gradation(P. 1378)**

Check Computer Name in Settings/Registration.

A computer or printer with the same name is registered in the WINS database.

- When <WINS Resolution> in <WINS Settings> is set to <On>, do not register a computer or printer with a name already listed in <Computer Name/Workgroup Name Settings> in <TCP/IP Settings>.
 - ▶ **Making WINS Settings(P. 297)**
 - ▶ **<Computer Name/Workgroup Name Settings>(P. 1093)**

A printer or computer with the same name already exists in the same workgroup as this machine.

- Do not register a computer or printer with a name already listed in <Computer Name/Workgroup Name Settings> in <TCP/IP Settings>.
 - ▶ **<Computer Name/Workgroup Name Settings>(P. 1093)**

A toner cartridge of the wrong color may have been inserted. If this toner cartridge is used, a malfunction may occur. Check the inserted toner cartridge.

The color of one of the inserted toner cartridges may be incorrect.

- Make sure to check the status of the inserted container, which is displayed in the area within the frame.



(Items shown on the screen may differ depending on your model and options.)

- To continue using the toner cartridge, press <I Agree>. If you select this option, the operation of the machine is not guaranteed.
- To replace the toner cartridge, press <Cancel>.
- If you are not sure about the remedies, contact your dealer or service representative from which you purchased the toner cartridge.

Cannot change the settings because the selected key is being used.

The key and certificate you are trying to delete is being used in TLS encrypted communications or the Restrict Receiving for Each Function mode of Device Information Distribution.

- Set all TLS settings to <Off> to stop TLS encrypted communication. Also set all settings in <Restrict Receiving for Each Function> to <On>.
 - ▶<Device Information Distribution Settings>(P. 1332)

Cannot find the selected server. Check the settings.

The host name cannot be identified when the authentication information of the LDAP server is set to <Use (Security Auth.)>.

- Check whether the settings in <DNS Settings> are correct.
 - ▶<DNS Settings>(P. 1115)
- Check whether the settings on the DNS server side are correct.

The IP address could not be identified.

- Check whether the settings in <DNS Settings> are correct.
 - ▶<DNS Settings>(P. 1115)
- Check whether the settings on the DNS server side are correct.

Cannot connect to the selected server. Check the settings.

Could not connect to the IP address/port.

- Check whether the server address and port number in <Register LDAP Server> are correct.
 - ▶<Registering the LDAP Server>(P. 299)
- Check whether the LDAP server is operating normally.
- If <Authentication Information> is set to <Use (Security Auth.)> for the LDAP server, check whether UDP packets are blocked by the filter.
- Check whether the gateway address set in <TCP/IP Settings> is correct.
 - ▶<Setting an IPv4 Address>(P. 279)

The setting item specified from Settings Menu cannot currently be used. Contact the system manager.

The selected settings menu cannot be changed or is not available.

- Contact your system administrator.

The selected button may be unavailable. Contact the system manager.

The selected user does not exist.

- Log in as the Administrator and register the button again.

"Administrator" has been disabled.

- Select a user with administrator privileges.

Could not send.

An error occurred in the WebDAV server or proxy server.

- Check the settings for the WebDAV server or proxy server.

The target file or directory does not allow access from outside.

- Check whether the WebDAV server settings are correct.
- Check whether the destination is correct.
 - ▶ **Registering Destinations(P. 389)**
 - ▶ **Accessing the Advanced Space from a Computer(P. 711)**

Access to the WebDAV server is busy.

- Try sending again after waiting a while.

Chunk divided sending was refused.

- Set <Use Divided Chunk Send for WebDAV TX> to <Off>.
 - ▶ **<Use Divided Chunk Send for WebDAV TX>(P. 1232)**

The data to send is too large.

- Reduce the size of the data and try sending again.

The specified URL (host name and folder path set as the destination) is too long.

- Check the full path to the HTTP server entered in <Host Name> and the path to the WebDAV folder entered in <Folder Path> as the destination.
 - ▶ **Registering Destinations(P. 389)**
 - ▶ **Basic Operations for Scanning Originals(P. 640)**

Session timed out. Wait a moment, then try to access the database again.

The session timed out because the specified length of time elapsed.

- Try accessing again after waiting a while. If the session continues to time out, restart the machine.

Cannot complete searching due to timeout. Check the settings.

The search could not be completed within the specified time.

- Increase the length of the timeout time in <Search Timeout> in <Register LDAP Server>.
 - ▶ **Registering the LDAP Server(P. 299)**

Could not execute because the file contains unsupported data.

The page cannot be generated due to incorrect content.

- Try printing again using data in a format compatible with the machine.

Direct Connection: Ended due to an error.

Failed to connect to the mobile device, or no data was sent or received between the machine and the connected mobile device for a certain period of time.

- Check the connection between the machine and the mobile device.

Direct Connection: Ended because no other device could be found.

Cannot find a mobile device capable of connection.

- Check the network settings of the mobile device, and then connect by holding it near the machine. Depending on your mobile device, the machine may not operate correctly. If you cannot successfully connect, contact your dealer or service representative.

Could not access the database. Restart the device.

Failed to access the user database because it is corrupt, etc.

- Restart the machine.

Digital Sig. Cert. Access Error

Could not access the user certificate when sending the user signature.

- Check the content of the user certificate registered in the machine.
 ▶ **Registering a User Signature Certificate(P. 897)**

Could not access the device certificate when sending the device signature.

- Check the content of the device certificate registered in the machine.
 ▶ **Generating a Device Signature Certificate(P. 896)**

Certificate Expiration Date Error

The certificate has expired.

- Check the expiration date of the certificate.

**Cannot log in because multiple users are registered under the same user name.
 Contact the system manager.**

The user name could not be distinguished because user names are set to be not case-sensitive.

- Change the settings to make user names case-sensitive, or register another user name.

Cannot register any new buttons because the number of registered buttons has reached the limit. Buttons already registered can be overwritten.

The button cannot be registered because the maximum number of buttons has been exceeded.

- Overwrite an existing button or delete unnecessary buttons.

▶ **Customizing the <Home> Screen(P. 363)**

Cannot import because the number of buttons for registration has exceeded the upper limit.

Buttons cannot be registered while importing because the maximum number of personal buttons/shared buttons has been exceeded.

- Delete unnecessary personal buttons/shared buttons, and import the data again.

Could not register because the number of registered users has reached the limit.

Cannot register the user because the number of users has exceeded the upper limit.

- Delete any unnecessary users.

Could not retrieve the device information details. Do you want to register the device as a destination?

Could not connect with the client machine due to an unknown reason when registering the destination client machine for distributing device information.

- Check whether the client machine is turned ON.
- Check the client machine and network settings, and try connecting again.
 - ▶ **Setting up the Network Environment(P. 263)**
- Set the key and certificate to use for TLS in the client machine.
 - ▶ **Configuring the Key and Certificate for TLS(P. 864)**
- Set a setting in <Restrict Receiving for Each Function> to <Off> in the client machine.
 - ▶ **<Device Information Distribution Settings>(P. 1332)**
- Set <Use HTTP> to <On> in the client machine.
 - ▶ **<Use HTTP>(P. 1100)**

NOTE

- If you select <Yes> in the above message, the client machine will be registered with <Distributable Settings> blank in <Details>, but device information cannot be distributed.

Replace the toner cartridge. (XXXX)

The toner in the toner cartridge has run out.

- Pressing the icon displayed at the bottom right of the screen displays a motion video to give the instructions for toner cartridge replacement. Follow these instructions to replace the toner cartridge.

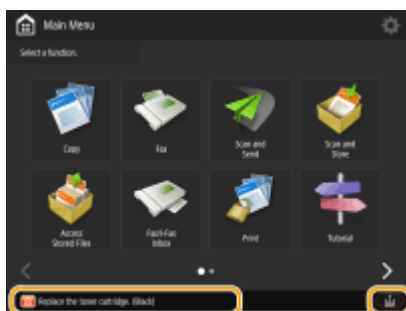

NOTE

- The "XXXX" in the message indicates the toner color.
- When black toner has run out completely, it is not necessary to press the icon on the lower-right corner of the screen. The toner cartridge replacement screen is automatically displayed, which allows you to perform the replacement procedure in accordance with the instructions given by motion video.

Cannot recognize the toner cartridge. Pull out the toner cartridge, then insert it again or information about remaining toner won't be detected properly.

The toner cartridge may not be correctly inserted, the toner cartridge may have been damaged, or a toner cartridge with the wrong model number may be inserted.

- Reinsert the toner cartridge. Make sure to check the status of the inserted container, which is displayed in the area within the frame. For instructions on checking the model number of the toner cartridge, see [▶ Consumables\(P. 123\)](#) .



- To continue using the toner cartridge, press <Close> or <I Agree>. If you select this option, the operation of the machine is not guaranteed.
- To replace the toner cartridge, press <Cancel>.
- If you are not sure about the remedies, contact your dealer or service representative from which you purchased the toner cartridge.

XXXX toner is low. Replacement is not yet needed.

Toner in the toner cartridge is running out.

- You can continue printing, but at this time you should prepare a new toner cartridge to have it available when needed.

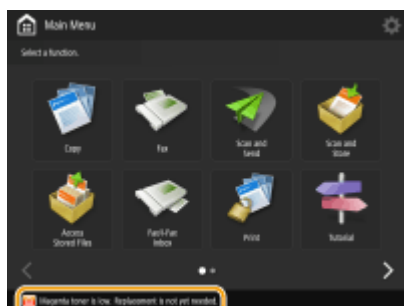

NOTE

- This message may not be displayed depending on your contract.
- The "XXXX" in the message indicates the toner color.

Load staples into the saddle stitch unit.

There are no staples in the staple case in the finisher's saddle stitch unit.

- Replenish the staples (replace the staple case).
 - ▶ **Main Unit Maintenance(P. 83)**

The entered PIN is incorrect.

An incorrect PIN was entered.

- Enter the PIN again.
- If you do not know the correct PIN, contact the administrator.

The authentication server is not running. Contact the system manager.

The LAN cable is disconnected.

- Connect the LAN cable.

The Active Directory server is not running.

- Start the Active Directory server.

The KDC service of Active Directory is stopped.

- Follow the procedure below to check the status of the service.
 1. Start the "Service" management tool of Active Directory.
 2. Check whether the Active Directory server is operating normally.

Communication with the Active Directory * server is blocked by the firewall.

- Stop blocking the default port 88.

* If Active Directory is set as the login destination, communication is normally performed with the UDP protocol using port 88, but the data may be processed with the TCP protocol if it exceeds a certain size.

Cannot find the authentication server. Contact the system manager.

The LAN cable is disconnected.

- Connect the LAN cable.

The primary/secondary DNS server settings of the machine are incorrect or not set.

- Check and adjust the DNS server settings of the machine.

The DNS server specified in the machine is not running or its service is stopped.

- Follow the procedure below to check the status and settings of the DNS server.
 1. Check whether the DNS server specified in the machine is running.
 2. Start the "Service" management tool of the DNS server.
 3. Check the status in [DNS Server], and if [Enable] is not displayed, right-click and select [Enable].

Check whether the host record exists in the DNS server.

- Check whether a host record exists in the DNS server, and whether the forwarder settings are correct.

No password is set on the authentication server side. Contact the system manager.

An appropriate password was not set on the server side when configuring or upgrading Active Directory.

- Reset the password of the corresponding account, and specify the settings again.

**Cannot log in because anonymous access to the authentication server is not allowed.
Contact the system manager.**

Anonymous access is not allowed on the LDAP server.

- On the information input screen of the LDAP server, select <Use authentication information>, and then specify the user name and password according to what is registered in the LDAP server.
▶ **Registering Server Information(P. 823)**

**The account information necessary to log in to the authentication server is invalid.
Contact the system manager.**

The user name or password is not set correctly.

- Confirm the authentication user ID and password, and whether the user has administrator privileges.

The attributes specified in the server settings are not set correctly.

- Confirm that the attributes are correct. Also, make sure that the fields (attribute names) do not contain invalid values.
▶ **Registering Server Information(P. 823)**

The administrator account information specified in the server settings is not set correctly. Alternatively, the user could not log in as an administrator.

- Specify the correct administrator account information.

The information for the server settings is insufficient.

- Confirm that the attributes necessary for logging in are set correctly.
▶ **Registering Server Information(P. 823)**

A competing IP address was found on the network.

The IPv4 address set for the machine already exists in the same network as the machine.

- Change the IP address of the machine in <IP Address> in <IPv4 Settings> so that it does not conflict with the IP address of another device.
▶ **Setting an IPv4 Address(P. 279)**

An IP address conflict was detected on the network (Main Line).

The IPv4 address set for the main line of the machine already exists on the same network as the machine.

- Change the IP address of the main line of the machine so that it does not conflict with the IP address of another device.
▶ **Setting an IPv4 Address(P. 279)**

An IP address conflict was detected on the network (Sub Line).

The IPv4 address set for the sub line of the machine already exists on the same network as the machine.

- Change the IP address of the sub line of the machine so that it does not conflict with the IP address of another device.
▶ **Setting the IPv4 Address of the Sub Line(P. 284)**

Could not perform the operation because a network error occurred.

Writing from an external source is not allowed.

- Set <Prohibit Writing from External> for the destination to <Off>.

You tried to save a file directly under a shared space or personal space.

- Files cannot be saved directly under the shared space (share) or personal space (users) of an Advanced Space. Select a folder in the space and save the file.

The full path (the folder name indicating the filename and destination to save) is too long.

- Shorten the folder name or file name or change the destination to save so that the number of characters for the path is 256 characters or fewer, including "/share" or "users".

The file cannot be stored because the maximum number of files/folders has been exceeded.

- Delete unnecessary files so that the number of files is fewer than the maximum of 100,000 for an Advanced Space, and 1,000 for a single folder. Alternatively, change the destination.

The storage device space is insufficient for storing the file.

- Delete unnecessary files or change the destination.

Check the network connection.

The cable is not connected to the machine correctly.

- Check whether the LAN cable is connected correctly. If you had to connect it again, restart the machine.
 ▶ **Connecting to a Wired LAN(P. 269)**

The machine is not connected to the network.

- If you want to use the machine without connecting to a network, set <Confirm Network Connection Setting Changes> to <Off>.
 ▶ **<Confirm Network Connection Setting Changes>(P. 1080)**

Check the network connection. (Main Line)

The machine and the LAN cable of the main line are not connected correctly.

- Check whether the LAN cable is connected correctly. If you had to connect it again, restart the machine.
 ▶ **Connecting to a Wired LAN(P. 269)**

The machine is not connected to the network.

- If you want to use the machine without connecting to a network, set <Confirm Network Connection Setting Changes> to <Off>.
 ▶ **<Confirm Network Connection Setting Changes>(P. 1080)**

Check the network connection. (Sub Line)

The machine and the LAN cable of the sub line are not connected correctly.

- Check whether the LAN cable is connected correctly. If you had to connect it again, restart the machine.
 ▶ **Front Side(P. 20)**

The machine is not connected to the network.

- If you want to use the machine without connecting to a network, set <Confirm Network Connection Setting Changes> to <Off>.
 ▶ **<Confirm Network Connection Setting Changes>(P. 1080)**

Eco (Staple-Free) is currently unavailable.

The eco (staple-free) staple unit is damaged.

- Contact your dealer or service representative.

The job was canceled because features that cannot be used at the same time as Eco (Staple-Free) are set. Change the settings, then try again. Changing the staple position or paper type may allow Eco (Staple-Free) to be used.

The staple position may be restricted depending on the paper type.

- Set the staple position to <Top Left> or <Bottom Right>.
- Change the paper type.

Check the punch waste tray.

The punch waste tray in the finisher is full.

- Empty the punch waste tray.
▶ **Main Unit Maintenance(P. 83)**

Scanning was canceled because the originals were not correctly fed.

A paper jam occurred in the feeder because multiple originals were fed together.

- Remove the originals from the feeder, and place them again.

A paper jam occurred in the feeder because an invalid type of original was fed.

- Remove the invalid original (▶ **Placing Originals(P. 39)**), and place an appropriate type of original.

Remove the jammed originals from the feeder and any originals left in the feeder tray, then place them back in the feeder tray and press the [Start] key.

Scanning was canceled because the original is jammed in the feeder.

- You need to restart the scanning with the sheet jammed in the feeder. Put together the unscanned sheets of original neatly, reload them in the feeder, and then press  (Start).
- If the message "Originals may have been fed diagonally. Check the following:" is displayed, follow the message to clear the jam. If the original was mistakenly detected as a stapled document, press <Set Sensor of Diagonally Fed Originals to Off Temporarily> and scan the document again from the first page.

Remove the original from the feeder.

You are using a function that cannot be used when an original is placed in the feeder.

- Place the original on the platen glass.

The finisher output trays cannot move up or down.

The output tray of the finisher is not operational.

- Remove any objects that may be obstructing the operation of the output tray.
- Restart the machine. If the message does not disappear after restarting the machine, write down the message displayed and contact your dealer or service representative.

The front cover of the finisher is open.

The front cover of the finisher is open.

- Check whether the front cover of the staple finisher/booklet finisher is closed.

Performing multiple jobs...

Multiple jobs such as print and send jobs are executing at the same time as the scan operation.

- Wait a while until the scan operation resumes.

Cannot log in because an authentication error occurred in Department ID Management. Contact the system manager.

When using User Authentication, Department ID Management is enabled but Department IDs have not been assigned to users.

- If you are a general user, ask your administrator to assign you a Department ID.
- If you are an administrator user, ask the Department ID Management administrator to assign you a Department ID. If no administrator users can log in, contact your dealer or service representative.

PDL Invalid DLG Input

The printer stopped operating normally due to an unknown problem.

- Restart the machine. If the message is still displayed after restarting the machine, make a note of the message and contact your dealer or service representative.

PDL DLG Rendering Error

The printer stopped operating normally due to an unknown problem.

- Restart the machine. If the message is still displayed after restarting the machine, make a note of the message and contact your dealer or service representative.

PDL DLG Unknown Error

The printer stopped operating normally due to an unknown problem.

- Restart the machine. If the message is still displayed after restarting the machine, make a note of the message and contact your dealer or service representative.

PDL DLG Memory Full

The work memory was insufficient when the system was processing data (in particular, graphic processing and text processing).

- Press <Skip Error>, and continue printing. However, pages that include the data that caused the error may not be printed correctly.

PDL DLG Mem. Alloc. Err

The printer stopped operating normally due to an unknown problem.

- Restart the machine. If the message is still displayed after restarting the machine, make a note of the message and contact your dealer or service representative.

PDL GL Orig. Pt Unknown

The printer stopped operating normally due to an unknown problem.

- Restart the machine. If the message is still displayed after restarting the machine, make a note of the message and contact your dealer or service representative.

PDL GL Coord.Result

The printer stopped operating normally due to an unknown problem.

- Restart the machine. If the message is still displayed after restarting the machine, make a note of the message and contact your dealer or service representative.

PDL Invalid GL Input

The printer stopped operating normally due to an unknown problem.

- Restart the machine. If the message is still displayed after restarting the machine, make a note of the message and contact your dealer or service representative.

PDL GL Range Check

The printer stopped operating normally due to an unknown problem.

- Restart the machine. If the message is still displayed after restarting the machine, make a note of the message and contact your dealer or service representative.

PDL GL Memory Full

The work memory was insufficient when the system was processing data (in particular, graphic processing and text processing).

- Press <Skip Error>, and continue printing. However, pages that include the data that caused the error may not be printed correctly.

PDL GL Mem. Alloc. Err

The printer stopped operating normally due to an unknown problem.

- Restart the machine. If the message is still displayed after restarting the machine, make a note of the message and contact your dealer or service representative.

PDL IMG Refer. Data Err

The TIFF or JPEG data includes data that cannot be processed with the machine.

- Cancel printing (**▶Canceling Printing(P. 600)**), initialize the printer to increase the free memory, and then try printing again. However, note that initializing the printer will erase all the data in the memory of the machine. For more details, see Setting the Machine (PS/PCL/UFR II Printer) via the online manual Web site.

PDL IMG Initial. Err

The memory for printing the TIFF or JPEG data was insufficient.

- Cancel printing (**▶Canceling Printing(P. 600)**), initialize the printer to increase the free memory, and then try printing again. However, note that initializing the printer will erase all the data in the memory of

the machine. For more details, see Setting the Machine (PS/PCL/UFR II Printer) via the online manual Web site.

PDL IMG Process. Error

An unknown problem occurred while processing the TIFF or JPEG data.

- Cancel printing (**▶Canceling Printing(P. 600)**), initialize the printer, and try printing again. However, note that initializing the printer will erase all the data in the memory of the machine. For more details, see Setting the Machine (PS/PCL/UFR II Printer) via the online manual Web site.

PDL IMG Invalid Data

The TIFF or JPEG data includes data that cannot be processed with the machine.

- Cancel printing (**▶Canceling Printing(P. 600)**), and check the TIFF or JPEG data.
- Press <Skip Error>, and continue printing. However, the data that caused the error will not be printed.

Data that cannot be processed by the machine because the machine has the same IP address as another device, etc. was sent.

- Cancel printing (**▶Canceling Printing(P. 600)**), check the IP address in <TCP/IP Settings>, and change the IP address if necessary.
▶Setting an IP Address(P. 278)

PDL IMG Work Memory Full

The memory for processing the TIFF or JPEG data was insufficient.

- Cancel printing (**▶Canceling Printing(P. 600)**), initialize the printer to increase the free memory, and then try printing again. However, note that initializing the printer will erase all the data in the memory of the machine. For more details, see Setting the Machine (PS/PCL/UFR II Printer) via the online manual Web site.
- Press <Skip Error>, and continue printing. However, the data that caused the error will not be printed.

PDL nn Rendering Error (nn is the module name)

The printer stopped operating normally due to an unknown problem.

- Restart the machine. If the message is still displayed after restarting the machine, make a note of the message and contact your dealer or service representative.

PDL PDF Error

PDF data that cannot be processed with the machine was sent.

- Cancel printing (**▶Canceling Printing(P. 600)**), optimize the PDF using Adobe Acrobat, and try printing again.
- Cancel printing (**▶Canceling Printing(P. 600)**), open the PDF file in an application, and try printing again using the printer driver.
- If the above-mentioned remedies do not solve the problem, make a note of the message and contact your dealer or service representative.

PDL PDF Data Decode Err

The password for printing the PDF file is incorrect.

- Enter the correct password, and try printing again.

Printing is not allowed in the security settings of the PDF file.

- Change the PDF file to allow printing in an application for editing PDF files.

If the PDF file is linked with a policy server, the policy server cannot be accessed.

- Check whether the policy server is turned on.
- Check whether the machine, policy server, and network are operating normally.

PDL PDF Memory Full

There is insufficient memory to process the PDF data.

- Cancel printing (**▶Canceling Printing(P. 600)**), optimize the PDF by adjusting settings such as the image resolution using Adobe Acrobat (to reduce the size of the data to print at one time), and perform printing again.
- Cancel printing (**▶Canceling Printing(P. 600)**), divide the pages of the PDF data in Adobe Acrobat into multiple files, and try printing again.
- Cancel printing (**▶Canceling Printing(P. 600)**), open the PDF file in an application, and try printing again using the printer driver.

PDL RIP Process. Error

The printer stopped operating normally due to an unknown problem.

- Restart the machine. If the message is still displayed after restarting the machine, make a note of the message and contact your dealer or service representative.

PDL XPS Error

An undefined error occurred.

- Restart the machine and try again. If the message is still displayed, make a note of the message and contact your dealer or service representative.

PDL XPS Initialize Error

An unknown error such as not being able to retrieve memory during initialization occurred.

- Restart the machine and try again. If the message is still displayed, make a note of the message and contact your dealer or service representative.

PDL XPS Rendering Error

An error occurred in the rendering system.

- Restart the machine and try again. If the message is still displayed, make a note of the message and contact your dealer or service representative.

PDL Image Comp. Error

The printer stopped operating normally due to an unknown problem.

- Restart the machine. If the message is still displayed after restarting the machine, make a note of the message and contact your dealer or service representative.

PDL Rendering Timeout

The printer stopped operating normally due to an unknown problem.

- Restart the machine. If the message is still displayed after restarting the machine, make a note of the message and contact your dealer or service representative.

PDL Data Transfer Error

The printer stopped operating normally due to an unknown problem.

- Restart the machine. If the message is still displayed after restarting the machine, make a note of the message and contact your dealer or service representative.

PDL Reg. Access Error

The printer stopped operating normally due to an unknown problem.

- Restart the machine. If the message is still displayed after restarting the machine, make a note of the message and contact your dealer or service representative.

Cannot recall the button settings because other operations are being performed.

The <Personal>/<Shared> cannot be called when another function is being executed.

- Call the <Personal>/<Shared> after the operations for the other function are complete.

Register to Home will be canceled and you will be returned to the function screen because you do not have permission to register buttons. Log in as an administrator, then try again.

Registering personal buttons/shared buttons is restricted in user authentication.

- Register the button after logging in as an administrator.
- Check the following settings.

<Allow Home Screen Customization for Common Use>

<Allow Registration/Editing of Personal Buttons>

▶ **Customizing the <Home> Screen(P. 363)**

Load staples into the stapler unit.

There are no staples in the staple case in the finisher's stapler unit.

- Replenish the staples (replace the staple case).
▶ **Main Unit Maintenance(P. 83)**

The password does not meet the policy requirements. Change the password.

The entered password violates the password policy.

- Enter a password that complies with the password policy. If you do not know the password policy, consult your system administrator.

Timer settings for this device and the authentication server may not be synchronized. Contact the system manager.

The date and time settings of the machine and the authentication server are different.

- Synchronize the date and time settings of the machine and the authentication server.

Wireless LAN communication error. Turn main power OFF and ON.

An unknown error occurred when configuring the wireless LAN connection.

- Restart the machine. Press the power switch to turn OFF the machine (**▶Turning OFF the Machine(P. 36)**). When 10 or more seconds have elapsed after the main power indicator turned off, turn ON the machine again (**▶Turning ON the Machine(P. 35)**).

Wireless LAN comm. error. Check Wireless LAN Information.

An unknown error occurred when configuring the wireless LAN connection.

- Check the wireless LAN settings.
 - ▶**Check the settings and information of the wireless LAN(P. 271)**

Cannot send because the memory is full. Wait a moment, then try again.

The fax could not be sent because there was insufficient memory.

- Lower the resolution and try sending again.
- Delete unnecessary documents in the memory of the machine to free up space.
 - ▶**Printing Documents in the Memory RX Inbox(P. 566)**
 - ▶**Working with Files and Folders in Other Devices(P. 722)**
- If this message is displayed frequently, contact your dealer or service representative.

Could not perform the operation because the memory is full.

When using the Scan and Store function, scanning was canceled because the memory became full while scanning the original.

- Press <OK> to return to the Basic Features screen. Delete unnecessary data to increase the free space, and try scanning the original again.

Scanning will be canceled because the memory is full. Do you want to print the scanned pages?

When using the Copy function, scanning was canceled because the memory became full while scanning the original.

- Press <Yes> to copy the scanned pages. Scan the remaining originals after copying is complete.

Scanning will be canceled because the memory is full. Wait a moment, then try again.

When using the Copy function, scanning was canceled because the memory became full while scanning the original.

- Press <OK> to return to the Basic Features screen. Scan the remaining originals after the current copy operation is complete.

Scanning will be canceled because the memory is full. Do you want to send the scanned pages?

When using the Fax or Scan and Send function, scanning was canceled because the memory became full while scanning the original.

- Press <Yes> to send the scanned pages. Scan the remaining originals after sending is complete.

Scanning will be canceled because the memory is full. Do you want to store the scanned pages?

When using the Scan and Store function, scanning was canceled because the memory became full while scanning the original.

- Press <Yes> to save the scanned pages. Scan the remaining originals after saving is complete.

The amount of data stored for registered users has reached the limit. You can perform operations, but no data (job setting logs, personal settings content, etc.) can be stored this time. To be able to store data from the next time you log in, unnecessary data must be deleted from other users. Contact the system manager or refer to the manual for details.

The user setting information could not be saved because the maximum number of users who can be registered was exceeded.

- To save new user setting information, delete any unnecessary user setting information.
 ▶ **Deleting User Setting Information(P. 850)**

NOTE:

- If you are not using the Personalization function, delete user setting information, and then set <Enable Use of Personal Settings> (▶<Enable Use of Personal Settings>(P. 1346)) to <Off>.
- You can specify settings to automatically delete old user setting information if the number of users who can be registered is exceeded.
 ▶<Action When Maximum Number of Users Exceeded>(P. 1346)

Register to Home will be canceled because you are not logged in. Return to the function screen, log in, then try again.

Registering shared buttons is restricted in user authentication.

- Register the button after logging in as an administrator.

Check the user name, password, or settings.

An incorrect user name or password was set for the LDAP server authentication information.

- Check whether the user name and password in <Register LDAP Server> are correct.
 ▶ **Registering the LDAP Server(P. 299)**

An incorrect domain name was set for the LDAP server authentication information.

- Check whether the domain name in <Register LDAP Server> is correct.
 ▶ **Registering the LDAP Server(P. 299)**

Load paper.



The paper in the paper source has run out.

- Load paper in the paper source displayed on the touch panel display.
 ▶ **Loading Paper(P. 46)**

The paper guides in the paper source are in the wrong position.

- Adjust the paper guides according to the edges of the paper. Depending on the cut edge of the paper, multiple sheets of paper may be fed together when printing, which can cause paper jams. This can be reduced by changing the orientation of the loaded paper.

The paper settings differ from the paper that is loaded.

- Check the paper settings in <Consumables/Others> in  (Status Monitor). If the paper settings are incorrect, match them with the paper that is loaded. Paper settings can be specified for all the paper sizes and types set in the paper drawers and multi-purpose tray in  (Settings/Registration) ▶ <Preferences> ▶ <Paper Settings>. If you are using the multi-purpose tray, remove the loaded paper and specify the paper settings.
 ▶ **Specifying Paper Size and Type(P. 64)**

The paper settings of the driver or application differ from the paper that is loaded.

- Check the paper settings on the [Printing Preferences] screen of the printer driver, and if the paper settings are incorrect, match them with the paper that is loaded.

Scanning was canceled because the data size of the scanned original exceeds the limit. Scanning may be possible if sharpness is reduced, or Original Type is set to Text.

Scanning was canceled because the data of the scanned document exceeded the maximum size that can be handled by the machine.

- You may be able to scan by lowering the setting in <Sharpness>, and setting <Original Type> to <Text>.

Some applications require license confirmation.

The license file of a MEAP application will expire soon.

- Add a license file.

Cooling... Wait a moment.

Cooling is being performed since the main unit's internal temperature has risen above the predetermined level.

- Wait a moment.

Information set by the currently logged-in user will not be stored.

The user setting information cannot be saved because the maximum number of users who can be registered was exceeded.

- To save new user setting information, delete any unnecessary user setting information.
 ▶ **Deleting User Setting Information(P. 850)**
- You can specify settings to automatically delete old user setting information if the number of users who can be registered is exceeded.
 ▶ **<Action When Maximum Number of Users Exceeded>(P. 1346)**

Login failed. Anonymous access to the authentication server is not allowed. Contact the system manager.

Anonymous access is not allowed in the LDAP server.

- Select the check box in [Use authentication information] on the screen for entering information on the LDAP server, and set the user name and password according to the information registered in the LDAP server.
- ▶ **Registering Server Information(P. 823)**

Login failed. The account information necessary to log in to the authentication server is invalid. Contact the system manager.

The user name or password is not set correctly.

- On the screen for entering the information for the LDAP server, set the correct settings according to the settings registered in the LDAP server.
- ▶ **Registering Server Information(P. 823)**

Cannot log in. Check the login destination.

The login destination information entered on the mobile device side is incorrect.

- Confirm that you have specified the correct login destination, and then log in again.

Cannot store the password because the number of passwords stored for each user has reached the limit.

The login user password cannot be registered because the maximum number of passwords has been exceeded.

- Delete unnecessary password information.

If a six-digit number is displayed when you are logging in

If an error occurs when you are logging in, a six-digit number may be displayed below the message. Take the necessary measure depending on the six-digit number displayed.

310001

Communication with the authentication server failed.

- Check the network cables from the machine and the domain controller (Active Directory).
- Check whether the domain controller is down.
- Check whether name resolution is working correctly with the DNS server set for the machine on the domain controller.
- Try again after augmenting the current value of [Period Until Timeout:] in the Active Directory settings.

310002

When [Use access mode within sites] is enabled on the machine, the site information of Active Directory is not set correctly.

- Check whether the site setting on Active Directory is valid.

310003

The network environment is not yet ready.

- Check again after a while.
- Check whether name resolution to the specified domain name is working correctly (the address can be identified) with the DNS server set for the machine, and then make adjustments as necessary.
- The DNS server set for the machine cannot be found, or it is currently unable to communicate. Check the configuration and the communication environment.

322000

A server error has occurred during Kerberos authentication.

- In Active Directory, clear the check box for [Do not require Kerberos preauthentication], which is an account option for the logged-in user account. Alternatively, check whether Active Directory is used properly.

322006

The objective user does not exist on the authentication server.

- Check whether the authentication user or search user exists on the domain controller to authenticate.

322012

In Active Directory, the check box for [Smart card is required for interactive logon], which is an account option for the logged-in user account, is selected.

- In Active Directory, clear the check box for [Smart card is required for interactive logon], which is an account option for the logged-in user account. After clearing the check box, be sure to reset the password. When resetting the password, you can use the same password instead of a new one.

322014

The password or the encryption method for Kerberos authentication is not set correctly.

- Reset the password for the authentication user or search user. For more information, see [▶Cannot log in to Active Directory.\(P. 1416\)](#) .
- Check whether the encryption method for Kerberos authentication is set to a method (AES128-bit encryption and DES) supported by User Authentication.

322018

The validity period of the account has expired.

- Check the validity period of the account in question.

322023

The validity period of the password has expired.

- Change the password.
- In Active Directory, check the setting of the account options for the logged-in user account.

322024

The user name or password is wrong when keyboard authentication is performed.

- Check the password of the authentication user or search user.

322029

The attempt to communicate with the writable domain controller failed.

- Check the network cable from the writable domain controller.
- Check whether the writable domain controller is down.
- Check whether name resolution is working correctly with the DNS server on the writable domain controller.
- Try again after augmenting the current value of [Period Until Timeout:] in the Active Directory settings.

322037

The date and time settings are not identical between the machine and the authentication server.

- Ensure that the date and time settings are identical between the machine and the authentication server.

322xxx

A Kerberos authentication error.

- A Kerberos error code is displayed in place of xxx.

323000

An error has occurred during LDAP server authentication.

- Check whether Active Directory or LDAP service is used properly.

323008

An LDAP server authentication error has occurred in relation to TLS/non-TLS communication.

- Check the communication settings (TLS/non-TLS) of the server.
- Check whether the communication settings on the device side are identical to those on the server side.

323048

You are attempting to log in as an anonymous user for LDAP server authentication.

- Check whether the LDAP service setting permits anonymous user authentication.

323049/323053

The user information for LDAP server authentication is not set correctly.

- Check the user name and password of the authentication user or search user.
- Check whether the authentication user or search user is invalid, whether their validity period has expired, and whether they are account-locked.

323xxx

An LDAP server authentication (LDAPBind) error.

- An LDAPBind error code is displayed in place of xxx.

324000

An error has occurred during LDAP server search.

- Check whether Active Directory or LDAP service is used properly.

324xxx

LDAP server search (LDAPSearch) error.

- An LDAPSearch error code is displayed in place of xxx.

325000

An error has occurred during LDAP server authentication.

- Check whether Active Directory or LDAP service is used properly.

325010

You have attempted to perform registration to a read-only domain controller.

- If the domain controller configured in Active Directory is of the read-only type, no user information editing functions (registering/deleting cards, changing PIN) are available. To use the user information registration function, configure a writable domain controller.

325050

The search user set in the Administrator settings page does not have update authority (write access).

- Check whether the search user is granted write access to the user attribute that you are going to modify.

325067

You are attempting to modify an attribute of a Relative Distinguished Name (RDN) such as cn attribute.

- You are attempting to modify an attribute of a Relative Distinguished Name (RDN) such as cn attribute. The information of such attribute cannot be modified, so specify another attribute.

325xxx

An LDAP server update error.

- An LDAPModify error code is displayed in place of xxx.

331000

User authentication failed.

- Check the user name and password. If the user name and password are correct, contact your system manager.

331001

The user name has not been entered.

- Enter the user name.

331002

Cannot find the user.

- Check the user name and password. If the user name and password are correct, contact your system manager. The user may not exist on the LDAP server, or the search user may not have read access to attribute information of the relevant account.

331003

You are using a card that is not registered on the authentication server.

- Check whether you are using a valid card.

331004

Card information is double registered on the authentication server.

- Contact your system manager.

331005

The validity period of the logged-in user has expired.

- Contact your system manager.

331006

The validity value of the card and that on the authentication server are different from each other.

- Check whether you are using a valid card. If you are using a valid card, contact your system manager.

331007

A validity value outside the range is set on the authentication server.

- Check whether the server is operated with the correct attribute of validity value.

331008

The account of the logged-in user is locked out.

- Contact your system manager.

331009

The user ID of the account you are using to log in to the machine is invalid. Or the Active Directory settings may not be correct.

- Check whether all of the required attributes are set correctly.

- In Active Directory, clear the check box for [Do not require Kerberos preauthentication], which is an account option for the logged-in user account.

331010

To perform authentication for a specific function, you have attempted to log in as a user who is not permitted to use that function.

- Contact your system manager.

331011

Login to perform authentication for a specific function failed.

- Check which functions the logged-in user is able to use.

331012

The PIN of the logged-in user is invalid.

- Enter the PIN again.

331013

The account of the logged-in user is invalid.

- Contact your system manager.

332000

User information updating failed.

- Updating the user information failed. Check whether the user information you used for updating is valid and whether invalid information is not specified for updating.

332001

Already registered card information.

- The card of the logged-in user is already registered. Check whether you are using a valid card. Or contact your system manager.

332002

An invalid attribute was specified for user information updating.

- When card information editing functions are used, it is not permitted to make registration with sAMAccountName or userPrincipalName attribute in the Active Directory settings. One solution is to use other attribute.

332003

An invalid login name was specified for user information updating.

- It is not permitted to register the name of the logged-in user (login name). Check the user name and contact your system manager.

332004

An invalid display name was specified for user information updating.

- It is not permitted to register the display name of the logged-in user. Check the display name attribute value on the server being referred to, and contact your system manager.

332005

An invalid domain name was specified for user information updating.

- It is not permitted to register the domain name for the logged-in user. Check the domain name you have selected and contact your system manager.

332006

An invalid email address was specified for user information updating.

- It is not permitted to register the email address of the logged-in user. Check the email address attribute value on the server being referred to, and contact your system manager.

332007

An invalid role was specified for user information updating.

- Check the attribute value for determining the privileges on the side of the server being referred to, and contact your system manager.

332008

The maximum registerable number of users was exceeded during user information updating.

- Contact your system manager.

Countermeasures for Each Error Code

961F-0WY

When printing or scanning is not completed normally or fax transmission or reception fails, a number starting with "#" (an error code) is displayed on the details screen for job log or a communication management report (**▶Printing Reports and Lists(P. 1026)**). Perform the countermeasure required for the error code.

NOTE

- Some error codes may not be displayed, depending on your machine.

#001 to #800

- ▶#001(P. 1470) ▶#003(P. 1470) ▶#005(P. 1470) ▶#009(P. 1470) ▶#010(P. 1470)
- ▶#011(P. 1471) ▶#012(P. 1471) ▶#018(P. 1471) ▶#019(P. 1471) ▶#022(P. 1471)
- ▶#025(P. 1472) ▶#033(P. 1472) ▶#034(P. 1472) ▶#035(P. 1472) ▶#037(P. 1472)
- ▶#040(P. 1473) ▶#054(P. 1473) ▶#080(P. 1473) ▶#081(P. 1473) ▶#082(P. 1473)
- ▶#083(P. 1473) ▶#084(P. 1474) ▶#099(P. 1474) ▶#102(P. 1474) ▶#107(P. 1474)
- ▶#401(P. 1474) ▶#402(P. 1474) ▶#403(P. 1474) ▶#404(P. 1475) ▶#406(P. 1475)
- ▶#407(P. 1475) ▶#409(P. 1475) ▶#410(P. 1475) ▶#411(P. 1475) ▶#701(P. 1476)
- ▶#702(P. 1476) ▶#703(P. 1476) ▶#704(P. 1476) ▶#705(P. 1476) ▶#706(P. 1477)
- ▶#711(P. 1477) ▶#712(P. 1477) ▶#713(P. 1477) ▶#715(P. 1477) ▶#716(P. 1477)
- ▶#749(P. 1477) ▶#751(P. 1478) ▶#752(P. 1478) ▶#753(P. 1478) ▶#754(P. 1478)
- ▶#755(P. 1479) ▶#759(P. 1479) ▶#761(P. 1479) ▶#762(P. 1479) ▶#766(P. 1479)
- ▶#769(P. 1480) ▶#770(P. 1480) ▶#771(P. 1480) ▶#772(P. 1481) ▶#773(P. 1481)

#801 to #999

- ▶#801(P. 1481) ▶#802(P. 1481) ▶#803(P. 1482) ▶#804(P. 1482) ▶#805(P. 1482)
- ▶#806(P. 1482) ▶#807(P. 1482) ▶#809(P. 1483) ▶#810(P. 1483) ▶#813(P. 1483)
- ▶#815(P. 1483) ▶#816(P. 1483) ▶#818(P. 1483) ▶#819(P. 1484) ▶#820(P. 1484)
- ▶#821(P. 1484) ▶#822(P. 1484) ▶#825(P. 1484) ▶#827(P. 1484) ▶#828(P. 1484)
- ▶#829(P. 1484) ▶#830(P. 1485) ▶#831(P. 1485) ▶#832(P. 1485) ▶#833(P. 1485)
- ▶#834(P. 1486) ▶#835(P. 1486) ▶#837(P. 1486) ▶#838(P. 1486) ▶#839(P. 1486)
- ▶#841(P. 1486) ▶#842(P. 1486) ▶#843(P. 1487) ▶#844(P. 1487) ▶#845(P. 1487)
- ▶#846(P. 1488) ▶#847(P. 1488) ▶#848(P. 1488) ▶#849(P. 1488) ▶#850(P. 1488)
- ▶#851(P. 1488) ▶#852(P. 1488) ▶#853(P. 1489) ▶#854(P. 1489) ▶#855(P. 1489)
- ▶#856(P. 1489) ▶#857(P. 1489) ▶#858(P. 1489) ▶#859(P. 1489) ▶#860(P. 1489)
- ▶#861(P. 1490) ▶#862(P. 1490) ▶#863(P. 1490) ▶#864(P. 1490) ▶#865(P. 1490)
- ▶#866(P. 1490) ▶#868(P. 1491) ▶#869(P. 1491) ▶#870(P. 1491) ▶#871(P. 1491)

- ▶#872(P. 1491) ▶#873(P. 1491) ▶#874(P. 1491) ▶#875(P. 1492) ▶#876(P. 1492)
- ▶#877(P. 1492) ▶#878(P. 1492) ▶#879(P. 1492) ▶#880(P. 1492) ▶#881(P. 1493)
- ▶#882(P. 1493) ▶#883(P. 1493) ▶#884(P. 1493) ▶#885(P. 1493) ▶#886(P. 1493)
- ▶#889(P. 1493) ▶#899(P. 1494) ▶#904(P. 1494) ▶#905(P. 1494) ▶#918(P. 1494)
- ▶#919(P. 1494) ▶#922(P. 1494) ▶#923(P. 1494) ▶#924(P. 1495) ▶#925(P. 1495)
- ▶#927(P. 1495) ▶#928(P. 1495) ▶#929(P. 1495) ▶#931(P. 1495) ▶#932(P. 1495)
- ▶#933(P. 1495) ▶#934(P. 1496) ▶#935(P. 1496) ▶#936(P. 1496) ▶#937(P. 1496)
- ▶#939(P. 1496) ▶#995(P. 1496)

■ #001

Different size originals were scanned without setting the Different Size Originals mode.

- Check the originals and the settings and scan the originals again.

A paper jam occurred.

- After removing the paper jam, check the documents and the settings, and then scan again.

■ #003

Communication that exceeds the specified time (64 minutes) causes an error.

- Lower the resolution and try sending again.
 - ▶Basic Operations for Sending Faxes(P. 524)
- When receiving a document, ask the other party to lower the resolution when scanning or divide the document into multiple parts.

■ #005

There was no response from the other party for 35 seconds.

- Check that the other party can communicate, and try sending again.

The device of the other party is not a model that supports G3.

- Check the device of the other party.

■ #009

Paper has run out.

- Load paper.
 - ▶Loading Paper(P. 46)

The paper deck/paper drawer is not inserted correctly.

- Insert the paper deck/paper drawer in all the way.
 - ▶Basic Paper Loading Method(P. 47)

■ #010

Paper has run out.

- Load paper.
- ▶ **Loading Paper(P. 46)**

■ #011

The document to send was not placed correctly.

- Place the original correctly and try sending again from the start of the procedure.

■ #012

Could not send because the device of the other party does not have any paper.

- Tell the other party to load paper.

■ #018

There was no response when redialing.

- Check that the other party can communicate, and redial again.

Could not send because the other party was making a call, etc.

- Check that the other party can communicate, and try sending again.

Could not send because the settings of the device of the other party do not match.

- Check the settings of the other party, and try sending again.

■ #019

When sending a fax from a remote fax client machine, sending could not be performed because the memory of the remote fax server machine became full.

- Try sending again after the other sending to the remote fax server machine is complete.
- Delete unnecessary documents and error documents from the remote fax server machine to free up space.

The document could not be sent because the memory of the machine is full.

- Delete unnecessary documents and documents with errors to make more memory available.

When performing memory sending, the image could not be stored in the memory.

- Perform memory sending again.
- Send the document with direct sending.

There was a problem with the scanned image when performing direct sending.

- Perform direct sending again.

■ #022

Forwarding could not be performed because the content of the group destination specified as the forwarding destination was deleted or only included a Mail Box.

- Specify another destination, and try sending again.

When sending to a destination registered in the address book, sending could not be performed because the destination was deleted from the address book while the machine was waiting to send.

- Specify another destination, and try sending again.

Sending from the fax driver is not allowed.

- Set <Allow Fax Driver TX> to <On>, and try sending again. **▶Restricting the Fax Sending Functions(P. 884)**

■ #025

When sending a fax from a remote fax client machine, a line that does not exist in the remote fax server machine was specified.

- Check the number of lines in the server machine, and try sending again after matching the remote fax transmission settings of the client machine with the number of lines on the server machine.
▶<No. of TX Lines>(P. 1262)

■ #033

The device of the other party does not support confidential communication or subaddresses.

- Send without using confidential communication or subaddresses.

■ #034

The confidential storage location in the device of the other party specified for confidential communication was not found.

- Check the confidential storage location in the device of the other party, and try sending again.

The memory was insufficient in the device of the other party.

- Ask the other party to free up some space.

■ #035

The device of the other party does not support the forwarding function or subaddresses.

- Directly send to the other party.

■ #037

The document could not be copied or received because there was insufficient memory available.

- Organize documents in the Memory RX Inbox to make more memory available.
▶Printing Documents in the Memory RX Inbox(P. 566)
- If you are copying a document with more than 100 pages in one operation, divide the document into two or more parts and then copy.

Data containing more than 1,000 pages was received.

- The machine deletes any pages after the 999th page, and prints or stores the remaining 999 pages. Tell the other party to send the 1,000th and subsequent pages again.

When performing delayed sending or redial sending, the image data of the document to send was not found in memory.

- Scan the original again, and try sending again.
- Select direct sending when sending again.

Could not send to multiple destinations because the machine had insufficient free memory.

- Delete unnecessary documents and error documents to free up space.
- Divide the document into two or more parts, and then try sending the document again.
- Lower the resolution and try sending again.

■ #040

When sending a fax from a remote fax client machine, sending could not be performed because the memory of the remote fax server machine was insufficient.

- Delete unnecessary documents and error documents from the remote fax server machine to free up space.
- Divide the document into two or more parts, and then try sending the document again.
- Lower the resolution and try sending again.

The document could not be sent because the memory of the machine is full.

- Delete unnecessary documents and documents with errors to make more memory available.
- Divide the sending operation into multiple batches instead of sending the document to all destinations at once.
- Lower the resolution, and then send the document again.

■ #054

The sending process was canceled because the unit telephone number and unit name were not registered.

- Try sending again after registering the unit telephone number and unit name.
 - ▶<Register Unit Telephone Number>(P. 1259)
 - ▶<Register Unit Name>(P. 1239)

■ #080

A subaddress is not set in the device of the other party.

- Check the subaddress of the other party, and try sending again.

■ #081

A password is not set in the device of the other party.

- Check the password of the other party, and try sending again.

■ #082

Polling transmission is not configured in the device of the other party.

- Tell the other party to configure polling transmission, and perform polling reception again.

■ #083

The subaddress and password of the machine and the device of the other party did not match when performing polling reception.

- Check that the subaddress and password of the machine and the device of the other party match, and try sending again.

■ #084

Cannot perform polling reception because the password is not supported by the device of the other party.

- Perform polling reception without using a password.

■ #099

The operation was canceled before it was complete.

- Perform the operation again.

■ #102

The subaddress and password do not match.

- Check the subaddress and password of the other party, and try sending again.

There was insufficient memory in the recipient's machine.

- Ask the recipient to make more memory available.

■ #107

The document could not be sent because there was insufficient memory available.

- Lower the resolution or divide the document into two or more parts, and then try sending the document again.
- Delete unnecessary files to make more memory available.
 - ▶ **Saving Received Documents in the Machine (Memory Reception)(P. 566)**
- If this problem occurs frequently, contact your dealer or service representative.

■ #401

The memory media or file server is full, or the number of files that can be saved in the root directory (the top level folder inside the memory media) has been exceeded.

- Delete unnecessary files from the memory media or file server, or create a new folder and move existing files to that folder to create room in the root directory.

■ #402

The image transfer failed when transferring to the memory media because an invalid character (such as \) was included in the specified filename.

- Change the filename to the correct filename.

■ #403

The file could not be saved because a file with the same name already exists. Normally, automatic renaming is performed to append a number between 1 and 999 to the filename when a file with the same name exists, but the file could not be saved because files with the numbers 1 to 999 appended to them already exist.

- Change the filename and save the file again.

■ #404

Writing failed because the write protect switch of the memory media was enabled.

- Disable the write protect switch of the memory media.

■ #406

Writing failed due to one of the following possible causes:

- **Memory media was removed while the file was being written to it.**
- **The Advanced Space of another machine on the network was deleted while the file was being written to it.**
- Check that the memory media is inserted or that the Advanced Space of another machine on the network is available, and read the file again.

The image transfer failed when transferring to the memory media because an unspecified error occurred. (The connected memory media may be formatted with an unsupported file system.)

- Check the status of the memory media and confirm that it is formatted with a file system supported by the machine (FAT32/exFAT). Then, try performing the procedure again.

The size of the file exceeded the upper limit.

- Lower the resolution or reduce the number of pages, and perform the operation again.

■ #407

The length of the full path to the specified file (or folder) exceeds the maximum supported length.

- Change the filename so that the length of the full path is within 256 characters, or change the destination folder.

■ #409

The file could not be saved because the maximum number of files that can be saved in the destination has been reached.

- Change the destination to save the file.

■ #410

Storing cannot be performed because there are too many jobs waiting to be stored.

- Perform the operation again when the other jobs are complete.

■ #411

The file are already locked by the other operations.

- Wait a while, and perform the operation again.

■ #701

The Department ID does not exist, or the PIN was changed.

- If you are using User Authentication, assign Department IDs to users. If you are using DepartmentID Authentication, enter the new Department ID and PIN to log in again.

The reception setting in <Allow Printer Jobs with Unknown IDs> or <Allow Remote Scan Jobs with Unknown IDs> is set to <Off>.

- Set <Allow Printer Jobs with Unknown IDs> and <Allow Remote Scan Jobs with Unknown IDs> in <Department ID Management> to <On>.

▶ **Setting the Department ID Management(P. 839)**

Sending could not be performed because the remote fax client machine failed authentication to the remote fax server machine.

- If Department ID Management is set in the remote fax server machine, log in to the remote fax client machine using the Department ID and PIN set in the remote fax server machine.

■ #702

Sending could not be performed because the memory was full.

- Wait a while. Try sending again after the other sending is complete.

■ #703

An error occurred while converting the image.

- Lower the resolution, and then send the document again.

Could not write because the image area of the memory is full.

- Try sending again after the other sending is complete.
- Delete unnecessary files in the Mail Box and Fax/I-Fax Inbox. If there is still a problem, restart the machine.

▶ **Turning ON the Machine(P. 35)**

■ #704

An unknown error occurred when retrieving destination information from the address book.

- Check the destination settings. If there is still a problem, restart the machine.

▶ **Turning ON the Machine(P. 35)**

■ #705

Sending was canceled because the image data size exceeded the maximum value set in Settings/Registration.

- Adjust the maximum data size for sending. Select a lower resolution or reduce the number of images sent at once when using the I-fax function to ensure that the maximum data size for sending is not exceeded. Divide the data, depending on the conditions of the other party.

▶ **<Maximum Data Size for Sending>(P. 1243)**

■ #706

An address book was being imported/exported from the Remote UI or another sending component was in use.

- Try sending again after the other operation is complete.

■ #711

The memory is full. You may be able to send if you delete unnecessary files in mail boxes.

- Try sending again after deleting unnecessary files in mail boxes.

■ #712

The memory is full. Try executing again after deleting unnecessary files in mail boxes.

- Try sending again after deleting unnecessary files in mail boxes.

■ #713

The document in Mail Box or Fax/I-Fax Inbox was deleted before sending the URL.

- Try sending again after saving the required document in the Mail Box or Fax/I-Fax Inbox.

■ #715

The certificate to use was not found when sending an e-mail with a digital signature attached.

- When using a device signature, set the e-mail address of the machine (**▶Setting E-mail/I-Fax Communication(P. 316)**), and then generate a certificate for device signatures (**▶Generating a Device Signature Certificate(P. 896)**). If a certificate for device signatures has already been generated, generate it again. When using a user signature, register the certificate for user signatures again (**▶Registering a User Signature Certificate(P. 897)**).
- Check whether an expired certificate or revoked certificate is being used. In addition, check whether the certificate chain is invalid.

■ #716

The destination public key certificate could not be found.

- Register the destination public key certificate in the machine.
▶Registering an S/MIME Certificate(P. 923)
- Check whether an expired certificate or revoked certificate is being used. In addition, check whether the certificate chain is invalid.

■ #749

The operation could not be performed because a service call message is displayed.

- Turn the main power OFF, and turn the main power ON again. If the operation still cannot be performed correctly, turn the main power switch OFF, remove the power plug from the outlet, and contact your dealer or service representative.
▶Turning OFF the Machine(P. 36)

▶ **Turning ON the Machine(P. 35)**

■ #751

The server is not running or the network is disconnected (either you could not connect to the destination, or the connection was lost before the job could be completed).

- Check whether the server is operating normally.
- Check the status of the network.
- If the destination is using IIS 6.0 with Windows Server 2003 and digest authentication is used as the authentication method of the WebDAV server, set <Use Divided Chunk Send for WebDAV TX> to <On> to send with WebDAV via a proxy using TLS communication.

▶ **<Use Divided Chunk Send for WebDAV TX>(P. 1232)**

The IP address is not set.

- Check <TCP/IP Settings> in <Preferences>.

▶ **<TCP/IP Settings>(P. 1092)**

Could not send to an SMB server (including the Advanced Space of another imageRUNNER ADVANCE series machine disclosed with SMB) because a file server is being browsed using Windows (SMB).

- If an error occurs with delayed sending, close the <Browse> screen, and scan and send the document again.
- If an error occurs when forwarding a received fax/I-fax file to an SMB server, scan a printed copy of the received file, and send it to the forwarding destination.

▶ **Basic Operations for Scanning Originals(P. 640)**

- You can avoid errors by using FTP as the protocol for sending to servers.

■ #752

The server is not running or the network is disconnected.

- Check whether the SMTP server is operating normally.
- Check the status of the network.

The SMTP server name setting for e-mail/I-fax is incorrect or the e-mail address or domain name is not set.

- Check the SMTP server name, e-mail address, and domain name settings in <Communication Settings>.

▶ **Setting E-mail/I-Fax Communication(P. 316)**

■ #753

A TCP/IP error (Socket or Select error, etc.) occurred when sending e-mail or when sending a fax from a remote fax client machine.

- Check the status of the network cable and connector. If there is still a problem, restart the machine.

▶ **Turning ON the Machine(P. 35)**

■ #754

The client machine is not functioning or the network is down when device information is being delivered.

- Check the client machine and network.

The destination setting is incorrect.

- Check the destination settings.

■ #755

Could not send a fax from a remote fax client machine because TCP/IP is not operating correctly.

- Check <TCP/IP Settings> in <Preferences>.
 - ▶<TCP/IP Settings>(P. 1092)

The IP address is not set.

- Check <TCP/IP Settings> in <Preferences>.
 - ▶<TCP/IP Settings>(P. 1092)
- If you selected <Wired LAN + Wireless LAN> in <Select Wired/Wireless LAN>, also check <Sub Line Settings> in <Preferences>.
 - ▶<Sub Line Settings>(P. 1134)

When the machine was turned ON, an IP address was not assigned to the machine by DHCP or Auto IP.

- Check <TCP/IP Settings> in <Preferences>.
 - ▶<TCP/IP Settings>(P. 1092)
- If you selected <Wired LAN + Wireless LAN> in <Select Wired/Wireless LAN>, also check <Sub Line Settings> in <Preferences>.
 - ▶<Sub Line Settings>(P. 1134)

■ #759

An error occurred when sending the URL of the Mail Box in which a file was saved.

- Contact your administrator.

■ #761

When sending a PDF/XPS file with a digital signature, the file could not be sent because the certificate or key pair set in the machine was corrupt or could not be accessed.

- When sending a PDF/XPS file with a user signature, check whether the user certificate is corrupt. If the user certificate is corrupt, install it again.
 - ▶**Adding a Digital Signature to Sent Files(P. 895)**
 - ▶**Registering a User Signature Certificate(P. 897)**
- When sending a PDF/XPS file with a device signature, check whether the device certificate is corrupt. If the device certificate is corrupt, generate it again.
 - ▶**Generating a Device Signature Certificate(P. 896)**

■ #762

Could not send to a domain not registered as an allowed domain because <Restrict TX Destination Domain> is set to <On>.

- Set <Restrict TX Destination Domain> to <Off> or register the domain as an allowed domain, and try sending again.
 - ▶**Restricting the Domain of Send Destination(P. 883)**

■ #766

The certificate to use when sending a PDF/XPS file with a digital signature has expired.

- Update the certificate or use a certificate that has not expired.

- If the certificate has not expired, set the time of the machine correctly.
 ▶ **Setting the Date/Time(P. 261)**

■ #769

The number of trials allowed for the send function reached the upper limit.

- If you want to continue using this function, purchase the official optional product.

■ #770

When sending with WebDAV, sending could not be performed because TLS communication was not supported on the WebDAV server side or proxy server side.

- Check the WebDAV server settings.
- Check the proxy server if you are sending via a proxy.

Sending could not be performed because a validation error occurred when validating the TLS server certificate when sending with WebDAV because <Confirm TLS Certificate for WebDAV TX> is set to <On>.

- Check whether the CA certificate used to sign the TLS server certificate on the WebDAV server side is registered in the machine.
- Check whether the TLS server certificate on the WebDAV server side is correct.
- Check whether the TLS server certificate is a self-signed certificate.

The operation could not be completed because a validation error occurred when validating the TLS server certificate when accessing another server because <Confirm TLS Certificate for Network Access> is set to <On>.

- Check whether the CA certificate used to sign the TLS server certificate of the Advanced Space of the other imageRUNNER ADVANCE series machine disclosed as a WebDAV server is registered in the machine.
- Check whether the TLS server certificate of the Advanced Space of the other imageRUNNER ADVANCE series machine disclosed as a WebDAV server is correct.
- Check whether the TLS server certificate is a self-signed certificate.

■ #771

The remote fax server address setting is incorrect.

- Check <Remote Fax TX Settings>.
 ▶ **<Remote Fax Server Address>(P. 1262)**

The remote fax server is not running.

- Check whether the remote fax server is operating normally.

The network is disconnected.

- Check the status of the network.

Could not connect to the remote fax server because the DNS server could not be connected to.

- Check the DNS server name setting.
 ▶ **Making DNS Settings(P. 289)**
- Check whether the DNS server is operating normally.

■ #772

The network is disconnected.

- Check the status of the network.

■ #773

A PDF function that cannot be set is selected when <Optimize PDF for Web> is set to <On>.

- Set one of the following: Device Signature, User Signature, or Reader Extensions.
- Set <Optimize PDF for Web> to <Off>.

▶<Optimize PDF for Web>(P. 1194)

PDF functions that are not available when <Format PDF to PDF/A> is set to <On > are selected.

- Cancel the Encrypt, and Visible Signatures settings. Alternatively, set <Format PDF to PDF/A> to <Off>.

▶<Format PDF to PDF/A>(P. 1193)

■ #801

A timeout error occurred due to a problem on the mail server side when communicating with the SMTP server to send an e-mail or send or receive an I-fax.

- Check whether the SMTP server is operating normally.
- Check the status of the network.

An error was returned from the SMTP server when connecting with SMTP. The address setting is incorrect. An error occurred due to a problem on the server side when sending to a file server.

- Check whether SMTP is operating normally, the status of the network, the destination settings, and the status and settings of the file server.

The user name and password required when sending e-mail have not been set.

- Check <SMTP Authentication (SMTP AUTH)> in <Authent./Encryption>.

▶Setting SMTP authentication and encryption communication to/from the SMTP server(P. 317)

You sent to a destination that does not have write privileges.

- Check the destination settings.

A file with the same name existed when sending to a file server that does not allow files to be overwritten.

- Change the settings of the file server to enable files to be overwritten. Alternatively, contact the server administrator.
- Change the filename.

The folder name or password specified when sending to a file server was incorrect.

- Check the folder name or password.

■ #802

The SMTP server name specified in <Communication Settings> is incorrect.

- Check the SMTP server name set in <Communication Settings>.

▶Setting E-mail/I-Fax Communication(P. 316)

The DNS server address specified in <DNS Settings> is incorrect.

- Check the DNS server address specified in the DNS settings.

► **Making DNS Settings(P. 289)**

Connection to the DNS server failed.

- Check that the DNS server is functioning normally.

The settings for the FTP server specified as the destination are incorrect.

- Check the FTP server specified as the destination.

Connection to the FTP server failed.

- Check that the FTP server is functioning normally.

■ #803

The connection was interrupted due to reasons on the recipient's side before all of the pages could be sent.

- Re-enter the group destination, and try sending again.

■ #804

When sending to a file server, no folders matched the specified path.

- Check the destination.

You do not have access privileges for the folder or file. Alternatively, the folder or file may have been deleted by another operation.

- Allow access to the folder on the server side. Alternatively, contact the server administrator.

■ #805

Could not send to the SMB server because there was insufficient free space on the server side.

- Delete unnecessary documents and error documents from the server to free up space. Alternatively, contact the server administrator.

■ #806

The user name or password specified when sending to a file server was incorrect.

- Check the user name or password.

The destination specified when sending an e-mail/I-fax was incorrect.

- Check the e-mail/I-fax destination.

■ #807

You do not have access privileges for the specified directory.

- Set access privileges for the server directory or send to a directory that you have access privileges for. Alternatively, contact your administrator.

■ #809

When sending to an SMB server, a file with the same name already exists and overwriting of files is not allowed.

- Change the filename and try sending again.
- Change the settings of the SMB server to enable files to be overwritten. Alternatively, contact the server administrator.

When sending to an SMB server, the response on the server side was slow, causing a wait time timeout on the machine side before the data could be sent or forwarding could be completed.

- Set a longer timeout time in <Timeout> on the SMB client.
 ▶ **Setting the SMB Client(P. 295)**

■ #810

A POP server connection error occurred when an I-fax was received.

- Check the POP server settings in <Communication Settings>.
 ▶ **Setting E-mail/I-Fax Communication(P. 316)**
- Check whether the POP server is operating correctly. Check the status of the network.

An error was returned from the POP server when connecting to the POP server. Alternatively, a timeout error occurred on the server side.

- Check the POP server settings in <Communication Settings>.
 ▶ **Setting E-mail/I-Fax Communication(P. 316)**
- Check whether the POP server is operating correctly. Check the status of the network.

■ #813

A POP server authentication error (user account error or password error) occurred when an I-fax was received.

- Check the POP server settings in <Communication Settings>.
 ▶ **Setting E-mail/I-Fax Communication(P. 316)**

■ #815

You cannot log on to the file server because the machine is printing a document sent to that server. Simultaneous connections are not possible.

- Wait for a few moments before trying to send the data again. Alternatively, stop the PServer.

■ #816

Printing could not be performed because the maximum number of prints set in Department ID Management was exceeded.

- Contact your System Manager.

■ #818

The received data was in a file format that cannot be printed.

- Tell the other party to change the file format and send again.

■ #819

Data that cannot be handled was received. The MIME information is invalid.

- Tell the other party to check the settings and send again.

■ #820

Data that cannot be handled was received. The BASE64 or uuencode is invalid.

- Tell the other party to check the settings and send again.

■ #821

Data that cannot be handled was received. A TIFF analysis error occurred.

- Tell the other party to check the settings and send again.

■ #822

Data that cannot be handled was received. The image cannot be decoded.

- Tell the other party to check the settings and send again.

■ #825

The Department ID and PIN of a job being executed or a reserved job were deleted, or the PIN was changed.

- Execute the job again using the changed Department ID and PIN.

Device information could not be delivered because the System Manager is registered on the destination client machine but not on the host machine. Or device information could not be delivered because the System Manager ID and System Manager PIN registered in the client machine differ from the System Manager ID and System Manager PIN registered in the host machine.

- Register the same System Manager ID and System Manager PIN in both the host machine and the destination client machine, and then try delivering the device information again.

■ #827

Data that cannot be handled was received. Unsupported MIME information was included.

- Tell the other party to check the settings and send again.

■ #828

HTML data was received.

- Tell the other party to change to a format other than HTML and send again.

■ #829

Data containing more than 1,000 pages was received.

- The machine deletes any pages after the 999th page, and prints or stores the remaining 999 pages. Tell the other party to send the 1,000th and subsequent pages again.

■ #830

A DSN error notification was received because the I-fax address or destination conditions were incorrect.

- Check the specified I-fax address and the destination conditions.

A DSN error notification was received because the size of the file that was sent exceeded the size allowed by the mail server.

- Change the setting in <Maximum Data Size for Sending> so that the size of the file to send does not exceed the size allowed by the mail server.
 - ▶<Maximum Data Size for Sending>(P. 1243)
- Check the status of the mail server, DNS server, and network.

■ #831

An I-fax document could not be received using SMTP because of the Receive Filter setting in Firewall Settings.

- Reset the Receive Filter setting in Firewall Settings.
 - ▶Specifying IP Addresses in Firewall Settings(P. 855)

■ #832

Could not send DSN mail because e-mail settings and network settings were not specified in <Communication Settings>.

- Check <Communication Settings>, <DNS Settings>, and <IP Address Settings>.
 - ▶Setting E-mail/I-Fax Communication(P. 316)
 - ▶Making DNS Settings(P. 289)
 - ▶Setting an IP Address(P. 278)

DSN mail could not be sent due to a problem with the mail server or DNS server.

- Check the status of the mail server and DNS server.

■ #833

MDN (Message Disposition Notification) mail could not be sent because the TCP/IP settings were not specified.

- Check <Communication Settings>, <DNS Settings>, and <IP Address Settings>.
 - ▶Setting E-mail/I-Fax Communication(P. 316)
 - ▶Making DNS Settings(P. 289)
 - ▶Setting an IP Address(P. 278)

MDN (Message Disposition Notification) mail could not be sent due to a problem with the mail server or DNS server.

- Check the status of the mail server and DNS server.

■ #834

An MDN error notification was received because the I-fax address or destination conditions were incorrect.

- Check the specified I-fax address and the destination conditions.

An MDN error notification was received because a problem occurred in the mail server or network.

- Check the status of the mail server and network.

An MDN error notification was received because a problem such as a full memory occurred at the other party.

- Check the conditions and status of the other party.

■ #835

The maximum number of text lines that can be received with I-fax was exceeded.

- Tell the other party to reduce the number of text lines in the message body and send again.

■ #837

A connection request was received from a host whose connection is restricted by the Receive Filter settings in Firewall Settings.

- Check the Receive Filter settings in Firewall Settings. This may also represent a hacking attempt via unauthorized access.

▶ **Specifying IP Addresses in Firewall Settings(P. 855)**

■ #838

The license required to use the send function has expired.

- Purchase a license for the send function.

■ #839

The user name or password set in <Communication Settings> is incorrect.

- Check the user name and password settings for SMTP authentication (SMTP AUTH) in <Communication Settings>.

▶ **Setting E-mail/I-Fax Communication(P. 316)**

■ #841

An encryption algorithm shared with the mail server does not exist for e-mail and I-fax transmission.

- Set <Allow TLS (POP)> or <Allow TLS (SMTP TX)> in <Communication Settings> to <Off>.

▶ **Setting E-mail/I-Fax Communication(P. 316)**

- Add a common encryption algorithm to the mail server settings.

■ #842

The mail server requested authentication using a client certificate for e-mail and I-fax transmission.

- Set <Allow TLS (POP)> or <Allow TLS (SMTP TX)> in <Communication Settings> to <Off>.
 ▶ **Setting E-mail/I-Fax Communication(P. 316)**

- Change mail server settings so that a client certificate is not requested.

Sending could not be performed because a validation error occurred when validating the TLS server certificate when sending with SMTP because <Confirm TLS Certificate for SMTP TX> is set to <On>.

- Use the Remote UI to check whether the CA certificate used to sign the TLS server certificate on the SMTP server side is registered in the machine.
- Check whether the TLS server certificate on the SMTP server side is correct.
- Check whether the TLS server certificate is a self-signed certificate.

■ #843

There is a great difference between the time of the KDC (Key Distribution Center) server and the time set in the machine.

- Adjust the current date and time in <Date/Time Settings>.
 ▶ **Setting the Date/Time(P. 261)**
- Adjust the current time set in the KDC (Key Distribution Center) server.

■ #844

Failed to perform TLS encrypted communication with the POP server when sending with POP before SMTP.

- Check the TLS encrypted communication settings of the POP server.
- Set <Allow TLS (POP)> to <Off> in <Communication Settings>. If the problem is not resolved, set <POP Authentication Before Sending> to <Off> in <Communication Settings>, and switch to a setting other than POP before SMTP.
 ▶ **Setting E-mail/I-Fax Communication(P. 316)**

Sending could not be performed because a validation error occurred when validating the TLS server certificate when communicating with the POP server because <Confirm TLS Certificate for POP RX> is set to <On>.

- Use the Remote UI to check whether the CA certificate used to sign the TLS server certificate on the POP server side is registered in the machine.
- Check whether the TLS server certificate on the POP server side is correct.
- Check whether the TLS server certificate is a self-signed certificate.

■ #845

Failed to perform POP authentication (POP AUTH) when sending with POP before SMTP.

- Check the settings in <POP Server>, <POP Login Name>, and <POP Password> in <Communication Settings>.
 ▶ **Setting E-mail/I-Fax Communication(P. 316)**
- Check the POP authentication settings of the POP server.
- Select <Standard> or <APOP> in <POP Auth. Method> in <Communication Settings>. If the problem is not resolved, set <POP Authentication Before Sending> to <Off> in <Communication Settings>, and switch the communication settings to something other than POP before SMTP.
 ▶ **Setting E-mail/I-Fax Communication(P. 316)**

■ #846

Failed to perform POP authentication (APOP) when sending with POP before SMTP.

- Check the settings in <POP Server>, <POP Login Name>, and <POP Password> in <Communication Settings>.
 - ▶ **Setting E-mail/I-Fax Communication(P. 316)**
- Check the APOP settings of the POP server.
- Select <Standard> or <POP AUTH> in <POP Auth. Method> in <Communication Settings>. If the problem is not resolved, set <POP Authentication Before Sending> to <Off> in <Communication Settings>, and switch the communication settings to something other than POP before SMTP.
 - ▶ **Setting E-mail/I-Fax Communication(P. 316)**

■ #847

Could not save the received file in a Confidential Fax Inbox because the memory of the Mail Box or Fax/I-Fax Inbox was full.

- Delete unnecessary files in the Confidential Fax Inbox or Memory RX Inbox.
 - ▶ **Printing Documents in the Memory RX Inbox(P. 566)**
 - ▶ **Keeping Received Documents Private(P. 569)**

■ #848

An error occurred when combining an e-mail that was divided and sent.

- The divided data may have been deleted. If you delete divided data, it cannot be combined to form a completed document, even if the remaining data is received later. Ask the sender to send the data again.

■ #849

Device information could not be delivered because the destination client machine is executing a job.

- Deliver the device information again after the destination client machine has finished executing its job.

■ #850

Device information could not be delivered because the destination client machine is operating a screen related to the device information.

- Check the device information that was not delivered, and then deliver the device information again.
 - ▶ **Checking the Results of Device Information Distribution(P. 1014)**

■ #851

The printer job could not be stored in the Mail Box because the memory is full.

- Check the amount of available memory, and execute the job again.

■ #852

The power was turned OFF while the job was being executed.

- Check that the power cable and plug are securely connected, and execute the job again.

■ #853

The memory is full.

- Reduce the number of pages or check that the number of jobs waiting to be processed has decreased, and execute the job again.

■ #854

Device information was delivered from a machine of a different model group with <Restrict Receiving Device Information> set to <On> on the destination client machine.

- Set <Restrict Receiving Device Information> to <Off>, and deliver the device information again
 ▶ **Distributing the Device Information(P. 1011)**

■ #855

Device information could not be delivered because it included a language that cannot be handled by the destination client machine.

- Contact your dealer or service representative.

■ #856

The executed operation was canceled because the storage area used for temporarily saving data is full.

- Contact your administrator.

■ #857

Printing was canceled due to the job being canceled while being received, or due to timeout.

- If timeout has occurred, check the status of the network.

■ #858

The data is invalid.

- Check that the print protocol is supported by the machine, as well as the print settings.

■ #859

A compression error occurred with the image data.

- Check the original and the settings, and then try scanning again.

■ #860

Recovery failed after a paper jam, or an incompatible page description language or settings which cannot be combined were included.

- Check the paper or job settings.

■ #861

An error occurred while processing the print data or image data.

- Check the image size and paper size, as well as the color specification settings.

■ #862

Settings are included which are not supported, cannot be combined, or otherwise exceed the limits of the machine.

- Check the job settings.

■ #863

The job was canceled because initialization operations were performed while the print data was being processed.

- Execute the job again.

■ #864

Could not correctly recognize the external controller, or an error occurred while forwarding print data.

- Check the controller and the print data.

■ #865

The required functions for printing are currently restricted.

- Check the machine and the job settings.

■ #866

The job was canceled by the security related settings.

- If you are executing a job from the printer driver, use the user information of the appropriate privileges.
- If you are executing a job from the control panel, login as a user with the appropriate privileges.

NOTE

The security related settings are as follows.

- <Restrict Job from Remote Device without User Auth.> is <On>
- <Prohibit Authentication Using Department ID and PIN> is <On>
- <Use ACCESS MANAGEMENT SYSTEM> is <On>
 - <Print from Drivers without AMS Printer Driver Add-in> is <Restrict>
 - The print function is restricted by the user role settings*

*For information on the user roll settings, see the ACCESS MANAGEMENT SYSTEM Administrator Guide.

■ #868

When sending with WebDAV, communication with the destination failed, and access via a proxy was requested (received HTTP Error 305: Use Proxy).

- Check the WebDAV server settings.
- Check the proxy settings.
-  **Setting a Proxy(P. 862)**

■ #869

When sending with WebDAV, a response indicating that authentication failed was received from the destination (received HTTP Error 401: Unauthorized).

- Check the user name or password.
- Check the WebDAV server security settings.

■ #870

When sending with WebDAV, a response indicating that the request was rejected was received from the destination (received HTTP Error 403: Forbidden).

- Try sending again after waiting a while.
- Check the destination settings.
- Check the WebDAV server settings.

■ #871

When sending with WebDAV, a response indicating that the specified folder was not found was received from the destination (HTTP Error 404: Not Found/409: Conflict/410: Gone).

- Check the destination settings.

■ #872

When sending with WebDAV, a response indicating that access is not allowed was received from the destination (received HTTP Error 405: Method Not Allowed).

- Check the WebDAV server settings.

■ #873

When sending with WebDAV, a response indicating that proxy authentication failed was received from the destination (received HTTP Error 407: Proxy Authentication Required).

- Check the proxy settings.
-  **Setting a Proxy(P. 862)**

■ #874

When sending with WebDAV, a response indicating that a timeout occurred was received from the destination (received HTTP Error 408: Request Timeout).

- Try sending again after waiting a while.

- Check the WebDAV server settings.

■ #875

When sending with WebDAV, a response indicating that chunk transmission was refused was received from the destination (received HTTP Error 411: Length Required).

- Set <Use Divided Chunk Send for WebDAV TX> to <Off>.
 - ▶<Use Divided Chunk Send for WebDAV TX>(P. 1232)
- Check the WebDAV server settings.

■ #876

When sending with WebDAV, a response indicating that the size of the data was too large was received from the destination (received HTTP Error 413: Request Entity Too Large).

- Check the WebDAV server settings.

■ #877

When sending with WebDAV, a response indicating that the URI (host name and path to folder) was too long was received from the destination (received HTTP Error 414: Request-URI Too Long).

- Check the WebDAV server settings.

■ #878

When sending with WebDAV, a response indicating that an unexpected situation preventing the request from being executed occurred on the server side was received from the destination (received HTTP Error 500: Internal Server Error).

- Check the WebDAV server settings.

■ #879

When sending with WebDAV, a response indicating that the server does not support the necessary functions to execute the request was received from the destination (received HTTP Error 501: Not Implemented).

- Check the WebDAV server settings.
- When sending via a proxy with non-TLS communication, set <Use Divided Chunk Send for WebDAV TX> to <Off>.
 - ▶<Use Divided Chunk Send for WebDAV TX>(P. 1232)

■ #880

When sending with WebDAV, a response indicating that communication with an upstream server failed was received from the proxy server (received HTTP Error 502: Bad Gateway).

- Check the WebDAV server settings.
- Check the proxy server settings.

■ #881

When sending with WebDAV, a response indicating that requests currently cannot be handled was received from the destination (received HTTP Error 503: Service Unavailable).

- Check the WebDAV server settings.

■ #882

When sending with WebDAV, a response indicating that communication with an upstream server failed was received from the proxy server (received HTTP Error 504: Gateway Timeout).

- Check the WebDAV server settings.
- Check the proxy server settings.

■ #883

When sending with WebDAV, a response indicating that the server does not support the necessary functions to execute the request was received from the destination (received HTTP Error 505: HTTP Version Not Supported).

- Check the WebDAV server settings.

■ #884

When sending with WebDAV, a response indicating that disk space required for the request could not be secured on the server side was received from the destination (received HTTP Error 507: Insufficient Storage).

- Check the WebDAV server settings.

■ #885

When sending with WebDAV, an unexpected error response was received from the server.

- Check the WebDAV server settings.
- Check the proxy server settings.

■ #886

When sending with WebDAV, a response indicating that the request was invalid was received from the destination (received HTTP Error 400: Bad Request).

- When sending via a proxy with non-TLS communication, set <Use Divided Chunk Send for WebDAV TX> to <Off>.
 <Use Divided Chunk Send for WebDAV TX>(P. 1232)

■ #889

The original could not be scanned or printed because it was embedded with job restriction information.

- Check the job restriction information or contact your administrator.

■ #899

E-mail or I-fax transmission completed normally. However, the transmission may not have been received by the other party because it is relayed by multiple servers.

- Ask whether the other party received the transmission, as necessary.

The fax was sent normally from the remote fax client. However, reception may be incomplete because the transmission was relayed via a remote fax server.

- Check whether the fax was sent in the transmission results of the remote fax server.
- Check the status of the server and network.
- Ask the recipient to check that the document was received properly.

■ #904

Destinations registered in <Favorite Settings> are not updated when the Address Book is retrieved using device information delivery from an iR/imagePRESS series machine connected to the network.

- Register <Favorite Settings> again from the touch panel display of the machine.

■ #905

The job could not be executed because a network error occurred.

- Check the path length and access privileges of the server, and whether the file or folder is in use.

■ #918

Could not recognize the QR code in the original.

- Check whether the QR code is in the correct position and scan the original again.

■ #919

A syntax error or a PostScript error that exceeds device restrictions, etc. was detected.

- Set <Print PS Errors> (Settings/Registration) to <On>, submit the job again, confirm the contents of the PostScript error, then execute the job after resolving the error. For more details, see "Setting the Machine (PS/PCL/UFR II Printer)" via the online manual site.

■ #922

The maximum number of sheets that can be saddle-stitched has been exceeded. Saddle-stitching may be able to be performed by reducing the number of sheets.

- Check the maximum number of sheets that can be saddle-stitched, and execute again.

■ #923

Could not print on the specified side of the cover, or body of the booklet.

- Change to a paper type that is compatible with two-sided printing, and execute the job again.

■ #924

A function was specified which cannot be combined with the Eco (Staple-Free) mode.

- If you change the staple position or the paper type, it may be possible to bind with the Eco (Staple-Free) mode.

■ #925

A transmission error occurred from the fax driver.

- An image size that cannot be sent was specified. Check the size of the image.

■ #927

A transmission error occurred from the fax driver.

- Font that cannot be processed is included in the data received by the machine from a computer. Check the received data.

■ #928

A transmission error occurred from the fax driver.

- The memory is full, or the data size has exceeded the size that can be processed at one time. Delete unnecessary data or check the data size.

■ #929

A transmission error occurred from the fax driver.

- A network error occurred when the machine was receiving data from a computer. Check the network connections and settings.

■ #931

The job was canceled because saddle folding could not be performed.

- Check the setting combinations as well as the type of paper you are using and the number of sheets.

■ #932

The maximum number of sheets that can be stapled with the Eco (Staple-Free) mode has been exceeded. Stapling with the Eco (Staple-Free) mode may be able to be performed by reducing the number of sheets.

- Check the maximum number of sheets that can be stapled with the Eco (Staple-Free) mode, and execute again.

■ #933

The maximum number of sheets that can be stapled has been exceeded. Stapling may be able to be performed by reducing the number of sheets.

- Check the maximum number of sheets that can be stapled, and execute again.

■ #934

An error occurred for a print job, and the job was deleted because the specified time period elapsed.

- Resolve the error and execute the job again.
- You can also change the time period before deletion or disable automatic deletion from <Auto Delete Suspended Jobs> (Settings/Registration).
 - ▶<Auto Delete Suspended Jobs>(P. 1176)

■ #935

The job was canceled and one copy was output without being bound because the maximum number of sheets of paper that can be bound with the Eco (Staple-Free) mode was exceeded.

- Check the maximum number of sheets of paper that can be bound with the Eco (Staple-Free) mode, and execute the job again.
- You can specify the procedure to perform when there are too many sheets to staple at once.
 - ▶<Action When Too Many Sheets to Staple>(P. 1170)

■ #936

The job was canceled and one copy was output without being stapled because the maximum number of sheets of paper that can be stapled together was exceeded.

- Check the maximum number of sheets of paper that can be stapled together, and execute the job again.
- You can specify the procedure to perform when there are too many sheets to staple at once.
 - ▶<Action When Too Many Sheets to Staple>(P. 1170)

■ #937

The document was output without being saddle stitched because the maximum number of sheets of paper that can be saddle stitched was exceeded.

- Saddle stitching may be possible if you reduce the number of sheets of paper.
- You can specify the procedure to perform when there are too many sheets to staple at once.
 - ▶<Action When Too Many Sheets to Staple>(P. 1170)

■ #939

Printing was canceled due to an error that occurred while processing the image data.

- Execute the job again.

■ #995

Reserved communication jobs were cleared.

- Perform the operation again, as necessary.

Implementing Security Measures

Implementing Security Measures	1498
Various Security Functions	1499

Implementing Security Measures

961F-0X0

Saving important data to the machine and sharing information via the machine enable the machine to be used more effectively. It also raises the value the machine provides as an information asset.

The machine provides various functions for enhancing security, such as preventing information leaks, preventing unauthorized access, and protecting confidential information. Using these security functions together enables you to use the machine securely.

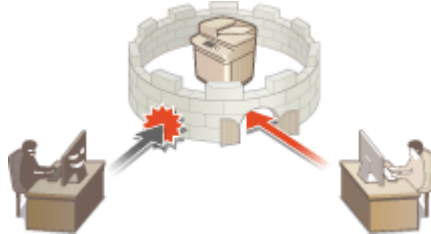

► **Various Security Functions(P. 1499)**

Various Security Functions

961F-0X1

Do you feel uneasy about the following problems?

- Unattended output
- Unauthorized access
- Faxes sent to the wrong destination
- Forgetting to erase confidential data on the machine

The machine provides various security functions for minimize the risk of information leakage and unauthorized access. This section describes functions that are effective in certain situations.

- ▶ **Preventing Documents Leaks and Modification(P. 1499)**
- ▶ **Preventing Unauthorized Access to the Network(P. 1500)**
- ▶ **Preventing Trouble Caused by Erroneous Sending(P. 1501)**
- ▶ **Preventing Leaks of Confidential Information during Operation of the Machine(P. 1502)**

! IMPORTANT

- Implementing security measures does not guarantee that all information will be protected.

NOTE

- Using the Import All function enables multiple devices to be managed with the same settings. ▶ **Importing/Exporting the Setting Data(P. 946)**

Preventing Documents Leaks and Modification



When managing confidential documents, it is necessary to handle problems such as leaks, loss, and modification. The machine is equipped with security functions designed to prevent paper and electronic documents from leakage and tampering, such as embedding invisible text in output, not starting printing until the user logs in at the device, and attaching a signature to PDF documents.

Use the following functions as security measures for preventing document leaks and modification, etc.

Forced Print of Recognition Information

You can configure the machine to always print information such as the name of the logged in user on printed or copied documents. This enables you to identify the user responsible for the output of each document. ▶ **Printing User Information on Documents(P. 891)**

Forced Secure Watermark

You can configure the machine to always embed invisible text such as "CONFIDENTIAL" or "TOP SECRET" in the background of printed or copied documents. The embedded text becomes visible when the documents are

copied, alerting users to unauthorized duplication or the risk of information leakage. **▶Embedding Invisible Text (Forced Secure Watermark)(P. 893)**

Forced Hold

To avoid leaving printed material, accidental information leakage, misprinting, etc., the administrator can set to store the document before printing. **▶Printing Documents Retained in the Machine (Forced Hold Printing) (P. 608)**

Encrypted Secure Print

By using Encrypted Secure Printing, you can send encrypted printing data to a machine from your computer. This enables you to reduce the risk of information leaks when sending printed data, and to print more safely. **▶Printing More Safely with Encrypted Secure Print(P. 611)**

Digital Signature

You can increase the reliability of documents created on the machine by adding digital signatures to scanned documents. The digital signature is added using a key and certificate mechanism, which enables you to identify the device and/or user that created the document, while ensuring that the data has not been altered. **▶Adding a Digital Signature to Sent Files(P. 895)**

Encrypted PDF

Setting a password when scanning an original enables PDF files to be encrypted for sending/saving. This helps reduce the risk of the files being viewed or edited by others. **▶Performing Encryption(P. 686)**

Preventing Unauthorized Access to the Network



Although Cloud services have made it easier to exchange data via the Internet, communication can still be intercepted or modified by malicious third parties due to network vulnerabilities. The machine provides various measures for increasing network security, such as only allowing communication with specific IP addresses and encrypting data for communication.

Use the following functions as security measures for preventing unauthorized network access, etc.

Firewall Settings

Unauthorized access by third parties, as well as network attacks and breaches, can be blocked by only allowing communication with devices that have a specific IP address. **▶Restricting Communication by Using Firewalls(P. 854)**

Proxy Settings

You can provide greater security by using a proxy server for connections outside the network, such as when browsing websites. **▶Setting a Proxy(P. 862)**

TLS Settings

TLS is a protocol for encryption for data sent over a network and is often used for communication via a Web browser or an e-mail application. TLS enables secure network communication when accessing the machine in a variety of situations, such as when using the Remote UI or distributing device information. **▶Configuring the Key and Certificate for TLS(P. 864)**

IPSec Settings

While TLS only encrypts data used on a specific application, such as a Web browser or an e-mail application, IPSec encrypts the whole (or payloads of) IP packets. This enables IPSec to offer a more versatile security system than TLS. [▶Configuring the IPSec Settings\(P. 869\)](#)

IEEE 802.1X Settings

If a device tries to connect and start communicating on an 802.1X network, the device must go through user authentication in order to prove that the connection is made by an authorized user. Authentication information is sent to and checked by a RADIUS server, which permits or rejects communication to the network depending on the authentication result. If authentication fails, a LAN switch (or an access point) blocks access from the outside of the network. The machine can connect to an 802.1X network as a client device. [▶Configuring the IEEE 802.1X Authentication Settings\(P. 874\)](#)

Preventing Trouble Caused by Erroneous Sending



Erroneous sending to the wrong destination or careless mistakes such as entering the wrong fax number can lead to leaks of confidential information. The machine provides various measures for increasing security when sending, such as limiting the destinations that can be sent to and forcing the fax number to be entered twice before sending. Use the following functions as security measures for preventing trouble caused by erroneous sending.

Address Book PIN

You can set an access number for important business contacts and other destinations in the Address Book that you do not want to display to all users. [▶Restricting Access to Destinations Registered in the Address Book\(P. 880\)](#)

Manage Address Book Access Numbers

You can prevent the leakage of sensitive or personal information from the Address Book by setting a PIN or preventing certain destinations from being displayed in the Address Book. You can also hide the Address Book itself. [▶Hiding the Address Book\(P. 880\)](#)

Restrict Address Book Use

Set whether to hide the Address Book and one-touch buttons. You can specify separate settings for Fax as well as Scan and Send. [▶Restricting Use of the Address Book\(P. 879\)](#)

Limit New Destination

The destinations that can be specified when sending faxes or scanned documents can be restricted to those registered in the Address Book or one-touch buttons, those registered in <Favorite Settings> or <Send to Myself>, or those that can be searched on the LDAP server. [▶Restricting New Destinations\(P. 882\)](#)

Limit E-Mail to Send to Myself

You can set restrictions so that users who log in with personal authentication can only send scanned documents to their own e-mail address. [▶Restricting E-Mail Destination to <Send to Myself>\(P. 883\)](#)

Restrict File TX to Personal Folder

You can set restrictions so that users who log in with personal authentication can only send scanned documents to their Personal folder. [▶Restricting File Send Destination to Personal Folder\(P. 883\)](#)

Restrict Sending to Domains

You can restrict e-mail and I-fax destinations so that only addresses in a specific domain are available. When a domain is specified, you can also set whether to allow sending to subdomains. [▶Restricting the Domain of Send Destination\(P. 883\)](#)

Confirm Entered Fax Number

You can require users to enter a fax number twice for confirmation before sending faxes, to prevent misdialing. [▶Confirming Fax Numbers before Sending\(P. 884\)](#)

Allow Fax Driver TX

You can prohibit users from sending faxes from a computer. [▶Restricting Fax Sending from a Computer\(P. 884\)](#)

Confirm Before Sending When Fax Dest. Included

You can set the machine to display a confirmation screen when sending to a fax destination. [▶Displaying a Confirmation Screen for Fax Destinations\(P. 884\)](#)

Previewing Documents before Sending

You can check scanned images on the preview screen before sending. [▶Checking Scanned Images Before Sending \(Preview\)\(P. 545\)](#)

Preventing Leaks of Confidential Information during Operation of the Machine



The machine generates value as an information asset by storing important data. Preventing confidential information from remaining on the machine after disposal is another important security measure. The machine provides various measures for increasing security of operation, such as preventing unregistered users from operating the machine, encrypting the data on the storage device, and completely erasing temporary job data when the machine is started.

Use the following functions as security measures for preventing leaks of confidential information during operation of the machine.

Verify System at Startup

The integrity of the firmware, system, and MEAP applications in the machine are verified during startup. [▶<System Verification Settings>\(P. 1360\)](#)

McAfee Embedded Control

When the machine is operating, the McAfee Embedded Control function is used to prevent unauthorized program modification and the execution of unauthorized programs, for improved system reliability. [▶<System Verification Settings>\(P. 1360\)](#)

Personal Authentication Management

A user name and password can be used to perform personal authentication of users. Preventing unauthorized access by third parties and setting usage restrictions can maintain a higher level of security and enable more efficient operation of the machine. [▶Managing Users\(P. 803\)](#)

Storage Device Data Encryption

You can prevent leakage due to removal of the storage device by automatically encrypting data on the storage device. [▶Managing Storage Device Data\(P. 1015\)](#)

Initialize All Data/Settings

You can restore all of the machine settings to the factory default values. All of the data that remains on the storage device is overwritten with 0 (null) data, which prevents the leakage of sensitive data when replacing or disposing of the storage device. ▶**Initializing All Data/Settings(P. 1016)**

Security Policy Settings

A security policy describes company-wide rules regarding information security. With this machine, multiple settings related to a security policy can be set together. ▶**Applying a Security Policy to the Machine(P. 792)**

Allow Use of Default Password for Remote Access

You can set the machine to not allow users to log in to the Remote UI using the default password (7654321) of the "Administrator" user for security reasons. ▶**<Allow Use of Default Password for Remote Access>(P. 1367)**

Appendix

Appendix	1506
Third Party Software	1507
Feature Highlights	1508
Operability	1509
Utilizing Personalization	1510
Productivity	1518
Image Quality	1519
Manageability	1520
Building a Dual Network Environment	1522
Reliability	1526
Office Compatibility	1528
The List of System Functions and Items	1529
Home	1530
Copy	1532
Fax	1534
Scan and Send	1536
Scan and Store	1538
Access Stored Files	1545
Fax/I-Fax Inbox	1554
Print	1556
MEAP	1557
Installing MEAP Applications	1559
Managing MEAP Applications	1562
Managing MEAP Application Licenses	1567
Changing Login Services	1569
Basic Windows Operations	1574
System Specifications	1577
Fax Function	1578
Send Functions	1580
Printer Functions	1582
Storage Space Functions	1585
Management Functions	1586
System Environment	1593
Network Environment	1595

System Options 1597

Appendix

961F-0X2

This chapter provides useful information and items that customers should be aware of, such as the machine's system specifications and functions for more effective use of the machine. Read this chapter as necessary.

■ System Specifications

You can check the specifications of the network environment, copy, scan, etc.



▶ **System Specifications(P. 1577)**

■ Enhancing Functions of the Machine

Refer to this section when you use the MEAP application, the dedicated application for enhancing functions.



▶ **MEAP(P. 1557)**

■ Additional Information

Read this chapter to learn useful information on using the machine.



- ▶ **Third Party Software(P. 1507)**
- ▶ **Feature Highlights(P. 1508)**
- ▶ **The List of System Functions and Items(P. 1529)**
- ▶ **Basic Windows Operations(P. 1574)**

Third Party Software

961F-0X3

For information related to third-party software, click the following icon(s).

Third-Party Services



THIRD PARTY LICENSE README



Third-party Software Included in this Manual



Feature Highlights

961F-0X4

This section highlights six ways in which you can use the machine to its fullest potential.

Simple operations and customizable functions for greater ease-of-use

▶ **Operability(P. 1509)**

Superior productivity to help your business' daily operations run more smoothly

▶ **Productivity(P. 1518)**

Clearer images thanks to high-quality image printing and corrective functions

▶ **Image Quality(P. 1519)**

Expanded capabilities and easier management

▶ **Manageability(P. 1520)**

Convenience and peace of mind

▶ **Reliability(P. 1526)**

An energy-saving design that's environmentally friendly

▶ **Office Compatibility(P. 1528)**

Operability



This section describes how to use simple operations and customizable functions to operate the machine more easily.



User-Friendly Operation Screens

The touch panel display can be operated with smartphone-like operations such as flick and pinch-in/pinch-out operations.

▶ Basic Operation of the Touch Panel Display (P. 347)



User Friendly Customization (Personalization)

The operation screens, settings, and functions of the machine can be customized according to user preferences. This is called "personalization."

The user must be logged in to personal authentication in order to use personalization.

▶ Utilizing Personalization (P. 1510)

▶ List of Items That Can Be Personalized (P. 357)

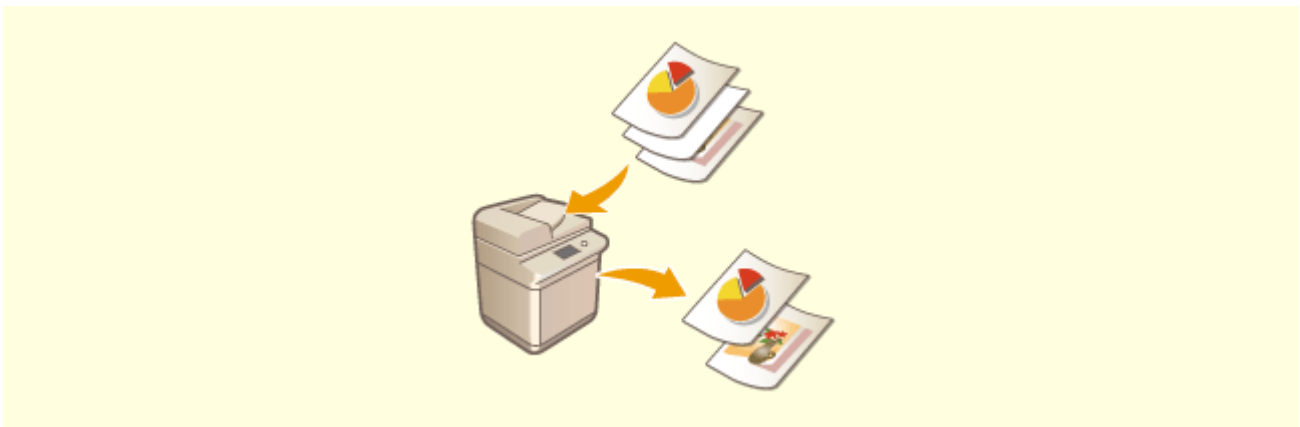

Automatically Deleting Blank Pages from the Scanned Data

Specify settings for <Skip Blank Pages> or <Skip Blank Originals> to set the machine to detect blank pages when scanning, and automatically delete them from the scanned data. This is useful for promoting efficient sending and sharing of files because this mode enables you to output/send data which does not contain blank pages even when scanning a document containing both 1-sided originals and 2-sided originals.

▶ Skipping Blank Pages When Printing (P. 507) (Copy)

▶ Skipping Blank Pages When Scanning (P. 673) (Scan and Send)

Utilizing Personalization

Have you ever experienced the following?

- Accidentally copying with the settings of the previous user
- Frequently configuring the same combination of settings

The machine has a personalization function that enables settings to be registered for each login user by using personal authentication management. For example, two-sided copying can be set as the default copy mode and the initial screen after logging in can be set to the Scan and Store Basic Features screen.

The customized settings can also be synchronized with other Canon machines on the same network and used on any machine.

The personalization function helps to improve operability and security, and reduce costs.

NOTE

- The user must be in a position to use the personal authentication function in order to use personalization. For information on personal authentication, contact your device administrator. **▶Managing Users(P. 803)**
- The settings that were personalized for each user can be synchronized with other Canon machines on the same network and used on all synchronized machines. **▶Synchronizing Settings for Multiple Canon Multifunction Printers(P. 988)**
- For details on the settings that can be personalized, see **▶List of Items That Can Be Personalized(P. 357)** .

■ Screen Personalization



▶Changing the Display Language for Each User (Switch Language/Keyboard)(P. 1512)

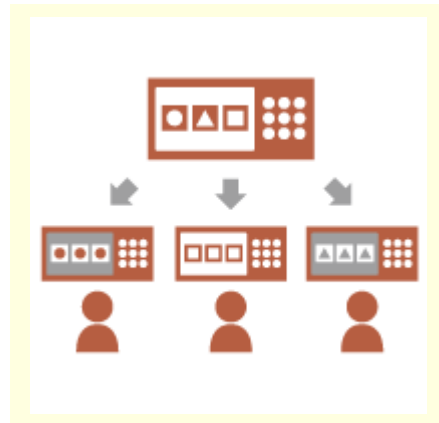

▶Displaying a Frequently Used Screen as the Initial Screen (Default Screen after Startup/Restoration / Default Screen (Status Monitor))(P. 1513)



▶Preventing Repeated Entry of the Same Character (Key Repetition Settings)(P. 1513)



▶ **Improving the Screen Visibility (Reversed Display (Color) / Enable Screen Magnification)(P. 1513)**

■ **Setting Personalization**



▶ **Specifying Frequently Used Settings as the Default Settings (Change Default Settings)(P. 1514)**



▶ **Creating Shortcuts to Setting Items at a Deep Level (Register Options Shortcuts)(P. 1514)**



▶ **Recalling Past Settings for Copying (Previous Settings) (P. 1514)**



▶ **Making the Job List Easy to See (Sorting the Job List)(P. 1515)**



▶ **Managing Destinations in Personal Address Lists/User Group Address Lists (Personal Address List / User Group Address List) (P. 1515)**

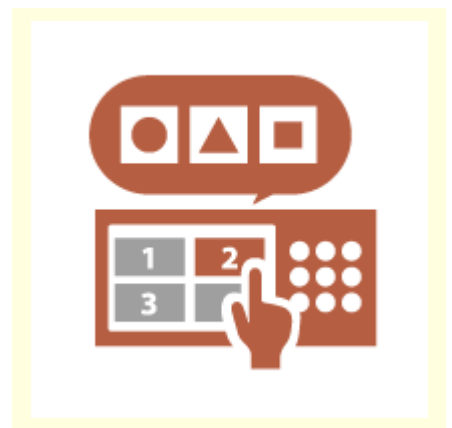

▶ **Enabling Multiple Settings to Be Set with a Single Button (<Personal>/<Shared>)(P. 1515)**

■ Function Personalization

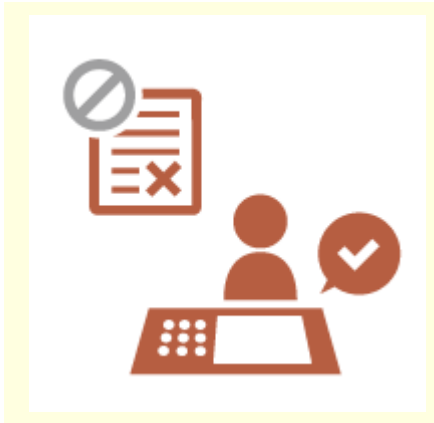

▶ **Printing Important Documents at the Machine (Forced Hold)**(P. 1516)

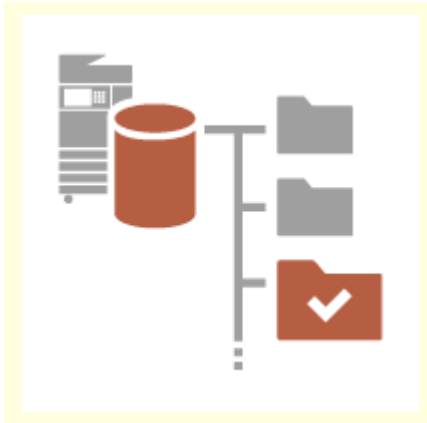

▶ **Storing Data in an Environment without a Data Server (Personal Space)**(P. 1516)



▶ **Directly Storing Scanned Data on a Server (Personal Folder)** (P. 1516)



▶ **Sending the Scanned Document to Your Own E-Mail Address (Send to Myself)**(P. 1517)

Screen Personalization

Changing the Display Language for Each User (Switch Language/Keyboard)

The language of the screen can be changed to the liking of each login user.

For example, the machine can display the screen in English for a certain user, and then switch the display language to French when another user logs in.

The keyboard layout of the touch panel display can also be changed.



▶ **Customizing the Screen Display Appearance and the Operational Conditions**(P. 380)

Displaying a Frequently Used Screen as the Initial Screen (Default Screen after Startup/ Restoration / Default Screen (Status Monitor))

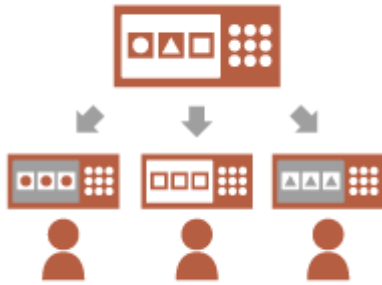

The screen displayed after logging in and after the machine returns from sleep mode can be set.

For example, the operation screen (Basic Features screen) for <Copy> and <Fax>, the destination selection screen for <Scan and Store>, and the <Status Monitor> screen for checking the job status can be set as the initial screen.

▶<Default Screen after Startup/Restoration>(P. 1063)

A frequently used job status/log screen can be registered as the default screen displayed when <Status Monitor> is pressed.

▶<Default Screen (Status Monitor)>(P. 1064)

Preventing Repeated Entry of the Same Character (Key Repetition Settings)



This setting enables you to adjust the time until entry of the same character is repeated.

For example, if you press and hold the <a> key for a certain period of time, the letter "a" begins to be entered repeatedly. This can be prevented for people who want to work slowly, by adjusting the response speed of the touch panel display.

▶Customizing the Screen Display Appearance and the Operational Conditions(P. 380)

Improving the Screen Visibility (Reversed Display (Color) / Enable Screen Magnification)

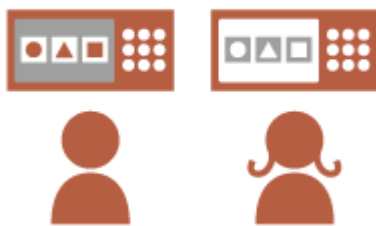

The screen can be enlarged or displayed with reversed colors.

For example, the screen colors can be reversed to make it easier to read for users that have trouble with the default colors.

Some screens can also be enlarged or reduced by pinching out or pinching in with two fingers.

▶Customizing the Screen Display Appearance and the Operational Conditions(P. 380)

Setting Personalization

Specifying Frequently Used Settings as the Default Settings (Change Default Settings)

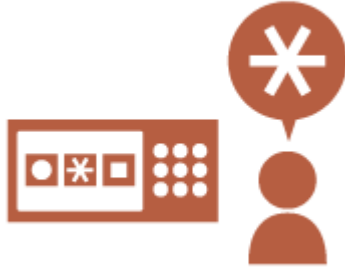

Frequently used settings can be registered as the default settings.

For example, if a user frequently uses the two-sided mode, it can be set by default to eliminate the need to specify it every time the user operates the machine.

- ▶<Change Default Settings>(P. 1197) (Copy)
- ▶<Change Default Settings>(P. 1251) (Fax)
- ▶<Change Default Settings>(P. 1228) (Scan and Send)
- ▶<Change Default Settings>(P. 1284) (Scan and Store)
- ▶<Change Default Settings>(P. 1286) (Access Stored Files)

Creating Shortcuts to Setting Items at a Deep Level (Register Options Shortcuts)

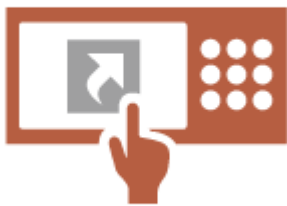

Shortcuts for frequently used settings can be registered to the Copy Basic Features screen, the Fax Basic Features screen, and the Scan and Send Basic Features screen.

For example, if a user frequently uses the <N on 1> mode in <Options> of the Copy function, a shortcut to the <N on 1> mode can be displayed on the Copy Basic Features screen, so that you can recall the <N on 1> mode with one press of a button instead of going all the way down to the <Options> screen.

- ▶<Customizing the Basic Features Screen>(P. 370)

Recalling Past Settings for Copying (Previous Settings)



The previously used <Copy> settings, and the previously used <Fax> and <Scan and Send> settings and destinations are retained in the machine. When copying with the same settings used in the past, the user can recall the previously used settings to eliminate the need to specify the same settings.

- ▶<Recalling Previously Used Copy Settings (Previous Settings)>(P. 514)
- ▶<Recalling Previously Used Settings for Sending (Previous Settings)>(P. 557)
- ▶<Recalling Previously Used Settings for Sending/Saving (Previous Settings)>(P. 691)

Making the Job List Easy to See (Sorting the Job List)



The job list can be sorted using the order of names, dates, etc., to make it easier to find the desired job or document.

The sorting order is retained for the next time the user logs in.

▶ **Changing the Display Order in the List(P. 349)**

Managing Destinations in Personal Address Lists/User Group Address Lists (Personal Address List / User Group Address List)



Destinations can be separated and managed using personal address lists and user group address lists.

For example, you can manage destinations used for your own personal customers in your personal address list and destinations shared within a group in a user group address list.

▶ **Registering Destinations in the Address Book(P. 394)**

Enabling Multiple Settings to Be Set with a Single Button (<Personal>/<Shared>)



<Personal> buttons and <Shared> buttons can be used to eliminate the need to set the same combination of settings separately.

For example, a user can set the <2-Sided> and <N on 1> modes together. By registering these settings in a <Personal> button, this combination of settings can be recalled with a single button press.

By registering the settings in a <Shared> button, they can be conveniently used by other users.

▶ **Registering Frequently Used Settings and Destinations as Personal Buttons/Shared Buttons on the <Home> Screen(P. 372)**

Function Personalization

Printing Important Documents at the Machine (Forced Hold)



Important documents can be prevented from being printed out until the user is present at the machine.

Forced hold printing enables you to check your print job at the machine before printing, so that you can cancel unnecessary jobs, or prevent other users from taking your documents away.

▶ **Printing Documents Retained in the Machine (Forced Hold Printing) (P. 608)**

Storing Data in an Environment without a Data Server (Personal Space)

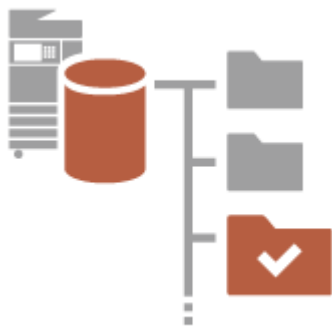

The Personal Space of the Advanced Space can be used to store important documents for management.

Separate folders for each user can be created in the machine and managed with the password used for personal authentication management.

Files in these folders can then be selected for printing.

▶ **Saving Documents in the Advanced Space(P. 709)**

Directly Storing Scanned Data on a Server (Personal Folder)



The data scanned with the machine can be stored on a server on the same network.

For example, a user can create a personal folder on an SMB server in the office and directly save data scanned with the machine. This prevents data from becoming mixed up with the data of other users.

▶ **Configuring Personal Folders(P. 846)**

Sending the Scanned Document to Your Own E-Mail Address (Send to Myself)



Users can easily send scanned documents to their own e-mail address. For example, when sending a document to the e-mail address of a customer as a PDF file, a user can press <Send to Myself> displayed on the Scan and Send Basic Features screen, etc. to also send the PDF file to their own e-mail address.

▶ **Scan Basic Features Screen(P. 637)**

Productivity

961F-0X7



This section describes how to use the machine's superior productivity to help your daily business operations run more smoothly.

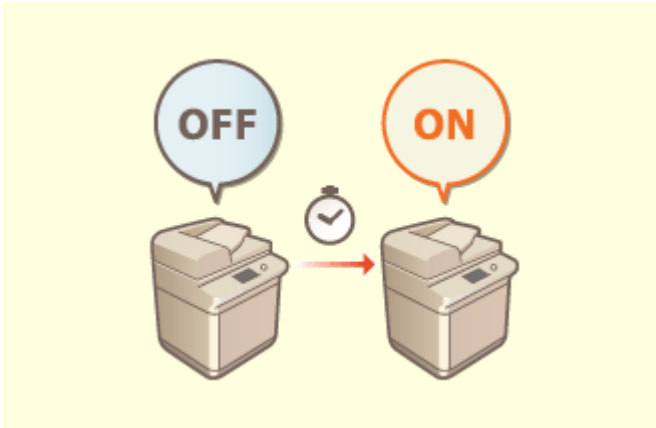

Using the Machine Immediately after Turning it ON (Quick Startup)

Specifying <Quick Startup Settings for Main Power> reduces the time required for the machine to start up after turning the main power ON, enabling smoother operations.

▶<Quick Startup Settings for Main Power>(P. 1073)

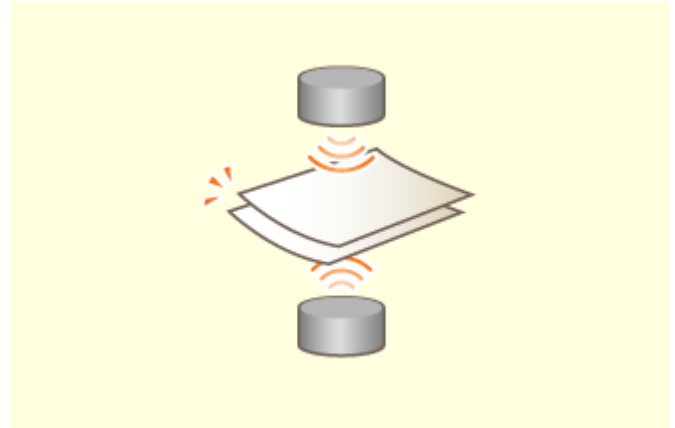

Preventing Missed Pages When Scanning Originals (Multiple Sheet Feed Detection)

Specifying <Detect Feeder Multi Sheet Fd.> to detect when multiple sheets are fed together enables you to prevent missed pages when scanning originals.

▶<Set Detection of Feeder Multi. Sheet Feed as Default>(P. 1185)

Image Quality

961F-0X8



This section describes functions that help to produce crisp and clear images, such as high-quality image printing and corrective functions.

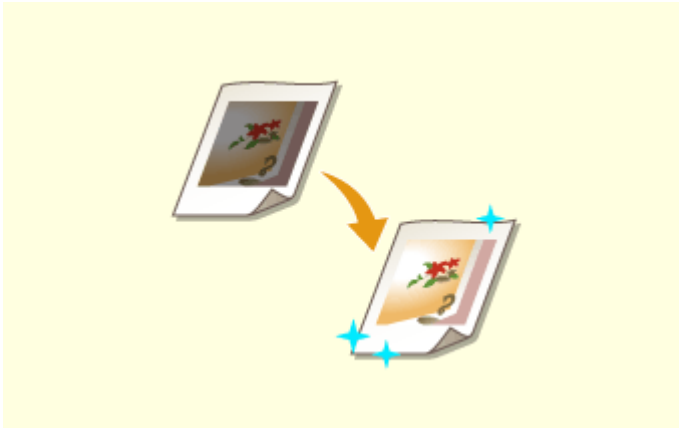

Adjusting the Quality of Printing and Finishing

You can achieve more satisfying print results by using corrective functions such as gradation adjustment and density correction.

▶ **Adjusting Print and Finish Quality**(P. 1376)



Sending Clearer Faxes

Reproduction can be enhanced on the receiving end by setting a corresponding gamma value when sending faxes.

▶ **<YCbCr TX Gamma Value>**(P. 1232)

Manageability

961F-0X9



This section describes how to expand the capabilities of the machine and make management easier.



Dual Network Environment

A dual network environment using wired LAN and wireless LAN or wired LAN and another wired LAN can be used.

▶ **Building a Dual Network Environment(P. 1522)**

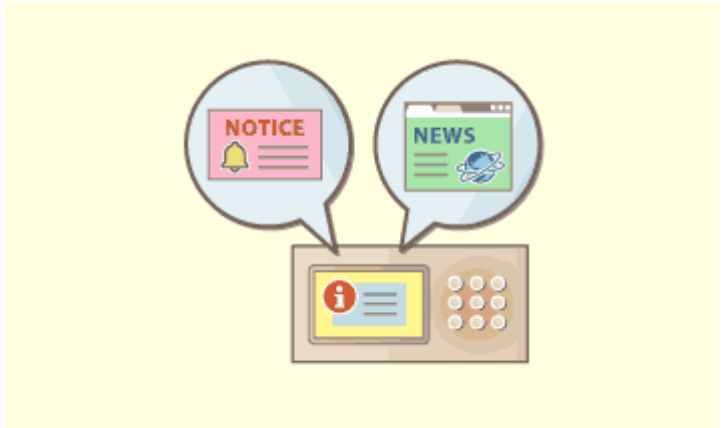

Using the Control Panel as a Tool for Sharing Information (Visual Message Function)

Content and messages set by the administrator can be displayed on the touch panel display to inform users. This function is useful for sharing information in the office.

▶ **Configuring the Visual Message Function(P. 979)**



Connecting to the Wireless LAN

A wireless LAN is built into the machine, enabling you to connect a computer or mobile device to the machine, as well as install it in a separate location.

▶ **Connecting to a Wireless LAN(P. 270)**



Linking with Mobile Devices

You can directly print data saved in a mobile device from the machine, or use the machine to scan data to a mobile device. You can also use your mobile device to specify settings for forced hold printing in the machine.

▶ **Linking with Mobile Devices(P. 764)**

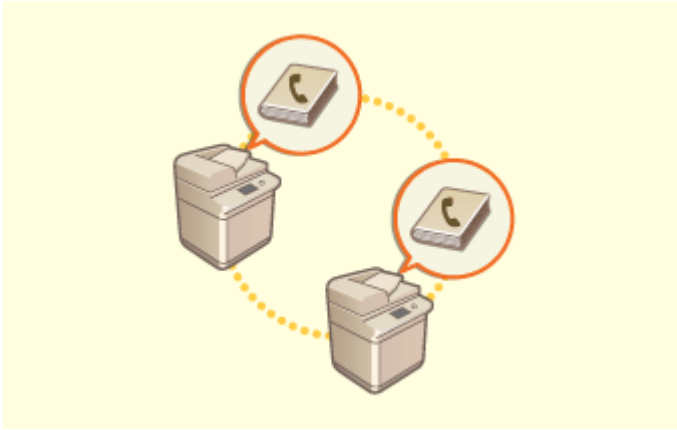

Easily Moving the Address Book

You can export the Address Book registered in the machine, and import it to another machine. You can also export the Address Book in the CSV file format and edit it on a computer

▶ **Importing/Exporting the Settings Individually(P. 954)**



Operating an Office Security Policy

A security policy describes company-wide rules regarding information security. With this machine, multiple settings related to a security policy can be set together.

▶ **Applying a Security Policy to the Machine(P. 792)**

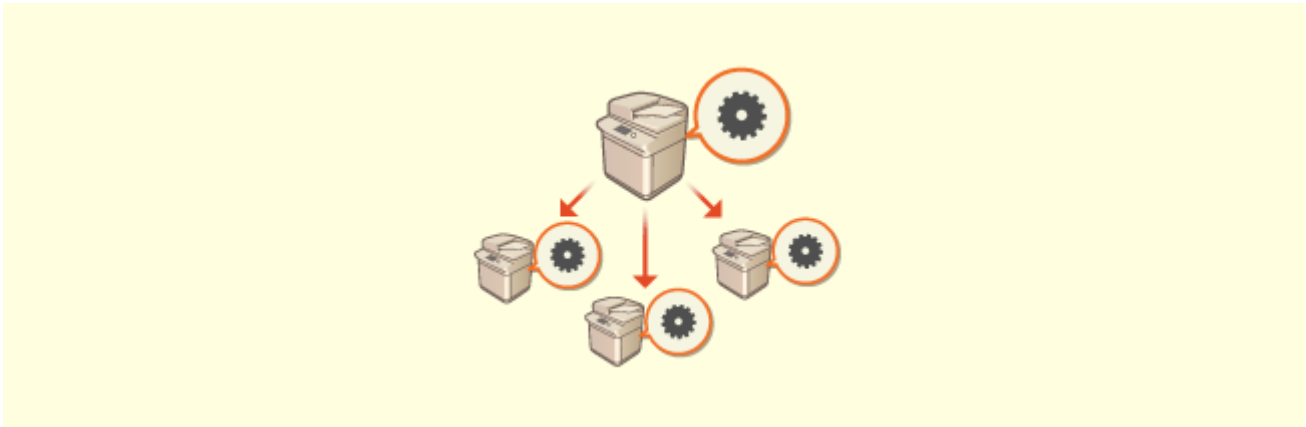

Sharing Settings between Multiple Machines

Personalized settings and Address Books can be synchronized and shared between multiple machines. Settings specified on a single machine are reflected in all synchronized machines.

▶ **Synchronizing Settings for Multiple Canon Multifunction Printers(P. 988)**

Building a Dual Network Environment

961F-0XA

Do you have separate machines in each department or floor of the same office for security purposes?

In addition to single connections with a wired LAN or wireless LAN, this machine enables dual network environments with both a wired LAN and wireless LAN or a wired LAN and another wired LAN via a USB-LAN adapter*. This makes it easy to build network environments where employees use the main line and customers use a sub line with restricted functionality. It also contributes to reduced costs as it is not necessary to install a machine for each network environment.

* For information on the supported USB-LAN adapters, contact your dealer or service representative.

NOTE

- To use Wireless LAN, the required wireless LAN connection must be installed. [▶System Options\(P. 1597\)](#)



This machine and the User's Guide refer to the main wired LAN in a dual network as the "main line". The sub wireless LAN or another wired LAN in a dual network is referred to as the "sub line."

- [▶Flow of Settings Required for a Dual Network\(P. 1522\)](#)
- [▶Cautions When Using the Sub Line\(P. 1524\)](#)

Flow of Settings Required for a Dual Network

In a dual network, the main line and sub line have separate settings. This section describes the settings required for the sub line network.

NOTE

- Specify the wired LAN/wireless LAN settings common to the main and sub lines, as required.
 - [▶Connecting to a Wired LAN\(P. 269\)](#)
 - [▶Connecting to a Wireless LAN\(P. 270\)](#)

- [▶Connecting to a Wired LAN\(P. 269\)](#)
- [▶Connecting to a Wireless LAN\(P. 270\)](#)

Step 1

[▶Selecting the Network Connection Method\(P. 267\)](#)

- Select <Wired LAN + Wireless LAN> or <Wired LAN + Wired LAN>.

**Step 2****▶Setting the IPv4 Address of the Sub Line(P. 284)**

- Specify the IPv4 address settings from <IP Address Settings> in <Sub Line Settings>. When using static routing, also set a gateway address.

**Step 3****▶Making Ethernet Settings(P. 286) ***

- Set this when using a wired LAN via a USB-LAN adapter for the sub line.
* Specify the required settings according to your environment.

**Step 4****▶Configuring the Firewall of the Sub Line(P. 859) ***

- Register the port numbers of the functions to use/restrict in the firewall settings of the sub line.
* Specify the required settings according to your environment.

**Step 5****▶Setting Static Routing(P. 307) ***

- Set static routing when connecting to another network via a router.
* Specify the required settings according to your environment.

**Step 6****▶Configuring System Data Communication(P. 311) ***

- Set this when performing specific system data communication, such as accessing a firmware distribution server in environments where DNS name resolution or network connections via a proxy cannot be used.
* Specify the required settings according to your environment.



Cautions When Using the Sub Line

The network functions set in the machine can all be used for the main line. However, the functions that can be used with the sub line are limited.

IMPORTANT

- The DNS server and WINS server settings cannot be used at the same time as the main line.
- <DNS Server Address Settings> and <Proxy Settings> in <Settings for System Data Communic.> can only be used for specific system data communication, such as using the sub line to access a firmware distribution server. When using a DNS server or proxy server for the sub line for applications other than system data communication, register the addresses and port numbers to use with the sub line in the settings of the main line.
 - ▶ **Making DNS Settings(P. 289)**
 - ▶ **Setting a Proxy(P. 862)**

■ Functions Restricted for the Sub Line

The following network functions cannot be used with the sub line.

- IPv6 address settings
- IEEE802.1X authentication
- IPsec
- NetBIOS
- SIP
- FTP (ACTIVE mode)
- DHCP Option Settings
- DNS Dynamic Update Settings
- Multicast Discovery Settings
- Setting the IP address via AutoIP
- Firewall settings via MAC address filter
- Browsing using the SMB protocol

The following functions and services cannot be used, due to the above limitations.

- Building a printing/accounting system that performs server connections via a MEAP application
- Building an authentication system for an Active Directory server
- File sending using DNS name resolution or NetBIOS name resolution from the SMB or WebDAV protocol*¹
- Automatic discovery of other multifunction printers on the sub line side using multicast discovery*¹
- Functions such as the following that use the IP address of the main line
 - [Security Policy Settings]
 - <Make Remote Address Book Open>
 - <Synchronize Custom Settings>*²
 - <Device Information Distribution Settings>
 - Batch importing/batch exporting
 - Visual Message
 - IP fax

Appendix

- Remote fax (client)
- Universal Print

*1 Specify the IP address directly.

*2 Connections using the sub line to access a server operating on the same network from a client

Reliability



This section describes how to use the machine with greater convenience and peace of mind.



Preventing Storage device Information Leakage

You can prevent leakage due to removal of the storage device by automatically encrypting data on the storage device.

▶ **Managing Storage Device Data(P. 1015)**



Managing Saved Copies of Faxes (Automatically Saving Images of Sent Faxes)

You can digitize and save sent faxes and automatically save them in a specified folder. Information related to sending is automatically added to the file name, enabling you to effectively manage faxes.

▶ **Saving a Copy of a Sent Document(P. 562)**



Digitizing and Managing Communication Management Reports

In addition to printing logs for sending and receiving (communication management reports), you can also save them as CSV files and manage them on a computer.

▶ **Outputting a Communication Result Report(P. 1029)**

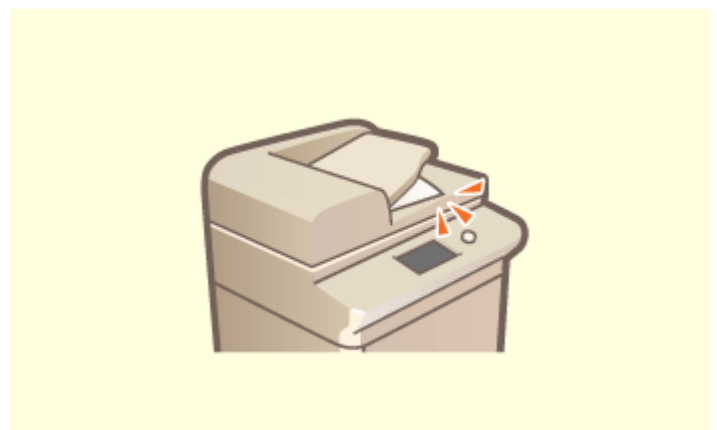

Preventing Forgotten Originals after Scanning

When an original is placed on the platen glass, an error tone and a message on the touch panel will notify you if you forget to retrieve it. In addition, an indicator will notify you during and after scanning via the feeder, thus helping prevent forgotten originals.

▶ **Setting Sounds(P. 384)**



Confirming Maintenance Procedures on the Touch Panel Display (Videos)

You can confirm procedures for replenishing consumables and cleaning by viewing videos on the touch panel display.

▶<Maintenance>(P. 1154)

Office Compatibility

961F-0XE



This section describes how to use the machine in an environmentally-friendly manner.



Using the Sleep Mode to Save Power During Standby

The machine saves power by switching to the Sleep mode or Energy Saver mode when not in use. Users can also save power by only starting up the functions they require when the machine recovers from the Sleep mode.

▶ **Entering Sleep Mode(P. 387)**

▶ **<Timer/Energy Settings>(P. 1072)**

The List of System Functions and Items

961F-0XF

- ▶ Home(P. 1530)
- ▶ Copy(P. 1532)
- ▶ Fax(P. 1534)
- ▶ Scan and Send(P. 1536)
- ▶ Scan and Store(P. 1538)
- ▶ Access Stored Files(P. 1545)
- ▶ Fax/I-Fax Inbox(P. 1554)
- ▶ Print(P. 1556)
- ▶ Visual Message(P. 979)

Home

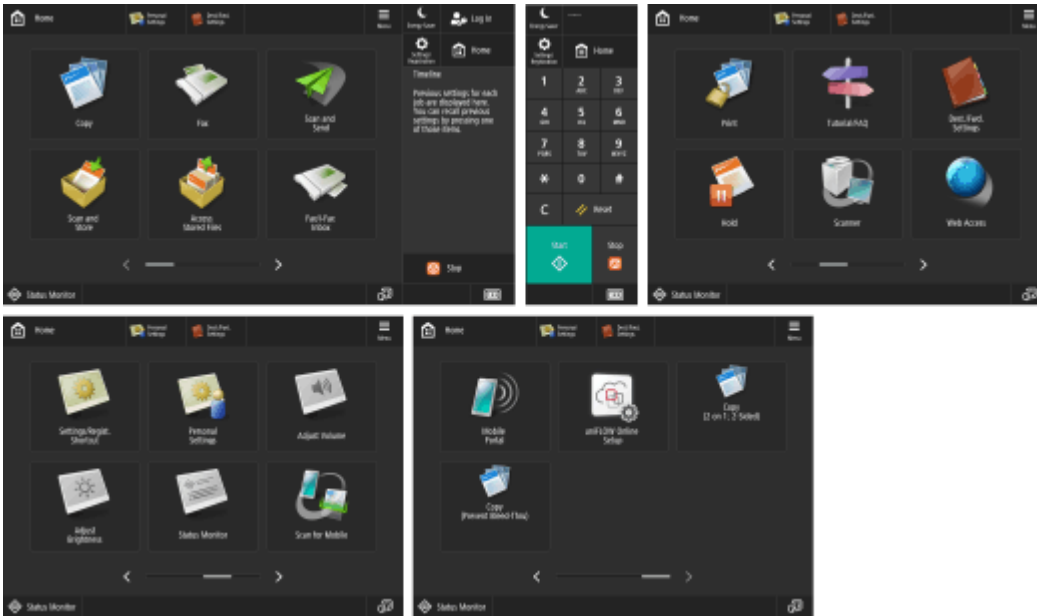

(Items shown on the screen may differ depending on your model and options.)

■ Shortcut

- ▶ Log In(P. 355)
- ▶ Home(P. 335)
- ▶ Timeline(P. 341)
- ▶ Status Monitor(P. 333)
- ▶ Energy Saver(P. 335)
- ▶ Settings/Registration(P. 1054)
- ▶ Numeric keys(P. 337)
- ▶ Clear(P. 337)
- ▶ Reset(P. 337)
- ▶ Start(P. 337)
- ▶ Stop(P. 336)
- ▶ Counter/Device Information(P. 336)

■ Function button list

- ▶ Copy(P. 416)
- ▶ Fax(P. 519)
- ▶ Scan and Send(P. 635)
- ▶ Scan and Store(P. 706)
- ▶ Access Stored Files(P. 706)
- ▶ Fax/I-Fax Inbox(P. 566)
- ▶ Print(P. 608)
- ▶ Tutorial/FAQ(P. 349)
- ▶ Dest./Fwd. Settings(P. 389)
- ▶ Scanner(P. 697)
- Web Access
 - ▶ Settings/Regist. Shortcut(P. 379)
 - ▶ Personal Settings(P. 380)

- ▶ **Status Monitor(P. 333)**
- ▶ **Scan for Mobile(P. 771)**
- ▶ **Mobile Portal(P. 765)**
- ▶ **Visual Message(P. 979)**
- ▶ **uniFLOW Online Setup(P. 1022)**
- ▶ **Personal/Shared(P. 372)**

Copy

961F-0XJ

- ▶ Copy Basic Features Screen(P. 1532)
- ▶ Options(P. 1532)

Copy Basic Features Screen

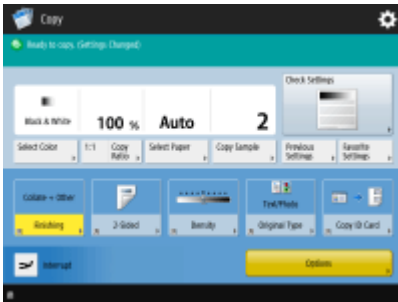

(Items shown on the screen may differ depending on your model and options.)

- ▶ Select Color(P. 420)
- ▶ 1:1(P. 418)
- ▶ Copy Ratio(P. 420)
- ▶ Select Paper(P. 420)
- ▶ Copy Sample(P. 455)
- ▶ Check Settings(P. 428)
- ▶ Previous Settings(P. 514)
- ▶ Favorite Settings(P. 367)
- ▶ Options Shortcuts(P. 370) 1 to 5
- ▶ Interrupt(P. 458)
- ▶ Options(P. 419)

Options

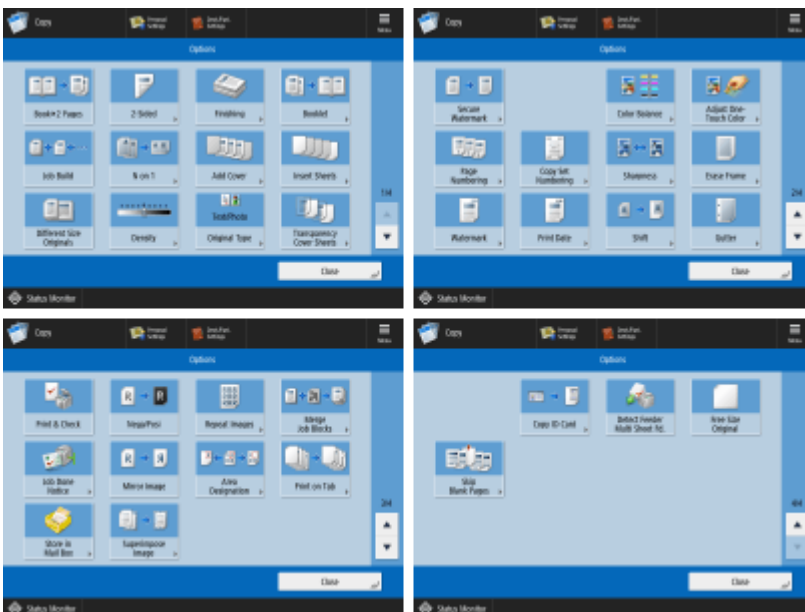

(Items shown on the screen may differ depending on your model and options.)

- ▶ Book > 2 Pages(P. 448)

- ▶2-Sided(P. 420)
- ▶Finishing (Collate/Group)(P. 460)
- ▶Finishing (Staple)(P. 462)
- ▶Finishing (Other Finishing Functions)(P. 464)
- ▶Booklet(P. 469)
- ▶Job Build(P. 453)
- ▶N on 1(P. 446)
- ▶Add Cover(P. 475)
- ▶Insert Sheets(P. 485)
- ▶Different Size Originals(P. 451)
- ▶Density(P. 420)
- ▶Original Type(P. 434)
- ▶Transparency Cover Sheets(P. 488)
- ▶Secure Watermark(P. 510)
- ▶Color Balance(P. 440)
- ▶Adjust OneTouch Color(P. 443)
- ▶Page Numbering(P. 465)
- ▶Copy Set Numbering(P. 465)
- ▶Sharpness(P. 436)
- ▶Erase Frame(P. 437)
- ▶Watermark(P. 465)
- ▶Print Date(P. 465)
- ▶Shift(P. 481)
- ▶Gutter(P. 473)
- ▶Print & Check(P. 456)
- ▶Nega/Posi(P. 439)
- ▶Repeat Images(P. 483)
- ▶Merge Job Blocks(P. 490)
- ▶Job Done Notice(P. 495)
- ▶Mirror Image(P. 480)
- ▶Area Designation(P. 499)
- ▶Store in Mail Box(P. 493)
- ▶Copy ID Card(P. 497)
- ▶Detect Feeder Multi Sheet Fd.(P. 429)
- ▶Free Size Original(P. 479)
- ▶Skip Blank Pages(P. 507)

Fax

961F-0XK

- ▶ Fax Basic Features Screen(P. 1534)
- ▶ Options(P. 1534)

Fax Basic Features Screen



- ▶ Details(P. 524)
- ▶ Delete Dest.(P. 524)
- ▶ Tone(P. 521)
- ▶ R(P. 522)
- ▶ To Remote Address Book(P. 522)
- ▶ Previous Settings(P. 557)
- ▶ Favorite Settings(P. 367)
- ▶ Resolution(P. 528)
- ▶ Scan Size(P. 528)
- ▶ Options Shortcuts(P. 370) 1 to 4
- ▶ Address Book(P. 524)
- ▶ On-Hook(P. 549)
- ▶ Direct Send(P. 547)
- ▶ Register One-Touch(P. 524)
- ▶ Options(P. 522)

Options

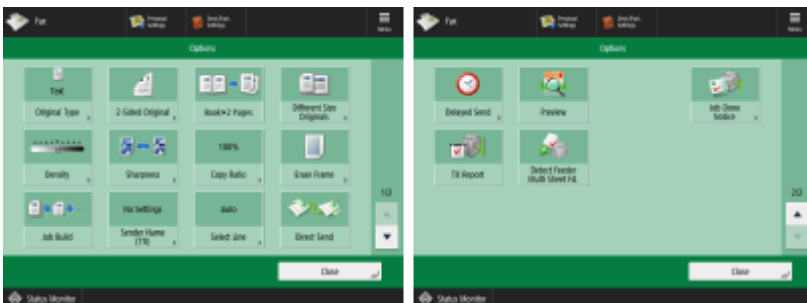

- ▶ Original Type(P. 528)
- ▶ 2-Sided Original(P. 528)
- ▶ Book>2 Pages(P. 528)
- ▶ Different Size Originals(P. 554)
- ▶ Density(P. 528)
- ▶ Sharpness(P. 528)
- ▶ Copy Ratio(P. 528)
- ▶ Erase Frame(P. 528)

- ▶ **Job Build(P. 555)**
- ▶ **Sender Name (TTI)(P. 538)**
- ▶ **Select Line(P. 538)**
- ▶ **Direct Send(P. 547)**
- ▶ **Delayed Send(P. 560)**
- ▶ **Preview(P. 545)**
- ▶ **Job Done Notice(P. 551)**
- ▶ **TX Report(P. 537)**
- ▶ **Detect Feeder Multi Sheet Fd.(P. 537)**

Scan and Send

- ▶ Scan and Send Basic Features Screen(P. 1536)
- ▶ Options(P. 1536)

Scan and Send Basic Features Screen



- ▶ Address Book(P. 640)
- ▶ One-Touch(P. 640)
- ▶ New Destination(P. 640)
- ▶ Mobile Portal(P. 640)
- ▶ Personal Folder(P. 640)
- ▶ Send to Myself(P. 640)
- ▶ Specify Destinations(P. 640)
- ▶ Details(P. 640)
- ▶ Delete Dest.(P. 640)
- ▶ Cc Bcc(P. 640)
- ▶ Previous Settings(P. 691)
- ▶ Favorite Settings(P. 367)
- ▶ Select Color(P. 645)
- ▶ Resolution(P. 645)
- ▶ Scan Size(P. 645)
- ▶ File Format(P. 645)
- ▶ Options Shortcuts(P. 370) 1 to 2
- ▶ Options(P. 638)

Options

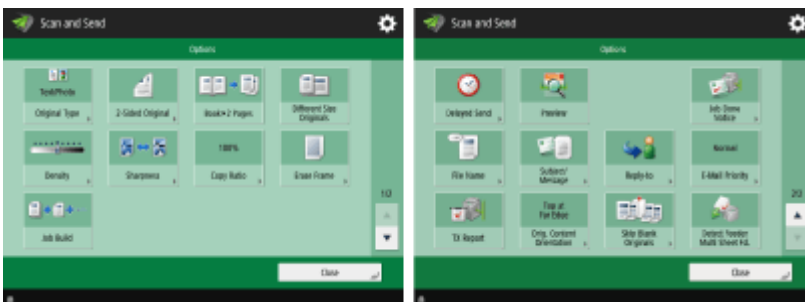

- ▶ Original Type(P. 659)
- ▶ 2-Sided Original(P. 646)
- ▶ Book>2 Pages(P. 666)
- ▶ Different Size Originals(P. 665)
- ▶ Density(P. 660)

- ▶ **Sharpness(P. 661)**
- ▶ **Copy Ratio(P. 646)**
- ▶ **Erase Frame(P. 662)**
- ▶ **Job Build(P. 670)**
- ▶ **Delayed Send(P. 677)**
- ▶ **Preview(P. 675)**
- ▶ **Job Done Notice(P. 679)**
- ▶ **File Name(P. 693)**
- ▶ **Subject/Message(P. 695)**
- ▶ **Reply-to(P. 695)**
- ▶ **E-Mail Priority(P. 696)**
- ▶ **TX Report(P. 654)**
- ▶ **Orig. Content Orientation(P. 655)**
- ▶ **Skip Blank Originals(P. 673)**
- ▶ **Detect Feeder Multi Sheet Fd.(P. 654)**

Scan and Store

961F-0XR

- ▶ **Storage Selection Screen(P. 1538)**
- ▶ **File Selection Screen(P. 1539)**
- ▶ **Scan Screen(P. 1541)**
- ▶ **Options(P. 1543)**

NOTE

- Some of the modes described here are referring to the modes of the <Copy> or <Scan and Send> function.

Storage Selection Screen



- ▶ **Mail Box(P. 725)**
- ▶ **Advanced Space(P. 709)**
- ▶ **Network(P. 721)**
- ▶ **Memory Media(P. 741)**

■ Advanced Space



- ▶ **Advanced Space Details(P. 713)**
- ▶ **Edit Personal Space(P. 717)**

■ Network

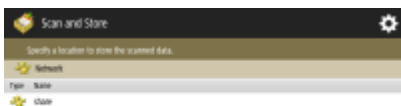

▶ Check Storage Information(P. 722)

■ Memory Media



▶ Check Media Information(P. 743)

File Selection Screen

■ Mail Box

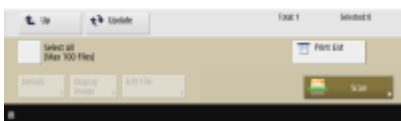

(Items shown on the screen may differ depending on your model and options.)

- ▶ List(P. 730)
- ▶ Thumbnail(P. 730)
- ▶ Up(P. 731)
- ▶ Update(P. 731)
- ▶ Select All (Max 100 Files)(P. 731) / ▶ Clear Selection(P. 731)
- ▶ Print List(P. 730)
- ▶ Details(P. 730)
- ▶ Display Image(P. 730)
- ▶ Edit File(P. 730)
- ▶ Scan(P. 725)

■ Advanced Space

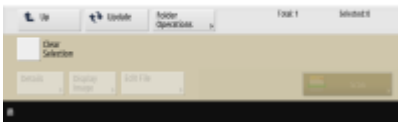
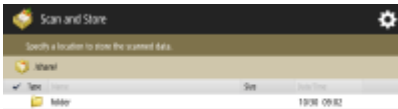

- ▶ Up(P. 714)
- ▶ Update(P. 714)
- ▶ Folder Operations(P. 714)
- ▶ Clear Selection(P. 714)
- ▶ Details(P. 714)
- ▶ Display Image(P. 714)
- ▶ Edit File(P. 714)
- ▶ Scan(P. 709)

■ Network

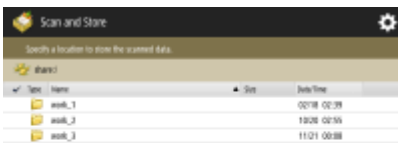

- ▶ Up(P. 714)
- ▶ Update(P. 714)
- ▶ Folder Operations(P. 714)
- ▶ Clear Selection(P. 714)
- ▶ Details(P. 714)
- ▶ Display Image(P. 714)
- ▶ Edit File(P. 714)
- ▶ Scan(P. 721)

■ Memory Media

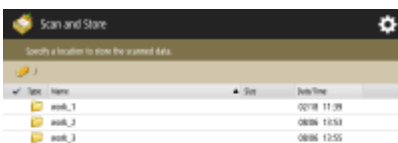

- ▶ Up(P. 744)
- ▶ Update(P. 744)
- ▶ Folder Operations(P. 744)
- ▶ Clear Selection(P. 744)

- ▶ **Details(P. 744)**
- ▶ **Display Image(P. 744)**
- ▶ **Edit File(P. 744)**
- ▶ **Scan(P. 741)**

Scan Screen

■ Mail Box

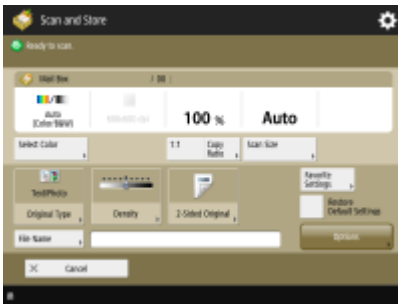

(Items shown on the screen may differ depending on your model and options.)

- ▶ **Select Color(P. 749)**
- ▶ **1:1(P. 749)**
- ▶ **Copy Ratio(P. 749)**
- ▶ **Scan Size(P. 749)**
- ▶ **Original Type(P. 750)**
- ▶ **Density(P. 750)**
- ▶ **2-Sided Original(P. 750)**
- ▶ **Favorite Settings(P. 749)**
- ▶ **Restore Default Settings(P. 750)**
- ▶ **File Name(P. 750)**
- ▶ **Options(P. 750)**

■ Advanced Space

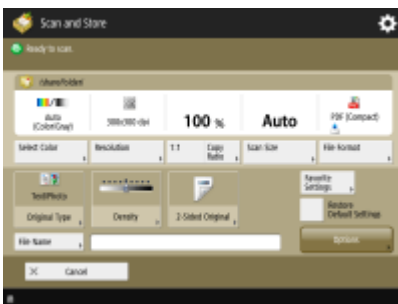

- ▶ **Select Color(P. 749)**
- ▶ **Resolution(P. 749)**
- ▶ **1:1(P. 749)**
- ▶ **Copy Ratio(P. 749)**
- ▶ **Scan Size(P. 749)**
- ▶ **File Format(P. 749)**
- ▶ **Original Type(P. 750)**
- ▶ **Density(P. 750)**
- ▶ **2-Sided Original(P. 750)**
- ▶ **Favorite Settings(P. 749)**
- ▶ **Restore Default Settings(P. 750)**

- ▶ **File Name(P. 750)**
- ▶ **Options(P. 750)**

■ Network



- ▶ **Select Color(P. 749)**
- ▶ **Resolution(P. 749)**
- ▶ **1:1(P. 749)**
- ▶ **Copy Ratio(P. 749)**
- ▶ **Scan Size(P. 749)**
- ▶ **File Format(P. 749)**
- ▶ **Original Type(P. 750)**
- ▶ **Density(P. 750)**
- ▶ **2-Sided Original(P. 750)**
- ▶ **Favorite Settings(P. 749)**
- ▶ **Restore Default Settings(P. 750)**
- ▶ **File Name(P. 750)**
- ▶ **Options(P. 750)**

■ Memory Media



- ▶ **Select Color(P. 749)**
- ▶ **Resolution(P. 749)**
- ▶ **1:1(P. 749)**
- ▶ **Copy Ratio(P. 749)**
- ▶ **Scan Size(P. 749)**
- ▶ **File Format(P. 749)**
- ▶ **Original Type(P. 750)**
- ▶ **Density(P. 750)**
- ▶ **2-Sided Original(P. 750)**
- ▶ **Favorite Settings(P. 749)**
- ▶ **Restore Default Settings(P. 750)**
- ▶ **File Name(P. 750)**
- ▶ **Options(P. 750)**

Options

■ Mail Box

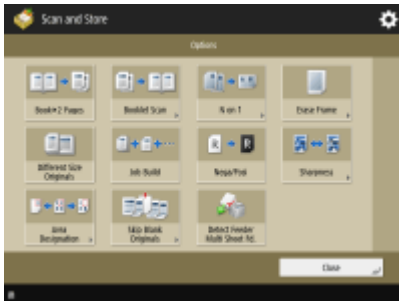

(Items shown on the screen may differ depending on your model and options.)

- ▶ **Book>2 Pages(P. 448)**
- ▶ **Booklet Scan(P. 668)**
- ▶ **N on 1(P. 446)**
- ▶ **Erase Frame(P. 437)**
- ▶ **Different Size Originals(P. 451)**
- ▶ **Job Build(P. 453)**
- ▶ **Nega/Posi(P. 439)**
- ▶ **Sharpness(P. 436)**
- ▶ **Area Designation(P. 499)**
- ▶ **Skip Blank Originals(P. 507)**
- ▶ **Detect Feeder Multi Sheet Fd.(P. 654)**

■ Advanced Space

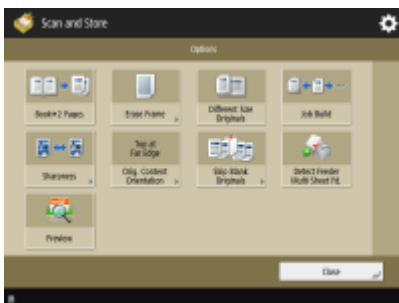

- ▶ **Book>2 Pages(P. 666)**
- ▶ **Erase Frame(P. 662)**
- ▶ **Different Size Originals(P. 665)**
- ▶ **Job Build(P. 670)**
- ▶ **Sharpness(P. 661)**
- ▶ **Orig. Content Orientation(P. 655)**
- ▶ **Skip Blank Originals(P. 673)**
- ▶ **Detect Feeder Multi Sheet Fd.(P. 654)**
- ▶ **Preview(P. 675)**

■ Network

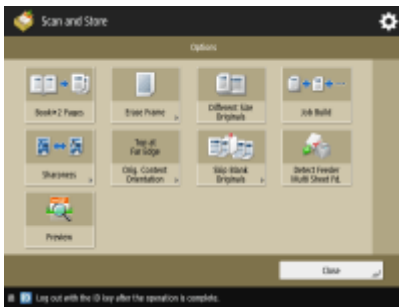

- ▶ **Book>2 Pages(P. 666)**
- ▶ **Erase Frame(P. 662)**
- ▶ **Different Size Originals(P. 665)**
- ▶ **Job Build(P. 670)**
- ▶ **Sharpness(P. 661)**
- ▶ **Orig. Content Orientation(P. 655)**
- ▶ **Skip Blank Originals(P. 673)**
- ▶ **Detect Feeder Multi Sheet Fd.(P. 654)**
- ▶ **Preview(P. 675)**

■ Memory Media

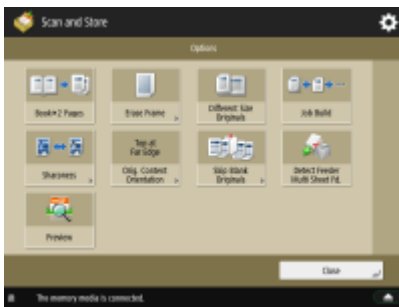

- ▶ **Book>2 Pages(P. 666)**
- ▶ **Erase Frame(P. 662)**
- ▶ **Different Size Originals(P. 665)**
- ▶ **Job Build(P. 670)**
- ▶ **Sharpness(P. 661)**
- ▶ **Orig. Content Orientation(P. 655)**
- ▶ **Skip Blank Originals(P. 673)**
- ▶ **Detect Feeder Multi Sheet Fd.(P. 654)**
- ▶ **Preview(P. 675)**

Access Stored Files

961F-0XS

- ▶ **Storage Selection Screen(P. 1545)**
- ▶ **File Selection Screen(P. 1546)**
- ▶ **Send Screen(P. 1548)**
- ▶ **Send Screen Options(P. 1548)**
- ▶ **Print Screen(P. 1549)**
- ▶ **Print Settings Screen(P. 1549)**
- ▶ **Print Settings Screen Options(P. 1551)**

NOTE

- Some of the modes described here are referring to the mode of the <Scan and Send> function.

Storage Selection Screen



- ▶ **Mail Box(P. 729)**
- ▶ **Advanced Space(P. 713)**
- ▶ **Network(P. 722)**
- ▶ **Memory Media(P. 743)**

■ Advanced Space

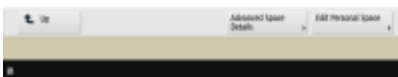

- ▶ **Advanced Space Details(P. 713)**
- ▶ **Edit Personal Space(P. 717)**

■ Network

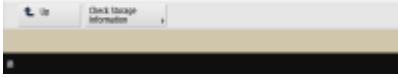
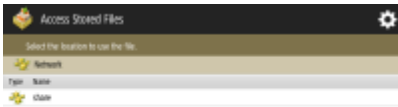

▶ Check Storage Information(P. 722)

■ Memory Media

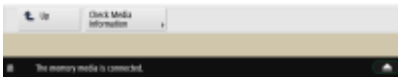
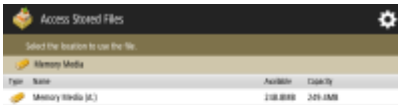

▶ Check Media Information(P. 743)

File Selection Screen

■ Mail Box

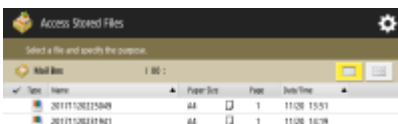

(Items shown on the screen may differ depending on your model and options.)

- ▶ List(P. 730)
- ▶ Thumbnail(P. 730)
- ▶ Up(P. 731)
- ▶ Update(P. 731)
- ▶ Select All (Max 100 Files)(P. 731) / ▶ Clear Selection(P. 731)
- ▶ Print List(P. 730)
- ▶ Details(P. 730)
- ▶ Display Image(P. 730)
- ▶ Edit File(P. 730)
- ▶ Send(P. 736)
- ▶ Print(P. 734)

■ Advanced Space



- ▶ Search(P. 713)
- ▶ Up(P. 714)
- ▶ Update(P. 714)
- ▶ Folder Operations(P. 714)
- ▶ Clear Selection(P. 714)
- ▶ Details(P. 714)
- ▶ Display Image(P. 714)
- ▶ Edit File(P. 714)
- ▶ Print(P. 718)

■ Network

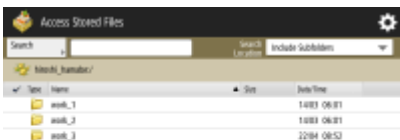

- ▶ Search(P. 713)
- ▶ Up(P. 714)
- ▶ Update(P. 714)
- ▶ Folder Operations(P. 714)
- ▶ Clear Selection(P. 714)
- ▶ Details(P. 714)
- ▶ Display Image(P. 714)
- ▶ Edit File(P. 714)
- ▶ Print(P. 723)

■ Memory Media

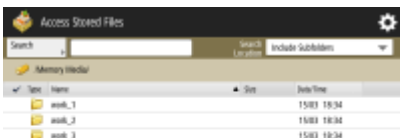

- ▶ Search(P. 713)
- ▶ Up(P. 744)

- ▶ Update(P. 744)
- ▶ Folder Operations(P. 744)
- ▶ Clear Selection(P. 744)
- ▶ Details(P. 744)
- ▶ Display Image(P. 744)
- ▶ Edit File(P. 744)
- ▶ Print(P. 747)

Send Screen

■ Mail Box

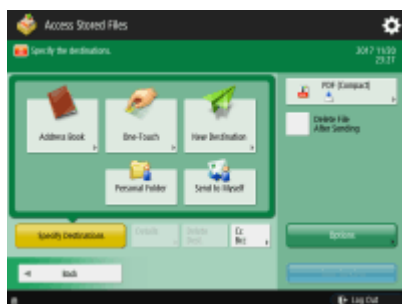

- ▶ Address Book(P. 640)
- ▶ One-Touch(P. 640)
- ▶ New Destination(P. 640)
- ▶ Personal Folder(P. 640)
- ▶ Send to Myself(P. 640)
- ▶ Specify Destinations(P. 640)
- ▶ Details(P. 640)
- ▶ Delete Dest.(P. 640)
- ▶ Cc Bcc(P. 640)
- ▶ File Format(P. 645)
- ▶ Delete File After Sending(P. 736)
- ▶ Options(P. 638)

Send Screen Options

■ Mail Box

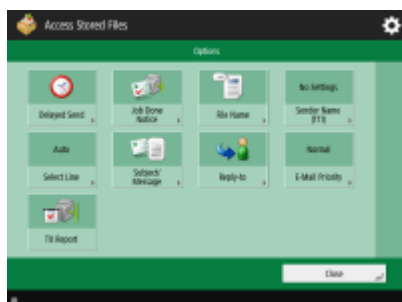

- ▶ Delayed Send(P. 677)
- ▶ Job Done Notice(P. 679)
- ▶ File Name(P. 693)
- ▶ Sender Name (TTI)(P. 538)
- ▶ Select Line(P. 538)

- ▶ Subject/Message(P. 695)
- ▶ Reply-to(P. 695)
- ▶ E-Mail Priority(P. 696)
- ▶ TX Report(P. 654)

Print Screen

■ Mail Box

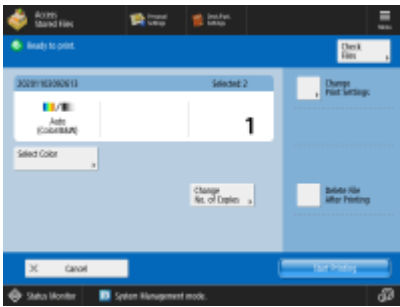

- ▶ Check Files(P. 753)
- ▶ Select Color(P. 752)
- ▶ Change Print Settings(P. 753)
- ▶ Change No. of Copies(P. 734)
- ▶ Delete File After Printing(P. 753)

Print Settings Screen

■ Mail Box

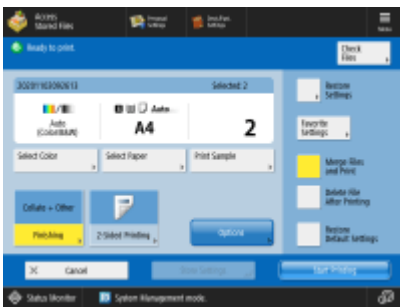

(Items shown on the screen may differ depending on your model and options.)

- ▶ Check Files(P. 753)
- ▶ Select Color(P. 752)
- ▶ Select Paper(P. 752)
- ▶ Print Sample(P. 752)
- ▶ Finishing(P. 754)
- ▶ 2-Sided Printing(P. 754)
- ▶ Options(P. 754)
- ▶ Restore Settings(P. 753)
- ▶ Favorite Settings(P. 754)
- ▶ Merge Files and Print(P. 754)
- ▶ Delete File After Printing(P. 753)
- ▶ Restore Default Settings(P. 754)
- ▶ Store Settings(P. 754)

■ Advanced Space



- ▶ Check Files(P. 753)
- ▶ Select Color(P. 756)
- ▶ Select Paper(P. 756)
- ▶ Finishing(P. 757)
- ▶ 2-Sided Printing(P. 757)
- ▶ Change No. of Copies(P. 718)
- ▶ Options(P. 757)
- ▶ Favorite Settings(P. 757)
- ▶ Print Range(P. 757)
- ▶ Restore Default Settings(P. 757)

■ Network

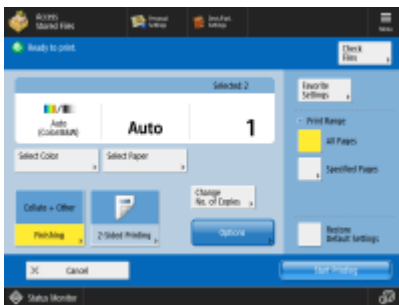

- ▶ Check Files(P. 753)
- ▶ Select Color(P. 756)
- ▶ Select Paper(P. 756)
- ▶ Finishing(P. 757)
- ▶ 2-Sided Printing(P. 757)
- ▶ Change No. of Copies(P. 723)
- ▶ Options(P. 757)
- ▶ Favorite Settings(P. 757)
- ▶ Print Range(P. 757)
- ▶ Restore Default Settings(P. 757)

■ Memory Media

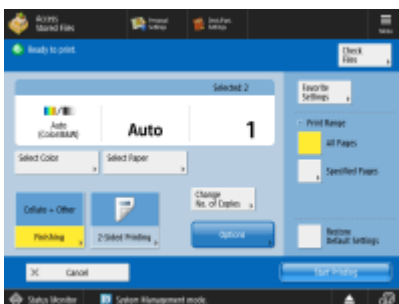

- ▶ Check Files(P. 753)
- ▶ Select Color(P. 756)
- ▶ Select Paper(P. 756)
- ▶ Finishing(P. 757)
- ▶ 2-Sided Printing(P. 757)
- ▶ Change No. of Copies(P. 747)
- ▶ Options(P. 757)
- ▶ Favorite Settings(P. 757)
- ▶ Print Range(P. 757)
- ▶ Restore Default Settings(P. 757)

Print Settings Screen Options

■ Mail Box

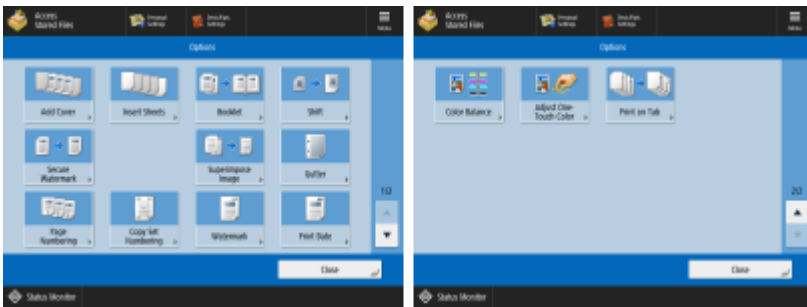

(Items shown on the screen may differ depending on your model and options.)

- ▶ Add Cover(P. 755)
- ▶ Insert Sheets(P. 755) / ▶ Job Separator(P. 755)
- ▶ Booklet(P. 755)
- ▶ Shift(P. 755)
- ▶ Secure Watermark(P. 755)
- ▶ Gutter(P. 755)
- ▶ Page Numbering(P. 755)
- ▶ Copy Set Numbering(P. 755)
- ▶ Watermark(P. 755)
- ▶ Print Date(P. 756)
- ▶ Color Balance(P. 756)
- ▶ Adjust One-Touch Color(P. 756)

■ Advanced Space

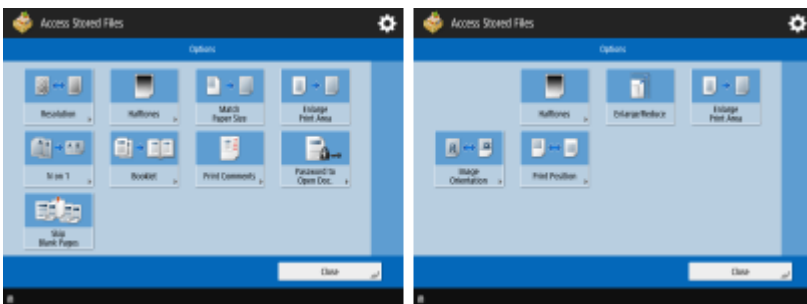

- ▶ Resolution(P. 758)
- ▶ Halftones(P. 758)
- ▶ Match Paper Size(P. 758)
- ▶ Enlarge Print Area(P. 758)

- ▶ **N on 1(P. 758)**
- ▶ **Booklet(P. 758)**
- ▶ **Print Comments(P. 758)**
- ▶ **Password to Open Doc.(P. 758)**
- ▶ **Skip Blank Pages(P. 759)**
- ▶ **Enlarge/Reduce(P. 759)**
- ▶ **Image Orientation(P. 759)**
- ▶ **Print Position(P. 759)**

■ **Network**

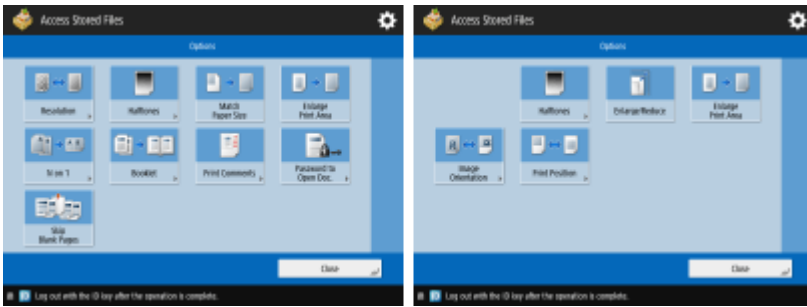

- ▶ **Resolution(P. 758)**
- ▶ **Halftones(P. 758)**
- ▶ **Match Paper Size(P. 758)**
- ▶ **Enlarge Print Area(P. 758)**
- ▶ **N on 1(P. 758)**
- ▶ **Booklet(P. 758)**
- ▶ **Print Comments(P. 758)**
- ▶ **Password to Open Doc.(P. 758)**
- ▶ **Skip Blank Pages(P. 759)**
- ▶ **Enlarge/Reduce(P. 759)**
- ▶ **Image Orientation(P. 759)**
- ▶ **Print Position(P. 759)**

■ **Memory Media**

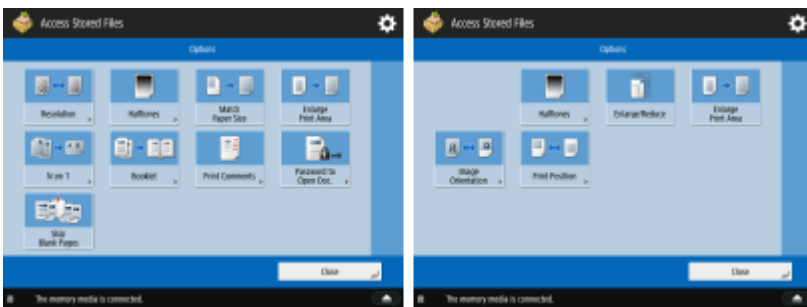

- ▶ **Resolution(P. 758)**
- ▶ **Halftones(P. 758)**
- ▶ **Match Paper Size(P. 758)**
- ▶ **Enlarge Print Area(P. 758)**
- ▶ **N on 1(P. 758)**
- ▶ **Booklet(P. 758)**
- ▶ **Print Comments(P. 758)**
- ▶ **Password to Open Doc.(P. 758)**
- ▶ **Skip Blank Pages(P. 759)**
- ▶ **Enlarge/Reduce(P. 759)**
- ▶ **Image Orientation(P. 759)**

 **Print Position(P. 759)**

Fax/I-Fax Inbox

- ▶ **Memory RX Inbox(P. 1554)**
- ▶ **Confidential Fax Inbox(P. 1555)**

Memory RX Inbox

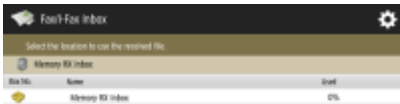

- ▶ **Memory RX Inbox(P. 566)**
- ▶ **Divided Data RX Inbox(P. 566)**

■ Memory RX Inbox

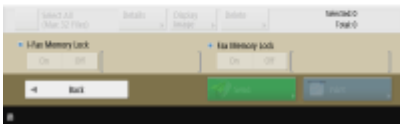
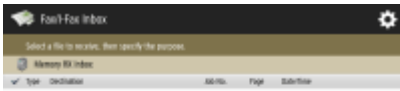

(Items shown on the screen may differ depending on your model and options.)

- ▶ **Select All (Max 32 Files)(P. 567) / ▶ Clear Selection(P. 567)**
- ▶ **Details(P. 567)**
- ▶ **Display Image(P. 567)**
- ▶ **Delete(P. 567)**
- ▶ **I-Fax Memory Lock(P. 566)**
- ▶ **Fax Memory Lock(P. 566)**
- ▶ **Send(P. 567)**
- ▶ **Print(P. 566)**

■ Divided Data RX Inbox



- ▶ **Divided Data List(P. 566)**
- ▶ **Delete(P. 567)**
- ▶ **Print When Deleted(P. 567)**

Confidential Fax Inbox



- ▶ **Details(P. 569)**
- ▶ **Display Image(P. 569)**
- ▶ **Delete(P. 569)**
- ▶ **Print(P. 569)**

Print

961F-0XW

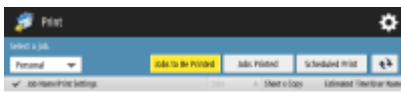

- ▶ **Personal/Shared/Group(P. 608)**
- ▶ **Jobs to Be Printed(P. 609)**
- ▶ **Jobs Printed(P. 609)**
- ▶ **Scheduled Print(P. 609)**
- ▶ **Select All (Max 100 jobs)(P. 610) / ▶ Clear Selection(P. 610)**
- ▶ **Print Settings(P. 609)**
- ▶ **Display Image(P. 609)**
- ▶ **Delete Job(P. 609)**
- ▶ **Cancel Printing(P. 609)**

MEAP

961F-0XX

MEAP (Multifunctional Embedded Application Platform) is a framework for enhancing and optimizing various functions installed on the machine such as "Communication," "Authentication" and "Output." For instance, user management using IC cards and collaboration with software which streamlines file processing becomes possible through MEAP. To enhance functions as stated before, you are required to install a dedicated application called a "MEAP application" on the machine. You can install MEAP applications and check their usage status by displaying the SMS (Service Management Service) from the Remote UI. In order to install a MEAP application, you are required to log in as an administrator (> **Logging into the Machine(P. 355)**).



NOTE

- SMS will always use encrypted TLS communications, regardless of the setting of <Use TLS> in <MEAP Settings>. Therefore, if the default key for SSL is not set in advance, you cannot log in to SMS. > **Configuring the Key and Certificate for TLS(P. 864)**
- Multiple users cannot log in to SMS at the same time.

■ Installing MEAP Applications

You can install MEAP applications and configure the necessary settings to use the MEAP applications.



> Installing MEAP Applications(P. 1559)

■ Managing MEAP Applications

This section describes how to check the MEAP applications you installed, how to uninstall the applications, and how to manage the licenses.

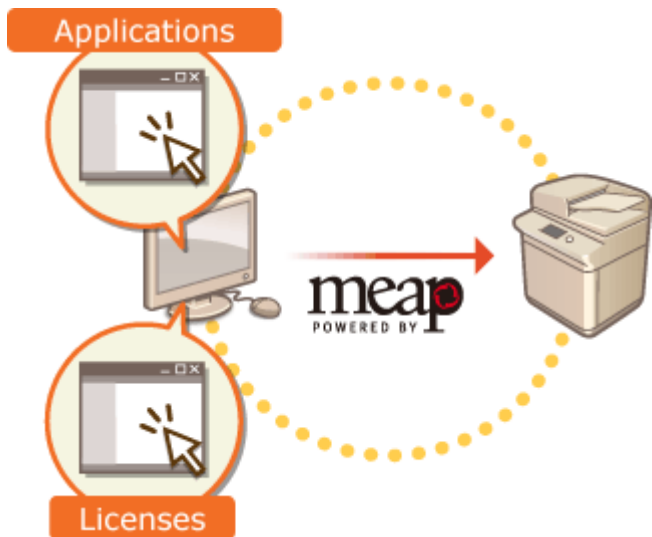

- ▶ Managing MEAP Applications(P. 1562)
- ▶ Managing MEAP Application Licenses(P. 1567)

Installing MEAP Applications

961F-0XY

Before installing a MEAP application, you must acquire the "license file" using a computer. After acquiring the license file, display the SMS from the Remote UI to install the MEAP application.



▶ **Acquiring the License File(P. 1559)**

▶ **Installing the Application(P. 1560)**

NOTE

- You can check the number of applications installed and the storage device space being used. ▶ **Managing MEAP Applications(P. 1562)**
- If your MEAP application does not come with a License Access Number, your license file will be provided by your MEAP Application provider. The license key and license file described in this section are not required. For more information, see the manual provided with each MEAP application.
- Depending on the MEAP application, it may require a specific condition for installation. For more information, see the user's manual for the MEAP application to be used.
- The maximum number of MEAP applications that can be installed on this machine is 19.

Acquiring the License File

! IMPORTANT

The following information is required for acquiring a license file.

- The "license access number" attached to the package of the MEAP application.
- The "serial number" of the machine displayed in the lower left of the screen when pressing  (Counter/Device Information) or the [Counter/Device Information] key* (Models with an upright control panel).

* You can also check the serial number through the SMS screen. ▶ **Managing MEAP Applications(P. 1562)**

1 Open a Web browser to access <http://www.canon.com/lms/license/>

2 Follow the on-screen instructions to acquire the license file.

⇒ After acquiring the license file, display the SMS to install the MEAP application.

Installing the Application

- 1 Log in to the Remote UI. ▶ Starting the Remote UI(P. 902)
- 2 Click [Service Management Service] on the portal page.
- 3 Click [Install MEAP Application].

- 4 Click [Browse...], specify the application file and the license file, and click [OK].

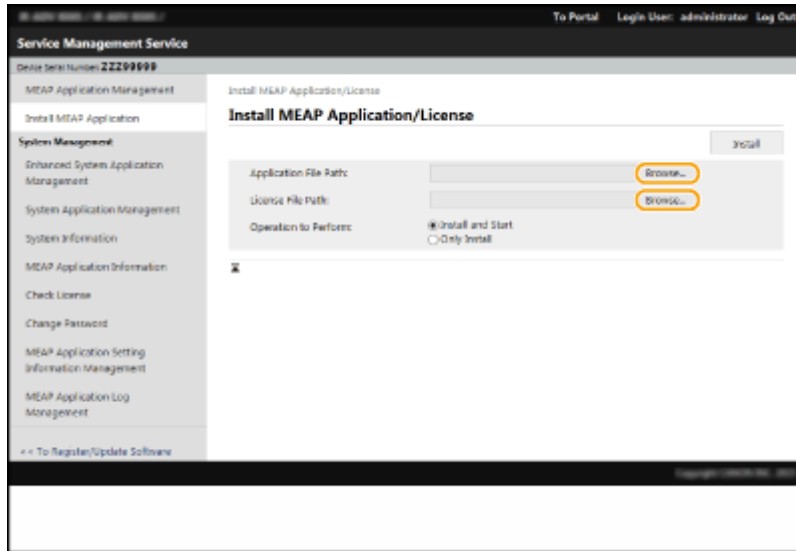

- Files with a ".jar" extension are application files.
- Files with an ".lic" extension are license files.

5 Select the operation to perform after installation.

- To start the application after installation, select [Install and Start]. If you do not want to start the application after installation, select [Only Install].

6 Click [Install] ► [Yes].

- When the licensing screen is displayed, confirm the contents and click [I Accept].
 ► When installation is complete, the MEAP Application Management screen is displayed.

NOTE

- Depending on the MEAP application, the user's manual or related software can be downloaded from the following URL. <http://canon.com/fau/downloads>
- You can upgrade the MEAP application version in the same procedure as the installation. Stop the MEAP application on the SMS screen before installing. ► **Managing MEAP Applications(P. 1562)**
- The maximum amount of storage device that applications can use is approximately 4 GB.
- If the machine is performing its shutdown process while an application is being installed, an error message may be displayed on the Install page for SMS, and the installation may be cancelled. In this case, try installing the MEAP application again after restarting the machine (turn the main power switch Off, and then On). For instructions on turning On/Off the machine, see ► **Turning OFF the Machine(P. 36)** , ► **Turning ON the Machine(P. 35)** .

Managing MEAP Applications

961F-0Y0

In addition to checking details and changing settings, you can upgrade MEAP applications or uninstall applications by using the SMS from the Remote UI.

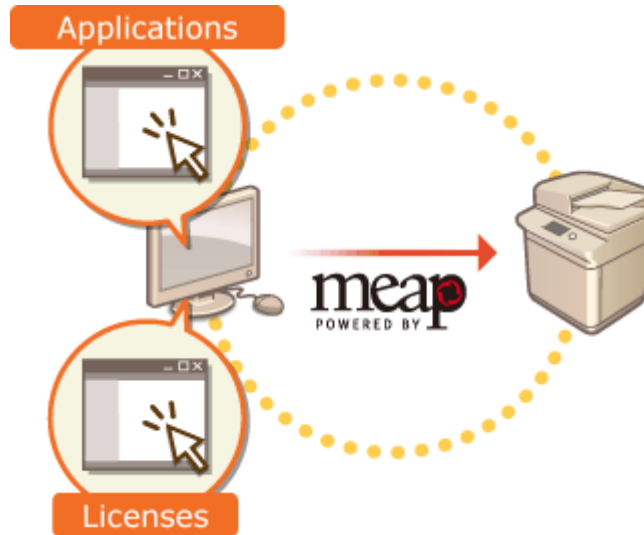

! IMPORTANT

- While you are operating on the SMS screen, do not use the [Back] button on your Web browser, the SMS screen may not operate properly.

- 1 Log in to the Remote UI. ▶ Starting the Remote UI(P. 902)
- 2 Click [Service Management Service] on the portal page.
- 3 Configure the settings on the SMS screen.

Service Management Service

MEAP Application Management

Application Name	Updated	Status	License	
ConfigSample	4.3.0.00	11/11 2015 9:27:20	Started	Stop Uninstall Unnecessary
BasicApplet-Service	2.3.0	11/11 2015 9:27:07	Started	Stop Uninstall Unnecessary
AuthenticationTest	1.0.0.1	11/11 2015 9:26:52	Started	Stop Uninstall Unnecessary
Bundle	4.4.0	11/11 2015 9:26:31	Started	Stop Uninstall Installed

Resource Information

Resource Name	Amount Used	Remaining	Percent Used
Storage	15750 KB	4178256 KB	0%
Memory	2393 KB	278207 KB	1%
Threads	10	441	2%
Sockets	1	343	0%
File Descriptors	13	328	4%

a [Device Serial Number: <Serial Number>]

The machine's serial number is displayed. Use this number when acquiring a license file. ▶ **Acquiring the License File(P. 1559)**

b Menu

If you click an item, the management page for the item appears.

- [MEAP Application Management]: The management of installed MEAP applications is mainly performed on this page.
- [Install MEAP Application]: A page for the installation and update of MEAP applications is displayed. ▶ **Installing MEAP Applications(P. 1559)**
- [System Management]: A page for managing applications and information related to the MEAP system is displayed.

[Enhanced System Application Management]	Installs, uninstalls, and manages system applications that can be enhanced. You can change the login service from this page. ▶ Changing Login Services(P. 1569)
[System Application Management]	Starts and stops the usage of installed system applications. Changing the SMS login method is performed from this page.
[System Information]	Displays the version and the operation status of a system application.
[MEAP Application Information]	Displays a list of applications (excluding system applications) currently installed and already uninstalled.
[Check License]	Displays the detailed information of license files before installation.
[Change Password]	Normally, it is not necessary to change this setting. Configure this setting especially when you use the "DepartmentID Authentication" login service. You must enter between 8 and 32 alphanumeric characters for the password.
[MEAP Application Setting Information Management]	Displays or deletes information related to MEAP application settings. If there is setting information that is shared between the applications, [Shared Setting Information of Applications] is displayed. It can be deleted in the same way as other items.
[MEAP Application Log Management]	Downloads or deletes log data such as the usage history of MEAP applications.

c [Resource Information]

Displays the usage amount, remaining amount, and the usage rate of storage device space as well as memory that is used by a MEAP application and system applications.

d [MEAP Application Management]

Displays a MEAP application name and its version, the date of update, operation status, and the license status.

- If you click a MEAP application name, detailed information such as the company's name and the memory usage amount for each application is displayed. License management is performed from here. ▶ **Managing MEAP Application Licenses(P. 1567)**
- For the operation status, one of the following is displayed.

[Installed]	The MEAP application has been installed, but it is not ready for use. Even if you restart the machine after stopping the use of the MEAP application, [Installed] is displayed.
[Started]	The MEAP application is ready for use.
[Stopped]	The MEAP application is not ready for use.
[Starting]	The MEAP application is starting.

[Stopping]	The MEAP application is stopping.
------------	-----------------------------------

- If you click the [Start] / [Stop] button located on the right side of the operation status, you can start/stop the use of the MEAP application.
- If you click [Uninstall], the MEAP application is uninstalled.
- For the license status, one of the following is displayed.

Depending on the MEAP application, the license file may have a term of validity. In addition, the maximum number (counter) for printing or scanning is predetermined.

[Installed]	The valid license is installed.
[Not Installed]	Unable to use the MEAP application as the license file is not installed or is disabled.
[Over Limit]	Some counters set for the MEAP application exceed the maximum value.
[Invalid]	The validity for the license file has expired or all counters set for the MEAP application exceed the maximum value.
[Unnecessary]	You can use the MEAP application even if you do not have a license file.

NOTE

If [Over Limit] or [Invalid] appears

- If the validity of the license file expires or a counter exceeds the maximum value, the MEAP application cannot be used. By adding a license, you can extend the validity or increase the counter's maximum value.
▶ Managing MEAP Application Licenses(P. 1567)

e [To Portal]/[Log Out]

Click to display the portal page of the Remote UI or the login screen of the Remote UI.

■ Starting or stopping the use of a MEAP application

If you selected [Only Install] in the installation of the MEAP application, you need to start the MEAP application. When you update a MEAP application, stop the MEAP application.

- 1 Click [MEAP Application Management].
- 2 Click [Start] / [Stop] for the MEAP application to be used.

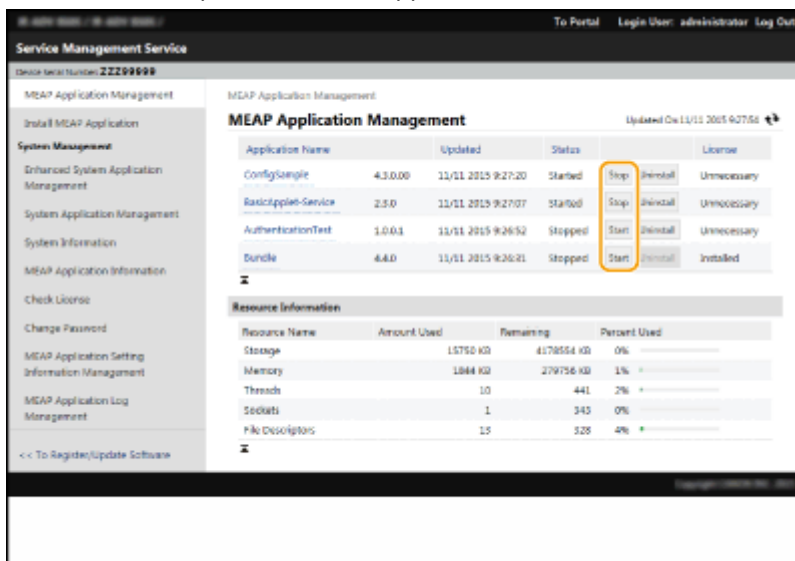

NOTE

- Depending on the MEAP application, you need to restart the machine. Follow the on-screen instructions and restart the machine.
- When the resources required for memory, threads, sockets, or file descriptors has run out, the application will not start, even if you click [Start].

■ Configuring the MEAP application's authentication information

Depending on the MEAP application, you may need to configure authentication information.

NOTE

- If the login application is changed, reconfirm the authentication information in [Set MEAP Authentication]. It may be necessary to re-enter the authentication information.

- 1 Click [MEAP Application Management] ► click an application to set the authentication information.
- 2 Click [Authentication Information Settings].

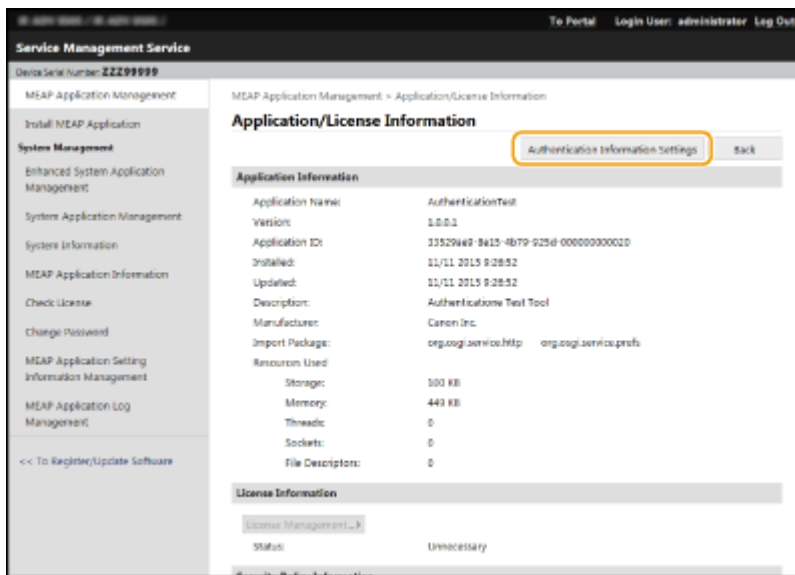

- 3 Enter the user name and password and select the login destination.

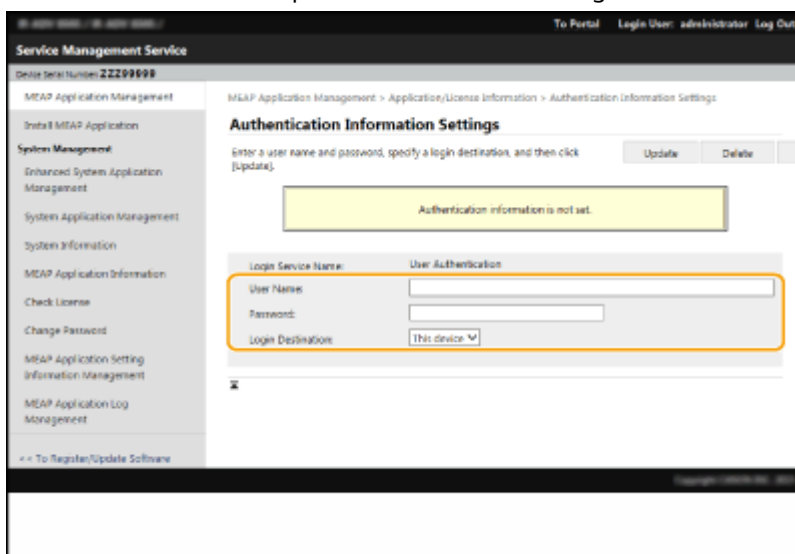

- 4 Click [Update].
- The [Authentication information has been set. Department ID: <ID>] message is displayed.

NOTE**To cancel authentication information**

- Click [Delete] ► [Yes] on the authentication information page in step 3.

■ Uninstalling a MEAP application

When uninstalling a MEAP application, you need to delete the corresponding license files in advance. ► **Managing MEAP Application Licenses(P. 1567)**

- 1 Click [MEAP Application Management] ► [Uninstall] for the application to be uninstalled.

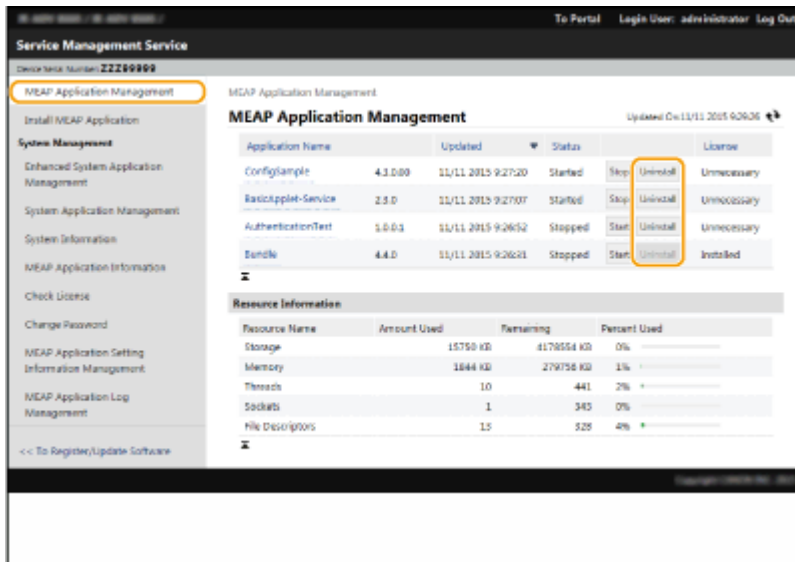

- 2 Click [Yes].
 - If you uninstall a MEAP application, you may be required to restart the machine. Follow the on-screen instructions to restart the machine.

! IMPORTANT

- If the "Export Package of this application will be unavailable." message is displayed, the MEAP application you are uninstalling is linked with other applications. If this MEAP application is uninstalled, other applications may not be able to be used.

- 4 When you finish the operation, click [Log Out].

! IMPORTANT

- When you close the SMS, make sure to log out. If you close the Web browser without logging out, you cannot use the SMS for some time.

Managing MEAP Application Licenses

961F-0Y1

License file operation may be required at times other than installing a MEAP application. For example, even when the licensed counter value or usage period is exceeded or has expired, you can continue to use the MEAP application by adding a license file. In addition, if you want to delete a MEAP application, you are required to delete the license file in advance.

- 1 Log in to the Remote UI. ▶ Starting the Remote UI(P. 902)
- 2 Click [Service Management Service] on the portal page.
- 3 Click [MEAP Application Management], and click the application to manage the license.

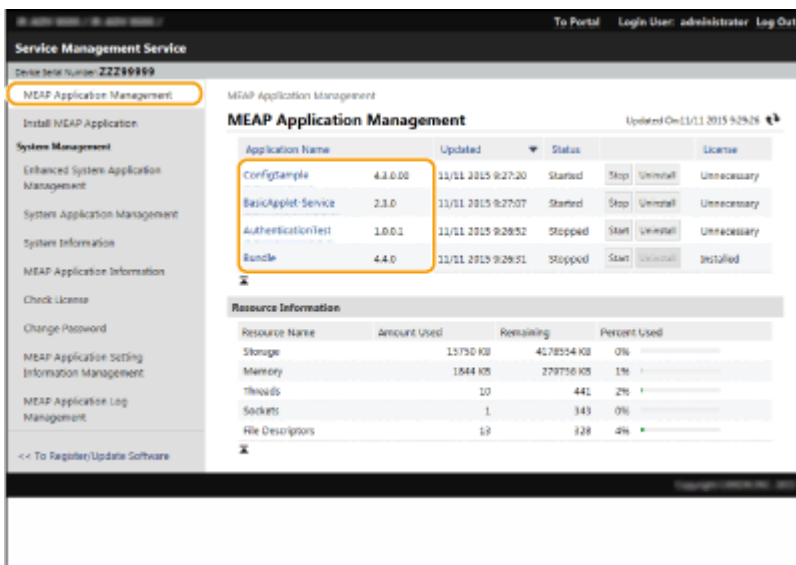

- 4 Click [License Management] and perform the intended operation.

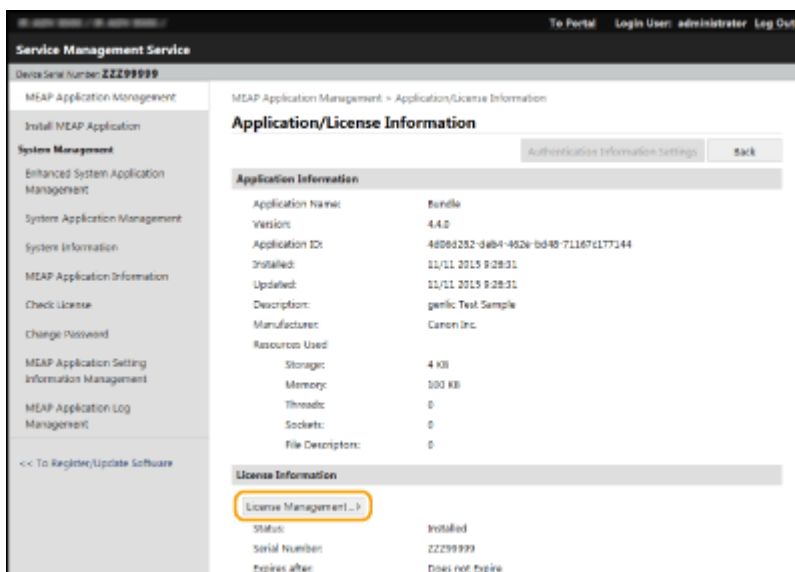

■ Adding a license file

- 1 Click [Browse...], select the license file to install, and click [OK].
- 2 Click [Install] ► [Yes].

▢ Installation starts.

NOTE

- Depending on the MEAP application, you may need to restart (stop and start) the application. ► **Managing MEAP Applications(P. 1562)**

■ Saving the license file on a computer

You can save a backup file on your computer before deleting the license file. If you want to save, you are required to disable the license file in advance.

- 1 Click [Disable] ► [Yes].
- 2 Click [Download], and specify the location to save the license file.

NOTE

- The disabled license file and the license file saved on your computer can be installed on the same machine again.

■ Deleting the license file

Before deleting the license file, you are required to disable the license file in advance.

- 1 Click [Disable] ► [Yes].
- 2 Click [Delete] ► [Yes].

IMPORTANT

- Once you have deleted the disabled license file, you cannot download it from the machine.

NOTE

- When there is an application with a license that will expire soon, you can also check the expiration date of the license from <Check License> for MEAP on the Home of the control panel.

Changing Login Services

961F-0Y2

The application to implement user authentication is called the "Login Service." The machine is set to use "User Authentication (personal authentication management)" for the login service by default. If you want to use "DepartmentID Authentication," change the login service in the SMS.

- ▶ **Changing the Login Service(P. 1569)**
- ▶ **Setting When Using DepartmentID Authentication(P. 1570)**

Changing the Login Service

- 1 Log in to the Remote UI. ▶ Starting the Remote UI(P. 902)**
- 2 Click [Service Management Service] on the portal page.**
- 3 Click [System Application Management] ▶ [Start] in [SMS Installer Service (Password Authentication)].**
 - ⇒ The status becomes [Started].
- 4 Click [Enhanced System Application Management] ▶ [Switch] in [DepartmentID Authentication].**
 - ⇒ The status becomes [Start after Restart].
- 5 Restart the machine. ▶ Restarting the Machine(P. 911)**
 - ⇒ The machine restarts and the changed settings are reflected.

IMPORTANT

When DepartmentID Authentication is started

- If you click [Service Management Service] on the portal page of the Remote UI, the login screen to the SMS is displayed. For security purposes, the machine is configured not to permit login with the default password dedicated for the SMS. Press  (Settings/Registration) ▶ <Management Settings> ▶ <Security Settings> ▶ <Authentication/Password Settings> ▶ <Password Settings> ▶ temporarily set <Allow Use of Default Password for Remote Access> to <On>.
- After logging in to the SMS with the default password, restore the original security level by changing the default password and then resetting <Allow Use of Default Password for Remote Access> to <Off>.
- "MeapSmsLogin" is set as the login password dedicated for the SMS. If you log in with "MeapSmsLogin," the screen for changing the password is displayed. For security purposes, follow the on-screen instructions to change the password.
- The password for the SMS can be changed with [Change Password] in [System Management].

- Make sure that you do not forget your password. Otherwise, you will not be able to access SMS. In this case, contact your dealer or service representative.

Return to User Authentication

- Select [Enhanced System Application Management] ► [User Authentication], click [Switch], and restart the machine. If you will not use SMS Installer Service (Password Authentication), after restart of the machine select [System Application Management] ► [SMS Installer Service (Password Authentication)], and click [Stop].

Setting When Using DepartmentID Authentication

When implementing Department ID Management with the DepartmentID Authentication, make sure that the administrator (system administrator) manages the Department IDs and PINs. To enhance security, log in with the system administrator's ID (System Manager ID) and make sure to change the system administrator's ID and PIN. Which users become administrator or general users depends on whether Department ID Management and System Manager Settings are set, as indicated in the table below.

Department ID Management	System Manager Settings	Administrator	General Users
On	Set	System Manager	Users authenticated with a Department ID and PIN not for the System Manager
	Not Set	Users authenticated with a Department ID and PIN	None
Off	Set	System Manager	Users other than the System Manager
	Not Set	All users	None

■ Changing the System Manager ID and PIN

- 1 Press  (Settings/Registration) ► <Log In>.
- 2 Enter <System Manager ID> and <System Manager PIN> and press <Log In>.
 - Immediately after the DepartmentID Authentication has started, both the System Manager ID and PIN are set as "7654321."
 - You cannot register a Department ID or PIN consisting only of 0s, such as "00" or "0000000".
 - Even if you enter fewer than seven digits, zeros are added to the start of the number, and a seven digit number is set. However, the zeros at the start of the number can be omitted when logging in. For example, even if you enter <2>, <02>, or <002>, the PIN is set as <0000002>. However, you can log in by entering <2>, <02>, or <002>.
- 3 Press <Management Settings> ► <User Management> ► <System Manager Information Settings>.
- 4 Enter the necessary information and press <OK>.
 - Enter the same PIN again for confirmation, and press <OK>.

NOTE

- If you install the Copy Card Reader after changing the System Manager ID and PIN, the ID and PIN return to "7654321."

- When the machine is equipped with the Copy Card Reader, the numbers assigned to each card (1 to 1000 by the factory default) cannot be registered as the System Manager ID and PIN.

■ Enabling Department ID Management

To enable Department ID Management with the DepartmentID Authentication, you need to register the Department ID and PIN.

- 1 Press  (Settings/Registration) ► <Management Settings> ► <User Management> ► <Department ID Management>.
- 2 Press <On>.
 - If you want to manage only with the System Manager ID and PIN without implementing Department ID Management, press <Off>.

IMPORTANT

- If you want to return the login service to the User Authentication and use the Department IDs, set Department ID Management of the DepartmentID Authentication to <Off> and start the User Authentication. Then assign Department IDs to users and set Department ID Management of the User Authentication to <On>.
- 3 Press <Register PIN> ► <Register>.
 - 4 Enter <Department ID> and <PIN> ► press <OK>.
 - Enter the same PIN again for confirmation, and press <OK>.
 - You cannot register a Department ID or PIN consisting only of 0s, such as "00" or "0000000".
 - Even if you enter fewer than seven digits, zeros are added to the start of the number, and a seven digit number is set. However, the zeros at the start of the number can be omitted when logging in. For example, even if you enter <2>, <02>, or <002>, the PIN is set as <0000002>. However, you can log in by entering <2>, <02>, or <002>.
 - If you do not set a PIN, you can use the machine by entering only the Department ID.
 - 5 Press <OK> ► <OK>.

■ Login Operation When Department ID Management Using the DepartmentID Authentication is Enabled

When Department ID Management is enabled, you need to log in to use the machine.

Logging in from the control panel

Enter <Department ID> and <PIN> ► press <Log In>.



NOTE

When Department ID Management is not implemented

- When only the System Manager ID and PIN are set without Department ID Management, you need to log in to the machine only when you want to configure the settings that require the administrator's authority. Press  (Settings/Registration) ► <Log In>, enter <System Manager ID> and <System Manager PIN>, and press <Log In>.

Logging in from the Remote UI

Enter the Department ID in [Department ID] and PIN in [PIN], and click [Log In].



NOTE

When Department ID Management is not implemented

- When only the System Manager ID and PIN are set without Department ID Management, the login methods differ between the system administrator and general users. For the system administrator, enter [System Manager ID]/[System Manager PIN], and then click [Log In (Administrator)]. General users do not need to enter the Department ID and PIN. Click [Log In (General User)].

■ Implementing Function Restrictions and User Management

Configure the settings as necessary.

Checking page totals



 (Settings/Registration) ► <Management Settings> ► <User Management> ► <Department ID Management> ► <Page Totals> ► Check the page total

Setting the maximum number of pages for copy/print/scan



⚙️ (Settings/Registration) ▶ <Management Settings> ▶ <User Management> ▶ <Department ID Management> ▶ <Register PIN> ▶ Select Department ID ▶ <Edit> ▶ <Turn Limit On/Off and Set Page Limit> ▶ Press <On> for functions to restrict ▶ Enter the number of pages ▶ <OK> ▶ <OK> ▶ <OK> ▶ <OK>

Setting Department ID Management on functions other than copy/print



⚙️ (Settings/Registration) ▶ <Management Settings> ▶ <User Management> ▶ <Department ID Management> ▶ <Register PIN> ▶ <Limit Functions> ▶ Press <On> for functions to set Department ID Management on ▶ <OK> ▶ <OK> ▶ <OK>

Deleting Department IDs



⚙️ (Settings/Registration) ▶ <Management Settings> ▶ <User Management> ▶ <Department ID Management> ▶ <Register PIN> ▶ Select the Department ID ▶ <Delete> ▶ <Yes> ▶ <OK> ▶ <OK>

Blocking Printer Jobs and Remote Scan Jobs When Department ID is Unknown



⚙️ (Settings/Registration) ▶ <Management Settings> ▶ <User Management> ▶ <Department ID Management> ▶ Set <Allow Printer Jobs with Unknown IDs> or <Allow Remote Scan Jobs with Unknown IDs> to <Off> ▶ <OK>

Not authenticate black and white copy/print jobs when using Department ID Management



⚙️ (Settings/Registration) ▶ <Management Settings> ▶ <User Management> ▶ <Department ID Management> ▶ Set <Allow Black & White Copy/Print Jobs> or <Allow Black & White Printer Jobs> to <Off> ▶ <OK>

LINKS

▶ [Configuring the Personal Authentication Management Settings\(P. 806\)](#)

Basic Windows Operations

961F-0Y3

- ▶ **Displaying the Printer Folder(P. 1574)**
- ▶ **Displaying Shared Printers in the Print Server(P. 1574)**
- ▶ **Checking the LPR/RAW Printer Port(P. 1575)**
- ▶ **When Printing from the Microsoft Store App(P. 1576)**

NOTE

- Depending on the computer that you use, the operation may differ.

■ Displaying the Printer Folder

Windows 8.1/Server 2012 R2

Right-click [Start] ▶ select [Control Panel] ▶ [View devices and printers].

Windows 10

[

Windows Server 2012

Right-click the lower-left corner of the screen ▶ select [Control Panel] ▶ [View devices and printers].

Windows Server 2016

Right-click [

■ Displaying Shared Printers in the Print Server

1 Open Windows Explorer.

Windows 8.1/Server 2012 R2

Right-click [Start] ▶ select [File Explorer].

Windows 10/Server 2016

Right-click [

Windows Server 2012

Right-click the lower-left corner of the screen ▶ select [File Explorer].

2 Select the print server from [Network].

- To view computers on the network, you may need to turn on network discovery or search the network for computers.

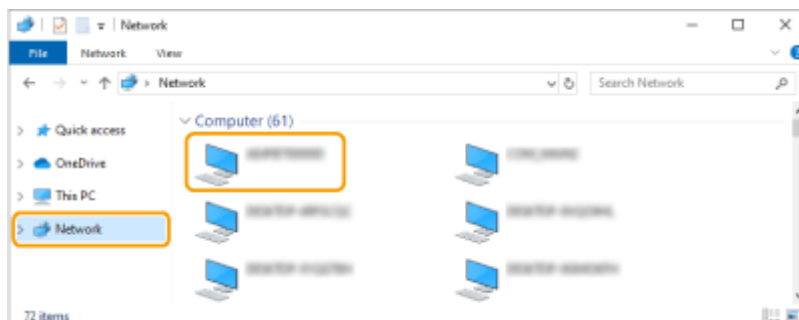

⇒ The shared printer is displayed.

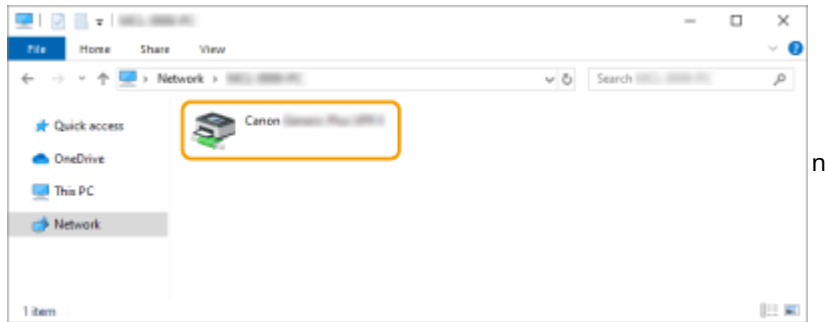

n

■ Checking the LPR/RAW Printer Port

1 Open the printer folder. ▶ Displaying the Printer Folder(P. 1574)

2 Right-click your printer icon of the machine and click [Printer properties].

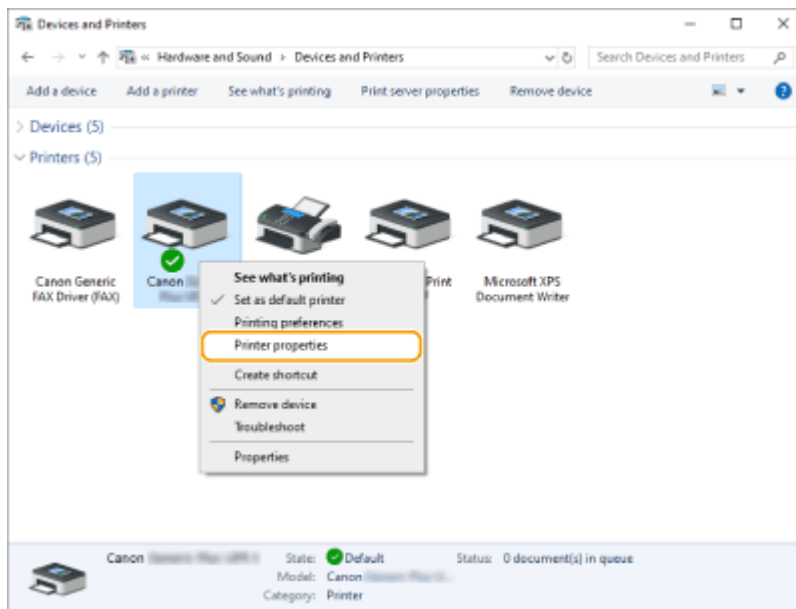

3 Check the port settings.

- Click the [Ports] tab.
- Make sure that the correct port is selected for the printer.

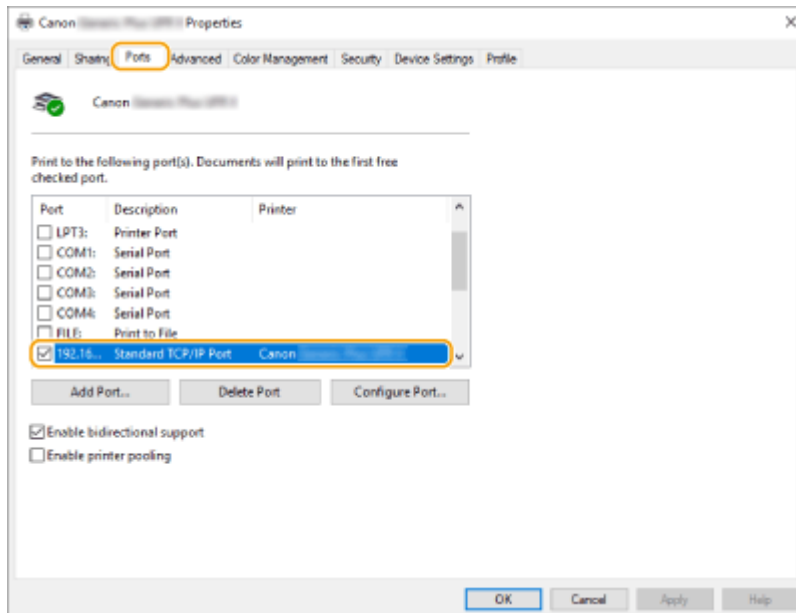

■ When Printing from the Microsoft Store App

Windows 8.1/Server 2012 R2

Display the charms on the right side of the screen ▶ Tap or click [Devices] ▶ [Print] ▶ The driver that you use ▶ [Print].

Windows 10

Tap or click [Print] on the application ▶ The driver that you use ▶ [Print].

Windows Server 2012

Display the charms on the right side of the screen ▶ Tap or click [Devices] ▶ The driver that you use ▶ [Print].

NOTE

- If you print using this method, only a limited number of print settings are available.
- If the message [The printer requires your attention. Go to the desktop to take care of it.] is displayed, go to the desktop and follow the instructions in the displayed dialog box. This message appears when the machine is set to display the user name during printing and similar instances.

System Specifications

961F-0Y4

This section presents the system specifications for this product. Specifications are subject to change without notice for product improvement or future release.

NOTE

- To check the specifications of the main unit and optional equipment for this product, see [▶Hardware Specifications\(P. 215\)](#) .

■ Functional Specifications

- ▶ [Fax Function\(P. 1578\)](#)
- ▶ [Send Functions\(P. 1580\)](#)
- ▶ [Printer Functions\(P. 1582\)](#)
- ▶ [Storage Space Functions\(P. 1585\)](#)
- ▶ [Management Functions\(P. 1586\)](#)

■ Environment To Use the Machine

- ▶ [System Environment\(P. 1593\)](#)
- ▶ [Network Environment\(P. 1595\)](#)
- ▶ [System Options\(P. 1597\)](#)

Fax Function

NOTE

Models with an optional fax function

- To use the fax function, the required fax options must be installed. [▶System Options\(P. 1597\)](#)

Telephone Line Used *1	Public Switched Telephone Network (PSTN)
Scan Line Density	<p>Normal</p> <p>G3: 8 pels^{*2}/mm x 3.85 line/mm</p> <p>Fine</p> <p>G3: 8 pels^{*2}/mm x 7.7 line/mm</p> <p>Super-Fine</p> <p>G3: 8 pels^{*2}/mm x 15.4 line/mm</p> <p>Ultra-Fine</p> <p>G3: 16 pels^{*2}/mm x 15.4 line/mm</p>
Transmission Speed	<p>Super G3: 33.6 kbps</p> <p>G3: 14.4 kbps</p>
Compression Method	MH, MR, MMR, JBIG
Transmission Type	Super G3, G3
Sending Original Sizes	A3, B4, A4, A4R, B5 ^{*3} , B5R ^{*4} , A5 ^{*4} , A5R ^{*4} , 11" x 17", LGL, LTR, LTRR, and STMTR
Receiving Paper Sizes	A3, B4, A4, A4R, B5, B5R, A5, A5R, 11" x 17", LGL, LTR, LTRR, STMTR, 8K, 16K, and 16KR
No. of Memory RX Jobs	Up to 320 jobs
Transmission Times	Approximately 2.6 seconds (When sending A4 Canon original paper, Normal 8 pels x 3.85 line/mm ECM (JBIG))

*1 When using an IP telephone service, facsimile communication may not be performed normally via an IP telephone line. It is recommended to use facsimile communication via a general telephone (Public Switched Telephone Network) line.

*2 Pels stands for picture elements (pixels).

*3 Sent as B4.

*4 Sent as A4.

■ **Max. Destinations for Sequential Broadcast Transmission**

- You can specify and send to up to 256 destinations at the one time. (If you specify a group, which is made up of several destinations, each destination is counted as a separate destination.)

Send Functions

961F-0Y6

■ Push Scan

Type	Color Scanner
Max. Original Scanning Size	Depends on copy specifications
Resolution for Scan	100x100 dpi, 150x150 dpi, 200x100 dpi (Normal), 200x200 dpi (Fine), 200x400 dpi (Superfine), 300x300 dpi, 400x400 dpi (Ultrafine), 600x600 dpi
Scanning Speed	See the feeder specifications.
Interface	1000 Base-T/100 Base-TX/10 Base-T (IEEE 802.3 compliant), Wi-Fi (IEEE 802.11b/g/n)
Protocol Supported	File: FTP (TCP/IP), SMB (TCP/IP), WebDAV E-mail/I-Fax: SMTP (send), POP3 (receive)
Output Format	TIFF (MMR), JPEG*1, PDF (Compact, OCR (Text Searchable)), Optimize PDF for Web, Format to PDF/A, Trace & Smooth, Encrypt), XPS (Compact, OCR (Text Searchable)), PDF/XPS (Device Signature, User Signature), Office Open XML (PowerPoint, Word)

*1 Single-Page only.

■ Pull Scan

Max. Original Scanning Size	Depends on copy specifications
Color mode	Color/Black-and-White Auto Switch, Color, Black-and-White, Grayscale
Resolution for Scan	75 dpi x 75 dpi to 600 dpi x 600 dpi (in 1 dpi increments)
Compatible OS	Windows 10/Windows 11/Windows Server 2012/Windows Server 2012 R2/Windows Server 2016/ Windows Server 2019/Windows Server 2022
Interface	USB2.0High-Speed, 1000Base-T/100Base-TX/10Base-T (IEEE 802.3 compliant), Wi-Fi (IEEE 802.11b/g/n)
Protocol Supported	TCP/IP
Driver	TWAIN compliant, WIA Compliant (Color Network ScanGear 2. For both TWAIN and WIA)

■ Internet/Intranet FAX

Communication Protocol	Internet FAX SMTP (send ^{*1})/POP3 (receive ^{*2}) Intranet FAX SMTP (send/receive ^{*1})
I-Fax Communication Mode	Simple mode, Full mode (ITU-T T.37 and W-NET FAX compliant, color supported)
Max. Original Size	A3
Resolution	Black-and-White 200 dpi x 100 dpi, 200 dpi x 200 dpi, 200 dpi x 400 dpi ^{*3} , 300 dpi x 300 dpi ^{*3} , 400 dpi x 400 dpi ^{*3} , 600 dpi x 600 dpi ^{*3} Color 100 dpi x 100 dpi ^{*3} , 200 dpi x 200 dpi, 300 dpi x 300 dpi ^{*3} , 400 dpi x 400 dpi ^{*3} , 600 dpi x 600 dpi ^{*3}

*1 Supports SMTP authentication and encrypted communication (TLS) during SMTP send/receive

*2 Supports APOP/POP before SMTP and encrypted communication (TLS) during POP RX

*3 Available depending on settings of the other party (capability setting of the receiving machine).

■ Max. Destinations for Sequential Broadcast Transmission

- You can specify and send to up to 256 destinations at the one time. (If you specify a group, which is made up of several destinations, each destination is counted as a separate destination.)

■ Max. Number of Pages That Can Be Sent with One Job

- The maximum number of pages that can be sent with one job is 999.

NOTE

- The maximum number of send jobs that the machine can handle is 64. However, the actual number of send jobs that the machine can handle may be less than 64, depending on the following conditions:
 - When multiple documents are being sent at the same time
 - When large documents are being sent
 - When a large amount of memory is being used for the Mail Box and Fax/I-Fax Inbox

Printer Functions

961F-0Y7

■ UFR II Printer Function

Type	Internal
Print Size	Depends on copy specifications
Print Speed	Depends on copy specifications
Data Processing Resolution	600 dpi x 600 dpi, 1200 dpi x 1200 dpi
Page Description Language (PDL)	UFR II
Protocol Supported	TCP/IP (LPD/Port9100/IPP/IPPS/FTP/WSD)
Compatible OS	<ul style="list-style-type: none"> • Windows 10/Windows 11/Windows Server 2012/Windows Server 2012 R2/Windows Server 2016/Windows Server 2019/Windows Server 2022 • macOS (10.13 or later)
Resident Fonts	None
Interface	USB2.0High-Speed, 1000Base-T/100Base-TX/10Base-T (IEEE 802.3 compliant), Wi-Fi (IEEE 802.11b/g/n)

■ PCL Printer Function

Type	Internal
Print Size	Depends on copy specifications
Print Speed	Depends on copy specifications
Data Processing Resolution	<ul style="list-style-type: none"> • PCL5: 600 dpi x 600 dpi • PCL6: 600 dpi x 600 dpi, 1200 dpi x 1200 dpi
Page Description Language (PDL)	PCL5, PCL6
Protocol Supported	TCP/IP (LPD/Port9100/IPP/IPPS/FTP/WSD)
Compatible OS	Windows 10/Windows 11/Windows Server 2012/Windows Server 2012 R2/Windows Server 2016/Windows Server 2019/Windows Server 2022

Resident Fonts	93 Roman, 10 Bitmap fonts, 2 OCR fonts, Andalé Mono WT J/K/S/T* ¹ (Japanese, Korean, Simplified Chinese, and Traditional Chinese) , Barcode fonts* ²
Interface	USB2.0High-Speed, 1000Base-T/100Base-TX/10Base-T (IEEE 802.3 compliant), Wi-Fi (IEEE 802.11b/g/n)

*1 Requires optional PCL International Font Set

*2 Require optional Barcode Printing Kit

■ PS Printer Function

Type	Internal
Print Size	Depends on copy specifications
Print Speed	Depends on copy specifications
Data Processing Resolution	600 dpi x 600 dpi, 1200 dpi x 1200 dpi
Page Description Language (PDL)	Adobe PostScript 3
Protocol Supported	TCP/IP (LPD/Port9100/IPP/IPPS/FTP/WSD)
Compatible OS	<p>Driver</p> <ul style="list-style-type: none"> Windows 10/Windows 11/Windows Server 2012/Windows Server 2012 R2/Windows Server 2016/Windows Server 2019/Windows Server 2022 macOS (10.13 or later) <p>PPD</p> <ul style="list-style-type: none"> Windows 10/Windows 11 macOS (10.13 or later)
Resident Fonts	136 Roman
Interface	USB2.0High-Speed, 1000Base-T/100Base-TX/10Base-T (IEEE 802.3 compliant), Wi-Fi (IEEE 802.11b/g/n)

■ Functions That Can Be Used with Each Page Description Language and File Format

Functions that can be used with each page description language and file format when using the forced hold print function are indicated below.

Available Functions	Page Description Language				File Format (When Printing with the Direct Print function)		
	UFR II	PS * ⁵	XPS	PCL * ⁶	PDF	JPEG	TIFF
Print	✓	✓	✓	✓	✓	✓	✓

Available Functions	Page Description Language				File Format (When Printing with the Direct Print function)		
	UFR II	PS *5	XPS	PCL *6	PDF	JPEG	TIFF
Change Settings	✓	✓	-	✓	✓	✓	-
No. of Copies	✓	✓	-	✓	✓	✓	-
Print Range*1	✓	✓	-	✓	✓	-	-
Select Color*2	✓	✓	-	✓	✓	✓	-
2-Sided Printing	✓	✓	-	✓	✓	✓	-
Select Paper*1*3	✓	-	-	✓	✓	✓	-
N on 1	✓	-	-	✓	✓	-	-
Staple*1*4	✓	-	-	✓	✓	✓	-
Eco (Staple-Free)*1*4	✓	-	-	✓	✓	✓	-
Booklet*1	✓	-	-	✓	✓	-	-
Hole Punch*1*4	✓	-	-	✓	✓	✓	-
Toner Save*1	✓	✓	-	✓	✓	✓	-
Display Image	✓	-	✓	✓	✓	✓	✓
Delete Page	✓	-	-	✓	-	-	-

*1 You cannot change the print settings when multiple documents are selected.

*2 You can set this only to [Black & White].

*3 You cannot change the paper source if different sizes of paper are specified in the print job.

*4 Indicates items that can be selected only when the appropriate optional equipment is attached to the machine.

*5 Settings can only be changed for jobs from the Canon PS3 printer driver, excluding PPD.

*6 Settings can be changed, or the preview can be displayed only for PCL XL.

NOTE

- Depending on changed settings, the document may not be printed correctly.

Storage Space Functions

961F-0Y8

■ Advanced Space

Storage Capacity	Standard: 16 GB Maximum: 480 GB (optional)
Maximum Path Length	256 characters
Maximum Number of Files a Single Directory Can Hold	1,000 (including folders)
Maximum Number of Files the Advanced Space Can Hold	100,000 (including folders)
Maximum Capacity per File	2 GB
Number of Clients for Allowed Accessing	SMB: 64 WebDAV: 3

■ Mail Box

Number of Boxes	100 boxes
File Format for Storing	Proprietary format
Resolution for Storing	<ul style="list-style-type: none"> ● Copy: (Black and White/Color) 600 dpi x 600 dpi ● Scan and Store: (Black and White/Color) 600 dpi x 600 dpi ● Scan and Send: (Black and White/Color) 100 dpi x 100 dpi, 150 dpi x 150 dpi, 200 dpi x 100 dpi, 200 dpi x 200 dpi, 200 dpi x 400 dpi, 300 dpi x 300 dpi, 400 dpi x 400 dpi, 600 dpi x 600 dpi ● Printer Driver: (Black and White/Color) 600 dpi x 600 dpi, 1200 dpi x 1200 dpi
Disk Capacity	Standard: approximately 65 GB Maximum: 98 GB (optional)
Storage Capacity	2,000 files or 10,000 pages (standard) / 15,000 pages (maximum)*1
Data Storage Period	3 days (can be changed from the Settings/Registration screen)

*1 Includes documents stored in the Fax/I-Fax Inbox. However, these numbers may vary depending on the remaining storage capacity.

Management Functions

961F-0Y9

■ Information Registered in User Authentication

Up to 5,001 users can be registered.

■ Registering Department IDs

Up to 1,000 Department IDs can be registered.

■ Authentication Functions

- When an Active Directory server is specified as an authentication server, the following system environment is required.

Software (operating system):	Windows Server 2012 ^{*1} /Windows Server 2012 R2 ^{*1} /Windows Server 2016 ^{*1} /Windows Server 2019 ^{*1} /Windows Server 2022 ^{*1}
-------------------------------------	--

^{*1} Users cannot log in with Active Directory authentication if Kerberos Armoring is enabled for KDC-related policies (group policies). Make sure to disable Kerberos Armoring.

- Kerberos encryption methods for the Active Directory authentication supported by the current version of User Authentication are as follows.

Encryption method	<ul style="list-style-type: none"> 128-bit AES (Advanced Encryption Standard) 256-bit AES (Advanced Encryption Standard) DES (Data Encryption Standard) RC4
--------------------------	---

NOTE

- The available encryption methods may vary, depending on the Active Directory settings.
- Of the available encryption methods, the one with the highest cipher strength is automatically selected.
- When specifying an Active Directory server as an authentication server, use the following ports^{*1} on the server.

To communicate with a DNS server:	port number 53
To communicate with a KDC (Key Distribution Center):	port number 88
To communicate with a server for LDAP directory service (can be changed to an arbitrary port number for the LDAP service):	port number 389

^{*1} The above port numbers are default values. These numbers may vary depending on the selected settings.

- When specifying an LDAP server as an authentication server, the following system environment is required.

Software:	OpenLDAP
Operating system:	Requirements are pursuant to the product specifications of the LDAP server.

- When specifying an LDAP server as an authentication server, use the following ports*1 on the server.

To communicate with the LDAP server using LDAP (when TLS is enabled):	port number 636
To communicate with the LDAP server using LDAP (when TLS is disabled):	port number 389

*1 The port numbers can be changed according to the LDAP server settings.

■ Firewall Settings

- When specifying IP addresses in firewall settings, up to 16 IP addresses (or ranges of IP addresses) can be specified for both IPv4 and IPv6.
- When specifying MAC addresses in firewall settings, up to 100 MAC addresses can be specified.
- The exception addresses and exception port numbers that can be used for communication using the sub line and are registered by default are indicated below.

Exception addresses:	0.0.0.1 to 255.255.255.255
Exception port numbers:	53, 67, 68, 80, 161, 443, 515*, 631*, 3702, 5353, 5357, 5358, 8000*, 8080, 8443*, 9013, 9100*, 10443*, 20010*, 47545

* Inbound filter only

■ Registration of Certificates (User Signature Keys/Certificates, CA Certificates, S/MIME Certificates)

- The algorithms and formats of keys and certificates that can be registered are as follows.

RSA signature algorithm:	SHA-1*1/SHA-256/SHA-384*2/SHA-512*2/MD2*1*3/MD5*1*3
RSA public-key algorithm (key length):	RSA (512 bits*3/1024 bits/2048 bits/4096 bits*3)
DSA signature algorithm:	SHA-1*1*3
DSA public-key algorithm (key length):	DSA (1024 bits/2048 bits/3072 bits)*1*3
ECDSA signature algorithm:	SHA-1*1*3/SHA-256/SHA-384/SHA-512
ECDSA public-key algorithm (key length):	ECDSA (P256/P384/P521)
Certificate format:	User Signature Keys/Certificates: PKCS#12*1 Keys, Certificates: PKCS#12*1*4

	CA Certificates, S/MIME Certificates: X.509 DER/PEM
File extension:	User Signature Keys/Certificates: pfx/p12 Keys, Certificates: pfx/p12*4 CA Certificates, S/MIME Certificates: cer/pem
Maximum number of registerable certificates:	User Signature Keys/Certificates: 100 (one user certificate per user) Keys, Certificates: 6*4 CA Certificates: 150 S/MIME Certificates: 2,000

*1 Available only when installed by using the Remote UI.

*2 Available only when the key algorithm is 1024 bits or more.

*3 Cannot be used for user signatures

*4 Used for TLS, IEEE802.1x, IPSec, and device signatures.

■ Registration of Certificate Revocation Lists (CRL)

Up to 50 certificate revocation lists (CRL) can be registered. Note, however, that CRL cannot be registered in the following cases.

- The data size of the CRL exceeds 1 MB.
- An unsupported signature algorithm is being used.
- The number of revoked certificates registered in one CRL file exceeds 10,000.

■ Definition of "Weak Encryption"

When <Prohibit Use of Weak Encryption> is set to <On>, the use of the following algorithms are prohibited.

Hash:	MD4, MD5, SHA-1
HMAC:	HMAC-MD5
Common key cryptosystem:	RC2, RC4, DES
Public key cryptosystem:	RSA encryption (512 bits/1024 bits), RSA signature (512 bits/1024 bits), DSA (512 bits/1024 bits), DH (512 bits/1024 bits)

NOTE

- Even when <Prohibit Use of Key/Certificate with Weak Encryption> is set to <On>, the hash algorithm SHA-1, which is used for signing a root certificate, can be used.

■ FIPS 140-2 Standard Algorithm

When <Format Encryption Method to FIPS 140-2> is set to <On>, the following algorithms are prohibited from use.

Hash:	MD4, MD5, SHA-1 (for a purpose other than TLS)
Common key cryptosystem:	RC2, RC4, DES, PBE
Public key cryptosystem:	RSA encryption (512 bits/1024 bits), RSA signature (512 bits/1024 bits), DSA signature (512 bits/1024 bits), DH (512 bits/1024 bits)

■ Log Management

- The following types of logs can be managed on the machine. Collected logs can be exported in the CSV file format.

Log Type	Number Indicated as "Log Type" in the CSV File	Description
User Authentication Log	4098	This log contains information related to the authentication status of user authentication (login/logout and user authentication success/failure), the registering/changing/deleting of user information managed with User Authentication, and the management (adding/editing/deleting) of roles with the ACCESS MANAGEMENT SYSTEM.
Job Log	1001	This log contains information related to the completion of copy/fax/scan/send/print jobs.
Transmission Log	8193	The log contains information related to transmissions.
Advanced Space Save Log	8196	This log contains information related to the saving of files to the Advanced Space, Network (Advanced Space of other machines), and Memory Media.
Mail Box Operation Log	8197	This log contains information related to the operations performed on data in the Mail Box, the Memory RX Inbox, and the Confidential Fax Inbox.
Mail Box Authentication Log	8199	This log contains information related to the authentication status of the Mail Box, the Memory RX Inbox, and the Confidential Fax Inbox.
Advanced Space Operation Log	8201	This log contains information related to data operations in the Advanced Space.
Machine Management Log	8198	This log contains information related to the starting/shutting down of the machine, changes made to the settings by using the  (Settings/Registration), changes made to the settings by using the Device Information Delivery function, and the time setting. The Machine Management Log also records changes in user information or security-related settings when the machine is inspected or repaired by your dealer or service representative.
Network Authentication Log	8200	This log is recorded when IPSec communication fails.
Export/Import All Log	8202	This log contains information related to the importing/exporting of the settings by using the Export All/Import All function.

Mail Box Backup Log	8203	Log for backups of the following: <ul style="list-style-type: none"> • User Inboxes • Memory RX Inbox • Confidential Fax Inbox • Advanced Space
Application/Software Management Screen Operation Log	3101	This is an operation log for SMS (Service Management Service), software registration/updates, and MEAP application installers, etc.
Security Policy Log	8204	This log contains information related to the setting status of the security policy settings.
Group Management Log	8205	This log contains information related to the setting status (registering/editing/deleting) of the user groups.
System Maintenance Log	8206	This log contains information related to firmware updates and backup/restoration of the MEAP application, etc.
Authentication Print Log	8207	This log contains information and the operation history related to the forced hold print jobs.
Setting Synchronization Log	8208	This log contains information related to the synchronization of machine settings. ▶Synchronizing Settings for Multiple Canon Multifunction Printers(P. 988)
Log for Audit Log Management	3001	This log contains information related to the starting and ending of this function (the Audit Log Management function), as well as the exporting of logs, etc.

NOTE

- Logs can contain up to 40,000 records. When the number of records exceeds 40,000, they are deleted, with the oldest records first.

■ Import/Export of the Setting Data

See **▶Settings/Registration(P. 1054)** .

■ Data Backup/Restoration

To back up or restore data, you can use an external storage device that meets the following requirements.

Interface:	USB 2.0/USB 3.0
File system:	FAT32/exFAT
Partition size:	more than 32 GB (Must not be divided into multiple partitions)
Power supply:	must supply power from an external power source

■ Number of machines and users supported by synchronization of custom settings (server)

- Number of synchronizable machines in a group: 10
- Number of synchronizable users for personalized setting values: 1,000

■ Maximum number of users whose setting information can be saved in the machine

- Users: 500
- Groups: 50

■ Max. Buttons Registered on the <Home> Screen

- Max. number of Personal buttons: 60 per user (total of 12,000 for all users)
- Max. number of Shared buttons: 60

■ Max. Destinations Registered to Address Book

- Address Lists 1 to 10/ Address List for Administrator: 1,600
- One-Touch Address List: 200
- Personal Address List: 25
- Group Address List: 4,000*¹ (10 groups*² x 400 destinations*³)

*1 Total 20,000 for all groups

*2 Max. number of groups per user (a total of 50 groups can be registered in a device)

*3 Max. number of destinations per group

■ Images That Can Be Imported for Login Screen Background

- File Size: 1,024 KB
- File Extension: jpg, jpeg, or png
- Image Size: 800 pixels x 486 pixels or smaller

■ Visual Message Specifications

File Format	JPEG, PNG, BMP, GIF, Animated GIF, and HTML (on the intranet/internet)
Communication Protocol	SMB, WebDAV, HTTP
Maximum size of the contents	Max. 10 MB
Image Size	Other than HTML: 799 pixels x 509 pixels* * If the image is larger than the above size, it is displayed in a reduced size without changing its aspect ratio. If the image is smaller than the above size, it is displayed without changing the size. HTML: over 799 pixels x 509 pixels can be used (by scrolling through them)

■ SCEP Server Support

Only the Network Device Enrollment Service (NDES) of Windows Server 2008 R2/2012 R2/2016 is supported.

System Environment

961F-0YA

WSD Scan	<ul style="list-style-type: none"> • Windows 10 • Windows 11 • WindowsServer 2012 • WindowsServer 2012 R2 • WindowsServer 2016 • WindowsServer 2019 • WindowsServer 2022
System requirements for the Remote UI *1	<p>Windows</p> <ul style="list-style-type: none"> • Microsoft Edge • Google Chrome <p>Mac OS</p> <ul style="list-style-type: none"> • Safari 11 or later • Google Chrome
Compatible mail forwarding server software	<ul style="list-style-type: none"> • Microsoft Exchange Server 2016 • Microsoft Exchange Server 2019 • Sendmail 8.15.2
Compatible mail receiving server software	<ul style="list-style-type: none"> • Microsoft Exchange Server 2016 • Microsoft Exchange Server 2019 • Qpopper 4.1.0
File servers available as destinations for file transmission	<p>FTP</p> <ul style="list-style-type: none"> • Windows Server 2012: Internet Information Services 8.0 • Windows Server 2012 R2: Internet Information Services 8.5 • Windows 10/11/Server 2016/Server 2019/Server 2022: Internet Information Services 10 • Cent OS Stream 8 <p>Windows (SMB)</p> <ul style="list-style-type: none"> • Windows 10 • Windows 11 • Windows Server 2012 • Windows Server 2012 R2 • Windows Server 2016 • Windows Server 2019 • Windows Server 2022 • macOS Catalina • macOS Big Sur • macOS Monterey • Cent OS Stream 8 <p>WebDAV</p> <ul style="list-style-type: none"> • Windows Server 2012: Internet Information Services 8.0 • Windows Server 2012 R2: Internet Information Services 8.5

Appendix

	<ul style="list-style-type: none"> ● Windows 10/11/Server 2016/Server 2019/Server 2022: Internet Information Services 10 ● macOS Catalina ● macOS Big Sur ● macOS Monterey ● Cent OS Stream 8
Windows servers allowed for accessing the Advanced Space	<p>SMB server</p> <ul style="list-style-type: none"> ● Windows Server 2012 ● Windows Server 2016 ● Windows Server 2019 ● Windows Server 2022 <p>WebDAV server</p> <ul style="list-style-type: none"> ● Windows Server 2012: Internet Information Services 8.0 ● Windows Server 2016: Internet Information Services 10.0 ● Windows Server 2019 ● Windows Server 2022
Client computers allowed for accessing the Advanced Space	<ul style="list-style-type: none"> ● Windows 10 ● Windows 11
Types of LDAP servers	<ul style="list-style-type: none"> ● Windows Server 2012 with Active Directory ● Windows Server 2012 R2 with Active Directory ● Windows Server 2016 with Active Directory ● Windows Server 2019 with Active Directory ● Windows Server 2022 with Active Directory

*1 Before changing the settings of the machine, set your Web browser to enable all cookies and use JavaScript.

Network Environment

961F-0YC

■ Wired LAN Specifications

Interface (Primary line/Secondary line)	10Base-T/100Base-TX/1000Base-T (RJ-45)
Protocol Supported	<p>TCP/IP</p> <ul style="list-style-type: none"> ● Frame type: Ethernet II ● Print applications: LPD/Raw/IPP/IPPS/FTP/WSD/Mopria/AirPrint/Windows 10 Mobile Print/Universal Print

NOTE

- For precautions related to the sub line, see [▶ Cautions When Using the Sub Line\(P. 1524\)](#) .

■ Wireless LAN Specifications

Standard	IEEE 802.11b, IEEE 802.11g, IEEE 802.11n
Transmission Scheme	<ul style="list-style-type: none"> ● IEEE 802.11b (Modulation system: DS-SS) ● IEEE 802.11g (Modulation system: OFDM method) ● IEEE 802.11n (Modulation system: OFDM method)
Security (encryption method)	<p>Infrastructure Mode</p> <ul style="list-style-type: none"> ● 128 (104)/64 (40) bit WEP ● WPA-PSK (TKIP/AES-CCMP) ● WPA2-PSK (TKIP/AES-CCMP) ● WPA3-SAE (AES-CCMP) ● WPA-EAP (AES-CCMP) ● WPA2-EAP (AES-CCMP) ● WPA3-EAP (AES-CCMP) <p>Access Point Mode</p> <p>WPA2-PSK (AES-CCMP)</p> <p>Wi-Fi Direct Mode</p> <p>WPA2-PSK (AES-CCMP)</p>
Connection Method	WPS (Wi-Fi Protected Setup), Manual setup

Port Numbers Available for Direct Connection

Type	Port Number	Protocol
------	-------------	----------

Appendix

TCP	515	LPD
	9100	RAW
	80, 8000, 8080	HTTP
	80, 631	IPP
	443, 10443	IPPS
	443, 8443	HTTPS
	9013	CPCA (unique Canon protocol)
	5357, 5358	WSD
UDP	161	SNMP
	5353	mDNS
	67, 68	DHCPv4
	3702	WSD
	47545	CPCA (unique Canon protocol)

System Options

961F-0YF

By installing system-related options, you can further enhance the performance of the machine.

▶ File Formats and the Need for Optional Products(P. 1598)

■ Barcode Printing Kit

This option enables you to print barcodes. For more details, see Bar Code Printing via the online manual site.

■ PCL International Font Set

This option enables you to add the following fonts for a PCL printer. As a result, you can output using multiple languages in a SAP Unicode environment.

- Andale® and WorldType® Collection J (Japanese Version)
- Andale® and WorldType® Collection K (Korean Version)
- Andale® and WorldType® Collection S (Simplified Chinese Version)
- Andale® and WorldType® Collection T (Traditional Chinese Version)

In order to support differences in character design depending on the region, four font versions are enabled.

■ Super G3 FAX Board

The "Super G3 FAX Board" enables you to send and receive faxes. You can also send documents that are created in applications directly from your computer via the network. ▶ Faxing(P. 519)

- The fax driver that enables faxing via a computer is included.

■ Super G3 2nd Line Fax Board

This option adds an additional telephone line and enables you to use two lines to send and receive faxes. ▶ Fax Line Settings(P. 314)

- On-Hook is only available with Line 1 (the standard line).

■ Remote Fax Kit

This option is needed to use the Remote Fax function. Even if the machine is not equipped with a fax board, you can send faxes via another imageRUNNER ADVANCE machine with a fax board installed on the same network. ▶ Using Remote Faxes(P. 592)

■ IP FAX Expansion Kit

Enables you to use IP Fax, a function to send and receive faxes in a TCP/IP network such as an office LAN. As devices send and receive faxes within the network, you can reduce the transmission cost. The transmission speed of IP Fax is faster than conventional fax transmissions. For more details, see IP FAX Expansion Kit User's Guide via the online manual site.

■ Voice Guidance Kit

This option enables you to hear voice navigation instructions when operating the machine.

■ Voice Operation Kit

The Voice Operation Kit enables you to hear voice navigation instructions when operating the machine. The Voice Operation Kit also includes a voice recognition function, which enables you to set the various functions of the machine using your own voice.

■ 250GB SSD

The 250GB SSD is necessary when using the Mirroring function of the Memory Mirroring Kit. **▶Using as a Simple File Server(P. 708)**

■ 1TB SSD

By replacing the storage device installed in the machine with the 1TB SSD, you can expand the memory capacity of the machine to 1 TB. **▶Using as a Simple File Server(P. 708)**

NOTE

- Once you replace the storage device with the 1TB SSD, the additional 1TB SSD is required to back up the data by using the Memory Mirroring Kit.

■ Memory Mirroring Kit

The Memory Mirroring Kit enables you to back up the data on the storage device of the machine to the additional optional storage device. Even if one storage device should fail, you can access the other storage device to reduce the risk of data loss.

■ Wireless LAN Board

This option enables you to use a wireless LAN. **▶Connecting to a Wireless LAN(P. 270)**

■ Copy Card Reader

This option enables you to perform Department ID Management through authentication with control card. For details, see **▶Copy Card Reader(P. 208)**

File Formats and the Need for Optional Products

Optional products may be required, depending on the file format and function you want to use. See the following table.

✓: Standard function ●: Optional products required

File Format (Detailed Setting)	Scan and Send / Scan and Store
JPEG	✓
TIFF	✓
PDF (Trace & Smooth)	✓

File Format (Detailed Setting)	Scan and Send / Scan and Store
PDF (Limited Color)	✓
PDF (Compact)	✓
PDF (OCR (Text Searchable))	✓
PDF (Encrypt)	✓
PDF (Device Signature)	✓
PDF (User Signature)	✓
PDF (Format to PDF/A)	✓
XPS (Compact)	✓
XPS (OCR (Text Searchable))	✓
XPS (Device Signature)	✓
XPS (User Signature)	✓
OOXML (Word)	✓
OOXML (PowerPoint)	✓

NOTE

- The following file formats can be used with the Access Stored Files function: JPEG, TIFF, PDF, XPS. To print files in other formats, move the files to your computer and print via the printer driver, etc.

The Software Subjected to Other License Conditions

Please refer to Contents of Software and respective License terms below, for more detail and corresponding license conditions.

Contents of Software

Names of Software

1. Adobe PDF Scan Library	5
2. Adobe PostScript 3.....	8
3. Apache Commons Codec	15
4. Apache Commons Logging.....	22
5. Apache Commons Net.....	27
6. Apache HttpClient.....	31
7. Apache HTTPComponents HttpCore	47
8. Apache log4j.....	51
9. ARM CMSIS (Cortex Microcontroller Software Interface Standard)	55
10. AWS IoT Device SDK	61
11. AWS SDK for Java	66
12. Bootstrap	71
13. Crypto API.....	72
14. Dump	73
15. expat.....	75
16. flipsnap	77
17. fontconfig.....	78
18. freetype2	79
19. HarfBuzz.....	84
20. HttpClient2.0 Alpha1 Release.....	85
21. iw	87
22. Jackson Annotations	88
23. Jackson Core.....	92
24. Jackson Databind	97
25. Jackson Dataformat cbor.....	102
26. Jackson JSON Processor.....	106
27. JAVA SE.....	111
28. jQuery.....	112
29. jquery.ex-table-filter	114
30. jquery-json.....	115
31. jQueryUI	116

32. JSEncrypt.....	117
33. libcurl	120
34. libdrm.....	133
35. libjpeg	146
36. libjpeg-turbo	147
37. libpcap	156
38. libpng.....	158
39. libtiff	163
40. libxml2	165
41. libXrandr.....	167
42. memcached	170
43. Mesa.....	173
44. MSTLIB.....	181
45. Net-SNMP.....	185
46. OPEN CV	202
47. OpenSSL	306
48. OSGi Release 5.....	331
49. Paho MQTT Client	342
50. pango (part of OpenTypeCode)	344
51. pixman	346
52. Protocol Buffers	349
53. servlet.jar	351
54. SQLite	359
55. tablesorter	361
56. wpa_supplicant-2.9	362
57. X Window System.....	365
58. xf86-video-intel.....	559
59. xkeyboard-config	568
60. Xrandr	579
61. Device Driver for Realtek RTL8111EP.....	581
62. Device Driver for REALTEK RTL8153	581
63. fusermount.....	581
64. Iptables.....	581
65. Linux	581
66. lvm2	581
67. WLAN USB Driver.....	581
68. ALSA Library	598
69. atk.....	598

70. cairo	598
71. clutter.....	598
72. clutter-gst	598
73. clutter-gtk.....	598
74. glib.....	598
75. glibc	598
76. gst--plugins-good	598
77. gstreamer	598
78. GTK+.....	598
79. json-glib.....	598
80. libfuse	598
81. Libnl	598
82. libusb	598
83. webkit	598
84. gst--plugins-base	619
85. iproute.....	630
86. Jersey.....	640
87. pango (except OpenTypeCode)	657
88. Squid	676

The software after No. 62 and downwards in the Table of Software described above, please see the followings.

- (1) Please access <<https://global.canon/en/oss/scd/index.html>> to fill the request form so that you receive an e-mail with the URL to download the source code; or
- (2) Please send us a letter in writing with the following information, so that you receive the source code via postal mail.

In case you have chosen this (2), WE MAY CHARGE YOU no more than the cost of performing this distribution.

- (i) Your Address (Country/Region, ZIP code, Address, Your name) [mandatory]
- (ii) Your e-mail address (for the purpose of possible communication with us) [optional]
- (iii) Name of the model that you purchased [mandatory].
- (iv) Platform Version. Please see the <Check Device Configuration> display on the control panel.
[mandatory]
- (v) Product ID number labeled on the back of the main unit. [mandatory]

– Addressee:

Open Source Promotion Division, Canon Inc.
30-2, Shimomaruko 3-chome, Ohta-ku,
Tokyo 146-8501, Japan

– Please see Privacy Notice at Canon Global <<https://global.canon/>>.

1. Adobe PDF Scan Library

Portions use software under the following terms:

This product contains either BSAFE and/or TIPEM software by RSA Security Inc.

This product includes software developed by the Apache Software Foundation (<http://www.apache.org/>).

Copyright (c) 1998-2000 The Apache Software Foundation. All rights reserved.

Redistribution and use in source and binary forms, with or without modification, are permitted provided that the following conditions are met:

1. Redistributions of source code must retain the above copyright notice, this list of conditions and the following disclaimer.
2. Redistributions in binary form must reproduce the above copyright notice, this list of conditions and the following disclaimer in the documentation and/or other materials provided with the distribution.
3. The end-user documentation included with the redistribution, if any, must include the following acknowledgment:

"This product includes software developed by the Apache Software Foundation (<http://www.apache.org/>)."

Alternately, this acknowledgment may appear in the software itself, if and wherever such third-party acknowledgments normally appear.

4. The names "Xerces" and "Apache Software Foundation" must not be used to endorse or promote products derived from this software without prior written permission. For written permission, please contact apache@apache.org.
5. Products derived from this software may not be called "Apache", nor may "Apache" appear in their name, without prior written permission of the Apache Software Foundation.

THIS SOFTWARE IS PROVIDED ``AS IS" AND ANY EXPRESSED OR IMPLIED WARRANTIES, INCLUDING, BUT NOT LIMITED TO, THE IMPLIED WARRANTIES OF MERCHANTABILITY AND FITNESS FOR A PARTICULAR PURPOSE ARE DISCLAIMED. IN NO EVENT SHALL THE APACHE SOFTWARE FOUNDATION OR ITS CONTRIBUTORS BE LIABLE FOR ANY DIRECT, INDIRECT, INCIDENTAL, SPECIAL, EXEMPLARY, OR CONSEQUENTIAL DAMAGES (INCLUDING, BUT NOT LIMITED TO, PROCUREMENT OF SUBSTITUTE GOODS OR SERVICES; LOSS OF USE, DATA, OR PROFITS; OR BUSINESS INTERRUPTION) HOWEVER CAUSED AND ON ANY THEORY OF LIABILITY, WHETHER IN CONTRACT, STRICT LIABILITY, OR TORT (INCLUDING NEGLIGENCE OR OTHERWISE) ARISING IN ANY WAY OUT OF THE USE OF THIS SOFTWARE, EVEN IF ADVISED OF THE POSSIBILITY OF SUCH DAMAGE.

This software consists of voluntary contributions made by many individuals on behalf of the Apache Software Foundation and was originally based on software copyright (c) 1999, International Business Machines, Inc., <http://www.ibm.com>. For more information on the Apache Software Foundation, please see <http://www.apache.org/>.

March 27, 2003

Portions of this product are based on Modifications created from the Original Code known as the "Sablotron XSLT Processor". The Sablotron XSLT Processor is subject to the Mozilla Public License Version 1.1 (the "License"). You may obtain a copy of the License at <http://www.mozilla.org/MPL/>

Software distributed under the License is distributed on an "AS IS" basis, WITHOUT WARRANTY OF ANY KIND, either express or implied. See the License for the specific language governing rights and limitations under the License.

The Original Code is the Sablotron XSLT Processor.

The Initial Developer of the Original Code is Ginger Alliance Ltd. Portions created by Ginger Alliance are Copyright (C) 2000 Ginger Alliance Ltd. All Rights Reserved.

Pursuant to sections 3.2 and 3.6 of the License, the Modifications created by Adobe Systems Incorporated are available as Source Code. The Modifications may be downloaded via the Internet from:

<http://partners.adobe.com/asn/tech/xml/sablotron/index.jsp>

The Original Code may be downloaded via the Internet from:

<https://sourceforge.net/projects/sablotron/>

Portions Copyright (c) 1997-1999 Silicon Graphics Computer Systems, Inc.

Permission to use, copy, modify, distribute and sell this software and its documentation for any purpose is hereby granted without fee, provided that the above copyright notice appear in all copies and that both that copyright notice and this permission notice appear in supporting documentation. Silicon Graphics makes no representations about the suitability of this software for any purpose. It is provided "as is" without express or implied warranty.

The Loki Library

Portions Copyright (c) 2001 by Andrei Alexandrescu . This code accompanies the book: Alexandrescu, Andrei. "Modern C++ Design: Generic Programming and Design Patterns Applied".

Portions Copyright (c) 2001. Addison-Wesley. Permission to use, copy, modify, distribute and sell this software for any purpose is hereby granted without fee, provided that the above copyright notice appear in all copies and that both that copyright notice and this permission notice appear in supporting documentation. The author or Addison-Wesley Longman make no representations about the suitability of this software for any purpose. It is provided "as is" without express or implied warranty.

Updated Information/Additional Third Party Code Information available at <http://www.adobe.com/go/thirdparty> .

2. Adobe PostScript 3

Copyright 2007–2008 Adobe Systems Incorporated and its licensors. All rights reserved.

Portions include software under the following terms:

This product contains either BSAFE and/or TPEM software by RSA Security Inc.

Portions of Pool.c_Copyright 1987 – NeXT, Inc., and portions of Graphics.c_Copyright 1988 NeXT, Inc. as an unpublished work. All Rights Reserved.

The Apache Software License, Version 1.1

This product includes software developed by the Apache Software Foundation (<http://www.apache.org/>).

Portions Copyright (c) 1998–2000 The Apache Software Foundation. All rights reserved.

Redistribution and use in source and binary forms, with or without modification, are permitted provided that the following conditions are met:

1. Redistributions of source code must retain the above copyright notice, this list of conditions and the following disclaimer.
2. Redistributions in binary form must reproduce the above copyright notice, this list of conditions and the following disclaimer in the documentation and/or other materials provided with the distribution.
3. The end-user documentation included with the redistribution, if any, must include the following acknowledgment:

"This product includes software developed by the Apache Software Foundation (<http://www.apache.org/>)."

Alternately, this acknowledgment may appear in the software itself, if and wherever such third-party acknowledgments normally appear.

4. The names "Xerces" and "Apache Software Foundation" must not be used to endorse or promote products derived from this software without prior written permission. For written permission, please contact apache@apache.org.
5. Products derived from this software may not be called "Apache", nor may "Apache" appear in their name, without prior written permission of the Apache Software Foundation.

THIS SOFTWARE IS PROVIDED ``AS IS" AND ANY EXPRESSED OR IMPLIED WARRANTIES, INCLUDING, BUT NOT LIMITED TO, THE IMPLIED WARRANTIES OF MERCHANTABILITY AND FITNESS FOR A PARTICULAR PURPOSE ARE DISCLAIMED. IN NO EVENT SHALL THE APACHE SOFTWARE FOUNDATION OR ITS CONTRIBUTORS BE LIABLE FOR ANY DIRECT, INDIRECT, INCIDENTAL, SPECIAL, EXEMPLARY, OR CONSEQUENTIAL DAMAGES (INCLUDING, BUT NOT LIMITED TO, PROCUREMENT OF SUBSTITUTE GOODS OR SERVICES; LOSS OF USE, DATA, OR PROFITS; OR BUSINESS INTERRUPTION) HOWEVER CAUSED AND ON ANY THEORY OF LIABILITY, WHETHER IN CONTRACT, STRICT LIABILITY, OR TORT (INCLUDING NEGLIGENCE OR OTHERWISE) ARISING IN ANY WAY OUT OF THE USE OF THIS SOFTWARE, EVEN IF ADVISED OF THE POSSIBILITY OF SUCH DAMAGE.

This software consists of voluntary contributions made by many individuals on behalf of the Apache Software Foundation and was originally based on software copyright (c) 1999, International Business Machines, Inc., <http://www.ibm.com>. For more information on the Apache Software Foundation, please see <http://www.apache.org/>.

This product includes software developed by the University of California, Berkeley and its contributors.

Portions Copyright (c) 1990 The Regents of the University of California. All rights reserved.

Redistribution and use in source and binary forms, with or without modification, are permitted provided that the following conditions are met:

1. Redistributions of source code must retain the above copyright notice, this list of conditions and the following disclaimer.
2. Redistributions in binary form must reproduce the above copyright notice, this list of conditions and the following disclaimer in the documentation and/or other materials provided with the distribution.
3. All advertising materials mentioning features or use of this software must display the following acknowledgement:

This product includes software developed by the University of California, Berkeley and its contributors.

4. Neither the name of the University nor the names of its contributors may be used to endorse or promote products derived from this software without specific prior written permission.

THIS SOFTWARE IS PROVIDED BY THE REGENTS AND CONTRIBUTORS "AS IS" AND ANY EXPRESS OR IMPLIED WARRANTIES, INCLUDING, BUT NOT LIMITED TO, THE IMPLIED WARRANTIES OF MERCHANTABILITY AND FITNESS FOR A PARTICULAR PURPOSE ARE DISCLAIMED. IN NO EVENT SHALL THE REGENTS OR CONTRIBUTORS BE LIABLE FOR ANY DIRECT, INDIRECT, INCIDENTAL, SPECIAL, EXEMPLARY, OR CONSEQUENTIAL DAMAGES (INCLUDING, BUT NOT LIMITED TO, PROCUREMENT OF

SUBSTITUTE GOODS OR SERVICES; LOSS OF USE, DATA, OR PROFITS; OR BUSINESS INTERRUPTION) HOWEVER CAUSED AND ON ANY THEORY OF LIABILITY, WHETHER IN CONTRACT, STRICT LIABILITY, OR TORT (INCLUDING NEGLIGENCE OR OTHERWISE) ARISING IN ANY WAY OUT OF THE USE OF THIS SOFTWARE, EVEN IF ADVISED OF THE POSSIBILITY OF SUCH DAMAGE.

Portions Copyright (c) 1985, 1986 The Regents of the University of California. All rights reserved.

This code is derived from software contributed to Berkeley by James A. Woods, derived from original work by Spencer Thomas and Joseph Orost.

Redistribution and use in source and binary forms are permitted provided that the above copyright notice and this paragraph are duplicated in all such forms and that any documentation, advertising materials, and other materials related to such distribution and use acknowledge that the software was developed by the University of California, Berkeley. The name of the University may not be used to endorse or promote products derived from this software without specific prior written permission.

THIS SOFTWARE IS PROVIDED ``AS IS" AND WITHOUT ANY EXPRESS OR IMPLIED WARRANTIES, INCLUDING, WITHOUT LIMITATION, THE IMPLIED WARRANTIES OF MERCHANTABILITY AND FITNESS FOR A PARTICULAR PURPOSE.

Portions Copyright (c) 1993 X Consortium

Permission is hereby granted, free of charge, to any person obtaining a copy of this software and associated documentation files (the "Software"), to deal in the Software without restriction, including without limitation the rights to use, copy, modify, merge, publish, distribute, sublicense, and/or sell copies of the Software, and to permit persons to whom the Software is furnished to do so, subject to the following conditions:

The above copyright notice and this permission notice shall be included in all copies or substantial portions of the Software.

THE SOFTWARE IS PROVIDED "AS IS", WITHOUT WARRANTY OF ANY KIND, EXPRESS OR IMPLIED, INCLUDING BUT NOT LIMITED TO THE WARRANTIES OF MERCHANTABILITY, FITNESS FOR A PARTICULAR PURPOSE AND NONINFRINGEMENT. IN NO EVENT SHALL THE X CONSORTIUM BE LIABLE FOR ANY CLAIM, DAMAGES OR OTHER LIABILITY, WHETHER IN AN ACTION OF CONTRACT, TORT OR OTHERWISE, ARISING FROM, OUT OF OR IN CONNECTION WITH THE SOFTWARE OR THE USE OR OTHER DEALINGS IN THE SOFTWARE.

Except as contained in this notice, the name of the X Consortium shall not be used in advertising or otherwise to promote the sale, use or other dealings in this Software without prior written authorization from the X Consortium.

NOTICE REGARDING SABLOTRON

March 27, 2003

Portions of this product are based on Modifications created from the Original Code known as the "Sablotron XSLT Processor". The Sablotron XSLT Processor is subject to the Mozilla Public License Version 1.1 (the "License"). You may obtain a copy of the License at <http://www.mozilla.org/MPL/>

Software distributed under the License is distributed on an "AS IS" basis, WITHOUT WARRANTY OF ANY KIND, either express or implied. See the License for the specific language governing rights and limitations under the License.

The Original Code is the Sablotron XSLT Processor.

The Initial Developer of the Original Code is Ginger Alliance Ltd. Portions created by Ginger Alliance are Copyright (C) 2000 Ginger Alliance Ltd. All Rights Reserved.

Pursuant to sections 3.2 and 3.6 of the License, the Modifications created by Adobe Systems Incorporated are available as Source Code. The Modifications may be downloaded via the Internet from:

<http://partners.adobe.com/asn/tech/xml/sablotron/index.jsp>

The Original Code may be downloaded via the Internet from:

<https://sourceforge.net/projects/sablotron/>

This product includes software developed by the University of California, Berkeley and its contributors.

Portions Copyright (c) 1982, 1986, 1987, 1988, 1989, 1990, 1991, 1992, 1993, 1994 The Regents of the University of California. All rights reserved.

Redistribution and use in source and binary forms, with or without modification, are permitted

provided that the following conditions are met:

1. Redistributions of source code must retain the above copyright notice, this list of conditions and the following disclaimer.
2. Redistributions in binary form must reproduce the above copyright notice, this list of conditions and the following disclaimer in the documentation and/or other materials provided with the distribution.
3. All advertising materials mentioning features or use of this software must display the following acknowledgement: This product includes software developed by the University of California, Berkeley and its contributors.
4. Neither the name of the University nor the names of its contributors may be used to endorse or promote products derived from this software without specific prior written permission.

THIS SOFTWARE IS PROVIDED BY THE REGENTS AND CONTRIBUTORS "AS IS" AND ANY EXPRESS OR IMPLIED WARRANTIES, INCLUDING, BUT NOT LIMITED TO, THE IMPLIED WARRANTIES OF MERCHANTABILITY AND FITNESS FOR A PARTICULAR PURPOSE ARE DISCLAIMED. IN NO EVENT SHALL THE REGENTS OR CONTRIBUTORS BE LIABLE FOR ANY DIRECT, INDIRECT, INCIDENTAL, SPECIAL, EXEMPLARY, OR CONSEQUENTIAL DAMAGES (INCLUDING, BUT NOT LIMITED TO, PROCUREMENT OF SUBSTITUTE GOODS OR SERVICES; LOSS OF USE, DATA, OR PROFITS; OR BUSINESS INTERRUPTION) HOWEVER CAUSED AND ON ANY THEORY OF LIABILITY, WHETHER IN CONTRACT, STRICT LIABILITY, OR TORT (INCLUDING NEGLIGENCE OR OTHERWISE) ARISING IN ANY WAY OUT OF THE USE OF THIS SOFTWARE, EVEN IF ADVISED OF THE POSSIBILITY OF SUCH DAMAGE.

Portions Copyright (c) 2001 by Andrei Alexandrescu. This code accompanies the book:
Alexandrescu, Andrei. "Modern C++ Design: Generic Programming and Design Patterns Applied".
Copyright (c) 2001. Addison-Wesley.

Permission to use, copy, modify, distribute and sell this software for any purpose is hereby granted without fee, provided that the above copyright notice appear in all copies and that both that copyright notice and this permission notice appear in supporting documentation. The author or Addison-Wesley Longman make no representations about the suitability of this software for any purpose. It is provided "as is" without express or implied warranty.

Portions developed by the University of California, Berkeley.

Portions Copyright © 1991–2005 Unicode, Inc. All rights reserved. Distributed under the Terms of Use in <http://www.unicode.org/copyright.html>.

Permission is hereby granted, free of charge, to any person obtaining a copy of the Unicode data files and associated documentation (the "Data Files") or Unicode software and associated documentation

(the "Software") to deal in the Data Files or Software without restriction, including without limitation the rights to use, copy, modify, merge, publish, distribute, and/or sell copies of the Data Files or Software, and to permit persons to whom the Data Files or Software are furnished to do so, provided that (a) the above copyright notice(s) and this permission notice appear in all copies of the Data Files or Software, (b) both the above copyright notice(s) and this permission notice appear in associated documentation, and (c) there is clear notice in each modified Data File or in the Software as well as in the documentation associated with the Data File(s) or Software that the data or software has been modified.

THE DATA FILES AND SOFTWARE ARE PROVIDED "AS IS", WITHOUT WARRANTY OF ANY KIND, EXPRESS OR IMPLIED, INCLUDING BUT NOT LIMITED TO THE WARRANTIES OF MERCHANTABILITY, FITNESS FOR A PARTICULAR PURPOSE AND NON-INFRINGEMENT OF THIRD PARTY RIGHTS. IN NO EVENT SHALL THE COPYRIGHT HOLDER OR HOLDERS INCLUDED IN THIS NOTICE BE LIABLE FOR ANY CLAIM, OR ANY SPECIAL INDIRECT OR CONSEQUENTIAL DAMAGES, OR ANY DAMAGES WHATSOEVER RESULTING FROM LOSS OF USE, DATA OR PROFITS, WHETHER IN AN ACTION OF CONTRACT, NEGLIGENCE OR OTHER TORTIOUS ACTION, ARISING OUT OF OR IN CONNECTION WITH THE USE OR PERFORMANCE OF THE DATA FILES OR SOFTWARE.

Except as contained in this notice, the name of a copyright holder shall not be used in advertising or otherwise to promote the sale, use or other dealings in these Data Files or Software without prior written authorization of the copyright holder.

Unicode and the Unicode logo are trademarks of Unicode, Inc., and may be registered in some jurisdictions. All other trademarks and registered trademarks mentioned herein are the property of their respective owners.

Adobe shall retain and reproduce, and require its Sublicensees to retain and reproduce JIM's following copyright notice within each copy of the licensed programs in any form, in whole or in part: "© 1981, 1990 JMI Consultants, Inc. All rights reserved."

This product includes software developed by the University of California, Berkeley and its contributors.

Portions Copyright (c) 1990, 1993 The Regents of the University of California. All rights reserved.

This code is derived from software contributed to Berkeley by Chris Torek.

Redistribution and use in source and binary forms, with or without modification, are permitted provided that the following conditions are met:

1. Redistributions of source code must retain the above copyright notice, this list of conditions and the following disclaimer.
2. Redistributions in binary form must reproduce the above copyright notice, this list of conditions and the following disclaimer in the documentation and/or other materials provided with the distribution.
3. All advertising materials mentioning features or use of this software must display the following acknowledgement:
This product includes software developed by the University of California, Berkeley and its contributors.
4. Neither the name of the University nor the names of its contributors may be used to endorse or promote products derived from this software without specific prior written permission.

THIS SOFTWARE IS PROVIDED BY THE REGENTS AND CONTRIBUTORS "AS IS" AND ANY EXPRESS OR IMPLIED WARRANTIES, INCLUDING, BUT NOT LIMITED TO, THE IMPLIED WARRANTIES OF MERCHANTABILITY AND FITNESS FOR A PARTICULAR PURPOSE ARE DISCLAIMED. IN NO EVENT SHALL THE REGENTS OR CONTRIBUTORS BE LIABLE FOR ANY DIRECT, INDIRECT, INCIDENTAL, SPECIAL, EXEMPLARY, OR CONSEQUENTIAL DAMAGES (INCLUDING, BUT NOT LIMITED TO, PROCUREMENT OF SUBSTITUTE GOODS OR SERVICES; LOSS OF USE, DATA, OR PROFITS; OR BUSINESS INTERRUPTION) HOWEVER CAUSED AND ON ANY THEORY OF LIABILITY, WHETHER IN CONTRACT, STRICT LIABILITY, OR TORT (INCLUDING NEGLIGENCE OR OTHERWISE) ARISING IN ANY WAY OUT OF THE USE OF THIS SOFTWARE, EVEN IF ADVISED OF THE POSSIBILITY OF SUCH DAMAGE.

The Loki Library

Portions Copyright (c) 2001 by Andrei Alexandrescu // This code accompanies the book: Alexandrescu, Andrei. "Modern C++ Design: Generic Programming and Design Patterns Applied". Copyright (c) 2001. Addison-Wesley.

Permission to use, copy, modify, distribute and sell this software for any purpose is hereby granted without fee, provided that the above copyright notice appear in all copies and that both that copyright notice and this permission notice appear in supporting documentation. The author or Addison-Wesley Longman make no representations about the suitability of this software for any purpose. It is provided "as is" without express or implied warranty.

Updated Information/Additional Third Party Code Information available at <http://www.adobe.com/go/thirdparty> .

3. Apache Commons Codec

Apache License

Version 2.0, January 2004

<http://www.apache.org/licenses/>

TERMS AND CONDITIONS FOR USE, REPRODUCTION, AND DISTRIBUTION

1. Definitions.

"License" shall mean the terms and conditions for use, reproduction, and distribution as defined by Sections 1 through 9 of this document.

"Licensor" shall mean the copyright owner or entity authorized by the copyright owner that is granting the License.

"Legal Entity" shall mean the union of the acting entity and all other entities that control, are controlled by, or are under common control with that entity. For the purposes of this definition, "control" means (i) the power, direct or indirect, to cause the direction or management of such entity, whether by contract or otherwise, or (ii) ownership of fifty percent (50%) or more of the outstanding shares, or (iii) beneficial ownership of such entity.

"You" (or "Your") shall mean an individual or Legal Entity exercising permissions granted by this License.

"Source" form shall mean the preferred form for making modifications, including but not limited to software source code, documentation source, and configuration files.

"Object" form shall mean any form resulting from mechanical transformation or translation of a Source form, including but not limited to compiled object code, generated documentation, and conversions to other media types.

"Work" shall mean the work of authorship, whether in Source or Object form, made available under the License, as indicated by a copyright notice that is included in or attached to the work (an example is provided in the Appendix below).

"Derivative Works" shall mean any work, whether in Source or Object form, that is based on (or derived from) the Work and for which the editorial revisions, annotations, elaborations, or other modifications represent, as a whole, an original work of authorship. For the purposes of this License, Derivative Works shall not include works that remain separable from, or merely link (or bind by name) to the interfaces of, the Work and Derivative Works thereof.

"Contribution" shall mean any work of authorship, including the original version of the Work and any modifications or additions to that Work or Derivative Works thereof, that is intentionally submitted to Licensor for inclusion in the Work by the copyright owner or by an individual or Legal Entity authorized to submit on behalf of the copyright owner. For the purposes of this definition, "submitted" means any form of electronic, verbal, or written communication sent to the Licensor or its representatives, including but not limited to communication on electronic mailing lists, source code control systems, and issue tracking systems that are managed by, or on behalf of, the Licensor for the purpose of discussing and improving the Work, but excluding communication that is conspicuously marked or otherwise designated in writing by the copyright owner as "Not a Contribution."

"Contributor" shall mean Licensor and any individual or Legal Entity on behalf of whom a Contribution has been received by Licensor and subsequently incorporated within the Work.

2. Grant of Copyright License. Subject to the terms and conditions of this License, each Contributor hereby grants to You a perpetual,

worldwide, non-exclusive, no-charge, royalty-free, irrevocable copyright license to reproduce, prepare Derivative Works of, publicly display, publicly perform, sublicense, and distribute the Work and such Derivative Works in Source or Object form.

3. Grant of Patent License. Subject to the terms and conditions of this License, each Contributor hereby grants to You a perpetual, worldwide, non-exclusive, no-charge, royalty-free, irrevocable (except as stated in this section) patent license to make, have made, use, offer to sell, sell, import, and otherwise transfer the Work, where such license applies only to those patent claims licensable by such Contributor that are necessarily infringed by their Contribution(s) alone or by combination of their Contribution(s) with the Work to which such Contribution(s) was submitted. If You institute patent litigation against any entity (including a cross-claim or counterclaim in a lawsuit) alleging that the Work or a Contribution incorporated within the Work constitutes direct or contributory patent infringement, then any patent licenses granted to You under this License for that Work shall terminate as of the date such litigation is filed.

4. Redistribution. You may reproduce and distribute copies of the Work or Derivative Works thereof in any medium, with or without modifications, and in Source or Object form, provided that You meet the following conditions:

(a) You must give any other recipients of the Work or Derivative Works a copy of this License; and

(b) You must cause any modified files to carry prominent notices stating that You changed the files; and

(c) You must retain, in the Source form of any Derivative Works that You distribute, all copyright, patent, trademark, and attribution notices from the Source form of the Work, excluding those notices that do not pertain to any part of the Derivative Works; and

(d) If the Work includes a "NOTICE" text file as part of its distribution, then any Derivative Works that You distribute must include a readable copy of the attribution notices contained within such NOTICE file, excluding those notices that do not pertain to any part of the Derivative Works, in at least one of the following places: within a NOTICE text file distributed as part of the Derivative Works; within the Source form or documentation, if provided along with the Derivative Works; or, within a display generated by the Derivative Works, if and wherever such third-party notices normally appear. The contents of the NOTICE file are for informational purposes only and do not modify the License. You may add Your own attribution notices within Derivative Works that You distribute, alongside or as an addendum to the NOTICE text from the Work, provided that such additional attribution notices cannot be construed as modifying the License.

You may add Your own copyright statement to Your modifications and may provide additional or different license terms and conditions for use, reproduction, or distribution of Your modifications, or for any such Derivative Works as a whole, provided Your use, reproduction, and distribution of the Work otherwise complies with the conditions stated in this License.

5. Submission of Contributions. Unless You explicitly state otherwise, any Contribution intentionally submitted for inclusion in the Work by You to the Licensor shall be under the terms and conditions of this License, without any additional terms or conditions.

Notwithstanding the above, nothing herein shall supersede or modify the terms of any separate license agreement you may have executed with Licensor regarding such Contributions.

6. Trademarks. This License does not grant permission to use the trade names, trademarks, service marks, or product names of the Licensor, except as required for reasonable and customary use in describing the origin of the Work and reproducing the content of the NOTICE file.

7. Disclaimer of Warranty. Unless required by applicable law or

agreed to in writing, Licensor provides the Work (and each Contributor provides its Contributions) on an "AS IS" BASIS, WITHOUT WARRANTIES OR CONDITIONS OF ANY KIND, either express or implied, including, without limitation, any warranties or conditions of TITLE, NON-INFRINGEMENT, MERCHANTABILITY, or FITNESS FOR A PARTICULAR PURPOSE. You are solely responsible for determining the appropriateness of using or redistributing the Work and assume any risks associated with Your exercise of permissions under this License.

8. Limitation of Liability. In no event and under no legal theory, whether in tort (including negligence), contract, or otherwise, unless required by applicable law (such as deliberate and grossly negligent acts) or agreed to in writing, shall any Contributor be liable to You for damages, including any direct, indirect, special, incidental, or consequential damages of any character arising as a result of this License or out of the use or inability to use the Work (including but not limited to damages for loss of goodwill, work stoppage, computer failure or malfunction, or any and all other commercial damages or losses), even if such Contributor has been advised of the possibility of such damages.

9. Accepting Warranty or Additional Liability. While redistributing the Work or Derivative Works thereof, You may choose to offer, and charge a fee for, acceptance of support, warranty, indemnity, or other liability obligations and/or rights consistent with this License. However, in accepting such obligations, You may act only on Your own behalf and on Your sole responsibility, not on behalf of any other Contributor, and only if You agree to indemnify, defend, and hold each Contributor harmless for any liability incurred by, or claims asserted against, such Contributor by reason of your accepting any such warranty or additional liability.

END OF TERMS AND CONDITIONS

APPENDIX: How to apply the Apache License to your work.

To apply the Apache License to your work, attach the following boilerplate notice, with the fields enclosed by brackets "[]"

replaced with your own identifying information. (Don't include the brackets!) The text should be enclosed in the appropriate comment syntax for the file format. We also recommend that a file or class name and description of purpose be included on the same "printed page" as the copyright notice for easier identification within third-party archives.

Copyright [yyyy] [name of copyright owner]

Licensed under the Apache License, Version 2.0 (the "License"); you may not use this file except in compliance with the License. You may obtain a copy of the License at

<http://www.apache.org/licenses/LICENSE-2.0>

Unless required by applicable law or agreed to in writing, software distributed under the License is distributed on an "AS IS" BASIS, WITHOUT WARRANTIES OR CONDITIONS OF ANY KIND, either express or implied. See the License for the specific language governing permissions and limitations under the License.

Apache Commons Codec
Copyright 2002–2017 The Apache Software Foundation

This product includes software developed at
The Apache Software Foundation (<http://www.apache.org/>).

src/test/org/apache/commons/codec/language/DoubleMetaphoneTest.java
contains test data from <http://aspell.net/test/orig/batch0.tab>.
Copyright (C) 2002 Kevin Atkinson (kevina@gnu.org)

=====
=====

The content of package org.apache.commons.codec.language.bm has been translated from the original php source code available at <http://stevemorse.org/phoneticinfo.htm> with permission from the original authors.

Original source copyright:

Copyright (c) 2008 Alexander Beider & Stephen P. Morse.

4. Apache Commons Logging

Apache License

Version 2.0, January 2004

TERMS AND CONDITIONS FOR USE, REPRODUCTION, AND DISTRIBUTION

1. Definitions.

"License" shall mean the terms and conditions for use, reproduction, and distribution as defined by Sections 1 through 9 of this document.

"Licensor" shall mean the copyright owner or entity authorized by the copyright owner that is granting the License.

"Legal Entity" shall mean the union of the acting entity and all other entities that control, are controlled by, or are under common control with that entity. For the purposes of this definition, "control" means (i) the power, direct or indirect, to cause the direction or management of such entity, whether by contract or otherwise, or (ii) ownership of fifty percent (50%) or more of the outstanding shares, or (iii) beneficial ownership of such entity.

"You" (or "Your") shall mean an individual or Legal Entity exercising permissions granted by this License.

"Source" form shall mean the preferred form for making modifications, including but not limited to software source code, documentation source, and configuration files.

"Object" form shall mean any form resulting from mechanical transformation or translation of a Source form, including but not limited to compiled object code, generated documentation, and conversions to other media types.

"Work" shall mean the work of authorship, whether in Source or Object form, made available under the License, as indicated by a copyright notice that is included in or attached to the work (an example is provided in the Appendix below).

"Derivative Works" shall mean any work, whether in Source or Object form, that is based on (or derived from) the Work and for which the editorial revisions, annotations, elaborations, or other modifications represent, as a whole, an original work of authorship. For the purposes of this License, Derivative Works shall not include works that remain separable from, or merely link (or bind by name) to the interfaces of, the Work and Derivative Works thereof.

"Contribution" shall mean any work of authorship, including the original version of the Work and any modifications or additions to that Work or Derivative Works thereof, that is intentionally submitted to Licensor for inclusion in the Work by the copyright owner or by an individual or Legal Entity authorized to submit on behalf of the copyright owner. For the purposes of this definition, "submitted" means any form of electronic, verbal, or written communication sent to the Licensor or its representatives, including but not limited to communication on electronic mailing lists, source code control systems, and issue tracking systems that are managed by, or on behalf of, the Licensor for the purpose of discussing and improving the Work, but excluding communication that is conspicuously marked or otherwise designated in writing by the copyright owner as "Not a Contribution."

"Contributor" shall mean Licensor and any individual or Legal Entity on behalf of whom a Contribution has been received by Licensor and subsequently incorporated within the Work.

2. Grant of Copyright License. Subject to the terms and conditions of this License, each Contributor hereby grants to You a perpetual, worldwide, non-exclusive, no-charge, royalty-free, irrevocable copyright license to reproduce, prepare Derivative Works of, publicly display, publicly perform, sublicense, and distribute the Work and such Derivative Works in Source or Object form.

3. Grant of Patent License. Subject to the terms and conditions of this License, each Contributor hereby grants to You a perpetual, worldwide, non-exclusive, no-charge, royalty-free, irrevocable (except as stated in this section) patent license to make, have made, use, offer to sell, sell, import, and otherwise transfer the Work, where such license applies only to those patent claims licensable by such Contributor that are necessarily infringed by their Contribution(s) alone or by combination of their Contribution(s) with the Work to which such Contribution(s) was submitted. If You institute patent litigation against any entity (including a cross-claim or counterclaim in a lawsuit) alleging that the Work or a Contribution incorporated within the Work constitutes direct or contributory patent infringement, then any patent licenses granted to You under this License for that Work shall terminate as of the date such litigation is filed.

4. Redistribution. You may reproduce and distribute copies of the Work or Derivative Works thereof in any medium, with or without modifications, and in Source or Object form, provided that You meet the following conditions:

1. You must give any other recipients of the Work or Derivative Works a copy of this License; and
2. You must cause any modified files to carry prominent notices stating that You changed the files; and
3. You must retain, in the Source form of any Derivative Works that You distribute, all copyright, patent, trademark, and attribution notices from the Source form of the Work, excluding those notices that do not pertain to any part of the Derivative Works; and
4. If the Work includes a "NOTICE" text file as part of its distribution, then any Derivative Works that You distribute must include a readable copy of the attribution notices contained within such NOTICE file, excluding those notices that do not pertain to any part of the Derivative Works, in at least one of the following places: within a NOTICE text file distributed as part of the Derivative Works; within the Source form or documentation, if provided along with the Derivative Works; or, within a display generated by the Derivative Works, if and wherever such third-party notices normally appear. The contents of the NOTICE file are for informational purposes only and do not modify the License. You may add Your own attribution notices within Derivative Works that You distribute, alongside or as an addendum to the NOTICE text from the Work, provided that such additional attribution notices cannot be construed as modifying the License.

You may add Your own copyright statement to Your modifications and may provide additional or different license terms and conditions for use, reproduction, or distribution of Your modifications, or for any such Derivative Works as a whole, provided Your use, reproduction, and distribution of the Work otherwise complies with the conditions stated in this License.

5. Submission of Contributions. Unless You explicitly state otherwise, any Contribution intentionally submitted for inclusion in the Work by You to the Licensor shall be under the terms and conditions of this License, without any additional terms or conditions. Notwithstanding the above, nothing herein shall supersede or modify the terms of any separate license agreement you may have executed with Licensor regarding such Contributions.
6. Trademarks. This License does not grant permission to use the trade names, trademarks, service marks, or product names of the Licensor, except as required for reasonable and customary use in describing the origin of the Work and reproducing the content of the NOTICE file.
7. Disclaimer of Warranty. Unless required by applicable law or agreed to in writing, Licensor provides the Work (and each Contributor provides its Contributions) on an "AS IS" BASIS, WITHOUT WARRANTIES OR CONDITIONS OF ANY KIND, either express or implied, including, without limitation, any warranties or conditions of TITLE, NON-INFRINGEMENT, MERCHANTABILITY, or FITNESS FOR A PARTICULAR PURPOSE. You are solely responsible for determining the appropriateness of using or redistributing the Work and assume any risks associated with Your exercise of permissions under this License.
8. Limitation of Liability. In no event and under no legal theory, whether in tort (including negligence), contract, or otherwise, unless required by applicable law (such as deliberate and grossly negligent acts) or agreed to in

writing, shall any Contributor be liable to You for damages, including any direct, indirect, special, incidental, or consequential damages of any character arising as a result of this License or out of the use or inability to use the Work (including but not limited to damages for loss of goodwill, work stoppage, computer failure or malfunction, or any and all other commercial damages or losses), even if such Contributor has been advised of the possibility of such damages.

9. Accepting Warranty or Additional Liability. While redistributing the Work or Derivative Works thereof, You may choose to offer, and charge a fee for, acceptance of support, warranty, indemnity, or other liability obligations and/or rights consistent with this License. However, in accepting such obligations, You may act only on Your own behalf and on Your sole responsibility, not on behalf of any other Contributor, and only if You agree to indemnify, defend, and hold each Contributor harmless for any liability incurred by, or claims asserted against, such Contributor by reason of your accepting any such warranty or additional liability.

END OF TERMS AND CONDITIONS

Note: Other license terms may apply to certain, identified software files contained within or distributed with the accompanying software if such terms are included in the directory containing the accompanying software. Such other license terms will then apply in lieu of the terms of the software license above.

JSON processing code subject to the JSON License from JSON.org:

Permission is hereby granted, free of charge, to any person obtaining a copy of this software and associated documentation files (the "Software"), to deal in the Software without restriction, including without limitation the rights to use, copy, modify, merge, publish, distribute, sublicense, and/or sell copies of the Software, and to permit persons to whom the Software is furnished to do so, subject to the following conditions:

The above copyright notice and this permission notice shall be included in all copies or substantial portions of the Software.

The Software shall be used for Good, not Evil.

THE SOFTWARE IS PROVIDED "AS IS", WITHOUT WARRANTY OF ANY KIND, EXPRESS OR IMPLIED, INCLUDING BUT NOT LIMITED TO THE WARRANTIES OF MERCHANTABILITY, FITNESS FOR A PARTICULAR PURPOSE AND NONINFRINGEMENT. IN NO EVENT SHALL THE AUTHORS OR COPYRIGHT HOLDERS BE LIABLE FOR ANY CLAIM, DAMAGES OR OTHER LIABILITY, WHETHER IN AN ACTION OF CONTRACT, TORT OR OTHERWISE, ARISING FROM, OUT OF OR IN CONNECTION WITH THE SOFTWARE OR THE USE OR OTHER DEALINGS IN THE SOFTWARE.

Apache Commons Logging

Copyright 2003-2014 The Apache Software Foundation

This product includes software developed at

The Apache Software Foundation (<http://www.apache.org/>).

5. Apache Commons Net

Apache License

Version 2.0, January 2004

TERMS AND CONDITIONS FOR USE, REPRODUCTION, AND DISTRIBUTION

1. Definitions.

"License" shall mean the terms and conditions for use, reproduction, and distribution as defined by Sections 1 through 9 of this document.

"Licensor" shall mean the copyright owner or entity authorized by the copyright owner that is granting the License.

"Legal Entity" shall mean the union of the acting entity and all other entities that control, are controlled by, or are under common control with that entity. For the purposes of this definition, "control" means (i) the power, direct or indirect, to cause the direction or management of such entity, whether by contract or otherwise, or (ii) ownership of fifty percent (50%) or more of the outstanding shares, or (iii) beneficial ownership of such entity.

"You" (or "Your") shall mean an individual or Legal Entity exercising permissions granted by this License.

"Source" form shall mean the preferred form for making modifications, including but not limited to software source code, documentation source, and configuration files.

"Object" form shall mean any form resulting from mechanical transformation or translation of a Source form, including but not limited to compiled object code, generated documentation, and conversions to other media types.

"Work" shall mean the work of authorship, whether in Source or Object form, made available under the License, as indicated by a copyright notice that is included in or attached to the work (an example is provided in the Appendix below).

"Derivative Works" shall mean any work, whether in Source or Object form, that is based on (or derived from) the Work and for which the editorial revisions, annotations, elaborations, or other

modifications represent, as a whole, an original work of authorship. For the purposes of this License, Derivative Works shall not include works that remain separable from, or merely link (or bind by name) to the interfaces of, the Work and Derivative Works thereof.

"Contribution" shall mean any work of authorship, including the original version of the Work and any modifications or additions to that Work or Derivative Works thereof, that is intentionally submitted to Licensor for inclusion in the Work by the copyright owner or by an individual or Legal Entity authorized to submit on behalf of the copyright owner. For the purposes of this definition, "submitted" means any form of electronic, verbal, or written communication sent to the Licensor or its representatives, including but not limited to communication on electronic mailing lists, source code control systems, and issue tracking systems that are managed by, or on behalf of, the Licensor for the purpose of discussing and improving the Work, but excluding communication that is conspicuously marked or otherwise designated in writing by the copyright owner as "Not a Contribution."

"Contributor" shall mean Licensor and any individual or Legal Entity on behalf of whom a Contribution has been received by Licensor and subsequently incorporated within the Work.

2. Grant of Copyright License. Subject to the terms and conditions of this License, each Contributor hereby grants to You a perpetual, worldwide, non-exclusive, no-charge, royalty-free, irrevocable copyright license to reproduce, prepare Derivative Works of, publicly display, publicly perform, sublicense, and distribute the Work and such Derivative Works in Source or Object form.

3. Grant of Patent License. Subject to the terms and conditions of this License, each Contributor hereby grants to You a perpetual, worldwide, non-exclusive, no-charge, royalty-free, irrevocable (except as stated in this section) patent license to make, have made, use, offer to sell, sell, import, and otherwise transfer the Work, where such license applies only to those patent claims licensable by such Contributor that are necessarily infringed by their Contribution(s) alone or by combination of their Contribution(s) with the Work to which such Contribution(s) was submitted. If You institute patent litigation against any entity (including a cross-claim or counterclaim in a lawsuit) alleging that the Work or a Contribution incorporated within the Work constitutes direct or contributory patent infringement, then any patent licenses granted to You under this License for that Work shall terminate as of the date such litigation is filed.

4. Redistribution. You may reproduce and distribute copies of the Work or Derivative Works thereof in any medium, with or without modifications, and in Source or Object form, provided that You meet the following conditions:

1. You must give any other recipients of the Work or Derivative Works a copy of this License; and

2. You must cause any modified files to carry prominent notices stating that You changed the files; and

3. You must retain, in the Source form of any Derivative Works that You distribute, all copyright, patent, trademark, and attribution notices from the Source form of the Work, excluding those notices that do not pertain to any part of the Derivative Works; and

4. If the Work includes a "NOTICE" text file as part of its distribution, then any Derivative Works that You distribute must include a readable copy of the attribution notices contained within such NOTICE file, excluding those notices that do not pertain to any part of the Derivative Works, in at least one of the following places: within a NOTICE text file distributed as part of the Derivative Works; within the Source form or documentation, if provided along with the Derivative Works; or, within a display generated by the Derivative Works, if and wherever such third-party notices normally appear. The contents of the NOTICE file are for informational purposes only and do not modify the License. You may add Your own attribution notices within Derivative Works that You distribute, alongside or as an addendum to the NOTICE text from the Work, provided that such additional attribution notices cannot be construed as modifying the License.

You may add Your own copyright statement to Your modifications and may provide additional or different license terms and conditions for use, reproduction, or distribution of Your modifications, or for any such Derivative Works as a whole, provided Your use, reproduction, and distribution of the Work otherwise complies with the conditions stated in this License.

5. Submission of Contributions. Unless You explicitly state otherwise, any Contribution intentionally submitted for inclusion in the Work by You to the Licensor shall be under the terms and conditions of this License, without any additional terms or conditions. Notwithstanding the above, nothing herein shall supersede or modify the terms of any separate license agreement you may have executed with Licensor regarding such Contributions.

6. Trademarks. This License does not grant permission to use the trade names, trademarks, service marks, or product names of the Licensor, except as required for reasonable and customary use in describing the origin of the Work and reproducing the content of the NOTICE file.

7. Disclaimer of Warranty. Unless required by applicable law or agreed to in writing, Licensor provides the Work (and each Contributor provides its Contributions) on an "AS IS" BASIS, WITHOUT WARRANTIES OR CONDITIONS OF ANY KIND, either express or implied, including, without limitation, any warranties or conditions of TITLE, NON-INFRINGEMENT, MERCHANTABILITY, or FITNESS FOR A PARTICULAR PURPOSE. You are solely responsible for determining the appropriateness of using or redistributing the Work and assume any risks associated with Your exercise of permissions under this License.

8. Limitation of Liability. In no event and under no legal theory, whether in tort (including negligence), contract, or otherwise, unless required by applicable law (such as deliberate and grossly negligent acts) or agreed to in writing, shall any Contributor be liable to You for damages, including any direct, indirect, special, incidental, or consequential damages of any character arising as a result of this License or out of the use or inability to use the Work (including but not limited to damages for loss of goodwill, work stoppage, computer failure or malfunction, or any and all other commercial damages or losses), even if such Contributor has been advised of the possibility of such damages.

9. Accepting Warranty or Additional Liability. While redistributing the Work or Derivative Works thereof, You may choose to offer, and charge a fee for, acceptance of support, warranty, indemnity, or other liability obligations and/or rights consistent with this License. However, in accepting such obligations, You may act only on Your own behalf and on Your sole responsibility, not on behalf of any other Contributor, and only if You agree to indemnify, defend, and hold each Contributor harmless for any liability incurred by, or claims asserted against, such Contributor by reason of your accepting any such warranty or additional liability.

END OF TERMS AND CONDITIONS

Note: Other license terms may apply to certain, identified software files contained within or distributed with the accompanying software if such terms are included in the directory containing the accompanying software. Such other license terms will then apply in lieu of the terms of the software license above.

JSON processing code subject to the JSON License from JSON.org:

Permission is hereby granted, free of charge, to any person obtaining a copy of this software and associated documentation files (the "Software"), to deal in the Software without restriction, including without limitation the rights to use, copy, modify, merge, publish, distribute, sublicense, and/or sell copies of the Software, and to permit persons to whom the Software is furnished to do so, subject to the following conditions:

The above copyright notice and this permission notice shall be included in all copies or substantial portions of the Software.

The Software shall be used for Good, not Evil.

THE SOFTWARE IS PROVIDED "AS IS", WITHOUT WARRANTY OF ANY KIND, EXPRESS OR IMPLIED,

INCLUDING BUT NOT LIMITED TO THE WARRANTIES OF MERCHANTABILITY, FITNESS FOR A PARTICULAR PURPOSE AND NONINFRINGEMENT. IN NO EVENT SHALL THE AUTHORS OR COPYRIGHT HOLDERS BE LIABLE FOR ANY CLAIM, DAMAGES OR OTHER LIABILITY, WHETHER IN AN ACTION OF CONTRACT, TORT OR OTHERWISE, ARISING FROM, OUT OF OR IN CONNECTION WITH THE SOFTWARE OR THE USE OR OTHER DEALINGS IN THE SOFTWARE.

Apache Commons Net

Copyright 2001–2017 The Apache Software Foundation

This product includes software developed at

The Apache Software Foundation (<http://www.apache.org/>).

6. Apache HttpClient

Apache License

Version 2.0, January 2004

<http://www.apache.org/licenses/>

TERMS AND CONDITIONS FOR USE, REPRODUCTION, AND DISTRIBUTION

1. Definitions.

"License" shall mean the terms and conditions for use, reproduction, and distribution as defined by Sections 1 through 9 of this document.

"Licensor" shall mean the copyright owner or entity authorized by the copyright owner that is granting the License.

"Legal Entity" shall mean the union of the acting entity and all other entities that control, are controlled by, or are under common control with that entity. For the purposes of this definition, "control" means (i) the power, direct or indirect, to cause the direction or management of such entity, whether by contract or otherwise, or (ii) ownership of fifty percent (50%) or more of the outstanding shares, or (iii) beneficial ownership of such entity.

"You" (or "Your") shall mean an individual or Legal Entity exercising permissions granted by this License.

"Source" form shall mean the preferred form for making modifications, including but not limited to software source code, documentation source, and configuration files.

"Object" form shall mean any form resulting from mechanical transformation or translation of a Source form, including but not limited to compiled object code, generated documentation, and conversions to other media types.

"Work" shall mean the work of authorship, whether in Source or Object form, made available under the License, as indicated by a copyright notice that is included in or attached to the work (an example is provided in the Appendix below).

"Derivative Works" shall mean any work, whether in Source or Object form, that is based on (or derived from) the Work and for which the editorial revisions, annotations, elaborations, or other modifications represent, as a whole, an original work of authorship. For the purposes of this License, Derivative Works shall not include works that remain separable from, or merely link (or bind by name) to the interfaces of, the Work and Derivative Works thereof.

"Contribution" shall mean any work of authorship, including the original version of the Work and any modifications or additions to that Work or Derivative Works thereof, that is intentionally submitted to Licensor for inclusion in the Work by the copyright owner or by an individual or Legal Entity authorized to submit on behalf of the copyright owner. For the purposes of this definition, "submitted" means any form of electronic, verbal, or written communication sent to the Licensor or its representatives, including but not limited to communication on electronic mailing lists, source code control systems, and issue tracking systems that are managed by, or on behalf of, the Licensor for the purpose of discussing and improving the Work, but excluding communication that is conspicuously marked or otherwise designated in writing by the copyright owner as "Not a Contribution."

"Contributor" shall mean Licensor and any individual or Legal Entity on behalf of whom a Contribution has been received by Licensor and subsequently incorporated within the Work.

2. Grant of Copyright License. Subject to the terms and conditions of this License, each Contributor hereby grants to You a perpetual, worldwide, non-exclusive, no-charge, royalty-free, irrevocable copyright license to reproduce, prepare Derivative Works of, publicly display, publicly perform, sublicense, and distribute the Work and such Derivative Works in Source or Object form.

3. Grant of Patent License. Subject to the terms and conditions of this License, each Contributor hereby grants to You a perpetual, worldwide, non-exclusive, no-charge, royalty-free, irrevocable (except as stated in this section) patent license to make, have made,

use, offer to sell, sell, import, and otherwise transfer the Work, where such license applies only to those patent claims licensable by such Contributor that are necessarily infringed by their Contribution(s) alone or by combination of their Contribution(s) with the Work to which such Contribution(s) was submitted. If You institute patent litigation against any entity (including a cross-claim or counterclaim in a lawsuit) alleging that the Work or a Contribution incorporated within the Work constitutes direct or contributory patent infringement, then any patent licenses granted to You under this License for that Work shall terminate as of the date such litigation is filed.

4. Redistribution. You may reproduce and distribute copies of the Work or Derivative Works thereof in any medium, with or without modifications, and in Source or Object form, provided that You meet the following conditions:

(a) You must give any other recipients of the Work or Derivative Works a copy of this License; and

(b) You must cause any modified files to carry prominent notices stating that You changed the files; and

(c) You must retain, in the Source form of any Derivative Works that You distribute, all copyright, patent, trademark, and attribution notices from the Source form of the Work, excluding those notices that do not pertain to any part of the Derivative Works; and

(d) If the Work includes a "NOTICE" text file as part of its distribution, then any Derivative Works that You distribute must include a readable copy of the attribution notices contained within such NOTICE file, excluding those notices that do not pertain to any part of the Derivative Works, in at least one of the following places: within a NOTICE text file distributed as part of the Derivative Works; within the Source form or documentation, if provided along with the Derivative Works; or, within a display generated by the Derivative Works, if and

wherever such third-party notices normally appear. The contents of the NOTICE file are for informational purposes only and do not modify the License. You may add Your own attribution notices within Derivative Works that You distribute, alongside or as an addendum to the NOTICE text from the Work, provided that such additional attribution notices cannot be construed as modifying the License.

You may add Your own copyright statement to Your modifications and may provide additional or different license terms and conditions for use, reproduction, or distribution of Your modifications, or for any such Derivative Works as a whole, provided Your use, reproduction, and distribution of the Work otherwise complies with the conditions stated in this License.

5. Submission of Contributions. Unless You explicitly state otherwise, any Contribution intentionally submitted for inclusion in the Work by You to the Licensor shall be under the terms and conditions of this License, without any additional terms or conditions.

Notwithstanding the above, nothing herein shall supersede or modify the terms of any separate license agreement you may have executed with Licensor regarding such Contributions.

6. Trademarks. This License does not grant permission to use the trade names, trademarks, service marks, or product names of the Licensor, except as required for reasonable and customary use in describing the origin of the Work and reproducing the content of the NOTICE file.

7. Disclaimer of Warranty. Unless required by applicable law or agreed to in writing, Licensor provides the Work (and each Contributor provides its Contributions) on an "AS IS" BASIS, WITHOUT WARRANTIES OR CONDITIONS OF ANY KIND, either express or implied, including, without limitation, any warranties or conditions of TITLE, NON-INFRINGEMENT, MERCHANTABILITY, or FITNESS FOR A PARTICULAR PURPOSE. You are solely responsible for determining the appropriateness of using or redistributing the Work and assume any risks associated with Your exercise of permissions under this License.

8. Limitation of Liability. In no event and under no legal theory, whether in tort (including negligence), contract, or otherwise, unless required by applicable law (such as deliberate and grossly negligent acts) or agreed to in writing, shall any Contributor be liable to You for damages, including any direct, indirect, special, incidental, or consequential damages of any character arising as a result of this License or out of the use or inability to use the Work (including but not limited to damages for loss of goodwill, work stoppage, computer failure or malfunction, or any and all other commercial damages or losses), even if such Contributor has been advised of the possibility of such damages.

9. Accepting Warranty or Additional Liability. While redistributing the Work or Derivative Works thereof, You may choose to offer, and charge a fee for, acceptance of support, warranty, indemnity, or other liability obligations and/or rights consistent with this License. However, in accepting such obligations, You may act only on Your own behalf and on Your sole responsibility, not on behalf of any other Contributor, and only if You agree to indemnify, defend, and hold each Contributor harmless for any liability incurred by, or claims asserted against, such Contributor by reason of your accepting any such warranty or additional liability.

END OF TERMS AND CONDITIONS

=====

This project includes Public Suffix List copied from
<https://publicsuffix.org/list/effective_tld_names.dat>
licensed under the terms of the Mozilla Public License, v. 2.0

Full license text: <<http://mozilla.org/MPL/2.0/>>

Mozilla Public License Version 2.0

=====

1. Definitions

1.1. "Contributor"

means each individual or legal entity that creates, contributes to the creation of, or owns Covered Software.

1.2. "Contributor Version"

means the combination of the Contributions of others (if any) used by a Contributor and that particular Contributor's Contribution.

1.3. "Contribution"

means Covered Software of a particular Contributor.

1.4. "Covered Software"

means Source Code Form to which the initial Contributor has attached the notice in Exhibit A, the Executable Form of such Source Code Form, and Modifications of such Source Code Form, in each case including portions thereof.

1.5. "Incompatible With Secondary Licenses"

means

(a) that the initial Contributor has attached the notice described in Exhibit B to the Covered Software; or

(b) that the Covered Software was made available under the terms of version 1.1 or earlier of the License, but not also under the terms of a Secondary License.

1.6. "Executable Form"

means any form of the work other than Source Code Form.

1.7. "Larger Work"

means a work that combines Covered Software with other material, in a separate file or files, that is not Covered Software.

1.8. "License"

means this document.

1.9. "Licensable"

means having the right to grant, to the maximum extent possible, whether at the time of the initial grant or subsequently, any and all of the rights conveyed by this License.

1.10. "Modifications"

means any of the following:

(a) any file in Source Code Form that results from an addition to, deletion from, or modification of the contents of Covered Software; or

(b) any new file in Source Code Form that contains any Covered Software.

1.11. "Patent Claims" of a Contributor

means any patent claim(s), including without limitation, method, process, and apparatus claims, in any patent Licensable by such Contributor that would be infringed, but for the grant of the License, by the making, using, selling, offering for sale, having made, import, or transfer of either its Contributions or its Contributor Version.

1.12. "Secondary License"

means either the GNU General Public License, Version 2.0, the GNU Lesser General Public License, Version 2.1, the GNU Affero General Public License, Version 3.0, or any later versions of those licenses.

1.13. "Source Code Form"

means the form of the work preferred for making modifications.

1.14. "You" (or "Your")

means an individual or a legal entity exercising rights under this License. For legal entities, "You" includes any entity that controls, is controlled by, or is under common control with You. For purposes of this definition, "control" means (a) the power, direct or indirect, to cause the direction or management of such entity,

whether by contract or otherwise, or (b) ownership of more than fifty percent (50%) of the outstanding shares or beneficial ownership of such entity.

2. License Grants and Conditions

2.1. Grants

Each Contributor hereby grants You a world-wide, royalty-free, non-exclusive license:

- (a) under intellectual property rights (other than patent or trademark) Licensable by such Contributor to use, reproduce, make available, modify, display, perform, distribute, and otherwise exploit its Contributions, either on an unmodified basis, with Modifications, or as part of a Larger Work; and
- (b) under Patent Claims of such Contributor to make, use, sell, offer for sale, have made, import, and otherwise transfer either its Contributions or its Contributor Version.

2.2. Effective Date

The licenses granted in Section 2.1 with respect to any Contribution become effective for each Contribution on the date the Contributor first distributes such Contribution.

2.3. Limitations on Grant Scope

The licenses granted in this Section 2 are the only rights granted under this License. No additional rights or licenses will be implied from the distribution or licensing of Covered Software under this License. Notwithstanding Section 2.1(b) above, no patent license is granted by a Contributor:

- (a) for any code that a Contributor has removed from Covered Software;
- or

(b) for infringements caused by: (i) Your and any other third party's modifications of Covered Software, or (ii) the combination of its Contributions with other software (except as part of its Contributor Version); or

(c) under Patent Claims infringed by Covered Software in the absence of its Contributions.

This License does not grant any rights in the trademarks, service marks, or logos of any Contributor (except as may be necessary to comply with the notice requirements in Section 3.4).

2.4. Subsequent Licenses

No Contributor makes additional grants as a result of Your choice to distribute the Covered Software under a subsequent version of this License (see Section 10.2) or under the terms of a Secondary License (if permitted under the terms of Section 3.3).

2.5. Representation

Each Contributor represents that the Contributor believes its Contributions are its original creation(s) or it has sufficient rights to grant the rights to its Contributions conveyed by this License.

2.6. Fair Use

This License is not intended to limit any rights You have under applicable copyright doctrines of fair use, fair dealing, or other equivalents.

2.7. Conditions

Sections 3.1, 3.2, 3.3, and 3.4 are conditions of the licenses granted in Section 2.1.

3. Responsibilities

3.1. Distribution of Source Form

All distribution of Covered Software in Source Code Form, including any Modifications that You create or to which You contribute, must be under the terms of this License. You must inform recipients that the Source Code Form of the Covered Software is governed by the terms of this License, and how they can obtain a copy of this License. You may not attempt to alter or restrict the recipients' rights in the Source Code Form.

3.2. Distribution of Executable Form

If You distribute Covered Software in Executable Form then:

- (a) such Covered Software must also be made available in Source Code Form, as described in Section 3.1, and You must inform recipients of the Executable Form how they can obtain a copy of such Source Code Form by reasonable means in a timely manner, at a charge no more than the cost of distribution to the recipient; and
- (b) You may distribute such Executable Form under the terms of this License, or sublicense it under different terms, provided that the license for the Executable Form does not attempt to limit or alter the recipients' rights in the Source Code Form under this License.

3.3. Distribution of a Larger Work

You may create and distribute a Larger Work under terms of Your choice, provided that You also comply with the requirements of this License for the Covered Software. If the Larger Work is a combination of Covered Software with a work governed by one or more Secondary Licenses, and the Covered Software is not Incompatible With Secondary Licenses, this License permits You to additionally distribute such Covered Software under the terms of such Secondary License(s), so that the recipient of the Larger Work may, at their option, further distribute the Covered Software under the terms of either this License or such Secondary

License(s).

3.4. Notices

You may not remove or alter the substance of any license notices (including copyright notices, patent notices, disclaimers of warranty, or limitations of liability) contained within the Source Code Form of the Covered Software, except that You may alter any license notices to the extent required to remedy known factual inaccuracies.

3.5. Application of Additional Terms

You may choose to offer, and to charge a fee for, warranty, support, indemnity or liability obligations to one or more recipients of Covered Software. However, You may do so only on Your own behalf, and not on behalf of any Contributor. You must make it absolutely clear that any such warranty, support, indemnity, or liability obligation is offered by You alone, and You hereby agree to indemnify every Contributor for any liability incurred by such Contributor as a result of warranty, support, indemnity or liability terms You offer. You may include additional disclaimers of warranty and limitations of liability specific to any jurisdiction.

4. Inability to Comply Due to Statute or Regulation

If it is impossible for You to comply with any of the terms of this License with respect to some or all of the Covered Software due to statute, judicial order, or regulation then You must: (a) comply with the terms of this License to the maximum extent possible; and (b) describe the limitations and the code they affect. Such description must be placed in a text file included with all distributions of the Covered Software under this License. Except to the extent prohibited by statute or regulation, such description must be sufficiently detailed for a recipient of ordinary skill to be able to understand it.

5. Termination

5.1. The rights granted under this License will terminate automatically if You fail to comply with any of its terms. However, if You become compliant, then the rights granted under this License from a particular Contributor are reinstated (a) provisionally, unless and until such Contributor explicitly and finally terminates Your grants, and (b) on an ongoing basis, if such Contributor fails to notify You of the non-compliance by some reasonable means prior to 60 days after You have come back into compliance. Moreover, Your grants from a particular Contributor are reinstated on an ongoing basis if such Contributor notifies You of the non-compliance by some reasonable means, this is the first time You have received notice of non-compliance with this License from such Contributor, and You become compliant prior to 30 days after Your receipt of the notice.

5.2. If You initiate litigation against any entity by asserting a patent infringement claim (excluding declaratory judgment actions, counter-claims, and cross-claims) alleging that a Contributor Version directly or indirectly infringes any patent, then the rights granted to You by any and all Contributors for the Covered Software under Section 2.1 of this License shall terminate.

5.3. In the event of termination under Sections 5.1 or 5.2 above, all end user license agreements (excluding distributors and resellers) which have been validly granted by You or Your distributors under this License prior to termination shall survive termination.

* *
* 6. Disclaimer of Warranty *
* ----- *

* *
* Covered Software is provided under this License on an "as is" *
* basis, without warranty of any kind, either expressed, implied, or *
* statutory, including, without limitation, warranties that the *
* Covered Software is free of defects, merchantable, fit for a *
* particular purpose or non-infringing. The entire risk as to the *
* quality and performance of the Covered Software is with You. *

* Should any Covered Software prove defective in any respect, You *
* (not any Contributor) assume the cost of any necessary servicing, *
* repair, or correction. This disclaimer of warranty constitutes an *
* essential part of this License. No use of any Covered Software is *
* authorized under this License except under this disclaimer. *
* * *

* *
* **7. Limitation of Liability** *
* ----- *

* *
* Under no circumstances and under no legal theory, whether tort *
* (including negligence), contract, or otherwise, shall any *
* Contributor, or anyone who distributes Covered Software as *
* permitted above, be liable to You for any direct, indirect, *
* special, incidental, or consequential damages of any character *
* including, without limitation, damages for lost profits, loss of *
* goodwill, work stoppage, computer failure or malfunction, or any *
* and all other commercial damages or losses, even if such party *
* shall have been informed of the possibility of such damages. This *
* limitation of liability shall not apply to liability for death or *
* personal injury resulting from such party's negligence to the *
* extent applicable law prohibits such limitation. Some *
* jurisdictions do not allow the exclusion or limitation of *
* incidental or consequential damages, so this exclusion and *
* limitation may not apply to You. *
* * *

8. Litigation

Any litigation relating to this License may be brought only in the courts of a jurisdiction where the defendant maintains its principal place of business and such litigation shall be governed by laws of that jurisdiction, without reference to its conflict-of-law provisions.

Nothing in this Section shall prevent a party's ability to bring cross-claims or counter-claims.

9. Miscellaneous

This License represents the complete agreement concerning the subject matter hereof. If any provision of this License is held to be unenforceable, such provision shall be reformed only to the extent necessary to make it enforceable. Any law or regulation which provides that the language of a contract shall be construed against the drafter shall not be used to construe this License against a Contributor.

10. Versions of the License

10.1. New Versions

Mozilla Foundation is the license steward. Except as provided in Section 10.3, no one other than the license steward has the right to modify or publish new versions of this License. Each version will be given a distinguishing version number.

10.2. Effect of New Versions

You may distribute the Covered Software under the terms of the version of the License under which You originally received the Covered Software, or under the terms of any subsequent version published by the license steward.

10.3. Modified Versions

If you create software not governed by this License, and you want to create a new license for such software, you may create and use a modified version of this License if you rename the license and remove any references to the name of the license steward (except to note that such modified license differs from this License).

10.4. Distributing Source Code Form that is Incompatible With Secondary Licenses

If You choose to distribute Source Code Form that is Incompatible With Secondary Licenses under the terms of this version of the License, the notice described in Exhibit B of this License must be attached.

Exhibit A – Source Code Form License Notice

This Source Code Form is subject to the terms of the Mozilla Public License, v. 2.0. If a copy of the MPL was not distributed with this file, You can obtain one at <http://mozilla.org/MPL/2.0/>.

If it is not possible or desirable to put the notice in a particular file, then You may include the notice in a location (such as a LICENSE file in a relevant directory) where a recipient would be likely to look for such a notice.

You may add additional accurate notices of copyright ownership.

Exhibit B – "Incompatible With Secondary Licenses" Notice

This Source Code Form is "Incompatible With Secondary Licenses", as defined by the Mozilla Public License, v. 2.0.

=====

The source code of `httpcomponents-client` can be obtained at <https://github.com/apache/httpcomponents-client/tree/rel/v4.5.13>.

=====

Apache HttpComponents Client
Copyright 1999–2020 The Apache Software Foundation

This product includes software developed at
The Apache Software Foundation (<http://www.apache.org/>).

7. Apache HTTPComponents HttpCore

Apache License

Version 2.0, January 2004

<http://www.apache.org/licenses/>

TERMS AND CONDITIONS FOR USE, REPRODUCTION, AND DISTRIBUTION

1. Definitions.

"License" shall mean the terms and conditions for use, reproduction, and distribution as defined by Sections 1 through 9 of this document.

"Licensor" shall mean the copyright owner or entity authorized by the copyright owner that is granting the License.

"Legal Entity" shall mean the union of the acting entity and all other entities that control, are controlled by, or are under common control with that entity. For the purposes of this definition, "control" means (i) the power, direct or indirect, to cause the direction or management of such entity, whether by contract or otherwise, or (ii) ownership of fifty percent (50%) or more of the outstanding shares, or (iii) beneficial ownership of such entity.

"You" (or "Your") shall mean an individual or Legal Entity exercising permissions granted by this License.

"Source" form shall mean the preferred form for making modifications, including but not limited to software source code, documentation source, and configuration files.

"Object" form shall mean any form resulting from mechanical transformation or translation of a Source form, including but not limited to compiled object code, generated documentation, and conversions to other media types.

"Work" shall mean the work of authorship, whether in Source or Object form, made available under the License, as indicated by a copyright notice that is included in or attached to the work (an example is provided in the Appendix below).

"Derivative Works" shall mean any work, whether in Source or Object form, that is based on (or derived from) the Work and for which the editorial revisions, annotations, elaborations, or other modifications represent, as a whole, an original work of authorship. For the purposes of this License, Derivative Works shall not include works that remain separable from, or merely link (or bind by name) to the interfaces of, the Work and Derivative Works thereof.

"Contribution" shall mean any work of authorship, including the original version of the Work and any modifications or additions to that Work or Derivative Works thereof, that is intentionally submitted to Licensor for inclusion in the Work by the copyright owner or by an individual or Legal Entity authorized to submit on behalf of the copyright owner. For the purposes of this definition, "submitted" means any form of electronic, verbal, or written communication sent to the Licensor or its representatives, including but not limited to communication on electronic mailing lists, source code control systems, and issue tracking systems that are managed by, or on behalf of, the Licensor for the purpose of discussing and improving the Work, but excluding communication that is conspicuously

marked or otherwise designated in writing by the copyright owner as "Not a Contribution."

"Contributor" shall mean Licensor and any individual or Legal Entity on behalf of whom a Contribution has been received by Licensor and subsequently incorporated within the Work.

2. Grant of Copyright License. Subject to the terms and conditions of this License, each Contributor hereby grants to You a perpetual, worldwide, non-exclusive, no-charge, royalty-free, irrevocable copyright license to reproduce, prepare Derivative Works of, publicly display, publicly perform, sublicense, and distribute the Work and such Derivative Works in Source or Object form.

3. Grant of Patent License. Subject to the terms and conditions of this License, each Contributor hereby grants to You a perpetual, worldwide, non-exclusive, no-charge, royalty-free, irrevocable (except as stated in this section) patent license to make, have made, use, offer to sell, sell, import, and otherwise transfer the Work, where such license applies only to those patent claims licensable by such Contributor that are necessarily infringed by their Contribution(s) alone or by combination of their Contribution(s) with the Work to which such Contribution(s) was submitted. If You institute patent litigation against any entity (including a cross-claim or counterclaim in a lawsuit) alleging that the Work or a Contribution incorporated within the Work constitutes direct or contributory patent infringement, then any patent licenses granted to You under this License for that Work shall terminate as of the date such litigation is filed.

4. Redistribution. You may reproduce and distribute copies of the Work or Derivative Works thereof in any medium, with or without modifications, and in Source or Object form, provided that You meet the following conditions:

1. You must give any other recipients of the Work or Derivative Works a copy of this License; and

2. You must cause any modified files to carry prominent notices stating that You changed the files; and

3. You must retain, in the Source form of any Derivative Works that You distribute, all copyright, patent, trademark, and attribution notices from the Source form of the Work, excluding those notices that do not pertain to any part of the Derivative Works; and

4. If the Work includes a "NOTICE" text file as part of its distribution, then any Derivative Works that You distribute must include a readable copy of the attribution notices contained within such NOTICE file, excluding those notices that do not pertain to any part of the Derivative Works, in at least one of the following places: within a NOTICE text file distributed as part of the Derivative Works; within the Source form or documentation, if provided along with the Derivative Works; or, within a display generated by the Derivative Works, if and wherever such third-party notices normally appear. The contents of the NOTICE file are for informational purposes only and do not modify the License. You may add Your own attribution notices within Derivative Works that You distribute, alongside or as an addendum to the NOTICE text from the Work, provided that such additional attribution notices cannot be construed as modifying the License.

You may add Your own copyright statement to Your modifications and may provide additional or different license terms and conditions for use, reproduction, or distribution of Your modifications, or for any such Derivative Works as a whole, provided Your use, reproduction, and distribution of the Work otherwise complies with the conditions stated in this License.

5. Submission of Contributions. Unless You explicitly state otherwise, any Contribution intentionally submitted for inclusion in the Work by You to the Licensor shall be under the terms and conditions of this License, without any additional terms or conditions. Notwithstanding the above, nothing herein shall supersede or modify the terms of any separate license agreement you may have executed with Licensor regarding such Contributions.

6. Trademarks. This License does not grant permission to use the trade names, trademarks, service marks, or product names of the Licensor, except as required for reasonable and customary use in describing the origin of the Work and reproducing the content of the NOTICE file.

7. Disclaimer of Warranty. Unless required by applicable law or agreed to in writing, Licensor provides the Work (and each Contributor provides its Contributions) on an "AS IS" BASIS, WITHOUT WARRANTIES OR CONDITIONS OF ANY KIND, either express or implied, including, without limitation, any warranties or conditions of TITLE, NON-INFRINGEMENT, MERCHANTABILITY, or FITNESS FOR A PARTICULAR PURPOSE. You are solely responsible for determining the appropriateness of using or redistributing the Work and assume any risks associated with Your exercise of permissions under this License.

8. Limitation of Liability. In no event and under no legal theory, whether in tort (including negligence), contract, or otherwise, unless required by applicable law (such as deliberate and grossly negligent acts) or agreed to in writing, shall any Contributor be liable to You for damages, including any direct, indirect, special, incidental, or consequential damages of any character arising as a result of this License or out of the use or inability to use the Work (including but not limited to damages for loss of goodwill, work stoppage, computer failure or malfunction, or any and all other commercial damages or losses), even if such Contributor has been advised of the possibility of such damages.

9. Accepting Warranty or Additional Liability. While redistributing the Work or Derivative Works thereof, You may choose to offer, and charge a fee for, acceptance of support, warranty, indemnity, or other liability obligations and/or rights consistent with this License. However, in accepting such obligations, You may act only on Your own behalf and on Your sole responsibility, not on behalf of any other Contributor, and only if You agree to indemnify, defend, and hold each Contributor harmless for any liability incurred by, or claims asserted against, such Contributor by reason of your accepting any such warranty or additional liability.

END OF TERMS AND CONDITIONS

APPENDIX: How to apply the Apache License to your work¶

To apply the Apache License to your work, attach the following boilerplate notice, with the fields enclosed by brackets "[]" replaced with your own identifying information. (Don't include the brackets!) The text should be enclosed in the appropriate comment syntax for the file format. We also

recommend that a file or class name and description of purpose be included on the same "printed page" as the copyright notice for easier identification within third-party archives.

Copyright [yyyy] [name of copyright owner]

Licensed under the Apache License, Version 2.0 (the "License");
you may not use this file except in compliance with the License.
You may obtain a copy of the License at

<http://www.apache.org/licenses/LICENSE-2.0>

Unless required by applicable law or agreed to in writing, software
distributed under the License is distributed on an "AS IS" BASIS,
WITHOUT WARRANTIES OR CONDITIONS OF ANY KIND, either express or implied.
See the License for the specific language governing permissions and
limitations under the License.

Apache HttpCore

Copyright 2005–2019 The Apache Software Foundation

This product includes software developed at
The Apache Software Foundation (<http://www.apache.org/>).

8. Apache log4j

Apache License

Version 2.0, January 2004

<http://www.apache.org/licenses/>

TERMS AND CONDITIONS FOR USE, REPRODUCTION, AND DISTRIBUTION

1. Definitions.

"License" shall mean the terms and conditions for use, reproduction, and distribution as defined by Sections 1 through 9 of this document.

"Licensor" shall mean the copyright owner or entity authorized by the copyright owner that is granting the License.

"Legal Entity" shall mean the union of the acting entity and all other entities that control, are controlled by, or are under common control with that entity. For the purposes of this definition, "control" means (i) the power, direct or indirect, to cause the direction or management of such entity, whether by contract or otherwise, or (ii) ownership of fifty percent (50%) or more of the outstanding shares, or (iii) beneficial ownership of such entity.

"You" (or "Your") shall mean an individual or Legal Entity exercising permissions granted by this License.

"Source" form shall mean the preferred form for making modifications, including but not limited to software source code, documentation source, and configuration files.

"Object" form shall mean any form resulting from mechanical transformation or translation of a Source form, including but not limited to compiled object code, generated documentation, and conversions to other media types.

"Work" shall mean the work of authorship, whether in Source or Object form, made available under the License, as indicated by a copyright notice that is included in or attached to the work (an example is provided in the Appendix below).

"Derivative Works" shall mean any work, whether in Source or Object form, that is based on (or derived from) the Work and for which the editorial revisions, annotations, elaborations, or other modifications represent, as a whole, an original work of authorship. For the purposes of this License, Derivative Works shall not include works that remain separable from, or merely link (or bind by name) to the interfaces of, the Work and Derivative Works thereof.

"Contribution" shall mean any work of authorship, including the original version of the Work and any modifications or additions to that Work or Derivative Works thereof, that is intentionally submitted to Licensor for inclusion in the Work by the copyright owner or by an individual or Legal Entity authorized to submit on behalf of the copyright owner. For the purposes of this definition, "submitted" means any form of electronic, verbal, or written communication sent to the Licensor or its representatives, including but not limited to communication on electronic mailing lists, source code control systems, and issue tracking systems that are managed by, or on behalf of, the Licensor for the purpose of discussing and improving the Work, but excluding communication that is conspicuously marked or otherwise designated in writing by the copyright owner as "Not a Contribution."

"Contributor" shall mean Licensor and any individual or Legal Entity on behalf of whom a Contribution has been received by Licensor and subsequently incorporated within the Work.

2. Grant of Copyright License. Subject to the terms and conditions of this License, each Contributor hereby grants to You a perpetual, worldwide, non-exclusive, no-charge, royalty-free, irrevocable

copyright license to reproduce, prepare Derivative Works of, publicly display, publicly perform, sublicense, and distribute the Work and such Derivative Works in Source or Object form.

3. Grant of Patent License. Subject to the terms and conditions of this License, each Contributor hereby grants to You a perpetual, worldwide, non-exclusive, no-charge, royalty-free, irrevocable (except as stated in this section) patent license to make, have made, use, offer to sell, sell, import, and otherwise transfer the Work, where such license applies only to those patent claims licensable by such Contributor that are necessarily infringed by their Contribution(s) alone or by combination of their Contribution(s) with the Work to which such Contribution(s) was submitted. If You institute patent litigation against any entity (including a cross-claim or counterclaim in a lawsuit) alleging that the Work or a Contribution incorporated within the Work constitutes direct or contributory patent infringement, then any patent licenses granted to You under this License for that Work shall terminate as of the date such litigation is filed.

4. Redistribution. You may reproduce and distribute copies of the Work or Derivative Works thereof in any medium, with or without modifications, and in Source or Object form, provided that You meet the following conditions:

- a. You must give any other recipients of the Work or Derivative Works a copy of this License; and
- b. You must cause any modified files to carry prominent notices stating that You changed the files; and
- c. You must retain, in the Source form of any Derivative Works that You distribute, all copyright, patent, trademark, and attribution notices from the Source form of the Work, excluding those notices that do not pertain to any part of the Derivative Works; and
- d. If the Work includes a "NOTICE" text file as part of its distribution, then any Derivative Works that You distribute must include a readable copy of the attribution notices contained within such NOTICE file, excluding those notices that do not pertain to any part of the Derivative Works, in at least one of the following places: within a NOTICE text file distributed as part of the Derivative Works; within the Source form or documentation, if provided along with the Derivative Works; or, within a display generated by the Derivative Works, if and wherever such third-party notices normally appear. The contents of the NOTICE file are for informational purposes only and do not modify the License. You may add Your own attribution notices within Derivative Works that You distribute, alongside or as an addendum to the NOTICE text from the Work, provided that such additional attribution notices cannot be construed as modifying the License.

You may add Your own copyright statement to Your modifications and may provide additional or different license terms and conditions for use, reproduction, or distribution of Your modifications, or for any such Derivative Works as a whole, provided Your use, reproduction, and distribution of the Work otherwise complies with the conditions stated in this License.

5. Submission of Contributions. Unless You explicitly state otherwise, any Contribution intentionally submitted for inclusion in the Work by You to the Licensor shall be under the terms and conditions of

this License, without any additional terms or conditions. Notwithstanding the above, nothing herein shall supersede or modify the terms of any separate license agreement you may have executed with Licensor regarding such Contributions.

6. Trademarks. This License does not grant permission to use the trade names, trademarks, service marks, or product names of the Licensor, except as required for reasonable and customary use in describing the origin of the Work and reproducing the content of the NOTICE file.

7. Disclaimer of Warranty. Unless required by applicable law or agreed to in writing, Licensor provides the Work (and each Contributor provides its Contributions) on an "AS IS" BASIS, WITHOUT WARRANTIES OR CONDITIONS OF ANY KIND, either express or implied, including, without limitation, any warranties or conditions of TITLE, NON-INFRINGEMENT, MERCHANTABILITY, or FITNESS FOR A PARTICULAR PURPOSE. You are solely responsible for determining the appropriateness of using or redistributing the Work and assume any risks associated with Your exercise of permissions under this License.

8. Limitation of Liability. In no event and under no legal theory, whether in tort (including negligence), contract, or otherwise, unless required by applicable law (such as deliberate and grossly negligent acts) or agreed to in writing, shall any Contributor be liable to You for damages, including any direct, indirect, special, incidental, or consequential damages of any character arising as a result of this License or out of the use or inability to use the Work (including but not limited to damages for loss of goodwill, work stoppage, computer failure or malfunction, or any and all other commercial damages or losses), even if such Contributor has been advised of the possibility of such damages.

9. Accepting Warranty or Additional Liability. While redistributing the Work or Derivative Works thereof, You may choose to offer, and charge a fee for, acceptance of support, warranty, indemnity, or other liability obligations and/or rights consistent with this License. However, in accepting such obligations, You may act only on Your own behalf and on Your sole responsibility, not on behalf of any other Contributor, and only if You agree to indemnify, defend, and hold each Contributor harmless for any liability incurred by, or claims asserted against, such Contributor by reason of your accepting any such warranty or additional liability.

END OF TERMS AND CONDITIONS

APPENDIX: How to apply the Apache License to your work

To apply the Apache License to your work, attach the following boilerplate notice, with the fields enclosed by brackets "[]" replaced with your own identifying information. (Don't include the brackets!) The text should be enclosed in the appropriate comment syntax for the file format. We also recommend that a file or class name and description of purpose be included on the same "printed page" as the copyright notice for easier identification within third-party archives.

Copyright [yyyy] [name of copyright owner] Licensed under the Apache License, Version 2.0 (the "License"); you may not use this file except in compliance with the License. You may obtain a copy of the License at <http://www.apache.org/licenses/LICENSE-2.0> Unless required by applicable law or agreed to in writing, software distributed under the License is distributed on an "AS IS" BASIS,

WITHOUT WARRANTIES OR CONDITIONS OF ANY KIND, either express or implied. See the License for the specific language governing permissions and limitations under the License.

9.ARM CMSIS (Cortex Microcontroller Software Interface Standard)

Apache License

Version 2.0, January 2004

<http://www.apache.org/licenses/>

TERMS AND CONDITIONS FOR USE, REPRODUCTION, AND DISTRIBUTION

1. Definitions.

"License" shall mean the terms and conditions for use, reproduction, and distribution as defined by Sections 1 through 9 of this document.

"Licensor" shall mean the copyright owner or entity authorized by the copyright owner that is granting the License.

"Legal Entity" shall mean the union of the acting entity and all other entities that control, are controlled by, or are under common control with that entity. For the purposes of this definition, "control" means (i) the power, direct or indirect, to cause the direction or management of such entity, whether by contract or otherwise, or (ii) ownership of fifty percent (50%) or more of the outstanding shares, or (iii) beneficial ownership of such entity.

"You" (or "Your") shall mean an individual or Legal Entity exercising permissions granted by this License.

"Source" form shall mean the preferred form for making modifications, including but not limited to software source code, documentation source, and configuration files.

"Object" form shall mean any form resulting from mechanical transformation or translation of a Source form, including but not limited to compiled object code, generated documentation, and conversions to other media types.

"Work" shall mean the work of authorship, whether in Source or Object form, made available under the License, as indicated by a copyright notice that is included in or attached to the work (an example is provided in the Appendix below).

"Derivative Works" shall mean any work, whether in Source or Object form, that is based on (or derived from) the Work and for which the editorial revisions, annotations, elaborations, or other modifications represent, as a whole, an original work of authorship. For the purposes of this License, Derivative Works shall not include works that remain separable from, or merely link (or bind by name) to the interfaces of, the Work and Derivative Works thereof.

"Contribution" shall mean any work of authorship, including the original version of the Work and any modifications or additions to that Work or Derivative Works thereof, that is intentionally submitted to Licensor for inclusion in the Work by the copyright owner or by an individual or Legal Entity authorized to submit on behalf of the copyright owner. For the purposes of this definition, "submitted" means any form of electronic, verbal, or written communication sent to the Licensor or its representatives, including but not limited to communication on electronic mailing lists, source code control systems, and issue tracking systems that are managed by, or on behalf of, the Licensor for the purpose of discussing and improving the Work, but excluding communication that is conspicuously marked or otherwise designated in writing by the copyright owner as "Not a Contribution."

"Contributor" shall mean Licensor and any individual or Legal Entity on behalf of whom a Contribution has been received by Licensor and subsequently incorporated within the Work.

2. Grant of Copyright License. Subject to the terms and conditions of this License, each Contributor hereby grants to You a perpetual, worldwide, non-exclusive, no-charge, royalty-free, irrevocable copyright license to reproduce, prepare Derivative Works of, publicly display, publicly perform, sublicense, and distribute the Work and such Derivative Works in Source or Object form.

3. Grant of Patent License. Subject to the terms and conditions of this License, each Contributor hereby grants to You a perpetual, worldwide, non-exclusive, no-charge, royalty-free, irrevocable (except as stated in this section) patent license to make, have made, use, offer to sell, sell, import, and otherwise transfer the Work, where such license applies only to those patent claims licensable by such Contributor that are necessarily infringed by their Contribution(s) alone or by combination of their Contribution(s) with the Work to which such Contribution(s) was submitted. If You institute patent litigation against any entity (including a cross-claim or counterclaim in a lawsuit) alleging that the Work or a Contribution incorporated within the Work constitutes direct or contributory patent infringement, then any patent licenses granted to You under this License for that Work shall terminate as of the date such litigation is filed.

4. Redistribution. You may reproduce and distribute copies of the Work or Derivative Works thereof in any medium, with or without modifications, and in Source or Object form, provided that You meet the following conditions:

(a) You must give any other recipients of the Work or Derivative Works a copy of this License; and

(b) You must cause any modified files to carry prominent notices stating that You changed the files;
and

(c) You must retain, in the Source form of any Derivative Works that You distribute, all copyright, patent, trademark, and attribution notices from the Source form of the Work, excluding those notices that do not pertain to any part of the Derivative Works; and

(d) If the Work includes a "NOTICE" text file as part of its distribution, then any Derivative Works that You distribute must include a readable copy of the attribution notices contained within such NOTICE file, excluding those notices that do not pertain to any part of the Derivative Works, in at least one of the following places: within a NOTICE text file distributed as part of the Derivative Works; within the Source form or documentation, if provided along with the Derivative Works; or, within a display generated by the Derivative Works, if and wherever such third-party notices normally appear. The contents of the NOTICE file are for informational purposes only and do not modify the License. You may add Your own attribution notices within Derivative Works that You distribute, alongside or as an addendum to the NOTICE text from the Work, provided that such additional attribution notices cannot be construed as modifying the License.

You may add Your own copyright statement to Your modifications and may provide additional or different license terms and conditions for use, reproduction, or distribution of Your modifications, or for any such Derivative Works as a whole, provided Your use, reproduction, and distribution of the Work otherwise complies with the conditions stated in this License.

5. Submission of Contributions. Unless You explicitly state otherwise, any Contribution intentionally submitted for inclusion in the Work by You to the Licensor shall be under the terms and conditions of this License, without any additional terms or conditions. Notwithstanding the above, nothing herein shall supersede or modify the terms of any separate license agreement you may have executed with Licensor regarding such Contributions.

6. Trademarks. This License does not grant permission to use the trade names, trademarks, service marks, or product names of the Licensor, except as required for reasonable and customary use in describing the origin of the Work and reproducing the content of the NOTICE file.

7. Disclaimer of Warranty. Unless required by applicable law or agreed to in writing, Licensor provides the Work (and each Contributor provides its Contributions) on an "AS IS" BASIS, WITHOUT WARRANTIES OR CONDITIONS OF ANY KIND, either express or implied, including, without limitation, any warranties or conditions of TITLE, NON-INFRINGEMENT, MERCHANTABILITY, or FITNESS FOR A PARTICULAR PURPOSE. You are solely responsible for determining the appropriateness of using or redistributing the Work and assume any risks associated with Your exercise of permissions under this License.

8. Limitation of Liability. In no event and under no legal theory, whether in tort (including negligence), contract, or otherwise, unless required by applicable law (such as deliberate and grossly negligent acts) or agreed to in writing, shall any Contributor be liable to You for damages, including any direct, indirect, special, incidental, or consequential damages of any character arising as a result of this License or out of the use or inability to use the Work (including but not limited to damages for loss of goodwill, work stoppage, computer failure or malfunction, or any and all other commercial damages or losses), even if such Contributor has been advised of the possibility of such damages.

9. Accepting Warranty or Additional Liability. While redistributing the Work or Derivative Works thereof, You may choose to offer, and charge a fee for, acceptance of support, warranty, indemnity, or other liability obligations and/or rights consistent with this License. However, in accepting such obligations, You may act only on Your own behalf and on Your sole responsibility, not on behalf of any other Contributor, and only if You agree to indemnify, defend, and hold each Contributor harmless for any liability incurred by, or claims asserted against, such Contributor by reason of your accepting any such warranty or additional liability.

END OF TERMS AND CONDITIONS

APPENDIX: How to apply the Apache License to your work.

To apply the Apache License to your work, attach the following boilerplate notice, with the fields enclosed by brackets "[]" replaced with your own identifying information. (Don't include the brackets!) The text should be enclosed in the appropriate comment syntax for the file format. We also recommend that a file or class name and description of purpose be included on the same "printed page" as the copyright notice for easier identification within third-party archives.

Copyright [yyyy] [name of copyright owner]

Licensed under the Apache License, Version 2.0 (the "License");
you may not use this file except in compliance with the License. You may obtain a copy of the License
at

<http://www.apache.org/licenses/LICENSE-2.0>

Unless required by applicable law or agreed to in writing, software distributed under the License is distributed on an "AS IS" BASIS, WITHOUT WARRANTIES OR CONDITIONS OF ANY KIND, either express or implied. See the License for the specific language governing permissions and limitations under the License.

10. AWS IoT Device SDK

Apache License

Version 2.0, January 2004

TERMS AND CONDITIONS FOR USE, REPRODUCTION, AND DISTRIBUTION

1. Definitions.

"License" shall mean the terms and conditions for use, reproduction, and distribution as defined by Sections 1 through 9 of this document.

"Licensor" shall mean the copyright owner or entity authorized by the copyright owner that is granting the License.

"Legal Entity" shall mean the union of the acting entity and all other entities that control, are controlled by, or are under common control with that entity. For the purposes of this definition, "control" means (i) the power, direct or indirect, to cause the direction or management of such entity, whether by contract or otherwise, or (ii) ownership of fifty percent (50%) or more of the outstanding shares, or (iii) beneficial ownership of such entity.

"You" (or "Your") shall mean an individual or Legal Entity exercising permissions granted by this License.

"Source" form shall mean the preferred form for making modifications, including but not limited to software source code, documentation source, and configuration files.

"Object" form shall mean any form resulting from mechanical transformation or translation of a Source form, including but not limited to compiled object code, generated documentation, and conversions to other media types.

"Work" shall mean the work of authorship, whether in Source or Object form, made available under the License, as indicated by a copyright notice that is included in or attached to the work (an example is provided in the Appendix below).

"Derivative Works" shall mean any work, whether in Source or Object form, that is based on (or derived from) the Work and for which the editorial revisions, annotations, elaborations, or other modifications represent, as a whole, an original work of authorship. For the purposes of this License, Derivative Works shall not include

works that remain separable from, or merely link (or bind by name) to the interfaces of, the Work and Derivative Works thereof.

"Contribution" shall mean any work of authorship, including the original version of the Work and any modifications or additions to that Work or Derivative Works thereof, that is intentionally submitted to Licensor for inclusion in the Work by the copyright owner or by an individual or Legal Entity authorized to submit on behalf of the copyright owner. For the purposes of this definition, "submitted" means any form of electronic, verbal, or written communication sent to the Licensor or its representatives, including but not limited to communication on electronic mailing lists, source code control systems, and issue tracking systems that are managed by, or on behalf of, the Licensor for the purpose of discussing and improving the Work, but excluding communication that is conspicuously marked or otherwise designated in writing by the copyright owner as "Not a Contribution."

"Contributor" shall mean Licensor and any individual or Legal Entity on behalf of whom a Contribution has been received by Licensor and subsequently incorporated within the Work.

2. Grant of Copyright License. Subject to the terms and conditions of this License, each Contributor hereby grants to You a perpetual, worldwide, non-exclusive, no-charge, royalty-free, irrevocable copyright license to reproduce, prepare Derivative Works of, publicly display, publicly perform, sublicense, and distribute the Work and such Derivative Works in Source or Object form.

3. Grant of Patent License. Subject to the terms and conditions of this License, each Contributor hereby grants to You a perpetual, worldwide, non-exclusive, no-charge, royalty-free, irrevocable (except as stated in this section) patent license to make, have made, use, offer to sell, sell, import, and otherwise transfer the Work, where such license applies only to those patent claims licensable by such Contributor that are necessarily infringed by their Contribution(s) alone or by combination of their Contribution(s) with the Work to which such Contribution(s) was submitted. If You institute patent litigation against any entity (including a cross-claim or counterclaim in a lawsuit) alleging that the Work or a Contribution incorporated within the Work constitutes direct or contributory patent infringement, then any patent licenses granted to You under this License for that Work shall terminate as of the date such litigation is filed.

4. Redistribution. You may reproduce and distribute copies of the Work or Derivative Works thereof in any medium, with or without modifications, and in Source or Object form, provided that You meet the following conditions:

1. You must give any other recipients of the Work or Derivative Works a copy of this License; and
2. You must cause any modified files to carry prominent notices stating that You changed the files; and

3. You must retain, in the Source form of any Derivative Works that You distribute, all copyright, patent, trademark, and attribution notices from the Source form of the Work, excluding those notices that do not pertain to any part of the Derivative Works; and

4. If the Work includes a "NOTICE" text file as part of its distribution, then any Derivative Works that You distribute must include a readable copy of the attribution notices contained within such NOTICE file, excluding those notices that do not pertain to any part of the Derivative Works, in at least one of the following places: within a NOTICE text file distributed as part of the Derivative Works; within the Source form or documentation, if provided along with the Derivative Works; or, within a display generated by the Derivative Works, if and wherever such third-party notices normally appear. The contents of the NOTICE file are for informational purposes only and do not modify the License. You may add Your own attribution notices within Derivative Works that You distribute, alongside or as an addendum to the NOTICE text from the Work, provided that such additional attribution notices cannot be construed as modifying the License.

You may add Your own copyright statement to Your modifications and may provide additional or different license terms and conditions for use, reproduction, or distribution of Your modifications, or for any such Derivative Works as a whole, provided Your use, reproduction, and distribution of the Work otherwise complies with the conditions stated in this License.

5. Submission of Contributions. Unless You explicitly state otherwise, any Contribution intentionally submitted for inclusion in the Work by You to the Licensor shall be under the terms and conditions of this License, without any additional terms or conditions. Notwithstanding the above, nothing herein shall supersede or modify the terms of any separate license agreement you may have executed with Licensor regarding such Contributions.

6. Trademarks. This License does not grant permission to use the trade names, trademarks, service marks, or product names of the Licensor, except as required for reasonable and customary use in describing the origin of the Work and reproducing the content of the NOTICE file.

7. Disclaimer of Warranty. Unless required by applicable law or agreed to in writing, Licensor provides the Work (and each Contributor provides its Contributions) on an "AS IS" BASIS, WITHOUT WARRANTIES OR CONDITIONS OF ANY KIND, either express or implied, including, without limitation, any warranties or conditions of TITLE, NON-INFRINGEMENT, MERCHANTABILITY, or FITNESS FOR A PARTICULAR PURPOSE. You are solely responsible for determining the appropriateness of using or redistributing the Work and assume any risks associated with Your exercise of permissions under this License.

8. Limitation of Liability. In no event and under no legal theory, whether in tort (including negligence), contract, or otherwise, unless required by applicable law (such as deliberate and grossly negligent acts) or agreed to in writing, shall any Contributor be liable to You for damages, including any direct, indirect, special, incidental, or consequential damages of any character arising as a result of this License or out of the use or inability to use

the Work (including but not limited to damages for loss of goodwill, work stoppage, computer failure or malfunction, or any and all other commercial damages or losses), even if such Contributor has been advised of the possibility of such damages.

9. Accepting Warranty or Additional Liability. While redistributing the Work or Derivative Works thereof, You may choose to offer, and charge a fee for, acceptance of support, warranty, indemnity, or other liability obligations and/or rights consistent with this License. However, in accepting such obligations, You may act only on Your own behalf and on Your sole responsibility, not on behalf of any other Contributor, and only if You agree to indemnify, defend, and hold each Contributor harmless for any liability incurred by, or claims asserted against, such Contributor by reason of your accepting any such warranty or additional liability.

END OF TERMS AND CONDITIONS

Note: Other license terms may apply to certain, identified software files contained within or distributed with the accompanying software if such terms are included in the directory containing the accompanying software. Such other license terms will then apply in lieu of the terms of the software license above.

JSON processing code subject to the JSON License from JSON.org:

Permission is hereby granted, free of charge, to any person obtaining a copy of this software and associated documentation files (the "Software"), to deal in the Software without restriction, including without limitation the rights to use, copy, modify, merge, publish, distribute, sublicense, and/or sell copies of the Software, and to permit persons to whom the Software is furnished to do so, subject to the following conditions:

The above copyright notice and this permission notice shall be included in all copies or substantial portions of the Software.

The Software shall be used for Good, not Evil.

THE SOFTWARE IS PROVIDED "AS IS", WITHOUT WARRANTY OF ANY KIND, EXPRESS OR IMPLIED, INCLUDING BUT NOT LIMITED TO THE WARRANTIES OF MERCHANTABILITY, FITNESS FOR A PARTICULAR PURPOSE AND NONINFRINGEMENT. IN NO EVENT SHALL THE AUTHORS OR COPYRIGHT HOLDERS BE LIABLE FOR ANY CLAIM, DAMAGES OR OTHER LIABILITY, WHETHER IN AN ACTION OF CONTRACT, TORT OR OTHERWISE, ARISING FROM, OUT OF OR IN CONNECTION WITH THE SOFTWARE OR THE USE OR OTHER DEALINGS IN THE SOFTWARE.

AWS IoT Device SDK for Java

Copyright 2010-2016 Amazon.com, Inc. or its affiliates. All Rights Reserved.

This product includes software developed by
Amazon Technologies, Inc (<http://www.amazon.com/>).

THIRD PARTY COMPONENTS

This software includes third party software subject to the following copyrights:

- PKCS#1 and PKCS#8 PEM encoded private key parsing and utility functions from oauth.googlecode.com -
Copyright 1998-2010 AOL Inc.

The licenses for these third party components are included in LICENSE.txt

11. AWS SDK for Java

Apache License

Version 2.0, January 2004

TERMS AND CONDITIONS FOR USE, REPRODUCTION, AND DISTRIBUTION

1. Definitions.

"License" shall mean the terms and conditions for use, reproduction, and distribution as defined by Sections 1 through 9 of this document.

"Licensor" shall mean the copyright owner or entity authorized by the copyright owner that is granting the License.

"Legal Entity" shall mean the union of the acting entity and all other entities that control, are controlled by, or are under common control with that entity. For the purposes of this definition, "control" means (i) the power, direct or indirect, to cause the direction or management of such entity, whether by contract or otherwise, or (ii) ownership of fifty percent (50%) or more of the outstanding shares, or (iii) beneficial ownership of such entity.

"You" (or "Your") shall mean an individual or Legal Entity exercising permissions granted by this License.

"Source" form shall mean the preferred form for making modifications, including but not limited to software source code, documentation source, and configuration files.

"Object" form shall mean any form resulting from mechanical transformation or translation of a Source form, including but not limited to compiled object code, generated documentation, and conversions to other media types.

"Work" shall mean the work of authorship, whether in Source or Object form, made available under the License, as indicated by a copyright notice that is included in or attached to the work (an example is provided in the Appendix below).

"Derivative Works" shall mean any work, whether in Source or Object form, that is based on (or derived from) the Work and for which the editorial revisions, annotations, elaborations, or other

modifications represent, as a whole, an original work of authorship. For the purposes of this License, Derivative Works shall not include works that remain separable from, or merely link (or bind by name) to the interfaces of, the Work and Derivative Works thereof.

"Contribution" shall mean any work of authorship, including the original version of the Work and any modifications or additions to that Work or Derivative Works thereof, that is intentionally submitted to Licensor for inclusion in the Work by the copyright owner or by an individual or Legal Entity authorized to submit on behalf of the copyright owner. For the purposes of this definition, "submitted" means any form of electronic, verbal, or written communication sent to the Licensor or its representatives, including but not limited to communication on electronic mailing lists, source code control systems, and issue tracking systems that are managed by, or on behalf of, the Licensor for the purpose of discussing and improving the Work, but excluding communication that is conspicuously marked or otherwise designated in writing by the copyright owner as "Not a Contribution."

"Contributor" shall mean Licensor and any individual or Legal Entity on behalf of whom a Contribution has been received by Licensor and subsequently incorporated within the Work.

2. Grant of Copyright License. Subject to the terms and conditions of this License, each Contributor hereby grants to You a perpetual, worldwide, non-exclusive, no-charge, royalty-free, irrevocable copyright license to reproduce, prepare Derivative Works of, publicly display, publicly perform, sublicense, and distribute the Work and such Derivative Works in Source or Object form.

3. Grant of Patent License. Subject to the terms and conditions of this License, each Contributor hereby grants to You a perpetual, worldwide, non-exclusive, no-charge, royalty-free, irrevocable (except as stated in this section) patent license to make, have made, use, offer to sell, sell, import, and otherwise transfer the Work, where such license applies only to those patent claims licensable by such Contributor that are necessarily infringed by their Contribution(s) alone or by combination of their Contribution(s) with the Work to which such Contribution(s) was submitted. If You institute patent litigation against any entity (including a cross-claim or counterclaim in a lawsuit) alleging that the Work or a Contribution incorporated within the Work constitutes direct or contributory patent infringement, then any patent licenses granted to You under this License for that Work shall terminate as of the date such litigation is filed.

4. Redistribution. You may reproduce and distribute copies of the Work or Derivative Works thereof in any medium, with or without modifications, and in Source or Object form, provided that You meet the following conditions:

1. You must give any other recipients of the Work or Derivative Works a copy of this License; and

2. You must cause any modified files to carry prominent notices stating that You changed the files; and

3. You must retain, in the Source form of any Derivative Works that You distribute, all copyright, patent, trademark, and attribution notices from the Source form of the Work, excluding those notices that do not pertain to any part of the Derivative Works; and

4. If the Work includes a "NOTICE" text file as part of its distribution, then any Derivative Works that You distribute must include a readable copy of the attribution notices contained within such NOTICE file, excluding those notices that do not pertain to any part of the Derivative Works, in at least one of the following places: within a NOTICE text file distributed as part of the Derivative Works; within the Source form or documentation, if provided along with the Derivative Works; or, within a display generated by the Derivative Works, if and wherever such third-party notices normally appear. The contents of the NOTICE file are for informational purposes only and do not modify the License. You may add Your own attribution notices within Derivative Works that You distribute, alongside or as an addendum to the NOTICE text from the Work, provided that such additional attribution notices cannot be construed as modifying the License.

You may add Your own copyright statement to Your modifications and may provide additional or different license terms and conditions for use, reproduction, or distribution of Your modifications, or for any such Derivative Works as a whole, provided Your use, reproduction, and distribution of the Work otherwise complies with the conditions stated in this License.

5. Submission of Contributions. Unless You explicitly state otherwise, any Contribution intentionally submitted for inclusion in the Work by You to the Licensor shall be under the terms and conditions of this License, without any additional terms or conditions. Notwithstanding the above, nothing herein shall supersede or modify the terms of any separate license agreement you may have executed with Licensor regarding such Contributions.

6. Trademarks. This License does not grant permission to use the trade names, trademarks, service marks, or product names of the Licensor, except as required for reasonable and customary use in describing the origin of the Work and reproducing the content of the NOTICE file.

7. Disclaimer of Warranty. Unless required by applicable law or agreed to in writing, Licensor provides the Work (and each Contributor provides its Contributions) on an "AS IS" BASIS, WITHOUT WARRANTIES OR CONDITIONS OF ANY KIND, either express or implied, including, without limitation, any warranties or conditions of TITLE, NON-INFRINGEMENT, MERCHANTABILITY, or FITNESS FOR A PARTICULAR PURPOSE. You are solely responsible for determining the appropriateness of using or redistributing the Work and assume any risks associated with Your exercise of permissions under this License.

8. Limitation of Liability. In no event and under no legal theory, whether in tort (including negligence), contract, or otherwise, unless required by applicable law (such as deliberate and grossly negligent acts) or agreed to in writing, shall any Contributor be liable to You for damages, including any direct, indirect, special, incidental, or consequential damages of any character arising as a result of this License or out of the use or inability to use the Work (including but not limited to damages for loss of goodwill, work stoppage, computer failure or malfunction, or any and all other commercial damages or losses), even if such Contributor has been advised of the possibility of such damages.

9. Accepting Warranty or Additional Liability. While redistributing the Work or Derivative Works thereof, You may choose to offer, and charge a fee for, acceptance of support, warranty, indemnity, or other liability obligations and/or rights consistent with this License. However, in accepting such obligations, You may act only on Your own behalf and on Your sole responsibility, not on behalf of any other Contributor, and only if You agree to indemnify, defend, and hold each Contributor harmless for any liability incurred by, or claims asserted against, such Contributor by reason of your accepting any such warranty or additional liability.

END OF TERMS AND CONDITIONS

Note: Other license terms may apply to certain, identified software files contained within or distributed with the accompanying software if such terms are included in the directory containing the accompanying software. Such other license terms will then apply in lieu of the terms of the software license above.

JSON processing code subject to the JSON License from JSON.org:

Permission is hereby granted, free of charge, to any person obtaining a copy of this software and associated documentation files (the "Software"), to deal in the Software without restriction, including without limitation the rights to use, copy, modify, merge, publish, distribute, sublicense, and/or sell copies of the Software, and to permit persons to whom the Software is furnished to do so, subject to the following conditions:

The above copyright notice and this permission notice shall be included in all copies or substantial portions of the Software.

The Software shall be used for Good, not Evil.

THE SOFTWARE IS PROVIDED "AS IS", WITHOUT WARRANTY OF ANY KIND, EXPRESS OR IMPLIED,

INCLUDING BUT NOT LIMITED TO THE WARRANTIES OF MERCHANTABILITY, FITNESS FOR A PARTICULAR PURPOSE AND NONINFRINGEMENT. IN NO EVENT SHALL THE AUTHORS OR COPYRIGHT HOLDERS BE LIABLE FOR ANY CLAIM, DAMAGES OR OTHER LIABILITY, WHETHER IN AN ACTION OF CONTRACT, TORT OR OTHERWISE, ARISING FROM, OUT OF OR IN CONNECTION WITH THE SOFTWARE OR THE USE OR OTHER DEALINGS IN THE SOFTWARE.

AWS SDK for Java

Copyright 2010–2012 Amazon.com, Inc. or its affiliates. All Rights Reserved.

This product includes software developed by
Amazon Technologies, Inc (<http://www.amazon.com/>).

THIRD PARTY COMPONENTS

This software includes third party software subject to the following copyrights:

- XML parsing and utility functions from JetS3t – Copyright 2006–2009 James Murty.
- JSON parsing and utility functions from JSON.org – Copyright 2002 JSON.org.

The licenses for these third party components are included in LICENSE.txt

12.Bootstrap

The MIT License (MIT)

Copyright (c) 2011-2014 Twitter, Inc

Permission is hereby granted, free of charge, to any person obtaining a copy of this software and associated documentation files (the "Software"), to deal in the Software without restriction, including without limitation the rights to use, copy, modify, merge, publish, distribute, sublicense, and/or sell copies of the Software, and to permit persons to whom the Software is furnished to do so, subject to the following conditions:

The above copyright notice and this permission notice shall be included in all copies or substantial portions of the Software.

THE SOFTWARE IS PROVIDED "AS IS", WITHOUT WARRANTY OF ANY KIND, EXPRESS OR IMPLIED, INCLUDING BUT NOT LIMITED TO THE WARRANTIES OF MERCHANTABILITY, FITNESS FOR A PARTICULAR PURPOSE AND NONINFRINGEMENT. IN NO EVENT SHALL THE AUTHORS OR COPYRIGHT HOLDERS BE LIABLE FOR ANY CLAIM, DAMAGES OR OTHER LIABILITY, WHETHER IN AN ACTION OF CONTRACT, TORT OR OTHERWISE, ARISING FROM, OUT OF OR IN CONNECTION WITH THE SOFTWARE OR THE USE OR OTHER DEALINGS IN THE SOFTWARE.

13.Crypto API

COPYRIGHT INFORMATION

Copyright (c) 2000 The Legion Of The Bouncy Castle (<http://www.bouncycastle.org>)

Permission is hereby granted, free of charge, to any person obtaining a copy of this software and associated documentation files (the "Software"), to deal in the Software without restriction, including without limitation the rights to use, copy, modify, merge, publish, distribute, sublicense, and/or sell copies of the Software, and to permit persons to whom the Software is furnished to do so, subject to the following conditions:

The above copyright notice and this permission notice shall be included in all copies or substantial portions of the Software.

THE SOFTWARE IS PROVIDED "AS IS", WITHOUT WARRANTY OF ANY KIND, EXPRESS OR IMPLIED, INCLUDING BUT NOT LIMITED TO THE WARRANTIES OF MERCHANTABILITY, FITNESS FOR A PARTICULAR PURPOSE AND NONINFRINGEMENT. IN NO EVENT SHALL THE AUTHORS OR COPYRIGHT HOLDERS BE LIABLE FOR ANY CLAIM, DAMAGES OR OTHER LIABILITY, WHETHER IN AN ACTION OF CONTRACT, TORT OR OTHERWISE, ARISING FROM, OUT OF OR IN CONNECTION WITH THE SOFTWARE OR THE USE OR OTHER DEALINGS IN THE SOFTWARE.

14. Dump

* Copyright (c) 1980, 1993

* The Regents of the University of California. All rights reserved.

*

* Redistribution and use in source and binary forms, with or without

* modification, are permitted provided that the following conditions

* are met:

* 1. Redistributions of source code must retain the above copyright

* notice, this list of conditions and the following disclaimer.

* 2. Redistributions in binary form must reproduce the above copyright

* notice, this list of conditions and the following disclaimer in the

* documentation and/or other materials provided with the distribution.

* 3. Neither the name of the University nor the names of its contributors

* may be used to endorse or promote products derived from this software

* without specific prior written permission.

*

* THIS SOFTWARE IS PROVIDED BY THE REGENTS AND CONTRIBUTORS ``AS IS" AND

* ANY EXPRESS OR IMPLIED WARRANTIES, INCLUDING, BUT NOT LIMITED TO, THE

* IMPLIED WARRANTIES OF MERCHANTABILITY AND FITNESS FOR A PARTICULAR PURPOSE

* ARE DISCLAIMED. IN NO EVENT SHALL THE REGENTS OR CONTRIBUTORS BE LIABLE

* FOR ANY DIRECT, INDIRECT, INCIDENTAL, SPECIAL, EXEMPLARY, OR CONSEQUENTIAL

* DAMAGES (INCLUDING, BUT NOT LIMITED TO, PROCUREMENT OF SUBSTITUTE GOODS

* OR SERVICES; LOSS OF USE, DATA, OR PROFITS; OR BUSINESS INTERRUPTION)

* HOWEVER CAUSED AND ON ANY THEORY OF LIABILITY, WHETHER IN CONTRACT, STRICT

* LIABILITY, OR TORT (INCLUDING NEGLIGENCE OR OTHERWISE) ARISING IN ANY WAY

* OUT OF THE USE OF THIS SOFTWARE, EVEN IF ADVISED OF THE POSSIBILITY OF

* SUCH DAMAGE.

Copyright (C) 1994 X Consortium

#

Permission is hereby granted, free of charge, to any person obtaining a copy

of this software and associated documentation files (the "Software"), to

deal in the Software without restriction, including without limitation the

rights to use, copy, modify, merge, publish, distribute, sublicense, and/or

sell copies of the Software, and to permit persons to whom the Software is

furnished to do so, subject to the following conditions:

#

The above copyright notice and this permission notice shall be included in

all copies or substantial portions of the Software.

#

THE SOFTWARE IS PROVIDED "AS IS", WITHOUT WARRANTY OF ANY KIND, EXPRESS OR

IMPLIED, INCLUDING BUT NOT LIMITED TO THE WARRANTIES OF MERCHANTABILITY,

FITNESS FOR A PARTICULAR PURPOSE AND NONINFRINGEMENT. IN NO EVENT SHALL THE

X CONSORTIUM BE LIABLE FOR ANY CLAIM, DAMAGES OR OTHER LIABILITY, WHETHER IN

AN ACTION OF CONTRACT, TORT OR OTHERWISE, ARISING FROM, OUT OF OR IN CONNec-

TION WITH THE SOFTWARE OR THE USE OR OTHER DEALINGS IN THE SOFTWARE. +

#

Except as contained in this notice, the name of the X Consortium shall not

be used in advertising or otherwise to promote the sale, use or other deal-

ings in this Software without prior written authorization from the X Consor-

tium.

15.expat

Copyright (c) 1998, 1999, 2000 Thai Open Source Software Center Ltd
and Clark Cooper

Copyright (c) 2001, 2002, 2003, 2004, 2005, 2006 Expat maintainers.

Permission is hereby granted, free of charge, to any person obtaining a copy of this software and associated documentation files (the "Software"), to deal in the Software without restriction, including without limitation the rights to use, copy, modify, merge, publish, distribute, sublicense, and/or sell copies of the Software, and to permit persons to whom the Software is furnished to do so, subject to the following conditions:

The above copyright notice and this permission notice shall be included in all copies or substantial portions of the Software.

THE SOFTWARE IS PROVIDED "AS IS", WITHOUT WARRANTY OF ANY KIND, EXPRESS OR IMPLIED, INCLUDING BUT NOT LIMITED TO THE WARRANTIES OF MERCHANTABILITY, FITNESS FOR A PARTICULAR PURPOSE AND NONINFRINGEMENT. IN NO EVENT SHALL THE AUTHORS OR COPYRIGHT HOLDERS BE LIABLE FOR ANY CLAIM, DAMAGES OR OTHER LIABILITY, WHETHER IN AN ACTION OF CONTRACT, TORT OR OTHERWISE, ARISING FROM, OUT OF OR IN CONNECTION WITH THE SOFTWARE OR THE USE OR OTHER DEALINGS IN THE SOFTWARE.

Copyright (c) 1998, 1999, 2000 Thai Open Source Software Center Ltd

Permission is hereby granted, free of charge, to any person obtaining a copy of this software and associated documentation files (the "Software"), to deal in the Software without restriction, including without limitation the rights to use, copy, modify, merge, publish, distribute, sublicense, and/or sell copies of the Software, and to permit persons to whom the Software is furnished to do so, subject to the following conditions:

The above copyright notice and this permission notice shall be included in all copies or substantial portions of the Software.

THE SOFTWARE IS PROVIDED "AS IS", WITHOUT WARRANTY OF ANY KIND, EXPRESS OR IMPLIED, INCLUDING BUT NOT LIMITED TO THE WARRANTIES OF MERCHANTABILITY, FITNESS FOR A PARTICULAR PURPOSE AND NONINFRINGEMENT. IN NO EVENT SHALL THE AUTHORS OR COPYRIGHT HOLDERS BE LIABLE FOR ANY CLAIM, DAMAGES OR OTHER LIABILITY, WHETHER IN AN ACTION OF CONTRACT, TORT OR OTHERWISE, ARISING FROM, OUT OF OR IN CONNECTION WITH

THE SOFTWARE OR THE USE OR OTHER DEALINGS IN THE SOFTWARE.

16. flipsnap

The MIT License (MIT)

Copyright(c) 2011 PixelGrid, Inc.

Permission is hereby granted, free of charge, to any person obtaining a copy of this software and associated documentation files (the "Software"), to deal in the Software without restriction, including without limitation the rights to use, copy, modify, merge, publish, distribute, sublicense, and/or sell copies of the Software, and to permit persons to whom the Software is furnished to do so, subject to the following conditions:

The above copyright notice and this permission notice shall be included in all copies or substantial portions of the Software.

THE SOFTWARE IS PROVIDED "AS IS", WITHOUT WARRANTY OF ANY KIND, EXPRESS OR IMPLIED, INCLUDING BUT NOT LIMITED TO THE WARRANTIES OF MERCHANTABILITY, FITNESS FOR A PARTICULAR PURPOSE AND NONINFRINGEMENT. IN NO EVENT SHALL THE AUTHORS OR COPYRIGHT HOLDERS BE LIABLE FOR ANY CLAIM, DAMAGES OR OTHER LIABILITY, WHETHER IN AN ACTION OF CONTRACT, TORT OR OTHERWISE, ARISING FROM, OUT OF OR IN CONNECTION WITH THE SOFTWARE OR THE USE OR OTHER DEALINGS IN THE SOFTWARE.

17.fontconfig

Copyright © 2001,2003 Keith Packard

Permission to use, copy, modify, distribute, and sell this software and its documentation for any purpose is hereby granted without fee, provided that the above copyright notice appear in all copies and that both that copyright notice and this permission notice appear in supporting documentation, and that the name of Keith Packard not be used in advertising or publicity pertaining to distribution of the software without specific, written prior permission. Keith Packard makes no representations about the suitability of this software for any purpose. It is provided "as is" without express or implied warranty.

KEITH PACKARD DISCLAIMS ALL WARRANTIES WITH REGARD TO THIS SOFTWARE, INCLUDING ALL IMPLIED WARRANTIES OF MERCHANTABILITY AND FITNESS, IN NO EVENT SHALL KEITH PACKARD BE LIABLE FOR ANY SPECIAL, INDIRECT OR CONSEQUENTIAL DAMAGES OR ANY DAMAGES WHATSOEVER RESULTING FROM LOSS OF USE, DATA OR PROFITS, WHETHER IN AN ACTION OF CONTRACT, NEGLIGENCE OR OTHER TORTIOUS ACTION, ARISING OUT OF OR IN CONNECTION WITH THE USE OR PERFORMANCE OF THIS SOFTWARE.

18. freetype2

The FreeType Project LICENSE

2006-Jan-27

Copyright 1996-2002, 2006 by
David Turner, Robert Wilhelm, and Werner Lemberg

Introduction

=====

The FreeType Project is distributed in several archive packages; some of them may contain, in addition to the FreeType font engine, various tools and contributions which rely on, or relate to, the FreeType Project.

This license applies to all files found in such packages, and which do not fall under their own explicit license. The license affects thus the FreeType font engine, the test programs, documentation and makefiles, at the very least.

This license was inspired by the BSD, Artistic, and IJG (Independent JPEG Group) licenses, which all encourage inclusion and use of free software in commercial and freeware products alike. As a consequence, its main points are that:

- o We don't promise that this software works. However, we will be interested in any kind of bug reports. ('as is' distribution)
- o You can use this software for whatever you want, in parts or full form, without having to pay us. ('royalty-free' usage)
- o You may not pretend that you wrote this software. If you use

it, or only parts of it, in a program, you must acknowledge somewhere in your documentation that you have used the FreeType code. ('credits')

We specifically permit and encourage the inclusion of this software, with or without modifications, in commercial products. We disclaim all warranties covering The FreeType Project and assume no liability related to The FreeType Project.

Finally, many people asked us for a preferred form for a credit/disclaimer to use in compliance with this license. We thus encourage you to use the following text:

""""

Portions of this software are copyright © <year> The FreeType Project (www.freetype.org). All rights reserved.

""""

Please replace <year> with the value from the FreeType version you actually use.

Legal Terms

=====

0. Definitions

Throughout this license, the terms `package', `FreeType Project', and `FreeType archive' refer to the set of files originally distributed by the authors (David Turner, Robert Wilhelm, and Werner Lemberg) as the `FreeType Project', be they named as alpha, beta or final release.

`You' refers to the licensee, or person using the project, where `using' is a generic term including compiling the project's source code as well as linking it to form a `program' or `executable'.

This program is referred to as 'a program using the FreeType engine'.

This license applies to all files distributed in the original FreeType Project, including all source code, binaries and documentation, unless otherwise stated in the file in its original, unmodified form as distributed in the original archive. If you are unsure whether or not a particular file is covered by this license, you must contact us to verify this.

The FreeType Project is copyright (C) 1996-2000 by David Turner, Robert Wilhelm, and Werner Lemberg. All rights reserved except as specified below.

1. No Warranty

THE FREETYPE PROJECT IS PROVIDED 'AS IS' WITHOUT WARRANTY OF ANY KIND, EITHER EXPRESS OR IMPLIED, INCLUDING, BUT NOT LIMITED TO, WARRANTIES OF MERCHANTABILITY AND FITNESS FOR A PARTICULAR PURPOSE. IN NO EVENT WILL ANY OF THE AUTHORS OR COPYRIGHT HOLDERS BE LIABLE FOR ANY DAMAGES CAUSED BY THE USE OR THE INABILITY TO USE, OF THE FREETYPE PROJECT.

2. Redistribution

This license grants a worldwide, royalty-free, perpetual and irrevocable right and license to use, execute, perform, compile, display, copy, create derivative works of, distribute and sublicense the FreeType Project (in both source and object code forms) and derivative works thereof for any purpose; and to authorize others to exercise some or all of the rights granted herein, subject to the following conditions:

- o Redistribution of source code must retain this license file ('FTL.TXT') unaltered; any additions, deletions or changes to the original files must be clearly indicated in accompanying

documentation. The copyright notices of the unaltered, original files must be preserved in all copies of source files.

- o Redistribution in binary form must provide a disclaimer that states that the software is based in part of the work of the FreeType Team, in the distribution documentation. We also encourage you to put an URL to the FreeType web page in your documentation, though this isn't mandatory.

These conditions apply to any software derived from or based on the FreeType Project, not just the unmodified files. If you use our work, you must acknowledge us. However, no fee need be paid to us.

3. Advertising

Neither the FreeType authors and contributors nor you shall use the name of the other for commercial, advertising, or promotional purposes without specific prior written permission.

We suggest, but do not require, that you use one or more of the following phrases to refer to this software in your documentation or advertising materials: 'FreeType Project', 'FreeType Engine', 'FreeType library', or 'FreeType Distribution'.

As you have not signed this license, you are not required to accept it. However, as the FreeType Project is copyrighted material, only this license, or another one contracted with the authors, grants you the right to use, distribute, and modify it. Therefore, by using, distributing, or modifying the FreeType Project, you indicate that you understand and accept all the terms of this license.

4. Contacts

There are two mailing lists related to FreeType:

- o freetype@nongnu.org

Discusses general use and applications of FreeType, as well as future and wanted additions to the library and distribution.

If you are looking for support, start in this list if you haven't found anything to help you in the documentation.

- o freetype-devel@nongnu.org

Discusses bugs, as well as engine internals, design issues, specific licenses, porting, etc.

Our home page can be found at

<http://www.freetype.org>

--- end of FTL.TXT ---

19. HarfBuzz

Copyright (C) 2006 Behdad Esfahbod

Copyright (C) 1998–2004 David Turner and Werner Lemberg

Copyright (C) 2008 Nokia Corporation and/or its subsidiary(-ies)

Copyright (C) 2004,2007 Red Hat, Inc.

Permission is hereby granted, without written agreement and without license or royalty fees, to use, copy, modify, and distribute this software and its documentation for any purpose, provided that the above copyright notice and the following two paragraphs appear in all copies of this software.

IN NO EVENT SHALL THE COPYRIGHT HOLDER BE LIABLE TO ANY PARTY FOR DIRECT, INDIRECT, SPECIAL, INCIDENTAL, OR CONSEQUENTIAL DAMAGES ARISING OUT OF THE USE OF THIS SOFTWARE AND ITS DOCUMENTATION, EVEN IF THE COPYRIGHT HOLDER HAS BEEN ADVISED OF THE POSSIBILITY OF SUCH DAMAGE.

THE COPYRIGHT HOLDER SPECIFICALLY DISCLAIMS ANY WARRANTIES, INCLUDING, BUT NOT LIMITED TO, THE IMPLIED WARRANTIES OF MERCHANTABILITY AND FITNESS FOR A PARTICULAR PURPOSE. THE SOFTWARE PROVIDED HEREUNDER IS ON AN "AS IS" BASIS, AND THE COPYRIGHT HOLDER HAS NO OBLIGATION TO PROVIDE MAINTENANCE, SUPPORT, UPDATES, ENHANCEMENTS, OR MODIFICATIONS.

20.HttpClient2.0 Alpha1 Release

This product includes software developed by the Apache Software Foundation (<http://www.apache.org/>) and is subject to the following terms and conditions.

Copyright (c) 2001 The Apache Software Foundation. All rights reserved.

Redistribution and use in source and binary forms, with or without modification, are permitted provided that the following conditions are met:

1. Redistributions of source code must retain the above copyright notice, this list of conditions and the following disclaimer.
2. Redistributions in binary form must reproduce the above copyright notice, this list of conditions and the following disclaimer in the documentation and/or other materials provided with the distribution.
3. The end-user documentation included with the redistribution, if any, must include the following acknowledgement:

"This product includes software developed by the Apache Software Foundation (<http://www.apache.org/>)."

Alternately, this acknowledgement may appear in the software itself, if and wherever such third-party acknowledgements normally appear.

4. The names "The Jakarta Project", "Commons", "Xerces", "Crimson", "Velocity", and "Apache Software Foundation" must not be used to endorse or promote products derived from this software without prior written permission. For written permission, please contact apache@apache.org.
5. Products derived from this software may not be called "Jakarta", "Commons", "Xerces", "Crimson", "Velocity", or "Apache", nor may "Jakarta", "Commons", "Xerces", "Crimson", "Velocity", or "Apache" appear in their names without prior written permission of the Apache Group.

NO WARRANTY

THIS SOFTWARE IS PROVIDED "AS IS" AND ANY EXPRESSED OR IMPLIED WARRANTIES, INCLUDING, BUT NOT LIMITED TO, THE IMPLIED WARRANTIES OF MERCHANTABILITY AND FITNESS FOR A PARTICULAR PURPOSE ARE DISCLAIMED. IN NO EVENT SHALL THE APACHE SOFTWARE FOUNDATION OR ITS CONTRIBUTORS BE LIABLE FOR ANY DIRECT, INDIRECT, INCIDENTAL, SPECIAL, EXEMPLARY, OR CONSEQUENTIAL DAMAGES (INCLUDING, BUT NOT LIMITED TO, PROCUREMENT OF SUBSTITUTE GOODS OR SERVICES; LOSS OF USE, DATA, OR PROFITS; OR BUSINESS INTERRUPTION) HOWEVER CAUSED AND ON ANY THEORY OF LIABILITY, WHETHER IN CONTRACT, STRICT LIABILITY, OR TORT (INCLUDING NEGLIGENCE OR OTHERWISE) ARISING IN ANY WAY OUT OF THE USE OF THIS SOFTWARE, EVEN IF ADVISED OF THE POSSIBILITY OF SUCH DAMAGE.

This software consists of voluntary contributions made by many individuals on behalf of the Apache Software Foundation. For more information on the Apache Software Foundation, please see <http://www.apache.org/>.

21.iw

Copyright (c) 2007, 2008 Johannes Berg

Copyright (c) 2007 Andy Lutomirski

Copyright (c) 2007 Mike Kershaw

Copyright (c) 2008–2009 Luis R. Rodriguez

Permission to use, copy, modify, and/or distribute this software for any purpose with or without fee is hereby granted, provided that the above copyright notice and this permission notice appear in all copies.

THE SOFTWARE IS PROVIDED "AS IS" AND THE AUTHOR DISCLAIMS ALL WARRANTIES WITH REGARD TO THIS SOFTWARE INCLUDING ALL IMPLIED WARRANTIES OF MERCHANTABILITY AND FITNESS. IN NO EVENT SHALL THE AUTHOR BE LIABLE FOR ANY SPECIAL, DIRECT, INDIRECT, OR CONSEQUENTIAL DAMAGES OR ANY DAMAGES WHATSOEVER RESULTING FROM LOSS OF USE, DATA OR PROFITS, WHETHER IN AN ACTION OF CONTRACT, NEGLIGENCE OR OTHER TORTIOUS ACTION, ARISING OUT OF OR IN CONNECTION WITH THE USE OR PERFORMANCE OF THIS SOFTWARE.

22.Jackson Annotations

Apache License

Version 2.0, January 2004

<http://www.apache.org/licenses/>

TERMS AND CONDITIONS FOR USE, REPRODUCTION, AND DISTRIBUTION

1. Definitions.

"License" shall mean the terms and conditions for use, reproduction, and distribution as defined by Sections 1 through 9 of this document.

"Licensor" shall mean the copyright owner or entity authorized by the copyright owner that is granting the License.

"Legal Entity" shall mean the union of the acting entity and all other entities that control, are controlled by, or are under common control with that entity. For the purposes of this definition, "control" means (i) the power, direct or indirect, to cause the direction or management of such entity, whether by contract or otherwise, or (ii) ownership of fifty percent (50%) or more of the outstanding shares, or (iii) beneficial ownership of such entity.

"You" (or "Your") shall mean an individual or Legal Entity exercising permissions granted by this License.

"Source" form shall mean the preferred form for making modifications, including but not limited to software source code, documentation source, and configuration files.

"Object" form shall mean any form resulting from mechanical transformation or translation of a Source form, including but not limited to compiled object code, generated documentation, and conversions to other media types.

"Work" shall mean the work of authorship, whether in Source or Object form, made available under the License, as indicated by a copyright notice that is included in or attached to the work (an example is provided in the Appendix below).

"Derivative Works" shall mean any work, whether in Source or Object form, that is based on (or derived from) the Work and for which the editorial revisions, annotations, elaborations, or other modifications represent, as a whole, an original work of authorship. For the purposes of this License, Derivative Works shall not include works that remain separable from, or merely link (or bind by name) to the interfaces of, the Work and Derivative Works thereof.

"Contribution" shall mean any work of authorship, including the original version of the Work and any modifications or additions to that Work or Derivative Works thereof, that is intentionally submitted to Licensor for inclusion in the Work by the copyright owner or by an individual or Legal Entity authorized to submit on behalf of the copyright owner. For the purposes of this definition,

"submitted" means any form of electronic, verbal, or written communication sent to the Licensor or its representatives, including but not limited to communication on electronic mailing lists, source code control systems, and issue tracking systems that are managed by, or on behalf of, the Licensor for the purpose of discussing and improving the Work, but excluding communication that is conspicuously marked or otherwise designated in writing by the copyright owner as "Not a Contribution."

"Contributor" shall mean Licensor and any individual or Legal Entity on behalf of whom a Contribution has been received by Licensor and subsequently incorporated within the Work.

2. Grant of Copyright License. Subject to the terms and conditions of this License, each Contributor hereby grants to You a perpetual, worldwide, non-exclusive, no-charge, royalty-free, irrevocable copyright license to reproduce, prepare Derivative Works of, publicly display, publicly perform, sublicense, and distribute the Work and such Derivative Works in Source or Object form.

3. Grant of Patent License. Subject to the terms and conditions of this License, each Contributor hereby grants to You a perpetual, worldwide, non-exclusive, no-charge, royalty-free, irrevocable (except as stated in this section) patent license to make, have made, use, offer to sell, sell, import, and otherwise transfer the Work, where such license applies only to those patent claims licensable by such Contributor that are necessarily infringed by their Contribution(s) alone or by combination of their Contribution(s) with the Work to which such Contribution(s) was submitted. If You institute patent litigation against any entity (including a cross-claim or counterclaim in a lawsuit) alleging that the Work or a Contribution incorporated within the Work constitutes direct or contributory patent infringement, then any patent licenses granted to You under this License for that Work shall terminate as of the date such litigation is filed.

4. Redistribution. You may reproduce and distribute copies of the Work or Derivative Works thereof in any medium, with or without modifications, and in Source or Object form, provided that You meet the following conditions:

1. You must give any other recipients of the Work or Derivative Works a copy of this License; and

2. You must cause any modified files to carry prominent notices stating that You changed the files; and

3. You must retain, in the Source form of any Derivative Works that You distribute, all copyright, patent, trademark, and attribution notices from the Source form of the Work, excluding those notices that do not pertain to any part of the Derivative Works; and

4. If the Work includes a "NOTICE" text file as part of its distribution, then any Derivative Works that You distribute must include a readable copy of the attribution notices contained within such NOTICE file, excluding those notices that do not pertain to any part of the Derivative Works, in at least one of the following places: within a NOTICE text file distributed as part of the Derivative Works; within the Source form or documentation, if provided along with the Derivative Works; or, within a display generated by the Derivative Works, if and wherever such third-party notices normally appear. The contents of the NOTICE file are for informational purposes only and do not modify the License.

You may add Your own attribution notices within Derivative Works that You distribute, alongside or as an addendum to the NOTICE text from the Work, provided that such additional attribution notices cannot be construed as modifying the License.

You may add Your own copyright statement to Your modifications and may provide additional or different license terms and conditions for use, reproduction, or distribution of Your modifications, or for any such Derivative Works as a whole, provided Your use, reproduction, and distribution of the Work otherwise complies with the conditions stated in this License.

5. Submission of Contributions. Unless You explicitly state otherwise, any Contribution intentionally submitted for inclusion in the Work by You to the Licensor shall be under the terms and conditions of this License, without any additional terms or conditions. Notwithstanding the above, nothing herein shall supersede or modify the terms of any separate license agreement you may have executed with Licensor regarding such Contributions.

6. Trademarks. This License does not grant permission to use the trade names, trademarks, service marks, or product names of the Licensor, except as required for reasonable and customary use in describing the origin of the Work and reproducing the content of the NOTICE file.

7. Disclaimer of Warranty. Unless required by applicable law or agreed to in writing, Licensor provides the Work (and each Contributor provides its Contributions) on an "AS IS" BASIS, WITHOUT WARRANTIES OR CONDITIONS OF ANY KIND, either express or implied, including, without limitation, any warranties or conditions of TITLE, NON-INFRINGEMENT, MERCHANTABILITY, or FITNESS FOR A PARTICULAR PURPOSE. You are solely responsible for determining the appropriateness of using or redistributing the Work and assume any risks associated with Your exercise of permissions under this License.

8. Limitation of Liability. In no event and under no legal theory, whether in tort (including negligence), contract, or otherwise, unless required by applicable law (such as deliberate and grossly negligent acts) or agreed to in writing, shall any Contributor be liable to You for damages, including any direct, indirect, special, incidental, or consequential damages of any character arising as a result of this License or out of the use or inability to use the Work (including but not limited to damages for loss of goodwill, work stoppage, computer failure or malfunction, or any and all other commercial damages or losses), even if such Contributor has been advised of the possibility of such damages.

9. Accepting Warranty or Additional Liability. While redistributing the Work or Derivative Works thereof, You may choose to offer, and charge a fee for, acceptance of support, warranty, indemnity, or other liability obligations and/or rights consistent with this License. However, in accepting such obligations, You may act only on Your own behalf and on Your sole responsibility, not on behalf of any other Contributor, and only if You agree to indemnify, defend, and hold each Contributor harmless for any liability incurred by, or claims asserted against, such Contributor by reason of your accepting any such warranty or additional liability.

END OF TERMS AND CONDITIONS

APPENDIX: How to apply the Apache License to your work¶

To apply the Apache License to your work, attach the following boilerplate notice, with the fields enclosed by brackets "[]" replaced with your own identifying information. (Don't include the brackets!) The text should be enclosed in the appropriate comment syntax for the file format. We also recommend that a file or class name and description of purpose be included on the same "printed page" as the copyright notice for easier identification within third-party archives.

Copyright [yyyy] [name of copyright owner]

Licensed under the Apache License, Version 2.0 (the "License");
you may not use this file except in compliance with the License.
You may obtain a copy of the License at

<http://www.apache.org/licenses/LICENSE-2.0>

Unless required by applicable law or agreed to in writing, software distributed under the License is distributed on an "AS IS" BASIS, WITHOUT WARRANTIES OR CONDITIONS OF ANY KIND, either express or implied. See the License for the specific language governing permissions and limitations under the License.

23. Jackson Core

Apache License

Version 2.0, January 2004

<http://www.apache.org/licenses/>

TERMS AND CONDITIONS FOR USE, REPRODUCTION, AND DISTRIBUTION

1. Definitions.

"License" shall mean the terms and conditions for use, reproduction, and distribution as defined by Sections 1 through 9 of this document.

"Licensor" shall mean the copyright owner or entity authorized by the copyright owner that is granting the License.

"Legal Entity" shall mean the union of the acting entity and all other entities that control, are controlled by, or are under common control with that entity. For the purposes of this definition, "control" means (i) the power, direct or indirect, to cause the direction or management of such entity, whether by contract or otherwise, or (ii) ownership of fifty percent (50%) or more of the outstanding shares, or (iii) beneficial ownership of such entity.

"You" (or "Your") shall mean an individual or Legal Entity exercising permissions granted by this License.

"Source" form shall mean the preferred form for making modifications, including but not limited to software source code, documentation source, and configuration files.

"Object" form shall mean any form resulting from mechanical transformation or translation of a Source form, including but not limited to compiled object code, generated documentation, and conversions to other media types.

"Work" shall mean the work of authorship, whether in Source or Object form, made available under the License, as indicated by a copyright notice that is included in or attached to the work (an example is provided in the Appendix below).

"Derivative Works" shall mean any work, whether in Source or Object form, that is based on (or derived from) the Work and for which the editorial revisions, annotations, elaborations, or other modifications represent, as a whole, an original work of authorship. For the purposes of this License, Derivative Works shall not include works that remain separable from, or merely link (or bind by name) to the interfaces of, the Work and Derivative Works thereof.

"Contribution" shall mean any work of authorship, including the original version of the Work and any modifications or additions to that Work or Derivative Works thereof, that is intentionally submitted to Licensor for inclusion in the Work by the copyright owner or by an individual or Legal Entity authorized to submit on behalf of the copyright owner. For the purposes of this definition,

"submitted" means any form of electronic, verbal, or written communication sent to the Licensor or its representatives, including but not limited to communication on electronic mailing lists, source code control systems, and issue tracking systems that are managed by, or on behalf of, the Licensor for the purpose of discussing and improving the Work, but excluding communication that is conspicuously marked or otherwise designated in writing by the copyright owner as "Not a Contribution."

"Contributor" shall mean Licensor and any individual or Legal Entity on behalf of whom a Contribution has been received by Licensor and subsequently incorporated within the Work.

2. Grant of Copyright License. Subject to the terms and conditions of this License, each Contributor hereby grants to You a perpetual, worldwide, non-exclusive, no-charge, royalty-free, irrevocable copyright license to reproduce, prepare Derivative Works of, publicly display, publicly perform, sublicense, and distribute the Work and such Derivative Works in Source or Object form.

3. Grant of Patent License. Subject to the terms and conditions of this License, each Contributor hereby grants to You a perpetual, worldwide, non-exclusive, no-charge, royalty-free, irrevocable (except as stated in this section) patent license to make, have made, use, offer to sell, sell, import, and otherwise transfer the Work, where such license applies only to those patent claims licensable by such Contributor that are necessarily infringed by their Contribution(s) alone or by combination of their Contribution(s) with the Work to which such Contribution(s) was submitted. If You institute patent litigation against any entity (including a cross-claim or counterclaim in a lawsuit) alleging that the Work or a Contribution incorporated within the Work constitutes direct or contributory patent infringement, then any patent licenses granted to You under this License for that Work shall terminate as of the date such litigation is filed.

4. Redistribution. You may reproduce and distribute copies of the Work or Derivative Works thereof in any medium, with or without modifications, and in Source or Object form, provided that You meet the following conditions:

1. You must give any other recipients of the Work or Derivative Works a copy of this License; and

2. You must cause any modified files to carry prominent notices stating that You changed the files; and

3. You must retain, in the Source form of any Derivative Works that You distribute, all copyright, patent, trademark, and attribution notices from the Source form of the Work, excluding those notices that do not pertain to any part of the Derivative Works; and

4. If the Work includes a "NOTICE" text file as part of its distribution, then any Derivative Works that You distribute must include a readable copy of the attribution notices contained within such NOTICE file, excluding those notices that do not pertain to any part of the Derivative Works, in at least one of the following places: within a NOTICE text file distributed as part of the Derivative Works; within the Source form or documentation, if provided along with the Derivative Works; or, within a display generated by the Derivative Works, if and wherever such third-party notices normally appear. The contents of the NOTICE file are for informational purposes only and do not modify the License.

You may add Your own attribution notices within Derivative Works that You distribute, alongside or as an addendum to the NOTICE text from the Work, provided that such additional attribution notices cannot be construed as modifying the License.

You may add Your own copyright statement to Your modifications and may provide additional or different license terms and conditions for use, reproduction, or distribution of Your modifications, or for any such Derivative Works as a whole, provided Your use, reproduction, and distribution of the Work otherwise complies with the conditions stated in this License.

5. Submission of Contributions. Unless You explicitly state otherwise, any Contribution intentionally submitted for inclusion in the Work by You to the Licensor shall be under the terms and conditions of this License, without any additional terms or conditions. Notwithstanding the above, nothing herein shall supersede or modify the terms of any separate license agreement you may have executed with Licensor regarding such Contributions.

6. Trademarks. This License does not grant permission to use the trade names, trademarks, service marks, or product names of the Licensor, except as required for reasonable and customary use in describing the origin of the Work and reproducing the content of the NOTICE file.

7. Disclaimer of Warranty. Unless required by applicable law or agreed to in writing, Licensor provides the Work (and each Contributor provides its Contributions) on an "AS IS" BASIS, WITHOUT WARRANTIES OR CONDITIONS OF ANY KIND, either express or implied, including, without limitation, any warranties or conditions of TITLE, NON-INFRINGEMENT, MERCHANTABILITY, or FITNESS FOR A PARTICULAR PURPOSE. You are solely responsible for determining the appropriateness of using or redistributing the Work and assume any risks associated with Your exercise of permissions under this License.

8. Limitation of Liability. In no event and under no legal theory, whether in tort (including negligence), contract, or otherwise, unless required by applicable law (such as deliberate and grossly negligent acts) or agreed to in writing, shall any Contributor be liable to You for damages, including any direct, indirect, special, incidental, or consequential damages of any character arising as a result of this License or out of the use or inability to use the Work (including but not limited to damages for loss of goodwill, work stoppage, computer failure or malfunction, or any and all other commercial damages or losses), even if such Contributor has been advised of the possibility of such damages.

9. Accepting Warranty or Additional Liability. While redistributing the Work or Derivative Works thereof, You may choose to offer, and charge a fee for, acceptance of support, warranty, indemnity, or other liability obligations and/or rights consistent with this License. However, in accepting such obligations, You may act only on Your own behalf and on Your sole responsibility, not on behalf of any other Contributor, and only if You agree to indemnify, defend, and hold each Contributor harmless for any liability incurred by, or claims asserted against, such Contributor by reason of your accepting any such warranty or additional liability.

END OF TERMS AND CONDITIONS

APPENDIX: How to apply the Apache License to your work¶

To apply the Apache License to your work, attach the following boilerplate notice, with the fields enclosed by brackets "[]" replaced with your own identifying information. (Don't include the brackets!) The text should be enclosed in the appropriate comment syntax for the file format. We also recommend that a file or class name and description of purpose be included on the same "printed page" as the copyright notice for easier identification within third-party archives.

Copyright [yyyy] [name of copyright owner]

Licensed under the Apache License, Version 2.0 (the "License");
you may not use this file except in compliance with the License.
You may obtain a copy of the License at

<http://www.apache.org/licenses/LICENSE-2.0>

Unless required by applicable law or agreed to in writing, software distributed under the License is distributed on an "AS IS" BASIS, WITHOUT WARRANTIES OR CONDITIONS OF ANY KIND, either express or implied. See the License for the specific language governing permissions and limitations under the License.

Jackson JSON processor

Jackson is a high-performance, Free/Open Source JSON processing library. It was originally written by Tatu Saloranta (tatu.saloranta@iki.fi), and has been in development since 2007. It is currently developed by a community of developers.

Licensing

Jackson 2.x core and extension components are licensed under Apache License 2.0 To find the details that apply to this artifact see the accompanying LICENSE file.

Credits

A list of contributors may be found from CREDITS(-2.x) file, which is included in some artifacts (usually source distributions); but is always available from the source code management (SCM) system project uses.

24.Jackson Databind

Apache License

Version 2.0, January 2004

<http://www.apache.org/licenses/>

TERMS AND CONDITIONS FOR USE, REPRODUCTION, AND DISTRIBUTION

1. Definitions.

"License" shall mean the terms and conditions for use, reproduction, and distribution as defined by Sections 1 through 9 of this document.

"Licensor" shall mean the copyright owner or entity authorized by the copyright owner that is granting the License.

"Legal Entity" shall mean the union of the acting entity and all other entities that control, are controlled by, or are under common control with that entity. For the purposes of this definition, "control" means (i) the power, direct or indirect, to cause the direction or management of such entity, whether by contract or otherwise, or (ii) ownership of fifty percent (50%) or more of the outstanding shares, or (iii) beneficial ownership of such entity.

"You" (or "Your") shall mean an individual or Legal Entity exercising permissions granted by this License.

"Source" form shall mean the preferred form for making modifications, including but not limited to software source code, documentation source, and configuration files.

"Object" form shall mean any form resulting from mechanical transformation or translation of a Source form, including but not limited to compiled object code, generated documentation, and conversions to other media types.

"Work" shall mean the work of authorship, whether in Source or Object form, made available under the License, as indicated by a copyright notice that is included in or attached to the work (an example is provided in the Appendix below).

"Derivative Works" shall mean any work, whether in Source or Object form, that is based on (or derived from) the Work and for which the editorial revisions, annotations, elaborations, or other modifications represent, as a whole, an original work of authorship. For the purposes of this License, Derivative Works shall not include works that remain separable from, or merely link (or bind by name) to the interfaces of, the Work and Derivative Works thereof.

"Contribution" shall mean any work of authorship, including the original version of the Work and any modifications or additions to that Work or Derivative Works thereof, that is intentionally submitted to Licensor for inclusion in the Work by the copyright owner or by an individual or Legal Entity authorized to submit on behalf of the copyright owner. For the purposes of this definition,

"submitted" means any form of electronic, verbal, or written communication sent to the Licensor or its representatives, including but not limited to communication on electronic mailing lists, source code control systems, and issue tracking systems that are managed by, or on behalf of, the Licensor for the purpose of discussing and improving the Work, but excluding communication that is conspicuously marked or otherwise designated in writing by the copyright owner as "Not a Contribution."

"Contributor" shall mean Licensor and any individual or Legal Entity on behalf of whom a Contribution has been received by Licensor and subsequently incorporated within the Work.

2. Grant of Copyright License. Subject to the terms and conditions of this License, each Contributor hereby grants to You a perpetual, worldwide, non-exclusive, no-charge, royalty-free, irrevocable copyright license to reproduce, prepare Derivative Works of, publicly display, publicly perform, sublicense, and distribute the Work and such Derivative Works in Source or Object form.

3. Grant of Patent License. Subject to the terms and conditions of this License, each Contributor hereby grants to You a perpetual, worldwide, non-exclusive, no-charge, royalty-free, irrevocable (except as stated in this section) patent license to make, have made, use, offer to sell, sell, import, and otherwise transfer the Work, where such license applies only to those patent claims licensable by such Contributor that are necessarily infringed by their Contribution(s) alone or by combination of their Contribution(s) with the Work to which such Contribution(s) was submitted. If You institute patent litigation against any entity (including a cross-claim or counterclaim in a lawsuit) alleging that the Work or a Contribution incorporated within the Work constitutes direct or contributory patent infringement, then any patent licenses granted to You under this License for that Work shall terminate as of the date such litigation is filed.

4. Redistribution. You may reproduce and distribute copies of the Work or Derivative Works thereof in any medium, with or without modifications, and in Source or Object form, provided that You meet the following conditions:

1. You must give any other recipients of the Work or Derivative Works a copy of this License; and

2. You must cause any modified files to carry prominent notices stating that You changed the files; and

3. You must retain, in the Source form of any Derivative Works that You distribute, all copyright, patent, trademark, and attribution notices from the Source form of the Work, excluding those notices that do not pertain to any part of the Derivative Works; and

4. If the Work includes a "NOTICE" text file as part of its distribution, then any Derivative Works that You distribute must include a readable copy of the attribution notices contained within such NOTICE file, excluding those notices that do not pertain to any part of the Derivative Works, in at least one of the following places: within a NOTICE text file distributed as part of the Derivative Works; within the Source form or documentation, if provided along with the Derivative Works; or, within a display generated by the Derivative Works, if and wherever such third-party notices normally appear. The contents of the NOTICE file are for informational purposes only and do not modify the License.

You may add Your own attribution notices within Derivative Works that You distribute, alongside or as an addendum to the NOTICE text from the Work, provided that such additional attribution notices cannot be construed as modifying the License.

You may add Your own copyright statement to Your modifications and may provide additional or different license terms and conditions for use, reproduction, or distribution of Your modifications, or for any such Derivative Works as a whole, provided Your use, reproduction, and distribution of the Work otherwise complies with the conditions stated in this License.

5. Submission of Contributions. Unless You explicitly state otherwise, any Contribution intentionally submitted for inclusion in the Work by You to the Licensor shall be under the terms and conditions of this License, without any additional terms or conditions. Notwithstanding the above, nothing herein shall supersede or modify the terms of any separate license agreement you may have executed with Licensor regarding such Contributions.

6. Trademarks. This License does not grant permission to use the trade names, trademarks, service marks, or product names of the Licensor, except as required for reasonable and customary use in describing the origin of the Work and reproducing the content of the NOTICE file.

7. Disclaimer of Warranty. Unless required by applicable law or agreed to in writing, Licensor provides the Work (and each Contributor provides its Contributions) on an "AS IS" BASIS, WITHOUT WARRANTIES OR CONDITIONS OF ANY KIND, either express or implied, including, without limitation, any warranties or conditions of TITLE, NON-INFRINGEMENT, MERCHANTABILITY, or FITNESS FOR A PARTICULAR PURPOSE. You are solely responsible for determining the appropriateness of using or redistributing the Work and assume any risks associated with Your exercise of permissions under this License.

8. Limitation of Liability. In no event and under no legal theory, whether in tort (including negligence), contract, or otherwise, unless required by applicable law (such as deliberate and grossly negligent acts) or agreed to in writing, shall any Contributor be liable to You for damages, including any direct, indirect, special, incidental, or consequential damages of any character arising as a result of this License or out of the use or inability to use the Work (including but not limited to damages for loss of goodwill, work stoppage, computer failure or malfunction, or any and all other commercial damages or losses), even if such Contributor has been advised of the possibility of such damages.

9. Accepting Warranty or Additional Liability. While redistributing the Work or Derivative Works thereof, You may choose to offer, and charge a fee for, acceptance of support, warranty, indemnity, or other liability obligations and/or rights consistent with this License. However, in accepting such obligations, You may act only on Your own behalf and on Your sole responsibility, not on behalf of any other Contributor, and only if You agree to indemnify, defend, and hold each Contributor harmless for any liability incurred by, or claims asserted against, such Contributor by reason of your accepting any such warranty or additional liability.

END OF TERMS AND CONDITIONS

APPENDIX: How to apply the Apache License to your work¶

To apply the Apache License to your work, attach the following boilerplate notice, with the fields enclosed by brackets "[]" replaced with your own identifying information. (Don't include the brackets!) The text should be enclosed in the appropriate comment syntax for the file format. We also recommend that a file or class name and description of purpose be included on the same "printed page" as the copyright notice for easier identification within third-party archives.

Copyright [yyyy] [name of copyright owner]

Licensed under the Apache License, Version 2.0 (the "License");
you may not use this file except in compliance with the License.
You may obtain a copy of the License at

<http://www.apache.org/licenses/LICENSE-2.0>

Unless required by applicable law or agreed to in writing, software distributed under the License is distributed on an "AS IS" BASIS, WITHOUT WARRANTIES OR CONDITIONS OF ANY KIND, either express or implied. See the License for the specific language governing permissions and limitations under the License.

Jackson JSON processor

Jackson is a high-performance, Free/Open Source JSON processing library. It was originally written by Tatu Saloranta (tatu.saloranta@iki.fi), and has been in development since 2007. It is currently developed by a community of developers.

Licensing

Jackson 2.x core and extension components are licensed under Apache License 2.0 To find the details that apply to this artifact see the accompanying LICENSE file.

Credits

A list of contributors may be found from CREDITS(-2.x) file, which is included in some artifacts (usually source distributions); but is always available from the source code management (SCM) system project uses.

25.Jackson Dataformat cbor

Apache License

Version 2.0, January 2004

<http://www.apache.org/licenses/>

TERMS AND CONDITIONS FOR USE, REPRODUCTION, AND DISTRIBUTION

1. Definitions.

"License" shall mean the terms and conditions for use, reproduction, and distribution as defined by Sections 1 through 9 of this document.

"Licensor" shall mean the copyright owner or entity authorized by the copyright owner that is granting the License.

"Legal Entity" shall mean the union of the acting entity and all other entities that control, are controlled by, or are under common control with that entity. For the purposes of this definition, "control" means (i) the power, direct or indirect, to cause the direction or management of such entity, whether by contract or otherwise, or (ii) ownership of fifty percent (50%) or more of the outstanding shares, or (iii) beneficial ownership of such entity.

"You" (or "Your") shall mean an individual or Legal Entity exercising permissions granted by this License.

"Source" form shall mean the preferred form for making modifications, including but not limited to software source code, documentation source, and configuration files.

"Object" form shall mean any form resulting from mechanical transformation or translation of a Source form, including but not limited to compiled object code, generated documentation, and conversions to other media types.

"Work" shall mean the work of authorship, whether in Source or Object form, made available under the License, as indicated by a copyright notice that is included in or attached to the work (an example is provided in the Appendix below).

"Derivative Works" shall mean any work, whether in Source or Object form, that is based on (or derived from) the Work and for which the editorial revisions, annotations, elaborations, or other modifications represent, as a whole, an original work of authorship. For the purposes of this License, Derivative Works shall not include works that remain separable from, or merely link (or bind by name) to the interfaces of, the Work and Derivative Works thereof.

"Contribution" shall mean any work of authorship, including the original version of the Work and any modifications or additions to that Work or Derivative Works thereof, that is intentionally submitted to Licensor for inclusion in the Work by the copyright owner or by an individual or Legal Entity authorized to submit on behalf of the copyright owner. For the purposes of this definition,

"submitted" means any form of electronic, verbal, or written communication sent to the Licensor or its representatives, including but not limited to communication on electronic mailing lists, source code control systems, and issue tracking systems that are managed by, or on behalf of, the Licensor for the purpose of discussing and improving the Work, but excluding communication that is conspicuously marked or otherwise designated in writing by the copyright owner as "Not a Contribution."

"Contributor" shall mean Licensor and any individual or Legal Entity on behalf of whom a Contribution has been received by Licensor and subsequently incorporated within the Work.

2. Grant of Copyright License. Subject to the terms and conditions of this License, each Contributor hereby grants to You a perpetual, worldwide, non-exclusive, no-charge, royalty-free, irrevocable copyright license to reproduce, prepare Derivative Works of, publicly display, publicly perform, sublicense, and distribute the Work and such Derivative Works in Source or Object form.

3. Grant of Patent License. Subject to the terms and conditions of this License, each Contributor hereby grants to You a perpetual, worldwide, non-exclusive, no-charge, royalty-free, irrevocable (except as stated in this section) patent license to make, have made, use, offer to sell, sell, import, and otherwise transfer the Work, where such license applies only to those patent claims licensable by such Contributor that are necessarily infringed by their Contribution(s) alone or by combination of their Contribution(s) with the Work to which such Contribution(s) was submitted. If You institute patent litigation against any entity (including a cross-claim or counterclaim in a lawsuit) alleging that the Work or a Contribution incorporated within the Work constitutes direct or contributory patent infringement, then any patent licenses granted to You under this License for that Work shall terminate as of the date such litigation is filed.

4. Redistribution. You may reproduce and distribute copies of the Work or Derivative Works thereof in any medium, with or without modifications, and in Source or Object form, provided that You meet the following conditions:

1. You must give any other recipients of the Work or Derivative Works a copy of this License; and

2. You must cause any modified files to carry prominent notices stating that You changed the files; and

3. You must retain, in the Source form of any Derivative Works that You distribute, all copyright, patent, trademark, and attribution notices from the Source form of the Work, excluding those notices that do not pertain to any part of the Derivative Works; and

4. If the Work includes a "NOTICE" text file as part of its distribution, then any Derivative Works that You distribute must include a readable copy of the attribution notices contained within such NOTICE file, excluding those notices that do not pertain to any part of the Derivative Works, in at least one of the following places: within a NOTICE text file distributed as part of the Derivative Works; within the Source form or documentation, if provided along with the Derivative Works; or, within a display generated by the Derivative Works, if and wherever such third-party notices normally appear. The contents of the NOTICE file are for informational purposes only and do not modify the License.

You may add Your own attribution notices within Derivative Works that You distribute, alongside or as an addendum to the NOTICE text from the Work, provided that such additional attribution notices cannot be construed as modifying the License.

You may add Your own copyright statement to Your modifications and may provide additional or different license terms and conditions for use, reproduction, or distribution of Your modifications, or for any such Derivative Works as a whole, provided Your use, reproduction, and distribution of the Work otherwise complies with the conditions stated in this License.

5. Submission of Contributions. Unless You explicitly state otherwise, any Contribution intentionally submitted for inclusion in the Work by You to the Licensor shall be under the terms and conditions of this License, without any additional terms or conditions. Notwithstanding the above, nothing herein shall supersede or modify the terms of any separate license agreement you may have executed with Licensor regarding such Contributions.

6. Trademarks. This License does not grant permission to use the trade names, trademarks, service marks, or product names of the Licensor, except as required for reasonable and customary use in describing the origin of the Work and reproducing the content of the NOTICE file.

7. Disclaimer of Warranty. Unless required by applicable law or agreed to in writing, Licensor provides the Work (and each Contributor provides its Contributions) on an "AS IS" BASIS, WITHOUT WARRANTIES OR CONDITIONS OF ANY KIND, either express or implied, including, without limitation, any warranties or conditions of TITLE, NON-INFRINGEMENT, MERCHANTABILITY, or FITNESS FOR A PARTICULAR PURPOSE. You are solely responsible for determining the appropriateness of using or redistributing the Work and assume any risks associated with Your exercise of permissions under this License.

8. Limitation of Liability. In no event and under no legal theory, whether in tort (including negligence), contract, or otherwise, unless required by applicable law (such as deliberate and grossly negligent acts) or agreed to in writing, shall any Contributor be liable to You for damages, including any direct, indirect, special, incidental, or consequential damages of any character arising as a result of this License or out of the use or inability to use the Work (including but not limited to damages for loss of goodwill, work stoppage, computer failure or malfunction, or any and all other commercial damages or losses), even if such Contributor has been advised of the possibility of such damages.

9. Accepting Warranty or Additional Liability. While redistributing the Work or Derivative Works thereof, You may choose to offer, and charge a fee for, acceptance of support, warranty, indemnity, or other liability obligations and/or rights consistent with this License. However, in accepting such obligations, You may act only on Your own behalf and on Your sole responsibility, not on behalf of any other Contributor, and only if You agree to indemnify, defend, and hold each Contributor harmless for any liability incurred by, or claims asserted against, such Contributor by reason of your accepting any such warranty or additional liability.

END OF TERMS AND CONDITIONS

APPENDIX: How to apply the Apache License to your work¶

To apply the Apache License to your work, attach the following boilerplate notice, with the fields enclosed by brackets "[]" replaced with your own identifying information. (Don't include the brackets!) The text should be enclosed in the appropriate comment syntax for the file format. We also recommend that a file or class name and description of purpose be included on the same "printed page" as the copyright notice for easier identification within third-party archives.

Copyright [yyyy] [name of copyright owner]

Licensed under the Apache License, Version 2.0 (the "License");
you may not use this file except in compliance with the License.
You may obtain a copy of the License at

<http://www.apache.org/licenses/LICENSE-2.0>

Unless required by applicable law or agreed to in writing, software distributed under the License is distributed on an "AS IS" BASIS, WITHOUT WARRANTIES OR CONDITIONS OF ANY KIND, either express or implied. See the License for the specific language governing permissions and limitations under the License.

26.Jackson JSON Processor

Apache License

Version 2.0, January 2004

TERMS AND CONDITIONS FOR USE, REPRODUCTION, AND DISTRIBUTION

1. Definitions.

"License" shall mean the terms and conditions for use, reproduction, and distribution as defined by Sections 1 through 9 of this document.

"Licensor" shall mean the copyright owner or entity authorized by the copyright owner that is granting the License.

"Legal Entity" shall mean the union of the acting entity and all other entities that control, are controlled by, or are under common control with that entity. For the purposes of this definition, "control" means (i) the power, direct or indirect, to cause the direction or management of such entity, whether by contract or otherwise, or (ii) ownership of fifty percent (50%) or more of the outstanding shares, or (iii) beneficial ownership of such entity.

"You" (or "Your") shall mean an individual or Legal Entity exercising permissions granted by this License.

"Source" form shall mean the preferred form for making modifications, including but not limited to software source code, documentation source, and configuration files.

"Object" form shall mean any form resulting from mechanical transformation or translation of a Source form, including but not limited to compiled object code, generated documentation, and conversions to other media types.

"Work" shall mean the work of authorship, whether in Source or Object form, made available under the License, as indicated by a copyright notice that is included in or attached to the work (an example is provided in the Appendix below).

"Derivative Works" shall mean any work, whether in Source or Object form, that is based on (or derived from) the Work and for which the editorial revisions, annotations, elaborations, or other

modifications represent, as a whole, an original work of authorship. For the purposes of this License, Derivative Works shall not include works that remain separable from, or merely link (or bind by name) to the interfaces of, the Work and Derivative Works thereof.

"Contribution" shall mean any work of authorship, including the original version of the Work and any modifications or additions to that Work or Derivative Works thereof, that is intentionally submitted to Licensor for inclusion in the Work by the copyright owner or by an individual or Legal Entity authorized to submit on behalf of the copyright owner. For the purposes of this definition, "submitted" means any form of electronic, verbal, or written communication sent to the Licensor or its representatives, including but not limited to communication on electronic mailing lists, source code control systems, and issue tracking systems that are managed by, or on behalf of, the Licensor for the purpose of discussing and improving the Work, but excluding communication that is conspicuously marked or otherwise designated in writing by the copyright owner as "Not a Contribution."

"Contributor" shall mean Licensor and any individual or Legal Entity on behalf of whom a Contribution has been received by Licensor and subsequently incorporated within the Work.

2. Grant of Copyright License. Subject to the terms and conditions of this License, each Contributor hereby grants to You a perpetual, worldwide, non-exclusive, no-charge, royalty-free, irrevocable copyright license to reproduce, prepare Derivative Works of, publicly display, publicly perform, sublicense, and distribute the Work and such Derivative Works in Source or Object form.

3. Grant of Patent License. Subject to the terms and conditions of this License, each Contributor hereby grants to You a perpetual, worldwide, non-exclusive, no-charge, royalty-free, irrevocable (except as stated in this section) patent license to make, have made, use, offer to sell, sell, import, and otherwise transfer the Work, where such license applies only to those patent claims licensable by such Contributor that are necessarily infringed by their Contribution(s) alone or by combination of their Contribution(s) with the Work to which such Contribution(s) was submitted. If You institute patent litigation against any entity (including a cross-claim or counterclaim in a lawsuit) alleging that the Work or a Contribution incorporated within the Work constitutes direct or contributory patent infringement, then any patent licenses granted to You under this License for that Work shall terminate as of the date such litigation is filed.

4. Redistribution. You may reproduce and distribute copies of the Work or Derivative Works thereof in any medium, with or without modifications, and in Source or Object form, provided that You meet the following conditions:

1. You must give any other recipients of the Work or Derivative Works a copy of this License; and

2. You must cause any modified files to carry prominent notices stating that You changed the files; and
3. You must retain, in the Source form of any Derivative Works that You distribute, all copyright, patent, trademark, and attribution notices from the Source form of the Work, excluding those notices that do not pertain to any part of the Derivative Works; and
4. If the Work includes a "NOTICE" text file as part of its distribution, then any Derivative Works that You distribute must include a readable copy of the attribution notices contained within such NOTICE file, excluding those notices that do not pertain to any part of the Derivative Works, in at least one of the following places: within a NOTICE text file distributed as part of the Derivative Works; within the Source form or documentation, if provided along with the Derivative Works; or, within a display generated by the Derivative Works, if and wherever such third-party notices normally appear. The contents of the NOTICE file are for informational purposes only and do not modify the License. You may add Your own attribution notices within Derivative Works that You distribute, alongside or as an addendum to the NOTICE text from the Work, provided that such additional attribution notices cannot be construed as modifying the License.

You may add Your own copyright statement to Your modifications and may provide additional or different license terms and conditions for use, reproduction, or distribution of Your modifications, or for any such Derivative Works as a whole, provided Your use, reproduction, and distribution of the Work otherwise complies with the conditions stated in this License.

5. Submission of Contributions. Unless You explicitly state otherwise, any Contribution intentionally submitted for inclusion in the Work by You to the Licensor shall be under the terms and conditions of this License, without any additional terms or conditions. Notwithstanding the above, nothing herein shall supersede or modify the terms of any separate license agreement you may have executed with Licensor regarding such Contributions.

6. Trademarks. This License does not grant permission to use the trade names, trademarks, service marks, or product names of the Licensor, except as required for reasonable and customary use in describing the origin of the Work and reproducing the content of the NOTICE file.

7. Disclaimer of Warranty. Unless required by applicable law or agreed to in writing, Licensor provides the Work (and each Contributor provides its Contributions) on an "AS IS" BASIS, WITHOUT WARRANTIES OR CONDITIONS OF ANY KIND, either express or implied, including, without limitation, any warranties or conditions of TITLE, NON-INFRINGEMENT, MERCHANTABILITY, or FITNESS FOR A PARTICULAR PURPOSE. You are solely responsible for determining the appropriateness of using or redistributing the Work and assume any risks associated with Your exercise of permissions under this License.

8. Limitation of Liability. In no event and under no legal theory, whether in tort (including negligence), contract, or otherwise, unless required by applicable law (such as deliberate and grossly negligent acts) or agreed to in writing, shall any Contributor be liable to You for damages, including any direct, indirect, special, incidental, or consequential damages of any character arising as a result of this License or out of the use or inability to use the Work (including but not limited to damages for loss of goodwill, work stoppage, computer failure or malfunction, or any and all other commercial damages or losses), even if such Contributor has been advised of the possibility of such damages.

9. Accepting Warranty or Additional Liability. While redistributing the Work or Derivative Works thereof, You may choose to offer, and charge a fee for, acceptance of support, warranty, indemnity, or other liability obligations and/or rights consistent with this License. However, in accepting such obligations, You may act only on Your own behalf and on Your sole responsibility, not on behalf of any other Contributor, and only if You agree to indemnify, defend, and hold each Contributor harmless for any liability incurred by, or claims asserted against, such Contributor by reason of your accepting any such warranty or additional liability.

END OF TERMS AND CONDITIONS

Note: Other license terms may apply to certain, identified software files contained within or distributed with the accompanying software if such terms are included in the directory containing the accompanying software. Such other license terms will then apply in lieu of the terms of the software license above.

JSON processing code subject to the JSON License from JSON.org:

Permission is hereby granted, free of charge, to any person obtaining a copy of this software and associated documentation files (the "Software"), to deal in the Software without restriction, including without limitation the rights to use, copy, modify, merge, publish, distribute, sublicense, and/or sell copies of the Software, and to permit persons to whom the Software is furnished to do so, subject to the following conditions:

The above copyright notice and this permission notice shall be included in all copies or substantial portions of the Software.

The Software shall be used for Good, not Evil.

THE SOFTWARE IS PROVIDED "AS IS", WITHOUT WARRANTY OF ANY KIND, EXPRESS OR IMPLIED,

INCLUDING BUT NOT LIMITED TO THE WARRANTIES OF MERCHANTABILITY, FITNESS FOR A PARTICULAR PURPOSE AND NONINFRINGEMENT. IN NO EVENT SHALL THE AUTHORS OR COPYRIGHT HOLDERS BE LIABLE FOR ANY CLAIM, DAMAGES OR OTHER LIABILITY, WHETHER IN AN ACTION OF CONTRACT, TORT OR OTHERWISE, ARISING FROM, OUT OF OR IN CONNECTION WITH THE SOFTWARE OR THE USE OR OTHER DEALINGS IN THE SOFTWARE.

27. JAVA SE

a. Java Technology Restrictions. You may not create, modify, or change the behavior of classes, interfaces, of subpackages that are in any way identified as “Java”, “Javax”, “Sun” or similar convention as specified by Oracle in any naming convention designation.

b. Trademarks and Logos. You shall acknowledge that Oracle owns the Java trademark and all Java-related trademarks, logos and icons including the Coffee Cup and Duke (“Java Marks”) and agree to: (a) comply with the Java Trademark Guidelines at <http://www.oracle.com/us/legal/trademarks/index.html>; (b) not do anything harmful to or inconsistent with Oracle’s rights in the Java Marks; and (c) assist Oracle in protecting those rights, including assigning to Oracle any right acquired by You in any Java Mark.

c. Source Code. JAVA SE may contain source code that, unless expressly licensed for other purposes, is provided solely for reference purpose pursuant to the terms applicable to JAVA SE.

d. Third Party Code. The additional copyright notices and license terms applicable to portions of the JAVA SE are forth in the THIRDPARTYLICENSEREADME.txt file.

e. Commercial Features. Your use of the Commercial Features for any commercial or production purpose requires a separate license from Oracle. “Commercial Features” means those features identified in Table 1–1 (Commercial Features In Java SE Product Editions) of the Program Documentation accessible at <http://www.oracle.com/technetwork/java/javase/documentation/index.html>.

28.jQuery

Copyright 2014 jQuery Foundation and other contributors

<http://jquery.com/>

Permission is hereby granted, free of charge, to any person obtaining a copy of this software and associated documentation files (the "Software"), to deal in the Software without restriction, including without limitation the rights to use, copy, modify, merge, publish, distribute, sublicense, and/or sell copies of the Software, and to permit persons to whom the Software is furnished to do so, subject to the following conditions:

The above copyright notice and this permission notice shall be included in all copies or substantial portions of the Software.

THE SOFTWARE IS PROVIDED "AS IS", WITHOUT WARRANTY OF ANY KIND, EXPRESS OR IMPLIED, INCLUDING BUT NOT LIMITED TO THE WARRANTIES OF MERCHANTABILITY, FITNESS FOR A PARTICULAR PURPOSE AND NONINFRINGEMENT. IN NO EVENT SHALL THE AUTHORS OR COPYRIGHT HOLDERS BE LIABLE FOR ANY CLAIM, DAMAGES OR OTHER LIABILITY, WHETHER IN AN ACTION OF CONTRACT, TORT OR OTHERWISE, ARISING FROM, OUT OF OR IN CONNECTION WITH THE SOFTWARE OR THE USE OR OTHER DEALINGS IN THE SOFTWARE.

Copyright (C) 2005, 2014 jQuery Foundation, Inc.

<https://jquery.org/license/>

Permission is hereby granted, free of charge, to any person obtaining a copy of this software and associated documentation files (the "Software"), to deal in the Software without restriction, including without limitation the rights to use, copy, modify, merge, publish, distribute, sublicense, and/or sell copies of the Software, and to permit persons to whom the Software is furnished to do so, subject to the following conditions:

The above copyright notice and this permission notice shall be included in all copies or substantial portions of the Software.

THE SOFTWARE IS PROVIDED "AS IS", WITHOUT WARRANTY OF ANY KIND, EXPRESS OR IMPLIED, INCLUDING BUT NOT LIMITED TO THE WARRANTIES OF MERCHANTABILITY, FITNESS FOR A PARTICULAR PURPOSE AND NONINFRINGEMENT. IN NO EVENT SHALL THE AUTHORS OR COPYRIGHT HOLDERS BE LIABLE FOR ANY CLAIM, DAMAGES OR OTHER LIABILITY, WHETHER IN AN ACTION OF CONTRACT, TORT OR OTHERWISE, ARISING FROM, OUT OF OR IN CONNECTION WITH THE SOFTWARE OR THE USE OR OTHER DEALINGS IN THE SOFTWARE.

29.jquery.ex-table-filter

Copyright (c) 2014 cyokodog

Permission is hereby granted, free of charge, to any person obtaining a copy of this software and associated documentation files (the "Software"), to deal in the Software without restriction, including without limitation the rights to use, copy, modify, merge, publish, distribute, sublicense, and/or sell copies of the Software, and to permit persons to whom the Software is furnished to do so, subject to the following conditions:

The above copyright notice and this permission notice shall be included in all copies or substantial portions of the Software.

THE SOFTWARE IS PROVIDED "AS IS", WITHOUT WARRANTY OF ANY KIND, EXPRESS OR IMPLIED, INCLUDING BUT NOT LIMITED TO THE WARRANTIES OF MERCHANTABILITY, FITNESS FOR A PARTICULAR PURPOSE AND NONINFRINGEMENT. IN NO EVENT SHALL THE AUTHORS OR COPYRIGHT HOLDERS BE LIABLE FOR ANY CLAIM, DAMAGES OR OTHER LIABILITY, WHETHER IN AN ACTION OF CONTRACT, TORT OR OTHERWISE, ARISING FROM, OUT OF OR IN CONNECTION WITH THE SOFTWARE OR THE USE OR OTHER DEALINGS IN THE SOFTWARE.

30.jquery-json

Copyright (c) 2009–2011 Brantley Harris

Permission is hereby granted, free of charge, to any person obtaining a copy of this software and associated documentation files (the "Software"), to deal in the Software without restriction, including without limitation the rights to use, copy, modify, merge, publish, distribute, sublicense, and/or sell copies of the Software, and to permit persons to whom the Software is furnished to do so, subject to the following conditions:

The above copyright notice and this permission notice shall be included in all copies or substantial portions of the Software.

THE SOFTWARE IS PROVIDED "AS IS", WITHOUT WARRANTY OF ANY KIND, EXPRESS OR IMPLIED, INCLUDING BUT NOT LIMITED TO THE WARRANTIES OF MERCHANTABILITY, FITNESS FOR A PARTICULAR PURPOSE AND NONINFRINGEMENT. IN NO EVENT SHALL THE AUTHORS OR COPYRIGHT HOLDERS BE LIABLE FOR ANY CLAIM, DAMAGES OR OTHER LIABILITY, WHETHER IN AN ACTION OF CONTRACT, TORT OR OTHERWISE, ARISING FROM, OUT OF OR IN CONNECTION WITH THE SOFTWARE OR THE USE OR OTHER DEALINGS IN THE SOFTWARE.

31. jQueryUI

Copyright (c) 2014 jQuery Foundation and other contributors

<http://jqueryui.com/>

Permission is hereby granted, free of charge, to any person obtaining a copy of this software and associated documentation files (the "Software"), to deal in the Software without restriction, including without limitation the rights to use, copy, modify, merge, publish, distribute, sublicense, and/or sell copies of the Software, and to permit persons to whom the Software is furnished to do so, subject to the following conditions:

The above copyright notice and this permission notice shall be included in all copies or substantial portions of the Software.

THE SOFTWARE IS PROVIDED "AS IS", WITHOUT WARRANTY OF ANY KIND, EXPRESS OR IMPLIED, INCLUDING BUT NOT LIMITED TO THE WARRANTIES OF MERCHANTABILITY, FITNESS FOR A PARTICULAR PURPOSE AND NONINFRINGEMENT. IN NO EVENT SHALL THE AUTHORS OR COPYRIGHT HOLDERS BE LIABLE FOR ANY CLAIM, DAMAGES OR OTHER LIABILITY, WHETHER IN AN ACTION OF CONTRACT, TORT OR OTHERWISE, ARISING FROM, OUT OF OR IN CONNECTION WITH THE SOFTWARE OR THE USE OR OTHER DEALINGS IN THE SOFTWARE.

32. JSEncrypt

Copyright (c) 2008–2013 Lapo Luchini <lapo@lapo.it>

Permission to use, copy, modify, and/or distribute this software for any purpose with or without fee is hereby granted, provided that the above copyright notice and this permission notice appear in all copies.

THE SOFTWARE IS PROVIDED "AS IS" AND THE AUTHOR DISCLAIMS ALL WARRANTIES WITH REGARD TO THIS SOFTWARE INCLUDING ALL IMPLIED WARRANTIES OF MERCHANTABILITY AND FITNESS. IN NO EVENT SHALL THE AUTHOR BE LIABLE FOR ANY SPECIAL, DIRECT, INDIRECT, OR CONSEQUENTIAL DAMAGES OR ANY DAMAGES WHATSOEVER RESULTING FROM LOSS OF USE, DATA OR PROFITS, WHETHER IN AN ACTION OF CONTRACT, NEGLIGENCE OR OTHER TORTIOUS ACTION, ARISING OUT OF OR IN CONNECTION WITH THE USE OR PERFORMANCE OF THIS SOFTWARE.

* Copyright (c) 2003–2005 Tom Wu

* All Rights Reserved.

*

* Permission is hereby granted, free of charge, to any person obtaining

* a copy of this software and associated documentation files (the

* "Software"), to deal in the Software without restriction, including

* without limitation the rights to use, copy, modify, merge, publish,

* distribute, sublicense, and/or sell copies of the Software, and to

* permit persons to whom the Software is furnished to do so, subject to

* the following conditions:

*

* The above copyright notice and this permission notice shall be

* included in all copies or substantial portions of the Software.

*

* THE SOFTWARE IS PROVIDED "AS-IS" AND WITHOUT WARRANTY OF ANY KIND,

* EXPRESS, IMPLIED OR OTHERWISE, INCLUDING WITHOUT LIMITATION, ANY

* WARRANTY OF MERCHANTABILITY OR FITNESS FOR A PARTICULAR PURPOSE.

*

* IN NO EVENT SHALL TOM WU BE LIABLE FOR ANY SPECIAL, INCIDENTAL,

* INDIRECT OR CONSEQUENTIAL DAMAGES OF ANY KIND, OR ANY DAMAGES WHATSOEVER

* RESULTING FROM LOSS OF USE, DATA OR PROFITS, WHETHER OR NOT ADVISED OF
* THE POSSIBILITY OF DAMAGE, AND ON ANY THEORY OF LIABILITY, ARISING OUT
* OF OR IN CONNECTION WITH THE USE OR PERFORMANCE OF THIS SOFTWARE.

*

* In addition, the following condition applies:

*

* All redistributions must retain an intact copy of this copyright notice
* and disclaimer.

CONTAINS CODE FROM YUI LIBRARY SEE LICENSE @ <http://yuilibrary.com/license/>

The 'jsrsasign'(RSA-Sign JavaScript Library) License

Copyright (c) 2010–2013 Kenji Urushima

Permission is hereby granted, free of charge, to any person obtaining a copy of this software and associated documentation files (the "Software"), to deal in the Software without restriction, including without limitation the rights to use, copy, modify, merge, publish, distribute, sublicense, and/or sell copies of the Software, and to permit persons to whom the Software is furnished to do so, subject to the following conditions:

The above copyright notice and this permission notice shall be included in all copies or substantial portions of the Software.

THE SOFTWARE IS PROVIDED "AS IS", WITHOUT WARRANTY OF ANY KIND, EXPRESS OR IMPLIED, INCLUDING BUT NOT LIMITED TO THE WARRANTIES OF MERCHANTABILITY, FITNESS FOR A PARTICULAR PURPOSE AND NONINFRINGEMENT. IN NO EVENT SHALL THE AUTHORS OR COPYRIGHT HOLDERS BE LIABLE FOR ANY CLAIM, DAMAGES OR OTHER LIABILITY, WHETHER IN AN ACTION OF CONTRACT, TORT OR OTHERWISE, ARISING FROM, OUT OF OR IN CONNECTION WITH THE SOFTWARE OR THE USE OR OTHER DEALINGS IN THE SOFTWARE.

The MIT License (MIT)

Copyright (c) 2013 AllPlayers.com

Permission is hereby granted, free of charge, to any person obtaining a copy of this software and associated documentation files (the "Software"), to deal in the Software without restriction, including without limitation the rights to use, copy, modify, merge, publish, distribute, sublicense, and/or sell copies of the Software, and to permit persons to whom the Software is furnished to do so, subject to the following conditions:

The above copyright notice and this permission notice shall be included in all copies or substantial portions of the Software.

THE SOFTWARE IS PROVIDED "AS IS", WITHOUT WARRANTY OF ANY KIND, EXPRESS OR IMPLIED, INCLUDING BUT NOT LIMITED TO THE WARRANTIES OF MERCHANTABILITY, FITNESS FOR A PARTICULAR PURPOSE AND NONINFRINGEMENT. IN NO EVENT SHALL THE AUTHORS OR COPYRIGHT HOLDERS BE LIABLE FOR ANY CLAIM, DAMAGES OR OTHER LIABILITY, WHETHER IN AN ACTION OF CONTRACT, TORT OR OTHERWISE, ARISING FROM, OUT OF OR IN CONNECTION WITH THE SOFTWARE OR THE USE OR OTHER DEALINGS IN THE SOFTWARE.

The MIT License (MIT)

Copyright(c) 2011 TJ Holowaychuk <tj@vision-media.ca>

Permission is hereby granted, free of charge, to any person obtaining a copy of this software and associated documentation files (the "Software"), to deal in the Software without restriction, including without limitation the rights to use, copy, modify, merge, publish, distribute, sublicense, and/or sell copies of the Software, and to permit persons to whom the Software is furnished to do so, subject to the following conditions:

The above copyright notice and this permission notice shall be included in all copies or substantial portions of the Software.

THE SOFTWARE IS PROVIDED "AS IS", WITHOUT WARRANTY OF ANY KIND, EXPRESS OR IMPLIED, INCLUDING BUT NOT LIMITED TO THE WARRANTIES OF MERCHANTABILITY, FITNESS FOR A PARTICULAR PURPOSE AND NONINFRINGEMENT. IN NO EVENT SHALL THE AUTHORS OR COPYRIGHT HOLDERS BE LIABLE FOR ANY CLAIM, DAMAGES OR OTHER LIABILITY, WHETHER IN AN ACTION OF CONTRACT, TORT OR OTHERWISE, ARISING FROM, OUT OF OR IN CONNECTION WITH THE SOFTWARE OR THE USE OR OTHER DEALINGS IN THE SOFTWARE.

33.libcurl

COPYRIGHT AND PERMISSION NOTICE

Copyright (c) 1996 – 2019, Daniel Stenberg, daniel@haxx.se, and many contributors, see the THANKS file.

All rights reserved.

Permission to use, copy, modify, and distribute this software for any purpose with or without fee is hereby granted, provided that the above copyright notice and this permission notice appear in all copies.

THE SOFTWARE IS PROVIDED "AS IS", WITHOUT WARRANTY OF ANY KIND, EXPRESS OR IMPLIED, INCLUDING BUT NOT LIMITED TO THE WARRANTIES OF MERCHANTABILITY, FITNESS FOR A PARTICULAR PURPOSE AND NONINFRINGEMENT OF THIRD PARTY RIGHTS. IN NO EVENT SHALL THE AUTHORS OR COPYRIGHT HOLDERS BE LIABLE FOR ANY CLAIM, DAMAGES OR OTHER LIABILITY, WHETHER IN AN ACTION OF CONTRACT, TORT OR OTHERWISE, ARISING FROM, OUT OF OR IN CONNECTION WITH THE SOFTWARE OR THE USE OR OTHER DEALINGS IN THE SOFTWARE.

Except as contained in this notice, the name of a copyright holder shall not be used in advertising or otherwise to promote the sale, use or other dealings in this Software without prior written authorization of the copyright holder.

COPYRIGHT AND PERMISSION NOTICE

Copyright (C) 2010, DirecTV, Contact: Eric Hu, ehu@directv.com.

Copyright (C) 2010 – 2018, Daniel Stenberg, daniel@haxx.se, et al.

All rights reserved.

Permission to use, copy, modify, and distribute this software for any purpose with or without fee is hereby granted, provided that the above copyright notice and this permission notice appear in all copies.

THE SOFTWARE IS PROVIDED "AS IS", WITHOUT WARRANTY OF ANY KIND, EXPRESS OR IMPLIED, INCLUDING BUT NOT LIMITED TO THE WARRANTIES OF MERCHANTABILITY, FITNESS FOR A

PARTICULAR PURPOSE AND NONINFRINGEMENT OF THIRD PARTY RIGHTS. IN NO EVENT SHALL THE AUTHORS OR COPYRIGHT HOLDERS BE LIABLE FOR ANY CLAIM, DAMAGES OR OTHER LIABILITY, WHETHER IN AN ACTION OF CONTRACT, TORT OR OTHERWISE, ARISING FROM, OUT OF OR IN CONNECTION WITH THE SOFTWARE OR THE USE OR OTHER DEALINGS IN THE SOFTWARE.

Except as contained in this notice, the name of a copyright holder shall not be used in advertising or otherwise to promote the sale, use or other dealings in this Software without prior written authorization of the copyright holder.

COPYRIGHT AND PERMISSION NOTICE

Copyright (C) 2012 – 2016, Linus Nielsen Feltzing, <linus@haxx.se>

Copyright (C) 2012 – 2017, Daniel Stenberg, <daniel@haxx.se>, et al.

All rights reserved.

Permission to use, copy, modify, and distribute this software for any purpose with or without fee is hereby granted, provided that the above copyright notice and this permission notice appear in all copies.

THE SOFTWARE IS PROVIDED "AS IS", WITHOUT WARRANTY OF ANY KIND, EXPRESS OR IMPLIED, INCLUDING BUT NOT LIMITED TO THE WARRANTIES OF MERCHANTABILITY, FITNESS FOR A PARTICULAR PURPOSE AND NONINFRINGEMENT OF THIRD PARTY RIGHTS. IN NO EVENT SHALL THE AUTHORS OR COPYRIGHT HOLDERS BE LIABLE FOR ANY CLAIM, DAMAGES OR OTHER LIABILITY, WHETHER IN AN ACTION OF CONTRACT, TORT OR OTHERWISE, ARISING FROM, OUT OF OR IN CONNECTION WITH THE SOFTWARE OR THE USE OR OTHER DEALINGS IN THE SOFTWARE.

Except as contained in this notice, the name of a copyright holder shall not be used in advertising or otherwise to promote the sale, use or other dealings in this Software without prior written authorization of the copyright holder.

COPYRIGHT AND PERMISSION NOTICE

Copyright (C) 2015 – 2017, Daniel Stenberg, <daniel@haxx.se>, et al.

Copyright (C) 2012 – 2014, Linus Nielsen Feltzing, <linus@haxx.se>

All rights reserved.

Permission to use, copy, modify, and distribute this software for any purpose with or without fee is hereby granted, provided that the above copyright notice and this permission notice appear in all copies.

THE SOFTWARE IS PROVIDED "AS IS", WITHOUT WARRANTY OF ANY KIND, EXPRESS OR IMPLIED, INCLUDING BUT NOT LIMITED TO THE WARRANTIES OF MERCHANTABILITY, FITNESS FOR A PARTICULAR PURPOSE AND NONINFRINGEMENT OF THIRD PARTY RIGHTS. IN NO EVENT SHALL THE AUTHORS OR COPYRIGHT HOLDERS BE LIABLE FOR ANY CLAIM, DAMAGES OR OTHER LIABILITY, WHETHER IN AN ACTION OF CONTRACT, TORT OR OTHERWISE, ARISING FROM, OUT OF OR IN CONNECTION WITH THE SOFTWARE OR THE USE OR OTHER DEALINGS IN THE SOFTWARE.

Except as contained in this notice, the name of a copyright holder shall not be used in advertising or otherwise to promote the sale, use or other dealings in this Software without prior written authorization of the copyright holder.

COPYRIGHT AND PERMISSION NOTICE

Copyright (C) 2014 – 2017, Steve Holme, <steve_holme@hotmail.com>.

All rights reserved.

Permission to use, copy, modify, and distribute this software for any purpose with or without fee is hereby granted, provided that the above copyright notice and this permission notice appear in all copies.

THE SOFTWARE IS PROVIDED "AS IS", WITHOUT WARRANTY OF ANY KIND, EXPRESS OR IMPLIED, INCLUDING BUT NOT LIMITED TO THE WARRANTIES OF MERCHANTABILITY, FITNESS FOR A PARTICULAR PURPOSE AND NONINFRINGEMENT OF THIRD PARTY RIGHTS. IN NO EVENT SHALL THE AUTHORS OR COPYRIGHT HOLDERS BE LIABLE FOR ANY CLAIM, DAMAGES OR OTHER LIABILITY, WHETHER IN AN ACTION OF CONTRACT, TORT OR OTHERWISE, ARISING FROM, OUT OF OR IN CONNECTION WITH THE SOFTWARE OR THE USE OR OTHER DEALINGS IN THE SOFTWARE.

Except as contained in this notice, the name of a copyright holder shall not be used in advertising or otherwise to promote the sale, use or other dealings in this Software without prior written authorization of the copyright holder.

COPYRIGHT AND PERMISSION NOTICE

Copyright (C) 2012 – 2015, Daniel Stenberg, <daniel@haxx.se>, et al.

Copyright (C) 2010, Howard Chu, <hyc@highlandsun.com>

All rights reserved.

Permission to use, copy, modify, and distribute this software for any purpose with or without fee is hereby granted, provided that the above copyright notice and this permission notice appear in all copies.

THE SOFTWARE IS PROVIDED "AS IS", WITHOUT WARRANTY OF ANY KIND, EXPRESS OR IMPLIED, INCLUDING BUT NOT LIMITED TO THE WARRANTIES OF MERCHANTABILITY, FITNESS FOR A PARTICULAR PURPOSE AND NONINFRINGEMENT OF THIRD PARTY RIGHTS. IN NO EVENT SHALL THE AUTHORS OR COPYRIGHT HOLDERS BE LIABLE FOR ANY CLAIM, DAMAGES OR OTHER LIABILITY, WHETHER IN AN ACTION OF CONTRACT, TORT OR OTHERWISE, ARISING FROM, OUT OF OR IN CONNECTION WITH THE SOFTWARE OR THE USE OR OTHER DEALINGS IN THE SOFTWARE.

Except as contained in this notice, the name of a copyright holder shall not be used in advertising or otherwise to promote the sale, use or other dealings in this Software without prior written authorization of the copyright holder.

COPYRIGHT AND PERMISSION NOTICE

Copyright (C) 2010, Howard Chu, <hyc@highlandsun.com>

All rights reserved.

Permission to use, copy, modify, and distribute this software for any purpose with or without fee is hereby granted, provided that the above copyright notice and this permission notice appear in all copies.

THE SOFTWARE IS PROVIDED "AS IS", WITHOUT WARRANTY OF ANY KIND, EXPRESS OR IMPLIED, INCLUDING BUT NOT LIMITED TO THE WARRANTIES OF MERCHANTABILITY, FITNESS FOR A PARTICULAR PURPOSE AND NONINFRINGEMENT OF THIRD PARTY RIGHTS. IN NO EVENT SHALL THE AUTHORS OR COPYRIGHT HOLDERS BE LIABLE FOR ANY CLAIM, DAMAGES OR OTHER LIABILITY, WHETHER IN AN ACTION OF CONTRACT, TORT OR OTHERWISE, ARISING FROM, OUT OF OR IN CONNECTION WITH THE SOFTWARE OR THE USE OR OTHER DEALINGS IN THE SOFTWARE.

Except as contained in this notice, the name of a copyright holder shall not be used in advertising or

otherwise to promote the sale, use or other dealings in this Software without prior written authorization of the copyright holder.

COPYRIGHT AND PERMISSION NOTICE

Copyright (C) 1998 – 2016, Florin Petriuc, <petriuc.florin@gmail.com>

All rights reserved.

Permission to use, copy, modify, and distribute this software for any purpose with or without fee is hereby granted, provided that the above copyright notice and this permission notice appear in all copies.

THE SOFTWARE IS PROVIDED "AS IS", WITHOUT WARRANTY OF ANY KIND, EXPRESS OR IMPLIED, INCLUDING BUT NOT LIMITED TO THE WARRANTIES OF MERCHANTABILITY, FITNESS FOR A PARTICULAR PURPOSE AND NONINFRINGEMENT OF THIRD PARTY RIGHTS. IN NO EVENT SHALL THE AUTHORS OR COPYRIGHT HOLDERS BE LIABLE FOR ANY CLAIM, DAMAGES OR OTHER LIABILITY, WHETHER IN AN ACTION OF CONTRACT, TORT OR OTHERWISE, ARISING FROM, OUT OF OR IN CONNECTION WITH THE SOFTWARE OR THE USE OR OTHER DEALINGS IN THE SOFTWARE.

Except as contained in this notice, the name of a copyright holder shall not be used in advertising or otherwise to promote the sale, use or other dealings in this Software without prior written authorization of the copyright holder.

COPYRIGHT AND PERMISSION NOTICE

Copyright (C) 2012 – 2017, Nick Zitzmann, <nickzman@gmail.com>.

Copyright (C) 2012 – 2018, Daniel Stenberg, <daniel@haxx.se>, et al.

All rights reserved.

Permission to use, copy, modify, and distribute this software for any purpose with or without fee is hereby granted, provided that the above copyright notice and this permission notice appear in all copies.

THE SOFTWARE IS PROVIDED "AS IS", WITHOUT WARRANTY OF ANY KIND, EXPRESS OR IMPLIED, INCLUDING BUT NOT LIMITED TO THE WARRANTIES OF MERCHANTABILITY, FITNESS FOR A PARTICULAR PURPOSE AND NONINFRINGEMENT OF THIRD PARTY RIGHTS. IN NO EVENT SHALL THE

AUTHORS OR COPYRIGHT HOLDERS BE LIABLE FOR ANY CLAIM, DAMAGES OR OTHER LIABILITY, WHETHER IN AN ACTION OF CONTRACT, TORT OR OTHERWISE, ARISING FROM, OUT OF OR IN CONNECTION WITH THE SOFTWARE OR THE USE OR OTHER DEALINGS IN THE SOFTWARE.

Except as contained in this notice, the name of a copyright holder shall not be used in advertising or otherwise to promote the sale, use or other dealings in this Software without prior written authorization of the copyright holder.

COPYRIGHT AND PERMISSION NOTICE

Copyright (C) 2014 – 2016, Steve Holme, <steve_holme@hotmail.com>.

Copyright (C) 2015 – 2017, Daniel Stenberg, <daniel@haxx.se>, et al.

All rights reserved.

Permission to use, copy, modify, and distribute this software for any purpose with or without fee is hereby granted, provided that the above copyright notice and this permission notice appear in all copies.

THE SOFTWARE IS PROVIDED "AS IS", WITHOUT WARRANTY OF ANY KIND, EXPRESS OR IMPLIED, INCLUDING BUT NOT LIMITED TO THE WARRANTIES OF MERCHANTABILITY, FITNESS FOR A PARTICULAR PURPOSE AND NONINFRINGEMENT OF THIRD PARTY RIGHTS. IN NO EVENT SHALL THE AUTHORS OR COPYRIGHT HOLDERS BE LIABLE FOR ANY CLAIM, DAMAGES OR OTHER LIABILITY, WHETHER IN AN ACTION OF CONTRACT, TORT OR OTHERWISE, ARISING FROM, OUT OF OR IN CONNECTION WITH THE SOFTWARE OR THE USE OR OTHER DEALINGS IN THE SOFTWARE.

Except as contained in this notice, the name of a copyright holder shall not be used in advertising or otherwise to promote the sale, use or other dealings in this Software without prior written authorization of the copyright holder.

COPYRIGHT AND PERMISSION NOTICE

Copyright (C) 2010 – 2011, Hoi-Ho Chan, <hoiho.chan@gmail.com>

Copyright (C) 2012 – 2018, Daniel Stenberg, <daniel@haxx.se>, et al.

All rights reserved.

Permission to use, copy, modify, and distribute this software for any purpose with or without fee is

hereby granted, provided that the above copyright notice and this permission notice appear in all copies.

THE SOFTWARE IS PROVIDED "AS IS", WITHOUT WARRANTY OF ANY KIND, EXPRESS OR IMPLIED, INCLUDING BUT NOT LIMITED TO THE WARRANTIES OF MERCHANTABILITY, FITNESS FOR A PARTICULAR PURPOSE AND NONINFRINGEMENT OF THIRD PARTY RIGHTS. IN NO EVENT SHALL THE AUTHORS OR COPYRIGHT HOLDERS BE LIABLE FOR ANY CLAIM, DAMAGES OR OTHER LIABILITY, WHETHER IN AN ACTION OF CONTRACT, TORT OR OTHERWISE, ARISING FROM, OUT OF OR IN CONNECTION WITH THE SOFTWARE OR THE USE OR OTHER DEALINGS IN THE SOFTWARE.

Except as contained in this notice, the name of a copyright holder shall not be used in advertising or otherwise to promote the sale, use or other dealings in this Software without prior written authorization of the copyright holder.

COPYRIGHT AND PERMISSION NOTICE

Copyright (C) 2012 – 2018, Daniel Stenberg, <daniel@haxx.se>, et al.

Copyright (C) 2010 , 2011, Hoi-Ho Chan, <hoiho.chan@gmail.com>

All rights reserved.

Permission to use, copy, modify, and distribute this software for any purpose with or without fee is hereby granted, provided that the above copyright notice and this permission notice appear in all copies.

THE SOFTWARE IS PROVIDED "AS IS", WITHOUT WARRANTY OF ANY KIND, EXPRESS OR IMPLIED, INCLUDING BUT NOT LIMITED TO THE WARRANTIES OF MERCHANTABILITY, FITNESS FOR A PARTICULAR PURPOSE AND NONINFRINGEMENT OF THIRD PARTY RIGHTS. IN NO EVENT SHALL THE AUTHORS OR COPYRIGHT HOLDERS BE LIABLE FOR ANY CLAIM, DAMAGES OR OTHER LIABILITY, WHETHER IN AN ACTION OF CONTRACT, TORT OR OTHERWISE, ARISING FROM, OUT OF OR IN CONNECTION WITH THE SOFTWARE OR THE USE OR OTHER DEALINGS IN THE SOFTWARE.

Except as contained in this notice, the name of a copyright holder shall not be used in advertising or otherwise to promote the sale, use or other dealings in this Software without prior written authorization of the copyright holder.

COPYRIGHT AND PERMISSION NOTICE

Copyright (C) 2010, Howard Chu, <hyc@openldap.org>

Copyright (C) 2011 – 2018, Daniel Stenberg, <daniel@haxx.se>, et al.

All rights reserved.

Permission to use, copy, modify, and distribute this software for any purpose with or without fee is hereby granted, provided that the above copyright notice and this permission notice appear in all copies.

THE SOFTWARE IS PROVIDED "AS IS", WITHOUT WARRANTY OF ANY KIND, EXPRESS OR IMPLIED, INCLUDING BUT NOT LIMITED TO THE WARRANTIES OF MERCHANTABILITY, FITNESS FOR A PARTICULAR PURPOSE AND NONINFRINGEMENT OF THIRD PARTY RIGHTS. IN NO EVENT SHALL THE AUTHORS OR COPYRIGHT HOLDERS BE LIABLE FOR ANY CLAIM, DAMAGES OR OTHER LIABILITY, WHETHER IN AN ACTION OF CONTRACT, TORT OR OTHERWISE, ARISING FROM, OUT OF OR IN CONNECTION WITH THE SOFTWARE OR THE USE OR OTHER DEALINGS IN THE SOFTWARE.

Except as contained in this notice, the name of a copyright holder shall not be used in advertising or otherwise to promote the sale, use or other dealings in this Software without prior written authorization of the copyright holder.

COPYRIGHT AND PERMISSION NOTICE

Copyright (C) 2012 – 2016, Marc Hoersken, <info@marc-hoersken.de>

Copyright (C) 2012, Mark Salisbury, <mark.salisbury@hp.com>

Copyright (C) 2012 – 2018, Daniel Stenberg, <daniel@haxx.se>, et al.

All rights reserved.

Permission to use, copy, modify, and distribute this software for any purpose with or without fee is hereby granted, provided that the above copyright notice and this permission notice appear in all copies.

THE SOFTWARE IS PROVIDED "AS IS", WITHOUT WARRANTY OF ANY KIND, EXPRESS OR IMPLIED, INCLUDING BUT NOT LIMITED TO THE WARRANTIES OF MERCHANTABILITY, FITNESS FOR A PARTICULAR PURPOSE AND NONINFRINGEMENT OF THIRD PARTY RIGHTS. IN NO EVENT SHALL THE AUTHORS OR COPYRIGHT HOLDERS BE LIABLE FOR ANY CLAIM, DAMAGES OR OTHER LIABILITY, WHETHER IN AN ACTION OF CONTRACT, TORT OR OTHERWISE, ARISING FROM, OUT OF OR IN CONNECTION WITH THE SOFTWARE OR THE USE OR OTHER DEALINGS IN THE SOFTWARE.

Except as contained in this notice, the name of a copyright holder shall not be used in advertising or otherwise to promote the sale, use or other dealings in this Software without prior written authorization of the copyright holder.

COPYRIGHT AND PERMISSION NOTICE

Copyright (C) 2012, Marc Hoersken, <info@marc-hoersken.de>, et al.

Copyright (C) 2012 – 2017, Daniel Stenberg, <daniel@haxx.se>, et al.

All rights reserved.

Permission to use, copy, modify, and distribute this software for any purpose with or without fee is hereby granted, provided that the above copyright notice and this permission notice appear in all copies.

THE SOFTWARE IS PROVIDED "AS IS", WITHOUT WARRANTY OF ANY KIND, EXPRESS OR IMPLIED, INCLUDING BUT NOT LIMITED TO THE WARRANTIES OF MERCHANTABILITY, FITNESS FOR A PARTICULAR PURPOSE AND NONINFRINGEMENT OF THIRD PARTY RIGHTS. IN NO EVENT SHALL THE AUTHORS OR COPYRIGHT HOLDERS BE LIABLE FOR ANY CLAIM, DAMAGES OR OTHER LIABILITY, WHETHER IN AN ACTION OF CONTRACT, TORT OR OTHERWISE, ARISING FROM, OUT OF OR IN CONNECTION WITH THE SOFTWARE OR THE USE OR OTHER DEALINGS IN THE SOFTWARE.

Except as contained in this notice, the name of a copyright holder shall not be used in advertising or otherwise to promote the sale, use or other dealings in this Software without prior written authorization of the copyright holder.

COPYRIGHT AND PERMISSION NOTICE

Copyright (C) 2014, Bill Nagel <wnagel@tycoint.com>, Exacq Technologies

Copyright (C) 2016–2018, Daniel Stenberg, <daniel@haxx.se>, et al.

All rights reserved.

Permission to use, copy, modify, and distribute this software for any purpose with or without fee is hereby granted, provided that the above copyright notice and this permission notice appear in all copies.

THE SOFTWARE IS PROVIDED "AS IS", WITHOUT WARRANTY OF ANY KIND, EXPRESS OR IMPLIED, INCLUDING BUT NOT LIMITED TO THE WARRANTIES OF MERCHANTABILITY, FITNESS FOR A PARTICULAR PURPOSE AND NONINFRINGEMENT OF THIRD PARTY RIGHTS. IN NO EVENT SHALL THE AUTHORS OR COPYRIGHT HOLDERS BE LIABLE FOR ANY CLAIM, DAMAGES OR OTHER LIABILITY, WHETHER IN AN ACTION OF CONTRACT, TORT OR OTHERWISE, ARISING FROM, OUT OF OR IN CONNECTION WITH THE SOFTWARE OR THE USE OR OTHER DEALINGS IN THE SOFTWARE.

Except as contained in this notice, the name of a copyright holder shall not be used in advertising or otherwise to promote the sale, use or other dealings in this Software without prior written authorization of the copyright holder.

COPYRIGHT AND PERMISSION NOTICE

Copyright (C) 2009, Markus Moeller, <markus_moeller@compuserve.com>

Copyright (C) 2012 – 2017, Daniel Stenberg, <daniel@haxx.se>, et al.

All rights reserved.

Permission to use, copy, modify, and distribute this software for any purpose with or without fee is hereby granted, provided that the above copyright notice and this permission notice appear in all copies.

THE SOFTWARE IS PROVIDED "AS IS", WITHOUT WARRANTY OF ANY KIND, EXPRESS OR IMPLIED, INCLUDING BUT NOT LIMITED TO THE WARRANTIES OF MERCHANTABILITY, FITNESS FOR A PARTICULAR PURPOSE AND NONINFRINGEMENT OF THIRD PARTY RIGHTS. IN NO EVENT SHALL THE AUTHORS OR COPYRIGHT HOLDERS BE LIABLE FOR ANY CLAIM, DAMAGES OR OTHER LIABILITY, WHETHER IN AN ACTION OF CONTRACT, TORT OR OTHERWISE, ARISING FROM, OUT OF OR IN CONNECTION WITH THE SOFTWARE OR THE USE OR OTHER DEALINGS IN THE SOFTWARE.

Except as contained in this notice, the name of a copyright holder shall not be used in advertising or otherwise to promote the sale, use or other dealings in this Software without prior written authorization of the copyright holder.

COPYRIGHT AND PERMISSION NOTICE

Copyright (C) 2012 – 2017, Daniel Stenberg, <daniel@haxx.se>, et al.

Copyright (C) 2009, 2011, Markus Moeller, <markus_moeller@compuserve.com>

All rights reserved.

Permission to use, copy, modify, and distribute this software for any purpose with or without fee is hereby granted, provided that the above copyright notice and this permission notice appear in all copies.

THE SOFTWARE IS PROVIDED "AS IS", WITHOUT WARRANTY OF ANY KIND, EXPRESS OR IMPLIED, INCLUDING BUT NOT LIMITED TO THE WARRANTIES OF MERCHANTABILITY, FITNESS FOR A PARTICULAR PURPOSE AND NONINFRINGEMENT OF THIRD PARTY RIGHTS. IN NO EVENT SHALL THE AUTHORS OR COPYRIGHT HOLDERS BE LIABLE FOR ANY CLAIM, DAMAGES OR OTHER LIABILITY, WHETHER IN AN ACTION OF CONTRACT, TORT OR OTHERWISE, ARISING FROM, OUT OF OR IN CONNECTION WITH THE SOFTWARE OR THE USE OR OTHER DEALINGS IN THE SOFTWARE.

Except as contained in this notice, the name of a copyright holder shall not be used in advertising or otherwise to promote the sale, use or other dealings in this Software without prior written authorization of the copyright holder.

* Copyright (C) 2017 – 2018 Red Hat, Inc.

*

* Authors: Nikos Mavrogiannopoulos, Tomas Mraz, Stanislav Zidek,

* Robert Kolcun, Andreas Schneider

*

* This software is licensed as described in the file COPYING, which

* you should have received as part of this distribution. The terms

* are also available at <https://curl.haxx.se/docs/copyright.html>.

*

* You may opt to use, copy, modify, merge, publish, distribute and/or sell

* copies of the Software, and permit persons to whom the Software is

* furnished to do so, under the terms of the COPYING file.

*

* This software is distributed on an "AS IS" basis, WITHOUT WARRANTY OF ANY

* KIND, either express or implied.

Copyright (C) 1994 X Consortium

#

Permission is hereby granted, free of charge, to any person obtaining a copy

of this software and associated documentation files (the "Software"), to

deal in the Software without restriction, including without limitation the

rights to use, copy, modify, merge, publish, distribute, sublicense, and/or
sell copies of the Software, and to permit persons to whom the Software is
furnished to do so, subject to the following conditions:

The above copyright notice and this permission notice shall be included in
all copies or substantial portions of the Software.

THE SOFTWARE IS PROVIDED "AS IS", WITHOUT WARRANTY OF ANY KIND, EXPRESS OR
IMPLIED, INCLUDING BUT NOT LIMITED TO THE WARRANTIES OF MERCHANTABILITY,
FITNESS FOR A PARTICULAR PURPOSE AND NONINFRINGEMENT. IN NO EVENT SHALL THE
X CONSORTIUM BE LIABLE FOR ANY CLAIM, DAMAGES OR OTHER LIABILITY, WHETHER IN
AN ACTION OF CONTRACT, TORT OR OTHERWISE, ARISING FROM, OUT OF OR IN CONNec-
TION WITH THE SOFTWARE OR THE USE OR OTHER DEALINGS IN THE SOFTWARE. +

Except as contained in this notice, the name of the X Consortium shall not
be used in advertising or otherwise to promote the sale, use or other deal-
ings in this Software without prior written authorization from the X Consor-
tium.

* Copyright (C) 1996–2001 Internet Software Consortium.

*

* Permission to use, copy, modify, and distribute this software for any
* purpose with or without fee is hereby granted, provided that the above
* copyright notice and this permission notice appear in all copies.

*

* THE SOFTWARE IS PROVIDED "AS IS" AND INTERNET SOFTWARE CONSORTIUM
* DISCLAIMS ALL WARRANTIES WITH REGARD TO THIS SOFTWARE INCLUDING ALL
* IMPLIED WARRANTIES OF MERCHANTABILITY AND FITNESS. IN NO EVENT SHALL
* INTERNET SOFTWARE CONSORTIUM BE LIABLE FOR ANY SPECIAL, DIRECT,
* INDIRECT, OR CONSEQUENTIAL DAMAGES OR ANY DAMAGES WHATSOEVER RESULTING
* FROM LOSS OF USE, DATA OR PROFITS, WHETHER IN AN ACTION OF CONTRACT,
* NEGLIGENCE OR OTHER TORTIOUS ACTION, ARISING OUT OF OR IN CONNECTION
* WITH THE USE OR PERFORMANCE OF THIS SOFTWARE.

* Copyright (c) 1995, 1996, 1997, 1998, 1999, 2017 Kungliga Tekniska Högskolan
* (Royal Institute of Technology, Stockholm, Sweden).

* Copyright (c) 2001 – 2017 Daniel Stenberg

* All rights reserved.

*

* Redistribution and use in source and binary forms, with or without
* modification, are permitted provided that the following conditions
* are met:

*

* 1. Redistributions of source code must retain the above copyright
* notice, this list of conditions and the following disclaimer.

*

* 2. Redistributions in binary form must reproduce the above copyright
* notice, this list of conditions and the following disclaimer in the
* documentation and/or other materials provided with the distribution.

*

* 3. Neither the name of the Institute nor the names of its contributors
* may be used to endorse or promote products derived from this software
* without specific prior written permission.

*

* THIS SOFTWARE IS PROVIDED BY THE INSTITUTE AND CONTRIBUTORS ``AS IS" AND
* ANY EXPRESS OR IMPLIED WARRANTIES, INCLUDING, BUT NOT LIMITED TO, THE
* IMPLIED WARRANTIES OF MERCHANTABILITY AND FITNESS FOR A PARTICULAR PURPOSE
* ARE DISCLAIMED. IN NO EVENT SHALL THE INSTITUTE OR CONTRIBUTORS BE LIABLE
* FOR ANY DIRECT, INDIRECT, INCIDENTAL, SPECIAL, EXEMPLARY, OR CONSEQUENTIAL
* DAMAGES (INCLUDING, BUT NOT LIMITED TO, PROCUREMENT OF SUBSTITUTE GOODS
* OR SERVICES; LOSS OF USE, DATA, OR PROFITS; OR BUSINESS INTERRUPTION)
* HOWEVER CAUSED AND ON ANY THEORY OF LIABILITY, WHETHER IN CONTRACT, STRICT
* LIABILITY, OR TORT (INCLUDING NEGLIGENCE OR OTHERWISE) ARISING IN ANY WAY
* OUT OF THE USE OF THIS SOFTWARE, EVEN IF ADVISED OF THE POSSIBILITY OF
* SUCH DAMAGE. */

34.libdrm

* Copyright 1999, 2000 Precision Insight, Inc., Cedar Park, Texas.

* Copyright 2000 VA Linux Systems, Inc., Sunnyvale, California.

* All Rights Reserved.

*

* Permission is hereby granted, free of charge, to any person obtaining a
* copy of this software and associated documentation files (the "Software"),
* to deal in the Software without restriction, including without limitation
* the rights to use, copy, modify, merge, publish, distribute, sublicense,
* and/or sell copies of the Software, and to permit persons to whom the
* Software is furnished to do so, subject to the following conditions:

*

* The above copyright notice and this permission notice (including the next
* paragraph) shall be included in all copies or substantial portions of the
* Software.

*

* THE SOFTWARE IS PROVIDED "AS IS", WITHOUT WARRANTY OF ANY KIND, EXPRESS OR
* IMPLIED, INCLUDING BUT NOT LIMITED TO THE WARRANTIES OF MERCHANTABILITY,
* FITNESS FOR A PARTICULAR PURPOSE AND NONINFRINGEMENT. IN NO EVENT SHALL
* PRECISION INSIGHT AND/OR ITS SUPPLIERS BE LIABLE FOR ANY CLAIM, DAMAGES OR
* OTHER LIABILITY, WHETHER IN AN ACTION OF CONTRACT, TORT OR OTHERWISE,
* ARISING FROM, OUT OF OR IN CONNECTION WITH THE SOFTWARE OR THE USE OR OTHER
* DEALINGS IN THE SOFTWARE.

* Copyright © 2007–2012 Intel Corporation

*

* Permission is hereby granted, free of charge, to any person obtaining a
* copy of this software and associated documentation files (the "Software"),
* to deal in the Software without restriction, including without limitation
* the rights to use, copy, modify, merge, publish, distribute, sublicense,
* and/or sell copies of the Software, and to permit persons to whom the
* Software is furnished to do so, subject to the following conditions:

*

* The above copyright notice and this permission notice (including the next
* paragraph) shall be included in all copies or substantial portions of the

* Software.

*

* THE SOFTWARE IS PROVIDED "AS IS", WITHOUT WARRANTY OF ANY KIND, EXPRESS OR
* IMPLIED, INCLUDING BUT NOT LIMITED TO THE WARRANTIES OF MERCHANTABILITY,
* FITNESS FOR A PARTICULAR PURPOSE AND NON-INFRINGEMENT. IN NO EVENT SHALL
* THE AUTHORS OR COPYRIGHT HOLDERS BE LIABLE FOR ANY CLAIM, DAMAGES OR OTHER
* LIABILITY, WHETHER IN AN ACTION OF CONTRACT, TORT OR OTHERWISE, ARISING
* FROM, OUT OF OR IN CONNECTION WITH THE SOFTWARE OR THE USE OR OTHER DEALINGS
* IN THE SOFTWARE.

* Copyright 2002, 2003, 2006 Tungsten Graphics, Inc., Cedar Park, Texas.

* All Rights Reserved.

*

* Permission is hereby granted, free of charge, to any person obtaining a
* copy of this software and associated documentation files (the
* "Software"), to deal in the Software without restriction, including
* without limitation the rights to use, copy, modify, merge, publish,
* distribute, sub license, and/or sell copies of the Software, and to
* permit persons to whom the Software is furnished to do so, subject to
* the following conditions:

*

* The above copyright notice and this permission notice (including the
* next paragraph) shall be included in all copies or substantial portions
* of the Software.

*

* THE SOFTWARE IS PROVIDED "AS IS", WITHOUT WARRANTY OF ANY KIND, EXPRESS
* OR IMPLIED, INCLUDING BUT NOT LIMITED TO THE WARRANTIES OF
* MERCHANTABILITY, FITNESS FOR A PARTICULAR PURPOSE AND NON-INFRINGEMENT.
* IN NO EVENT SHALL TUNGSTEN GRAPHICS AND/OR ITS SUPPLIERS BE LIABLE FOR
* ANY CLAIM, DAMAGES OR OTHER LIABILITY, WHETHER IN AN ACTION OF CONTRACT,
* TORT OR OTHERWISE, ARISING FROM, OUT OF OR IN CONNECTION WITH THE
* SOFTWARE OR THE USE OR OTHER DEALINGS IN THE SOFTWARE.

* Copyright © 2007 Red Hat Inc.

* Copyright © 2007–2012 Intel Corporation

* Copyright 2006 Tungsten Graphics, Inc., Bismarck, ND., USA

* All Rights Reserved.

*

* Permission is hereby granted, free of charge, to any person obtaining a
* copy of this software and associated documentation files (the
* "Software"), to deal in the Software without restriction, including
* without limitation the rights to use, copy, modify, merge, publish,
* distribute, sub license, and/or sell copies of the Software, and to
* permit persons to whom the Software is furnished to do so, subject to
* the following conditions:

*

* THE SOFTWARE IS PROVIDED "AS IS", WITHOUT WARRANTY OF ANY KIND, EXPRESS OR
* IMPLIED, INCLUDING BUT NOT LIMITED TO THE WARRANTIES OF MERCHANTABILITY,
* FITNESS FOR A PARTICULAR PURPOSE AND NON-INFRINGEMENT. IN NO EVENT SHALL
* THE COPYRIGHT HOLDERS, AUTHORS AND/OR ITS SUPPLIERS BE LIABLE FOR ANY CLAIM,
* DAMAGES OR OTHER LIABILITY, WHETHER IN AN ACTION OF CONTRACT, TORT OR
* OTHERWISE, ARISING FROM, OUT OF OR IN CONNECTION WITH THE SOFTWARE OR THE
* USE OR OTHER DEALINGS IN THE SOFTWARE.

*

* The above copyright notice and this permission notice (including the
* next paragraph) shall be included in all copies or substantial portions
* of the Software.

* Copyright 1999 Precision Insight, Inc., Cedar Park, Texas.

* All Rights Reserved.

*

* Permission is hereby granted, free of charge, to any person obtaining a
* copy of this software and associated documentation files (the "Software"),
* to deal in the Software without restriction, including without limitation
* the rights to use, copy, modify, merge, publish, distribute, sublicense,
* and/or sell copies of the Software, and to permit persons to whom the
* Software is furnished to do so, subject to the following conditions:

*

* The above copyright notice and this permission notice (including the next
* paragraph) shall be included in all copies or substantial portions of the
* Software.

*

* THE SOFTWARE IS PROVIDED "AS IS", WITHOUT WARRANTY OF ANY KIND, EXPRESS OR

* IMPLIED, INCLUDING BUT NOT LIMITED TO THE WARRANTIES OF MERCHANTABILITY,
* FITNESS FOR A PARTICULAR PURPOSE AND NON-INFRINGEMENT. IN NO EVENT SHALL
* PRECISION INSIGHT AND/OR ITS SUPPLIERS BE LIABLE FOR ANY CLAIM, DAMAGES OR
* OTHER LIABILITY, WHETHER IN AN ACTION OF CONTRACT, TORT OR OTHERWISE,
* ARISING FROM, OUT OF OR IN CONNECTION WITH THE SOFTWARE OR THE USE OR OTHER
* DEALINGS IN THE SOFTWARE.

Copyright 2005 Adam Jackson.

#

Permission is hereby granted, free of charge, to any person obtaining a
copy of this software and associated documentation files (the "Software"),
to deal in the Software without restriction, including without limitation
on the rights to use, copy, modify, merge, publish, distribute, sub
license, and/or sell copies of the Software, and to permit persons to whom
the Software is furnished to do so, subject to the following conditions:

#

The above copyright notice and this permission notice (including the next
paragraph) shall be included in all copies or substantial portions of the
Software.

#

THE SOFTWARE IS PROVIDED "AS IS", WITHOUT WARRANTY OF ANY KIND, EXPRESS OR
IMPLIED, INCLUDING BUT NOT LIMITED TO THE WARRANTIES OF MERCHANTABILITY,
FITNESS FOR A PARTICULAR PURPOSE AND NON-INFRINGEMENT. IN NO EVENT SHALL
ADAM JACKSON BE LIABLE FOR ANY CLAIM, DAMAGES OR OTHER LIABILITY, WHETHER
IN AN ACTION OF CONTRACT, TORT OR OTHERWISE, ARISING FROM, OUT OF OR IN
CONNECTION WITH THE SOFTWARE OR THE USE OR OTHER DEALINGS IN THE SOFTWARE.

* Copyright 1998–2003 VIA Technologies, Inc. All Rights Reserved.

* Copyright 2001–2003 S3 Graphics, Inc. All Rights Reserved.

*

* Permission is hereby granted, free of charge, to any person obtaining a
* copy of this software and associated documentation files (the "Software"),
* to deal in the Software without restriction, including without limitation
* the rights to use, copy, modify, merge, publish, distribute, sub license,
* and/or sell copies of the Software, and to permit persons to whom the
* Software is furnished to do so, subject to the following conditions:

*

* The above copyright notice and this permission notice (including the
* next paragraph) shall be included in all copies or substantial portions
* of the Software.

*

* THE SOFTWARE IS PROVIDED "AS IS", WITHOUT WARRANTY OF ANY KIND, EXPRESS OR
* IMPLIED, INCLUDING BUT NOT LIMITED TO THE WARRANTIES OF MERCHANTABILITY,
* FITNESS FOR A PARTICULAR PURPOSE AND NON-INFRINGEMENT. IN NO EVENT SHALL
* VIA, S3 GRAPHICS, AND/OR ITS SUPPLIERS BE LIABLE FOR ANY CLAIM, DAMAGES OR
* OTHER LIABILITY, WHETHER IN AN ACTION OF CONTRACT, TORT OR OTHERWISE,
* ARISING FROM, OUT OF OR IN CONNECTION WITH THE SOFTWARE OR THE USE OR OTHER
* DEALINGS IN THE SOFTWARE.

* Copyright 2013 Red Hat

* All Rights Reserved.

*

* Permission is hereby granted, free of charge, to any person obtaining a
* copy of this software and associated documentation files (the "Software"),
* to deal in the Software without restriction, including without limitation
* the rights to use, copy, modify, merge, publish, distribute, sublicense,
* and/or sell copies of the Software, and to permit persons to whom the
* Software is furnished to do so, subject to the following conditions:

*

* The above copyright notice and this permission notice (including the next
* paragraph) shall be included in all copies or substantial portions of the
* Software.

*

* THE SOFTWARE IS PROVIDED "AS IS", WITHOUT WARRANTY OF ANY KIND, EXPRESS OR
* IMPLIED, INCLUDING BUT NOT LIMITED TO THE WARRANTIES OF MERCHANTABILITY,
* FITNESS FOR A PARTICULAR PURPOSE AND NONINFRINGEMENT. IN NO EVENT SHALL
* THE AUTHORS AND/OR ITS SUPPLIERS BE LIABLE FOR ANY CLAIM, DAMAGES OR
* OTHER LIABILITY, WHETHER IN AN ACTION OF CONTRACT, TORT OR OTHERWISE,
* ARISING FROM, OUT OF OR IN CONNECTION WITH THE SOFTWARE OR THE USE OR
* OTHER DEALINGS IN THE SOFTWARE. +

* Copyright 2000 Gareth Hughes

* Copyright 2002 Frank C. Earl

* Copyright 2002–2003 Leif Delgass

* All Rights Reserved.

*

* Permission is hereby granted, free of charge, to any person obtaining a
* copy of this software and associated documentation files (the "Software"),
* to deal in the Software without restriction, including without limitation
* the rights to use, copy, modify, merge, publish, distribute, sublicense,
* and/or sell copies of the Software, and to permit persons to whom the
* Software is furnished to do so, subject to the following conditions:

*

* The above copyright notice and this permission notice (including the next
* paragraph) shall be included in all copies or substantial portions of the
* Software.

*

* THE SOFTWARE IS PROVIDED "AS IS", WITHOUT WARRANTY OF ANY KIND, EXPRESS OR
* IMPLIED, INCLUDING BUT NOT LIMITED TO THE WARRANTIES OF MERCHANTABILITY,
* FITNESS FOR A PARTICULAR PURPOSE AND NONINFRINGEMENT. IN NO EVENT SHALL
* THE COPYRIGHT OWNER(S) BE LIABLE FOR ANY CLAIM, DAMAGES OR OTHER LIABILITY, WHETHER
* IN AN ACTION OF CONTRACT, TORT OR OTHERWISE, ARISING FROM, OUT OF OR IN
* CONNECTION WITH THE SOFTWARE OR THE USE OR OTHER DEALINGS IN THE SOFTWARE. +

* Copyright (c) 2012–2014, NVIDIA CORPORATION. All rights reserved.

*

* Permission is hereby granted, free of charge, to any person obtaining a
* copy of this software and associated documentation files (the "Software"),
* to deal in the Software without restriction, including without limitation
* the rights to use, copy, modify, merge, publish, distribute, sublicense,
* and/or sell copies of the Software, and to permit persons to whom the
* Software is furnished to do so, subject to the following conditions:

*

* The above copyright notice and this permission notice shall be included in
* all copies or substantial portions of the Software.

*

* THE SOFTWARE IS PROVIDED "AS IS", WITHOUT WARRANTY OF ANY KIND, EXPRESS OR
* IMPLIED, INCLUDING BUT NOT LIMITED TO THE WARRANTIES OF MERCHANTABILITY,
* FITNESS FOR A PARTICULAR PURPOSE AND NONINFRINGEMENT. IN NO EVENT SHALL

* THE COPYRIGHT HOLDER(S) OR AUTHOR(S) BE LIABLE FOR ANY CLAIM, DAMAGES OR
* OTHER LIABILITY, WHETHER IN AN ACTION OF CONTRACT, TORT OR OTHERWISE,
* ARISING FROM, OUT OF OR IN CONNECTION WITH THE SOFTWARE OR THE USE OR
* OTHER DEALINGS IN THE SOFTWARE.

* Copyright (c) 2007 Dave Airlie <airlied@linux.ie>
* Copyright (c) 2007 Jakob Bornecrantz <wallbraker@gmail.com>
* Copyright (c) 2008 Red Hat Inc.
* Copyright (c) 2007–2008 Tungsten Graphics, Inc., Cedar Park, TX., USA
* Copyright (c) 2007–2008 Intel Corporation

*
* Permission is hereby granted, free of charge, to any person obtaining a
* copy of this software and associated documentation files (the "Software"),
* to deal in the Software without restriction, including without limitation
* the rights to use, copy, modify, merge, publish, distribute, sublicense,
* and/or sell copies of the Software, and to permit persons to whom the
* Software is furnished to do so, subject to the following conditions:

*
* The above copyright notice and this permission notice shall be included in
* all copies or substantial portions of the Software.

*
* THE SOFTWARE IS PROVIDED "AS IS", WITHOUT WARRANTY OF ANY KIND, EXPRESS OR
* IMPLIED, INCLUDING BUT NOT LIMITED TO THE WARRANTIES OF MERCHANTABILITY,
* FITNESS FOR A PARTICULAR PURPOSE AND NONINFRINGEMENT. IN NO EVENT SHALL THE
* AUTHORS OR COPYRIGHT HOLDERS BE LIABLE FOR ANY CLAIM, DAMAGES OR OTHER
* LIABILITY, WHETHER IN AN ACTION OF CONTRACT, TORT OR OTHERWISE, ARISING
* FROM, OUT OF OR IN CONNECTION WITH THE SOFTWARE OR THE USE OR OTHER DEALINGS
* IN THE SOFTWARE.

* Copyright 2004 Felix Kuehling
* All Rights Reserved.

*
* Permission is hereby granted, free of charge, to any person obtaining a
* copy of this software and associated documentation files (the "Software"),
* to deal in the Software without restriction, including without limitation
* the rights to use, copy, modify, merge, publish, distribute, sub license,

* and/or sell copies of the Software, and to permit persons to whom the
* Software is furnished to do so, subject to the following conditions:

*

* The above copyright notice and this permission notice (including the
* next paragraph) shall be included in all copies or substantial portions
* of the Software.

*

* THE SOFTWARE IS PROVIDED "AS IS", WITHOUT WARRANTY OF ANY KIND,
* EXPRESS OR IMPLIED, INCLUDING BUT NOT LIMITED TO THE WARRANTIES OF
* MERCHANTABILITY, FITNESS FOR A PARTICULAR PURPOSE AND
* NON-INFRINGEMENT. IN NO EVENT SHALL FELIX KUEHLING BE LIABLE FOR
* ANY CLAIM, DAMAGES OR OTHER LIABILITY, WHETHER IN AN ACTION OF
* CONTRACT, TORT OR OTHERWISE, ARISING FROM, OUT OF OR IN CONNECTION
* WITH THE SOFTWARE OR THE USE OR OTHER DEALINGS IN THE SOFTWARE.

* Copyright 2005 Eric Anholt

* All Rights Reserved.

*

* Permission is hereby granted, free of charge, to any person obtaining a
* copy of this software and associated documentation files (the "Software"),
* to deal in the Software without restriction, including without limitation
* the rights to use, copy, modify, merge, publish, distribute, sublicense,
* and/or sell copies of the Software, and to permit persons to whom the
* Software is furnished to do so, subject to the following conditions:

*

* The above copyright notice and this permission notice (including the next
* paragraph) shall be included in all copies or substantial portions of the
* Software.

*

* THE SOFTWARE IS PROVIDED "AS IS", WITHOUT WARRANTY OF ANY KIND, EXPRESS OR
* IMPLIED, INCLUDING BUT NOT LIMITED TO THE WARRANTIES OF MERCHANTABILITY,
* FITNESS FOR A PARTICULAR PURPOSE AND NON-INFRINGEMENT. IN NO EVENT SHALL
* THE AUTHORS OR COPYRIGHT HOLDERS BE LIABLE FOR ANY CLAIM, DAMAGES OR OTHER
* LIABILITY, WHETHER IN AN ACTION OF CONTRACT, TORT OR OTHERWISE, ARISING FROM,
* OUT OF OR IN CONNECTION WITH THE SOFTWARE OR THE USE OR OTHER DEALINGS IN THE
* SOFTWARE.

* Copyright © 2014–2015 Broadcom

*

* Permission is hereby granted, free of charge, to any person obtaining a
* copy of this software and associated documentation files (the "Software"),
* to deal in the Software without restriction, including without limitation
* the rights to use, copy, modify, merge, publish, distribute, sublicense,
* and/or sell copies of the Software, and to permit persons to whom the
* Software is furnished to do so, subject to the following conditions:

*

* The above copyright notice and this permission notice (including the next
* paragraph) shall be included in all copies or substantial portions of the
* Software.

*

* THE SOFTWARE IS PROVIDED "AS IS", WITHOUT WARRANTY OF ANY KIND, EXPRESS OR
* IMPLIED, INCLUDING BUT NOT LIMITED TO THE WARRANTIES OF MERCHANTABILITY,
* FITNESS FOR A PARTICULAR PURPOSE AND NONINFRINGEMENT. IN NO EVENT SHALL
* THE AUTHORS OR COPYRIGHT HOLDERS BE LIABLE FOR ANY CLAIM, DAMAGES OR OTHER
* LIABILITY, WHETHER IN AN ACTION OF CONTRACT, TORT OR OTHERWISE, ARISING
* FROM, OUT OF OR IN CONNECTION WITH THE SOFTWARE OR THE USE OR OTHER DEALINGS
* IN THE SOFTWARE.

* Copyright 2000 Precision Insight, Inc., Cedar Park, Texas.

* Copyright 2000 VA Linux Systems, Inc., Fremont, California.

* Copyright 2002 Tungsten Graphics, Inc., Cedar Park, Texas.

* Copyright 2014 Advanced Micro Devices, Inc.

*

* Permission is hereby granted, free of charge, to any person obtaining a
* copy of this software and associated documentation files (the "Software"),
* to deal in the Software without restriction, including without limitation
* the rights to use, copy, modify, merge, publish, distribute, sublicense,
* and/or sell copies of the Software, and to permit persons to whom the
* Software is furnished to do so, subject to the following conditions:

*

* The above copyright notice and this permission notice shall be included in
* all copies or substantial portions of the Software.

*

* THE SOFTWARE IS PROVIDED "AS IS", WITHOUT WARRANTY OF ANY KIND, EXPRESS OR
* IMPLIED, INCLUDING BUT NOT LIMITED TO THE WARRANTIES OF MERCHANTABILITY,
* FITNESS FOR A PARTICULAR PURPOSE AND NONINFRINGEMENT. IN NO EVENT SHALL
* THE COPYRIGHT HOLDER(S) OR AUTHOR(S) BE LIABLE FOR ANY CLAIM, DAMAGES OR
* OTHER LIABILITY, WHETHER IN AN ACTION OF CONTRACT, TORT OR OTHERWISE,
* ARISING FROM, OUT OF OR IN CONNECTION WITH THE SOFTWARE OR THE USE OR
* OTHER DEALINGS IN THE SOFTWARE.

* Copyright 2000 Precision Insight, Inc., Cedar Park, Texas.
* Copyright 2000 VA Linux Systems, Inc., Fremont, California.
* Copyright 2002 Tungsten Graphics, Inc., Cedar Park, Texas.
* All rights reserved.

*

* Permission is hereby granted, free of charge, to any person obtaining a
* copy of this software and associated documentation files (the "Software"),
* to deal in the Software without restriction, including without limitation
* the rights to use, copy, modify, merge, publish, distribute, sublicense,
* and/or sell copies of the Software, and to permit persons to whom the
* Software is furnished to do so, subject to the following conditions:

*

* The above copyright notice and this permission notice (including the next
* paragraph) shall be included in all copies or substantial portions of the
* Software.

*

* THE SOFTWARE IS PROVIDED "AS IS", WITHOUT WARRANTY OF ANY KIND, EXPRESS OR
* IMPLIED, INCLUDING BUT NOT LIMITED TO THE WARRANTIES OF MERCHANTABILITY,
* FITNESS FOR A PARTICULAR PURPOSE AND NONINFRINGEMENT. IN NO EVENT SHALL
* PRECISION INSIGHT AND/OR ITS SUPPLIERS BE LIABLE FOR ANY CLAIM, DAMAGES OR
* OTHER LIABILITY, WHETHER IN AN ACTION OF CONTRACT, TORT OR OTHERWISE,
* ARISING FROM, OUT OF OR IN CONNECTION WITH THE SOFTWARE OR THE USE OR OTHER
* DEALINGS IN THE SOFTWARE.

* Copyright 2005 Stephane Marchesin.
* All Rights Reserved.

*

* Permission is hereby granted, free of charge, to any person obtaining a

* copy of this software and associated documentation files (the "Software"),
* to deal in the Software without restriction, including without limitation
* the rights to use, copy, modify, merge, publish, distribute, sublicense,
* and/or sell copies of the Software, and to permit persons to whom the
* Software is furnished to do so, subject to the following conditions:

*
* The above copyright notice and this permission notice (including the next
* paragraph) shall be included in all copies or substantial portions of the
* Software.

*
* THE SOFTWARE IS PROVIDED "AS IS", WITHOUT WARRANTY OF ANY KIND, EXPRESS OR
* IMPLIED, INCLUDING BUT NOT LIMITED TO THE WARRANTIES OF MERCHANTABILITY,
* FITNESS FOR A PARTICULAR PURPOSE AND NONINFRINGEMENT. IN NO EVENT SHALL
* VA LINUX SYSTEMS AND/OR ITS SUPPLIERS BE LIABLE FOR ANY CLAIM, DAMAGES OR
* OTHER LIABILITY, WHETHER IN AN ACTION OF CONTRACT, TORT OR OTHERWISE,
* ARISING FROM, OUT OF OR IN CONNECTION WITH THE SOFTWARE OR THE USE OR
* OTHER DEALINGS IN THE SOFTWARE.

* Copyright © 2009–2015 VMware, Inc., Palo Alto, CA., USA
* All Rights Reserved.

*
* Permission is hereby granted, free of charge, to any person obtaining a
* copy of this software and associated documentation files (the
* "Software"), to deal in the Software without restriction, including
* without limitation the rights to use, copy, modify, merge, publish,
* distribute, sub license, and/or sell copies of the Software, and to
* permit persons to whom the Software is furnished to do so, subject to
* the following conditions:

*
* The above copyright notice and this permission notice (including the
* next paragraph) shall be included in all copies or substantial portions
* of the Software.

*
* THE SOFTWARE IS PROVIDED "AS IS", WITHOUT WARRANTY OF ANY KIND, EXPRESS OR
* IMPLIED, INCLUDING BUT NOT LIMITED TO THE WARRANTIES OF MERCHANTABILITY,
* FITNESS FOR A PARTICULAR PURPOSE AND NON-INFRINGEMENT. IN NO EVENT SHALL
* THE COPYRIGHT HOLDERS, AUTHORS AND/OR ITS SUPPLIERS BE LIABLE FOR ANY CLAIM,

* DAMAGES OR OTHER LIABILITY, WHETHER IN AN ACTION OF CONTRACT, TORT OR
* OTHERWISE, ARISING FROM, OUT OF OR IN CONNECTION WITH THE SOFTWARE OR THE
* USE OR OTHER DEALINGS IN THE SOFTWARE.

* Copyright (c) 2007–2008 Tungsten Graphics, Inc., Cedar Park, Texas.

* Copyright (c) 2007–2008 Dave Airlie <airlied@linux.ie>

* Copyright (c) 2007–2008 Jakob Bornecrantz <wallbraker@gmail.com>

*

* Permission is hereby granted, free of charge, to any person obtaining a
* copy of this software and associated documentation files (the "Software"),
* to deal in the Software without restriction, including without limitation
* the rights to use, copy, modify, merge, publish, distribute, sublicense,
* and/or sell copies of the Software, and to permit persons to whom the
* Software is furnished to do so, subject to the following conditions:

*

* The above copyright notice and this permission notice shall be included in
* all copies or substantial portions of the Software.

*

* THE SOFTWARE IS PROVIDED "AS IS", WITHOUT WARRANTY OF ANY KIND, EXPRESS OR
* IMPLIED, INCLUDING BUT NOT LIMITED TO THE WARRANTIES OF MERCHANTABILITY,
* FITNESS FOR A PARTICULAR PURPOSE AND NONINFRINGEMENT. IN NO EVENT SHALL THE
* AUTHORS OR COPYRIGHT HOLDERS BE LIABLE FOR ANY CLAIM, DAMAGES OR OTHER
* LIABILITY, WHETHER IN AN ACTION OF CONTRACT, TORT OR OTHERWISE, ARISING
* FROM, OUT OF OR IN CONNECTION WITH THE SOFTWARE OR THE USE OR OTHER DEALINGS
* IN THE SOFTWARE.

* Copyright (C) 1999 Wittawat Yamwong

*

* Permission is hereby granted, free of charge, to any person obtaining a
* copy of this software and associated documentation files (the "Software"),
* to deal in the Software without restriction, including without limitation
* the rights to use, copy, modify, merge, publish, distribute, sublicense,
* and/or sell copies of the Software, and to permit persons to whom the
* Software is furnished to do so, subject to the following conditions:

*

* The above copyright notice and this permission notice shall be included

* in all copies or substantial portions of the Software.

*

* THE SOFTWARE IS PROVIDED "AS IS", WITHOUT WARRANTY OF ANY KIND, EXPRESS
* OR IMPLIED, INCLUDING BUT NOT LIMITED TO THE WARRANTIES OF MERCHANTABILITY,
* FITNESS FOR A PARTICULAR PURPOSE AND NONINFRINGEMENT. IN NO EVENT SHALL
* WITTAWAT YAMWONG, OR ANY OTHER CONTRIBUTORS BE LIABLE FOR ANY CLAIM,
* DAMAGES OR OTHER LIABILITY, WHETHER IN AN ACTION OF CONTRACT, TORT OR
* OTHERWISE, ARISING FROM, OUT OF OR IN CONNECTION WITH THE SOFTWARE
* OR THE USE OR OTHER DEALINGS IN THE SOFTWARE.

* Copyright 2014 Advanced Micro Devices, Inc.

*

* Permission is hereby granted, free of charge, to any person obtaining a
* copy of this software and associated documentation files (the "Software"),
* to deal in the Software without restriction, including without limitation
* the rights to use, copy, modify, merge, publish, distribute, sublicense,
* and/or sell copies of the Software, and to permit persons to whom the
* Software is furnished to do so, subject to the following conditions:

*

* The above copyright notice and this permission notice shall be included in
* all copies or substantial portions of the Software.

*

* THE SOFTWARE IS PROVIDED "AS IS", WITHOUT WARRANTY OF ANY KIND, EXPRESS OR
* IMPLIED, INCLUDING BUT NOT LIMITED TO THE WARRANTIES OF MERCHANTABILITY,
* FITNESS FOR A PARTICULAR PURPOSE AND NONINFRINGEMENT. IN NO EVENT SHALL
* THE COPYRIGHT HOLDER(S) OR AUTHOR(S) BE LIABLE FOR ANY CLAIM, DAMAGES OR
* OTHER LIABILITY, WHETHER IN AN ACTION OF CONTRACT, TORT OR OTHERWISE,
* ARISING FROM, OUT OF OR IN CONNECTION WITH THE SOFTWARE OR THE USE OR
* OTHER DEALINGS IN THE SOFTWARE.

35.libjpeg

"this software is based in part on the work of the Independent JPEG Group."

36. libjpeg-turbo

this software is based in part on the work of the Independent JPEG Group.

* Copyright (C)2009–2016 D. R. Commander. All Rights Reserved.

*

* Redistribution and use in source and binary forms, with or without

* modification, are permitted provided that the following conditions are met:

*

* – Redistributions of source code must retain the above copyright notice,

* this list of conditions and the following disclaimer.

* – Redistributions in binary form must reproduce the above copyright notice,

* this list of conditions and the following disclaimer in the documentation

* and/or other materials provided with the distribution.

* – Neither the name of the libjpeg-turbo Project nor the names of its

* contributors may be used to endorse or promote products derived from this

* software without specific prior written permission.

*

* THIS SOFTWARE IS PROVIDED BY THE COPYRIGHT HOLDERS AND CONTRIBUTORS "AS IS",

* AND ANY EXPRESS OR IMPLIED WARRANTIES, INCLUDING, BUT NOT LIMITED TO, THE

* IMPLIED WARRANTIES OF MERCHANTABILITY AND FITNESS FOR A PARTICULAR PURPOSE

* ARE DISCLAIMED. IN NO EVENT SHALL THE COPYRIGHT HOLDERS OR CONTRIBUTORS BE

* LIABLE FOR ANY DIRECT, INDIRECT, INCIDENTAL, SPECIAL, EXEMPLARY, OR

* CONSEQUENTIAL DAMAGES (INCLUDING, BUT NOT LIMITED TO, PROCUREMENT OF

* SUBSTITUTE GOODS OR SERVICES; LOSS OF USE, DATA, OR PROFITS; OR BUSINESS

* INTERRUPTION) HOWEVER CAUSED AND ON ANY THEORY OF LIABILITY, WHETHER IN

* CONTRACT, STRICT LIABILITY, OR TORT (INCLUDING NEGLIGENCE OR OTHERWISE)

* ARISING IN ANY WAY OUT OF THE USE OF THIS SOFTWARE, EVEN IF ADVISED OF THE

* POSSIBILITY OF SUCH DAMAGE.

* /.

* Copyright (C)2011–2013 D. R. Commander. All Rights Reserved.

* Copyright (C)2015 Viktor Szathmáry. All Rights Reserved.

*

- * Redistribution and use in source and binary forms, with or without
- * modification, are permitted provided that the following conditions are met:
- *
- * – Redistributions of source code must retain the above copyright notice,
- * this list of conditions and the following disclaimer.
- * – Redistributions in binary form must reproduce the above copyright notice,
- * this list of conditions and the following disclaimer in the documentation
- * and/or other materials provided with the distribution.
- * – Neither the name of the libjpeg-turbo Project nor the names of its
- * contributors may be used to endorse or promote products derived from this
- * software without specific prior written permission.
- *
- * THIS SOFTWARE IS PROVIDED BY THE COPYRIGHT HOLDERS AND CONTRIBUTORS
- "AS IS",
- * AND ANY EXPRESS OR IMPLIED WARRANTIES, INCLUDING, BUT NOT LIMITED TO,
- THE
- * IMPLIED WARRANTIES OF MERCHANTABILITY AND FITNESS FOR A PARTICULAR
- PURPOSE

* ARE DISCLAIMED. IN NO EVENT SHALL THE COPYRIGHT HOLDERS OR CONTRIBUTORS BE

* LIABLE FOR ANY DIRECT, INDIRECT, INCIDENTAL, SPECIAL, EXEMPLARY, OR CONSEQUENTIAL DAMAGES (INCLUDING, BUT NOT LIMITED TO, PROCUREMENT OF SUBSTITUTE GOODS OR SERVICES; LOSS OF USE, DATA, OR PROFITS; OR BUSINESS INTERRUPTION) HOWEVER CAUSED AND ON ANY THEORY OF LIABILITY, WHETHER IN

* CONTRACT, STRICT LIABILITY, OR TORT (INCLUDING NEGLIGENCE OR OTHERWISE) ARISING IN ANY WAY OUT OF THE USE OF THIS SOFTWARE, EVEN IF ADVISED OF THE POSSIBILITY OF SUCH DAMAGE.

* Copyright (C)2009–2014, 2015, 2016 D. R. Commander. All Rights Reserved.

*

* Redistribution and use in source and binary forms, with or without modification, are permitted provided that the following conditions are met:

*

- * – Redistributions of source code must retain the above copyright notice,
- * this list of conditions and the following disclaimer.
- * – Redistributions in binary form must reproduce the above copyright notice,

* this list of conditions and the following disclaimer in the documentation

* and/or other materials provided with the distribution.

* – Neither the name of the libjpeg–turbo Project nor the names of its

* contributors may be used to endorse or promote products derived from this

* software without specific prior written permission.

*

* THIS SOFTWARE IS PROVIDED BY THE COPYRIGHT HOLDERS AND CONTRIBUTORS

"AS IS",

* AND ANY EXPRESS OR IMPLIED WARRANTIES, INCLUDING, BUT NOT LIMITED TO,

THE

* IMPLIED WARRANTIES OF MERCHANTABILITY AND FITNESS FOR A PARTICULAR

PURPOSE

* ARE DISCLAIMED. IN NO EVENT SHALL THE COPYRIGHT HOLDERS OR

CONTRIBUTORS BE

* LIABLE FOR ANY DIRECT, INDIRECT, INCIDENTAL, SPECIAL, EXEMPLARY, OR

* CONSEQUENTIAL DAMAGES (INCLUDING, BUT NOT LIMITED TO, PROCUREMENT OF

* SUBSTITUTE GOODS OR SERVICES; LOSS OF USE, DATA, OR PROFITS; OR BUSINESS

* INTERRUPTION) HOWEVER CAUSED AND ON ANY THEORY OF LIABILITY, WHETHER

IN

* CONTRACT, STRICT LIABILITY, OR TORT (INCLUDING NEGLIGENCE OR OTHERWISE)
* ARISING IN ANY WAY OUT OF THE USE OF THIS SOFTWARE, EVEN IF ADVISED OF THE
* POSSIBILITY OF SUCH DAMAGE.

* Copyright (C)2011–2015 D. R. Commander. All Rights Reserved.

* Copyright (C)2015 Viktor Szathmáry. All Rights Reserved.

*

* Redistribution and use in source and binary forms, with or without
* modification, are permitted provided that the following conditions are met:

*

* – Redistributions of source code must retain the above copyright notice,
* this list of conditions and the following disclaimer.
* – Redistributions in binary form must reproduce the above copyright notice,
* this list of conditions and the following disclaimer in the documentation
* and/or other materials provided with the distribution.

* – Neither the name of the libjpeg-turbo Project nor the names of its
* contributors may be used to endorse or promote products derived from this
* software without specific prior written permission.

*

* THIS SOFTWARE IS PROVIDED BY THE COPYRIGHT HOLDERS AND CONTRIBUTORS
"AS IS",
* AND ANY EXPRESS OR IMPLIED WARRANTIES, INCLUDING, BUT NOT LIMITED TO,
THE
* IMPLIED WARRANTIES OF MERCHANTABILITY AND FITNESS FOR A PARTICULAR
PURPOSE
* ARE DISCLAIMED. IN NO EVENT SHALL THE COPYRIGHT HOLDERS OR
CONTRIBUTORS BE
* LIABLE FOR ANY DIRECT, INDIRECT, INCIDENTAL, SPECIAL, EXEMPLARY, OR
* CONSEQUENTIAL DAMAGES (INCLUDING, BUT NOT LIMITED TO, PROCUREMENT OF
* SUBSTITUTE GOODS OR SERVICES; LOSS OF USE, DATA, OR PROFITS; OR BUSINESS
* INTERRUPTION) HOWEVER CAUSED AND ON ANY THEORY OF LIABILITY, WHETHER
IN
* CONTRACT, STRICT LIABILITY, OR TORT (INCLUDING NEGLIGENCE OR OTHERWISE)
* ARISING IN ANY WAY OUT OF THE USE OF THIS SOFTWARE, EVEN IF ADVISED OF THE
* POSSIBILITY OF SUCH DAMAGE.

* Copyright (C)2015 Viktor Szathmáry. All Rights Reserved.

*

- * Redistribution and use in source and binary forms, with or without
- * modification, are permitted provided that the following conditions are met:
- *
- * – Redistributions of source code must retain the above copyright notice,
- * this list of conditions and the following disclaimer.
- * – Redistributions in binary form must reproduce the above copyright notice,
- * this list of conditions and the following disclaimer in the documentation
- * and/or other materials provided with the distribution.
- * – Neither the name of the libjpeg-turbo Project nor the names of its
- * contributors may be used to endorse or promote products derived from this
- * software without specific prior written permission.
- *
- * THIS SOFTWARE IS PROVIDED BY THE COPYRIGHT HOLDERS AND CONTRIBUTORS
- "AS IS",
- * AND ANY EXPRESS OR IMPLIED WARRANTIES, INCLUDING, BUT NOT LIMITED TO,
- THE
- * IMPLIED WARRANTIES OF MERCHANTABILITY AND FITNESS FOR A PARTICULAR
- PURPOSE

* ARE DISCLAIMED. IN NO EVENT SHALL THE COPYRIGHT HOLDERS OR
CONTRIBUTORS BE
* LIABLE FOR ANY DIRECT, INDIRECT, INCIDENTAL, SPECIAL, EXEMPLARY, OR
* CONSEQUENTIAL DAMAGES (INCLUDING, BUT NOT LIMITED TO, PROCUREMENT OF
* SUBSTITUTE GOODS OR SERVICES; LOSS OF USE, DATA, OR PROFITS; OR BUSINESS
* INTERRUPTION) HOWEVER CAUSED AND ON ANY THEORY OF LIABILITY, WHETHER
IN
* CONTRACT, STRICT LIABILITY, OR TORT (INCLUDING NEGLIGENCE OR OTHERWISE)
* ARISING IN ANY WAY OUT OF THE USE OF THIS SOFTWARE, EVEN IF ADVISED OF THE
* POSSIBILITY OF SUCH DAMAGE.

** Copyright (C) 1988, 1989 by Jef Poskanzer.

**

** Permission to use, copy, modify, and distribute this software and its
** documentation for any purpose and without fee is hereby granted, provided
** that the above copyright notice appear in all copies and that both that
** copyright notice and this permission notice appear in supporting
** documentation. This software is provided "as is" without express or
** implied warranty.

37.libpcap

License: BSD

Redistribution and use in source and binary forms, with or without modification, are permitted provided that the following conditions are met:

1. Redistributions of source code must retain the above copyright notice, this list of conditions and the following disclaimer.
2. Redistributions in binary form must reproduce the above copyright notice, this list of conditions and the following disclaimer in the documentation and/or other materials provided with the distribution.
3. The names of the authors may not be used to endorse or promote products derived from this software without specific prior written permission.

THIS SOFTWARE IS PROVIDED BY THE COPYRIGHT HOLDERS AND CONTRIBUTORS "AS IS" AND ANY EXPRESS OR IMPLIED WARRANTIES, INCLUDING, BUT NOT LIMITED TO,

THE IMPLIED WARRANTIES OF MERCHANTABILITY AND FITNESS FOR A PARTICULAR PURPOSE ARE DISCLAIMED. IN NO EVENT SHALL THE COPYRIGHT HOLDER OR CONTRIBUTORS BE LIABLE FOR ANY DIRECT, INDIRECT, INCIDENTAL, SPECIAL, EXEMPLARY, OR CONSEQUENTIAL DAMAGES (INCLUDING, BUT NOT LIMITED TO, PROCUREMENT OF SUBSTITUTE GOODS OR SERVICES; LOSS OF USE, DATA, OR PROFITS; OR BUSINESS INTERRUPTION) HOWEVER CAUSED AND ON ANY THEORY OF LIABILITY, WHETHER IN CONTRACT, STRICT LIABILITY, OR TORT (INCLUDING NEGLIGENCE OR OTHERWISE) ARISING IN ANY WAY OUT OF THE USE OF THIS SOFTWARE, EVEN IF ADVISED OF THE POSSIBILITY OF SUCH DAMAGE.

38.libpng

* If you modify libpng you may insert additional notices immediately following
* this sentence.

*

* libpng versions 1.0.7, July 1, 2000, through 1.2.5, October 3, 2002, are

* Copyright (c) 2000–2002 Glenn Randers-Pehrson, and are

* distributed according to the same disclaimer and license as libpng-1.0.6

* with the following individuals added to the list of Contributing Authors

*

* Simon-Pierre Cadieux

* Eric S. Raymond

* Gilles Vollant

*

* and with the following additions to the disclaimer:

*

* There is no warranty against interference with your enjoyment of the

* library or against infringement. There is no warranty that our

* efforts or the library will fulfill any of your particular purposes

* or needs. This library is provided with all faults, and the entire
* risk of satisfactory quality, performance, accuracy, and effort is with
* the user.

*

* libpng versions 0.97, January 1998, through 1.0.6, March 20, 2000, are

* Copyright (c) 1998, 1999, 2000 Glenn Randers-Pehrson

* Distributed according to the same disclaimer and license as libpng-0.96,

* with the following individuals added to the list of Contributing Authors:

*

* Tom Lane

* Glenn Randers-Pehrson

* Willem van Schaik

*

* libpng versions 0.89, June 1996, through 0.96, May 1997, are

* Copyright (c) 1996, 1997 Andreas Dilger

* Distributed according to the same disclaimer and license as libpng-0.88,

* with the following individuals added to the list of Contributing Authors:

*

* John Bowler

* Kevin Bracey

* Sam Bushell

* Magnus Holmgren

* Greg Roelofs

* Tom Tanner

*

* libpng versions 0.5, May 1995, through 0.88, January 1996, are

* Copyright (c) 1995, 1996 Guy Eric Schalnat, Group 42, Inc.

*

* For the purposes of this copyright and license, "Contributing Authors"

* is defined as the following set of individuals:

*

* Andreas Dilger

* Dave Martindale

* Guy Eric Schalnat

* Paul Schmidt

* Tim Wegner

*

* The PNG Reference Library is supplied "AS IS". The Contributing Authors

* and Group 42, Inc. disclaim all warranties, expressed or implied,
* including, without limitation, the warranties of merchantability and of
* fitness for any purpose. The Contributing Authors and Group 42, Inc.
* assume no liability for direct, indirect, incidental, special, exemplary,
* or consequential damages, which may result from the use of the PNG
* Reference Library, even if advised of the possibility of such damage.

*

* Permission is hereby granted to use, copy, modify, and distribute this
* source code, or portions hereof, for any purpose, without fee, subject
* to the following restrictions:

*

* 1. The origin of this source code must not be misrepresented.

*

* 2. Altered versions must be plainly marked as such and
* must not be misrepresented as being the original source.

*

* 3. This Copyright notice may not be removed or altered from
* any source or altered source distribution.

*

* The Contributing Authors and Group 42, Inc. specifically permit, without
* fee, and encourage the use of this source code as a component to
* supporting the PNG file format in commercial products. If you use this
* source code in a product, acknowledgment is not required but would be
* appreciated.

39.libtiff

Copyright (c) 1988–1997 Sam Leffler

Copyright (c) 1991–1997 Silicon Graphics, Inc.

Permission to use, copy, modify, distribute, and sell this software and its documentation for any purpose is hereby granted without fee, provided that (i) the above copyright notices and this permission notice appear in all copies of the software and related documentation, and (ii) the names of Sam Leffler and Silicon Graphics may not be used in any advertising or publicity relating to the software without the specific, prior written permission of Sam Leffler and Silicon Graphics.

THE SOFTWARE IS PROVIDED "AS-IS" AND WITHOUT WARRANTY OF ANY KIND, EXPRESS, IMPLIED OR OTHERWISE, INCLUDING WITHOUT LIMITATION, ANY WARRANTY OF MERCHANTABILITY OR FITNESS FOR A PARTICULAR PURPOSE.

IN NO EVENT SHALL SAM LEFFLER OR SILICON GRAPHICS BE LIABLE FOR ANY SPECIAL, INCIDENTAL, INDIRECT OR CONSEQUENTIAL DAMAGES OF ANY KIND,

OR ANY DAMAGES WHATSOEVER RESULTING FROM LOSS OF USE, DATA OR PROFITS,
WHETHER OR NOT ADVISED OF THE POSSIBILITY OF DAMAGE, AND ON ANY THEORY
OF
LIABILITY, ARISING OUT OF OR IN CONNECTION WITH THE USE OR PERFORMANCE
OF THIS SOFTWARE.

40.libxml2

Copyright (C) 1998–2003 Daniel Veillard. All Rights Reserved.

Permission is hereby granted, free of charge, to any person obtaining a copy of this software and associated documentation files (the "Software"), to deal in the Software without restriction, including without limitation the rights to use, copy, modify, merge, publish, distribute, sublicense, and/or sell copies of the Software, and to permit persons to whom the Software is furnished to do so, subject to the following conditions:

The above copyright notice and this permission notice shall be included in all copies or substantial portions of the Software.

THE SOFTWARE IS PROVIDED "AS IS", WITHOUT WARRANTY OF ANY KIND, EXPRESS OR IMPLIED, INCLUDING BUT NOT LIMITED TO THE WARRANTIES OF MERCHANTABILITY, FITNESS FOR A PARTICULAR PURPOSE AND NONINFRINGEMENT. IN NO EVENT SHALL THE

DANIEL VEILLARD BE LIABLE FOR ANY CLAIM, DAMAGES OR OTHER LIABILITY,
WHETHER
IN AN ACTION OF CONTRACT, TORT OR OTHERWISE, ARISING FROM, OUT OF OR IN
CON-
NECTION WITH THE SOFTWARE OR THE USE OR OTHER DEALINGS IN THE SOFTWARE.

Except as contained in this notice, the name of Daniel Veillard shall not
be used in advertising or otherwise to promote the sale, use or other deal-
ings in this Software without prior written authorization from him.

41 .libXrandr

Copyright (c) 2000, Compaq Computer Corporation,

Copyright (c) 2002, Hewlett Packard, Inc.

Permission to use, copy, modify, distribute, and sell this software and its documentation for any purpose is hereby granted without fee, provided that the above copyright notice appear in all copies and that both that copyright notice and this permission notice appear in supporting documentation, and that the name of Compaq or HP not be used in advertising or publicity pertaining to distribution of the software without specific, written prior permission. HP makes no representations about the suitability of this software for any purpose. It is provided "as is" without express or implied warranty.

HP DISCLAIMS ALL WARRANTIES WITH REGARD TO THIS SOFTWARE, INCLUDING ALL IMPLIED WARRANTIES OF MERCHANTABILITY AND FITNESS, IN NO EVENT SHALL HP BE LIABLE FOR ANY SPECIAL, INDIRECT OR CONSEQUENTIAL DAMAGES OR ANY DAMAGES

WHATSOEVER RESULTING FROM LOSS OF USE, DATA OR PROFITS, WHETHER IN AN ACTION

OF CONTRACT, NEGLIGENCE OR OTHER TORTIOUS ACTION, ARISING OUT OF OR IN CONNECTION WITH THE USE OR PERFORMANCE OF THIS SOFTWARE.

Copyright (c) 2000 Compaq Computer Corporation, Inc.

Copyright (c) 2002 Hewlett-Packard Company, Inc.

Copyright (c) 2006 Intel Corporation

Copyright (c) 2008 Red Hat, Inc.

Permission to use, copy, modify, distribute, and sell this software and its documentation for any purpose is hereby granted without fee, provided that the above copyright notice appear in all copies and that both that copyright notice and this permission notice appear in supporting documentation, and that the name of the copyright holders not be used in advertising or publicity pertaining to distribution of the software without specific, written prior permission. The copyright holders make no representations about the suitability of this software for any purpose. It is provided "as is" without express or implied warranty.

THE COPYRIGHT HOLDERS DISCLAIM ALL WARRANTIES WITH REGARD TO THIS SOFTWARE, INCLUDING ALL IMPLIED WARRANTIES OF MERCHANTABILITY AND FITNESS, IN NO EVENT SHALL THE COPYRIGHT HOLDERS BE LIABLE FOR ANY SPECIAL, INDIRECT OR CONSEQUENTIAL DAMAGES OR ANY DAMAGES WHATSOEVER RESULTING FROM LOSS OF USE, DATA OR PROFITS, WHETHER IN AN ACTION OF CONTRACT, NEGLIGENCE OR OTHER TORTIOUS ACTION, ARISING OUT OF OR IN CONNECTION WITH THE USE OR PERFORMANCE OF THIS SOFTWARE.

Copyright (c) 2000 Compaq Computer Corporation, Inc.

Copyright (c) 2002 Hewlett Packard Company, Inc.

Copyright (c) 2006 Keith Packard

Permission to use, copy, modify, distribute, and sell this software and its documentation for any purpose is hereby granted without fee, provided that the above copyright notice appear in all copies and that both that copyright

notice and this permission notice appear in supporting documentation, and that the name of the copyright holders not be used in advertising or publicity pertaining to distribution of the software without specific, written prior permission. The copyright holders make no representations about the suitability of this software for any purpose. It is provided "as is" without express or implied warranty.

THE COPYRIGHT HOLDERS DISCLAIM ALL WARRANTIES WITH REGARD TO THIS SOFTWARE, INCLUDING ALL IMPLIED WARRANTIES OF MERCHANTABILITY AND FITNESS, IN NO EVENT SHALL THE COPYRIGHT HOLDERS BE LIABLE FOR ANY SPECIAL, INDIRECT OR CONSEQUENTIAL DAMAGES OR ANY DAMAGES WHATSOEVER RESULTING FROM LOSS OF USE, DATA OR PROFITS, WHETHER IN AN ACTION OF CONTRACT, NEGLIGENCE OR OTHER TORTIOUS ACTION, ARISING OUT OF OR IN CONNECTION WITH THE USE OR PERFORMANCE OF THIS SOFTWARE.

42.[memcached](#)

Copyright (c) 2003, Danga Interactive, Inc.

All rights reserved.

Redistribution and use in source and binary forms, with or without modification, are permitted provided that the following conditions are met:

- * Redistributions of source code must retain the above copyright notice, this list of conditions and the following disclaimer.

- * Redistributions in binary form must reproduce the above copyright notice, this list of conditions and the following disclaimer in the documentation and/or other materials provided with the distribution.

- * Neither the name of the Danga Interactive nor the names of its contributors may be used to endorse or promote products derived from this software without specific prior written permission.

THIS SOFTWARE IS PROVIDED BY THE COPYRIGHT HOLDERS AND CONTRIBUTORS "AS IS" AND ANY EXPRESS OR IMPLIED WARRANTIES, INCLUDING, BUT NOT LIMITED TO, THE IMPLIED WARRANTIES OF MERCHANTABILITY AND FITNESS FOR A PARTICULAR PURPOSE ARE DISCLAIMED. IN NO EVENT SHALL THE COPYRIGHT OWNER OR CONTRIBUTORS BE LIABLE FOR ANY DIRECT, INDIRECT, INCIDENTAL, SPECIAL, EXEMPLARY, OR CONSEQUENTIAL DAMAGES (INCLUDING, BUT NOT LIMITED TO, PROCUREMENT OF SUBSTITUTE GOODS OR SERVICES; LOSS OF USE, DATA, OR PROFITS; OR BUSINESS INTERRUPTION) HOWEVER CAUSED AND ON ANY THEORY OF LIABILITY, WHETHER IN CONTRACT, STRICT LIABILITY, OR TORT (INCLUDING NEGLIGENCE OR OTHERWISE) ARISING IN ANY WAY OUT OF THE USE OF THIS SOFTWARE, EVEN IF ADVISED OF THE POSSIBILITY OF SUCH DAMAGE.

43. Mesa

Mesa 3-D graphics library

Copyright (C) 1999-2007 Brian Paul All Rights Reserved.

Permission is hereby granted, free of charge, to any person obtaining a copy of this software and associated documentation files (the "Software"), to deal in the Software without restriction, including without limitation the rights to use, copy, modify, merge, publish, distribute, sublicense, and/or sell copies of the Software, and to permit persons to whom the Software is furnished to do so, subject to the following conditions:

The above copyright notice and this permission notice shall be included in all copies or substantial portions of the Software.

THE SOFTWARE IS PROVIDED "AS IS", WITHOUT WARRANTY OF ANY KIND, EXPRESS OR IMPLIED, INCLUDING BUT NOT LIMITED TO THE WARRANTIES OF MERCHANTABILITY,

FITNESS FOR A PARTICULAR PURPOSE AND NONINFRINGEMENT. IN NO EVENT SHALL THE AUTHORS OR COPYRIGHT HOLDERS BE LIABLE FOR ANY CLAIM, DAMAGES OR OTHER LIABILITY, WHETHER IN AN ACTION OF CONTRACT, TORT OR OTHERWISE, ARISING FROM, OUT OF OR IN CONNECTION WITH THE SOFTWARE OR THE USE OR OTHER DEALINGS IN THE SOFTWARE.

* Copyright 2003 VMware, Inc.

* All Rights Reserved.

*

* Permission is hereby granted, free of charge, to any person obtaining a

* copy of this software and associated documentation files (the

* "Software"), to deal in the Software without restriction, including

* without limitation the rights to use, copy, modify, merge, publish,

* distribute, sub license, and/or sell copies of the Software, and to

* permit persons to whom the Software is furnished to do so, subject to

* the following conditions:

*

* The above copyright notice and this permission notice (including the

* next paragraph) shall be included in all copies or substantial portions

* of the Software.

*

* THE SOFTWARE IS PROVIDED "AS IS", WITHOUT WARRANTY OF ANY KIND, EXPRESS

* OR IMPLIED, INCLUDING BUT NOT LIMITED TO THE WARRANTIES OF

* MERCHANTABILITY, FITNESS FOR A PARTICULAR PURPOSE AND

NON-INFRINGEMENT.

* IN NO EVENT SHALL VMWARE AND/OR ITS SUPPLIERS BE LIABLE FOR

* ANY CLAIM, DAMAGES OR OTHER LIABILITY, WHETHER IN AN ACTION OF

CONTRACT,

* TORT OR OTHERWISE, ARISING FROM, OUT OF OR IN CONNECTION WITH THE

* SOFTWARE OR THE USE OR OTHER DEALINGS IN THE SOFTWARE.

/*

Copyright (C) Intel Corp. 2006. All Rights Reserved.

Intel funded Tungsten Graphics to

develop this 3D driver.

Permission is hereby granted, free of charge, to any person obtaining a copy of this software and associated documentation files (the "Software"), to deal in the Software without restriction, including without limitation the rights to use, copy, modify, merge, publish, distribute, sublicense, and/or sell copies of the Software, and to permit persons to whom the Software is furnished to do so, subject to the following conditions:

The above copyright notice and this permission notice (including the next paragraph) shall be included in all copies or substantial portions of the Software.

THE SOFTWARE IS PROVIDED "AS IS", WITHOUT WARRANTY OF ANY KIND, EXPRESS OR IMPLIED, INCLUDING BUT NOT LIMITED TO THE WARRANTIES OF MERCHANTABILITY, FITNESS FOR A PARTICULAR PURPOSE AND NONINFRINGEMENT. IN NO EVENT SHALL THE COPYRIGHT OWNER(S) AND/OR ITS SUPPLIERS BE LIABLE FOR ANY CLAIM, DAMAGES OR OTHER LIABILITY, WHETHER IN AN ACTION

OF CONTRACT, TORT OR OTHERWISE, ARISING FROM, OUT OF OR IN CONNECTION WITH THE SOFTWARE OR THE USE OR OTHER DEALINGS IN THE SOFTWARE.

/*

** Copyright (c) 2013–2014 The Khronos Group Inc.

**

** Permission is hereby granted, free of charge, to any person obtaining a

** copy of this software and/or associated documentation files (the

** "Materials"), to deal in the Materials without restriction, including

** without limitation the rights to use, copy, modify, merge, publish,

** distribute, sublicense, and/or sell copies of the Materials, and to

** permit persons to whom the Materials are furnished to do so, subject to

** the following conditions:

**

** The above copyright notice and this permission notice shall be included

** in all copies or substantial portions of the Materials.

**

** THE MATERIALS ARE PROVIDED "AS IS", WITHOUT WARRANTY OF ANY KIND,

** EXPRESS OR IMPLIED, INCLUDING BUT NOT LIMITED TO THE WARRANTIES OF

** MERCHANTABILITY, FITNESS FOR A PARTICULAR PURPOSE AND
NONINFRINGEMENT.

** IN NO EVENT SHALL THE AUTHORS OR COPYRIGHT HOLDERS BE LIABLE FOR ANY
** CLAIM, DAMAGES OR OTHER LIABILITY, WHETHER IN AN ACTION OF CONTRACT,
** TORT OR OTHERWISE, ARISING FROM, OUT OF OR IN CONNECTION WITH THE
** MATERIALS OR THE USE OR OTHER DEALINGS IN THE MATERIALS.

*/

/*

* SGI FREE SOFTWARE LICENSE B (Version 2.0, Sept. 18, 2008)

* Copyright (C) 1991–2000 Silicon Graphics, Inc. All Rights Reserved.

*

* Permission is hereby granted, free of charge, to any person obtaining a
* copy of this software and associated documentation files (the "Software"),
* to deal in the Software without restriction, including without limitation
* the rights to use, copy, modify, merge, publish, distribute, sublicense,
* and/or sell copies of the Software, and to permit persons to whom the
* Software is furnished to do so, subject to the following conditions:

*

- * The above copyright notice including the dates of first publication and
- * either this permission notice or a reference to
- * <http://oss.sgi.com/projects/FreeB/>
- * shall be included in all copies or substantial portions of the Software.
- *
* THE SOFTWARE IS PROVIDED "AS IS", WITHOUT WARRANTY OF ANY KIND, EXPRESS
- * OR IMPLIED, INCLUDING BUT NOT LIMITED TO THE WARRANTIES OF
- MERCHANTABILITY,
- * FITNESS FOR A PARTICULAR PURPOSE AND NONINFRINGEMENT. IN NO EVENT
- SHALL
- * SILICON GRAPHICS, INC. BE LIABLE FOR ANY CLAIM, DAMAGES OR OTHER LIABILITY,
- * WHETHER IN AN ACTION OF CONTRACT, TORT OR OTHERWISE, ARISING FROM,
- OUT OF
- * OR IN CONNECTION WITH THE SOFTWARE OR THE USE OR OTHER DEALINGS IN THE
- * SOFTWARE.
- *
* Except as contained in this notice, the name of Silicon Graphics, Inc.
- * shall not be used in advertising or otherwise to promote the sale, use or
- * other dealings in this Software without prior written authorization from

* Silicon Graphics, Inc.

*/

* (C) Copyright yohhoy 2012.

* Distributed under the Boost Software License, Version 1.0.

*

* Permission is hereby granted, free of charge, to any person or organization

* obtaining a copy of the software and accompanying documentation covered by

* this license (the "Software") to use, reproduce, display, distribute,

* execute, and transmit the Software, and to prepare [[derivative work]]s of the

* Software, and to permit third-parties to whom the Software is furnished to

* do so, all subject to the following:

*

* The copyright notices in the Software and this entire statement, including

* the above license grant, this restriction and the following disclaimer,

* must be included in all copies of the Software, in whole or in part, and

* all derivative works of the Software, unless such copies or derivative

* works are solely in the form of machine-executable object code generated by

* a source language processor.

*

* THE SOFTWARE IS PROVIDED "AS IS", WITHOUT WARRANTY OF ANY KIND, EXPRESS

OR

* IMPLIED, INCLUDING BUT NOT LIMITED TO THE WARRANTIES OF

MERCHANTABILITY,

* FITNESS FOR A PARTICULAR PURPOSE, TITLE AND NON-INFRINGEMENT. IN NO

EVENT

* SHALL THE COPYRIGHT HOLDERS OR ANYONE DISTRIBUTING THE SOFTWARE BE

LIABLE

* FOR ANY DAMAGES OR OTHER LIABILITY, WHETHER IN CONTRACT, TORT OR

OTHERWISE,

* ARISING FROM, OUT OF OR IN CONNECTION WITH THE SOFTWARE OR THE USE OR

OTHER

* DEALINGS IN THE SOFTWARE.

44.MSTLIB

Copyright (c) 1994, 1997, 2001, 2002 Red Hat Incorporated.

All rights reserved.

Redistribution and use in source and binary forms, with or without modification, are permitted provided that the following conditions are met:

Redistributions of source code must retain the above copyright notice, this list of conditions and the following disclaimer.

Redistributions in binary form must reproduce the above copyright notice, this list of conditions and the following disclaimer in the documentation and/or other materials provided with the distribution.

The name of Red Hat Incorporated may not be used to endorse or promote products derived from this software without specific prior written permission.

THIS SOFTWARE IS PROVIDED BY THE COPYRIGHT HOLDERS AND CONTRIBUTORS "AS IS"

AND ANY EXPRESS OR IMPLIED WARRANTIES, INCLUDING, BUT NOT LIMITED TO, THE

IMPLIED WARRANTIES OF MERCHANTABILITY AND FITNESS FOR A PARTICULAR PURPOSE ARE
DISCLAIMED. IN NO EVENT SHALL RED HAT INCORPORATED BE LIABLE FOR ANY DIRECT, INDIRECT, INCIDENTAL, SPECIAL, EXEMPLARY, OR CONSEQUENTIAL DAMAGES
(INCLUDING, BUT NOT LIMITED TO, PROCUREMENT OF SUBSTITUTE GOODS OR SERVICES;
LOSS OF USE, DATA, OR PROFITS; OR BUSINESS INTERRUPTION) HOWEVER CAUSED AND
ON ANY THEORY OF LIABILITY, WHETHER IN CONTRACT, STRICT LIABILITY, OR TORT (INCLUDING NEGLIGENCE OR OTHERWISE) ARISING IN ANY WAY OUT OF THE USE OF THIS SOFTWARE, EVEN IF ADVISED OF THE POSSIBILITY OF SUCH DAMAGE.

Copyright (c) 1990 The Regents of the University of California.

All rights reserved.

Redistribution and use in source and binary forms are permitted provided that the above copyright notice and this paragraph are

duplicated in all such forms and that any documentation, advertising materials, and other materials related to such distribution and use acknowledge that the software was developed by the University of California, Berkeley. The name of the University may not be used to endorse or promote products derived from this software without specific prior written permission.

THIS SOFTWARE IS PROVIDED ``AS IS" AND WITHOUT ANY EXPRESS OR IMPLIED WARRANTIES, INCLUDING, WITHOUT LIMITATION, THE IMPLIED WARRANTIES OF MERCHANTABILITY AND FITNESS FOR A PARTICULAR PURPOSE.

45.Net-SNMP

Various copyrights apply to this package, listed in various separate parts below. Please make sure that you read all the parts.

----- Part 1: CMU/UCD copyright notice: (BSD like) -----

Copyright 1989, 1991, 1992 by Carnegie Mellon University

Derivative Work - 1996, 1998-2000

Copyright 1996, 1998-2000 The Regents of the University of California

All Rights Reserved

Permission to use, copy, modify and distribute this software and its documentation for any purpose and without fee is hereby granted, provided that the above copyright notice appears in all copies and that both that copyright notice and this permission notice appear in

supporting documentation, and that the name of CMU and The Regents of the University of California not be used in advertising or publicity pertaining to distribution of the software without specific written permission.

CMU AND THE REGENTS OF THE UNIVERSITY OF CALIFORNIA DISCLAIM ALL WARRANTIES WITH REGARD TO THIS SOFTWARE, INCLUDING ALL IMPLIED WARRANTIES OF MERCHANTABILITY AND FITNESS. IN NO EVENT SHALL CMU OR THE REGENTS OF THE UNIVERSITY OF CALIFORNIA BE LIABLE FOR ANY SPECIAL, INDIRECT OR CONSEQUENTIAL DAMAGES OR ANY DAMAGES WHATSOEVER RESULTING FROM THE LOSS OF USE, DATA OR PROFITS, WHETHER IN AN ACTION OF CONTRACT, NEGLIGENCE OR OTHER TORTIOUS ACTION, ARISING OUT OF OR IN CONNECTION WITH THE USE OR PERFORMANCE OF THIS SOFTWARE.

----- Part 2: Networks Associates Technology, Inc copyright notice (BSD) -----

Copyright (c) 2001–2003, Networks Associates Technology, Inc

All rights reserved.

Redistribution and use in source and binary forms, with or without modification, are permitted provided that the following conditions are met:

- * Redistributions of source code must retain the above copyright notice, this list of conditions and the following disclaimer.

- * Redistributions in binary form must reproduce the above copyright notice, this list of conditions and the following disclaimer in the documentation and/or other materials provided with the distribution.

- * Neither the name of the Networks Associates Technology, Inc nor the names of its contributors may be used to endorse or promote products derived from this software without specific prior written permission.

THIS SOFTWARE IS PROVIDED BY THE COPYRIGHT HOLDERS AND CONTRIBUTORS

``AS

IS" AND ANY EXPRESS OR IMPLIED WARRANTIES, INCLUDING, BUT NOT LIMITED TO, THE IMPLIED WARRANTIES OF MERCHANTABILITY AND FITNESS FOR A PARTICULAR PURPOSE ARE DISCLAIMED. IN NO EVENT SHALL THE COPYRIGHT HOLDERS OR CONTRIBUTORS BE LIABLE FOR ANY DIRECT, INDIRECT, INCIDENTAL, SPECIAL, EXEMPLARY, OR CONSEQUENTIAL DAMAGES (INCLUDING, BUT NOT LIMITED TO, PROCUREMENT OF SUBSTITUTE GOODS OR SERVICES; LOSS OF USE, DATA, OR PROFITS; OR BUSINESS INTERRUPTION) HOWEVER CAUSED AND ON ANY THEORY OF LIABILITY, WHETHER IN CONTRACT, STRICT LIABILITY, OR TORT (INCLUDING NEGLIGENCE OR OTHERWISE) ARISING IN ANY WAY OUT OF THE USE OF THIS SOFTWARE, EVEN IF ADVISED OF THE POSSIBILITY OF SUCH DAMAGE.

----- Part 3: Cambridge Broadband Ltd. copyright notice (BSD) -----

Portions of this code are copyright (c) 2001–2003, Cambridge Broadband Ltd.

All rights reserved.

Redistribution and use in source and binary forms, with or without

modification, are permitted provided that the following conditions are met:

- * Redistributions of source code must retain the above copyright notice, this list of conditions and the following disclaimer.

- * Redistributions in binary form must reproduce the above copyright notice, this list of conditions and the following disclaimer in the documentation and/or other materials provided with the distribution.

- * The name of Cambridge Broadband Ltd. may not be used to endorse or promote products derived from this software without specific prior written permission.

THIS SOFTWARE IS PROVIDED BY THE COPYRIGHT HOLDER "AS IS" AND ANY EXPRESS OR IMPLIED WARRANTIES, INCLUDING, BUT NOT LIMITED TO, THE IMPLIED WARRANTIES OF MERCHANTABILITY AND FITNESS FOR A PARTICULAR PURPOSE ARE DISCLAIMED. IN NO EVENT SHALL THE COPYRIGHT HOLDER BE LIABLE FOR ANY DIRECT, INDIRECT, INCIDENTAL, SPECIAL, EXEMPLARY, OR CONSEQUENTIAL DAMAGES (INCLUDING, BUT NOT LIMITED TO, PROCUREMENT OF SUBSTITUTE GOODS OR SERVICES; LOSS OF USE, DATA, OR PROFITS; OR

BUSINESS INTERRUPTION) HOWEVER CAUSED AND ON ANY THEORY OF LIABILITY, WHETHER IN CONTRACT, STRICT LIABILITY, OR TORT (INCLUDING NEGLIGENCE OR OTHERWISE) ARISING IN ANY WAY OUT OF THE USE OF THIS SOFTWARE, EVEN IF ADVISED OF THE POSSIBILITY OF SUCH DAMAGE.

----- Part 4: Sun Microsystems, Inc. copyright notice (BSD) -----

Copyright © 2003 Sun Microsystems, Inc., 4150 Network Circle, Santa Clara, California 95054, U.S.A. All rights reserved.

Use is subject to license terms below.

This distribution may include materials developed by third parties.

Sun, Sun Microsystems, the Sun logo and Solaris are trademarks or registered trademarks of Sun Microsystems, Inc. in the U.S. and other countries.

Redistribution and use in source and binary forms, with or without

modification, are permitted provided that the following conditions are met:

- * Redistributions of source code must retain the above copyright notice, this list of conditions and the following disclaimer.

- * Redistributions in binary form must reproduce the above copyright notice, this list of conditions and the following disclaimer in the documentation and/or other materials provided with the distribution.

- * Neither the name of the Sun Microsystems, Inc. nor the names of its contributors may be used to endorse or promote products derived from this software without specific prior written permission.

THIS SOFTWARE IS PROVIDED BY THE COPYRIGHT HOLDERS AND CONTRIBUTORS

AS

IS" AND ANY EXPRESS OR IMPLIED WARRANTIES, INCLUDING, BUT NOT LIMITED TO, THE IMPLIED WARRANTIES OF MERCHANTABILITY AND FITNESS FOR A PARTICULAR PURPOSE ARE DISCLAIMED. IN NO EVENT SHALL THE COPYRIGHT HOLDERS OR

CONTRIBUTORS BE LIABLE FOR ANY DIRECT, INDIRECT, INCIDENTAL, SPECIAL, EXEMPLARY, OR CONSEQUENTIAL DAMAGES (INCLUDING, BUT NOT LIMITED TO, PROCUREMENT OF SUBSTITUTE GOODS OR SERVICES; LOSS OF USE, DATA, OR PROFITS; OR BUSINESS INTERRUPTION) HOWEVER CAUSED AND ON ANY THEORY OF LIABILITY, WHETHER IN CONTRACT, STRICT LIABILITY, OR TORT (INCLUDING NEGLIGENCE OR OTHERWISE) ARISING IN ANY WAY OUT OF THE USE OF THIS SOFTWARE, EVEN IF ADVISED OF THE POSSIBILITY OF SUCH DAMAGE.

----- Part 5: Sparta, Inc copyright notice (BSD) -----

Copyright (c) 2003–2012, Sparta, Inc

All rights reserved.

Redistribution and use in source and binary forms, with or without modification, are permitted provided that the following conditions are met:

* Redistributions of source code must retain the above copyright notice, this list of conditions and the following disclaimer.

- * Redistributions in binary form must reproduce the above copyright notice, this list of conditions and the following disclaimer in the documentation and/or other materials provided with the distribution.

- * Neither the name of Sparta, Inc nor the names of its contributors may be used to endorse or promote products derived from this software without specific prior written permission.

THIS SOFTWARE IS PROVIDED BY THE COPYRIGHT HOLDERS AND CONTRIBUTORS

AS

IS" AND ANY EXPRESS OR IMPLIED WARRANTIES, INCLUDING, BUT NOT LIMITED TO, THE IMPLIED WARRANTIES OF MERCHANTABILITY AND FITNESS FOR A PARTICULAR PURPOSE ARE DISCLAIMED. IN NO EVENT SHALL THE COPYRIGHT HOLDERS OR CONTRIBUTORS BE LIABLE FOR ANY DIRECT, INDIRECT, INCIDENTAL, SPECIAL, EXEMPLARY, OR CONSEQUENTIAL DAMAGES (INCLUDING, BUT NOT LIMITED TO, PROCUREMENT OF SUBSTITUTE GOODS OR SERVICES; LOSS OF USE, DATA, OR PROFITS; OR BUSINESS INTERRUPTION) HOWEVER CAUSED AND ON ANY THEORY OF LIABILITY,

WHETHER IN CONTRACT, STRICT LIABILITY, OR TORT (INCLUDING NEGLIGENCE OR OTHERWISE) ARISING IN ANY WAY OUT OF THE USE OF THIS SOFTWARE, EVEN IF ADVISED OF THE POSSIBILITY OF SUCH DAMAGE.

----- Part 6: Cisco/BUPTNIC copyright notice (BSD) -----

Copyright (c) 2004, Cisco, Inc and Information Network

Center of Beijing University of Posts and Telecommunications.

All rights reserved.

Redistribution and use in source and binary forms, with or without modification, are permitted provided that the following conditions are met:

- * Redistributions of source code must retain the above copyright notice, this list of conditions and the following disclaimer.

- * Redistributions in binary form must reproduce the above copyright notice, this list of conditions and the following disclaimer in the documentation and/or other materials provided with the distribution.

* Neither the name of Cisco, Inc, Beijing University of Posts and Telecommunications, nor the names of their contributors may be used to endorse or promote products derived from this software without specific prior written permission.

THIS SOFTWARE IS PROVIDED BY THE COPYRIGHT HOLDERS AND CONTRIBUTORS

AS

IS" AND ANY EXPRESS OR IMPLIED WARRANTIES, INCLUDING, BUT NOT LIMITED TO, THE IMPLIED WARRANTIES OF MERCHANTABILITY AND FITNESS FOR A PARTICULAR PURPOSE ARE DISCLAIMED. IN NO EVENT SHALL THE COPYRIGHT HOLDERS OR CONTRIBUTORS BE LIABLE FOR ANY DIRECT, INDIRECT, INCIDENTAL, SPECIAL, EXEMPLARY, OR CONSEQUENTIAL DAMAGES (INCLUDING, BUT NOT LIMITED TO, PROCUREMENT OF SUBSTITUTE GOODS OR SERVICES; LOSS OF USE, DATA, OR PROFITS; OR BUSINESS INTERRUPTION) HOWEVER CAUSED AND ON ANY THEORY OF LIABILITY, WHETHER IN CONTRACT, STRICT LIABILITY, OR TORT (INCLUDING NEGLIGENCE OR OTHERWISE) ARISING IN ANY WAY OUT OF THE USE OF THIS SOFTWARE, EVEN IF ADVISED OF THE POSSIBILITY OF SUCH DAMAGE.

----- Part 7: Fabasoft R&D Software GmbH & Co KG copyright notice (BSD) -----

Copyright (c) Fabasoft R&D Software GmbH & Co KG, 2003

oss@fabasoft.com

Author: Bernhard Penz <bernhard.penz@fabasoft.com>

Redistribution and use in source and binary forms, with or without modification, are permitted provided that the following conditions are met:

- * Redistributions of source code must retain the above copyright notice, this list of conditions and the following disclaimer.

- * Redistributions in binary form must reproduce the above copyright notice, this list of conditions and the following disclaimer in the documentation and/or other materials provided with the distribution.

- * The name of Fabasoft R&D Software GmbH & Co KG or any of its subsidiaries, brand or product names may not be used to endorse or promote products

derived from this software without specific prior written permission.

THIS SOFTWARE IS PROVIDED BY THE COPYRIGHT HOLDER "AS IS" AND ANY EXPRESS OR IMPLIED WARRANTIES, INCLUDING, BUT NOT LIMITED TO, THE IMPLIED WARRANTIES OF MERCHANTABILITY AND FITNESS FOR A PARTICULAR PURPOSE ARE DISCLAIMED. IN NO EVENT SHALL THE COPYRIGHT HOLDER BE LIABLE FOR ANY DIRECT, INDIRECT, INCIDENTAL, SPECIAL, EXEMPLARY, OR CONSEQUENTIAL DAMAGES (INCLUDING, BUT NOT LIMITED TO, PROCUREMENT OF SUBSTITUTE GOODS OR SERVICES; LOSS OF USE, DATA, OR PROFITS; OR BUSINESS INTERRUPTION) HOWEVER CAUSED AND ON ANY THEORY OF LIABILITY, WHETHER IN CONTRACT, STRICT LIABILITY, OR TORT (INCLUDING NEGLIGENCE OR OTHERWISE) ARISING IN ANY WAY OUT OF THE USE OF THIS SOFTWARE, EVEN IF ADVISED OF THE POSSIBILITY OF SUCH DAMAGE.

----- Part 8: Apple Inc. copyright notice (BSD) -----

Copyright (c) 2007 Apple Inc. All rights reserved.

Redistribution and use in source and binary forms, with or without

modification, are permitted provided that the following conditions are met:

1. Redistributions of source code must retain the above copyright notice, this list of conditions and the following disclaimer.
2. Redistributions in binary form must reproduce the above copyright notice, this list of conditions and the following disclaimer in the documentation and/or other materials provided with the distribution.
3. Neither the name of Apple Inc. ("Apple") nor the names of its contributors may be used to endorse or promote products derived from this software without specific prior written permission.

THIS SOFTWARE IS PROVIDED BY APPLE AND ITS CONTRIBUTORS "AS IS" AND ANY EXPRESS OR IMPLIED WARRANTIES, INCLUDING, BUT NOT LIMITED TO, THE IMPLIED WARRANTIES OF MERCHANTABILITY AND FITNESS FOR A PARTICULAR PURPOSE ARE DISCLAIMED. IN NO EVENT SHALL APPLE OR ITS CONTRIBUTORS BE LIABLE FOR ANY DIRECT, INDIRECT, INCIDENTAL, SPECIAL, EXEMPLARY, OR CONSEQUENTIAL DAMAGES (INCLUDING, BUT NOT

LIMITED TO, PROCUREMENT OF SUBSTITUTE GOODS OR SERVICES; LOSS OF USE, DATA, OR PROFITS; OR BUSINESS INTERRUPTION) HOWEVER CAUSED AND ON ANY THEORY OF LIABILITY, WHETHER IN CONTRACT, STRICT LIABILITY, OR TORT (INCLUDING NEGLIGENCE OR OTHERWISE) ARISING IN ANY WAY OUT OF THE USE OF THIS SOFTWARE, EVEN IF ADVISED OF THE POSSIBILITY OF SUCH DAMAGE.

---- Part 9: ScienceLogic, LLC copyright notice (BSD) -----

Copyright (c) 2009, ScienceLogic, LLC

All rights reserved.

Redistribution and use in source and binary forms, with or without modification, are permitted provided that the following conditions are met:

- * Redistributions of source code must retain the above copyright notice, this list of conditions and the following disclaimer.

- * Redistributions in binary form must reproduce the above copyright notice, this list of conditions and the following disclaimer in the documentation and/or other materials provided with the distribution.

- * Neither the name of ScienceLogic, LLC nor the names of its contributors may be used to endorse or promote products derived from this software without specific prior written permission.

THIS SOFTWARE IS PROVIDED BY THE COPYRIGHT HOLDERS AND CONTRIBUTORS
"AS IS" AND ANY EXPRESS OR IMPLIED WARRANTIES, INCLUDING, BUT NOT
LIMITED TO, THE IMPLIED WARRANTIES OF MERCHANTABILITY AND FITNESS FOR
A PARTICULAR PURPOSE ARE DISCLAIMED. IN NO EVENT SHALL THE COPYRIGHT
HOLDERS OR CONTRIBUTORS BE LIABLE FOR ANY DIRECT, INDIRECT,
INCIDENTAL, SPECIAL, EXEMPLARY, OR CONSEQUENTIAL DAMAGES (INCLUDING,
BUT NOT LIMITED TO, PROCUREMENT OF SUBSTITUTE GOODS OR SERVICES; LOSS
OF USE, DATA, OR PROFITS; OR BUSINESS INTERRUPTION) HOWEVER CAUSED AND
ON ANY THEORY OF LIABILITY, WHETHER IN CONTRACT, STRICT LIABILITY, OR
TORT (INCLUDING NEGLIGENCE OR OTHERWISE) ARISING IN ANY WAY OUT OF THE
USE OF THIS SOFTWARE, EVEN IF ADVISED OF THE POSSIBILITY OF SUCH

DAMAGE.

46.OPEN CV

// Copyright (C) 2000, Intel Corporation, all rights reserved.

// Third party copyrights are property of their respective owners.

//

// Redistribution and use in source and binary forms, with or without modification,

// are permitted provided that the following conditions are met:

//

// * Redistribution's of source code must retain the above copyright notice,

// this list of conditions and the following disclaimer.

//

// * Redistribution's in binary form must reproduce the above copyright notice,

// this list of conditions and the following disclaimer in the documentation

// and/or other materials provided with the distribution.

//

// * The name of Intel Corporation may not be used to endorse or promote products

// derived from this software without specific prior written permission.

//

// This software is provided by the copyright holders and contributors "as is" and

// any express or implied warranties, including, but not limited to, the implied
// warranties of merchantability and fitness for a particular purpose are disclaimed.
// In no event shall the Intel Corporation or contributors be liable for any direct,
// indirect, incidental, special, exemplary, or consequential damages
// (including, but not limited to, procurement of substitute goods or services;
// loss of use, data, or profits; or business interruption) however caused
// and on any theory of liability, whether in contract, strict liability,
// or tort (including negligence or otherwise) arising in any way out of
// the use of this software, even if advised of the possibility of such damage.

// Copyright (C) 2000–2008, Intel Corporation, all rights reserved.
// Copyright (C) 2009, 2010, Willow Garage Inc., all rights reserved.
// Copyright (C) 2014, 2015, Itseez Inc., all rights reserved.
// Third party copyrights are property of their respective owners.

/

// Redistribution and use in source and binary forms, with or without modification,
// are permitted provided that the following conditions are met:
//
// * Redistribution's of source code must retain the above copyright notice,

```
// this list of conditions and the following disclaimer.  
  
//  
  
// * Redistribution's in binary form must reproduce the above copyright notice,  
// this list of conditions and the following disclaimer in the documentation  
// and/or other materials provided with the distribution.  
  
//  
  
// * The name of the copyright holders may not be used to endorse or promote  
products  
  
// derived from this software without specific prior written permission.  
  
//  
  
// This software is provided by the copyright holders and contributors "as is" and  
// any express or implied warranties, including, but not limited to, the implied  
// warranties of merchantability and fitness for a particular purpose are disclaimed.  
// In no event shall the Intel Corporation or contributors be liable for any direct,  
// indirect, incidental, special, exemplary, or consequential damages  
// (including, but not limited to, procurement of substitute goods or services;  
// loss of use, data, or profits; or business interruption) however caused  
// and on any theory of liability, whether in contract, strict liability,  
// or tort (including negligence or otherwise) arising in any way out of
```

```
// the use of this software, even if advised of the possibility of such damage.

// Copyright (C) 2000–2008, Intel Corporation, all rights reserved.

// Copyright (C) 2009, Willow Garage Inc., all rights reserved.

// Copyright (C) 2013, OpenCV Foundation, all rights reserved.

// Third party copyrights are property of their respective owners.

//

// Redistribution and use in source and binary forms, with or without modification,

// are permitted provided that the following conditions are met:

//

// * Redistribution's of source code must retain the above copyright notice,

// this list of conditions and the following disclaimer.

//

// * Redistribution's in binary form must reproduce the above copyright notice,

// this list of conditions and the following disclaimer in the documentation

// and/or other materials provided with the distribution.

//

// * The name of the copyright holders may not be used to endorse or promote

products
```

// derived from this software without specific prior written permission.

//

// This software is provided by the copyright holders and contributors "as is" and

// any express or implied warranties, including, but not limited to, the implied

// warranties of merchantability and fitness for a particular purpose are disclaimed.

// In no event shall the Intel Corporation or contributors be liable for any direct,

// indirect, incidental, special, exemplary, or consequential damages

// (including, but not limited to, procurement of substitute goods or services;

// loss of use, data, or profits; or business interruption) however caused

// and on any theory of liability, whether in contract, strict liability,

// or tort (including negligence or otherwise) arising in any way out of

// the use of this software, even if advised of the possibility of such damage.

//

// Copyright (C) 2000–2008, Intel Corporation, all rights reserved.

// Copyright (C) 2009–2011, Willow Garage Inc., all rights reserved.

// Third party copyrights are property of their respective owners.

//

// Redistribution and use in source and binary forms, with or without modification,

// are permitted provided that the following conditions are met:

```
//  
  
// * Redistribution's of source code must retain the above copyright notice,  
// this list of conditions and the following disclaimer.  
  
//  
// * Redistribution's in binary form must reproduce the above copyright notice,  
// this list of conditions and the following disclaimer in the documentation  
// and/or other materials provided with the distribution.  
  
//  
// * The name of the copyright holders may not be used to endorse or promote  
products  
// derived from this software without specific prior written permission.  
  
//  
// This software is provided by the copyright holders and contributors "as is" and  
// any express or implied warranties, including, but not limited to, the implied  
// warranties of merchantability and fitness for a particular purpose are disclaimed.  
// In no event shall the Intel Corporation or contributors be liable for any direct,  
// indirect, incidental, special, exemplary, or consequential damages  
// (including, but not limited to, procurement of substitute goods or services;  
// loss of use, data, or profits; or business interruption) however caused
```



```
// and on any theory of liability, whether in contract, strict liability,  
  
// or tort (including negligence or otherwise) arising in any way out of  
  
// the use of this software, even if advised of the possibility of such damage.  
  
  
// Copyright (C) 2000–2008, Intel Corporation, all rights reserved.  
  
// Copyright (C) 2009, Willow Garage Inc., all rights reserved.  
  
// Third party copyrights are property of their respective owners.  
  
//  
  
// Redistribution and use in source and binary forms, with or without modification,  
  
// are permitted provided that the following conditions are met:  
  
//  
  
// * Redistribution's of source code must retain the above copyright notice,  
  
// this list of conditions and the following disclaimer.  
  
//  
  
// * Redistribution's in binary form must reproduce the above copyright notice,  
  
// this list of conditions and the following disclaimer in the documentation  
  
// and/or other materials provided with the distribution.  
  
//
```

```
// * The name of the copyright holders may not be used to endorse or promote
products

// derived from this software without specific prior written permission.

//

// This software is provided by the copyright holders and contributors "as is" and
// any express or implied warranties, including, but not limited to, the implied
// warranties of merchantability and fitness for a particular purpose are disclaimed.
// In no event shall the Intel Corporation or contributors be liable for any direct,
// indirect, incidental, special, exemplary, or consequential damages
// (including, but not limited to, procurement of substitute goods or services;
// loss of use, data, or profits; or business interruption) however caused
// and on any theory of liability, whether in contract, strict liability,
// or tort (including negligence or otherwise) arising in any way out of
// the use of this software, even if advised of the possibility of such damage.

// Copyright (C) 2010–2012, Institute Of Software Chinese Academy Of Science, all
rights reserved.

// Copyright (C) 2010–2012, Advanced Micro Devices, Inc., all rights reserved.

// Copyright (C) 2013, OpenCV Foundation, all rights reserved.
```

```
// Third party copyrights are property of their respective owners.

//

// @Authors

// Jia Haipeng, jiahaipeng95@gmail.com

//

//

// Redistribution and use in source and binary forms, with or without modification,

// are permitted provided that the following conditions are met:

//

// * Redistribution's of source code must retain the above copyright notice,

// this list of conditions and the following disclaimer.

//

// * Redistribution's in binary form must reproduce the above copyright notice,

// this list of conditions and the following disclaimer in the documentation

// and/or other materials provided with the distribution.

//

// * The name of the copyright holders may not be used to endorse or promote

products

// derived from this software without specific prior written permission.
```

//

// This software is provided by the copyright holders and contributors as is and
// any express or implied warranties, including, but not limited to, the implied
// warranties of merchantability and fitness for a particular purpose are disclaimed.
// In no event shall the copyright holders or contributors be liable for any direct,
// indirect, incidental, special, exemplary, or consequential damages
// (including, but not limited to, procurement of substitute goods or services;
// loss of use, data, or profits; or business interruption) however caused
// and on any theory of liability, whether in contract, strict liability,
// or tort (including negligence or otherwise) arising in any way out of
// the use of this software, even if advised of the possibility of such damage.

// Copyright (C) 2000–2008, Intel Corporation, all rights reserved.

// Copyright (C) 2009–2011, Willow Garage Inc., all rights reserved.

// Copyright (C) 2014–2015, Itseez Inc., all rights reserved.

// Third party copyrights are property of their respective owners.

//

// Redistribution and use in source and binary forms, with or without modification,
// are permitted provided that the following conditions are met:

```
//  
  
// * Redistribution's of source code must retain the above copyright notice,  
// this list of conditions and the following disclaimer.  
  
//  
// * Redistribution's in binary form must reproduce the above copyright notice,  
// this list of conditions and the following disclaimer in the documentation  
// and/or other materials provided with the distribution.  
  
//  
// * The name of the copyright holders may not be used to endorse or promote  
products  
// derived from this software without specific prior written permission.  
  
//  
// This software is provided by the copyright holders and contributors "as is" and  
// any express or implied warranties, including, but not limited to, the implied  
// warranties of merchantability and fitness for a particular purpose are disclaimed.  
// In no event shall the Intel Corporation or contributors be liable for any direct,  
// indirect, incidental, special, exemplary, or consequential damages  
// (including, but not limited to, procurement of substitute goods or services;  
// loss of use, data, or profits; or business interruption) however caused
```

```
// and on any theory of liability, whether in contract, strict liability,  
  
// or tort (including negligence or otherwise) arising in any way out of  
  
// the use of this software, even if advised of the possibility of such damage.  
  
  
// Copyright (C) 2000–2008, Intel Corporation, all rights reserved.  
  
// Copyright (C) 2009, Willow Garage Inc., all rights reserved.  
  
// Copyright (C) 2013, OpenCV Foundation, all rights reserved.  
  
// Copyright (C) 2015, Itseez Inc., all rights reserved.  
  
// Third party copyrights are property of their respective owners.  
  
//  
  
// Redistribution and use in source and binary forms, with or without modification,  
  
// are permitted provided that the following conditions are met:  
  
//  
  
// * Redistribution's of source code must retain the above copyright notice,  
  
// this list of conditions and the following disclaimer.  
  
//  
  
// * Redistribution's in binary form must reproduce the above copyright notice,  
  
// this list of conditions and the following disclaimer in the documentation  
  
// and/or other materials provided with the distribution.
```

//

// * The name of the copyright holders may not be used to endorse or promote products

// derived from this software without specific prior written permission.

//

// This software is provided by the copyright holders and contributors "as is" and

// any express or implied warranties, including, but not limited to, the implied

// warranties of merchantability and fitness for a particular purpose are disclaimed.

// In no event shall the Intel Corporation or contributors be liable for any direct,

// indirect, incidental, special, exemplary, or consequential damages

// (including, but not limited to, procurement of substitute goods or services;

// loss of use, data, or profits; or business interruption) however caused

// and on any theory of liability, whether in contract, strict liability,

// or tort (including negligence or otherwise) arising in any way out of

// the use of this software, even if advised of the possibility of such damage.

// Copyright (C) 2000–2008, Intel Corporation, all rights reserved.

// Copyright (C) 2009, Willow Garage Inc., all rights reserved.

// Copyright (C) 2013, OpenCV Foundation, all rights reserved.

```
// Copyright (C) 2014, Itseez Inc., all rights reserved.

// Third party copyrights are property of their respective owners.

//

// Redistribution and use in source and binary forms, with or without modification,
// are permitted provided that the following conditions are met:

//

// * Redistribution's of source code must retain the above copyright notice,
// this list of conditions and the following disclaimer.

//

// * Redistribution's in binary form must reproduce the above copyright notice,
// this list of conditions and the following disclaimer in the documentation
// and/or other materials provided with the distribution.

//

// * The name of the copyright holders may not be used to endorse or promote
products
// derived from this software without specific prior written permission.

//

// This software is provided by the copyright holders and contributors "as is" and
// any express or implied warranties, including, but not limited to, the implied
```

// warranties of merchantability and fitness for a particular purpose are disclaimed.
// In no event shall the Intel Corporation or contributors be liable for any direct,
// indirect, incidental, special, exemplary, or consequential damages
// (including, but not limited to, procurement of substitute goods or services;
// loss of use, data, or profits; or business interruption) however caused
// and on any theory of liability, whether in contract, strict liability,
// or tort (including negligence or otherwise) arising in any way out of
// the use of this software, even if advised of the possibility of such damage.

// Copyright (C) 2010–2012, Institute Of Software Chinese Academy Of Science, all
rights reserved.

// Copyright (C) 2010–2012, Advanced Micro Devices, Inc., all rights reserved.

// Third party copyrights are property of their respective owners.

//

// @Authors

// Rock Li, Rock.li@amd.com

//

// Redistribution and use in source and binary forms, with or without modification,
// are permitted provided that the following conditions are met:

```
//  
  
// * Redistribution's of source code must retain the above copyright notice,  
// this list of conditions and the following disclaimer.  
  
//  
// * Redistribution's in binary form must reproduce the above copyright notice,  
// this list of conditions and the following disclaimer in the documentation  
// and/or other materials provided with the distribution.  
  
//  
// * The name of the copyright holders may not be used to endorse or promote  
products  
// derived from this software without specific prior written permission.  
  
//  
// This software is provided by the copyright holders and contributors as is and  
// any express or implied warranties, including, but not limited to, the implied  
// warranties of merchantability and fitness for a particular purpose are disclaimed.  
// In no event shall the Intel Corporation or contributors be liable for any direct,  
// indirect, incidental, special, exemplary, or consequential damages  
// (including, but not limited to, procurement of substitute goods or services;  
// loss of use, data, or profits; or business interruption) however caused
```

```
// and on any theory of liability, whether in contract, strict liability,  
  
// or tort (including negligence or otherwise) arising in any way out of  
  
// the use of this software, even if advised of the possibility of such damage.  
  
  
// Copyright (C) 2010–2012, Multicoreware, Inc., all rights reserved.  
  
// Copyright (C) 2010–2012, Advanced Micro Devices, Inc., all rights reserved.  
  
// Third party copyrights are property of their respective owners.  
  
//  
  
// @Authors  
  
// Nathan, liujun@multicorewareinc.com  
  
//  
  
// Redistribution and use in source and binary forms, with or without modification,  
  
// are permitted provided that the following conditions are met:  
  
//  
  
// * Redistribution's of source code must retain the above copyright notice,  
  
// this list of conditions and the following disclaimer.  
  
//  
  
// * Redistribution's in binary form must reproduce the above copyright notice,  
  
// this list of conditions and the following disclaimer in the documentation
```

// and/or other materials provided with the distribution.

//

// * The name of the copyright holders may not be used to endorse or promote products derived from this software without specific prior written permission.

//

// This software is provided by the copyright holders and contributors "as is" and any express or implied warranties, including, but not limited to, the implied warranties of merchantability and fitness for a particular purpose are disclaimed.

// In no event shall the Intel Corporation or contributors be liable for any direct, indirect, incidental, special, exemplary, or consequential damages (including, but not limited to, procurement of substitute goods or services; loss of use, data, or profits; or business interruption) however caused and on any theory of liability, whether in contract, strict liability, or tort (including negligence or otherwise) arising in any way out of the use of this software, even if advised of the possibility of such damage.

// Copyright (C) 2010–2012, MulticoreWare Inc., all rights reserved.

// Copyright (C) 2010–2012, Advanced Micro Devices, Inc., all rights reserved.

```
// Third party copyrights are property of their respective owners.

//

// @Authors

// Liu Liujun, liujun@multicorewareinc.com

//

// Redistribution and use in source and binary forms, with or without modification,

// are permitted provided that the following conditions are met:

//

// * Redistribution's of source code must retain the above copyright notice,

// this list of conditions and the following disclaimer.

//

// * Redistribution's in binary form must reproduce the above copyright notice,

// this list of conditions and the following disclaimer in the documentation

// and/or other materials provided with the distribution.

//

// * The name of the copyright holders may not be used to endorse or promote

products

// derived from this software without specific prior written permission.

//
```

// This software is provided by the copyright holders and contributors as is and
// any express or implied warranties, including, but not limited to, the implied
// warranties of merchantability and fitness for a particular purpose are disclaimed.
// In no event shall the Intel Corporation or contributors be liable for any direct,
// indirect, incidental, special, exemplary, or consequential damages
// (including, but not limited to, procurement of substitute goods or services;
// loss of use, data, or profits; or business interruption) however caused
// and on any theory of liability, whether in contract, strict liability,
// or tort (including negligence or otherwise) arising in any way out of
// the use of this software, even if advised of the possibility of such damage.

// Copyright (C) 2010–2013, 2014 Advanced Micro Devices, Inc., all rights reserved.
// Third party copyrights are property of their respective owners.

//

// Redistribution and use in source and binary forms, with or without modification,
// are permitted provided that the following conditions are met:

//

// * Redistribution's of source code must retain the above copyright notice,
// this list of conditions and the following disclaimer.

```
//  
  
// * Redistribution's in binary form must reproduce the above copyright notice,  
// this list of conditions and the following disclaimer in the documentation  
// and/or other materials provided with the distribution.  
  
//  
// * The name of the copyright holders may not be used to endorse or promote  
products  
// derived from this software without specific prior written permission.  
  
//  
// This software is provided by the copyright holders and contributors as is and  
// any express or implied warranties, including, but not limited to, the implied  
// warranties of merchantability and fitness for a particular purpose are disclaimed.  
// In no event shall the Intel Corporation or contributors be liable for any direct,  
// indirect, incidental, special, exemplary, or consequential damages  
// (including, but not limited to, procurement of substitute goods or services;  
// loss of use, data, or profits; or business interruption) however caused  
// and on any theory of liability, whether in contract, strict liability,  
// or tort (including negligence or otherwise) arising in any way out of  
// the use of this software, even if advised of the possibility of such damage.
```

// Copyright (C) 2010–2012, Institute Of Software Chinese Academy Of Science, all rights reserved.

// Copyright (C) 2010–2012, Advanced Micro Devices, Inc., all rights reserved.

// Copyright (C) 2010–2012, Multicoreware, Inc., all rights reserved.

// Third party copyrights are property of their respective owners.

//

// @Authors

// Niko Li, newlife20080214@gmail.com

// Jia Haipeng, jiahaipeng95@gmail.com

// Xu Pang, pangxu010@163.com

// Wenju He, wenju@multicorewareinc.com

// Redistribution and use in source and binary forms, with or without modification,

// are permitted provided that the following conditions are met:

//

// * Redistribution's of source code must retain the above copyright notice,

// this list of conditions and the following disclaimer.

//

// * Redistribution's in binary form must reproduce the above copyright notice,

// this list of conditions and the following disclaimer in the documentation
// and/or other materials provided with the distribution.

//
// * The name of the copyright holders may not be used to endorse or promote
products
// derived from this software without specific prior written permission.

//
// This software is provided by the copyright holders and contributors as is and
// any express or implied warranties, including, but not limited to, the implied
// warranties of merchantability and fitness for a particular purpose are disclaimed.
// In no event shall the Intel Corporation or contributors be liable for any direct,
// indirect, incidental, special, exemplary, or consequential damages
// (including, but not limited to, procurement of substitute goods or services;
// loss of use, data, or profits; or business interruption) however caused
// and on any theory of liability, whether in contract, strict liability,
// or tort (including negligence or otherwise) arising in any way out of
// the use of this software, even if advised of the possibility of such damage.

// Copyright (C) 2010–2012, Multicoreware, Inc., all rights reserved.

```
// Copyright (C) 2010–2012, Advanced Micro Devices, Inc., all rights reserved.

// Third party copyrights are property of their respective owners.

//

// @Authors

// Peng Xiao, pengxiao@multicorewareinc.com

//

// Redistribution and use in source and binary forms, with or without modification,

// are permitted provided that the following conditions are met:

//

// * Redistribution's of source code must retain the above copyright notice,

// this list of conditions and the following disclaimer.

//

// * Redistribution's in binary form must reproduce the above copyright notice,

// this list of conditions and the following disclaimer in the documentation

// and/or other materials provided with the distribution.

//

// * The name of the copyright holders may not be used to endorse or promote

products

// derived from this software without specific prior written permission.
```

```
//  
  
// This software is provided by the copyright holders and contributors as is and  
// any express or implied warranties, including, but not limited to, the implied  
// warranties of merchantability and fitness for a particular purpose are disclaimed.  
// In no event shall the Intel Corporation or contributors be liable for any direct,  
// indirect, incidental, special, exemplary, or consequential damages  
// (including, but not limited to, procurement of substitute goods or services;  
// loss of use, data, or profits; or business interruption) however caused  
// and on any theory of liability, whether in contract, strict liability,  
// or tort (including negligence or otherwise) arising in any way out of  
// the use of this software, even if advised of the possibility of such damage.  
  
// Copyright (C) 2000, Intel Corporation, all rights reserved.  
// Copyright (C) 2014, Itseez Inc., all rights reserved.  
// Third party copyrights are property of their respective owners.  
  
//  
// Redistribution and use in source and binary forms, with or without modification,  
// are permitted provided that the following conditions are met:  
  
//
```

```
// * Redistribution's of source code must retain the above copyright notice,  
  
// this list of conditions and the following disclaimer.  
  
//  
  
// * Redistribution's in binary form must reproduce the above copyright notice,  
  
// this list of conditions and the following disclaimer in the documentation  
  
// and/or other materials provided with the distribution.  
  
//  
  
// * The name of Intel Corporation may not be used to endorse or promote products  
  
// derived from this software without specific prior written permission.  
  
//  
  
// This software is provided by the copyright holders and contributors "as is" and  
  
// any express or implied warranties, including, but not limited to, the implied  
  
// warranties of merchantability and fitness for a particular purpose are disclaimed.  
  
// In no event shall the Intel Corporation or contributors be liable for any direct,  
  
// indirect, incidental, special, exemplary, or consequential damages  
  
// (including, but not limited to, procurement of substitute goods or services;  
  
// loss of use, data, or profits; or business interruption) however caused  
  
// and on any theory of liability, whether in contract, strict liability,  
  
// or tort (including negligence or otherwise) arising in any way out of
```

```
// the use of this software, even if advised of the possibility of such damage.

// Copyright (C) 2010–2012, Multicoreware, Inc., all rights reserved.

// Copyright (C) 2010–2012, Advanced Micro Devices, Inc., all rights reserved.

// Third party copyrights are property of their respective owners.

//

// @Authors

// Sen Liu, swjtuls1987@126.com

//

// Redistribution and use in source and binary forms, with or without modification,

// are permitted provided that the following conditions are met:

//

// * Redistribution's of source code must retain the above copyright notice,

// this list of conditions and the following disclaimer.

//

// * Redistribution's in binary form must reproduce the above copyright notice,

// this list of conditions and the following disclaimer in the documentation

// and/or other materials provided with the distribution.

//
```

```
// * The name of the copyright holders may not be used to endorse or promote
products
// derived from this software without specific prior written permission.
//
// This software is provided by the copyright holders and contributors as is and
// any express or implied warranties, including, but not limited to, the implied
// warranties of merchantability and fitness for a particular purpose are disclaimed.
// In no event shall the Intel Corporation or contributors be liable for any direct,
// indirect, incidental, special, exemplary, or consequential damages
// (including, but not limited to, procurement of substitute goods or services;
// loss of use, data, or profits; or business interruption) however caused
// and on any theory of liability, whether in contract, strict liability,
// or tort (including negligence or otherwise) arising in any way out of
// the use of this software, even if advised of the possibility of such damage.
//
// Copyright (C) 2013, NVIDIA Corporation, all rights reserved.
// Copyright (C) 2014, Itseez Inc., all rights reserved.
// Third party copyrights are property of their respective owners.
//
```

```
// Redistribution and use in source and binary forms, with or without modification,  
  
// are permitted provided that the following conditions are met:  
  
//  
  
// * Redistribution's of source code must retain the above copyright notice,  
  
// this list of conditions and the following disclaimer.  
  
//  
  
// * Redistribution's in binary form must reproduce the above copyright notice,  
  
// this list of conditions and the following disclaimer in the documentation  
  
// and/or other materials provided with the distribution.  
  
//  
  
// * The name of the copyright holders may not be used to endorse or promote  
products  
  
// derived from this software without specific prior written permission.  
  
//  
  
// This software is provided by the copyright holders and contributors "as is" and  
  
// any express or implied warranties, including, but not limited to, the implied  
  
// warranties of merchantability and fitness for a particular purpose are disclaimed.  
  
// In no event shall the copyright holders or contributors be liable for any direct,  
  
// indirect, incidental, special, exemplary, or consequential damages
```

```
// (including, but not limited to, procurement of substitute goods or services;  
// loss of use, data, or profits; or business interruption) however caused  
// and on any theory of liability, whether in contract, strict liability,  
// or tort (including negligence or otherwise) arising in any way out of  
// the use of this software, even if advised of the possibility of such damage.  
  
// Copyright (C) 2013, OpenCV Foundation, all rights reserved.  
// Third party copyrights are property of their respective owners.  
  
//  
// Redistribution and use in source and binary forms, with or without modification,  
// are permitted provided that the following conditions are met:  
  
//  
// * Redistribution's of source code must retain the above copyright notice,  
// this list of conditions and the following disclaimer.  
  
//  
// * Redistribution's in binary form must reproduce the above copyright notice,  
// this list of conditions and the following disclaimer in the documentation  
// and/or other materials provided with the distribution.  
  
//
```



```
// * The name of the copyright holders may not be used to endorse or promote
products
// derived from this software without specific prior written permission.
//
// This software is provided by the copyright holders and contributors "as is" and
// any express or implied warranties, including, but not limited to, the implied
// warranties of merchantability and fitness for a particular purpose are disclaimed.
// In no event shall the OpenCV Foundation or contributors be liable for any direct,
// indirect, incidental, special, exemplary, or consequential damages
// (including, but not limited to, procurement of substitute goods or services;
// loss of use, data, or profits; or business interruption) however caused
// and on any theory of liability, whether in contract, strict liability,
// or tort (including negligence or otherwise) arising in any way out of
// the use of this software, even if advised of the possibility of such damage.
// Copyright (C) 2010–2012, Institute Of Software Chinese Academy Of Science, all
rights reserved.
// Copyright (C) 2010–2012, Advanced Micro Devices, Inc., all rights reserved.
// Copyright (C) 2013, OpenCV Foundation, all rights reserved.
```

```
// Third party copyrights are property of their respective owners.

//

// Redistribution and use in source and binary forms, with or without modification,
// are permitted provided that the following conditions are met:

//

// * Redistribution's of source code must retain the above copyright notice,
// this list of conditions and the following disclaimer.

//

// * Redistribution's in binary form must reproduce the above copyright notice,
// this list of conditions and the following disclaimer in the documentation
// and/or other materials provided with the distribution.

//

// * The name of the copyright holders may not be used to endorse or promote
products
// derived from this software without specific prior written permission.

//

// This software is provided by the copyright holders and contributors as is and
// any express or implied warranties, including, but not limited to, the implied
// warranties of merchantability and fitness for a particular purpose are disclaimed.
```

// In no event shall the copyright holders or contributors be liable for any direct,
// indirect, incidental, special, exemplary, or consequential damages
// (including, but not limited to, procurement of substitute goods or services;
// loss of use, data, or profits; or business interruption) however caused
// and on any theory of liability, whether in contract, strict liability,
// or tort (including negligence or otherwise) arising in any way out of
// the use of this software, even if advised of the possibility of such damage.

// Copyright (C) 2000–2008, Intel Corporation, all rights reserved.

// Copyright (C) 2009–2011, Willow Garage Inc., all rights reserved.

// Copyright (C) 2014, Itseez Inc., all rights reserved.

// Third party copyrights are property of their respective owners.

//

// Redistribution and use in source and binary forms, with or without modification,

// are permitted provided that the following conditions are met:

//

// * Redistribution's of source code must retain the above copyright notice,

// this list of conditions and the following disclaimer.

//

```
// * Redistribution's in binary form must reproduce the above copyright notice,  
// this list of conditions and the following disclaimer in the documentation  
// and/or other materials provided with the distribution.  
  
//  
// * The name of the copyright holders may not be used to endorse or promote  
products  
// derived from this software without specific prior written permission.  
  
//  
// This software is provided by the copyright holders and contributors "as is" and  
// any express or implied warranties, including, but not limited to, the implied  
// warranties of merchantability and fitness for a particular purpose are disclaimed.  
// In no event shall the Intel Corporation or contributors be liable for any direct,  
// indirect, incidental, special, exemplary, or consequential damages  
// (including, but not limited to, procurement of substitute goods or services;  
// loss of use, data, or profits; or business interruption) however caused  
// and on any theory of liability, whether in contract, strict liability,  
// or tort (including negligence or otherwise) arising in any way out of  
// the use of this software, even if advised of the possibility of such damage.
```

// Copyright (C) 2010–2012, Institute Of Software Chinese Academy Of Science, all rights reserved.

// Copyright (C) 2010–2012, Advanced Micro Devices, Inc., all rights reserved.

// Third party copyrights are property of their respective owners.

//

// @Authors

// Niko Li, newlife20080214@gmail.com

// Zero Lin zero.lin@amd.com

// Redistribution and use in source and binary forms, with or without modification,

// are permitted provided that the following conditions are met:

//

// * Redistribution's of source code must retain the above copyright notice,

// this list of conditions and the following disclaimer.

//

// * Redistribution's in binary form must reproduce the above copyright notice,

// this list of conditions and the following disclaimer in the documentation

// and/or other materials provided with the distribution.

//

```
// * The name of the copyright holders may not be used to endorse or promote
products
// derived from this software without specific prior written permission.
//
// This software is provided by the copyright holders and contributors as is and
// any express or implied warranties, including, but not limited to, the implied
// warranties of merchantability and fitness for a particular purpose are disclaimed.
// In no event shall the Intel Corporation or contributors be liable for any direct,
// indirect, incidental, special, exemplary, or consequential damages
// (including, but not limited to, procurement of substitute goods or services;
// loss of use, data, or profits; or business interruption) however caused
// and on any theory of liability, whether in contract, strict liability,
// or tort (including negligence or otherwise) arising in any way out of
// the use of this software, even if advised of the possibility of such damage.
//
// Copyright (C) 2000–2008, Intel Corporation, all rights reserved.
// Copyright (C) 2009, Willow Garage Inc., all rights reserved.
// Copyright (C) 2013, OpenCV Foundation, all rights reserved.
// Third party copyrights are property of their respective owners.
```

```
//  
  
// Redistribution and use in source and binary forms, with or without modification,  
// are permitted provided that the following conditions are met:  
  
//  
// * Redistribution's of source code must retain the above copyright notice,  
// this list of conditions and the following disclaimer.  
  
//  
// * Redistribution's in binary form must reproduce the above copyright notice,  
// this list of conditions and the following disclaimer in the documentation  
// and/or other materials provided with the distribution.  
  
//  
// * The name of the copyright holders may not be used to endorse or promote  
products  
// derived from this software without specific prior written permission.  
  
//  
// This software is provided by the copyright holders and contributors "as is" and  
// any express or implied warranties, including, but not limited to, the implied  
// warranties of merchantability and fitness for a particular purpose are disclaimed.  
// In no event shall the Intel Corporation or contributors be liable for any direct,
```

```
// indirect, incidental, special, exemplary, or consequential damages
// (including, but not limited to, procurement of substitute goods or services;
// loss of use, data, or profits; or business interruption) however caused
// and on any theory of liability, whether in contract, strict liability,
// or tort (including negligence or otherwise) arising in any way out of
// the use of this software, even if advised of the possibility of such damage.

// Copyright (C) 2000–2015, Intel Corporation, all rights reserved.
// Copyright (C) 2009–2011, Willow Garage Inc., all rights reserved.
// Copyright (C) 2015, OpenCV Foundation, all rights reserved.
// Copyright (C) 2015, Itseez Inc., all rights reserved.
// Third party copyrights are property of their respective owners.
//
// Redistribution and use in source and binary forms, with or without modification,
// are permitted provided that the following conditions are met:
//
// * Redistribution's of source code must retain the above copyright notice,
// this list of conditions and the following disclaimer.
//
```



```
// * Redistribution's in binary form must reproduce the above copyright notice,  
// this list of conditions and the following disclaimer in the documentation  
// and/or other materials provided with the distribution.  
  
//  
// * The name of the copyright holders may not be used to endorse or promote  
products  
// derived from this software without specific prior written permission.  
  
//  
// This software is provided by the copyright holders and contributors "as is" and  
// any express or implied warranties, including, but not limited to, the implied  
// warranties of merchantability and fitness for a particular purpose are disclaimed.  
// In no event shall the Intel Corporation or contributors be liable for any direct,  
// indirect, incidental, special, exemplary, or consequential damages  
// (including, but not limited to, procurement of substitute goods or services;  
// loss of use, data, or profits; or business interruption) however caused  
// and on any theory of liability, whether in contract, strict liability,  
// or tort (including negligence or otherwise) arising in any way out of  
// the use of this software, even if advised of the possibility of such damage.
```

// Copyright (C) 2010–2012, Institute Of Software Chinese Academy Of Science, all rights reserved.

// Copyright (C) 2010–2012, Advanced Micro Devices, Inc., all rights reserved.

// Third party copyrights are property of their respective owners.

//

// @Authors

// Shengen Yan,yanshengen@gmail.com

//

// Redistribution and use in source and binary forms, with or without modification,

// are permitted provided that the following conditions are met:

//

// * Redistribution's of source code must retain the above copyright notice,

// this list of conditions and the following disclaimer.

//

// * Redistribution's in binary form must reproduce the above copyright notice,

// this list of conditions and the following disclaimer in the documentation

// and/or other materials provided with the distribution.

//

// * The name of the copyright holders may not be used to endorse or promote products

// derived from this software without specific prior written permission.

//

// This software is provided by the copyright holders and contributors as is and

// any express or implied warranties, including, but not limited to, the implied

// warranties of merchantability and fitness for a particular purpose are disclaimed.

// In no event shall the Intel Corporation or contributors be liable for any direct,

// indirect, incidental, special, exemplary, or consequential damages

// (including, but not limited to, procurement of substitute goods or services;

// loss of use, data, or profits; or business interruption) however caused

// and on any theory of liability, whether in contract, strict liability,

// or tort (including negligence or otherwise) arising in any way out of

// the use of this software, even if advised of the possibility of such damage.

// Copyright (C) 2000–2008, Intel Corporation, all rights reserved.

// Copyright (C) 2009, Willow Garage Inc., all rights reserved.

// Copyright (C) 2014–2015, Itseez Inc., all rights reserved.

// Third party copyrights are property of their respective owners.

```
//  
  
// Redistribution and use in source and binary forms, with or without modification,  
// are permitted provided that the following conditions are met:  
  
//  
// * Redistribution's of source code must retain the above copyright notice,  
// this list of conditions and the following disclaimer.  
  
//  
// * Redistribution's in binary form must reproduce the above copyright notice,  
// this list of conditions and the following disclaimer in the documentation  
// and/or other materials provided with the distribution.  
  
//  
// * The name of the copyright holders may not be used to endorse or promote  
products  
// derived from this software without specific prior written permission.  
  
//  
// This software is provided by the copyright holders and contributors "as is" and  
// any express or implied warranties, including, but not limited to, the implied  
// warranties of merchantability and fitness for a particular purpose are disclaimed.  
// In no event shall the Intel Corporation or contributors be liable for any direct,
```

```
// indirect, incidental, special, exemplary, or consequential damages
// (including, but not limited to, procurement of substitute goods or services;
// loss of use, data, or profits; or business interruption) however caused
// and on any theory of liability, whether in contract, strict liability,
// or tort (including negligence or otherwise) arising in any way out of
// the use of this software, even if advised of the possibility of such damage.

// Copyright (C) 2000, Intel Corporation, all rights reserved.
// Copyright (C) 2013, OpenCV Foundation, all rights reserved.
// Third party copyrights are property of their respective owners.
//
// Redistribution and use in source and binary forms, with or without modification,
// are permitted provided that the following conditions are met:
//
// * Redistribution's of source code must retain the above copyright notice,
// this list of conditions and the following disclaimer.
//
// * Redistribution's in binary form must reproduce the above copyright notice,
// this list of conditions and the following disclaimer in the documentation
```

// and/or other materials provided with the distribution.

//

// * The name of the copyright holders may not be used to endorse or promote products derived from this software without specific prior written permission.

//

// This software is provided by the copyright holders and contributors "as is" and any express or implied warranties, including, but not limited to, the implied warranties of merchantability and fitness for a particular purpose are disclaimed.

// In no event shall the Intel Corporation or contributors be liable for any direct, indirect, incidental, special, exemplary, or consequential damages (including, but not limited to, procurement of substitute goods or services; loss of use, data, or profits; or business interruption) however caused and on any theory of liability, whether in contract, strict liability, or tort (including negligence or otherwise) arising in any way out of the use of this software, even if advised of the possibility of such damage.

// Copyright (C) 2010–2012, Institute Of Software Chinese Academy Of Science, all rights reserved.

```
// Copyright (C) 2010–2012, Advanced Micro Devices, Inc., all rights reserved.

// Third party copyrights are property of their respective owners.

//

// @Authors

// Jia Haipeng, jiahaipeng95@gmail.com

// Peng Xiao, pengxiao@multicorewareinc.com

//

// Redistribution and use in source and binary forms, with or without modification,

// are permitted provided that the following conditions are met:

//

// * Redistribution's of source code must retain the above copyright notice,

// this list of conditions and the following disclaimer.

//

// * Redistribution's in binary form must reproduce the above copyright notice,

// this list of conditions and the following disclaimer in the documentation

// and/or other materials provided with the distribution.

//

// * The name of the copyright holders may not be used to endorse or promote

products
```

// derived from this software without specific prior written permission.

//

// This software is provided by the copyright holders and contributors as is and

// any express or implied warranties, including, but not limited to, the implied

// warranties of merchantability and fitness for a particular purpose are disclaimed.

// In no event shall the Intel Corporation or contributors be liable for any direct,

// indirect, incidental, special, exemplary, or consequential damages

// (including, but not limited to, procurement of substitute goods or services;

// loss of use, data, or profits; or business interruption) however caused

// and on any theory of liability, whether in contract, strict liability,

// or tort (including negligence or otherwise) arising in any way out of

// the use of this software, even if advised of the possibility of such damage.

//

// Copyright (C) 2000–2008, Intel Corporation, all rights reserved.

// Copyright (C) 2009–2010, Willow Garage Inc., all rights reserved.

// Copyright (C) 2014, Itseez Inc., all rights reserved.

// Third party copyrights are property of their respective owners.

//

// Redistribution and use in source and binary forms, with or without modification,

```
// are permitted provided that the following conditions are met:

//

// * Redistribution's of source code must retain the above copyright notice,
// this list of conditions and the following disclaimer.

//

// * Redistribution's in binary form must reproduce the above copyright notice,
// this list of conditions and the following disclaimer in the documentation
// and/or other materials provided with the distribution.

//

// * The name of the copyright holders may not be used to endorse or promote
products
// derived from this software without specific prior written permission.

//

// This software is provided by the copyright holders and contributors "as is" and
// any express or implied warranties, including, but not limited to, the implied
// warranties of merchantability and fitness for a particular purpose are disclaimed.
// In no event shall the Intel Corporation or contributors be liable for any direct,
// indirect, incidental, special, exemplary, or consequential damages
// (including, but not limited to, procurement of substitute goods or services;
```

```
// loss of use, data, or profits; or business interruption) however caused
// and on any theory of liability, whether in contract, strict liability,
// or tort (including negligence or otherwise) arising in any way out of
// the use of this software, even if advised of the possibility of such damage.

// Copyright (C) 2010–2013, Advanced Micro Devices, Inc., all rights reserved.
// Third party copyrights are property of their respective owners.

//

// Redistribution and use in source and binary forms, with or without modification,
// are permitted provided that the following conditions are met:

//

// * Redistribution's of source code must retain the above copyright notice,
// this list of conditions and the following disclaimer.

//

// * Redistribution's in binary form must reproduce the above copyright notice,
// this list of conditions and the following disclaimer in the documentation
// and/or other materials provided with the distribution.

//
```

// * The name of the copyright holders may not be used to endorse or promote products
derived from this software without specific prior written permission.
//
// This software is provided by the copyright holders and contributors as is and
// any express or implied warranties, including, but not limited to, the implied
// warranties of merchantability and fitness for a particular purpose are disclaimed.
// In no event shall the copyright holders or contributors be liable for any direct,
// indirect, incidental, special, exemplary, or consequential damages
// (including, but not limited to, procurement of substitute goods or services;
// loss of use, data, or profits; or business interruption) however caused
// and on any theory of liability, whether in contract, strict liability,
// or tort (including negligence or otherwise) arising in any way out of
// the use of this software, even if advised of the possibility of such damage.

Copyright (C) 2010–2013, Advanced Micro Devices, Inc., all rights reserved.

// Copyright (C) 2014, Intel Corporation, all rights reserved.

// Third party copyrights are property of their respective owners.

//

```
// Redistribution and use in source and binary forms, with or without modification,  
// are permitted provided that the following conditions are met:  
  
//  
// * Redistribution's of source code must retain the above copyright notice,  
// this list of conditions and the following disclaimer.  
  
//  
// * Redistribution's in binary form must reproduce the above copyright notice,  
// this list of conditions and the following disclaimer in the documentation  
// and/or other materials provided with the distribution.  
  
//  
// * The name of the copyright holders may not be used to endorse or promote  
products  
// derived from this software without specific prior written permission.  
  
//  
// This software is provided by the copyright holders and contributors as is and  
// any express or implied warranties, including, but not limited to, the implied  
// warranties of merchantability and fitness for a particular purpose are disclaimed.  
// In no event shall the Intel Corporation or contributors be liable for any direct,  
// indirect, incidental, special, exemplary, or consequential damages
```

```
// (including, but not limited to, procurement of substitute goods or services;  
// loss of use, data, or profits; or business interruption) however caused  
// and on any theory of liability, whether in contract, strict liability,  
// or tort (including negligence or otherwise) arising in any way out of  
// the use of this software, even if advised of the possibility of such damage.  
  
// Copyright (C) 2010–2012, Institute Of Software Chinese Academy Of Science, all  
rights reserved.  
  
// Copyright (C) 2010–2012, Advanced Micro Devices, Inc., all rights reserved.  
  
// Copyright (C) 2014, Itseez, Inc, all rights reserved.  
  
// Third party copyrights are property of their respective owners.  
  
//  
  
// @Authors  
  
// Niko Li, newlife20080214@gmail.com  
  
//  
  
// Redistribution and use in source and binary forms, with or without modification,  
// are permitted provided that the following conditions are met:  
  
//  
  
// * Redistribution's of source code must retain the above copyright notice,
```

```
// this list of conditions and the following disclaimer.  
  
//  
  
// * Redistribution's in binary form must reproduce the above copyright notice,  
// this list of conditions and the following disclaimer in the documentation  
// and/or other materials provided with the distribution.  
  
//  
  
// * The name of the copyright holders may not be used to endorse or promote  
products  
  
// derived from this software without specific prior written permission.  
  
//  
  
// This software is provided by the copyright holders and contributors as is and  
// any express or implied warranties, including, but not limited to, the implied  
// warranties of merchantability and fitness for a particular purpose are disclaimed.  
// In no event shall the Intel Corporation or contributors be liable for any direct,  
// indirect, incidental, special, exemplary, or consequential damages  
// (including, but not limited to, procurement of substitute goods or services;  
// loss of use, data, or profits; or business interruption) however caused  
// and on any theory of liability, whether in contract, strict liability,  
// or tort (including negligence or otherwise) arising in any way out of
```

```
// the use of this software, even if advised of the possibility of such damage.

// Copyright (C) 2014, Intel Corporation, all rights reserved.

// Third party copyrights are property of their respective owners.

//

// Redistribution and use in source and binary forms, with or without modification,
// are permitted provided that the following conditions are met:

//

// * Redistribution's of source code must retain the above copyright notice,
// this list of conditions and the following disclaimer.

//

// * Redistribution's in binary form must reproduce the above copyright notice,
// this list of conditions and the following disclaimer in the documentation
// and/or other materials provided with the distribution.

//

// * The name of the copyright holders may not be used to endorse or promote
products
// derived from this software without specific prior written permission.

//
```

// This software is provided by the copyright holders and contributors "as is" and
// any express or implied warranties, including, but not limited to, the implied
// warranties of merchantability and fitness for a particular purpose are disclaimed.
// In no event shall the Intel Corporation or contributors be liable for any direct,
// indirect, incidental, special, exemplary, or consequential damages
// (including, but not limited to, procurement of substitute goods or services;
// loss of use, data, or profits; or business interruption) however caused
// and on any theory of liability, whether in contract, strict liability,
// or tort (including negligence or otherwise) arising in any way out of
// the use of this software, even if advised of the possibility of such damage.

// Copyright (C) 2000–2008, Intel Corporation, all rights reserved.
// Copyright (C) 2009–2012, Willow Garage Inc., all rights reserved.
// Third party copyrights are property of their respective owners.

//

// Redistribution and use in source and binary forms, with or without modification,
// are permitted provided that the following conditions are met:

//

// * Redistribution's of source code must retain the above copyright notice,

```
// this list of conditions and the following disclaimer.  
  
//  
  
// * Redistribution's in binary form must reproduce the above copyright notice,  
// this list of conditions and the following disclaimer in the documentation  
// and/or other materials provided with the distribution.  
  
//  
  
// * The name of the copyright holders may not be used to endorse or promote  
products  
  
// derived from this software without specific prior written permission.  
  
//  
  
// This software is provided by the copyright holders and contributors "as is" and  
// any express or implied warranties, including, but not limited to, the implied  
// warranties of merchantability and fitness for a particular purpose are disclaimed.  
// In no event shall the Intel Corporation or contributors be liable for any direct,  
// indirect, incidental, special, exemplary, or consequential damages  
// (including, but not limited to, procurement of substitute goods or services;  
// loss of use, data, or profits; or business interruption) however caused  
// and on any theory of liability, whether in contract, strict liability,  
// or tort (including negligence or otherwise) arising in any way out of
```

```
// the use of this software, even if advised of the possibility of such damage.

// Copyright (C) 2010–2012, Institute Of Software Chinese Academy Of Science, all
rights reserved.

// Copyright (C) 2010–2012, Advanced Micro Devices, Inc., all rights reserved.

// Third party copyrights are property of their respective owners.

//

// @Authors

// Zhang Ying, zhangying913@gmail.com

//

// Redistribution and use in source and binary forms, with or without modification,
// are permitted provided that the following conditions are met:

//

// * Redistribution's of source code must retain the above copyright notice,
// this list of conditions and the following disclaimer.

//

// * Redistribution's in binary form must reproduce the above copyright notice,
// this list of conditions and the following disclaimer in the documentation
// and/or other materials provided with the distribution.
```

//

// * The name of the copyright holders may not be used to endorse or promote products

// derived from this software without specific prior written permission.

//

// This software is provided by the copyright holders and contributors as is and

// any express or implied warranties, including, but not limited to, the implied

// warranties of merchantability and fitness for a particular purpose are disclaimed.

// In no event shall the Intel Corporation or contributors be liable for any direct,

// indirect, incidental, special, exemplary, or consequential damages

// (including, but not limited to, procurement of substitute goods or services;

// loss of use, data, or profits; or business interruption) however caused

// and on any theory of liability, whether in contract, strict liability,

// or tort (including negligence or otherwise) arising in any way out of

// the use of this software, even if advised of the possibility of such damage.

// Copyright (C) 2000–2008, Intel Corporation, all rights reserved.

// Copyright (C) 2008–2013, Willow Garage Inc., all rights reserved.

// Third party copyrights are property of their respective owners.

```
//  
  
// Redistribution and use in source and binary forms, with or without modification,  
// are permitted provided that the following conditions are met:  
  
//  
// * Redistribution's of source code must retain the above copyright notice,  
// this list of conditions and the following disclaimer.  
  
//  
// * Redistribution's in binary form must reproduce the above copyright notice,  
// this list of conditions and the following disclaimer in the documentation  
// and / or other materials provided with the distribution.  
  
//  
// * The name of the copyright holders may not be used to endorse or promote  
products  
// derived from this software without specific prior written permission.  
  
//  
// This software is provided by the copyright holders and contributors "as is" and  
// any express or implied warranties, including, but not limited to, the implied  
// warranties of merchantability and fitness for a particular purpose are disclaimed.  
// In no event shall the Intel Corporation or contributors be liable for any direct,
```

```
// indirect, incidental, special, exemplary, or consequential damages
// (including, but not limited to, procurement of substitute goods or services;
// loss of use, data, or profits; or business interruption) however caused
// and on any theory of liability, whether in contract, strict liability,
// or tort (including negligence or otherwise) arising in any way out of
// the use of this software, even if advised of the possibility of such damage.

// Copyright (C) 2000, Intel Corporation, all rights reserved.
// Copyright (C) 2013, OpenCV Foundation, all rights reserved.
// Copyright (C) 2014, Itseez, Inc, all rights reserved.
// Third party copyrights are property of their respective owners.
//
// Redistribution and use in source and binary forms, with or without modification,
// are permitted provided that the following conditions are met:
//
// * Redistribution's of source code must retain the above copyright notice,
// this list of conditions and the following disclaimer.
//
// * Redistribution's in binary form must reproduce the above copyright notice,
```

```
// this list of conditions and the following disclaimer in the documentation
// and/or other materials provided with the distribution.
//
// * The name of the copyright holders may not be used to endorse or promote
products
// derived from this software without specific prior written permission.
//
// This software is provided by the copyright holders and contributors "as is" and
// any express or implied warranties, including, but not limited to, the implied
// warranties of merchantability and fitness for a particular purpose are disclaimed.
// In no event shall the Intel Corporation or contributors be liable for any direct,
// indirect, incidental, special, exemplary, or consequential damages
// (including, but not limited to, procurement of substitute goods or services;
// loss of use, data, or profits; or business interruption) however caused
// and on any theory of liability, whether in contract, strict liability,
// or tort (including negligence or otherwise) arising in any way out of
// the use of this software, even if advised of the possibility of such damage.
// Copyright (C) 2000–2008, Intel Corporation, all rights reserved.
```

```
// Copyright (C) 2008–2011, Willow Garage Inc., all rights reserved.

// Third party copyrights are property of their respective owners.

//

// @Authors

// Nghia Ho, nghiaho12@yahoo.com

//

// Redistribution and use in source and binary forms, with or without modification,

// are permitted provided that the following conditions are met:

//

// * Redistribution's of source code must retain the above copyright notice,

// this list of conditions and the following disclaimer.

//

// * Redistribution's in binary form must reproduce the above copyright notice,

// this list of conditions and the following disclaimer in the documentation

// and/or other materials provided with the distribution.

//

// * The name of OpenCV Foundation may not be used to endorse or promote

products

// derived from this software without specific prior written permission.
```

```
//  
  
// This software is provided by the copyright holders and contributors "as is" and  
// any express or implied warranties, including, but not limited to, the implied  
// warranties of merchantability and fitness for a particular purpose are disclaimed.  
// In no event shall the OpenCV Foundation or contributors be liable for any direct,  
// indirect, incidental, special, exemplary, or consequential damages  
// (including, but not limited to, procurement of substitute goods or services;  
// loss of use, data, or profits; or business interruption) however caused  
// and on any theory of liability, whether in contract, strict liability,  
// or tort (including negligence or otherwise) arising in any way out of  
// the use of this software, even if advised of the possibility of such damage.  
  
// Copyright (C) 2000–2015, Intel Corporation, all rights reserved.  
// Copyright (C) 2009, Willow Garage Inc., all rights reserved.  
// Copyright (C) 2013, OpenCV Foundation, all rights reserved.  
// Copyright (C) 2015, Itseez Inc., all rights reserved.  
// Third party copyrights are property of their respective owners.  
  
//  
// Redistribution and use in source and binary forms, with or without modification,
```



```
// are permitted provided that the following conditions are met:

//

// * Redistribution's of source code must retain the above copyright notice,
// this list of conditions and the following disclaimer.

//

// * Redistribution's in binary form must reproduce the above copyright notice,
// this list of conditions and the following disclaimer in the documentation
// and/or other materials provided with the distribution.

//

// * The name of the copyright holders may not be used to endorse or promote
products
// derived from this software without specific prior written permission.

//

// This software is provided by the copyright holders and contributors "as is" and
// any express or implied warranties, including, but not limited to, the implied
// warranties of merchantability and fitness for a particular purpose are disclaimed.
// In no event shall the Intel Corporation or contributors be liable for any direct,
// indirect, incidental, special, exemplary, or consequential damages
// (including, but not limited to, procurement of substitute goods or services;
```

```
// loss of use, data, or profits; or business interruption) however caused
// and on any theory of liability, whether in contract, strict liability,
// or tort (including negligence or otherwise) arising in any way out of
// the use of this software, even if advised of the possibility of such damage.

// Copyright (C) 2010–2012, Institute Of Software Chinese Academy Of Science, all
rights reserved.

// Copyright (C) 2010–2012, Advanced Micro Devices, Inc., all rights reserved.

// Third party copyrights are property of their respective owners.

//

// @Authors

// Niko Li, newlife20080214@gmail.com

// Rock Li, Rock.li@amd.com

// Redistribution and use in source and binary forms, with or without modification,
// are permitted provided that the following conditions are met:

//

// * Redistribution's of source code must retain the above copyright notice,
// this list of conditions and the following disclaimer.

//
```

```
// * Redistribution's in binary form must reproduce the above copyright notice,  
// this list of conditions and the following disclaimer in the documentation  
// and/or other materials provided with the distribution.  
  
//  
// * The name of the copyright holders may not be used to endorse or promote  
products  
// derived from this software without specific prior written permission.  
  
//  
// This software is provided by the copyright holders and contributors as is and  
// any express or implied warranties, including, but not limited to, the implied  
// warranties of merchantability and fitness for a particular purpose are disclaimed.  
// In no event shall the Intel Corporation or contributors be liable for any direct,  
// indirect, incidental, special, exemplary, or consequential damages  
// (including, but not limited to, procurement of substitute goods or services;  
// loss of use, data, or profits; or business interruption) however caused  
// and on any theory of liability, whether in contract, strict liability,  
// or tort (including negligence or otherwise) arising in any way out of  
// the use of this software, even if advised of the possibility of such damage.
```

```
// Copyright (C) 2000–2008, Intel Corporation, all rights reserved.

// Copyright (C) 2009, Willow Garage Inc., all rights reserved.

// Copyright (C) 2015, Itseez Inc., all rights reserved.

// Third party copyrights are property of their respective owners.

//

// Redistribution and use in source and binary forms, with or without modification,

// are permitted provided that the following conditions are met:

//

// * Redistribution's of source code must retain the above copyright notice,

// this list of conditions and the following disclaimer.

//

// * Redistribution's in binary form must reproduce the above copyright notice,

// this list of conditions and the following disclaimer in the documentation

// and/or other materials provided with the distribution.

//

// * The name of the copyright holders may not be used to endorse or promote

products

// derived from this software without specific prior written permission.

//
```

// This software is provided by the copyright holders and contributors "as is" and
// any express or implied warranties, including, but not limited to, the implied
// warranties of merchantability and fitness for a particular purpose are disclaimed.
// In no event shall the Intel Corporation or contributors be liable for any direct,
// indirect, incidental, special, exemplary, or consequential damages
// (including, but not limited to, procurement of substitute goods or services;
// loss of use, data, or profits; or business interruption) however caused
// and on any theory of liability, whether in contract, strict liability,
// or tort (including negligence or otherwise) arising in any way out of
// the use of this software, even if advised of the possibility of such damage.

// Copyright (C) 2010–2012, Institute Of Software Chinese Academy Of Science, all
rights reserved.

// Copyright (C) 2010–2012, Advanced Micro Devices, Inc., all rights reserved.

// Third party copyrights are property of their respective owners.

//

// Redistribution and use in source and binary forms, with or without modification,
// are permitted provided that the following conditions are met:

//

```
// * Redistribution's of source code must retain the above copyright notice,  
  
// this list of conditions and the following disclaimer.  
  
//  
  
// * Redistribution's in binary form must reproduce the above copyright notice,  
  
// this list of conditions and the following disclaimer in the documentation  
  
// and/or other materials provided with the distribution.  
  
//  
  
// * The name of the copyright holders may not be used to endorse or promote  
products  
  
// derived from this software without specific prior written permission.  
  
//  
  
// This software is provided by the copyright holders and contributors as is and  
  
// any express or implied warranties, including, but not limited to, the implied  
  
// warranties of merchantability and fitness for a particular purpose are disclaimed.  
  
// In no event shall the Intel Corporation or contributors be liable for any direct,  
  
// indirect, incidental, special, exemplary, or consequential damages  
  
// (including, but not limited to, procurement of substitute goods or services;  
  
// loss of use, data, or profits; or business interruption) however caused  
  
// and on any theory of liability, whether in contract, strict liability,
```

```
// or tort (including negligence or otherwise) arising in any way out of
// the use of this software, even if advised of the possibility of such damage.

// Copyright (C) 2000–2008, Intel Corporation, all rights reserved.
// Copyright (C) 2009–2010, Willow Garage Inc., all rights reserved.
// Third party copyrights are property of their respective owners.

//

// Redistribution and use in source and binary forms, with or without modification,
// are permitted provided that the following conditions are met:

//

// * Redistribution's of source code must retain the above copyright notice,
// this list of conditions and the following disclaimer.

//

// * Redistribution's in binary form must reproduce the above copyright notice,
// this list of conditions and the following disclaimer in the documentation
// and/or other materials provided with the distribution.

//

// * The name of the copyright holders may not be used to endorse or promote
products
```

// derived from this software without specific prior written permission.

//

// This software is provided by the copyright holders and contributors "as is" and

// any express or implied warranties, including, but not limited to, the implied

// warranties of merchantability and fitness for a particular purpose are disclaimed.

// In no event shall the Intel Corporation or contributors be liable for any direct,

// indirect, incidental, special, exemplary, or consequential damages

// (including, but not limited to, procurement of substitute goods or services;

// loss of use, data, or profits; or business interruption) however caused

// and on any theory of liability, whether in contract, strict liability,

// or tort (including negligence or otherwise) arising in any way out of

// the use of this software, even if advised of the possibility of such damage.

//

// Copyright (C) 2000–2008, Intel Corporation, all rights reserved.

// Copyright (C) 2009–2011, Willow Garage Inc., all rights reserved.

// Third party copyrights are property of their respective owners.

//

// Redistribution and use in source and binary forms, with or without modification,

// are permitted provided that the following conditions are met:

```
//  
  
// * Redistribution's of source code must retain the above copyright notice,  
// this list of conditions and the following disclaimer.  
  
//  
// * Redistribution's in binary form must reproduce the above copyright notice,  
// this list of conditions and the following disclaimer in the documentation  
// and/or other materials provided with the distribution.  
  
//  
// * The name of the copyright holders may not be used to endorse or promote  
products  
// derived from this software without specific prior written permission.  
  
//  
// This software is provided by the copyright holders and contributors "as is" and  
// any express or implied warranties, including, but not limited to, the implied  
// warranties of merchantability and fitness for a particular purpose are disclaimed.  
// In no event shall the Intel Corporation or contributors be liable for any direct,  
// indirect, incidental, special, exemplary, or consequential damages  
// (including, but not limited to, procurement of substitute goods or services;  
// loss of use, data, or profits; or business interruption) however caused
```

```
// and on any theory of liability, whether in contract, strict liability,  
  
// or tort (including negligence or otherwise) arising in any way out of  
  
// the use of this software, even if advised of the possibility of such damage.  
  
  
// Copyright (C) 2000, Intel Corporation, all rights reserved.  
  
// Copyright (C) 2013, OpenCV Foundation, all rights reserved.  
  
// Copyright (C) 2013, Ovidiu Parvu, all rights reserved.  
  
// Third party copyrights are property of their respective owners.  
  
//  
  
// Redistribution and use in source and binary forms, with or without modification,  
  
// are permitted provided that the following conditions are met:  
  
//  
  
// * Redistribution's of source code must retain the above copyright notice,  
  
// this list of conditions and the following disclaimer.  
  
//  
  
// * Redistribution's in binary form must reproduce the above copyright notice,  
  
// this list of conditions and the following disclaimer in the documentation  
  
// and/or other materials provided with the distribution.  
  
//
```

// * The name of the copyright holders may not be used to endorse or promote products

// derived from this software without specific prior written permission.

//

// This software is provided by the copyright holders and contributors "as is" and any express or implied warranties, including, but not limited to, the implied warranties of merchantability and fitness for a particular purpose are disclaimed.

// In no event shall the Intel Corporation or contributors be liable for any direct, indirect, incidental, special, exemplary, or consequential damages (including, but not limited to, procurement of substitute goods or services; loss of use, data, or profits; or business interruption) however caused and on any theory of liability, whether in contract, strict liability, or tort (including negligence or otherwise) arising in any way out of the use of this software, even if advised of the possibility of such damage.

// Copyright (C) 2010–2012, Institute Of Software Chinese Academy Of Science, all rights reserved.

// Copyright (C) 2010–2012, Advanced Micro Devices, Inc., all rights reserved.

// Third party copyrights are property of their respective owners.

```
//  
  
// @Authors  
  
// Niko Li, newlife20080214@gmail.com  
  
// Zero Lin, zero.lin@amd.com  
  
// Yao Wang, bitwangyaoyao@gmail.com  
  
// Redistribution and use in source and binary forms, with or without modification,  
// are permitted provided that the following conditions are met:  
  
//  
// * Redistribution's of source code must retain the above copyright notice,  
// this list of conditions and the following disclaimer.  
  
//  
// * Redistribution's in binary form must reproduce the above copyright notice,  
// this list of conditions and the following disclaimer in the documentation  
// and/or other materials provided with the distribution.  
  
//  
// * The name of the copyright holders may not be used to endorse or promote  
products  
// derived from this software without specific prior written permission.  
  
//
```

// This software is provided by the copyright holders and contributors as is and
// any express or implied warranties, including, but not limited to, the implied
// warranties of merchantability and fitness for a particular purpose are disclaimed.
// In no event shall the Intel Corporation or contributors be liable for any direct,
// indirect, incidental, special, exemplary, or consequential damages
// (including, but not limited to, procurement of substitute goods or services;
// loss of use, data, or profits; or business interruption) however caused
// and on any theory of liability, whether in contract, strict liability,
// or tort (including negligence or otherwise) arising in any way out of
// the use of this software, even if advised of the possibility of such damage.

// Copyright (C) 2010–2012, Multicoreware, Inc., all rights reserved.
// Copyright (C) 2010–2012, Advanced Micro Devices, Inc., all rights reserved.
// Third party copyrights are property of their respective owners.

//
// @Authors
// Peng Xiao, pengxiao@multicorewareinc.com
//
// Redistribution and use in source and binary forms, with or without modification,

```
// are permitted provided that the following conditions are met:

//

// * Redistribution's of source code must retain the above copyright notice,
// this list of conditions and the following disclaimer.

//

// * Redistribution's in binary form must reproduce the above copyright notice,
// this list of conditions and the following disclaimer in the documentation
// and/or other materials provided with the distribution.

//

// * The name of the copyright holders may not be used to endorse or promote
products
// derived from this software without specific prior written permission.

//

// This software is provided by the copyright holders and contributors as is and
// any express or implied warranties, including, but not limited to, the implied
// warranties of merchantability and fitness for a particular purpose are disclaimed.
// In no event shall the uintel Corporation or contributors be liable for any direct,
// indirect, incidental, special, exemplary, or consequential damages
// (including, but not limited to, procurement of substitute goods or services;
```

// loss of use, data, or profits; or business u Interruption) however caused
// and on any theory of liability, whether in contract, strict liability,
// or tort (including negligence or otherwise) arising in any way out of
// the use of this software, even if advised of the possibility of such damage.

// Copyright (C) 2014, 2015, Itseez Inc., all rights reserved.

// Third party copyrights are property of their respective owners.

//

// Redistribution and use in source and binary forms, with or without modification,
// are permitted provided that the following conditions are met:

//

// * Redistribution's of source code must retain the above copyright notice,
// this list of conditions and the following disclaimer.

//

// * Redistribution's in binary form must reproduce the above copyright notice,
// this list of conditions and the following disclaimer in the documentation
// and/or other materials provided with the distribution.

//

// * The name of the copyright holders may not be used to endorse or promote products
// derived from this software without specific prior written permission.
//
// This software is provided by the copyright holders and contributors "as is" and
// any express or implied warranties, including, but not limited to, the implied
// warranties of merchantability and fitness for a particular purpose are disclaimed.
// In no event shall the Intel Corporation or contributors be liable for any direct,
// indirect, incidental, special, exemplary, or consequential damages
// (including, but not limited to, procurement of substitute goods or services;
// loss of use, data, or profits; or business interruption) however caused
// and on any theory of liability, whether in contract, strict liability,
// or tort (including negligence or otherwise) arising in any way out of
// the use of this software, even if advised of the possibility of such damage.

/*****

* Copyright (c) 2008 – 2012, 2013 The Khronos Group Inc.

*

* Permission is hereby granted, free of charge, to any person obtaining a

* copy of this software and/or associated documentation files (the
* "Materials"), to deal in the Materials without restriction, including
* without limitation the rights to use, copy, modify, merge, publish,
* distribute, sublicense, and/or sell copies of the Materials, and to
* permit persons to whom the Materials are furnished to do so, subject to
* the following conditions:

*

* The above copyright notice and this permission notice shall be included
* in all copies or substantial portions of the Materials.

*

* THE MATERIALS ARE PROVIDED "AS IS", WITHOUT WARRANTY OF ANY KIND,
* EXPRESS OR IMPLIED, INCLUDING BUT NOT LIMITED TO THE WARRANTIES OF
* MERCHANTABILITY, FITNESS FOR A PARTICULAR PURPOSE AND
NONINFRINGEMENT.

* IN NO EVENT SHALL THE AUTHORS OR COPYRIGHT HOLDERS BE LIABLE FOR ANY
* CLAIM, DAMAGES OR OTHER LIABILITY, WHETHER IN AN ACTION OF CONTRACT,
* TORT OR OTHERWISE, ARISING FROM, OUT OF OR IN CONNECTION WITH THE
* MATERIALS OR THE USE OR OTHER DEALINGS IN THE MATERIALS.

***** /

```
// Copyright (C) 2010–2013, Advanced Micro Devices, Inc., all rights reserved.

// Third party copyrights are property of their respective owners.

//

// Redistribution and use in source and binary forms, with or without modification,
// are permitted provided that the following conditions are met:

//

// * Redistribution's of source code must retain the above copyright notice,
// this list of conditions and the following disclaimer.

//

// * Redistribution's in binary form must reproduce the above copyright notice,
// this list of conditions and the following disclaimer in the documentation
// and/or other materials provided with the distribution.

//

// * The name of the copyright holders may not be used to endorse or promote
products
// derived from this software without specific prior written permission.

//

// This software is provided by the copyright holders and contributors "as is" and
```

// any express or implied warranties, including, but not limited to, the implied
// warranties of merchantability and fitness for a particular purpose are disclaimed.
// In no event shall the OpenCV Foundation or contributors be liable for any direct,
// indirect, incidental, special, exemplary, or consequential damages
// (including, but not limited to, procurement of substitute goods or services;
// loss of use, data, or profits; or business interruption) however caused
// and on any theory of liability, whether in contract, strict liability,
// or tort (including negligence or otherwise) arising in any way out of
// the use of this software, even if advised of the possibility of such damage.

// Copyright (C) 2013, NVIDIA Corporation, all rights reserved.

// Third party copyrights are property of their respective owners.

//

// Redistribution and use in source and binary forms, with or without modification,
// are permitted provided that the following conditions are met:

//

// * Redistribution's of source code must retain the above copyright notice,
// this list of conditions and the following disclaimer.

//

```
// * Redistribution's in binary form must reproduce the above copyright notice,  
// this list of conditions and the following disclaimer in the documentation  
// and/or other materials provided with the distribution.  
  
//  
// * The name of the copyright holders may not be used to endorse or promote  
products  
// derived from this software without specific prior written permission.  
  
//  
// This software is provided by the copyright holders and contributors "as is" and  
// any express or implied warranties, including, but not limited to, the implied  
// warranties of merchantability and fitness for a particular purpose are disclaimed.  
// In no event shall the copyright holders or contributors be liable for any direct,  
// indirect, incidental, special, exemplary, or consequential damages  
// (including, but not limited to, procurement of substitute goods or services;  
// loss of use, data, or profits; or business interruption) however caused  
// and on any theory of liability, whether in contract, strict liability,  
// or tort (including negligence or otherwise) arising in any way out of  
// the use of this software, even if advised of the possibility of such damage.
```

```
// Copyright (C) 2010–2012, Multicoreware, Inc., all rights reserved.

// Copyright (C) 2010–2012, Advanced Micro Devices, Inc., all rights reserved.

// Third party copyrights are property of their respective owners.

//

// @Authors

// Dachuan Zhao, dachuan@multicorewareinc.com

//

// Redistribution and use in source and binary forms, with or without modification,

// are permitted provided that the following conditions are met:

//

// * Redistribution's of source code must retain the above copyright notice,

// this list of conditions and the following disclaimer.

//

// * Redistribution's in binary form must reproduce the above copyright notice,

// this list of conditions and the following disclaimer in the documentation

// and/or other materials provided with the distribution.

//

// * The name of the copyright holders may not be used to endorse or promote

products
```

// derived from this software without specific prior written permission.

//

// This software is provided by the copyright holders and contributors as is and

// any express or implied warranties, including, but not limited to, the implied

// warranties of merchantability and fitness for a particular purpose are disclaimed.

// In no event shall the Intel Corporation or contributors be liable for any direct,

// indirect, incidental, special, exemplary, or consequential damages

// (including, but not limited to, procurement of substitute goods or services;

// loss of use, data, or profits; or business interruption) however caused

// and on any theory of liability, whether in contract, strict liability,

// or tort (including negligence or otherwise) arising in any way out of

// the use of this software, even if advised of the possibility of such damage.

// Copyright (C) 2010–2012, Multicoreware, Inc., all rights reserved.

// Copyright (C) 2010–2012, Advanced Micro Devices, Inc., all rights reserved.

// Third party copyrights are property of their respective owners.

//

// @Authors

// Zhang Chunpeng chunpeng@multicorewareinc.com

```
// Dachuan Zhao, dachuan@multicorewareinc.com

// Yao Wang, yao@multicorewareinc.com

// Peng Xiao, pengxiao@outlook.com

//

// Redistribution and use in source and binary forms, with or without modification,

// are permitted provided that the following conditions are met:

//

// * Redistribution's of source code must retain the above copyright notice,

// this list of conditions and the following disclaimer.

//

// * Redistribution's in binary form must reproduce the above copyright notice,

// this list of conditions and the following disclaimer in the documentation

// and/or other materials provided with the distribution.

//

// * The name of the copyright holders may not be used to endorse or promote

products

// derived from this software without specific prior written permission.

//

// This software is provided by the copyright holders and contributors as is and
```

// any express or implied warranties, including, but not limited to, the implied
// warranties of merchantability and fitness for a particular purpose are disclaimed.
// In no event shall the Intel Corporation or contributors be liable for any direct,
// indirect, incidental, special, exemplary, or consequential damages
// (including, but not limited to, procurement of substitute goods or services;
// loss of use, data, or profits; or business interruption) however caused
// and on any theory of liability, whether in contract, strict liability,
// or tort (including negligence or otherwise) arising in any way out of
// the use of this software, even if advised of the possibility of such damage.

// Copyright (C) 2010–2012, Institute Of Software Chinese Academy Of Science, all
rights reserved.

// Copyright (C) 2010–2012, Advanced Micro Devices, Inc., all rights reserved.

// Third party copyrights are property of their respective owners.

//

// @Authors

// Wu Zailong, bullet@yeah.net

//

// Redistribution and use in source and binary forms, with or without modification,

```
// are permitted provided that the following conditions are met:

//

// * Redistribution's of source code must retain the above copyright notice,
// this list of conditions and the following disclaimer.

//

// * Redistribution's in binary form must reproduce the above copyright notice,
// this list of conditions and the following disclaimer in the documentation
// and/or other materials provided with the distribution.

//

// * The name of the copyright holders may not be used to endorse or promote
products
// derived from this software without specific prior written permission.

//

// This software is provided by the copyright holders and contributors as is and
// any express or implied warranties, including, but not limited to, the implied
// warranties of merchantability and fitness for a particular purpose are disclaimed.
// In no event shall the Intel Corporation or contributors be liable for any direct,
// indirect, incidental, special, exemplary, or consequential damages
// (including, but not limited to, procurement of substitute goods or services;
```

```
// loss of use, data, or profits; or business interruption) however caused
// and on any theory of liability, whether in contract, strict liability,
// or tort (including negligence or otherwise) arising in any way out of
// the use of this software, even if advised of the possibility of such damage.

// Copyright (C) 2010–2012, Institute Of Software Chinese Academy Of Science, all
rights reserved.

// Copyright (C) 2010–2012, Advanced Micro Devices, Inc., all rights reserved.

// Third party copyrights are property of their respective owners.

//

// @Authors

// Zhang Ying, zhangying913@gmail.com

// Niko Li, newlife20080214@gmail.com

// Redistribution and use in source and binary forms, with or without modification,
// are permitted provided that the following conditions are met:

//

// * Redistribution's of source code must retain the above copyright notice,
// this list of conditions and the following disclaimer.

//
```

```
// * Redistribution's in binary form must reproduce the above copyright notice,  
// this list of conditions and the following disclaimer in the documentation  
// and/or other materials provided with the distribution.  
  
//  
// * The name of the copyright holders may not be used to endorse or promote  
products  
// derived from this software without specific prior written permission.  
  
//  
// This software is provided by the copyright holders and contributors as is and  
// any express or implied warranties, including, but not limited to, the implied  
// warranties of merchantability and fitness for a particular purpose are disclaimed.  
// In no event shall the Intel Corporation or contributors be liable for any direct,  
// indirect, incidental, special, exemplary, or consequential damages  
// (including, but not limited to, procurement of substitute goods or services;  
// loss of use, data, or profits; or business interruption) however caused  
// and on any theory of liability, whether in contract, strict liability,  
// or tort (including negligence or otherwise) arising in any way out of  
// the use of this software, even if advised of the possibility of such damage.
```

```
// Copyright (C) 2000, Intel Corporation, all rights reserved.

// Third party copyrights are property of their respective owners.

//

// Redistribution and use in source and binary forms, with or without modification,
// are permitted provided that the following conditions are met:

//

// * Redistribution's of source code must retain the above copyright notice,
// this list of conditions and the following disclaimer.

//

// * Redistribution's in binary form must reproduce the above copyright notice,
// this list of conditions and the following disclaimer in the documentation
// and/or other materials provided with the distribution.

//

// * The name of OpenCV Foundation may not be used to endorse or promote
products
// derived from this software without specific prior written permission.

//

// This software is provided by the copyright holders and contributors "as is" and
// any express or implied warranties, including, but not limited to, the implied
```

```
// warranties of merchantability and fitness for a particular purpose are disclaimed.
// In no event shall the OpenCV Foundation or contributors be liable for any direct,
// indirect, incidental, special, exemplary, or consequential damages
// (including, but not limited to, procurement of substitute goods or services;
// loss of use, data, or profits; or business interruption) however caused
// and on any theory of liability, whether in contract, strict liability,
// or tort (including negligence or otherwise) arising in any way out of
// the use of this software, even if advised of the possibility of such damage.

// Copyright (C) 2010–2012, Multicoreware, Inc., all rights reserved.
// Copyright (C) 2010–2012, Advanced Micro Devices, Inc., all rights reserved.
// Third party copyrights are property of their respective owners.

//

// @Authors

// Jin Ma jin@multicorewareinc.com

//

// Redistribution and use in source and binary forms, with or without modification,
// are permitted provided that the following conditions are met:

//
```

```
// * Redistribution's of source code must retain the above copyright notice,  
  
// this list of conditions and the following disclaimer.  
  
//  
  
// * Redistribution's in binary form must reproduce the above copyright notice,  
  
// this list of conditions and the following disclaimer in the documentation  
  
// and/or other materials provided with the distribution.  
  
//  
  
// * The name of the copyright holders may not be used to endorse or promote  
products  
  
// derived from this software without specific prior written permission.  
  
//  
  
// This software is provided by the copyright holders and contributors as is and  
  
// any express or implied warranties, including, but not limited to, the implied  
  
// warranties of merchantability and fitness for a particular purpose are disclaimed.  
  
// In no event shall the Intel Corporation or contributors be liable for any direct,  
  
// indirect, incidental, special, exemplary, or consequential damages  
  
// (including, but not limited to, procurement of substitute goods or services;  
  
// loss of use, data, or profits; or business interruption) however caused  
  
// and on any theory of liability, whether in contract, strict liability,
```

```
// or tort (including negligence or otherwise) arising in any way out of
// the use of this software, even if advised of the possibility of such damage.

// Copyright (C) 2010–2012, Institute Of Software Chinese Academy Of Science, all
rights reserved.

// Copyright (C) 2010–2012, Advanced Micro Devices, Inc., all rights reserved.

// Third party copyrights are property of their respective owners.

//

// @Authors

// Jia Haipeng, jiahaipeng95@gmail.com

//

// Redistribution and use in source and binary forms, with or without modification,
// are permitted provided that the following conditions are met:

//

// * Redistribution's of source code must retain the above copyright notice,
// this list of conditions and the following disclaimer.

//

// * Redistribution's in binary form must reproduce the above copyright notice,
// this list of conditions and the following disclaimer in the documentation
```

// and/or other materials provided with the distribution.

//

// * The name of the copyright holders may not be used to endorse or promote products derived from this software without specific prior written permission.

//

// This software is provided by the copyright holders and contributors as is and any express or implied warranties, including, but not limited to, the implied warranties of merchantability and fitness for a particular purpose are disclaimed.

// In no event shall the Intel Corporation or contributors be liable for any direct, indirect, incidental, special, exemplary, or consequential damages (including, but not limited to, procurement of substitute goods or services; loss of use, data, or profits; or business interruption) however caused and on any theory of liability, whether in contract, strict liability, or tort (including negligence or otherwise) arising in any way out of the use of this software, even if advised of the possibility of such damage.

// Copyright (C) 2014, Itseez Inc., all rights reserved.

// Third party copyrights are property of their respective owners.

```
//  
  
// Redistribution and use in source and binary forms, with or without modification,  
// are permitted provided that the following conditions are met:  
  
//  
// * Redistribution's of source code must retain the above copyright notice,  
// this list of conditions and the following disclaimer.  
  
//  
// * Redistribution's in binary form must reproduce the above copyright notice,  
// this list of conditions and the following disclaimer in the documentation  
// and/or other materials provided with the distribution.  
  
//  
// * The name of the copyright holders may not be used to endorse or promote  
products  
// derived from this software without specific prior written permission.  
  
//  
// This software is provided by the copyright holders and contributors "as is" and  
// any express or implied warranties, including, but not limited to, the implied  
// warranties of merchantability and fitness for a particular purpose are disclaimed.  
// In no event shall the Intel Corporation or contributors be liable for any direct,
```

// indirect, incidental, special, exemplary, or consequential damages
// (including, but not limited to, procurement of substitute goods or services;
// loss of use, data, or profits; or business interruption) however caused
// and on any theory of liability, whether in contract, strict liability,
// or tort (including negligence or otherwise) arising in any way out of
// the use of this software, even if advised of the possibility of such damage.

// Copyright(C) 2000–2015, Intel Corporation, all rights reserved.
// Copyright (C) 2011–2013, NVIDIA Corporation, all rights reserved.
// Copyright (C) 2013, OpenCV Foundation, all rights reserved.
// Copyright (C) 2015, Itseez Inc., all rights reserved.

// Third party copyrights are property of their respective owners.

//

// Redistribution and use in source and binary forms, with or without modification,
// are permitted provided that the following conditions are met:

//

// * Redistribution's of source code must retain the above copyright notice,
// this list of conditions and the following disclaimer.

//

```
// * Redistribution's in binary form must reproduce the above copyright notice,  
// this list of conditions and the following disclaimer in the documentation  
// and/or other materials provided with the distribution.  
  
//  
// * The name of Intel Corporation may not be used to endorse or promote products  
// derived from this software without specific prior written permission.  
  
//  
// This software is provided by the copyright holders and contributors "as is" and  
// any express or implied warranties, including, but not limited to, the implied  
// warranties of merchantability and fitness for a particular purpose are disclaimed.  
// In no event shall the Intel Corporation or contributors be liable for any direct,  
// indirect, incidental, special, exemplary, or consequential damages  
//(including, but not limited to, procurement of substitute goods or services;  
// loss of use, data, or profits; or business interruption) however caused  
// and on any theory of liability, whether in contract, strict liability,  
// or tort(including negligence or otherwise) arising in any way out of  
// the use of this software, even if advised of the possibility of such damage.  
  
// Copyright (C) 2008, Google, all rights reserved.
```

```
// Third party copyrights are property of their respective owners.

//

// Redistribution and use in source and binary forms, with or without
// modification, are permitted provided that the following conditions are met:
//
// * Redistribution's of source code must retain the above copyright notice,
// this list of conditions and the following disclaimer.
//
// * Redistribution's in binary form must reproduce the above copyright notice,
// this list of conditions and the following disclaimer in the documentation
// and/or other materials provided with the distribution.
//
// * The name of Intel Corporation or contributors may not be used to endorse
// or promote products derived from this software without specific
// prior written permission.
//
// This software is provided by the copyright holders and contributors "as is"
// and any express or implied warranties, including, but not limited to, the
// implied warranties of merchantability and fitness for a particular purpose
```

// are disclaimed. In no event shall the Intel Corporation or contributors be
// liable for any direct, indirect, incidental, special, exemplary, or
// consequential damages
// (including, but not limited to, procurement of substitute goods or services;
// loss of use, data, or profits; or business interruption) however caused
// and on any theory of liability, whether in contract, strict liability,
// or tort (including negligence or otherwise) arising in any way out of
// the use of this software, even if advised of the possibility of such damage.

* Copyright (c) 2011. Philipp Wagner <bytefish[at]gmx[dot]de>.

* Released to public domain under terms of the BSD Simplified license.

*

* Redistribution and use in source and binary forms, with or without

* modification, are permitted provided that the following conditions are met:

* * Redistributions of source code must retain the above copyright

* notice, this list of conditions and the following disclaimer.

* * Redistributions in binary form must reproduce the above copyright

* notice, this list of conditions and the following disclaimer in the

* documentation and/or other materials provided with the distribution.

* * Neither the name of the organization nor the names of its contributors
* may be used to endorse or promote products derived from this software
* without specific prior written permission.

* Copyright (c) 2008–2011, William Lucas

* All rights reserved.

*

* Redistribution and use in source and binary forms, with or without
* modification, are permitted provided that the following conditions
* are met:

*

* * Redistributions of source code must retain the above copyright
* notice, this list of conditions and the following disclaimer.

* * Redistributions in binary form must reproduce the above
* copyright notice, this list of conditions and the following
* disclaimer in the documentation and/or other materials provided
* with the distribution.

* * Neither the name of the Willow Garage nor the names of its
* contributors may be used to endorse or promote products derived

* from this software without specific prior written permission.

*

* THIS SOFTWARE IS PROVIDED BY THE COPYRIGHT HOLDERS AND CONTRIBUTORS

* "AS IS" AND ANY EXPRESS OR IMPLIED WARRANTIES, INCLUDING, BUT NOT

* LIMITED TO, THE IMPLIED WARRANTIES OF MERCHANTABILITY AND FITNESS

* FOR A PARTICULAR PURPOSE ARE DISCLAIMED. IN NO EVENT SHALL THE

* COPYRIGHT OWNER OR CONTRIBUTORS BE LIABLE FOR ANY DIRECT, INDIRECT,

* INCIDENTAL, SPECIAL, EXEMPLARY, OR CONSEQUENTIAL DAMAGES (INCLUDING,

* BUT NOT LIMITED TO, PROCUREMENT OF SUBSTITUTE GOODS OR SERVICES;

* LOSS OF USE, DATA, OR PROFITS; OR BUSINESS INTERRUPTION) HOWEVER

* CAUSED AND ON ANY THEORY OF LIABILITY, WHETHER IN CONTRACT, STRICT

* LIABILITY, OR TORT (INCLUDING NEGLIGENCE OR OTHERWISE) ARISING IN

* ANY WAY OUT OF THE USE OF THIS SOFTWARE, EVEN IF ADVISED OF THE

* POSSIBILITY OF SUCH DAMAGE.

Copyright (C) 1997 – 2002, Makoto Matsumoto and Takuji Nishimura,

All rights reserved.

Redistribution and use in source and binary forms, with or without

modification, are permitted provided that the following conditions

are met:

1. Redistributions of source code must retain the above copyright

notice, this list of conditions and the following disclaimer. +

2. Redistributions in binary form must reproduce the above copyright

notice, this list of conditions and the following disclaimer in the

documentation and/or other materials provided with the distribution. +

3. The names of its contributors may not be used to endorse or promote

products derived from this software without specific prior written

permission. +

THIS SOFTWARE IS PROVIDED BY THE COPYRIGHT HOLDERS AND CONTRIBUTORS

"AS IS" AND ANY EXPRESS OR IMPLIED WARRANTIES, INCLUDING, BUT NOT

LIMITED TO, THE IMPLIED WARRANTIES OF MERCHANTABILITY AND FITNESS FOR

A PARTICULAR PURPOSE ARE DISCLAIMED. IN NO EVENT SHALL THE COPYRIGHT

OWNER OR

CONTRIBUTORS BE LIABLE FOR ANY DIRECT, INDIRECT, INCIDENTAL, SPECIAL, EXEMPLARY, OR CONSEQUENTIAL DAMAGES (INCLUDING, BUT NOT LIMITED TO, PROCUREMENT OF SUBSTITUTE GOODS OR SERVICES; LOSS OF USE, DATA, OR PROFITS; OR BUSINESS INTERRUPTION) HOWEVER CAUSED AND ON ANY THEORY OF LIABILITY, WHETHER IN CONTRACT, STRICT LIABILITY, OR TORT (INCLUDING NEGLIGENCE OR OTHERWISE) ARISING IN ANY WAY OUT OF THE USE OF THIS SOFTWARE, EVEN IF ADVISED OF THE POSSIBILITY OF SUCH DAMAGE.

// * Copyright (c) 1992, 1993

// * The Regents of the University of California. All rights reserved.

// *

// * Redistribution and use in source and binary forms, with or without

// * modification, are permitted provided that the following conditions

// * are met:

// * 1. Redistributions of source code must retain the above copyright

// * notice, this list of conditions and the following disclaimer.

// * 2. Redistributions in binary form must reproduce the above copyright

// * notice, this list of conditions and the following disclaimer in the

// * documentation and/or other materials provided with the distribution.

// * 3. All advertising materials mentioning features or use of this software
// * must display the following acknowledgement:
// * This product includes software developed by the University of
// * California, Berkeley and its contributors.
// * 4. Neither the name of the University nor the names of its contributors
// * may be used to endorse or promote products derived from this software
// * without specific prior written permission.
// *
// * THIS SOFTWARE IS PROVIDED BY THE REGENTS AND CONTRIBUTORS ``AS IS''
AND
// * ANY EXPRESS OR IMPLIED WARRANTIES, INCLUDING, BUT NOT LIMITED TO, THE
// * IMPLIED WARRANTIES OF MERCHANTABILITY AND FITNESS FOR A PARTICULAR
PURPOSE
// * ARE DISCLAIMED. IN NO EVENT SHALL THE REGENTS OR CONTRIBUTORS BE
LIABLE
// * FOR ANY DIRECT, INDIRECT, INCIDENTAL, SPECIAL, EXEMPLARY, OR
CONSEQUENTIAL
// * DAMAGES (INCLUDING, BUT NOT LIMITED TO, PROCUREMENT OF SUBSTITUTE
GOODS

// * OR SERVICES; LOSS OF USE, DATA, OR PROFITS; OR BUSINESS INTERRUPTION)
// * HOWEVER CAUSED AND ON ANY THEORY OF LIABILITY, WHETHER IN CONTRACT,
STRICT
// * LIABILITY, OR TORT (INCLUDING NEGLIGENCE OR OTHERWISE) ARISING IN ANY
WAY
// * OUT OF THE USE OF THIS SOFTWARE, EVEN IF ADVISED OF THE POSSIBILITY OF
// * SUCH DAMAGE.

47.OpenSSL

OpenSSL License

/*

=====

=====

* Copyright (c) 1998–2011 The OpenSSL Project. All rights reserved.

*

* Redistribution and use in source and binary forms, with or without

* modification, are permitted provided that the following conditions

* are met:

*

* 1. Redistributions of source code must retain the above copyright

* notice, this list of conditions and the following disclaimer.

*

* 2. Redistributions in binary form must reproduce the above copyright

* notice, this list of conditions and the following disclaimer in

* the documentation and/or other materials provided with the

* distribution.

*

* 3. All advertising materials mentioning features or use of this

* software must display the following acknowledgment:

* "This product includes software developed by the OpenSSL Project

* for use in the OpenSSL Toolkit. (<http://www.openssl.org/>)"

*

* 4. The names "OpenSSL Toolkit" and "OpenSSL Project" must not be used to

* endorse or promote products derived from this software without
* prior written permission. For written permission, please contact
* openssl-core@openssl.org.

*

* 5. Products derived from this software may not be called "OpenSSL"
* nor may "OpenSSL" appear in their names without prior written
* permission of the OpenSSL Project.

*

* 6. Redistributions of any form whatsoever must retain the following
* acknowledgment:

* "This product includes software developed by the OpenSSL Project
* for use in the OpenSSL Toolkit (<http://www.openssl.org/>)"

*

* THIS SOFTWARE IS PROVIDED BY THE OpenSSL PROJECT ``AS IS'' AND ANY
* EXPRESSED OR IMPLIED WARRANTIES, INCLUDING, BUT NOT LIMITED TO, THE
* IMPLIED WARRANTIES OF MERCHANTABILITY AND FITNESS FOR A PARTICULAR
* PURPOSE ARE DISCLAIMED. IN NO EVENT SHALL THE OpenSSL PROJECT OR
* ITS CONTRIBUTORS BE LIABLE FOR ANY DIRECT, INDIRECT, INCIDENTAL,
* SPECIAL, EXEMPLARY, OR CONSEQUENTIAL DAMAGES (INCLUDING, BUT

* NOT LIMITED TO, PROCUREMENT OF SUBSTITUTE GOODS OR SERVICES;
* LOSS OF USE, DATA, OR PROFITS; OR BUSINESS INTERRUPTION)
* HOWEVER CAUSED AND ON ANY THEORY OF LIABILITY, WHETHER IN CONTRACT,
* STRICT LIABILITY, OR TORT (INCLUDING NEGLIGENCE OR OTHERWISE)
* ARISING IN ANY WAY OUT OF THE USE OF THIS SOFTWARE, EVEN IF ADVISED
* OF THE POSSIBILITY OF SUCH DAMAGE.

*

=====
=====

*

* This product includes cryptographic software written by Eric Young
* (eay@cryptsoft.com). This product includes software written by Tim
* Hudson (tjh@cryptsoft.com).

*

*/

Original SSLeay License

/* Copyright (C) 1995-1998 Eric Young (eay@cryptsoft.com)

* All rights reserved.

*

* This package is an SSL implementation written

* by Eric Young (eay@cryptsoft.com).

* The implementation was written so as to conform with Netscapes SSL.

*

* This library is free for commercial and non-commercial use as long as

* the following conditions are aheared to. The following conditions

* apply to all code found in this distribution, be it the RC4, RSA,

* lhash, DES, etc., code; not just the SSL code. The SSL documentation

* included with this distribution is covered by the same copyright terms

* except that the holder is Tim Hudson (tjh@cryptsoft.com).

*

* Copyright remains Eric Young's, and as such any Copyright notices in

* the code are not to be removed.

* If this package is used in a product, Eric Young should be given attribution

* as the author of the parts of the library used.

* This can be in the form of a textual message at program startup or

- * in documentation (online or textual) provided with the package.
- *
- * Redistribution and use in source and binary forms, with or without
- * modification, are permitted provided that the following conditions
- * are met:
- * 1. Redistributions of source code must retain the copyright
- * notice, this list of conditions and the following disclaimer.
- * 2. Redistributions in binary form must reproduce the above copyright
- * notice, this list of conditions and the following disclaimer in the
- * documentation and/or other materials provided with the distribution.
- * 3. All advertising materials mentioning features or use of this software
- * must display the following acknowledgement:
- * "This product includes cryptographic software written by
- * Eric Young (eay@cryptsoft.com)"
- * The word 'cryptographic' can be left out if the routines from the library
- * being used are not cryptographic related :-).
- * 4. If you include any Windows specific code (or a derivative thereof) from
- * the apps directory (application code) you must include an acknowledgement:
- * "This product includes software written by Tim Hudson (tjh@cryptsoft.com)"

*

* THIS SOFTWARE IS PROVIDED BY ERIC YOUNG ``AS IS" AND

* ANY EXPRESS OR IMPLIED WARRANTIES, INCLUDING, BUT NOT LIMITED TO, THE

* IMPLIED WARRANTIES OF MERCHANTABILITY AND FITNESS FOR A PARTICULAR

PURPOSE

* ARE DISCLAIMED. IN NO EVENT SHALL THE AUTHOR OR CONTRIBUTORS BE LIABLE

* FOR ANY DIRECT, INDIRECT, INCIDENTAL, SPECIAL, EXEMPLARY, OR

CONSEQUENTIAL

* DAMAGES (INCLUDING, BUT NOT LIMITED TO, PROCUREMENT OF SUBSTITUTE

GOODS

* OR SERVICES; LOSS OF USE, DATA, OR PROFITS; OR BUSINESS INTERRUPTION)

* HOWEVER CAUSED AND ON ANY THEORY OF LIABILITY, WHETHER IN CONTRACT,

STRICT

* LIABILITY, OR TORT (INCLUDING NEGLIGENCE OR OTHERWISE) ARISING IN ANY WAY

* OUT OF THE USE OF THIS SOFTWARE, EVEN IF ADVISED OF THE POSSIBILITY OF

* SUCH DAMAGE.

*

* The licence and distribution terms for any publically available version or

* derivative of this code cannot be changed. i.e. this code cannot simply be

* copied and put under another distribution licence

* [including the GNU Public Licence.]

*/

/*

* Copyright (c) 2002 Bob Beck <beck@openbsd.org>

* Copyright (c) 2002 Theo de Raadt

* Copyright (c) 2002 Markus Friedl

* All rights reserved.

*

* Redistribution and use in source and binary forms, with or without

* modification, are permitted provided that the following conditions

* are met:

* 1. Redistributions of source code must retain the above copyright

* notice, this list of conditions and the following disclaimer.

* 2. Redistributions in binary form must reproduce the above copyright

* notice, this list of conditions and the following disclaimer in the

* documentation and/or other materials provided with the distribution.

*

* THIS SOFTWARE IS PROVIDED BY THE AUTHOR AND CONTRIBUTORS "AS IS" AND
ANY

* EXPRESS OR IMPLIED WARRANTIES, INCLUDING, BUT NOT LIMITED TO, THE
IMPLIED

* WARRANTIES OF MERCHANTABILITY AND FITNESS FOR A PARTICULAR PURPOSE
ARE

* DISCLAIMED. IN NO EVENT SHALL THE AUTHOR OR CONTRIBUTORS BE LIABLE
FOR ANY

* DIRECT, INDIRECT, INCIDENTAL, SPECIAL, EXEMPLARY, OR CONSEQUENTIAL
DAMAGES

* (INCLUDING, BUT NOT LIMITED TO, PROCUREMENT OF SUBSTITUTE GOODS OR
SERVICES;

* LOSS OF USE, DATA, OR PROFITS; OR BUSINESS INTERRUPTION) HOWEVER CAUSED
AND

* ON ANY THEORY OF LIABILITY, WHETHER IN CONTRACT, STRICT LIABILITY, OR
TORT

* (INCLUDING NEGLIGENCE OR OTHERWISE) ARISING IN ANY WAY OUT OF THE USE
OF

* THIS SOFTWARE, EVEN IF ADVISED OF THE POSSIBILITY OF SUCH DAMAGE.

*

*/

/*

* Copyright (c) 2004, Richard Levitte <richard@levitte.org>

* All rights reserved.

*

* Redistribution and use in source and binary forms, with or without

* modification, are permitted provided that the following conditions

* are met:

* 1. Redistributions of source code must retain the above copyright

* notice, this list of conditions and the following disclaimer.

* 2. Redistributions in binary form must reproduce the above copyright

* notice, this list of conditions and the following disclaimer in the

* documentation and/or other materials provided with the distribution.

*

* THIS SOFTWARE IS PROVIDED BY THE REGENTS AND CONTRIBUTORS ``AS IS'' AND

* ANY EXPRESS OR IMPLIED WARRANTIES, INCLUDING, BUT NOT LIMITED TO, THE

* IMPLIED WARRANTIES OF MERCHANTABILITY AND FITNESS FOR A PARTICULAR PURPOSE

* ARE DISCLAIMED. IN NO EVENT SHALL THE REGENTS OR CONTRIBUTORS BE LIABLE

* FOR ANY DIRECT, INDIRECT, INCIDENTAL, SPECIAL, EXEMPLARY, OR CONSEQUENTIAL

* DAMAGES (INCLUDING, BUT NOT LIMITED TO, PROCUREMENT OF SUBSTITUTE GOODS

* OR SERVICES; LOSS OF USE, DATA, OR PROFITS; OR BUSINESS INTERRUPTION)

* HOWEVER CAUSED AND ON ANY THEORY OF LIABILITY, WHETHER IN CONTRACT, STRICT

* LIABILITY, OR TORT (INCLUDING NEGLIGENCE OR OTHERWISE) ARISING IN ANY

WAY

* OUT OF THE USE OF THIS SOFTWARE, EVEN IF ADVISED OF THE POSSIBILITY OF

* SUCH DAMAGE.

*/

/* Copyright (c) 2014, Google Inc.

*

* Permission to use, copy, modify, and/or distribute this software for any
* purpose with or without fee is hereby granted, provided that the above
* copyright notice and this permission notice appear in all copies.

*

* THE SOFTWARE IS PROVIDED "AS IS" AND THE AUTHOR DISCLAIMS ALL

WARRANTIES

* WITH REGARD TO THIS SOFTWARE INCLUDING ALL IMPLIED WARRANTIES OF

* MERCHANTABILITY AND FITNESS. IN NO EVENT SHALL THE AUTHOR BE LIABLE FOR

ANY

* SPECIAL, DIRECT, INDIRECT, OR CONSEQUENTIAL DAMAGES OR ANY DAMAGES

* WHATSOEVER RESULTING FROM LOSS OF USE, DATA OR PROFITS, WHETHER IN AN

ACTION

* OF CONTRACT, NEGLIGENCE OR OTHER TORTIOUS ACTION, ARISING OUT OF OR

IN

* CONNECTION WITH THE USE OR PERFORMANCE OF THIS SOFTWARE.

*/

/*

=====

=====

* Copyright (c) 1998–2018 The OpenSSL Project. All rights reserved.

*

* Redistribution and use in source and binary forms, with or without

* modification, are permitted provided that the following conditions

* are met:

*

* 1. Redistributions of source code must retain the above copyright

* notice, this list of conditions and the following disclaimer.

*

* 2. Redistributions in binary form must reproduce the above copyright

* notice, this list of conditions and the following disclaimer in

* the documentation and/or other materials provided with the

* distribution.

*

* 3. All advertising materials mentioning features or use of this

* software must display the following acknowledgment:

* "This product includes software developed by the OpenSSL Project
* for use in the OpenSSL Toolkit. (<http://www.openssl.org/>)"

*

* 4. The names "OpenSSL Toolkit" and "OpenSSL Project" must not be used to
* endorse or promote products derived from this software without
* prior written permission. For written permission, please contact
* openssl-core@openssl.org.

*

* 5. Products derived from this software may not be called "OpenSSL"
* nor may "OpenSSL" appear in their names without prior written
* permission of the OpenSSL Project.

*

* 6. Redistributions of any form whatsoever must retain the following
* acknowledgment:

* "This product includes software developed by the OpenSSL Project
* for use in the OpenSSL Toolkit (<http://www.openssl.org/>)"

*

* THIS SOFTWARE IS PROVIDED BY THE OpenSSL PROJECT ``AS IS'' AND ANY
* EXPRESSED OR IMPLIED WARRANTIES, INCLUDING, BUT NOT LIMITED TO, THE

* IMPLIED WARRANTIES OF MERCHANTABILITY AND FITNESS FOR A PARTICULAR
* PURPOSE ARE DISCLAIMED. IN NO EVENT SHALL THE OpenSSL PROJECT OR
* ITS CONTRIBUTORS BE LIABLE FOR ANY DIRECT, INDIRECT, INCIDENTAL,
* SPECIAL, EXEMPLARY, OR CONSEQUENTIAL DAMAGES (INCLUDING, BUT
* NOT LIMITED TO, PROCUREMENT OF SUBSTITUTE GOODS OR SERVICES;
* LOSS OF USE, DATA, OR PROFITS; OR BUSINESS INTERRUPTION)
* HOWEVER CAUSED AND ON ANY THEORY OF LIABILITY, WHETHER IN CONTRACT,
* STRICT LIABILITY, OR TORT (INCLUDING NEGLIGENCE OR OTHERWISE)
* ARISING IN ANY WAY OUT OF THE USE OF THIS SOFTWARE, EVEN IF ADVISED
* OF THE POSSIBILITY OF SUCH DAMAGE.

*

=====

=====

*

* This product includes cryptographic software written by Eric Young
* (eay@cryptsoft.com). This product includes software written by Tim
* Hudson (tjh@cryptsoft.com).

*

*/

Original SSLeay License

/* Copyright (C) 1995-1998 Eric Young (eay@cryptsoft.com)

* All rights reserved.

*

* This package is an SSL implementation written

* by Eric Young (eay@cryptsoft.com).

* The implementation was written so as to conform with Netscapes SSL.

*

* This library is free for commercial and non-commercial use as long as

* the following conditions are aheared to. The following conditions

* apply to all code found in this distribution, be it the RC4, RSA,

* lhash, DES, etc., code; not just the SSL code. The SSL documentation

* included with this distribution is covered by the same copyright terms

* except that the holder is Tim Hudson (tjh@cryptsoft.com).

*

* Copyright remains Eric Young's, and as such any Copyright notices in

- * the code are not to be removed.
- * If this package is used in a product, Eric Young should be given attribution
- * as the author of the parts of the library used.
- * This can be in the form of a textual message at program startup or
- * in documentation (online or textual) provided with the package.
- *
- * Redistribution and use in source and binary forms, with or without
- * modification, are permitted provided that the following conditions
- * are met:
- * 1. Redistributions of source code must retain the copyright
- * notice, this list of conditions and the following disclaimer.
- * 2. Redistributions in binary form must reproduce the above copyright
- * notice, this list of conditions and the following disclaimer in the
- * documentation and/or other materials provided with the distribution.
- * 3. All advertising materials mentioning features or use of this software
- * must display the following acknowledgement:
- * "This product includes cryptographic software written by
- * Eric Young (eay@cryptsoft.com)"
- * The word 'cryptographic' can be left out if the rouines from the library

- * being used are not cryptographic related :-).
- * 4. If you include any Windows specific code (or a derivative thereof) from
- * the apps directory (application code) you must include an acknowledgement:
- * "This product includes software written by Tim Hudson (tjh@cryptsoft.com)"

*

* THIS SOFTWARE IS PROVIDED BY ERIC YOUNG ``AS IS" AND

* ANY EXPRESS OR IMPLIED WARRANTIES, INCLUDING, BUT NOT LIMITED TO, THE

* IMPLIED WARRANTIES OF MERCHANTABILITY AND FITNESS FOR A PARTICULAR

PURPOSE

* ARE DISCLAIMED. IN NO EVENT SHALL THE AUTHOR OR CONTRIBUTORS BE

LIABLE

* FOR ANY DIRECT, INDIRECT, INCIDENTAL, SPECIAL, EXEMPLARY, OR

CONSEQUENTIAL

* DAMAGES (INCLUDING, BUT NOT LIMITED TO, PROCUREMENT OF SUBSTITUTE

GOODS

* OR SERVICES; LOSS OF USE, DATA, OR PROFITS; OR BUSINESS INTERRUPTION)

* HOWEVER CAUSED AND ON ANY THEORY OF LIABILITY, WHETHER IN CONTRACT,

STRICT

* LIABILITY, OR TORT (INCLUDING NEGLIGENCE OR OTHERWISE) ARISING IN ANY
WAY

* OUT OF THE USE OF THIS SOFTWARE, EVEN IF ADVISED OF THE POSSIBILITY OF
* SUCH DAMAGE.

*

* The licence and distribution terms for any publically available version or
* derivative of this code cannot be changed. i.e. this code cannot simply be
* copied and put under another distribution licence
* [including the GNU Public Licence.]

*/

=====

=====

* Copyright (c) 1998–2008 The OpenSSL Project. All rights reserved.

*

* Redistribution and use in source and binary forms, with or without
* modification, are permitted provided that the following conditions
* are met:

*

- * 1. Redistributions of source code must retain the above copyright notice, this list of conditions and the following disclaimer.
- *
* 2. Redistributions in binary form must reproduce the above copyright notice, this list of conditions and the following disclaimer in the documentation and/or other materials provided with the distribution.
- *
* 3. All advertising materials mentioning features or use of this software must display the following acknowledgment:
* "This product includes software developed by the OpenSSL Project for use in the OpenSSL Toolkit. (<http://www.openssl.org/>)"
- *
* 4. The names "OpenSSL Toolkit" and "OpenSSL Project" must not be used to endorse or promote products derived from this software without prior written permission. For written permission, please contact openssl-core@openssl.org.
- *
* 5. Products derived from this software may not be called "OpenSSL"

* nor may "OpenSSL" appear in their names without prior written
* permission of the OpenSSL Project.

*

* 6. Redistributions of any form whatsoever must retain the following

* acknowledgment:

* "This product includes software developed by the OpenSSL Project
* for use in the OpenSSL Toolkit (<http://www.openssl.org/>)"

*

* THIS SOFTWARE IS PROVIDED BY THE OpenSSL PROJECT ``AS IS" AND ANY
* EXPRESSED OR IMPLIED WARRANTIES, INCLUDING, BUT NOT LIMITED TO, THE
* IMPLIED WARRANTIES OF MERCHANTABILITY AND FITNESS FOR A PARTICULAR
* PURPOSE ARE DISCLAIMED. IN NO EVENT SHALL THE OpenSSL PROJECT OR
* ITS CONTRIBUTORS BE LIABLE FOR ANY DIRECT, INDIRECT, INCIDENTAL,
* SPECIAL, EXEMPLARY, OR CONSEQUENTIAL DAMAGES (INCLUDING, BUT
* NOT LIMITED TO, PROCUREMENT OF SUBSTITUTE GOODS OR SERVICES;
* LOSS OF USE, DATA, OR PROFITS; OR BUSINESS INTERRUPTION)
* HOWEVER CAUSED AND ON ANY THEORY OF LIABILITY, WHETHER IN CONTRACT,
* STRICT LIABILITY, OR TORT (INCLUDING NEGLIGENCE OR OTHERWISE)
* ARISING IN ANY WAY OUT OF THE USE OF THIS SOFTWARE, EVEN IF ADVISED

* OF THE POSSIBILITY OF SUCH DAMAGE.

*

=====
=====

/* Copyright (C) 1995-1998 Eric Young (eay@cryptsoft.com)

* All rights reserved.

*

* This package is an SSL implementation written

* by Eric Young (eay@cryptsoft.com).

* The implementation was written so as to conform with Netscapes SSL.

*

* This library is free for commercial and non-commercial use as long as

* the following conditions are aheared to. The following conditions

* apply to all code found in this distribution, be it the RC4, RSA,

* lhash, DES, etc., code; not just the SSL code. The SSL documentation

* included with this distribution is covered by the same copyright terms

* except that the holder is Tim Hudson (tjh@cryptsoft.com).

*

- * Copyright remains Eric Young's, and as such any Copyright notices in
- * the code are not to be removed.
- * If this package is used in a product, Eric Young should be given attribution
- * as the author of the parts of the library used.
- * This can be in the form of a textual message at program startup or
- * in documentation (online or textual) provided with the package.
- *
- * Redistribution and use in source and binary forms, with or without
- * modification, are permitted provided that the following conditions
- * are met:
- * 1. Redistributions of source code must retain the copyright
- * notice, this list of conditions and the following disclaimer.
- * 2. Redistributions in binary form must reproduce the above copyright
- * notice, this list of conditions and the following disclaimer in the
- * documentation and/or other materials provided with the distribution.
- * 3. All advertising materials mentioning features or use of this software
- * must display the following acknowledgement:
- * "This product includes cryptographic software written by
- * Eric Young (eay@cryptsoft.com)"

- * The word 'cryptographic' can be left out if the routines from the library
- * being used are not cryptographic related :-).
- * 4. If you include any Windows specific code (or a derivative thereof) from
- * the apps directory (application code) you must include an acknowledgement:
- * "This product includes software written by Tim Hudson (tjh@cryptsoft.com)"

*

* THIS SOFTWARE IS PROVIDED BY ERIC YOUNG ``AS IS" AND

* ANY EXPRESS OR IMPLIED WARRANTIES, INCLUDING, BUT NOT LIMITED TO, THE

* IMPLIED WARRANTIES OF MERCHANTABILITY AND FITNESS FOR A PARTICULAR

PURPOSE

* ARE DISCLAIMED. IN NO EVENT SHALL THE AUTHOR OR CONTRIBUTORS BE

LIABLE

* FOR ANY DIRECT, INDIRECT, INCIDENTAL, SPECIAL, EXEMPLARY, OR

CONSEQUENTIAL

* DAMAGES (INCLUDING, BUT NOT LIMITED TO, PROCUREMENT OF SUBSTITUTE

GOODS

* OR SERVICES; LOSS OF USE, DATA, OR PROFITS; OR BUSINESS INTERRUPTION)

* HOWEVER CAUSED AND ON ANY THEORY OF LIABILITY, WHETHER IN CONTRACT,

STRICT

* LIABILITY, OR TORT (INCLUDING NEGLIGENCE OR OTHERWISE) ARISING IN ANY
WAY

* OUT OF THE USE OF THIS SOFTWARE, EVEN IF ADVISED OF THE POSSIBILITY OF
* SUCH DAMAGE.

*

* The licence and distribution terms for any publically available version or
* derivative of this code cannot be changed. i.e. this code cannot simply be
* copied and put under another distribution licence
* [including the GNU Public Licence.]

*/

48.OSGi Release 5

Apache License

Version 2.0, January 2004

<http://www.apache.org/licenses/>

TERMS AND CONDITIONS FOR USE, REPRODUCTION, AND DISTRIBUTION

1. Definitions.

"License" shall mean the terms and conditions for use, reproduction, and distribution as defined by Sections 1 through 9 of this document.

"Licensor" shall mean the copyright owner or entity authorized by the copyright owner that is granting the License.

"Legal Entity" shall mean the union of the acting entity and all other entities that control, are controlled by, or are under common control with that entity. For the purposes of this definition,

"control" means (i) the power, direct or indirect, to cause the direction or management of such entity, whether by contract or otherwise, or (ii) ownership of fifty percent (50%) or more of the outstanding shares, or (iii) beneficial ownership of such entity.

"You" (or "Your") shall mean an individual or Legal Entity exercising permissions granted by this License.

"Source" form shall mean the preferred form for making modifications, including but not limited to software source code, documentation source, and configuration files.

"Object" form shall mean any form resulting from mechanical transformation or translation of a Source form, including but not limited to compiled object code, generated documentation, and conversions to other media types.

"Work" shall mean the work of authorship, whether in Source or Object form, made available under the License, as indicated by a

copyright notice that is included in or attached to the work

(an example is provided in the Appendix below).

"Derivative Works" shall mean any work, whether in Source or Object form, that is based on (or derived from) the Work and for which the editorial revisions, annotations, elaborations, or other modifications represent, as a whole, an original work of authorship. For the purposes of this License, Derivative Works shall not include works that remain separable from, or merely link (or bind by name) to the interfaces of, the Work and Derivative Works thereof.

"Contribution" shall mean any work of authorship, including the original version of the Work and any modifications or additions to that Work or Derivative Works thereof, that is intentionally submitted to Licensor for inclusion in the Work by the copyright owner or by an individual or Legal Entity authorized to submit on behalf of the copyright owner. For the purposes of this definition, "submitted" means any form of electronic, verbal, or written communication sent to the Licensor or its representatives, including but not limited to

communication on electronic mailing lists, source code control systems, and issue tracking systems that are managed by, or on behalf of, the Licensor for the purpose of discussing and improving the Work, but excluding communication that is conspicuously marked or otherwise designated in writing by the copyright owner as "Not a Contribution."

"Contributor" shall mean Licensor and any individual or Legal Entity on behalf of whom a Contribution has been received by Licensor and subsequently incorporated within the Work.

2. Grant of Copyright License. Subject to the terms and conditions of this License, each Contributor hereby grants to You a perpetual, worldwide, non-exclusive, no-charge, royalty-free, irrevocable copyright license to reproduce, prepare Derivative Works of, publicly display, publicly perform, sublicense, and distribute the Work and such Derivative Works in Source or Object form.

3. Grant of Patent License. Subject to the terms and conditions of this License, each Contributor hereby grants to You a perpetual,

worldwide, non-exclusive, no-charge, royalty-free, irrevocable (except as stated in this section) patent license to make, have made, use, offer to sell, sell, import, and otherwise transfer the Work, where such license applies only to those patent claims licensable by such Contributor that are necessarily infringed by their Contribution(s) alone or by combination of their Contribution(s) with the Work to which such Contribution(s) was submitted. If You institute patent litigation against any entity (including a cross-claim or counterclaim in a lawsuit) alleging that the Work or a Contribution incorporated within the Work constitutes direct or contributory patent infringement, then any patent licenses granted to You under this License for that Work shall terminate as of the date such litigation is filed.

4. Redistribution. You may reproduce and distribute copies of the Work or Derivative Works thereof in any medium, with or without modifications, and in Source or Object form, provided that You meet the following conditions:

(a) You must give any other recipients of the Work or
Derivative Works a copy of this License; and

(b) You must cause any modified files to carry prominent notices
stating that You changed the files; and

(c) You must retain, in the Source form of any Derivative Works
that You distribute, all copyright, patent, trademark, and
attribution notices from the Source form of the Work,
excluding those notices that do not pertain to any part of
the Derivative Works; and

(d) If the Work includes a "NOTICE" text file as part of its
distribution, then any Derivative Works that You distribute must
include a readable copy of the attribution notices contained
within such NOTICE file, excluding those notices that do not
pertain to any part of the Derivative Works, in at least one
of the following places: within a NOTICE text file distributed
as part of the Derivative Works; within the Source form or

documentation, if provided along with the Derivative Works; or, within a display generated by the Derivative Works, if and wherever such third-party notices normally appear. The contents of the NOTICE file are for informational purposes only and do not modify the License. You may add Your own attribution notices within Derivative Works that You distribute, alongside or as an addendum to the NOTICE text from the Work, provided that such additional attribution notices cannot be construed as modifying the License.

You may add Your own copyright statement to Your modifications and may provide additional or different license terms and conditions for use, reproduction, or distribution of Your modifications, or for any such Derivative Works as a whole, provided Your use, reproduction, and distribution of the Work otherwise complies with the conditions stated in this License.

5. Submission of Contributions. Unless You explicitly state otherwise, any Contribution intentionally submitted for inclusion in the Work

by You to the Licensor shall be under the terms and conditions of this License, without any additional terms or conditions.

Notwithstanding the above, nothing herein shall supersede or modify the terms of any separate license agreement you may have executed with Licensor regarding such Contributions.

6. Trademarks. This License does not grant permission to use the trade names, trademarks, service marks, or product names of the Licensor, except as required for reasonable and customary use in describing the origin of the Work and reproducing the content of the NOTICE file.

7. Disclaimer of Warranty. Unless required by applicable law or agreed to in writing, Licensor provides the Work (and each Contributor provides its Contributions) on an "AS IS" BASIS, WITHOUT WARRANTIES OR CONDITIONS OF ANY KIND, either express or implied, including, without limitation, any warranties or conditions of TITLE, NON-INFRINGEMENT, MERCHANTABILITY, or FITNESS FOR A PARTICULAR PURPOSE. You are solely responsible for determining the appropriateness of using or redistributing the Work and assume any

risks associated with Your exercise of permissions under this License.

8. Limitation of Liability. In no event and under no legal theory, whether in tort (including negligence), contract, or otherwise, unless required by applicable law (such as deliberate and grossly negligent acts) or agreed to in writing, shall any Contributor be liable to You for damages, including any direct, indirect, special, incidental, or consequential damages of any character arising as a result of this License or out of the use or inability to use the Work (including but not limited to damages for loss of goodwill, work stoppage, computer failure or malfunction, or any and all other commercial damages or losses), even if such Contributor has been advised of the possibility of such damages.

9. Accepting Warranty or Additional Liability. While redistributing the Work or Derivative Works thereof, You may choose to offer, and charge a fee for, acceptance of support, warranty, indemnity, or other liability obligations and/or rights consistent with this License. However, in accepting such obligations, You may act only

on Your own behalf and on Your sole responsibility, not on behalf of any other Contributor, and only if You agree to indemnify, defend, and hold each Contributor harmless for any liability incurred by, or claims asserted against, such Contributor by reason of your accepting any such warranty or additional liability.

END OF TERMS AND CONDITIONS

APPENDIX: How to apply the Apache License to your work.

To apply the Apache License to your work, attach the following boilerplate notice, with the fields enclosed by brackets "[]" replaced with your own identifying information. (Don't include the brackets!) The text should be enclosed in the appropriate comment syntax for the file format. We also recommend that a file or class name and description of purpose be included on the same "printed page" as the copyright notice for easier identification within third-party archives.

Copyright [yyyy] [name of copyright owner]

Licensed under the Apache License, Version 2.0 (the "License");

you may not use this file except in compliance with the License.

You may obtain a copy of the License at

<http://www.apache.org/licenses/LICENSE-2.0>

Unless required by applicable law or agreed to in writing, software

distributed under the License is distributed on an "AS IS" BASIS,

WITHOUT WARRANTIES OR CONDITIONS OF ANY KIND, either express or implied.

See the License for the specific language governing permissions and

limitations under the License.

49. Paho MQTT Client

Eclipse Distribution License – v 1.0

Copyright (c) 2007, Eclipse Foundation, Inc. and its licensors.

All rights reserved.

Redistribution and use in source and binary forms, with or without modification, are permitted provided that the following conditions are met:

- Redistributions of source code must retain the above copyright notice, this list of conditions and the following disclaimer.
- Redistributions in binary form must reproduce the above copyright notice, this list of conditions and the following disclaimer in the documentation and/or other materials provided with the distribution.
- Neither the name of the Eclipse Foundation, Inc. nor the names of its contributors may be used to endorse or promote products derived from this software without specific prior written permission.

THIS SOFTWARE IS PROVIDED BY THE COPYRIGHT HOLDERS AND CONTRIBUTORS "AS IS" AND ANY EXPRESS OR IMPLIED WARRANTIES, INCLUDING, BUT NOT LIMITED TO, THE IMPLIED WARRANTIES OF MERCHANTABILITY AND FITNESS FOR A PARTICULAR

PURPOSE ARE DISCLAIMED. IN NO EVENT SHALL THE COPYRIGHT OWNER OR CONTRIBUTORS BE LIABLE FOR ANY DIRECT, INDIRECT, INCIDENTAL, SPECIAL, EXEMPLARY, OR CONSEQUENTIAL DAMAGES (INCLUDING, BUT NOT LIMITED TO, PROCUREMENT OF SUBSTITUTE GOODS OR SERVICES; LOSS OF USE, DATA, OR PROFITS; OR BUSINESS INTERRUPTION) HOWEVER CAUSED AND ON ANY THEORY OF LIABILITY, WHETHER IN CONTRACT, STRICT LIABILITY, OR TORT (INCLUDING NEGLIGENCE OR OTHERWISE) ARISING IN ANY WAY OUT OF THE USE OF THIS SOFTWARE, EVEN IF ADVISED OF THE POSSIBILITY OF SUCH DAMAGE.

50.pango (part of OpenTypeCode)

Copyright (C) 2009 Red Hat, Inc.

Copyright (C) 1998–2004 David Turner and Werner Lemberg

Copyright (C) 2004,2007 Red Hat, Inc.

Copyright (C) 2004,2007,2009 Red Hat, Inc.

Copyright (C) 2007,2008,2009 Red Hat, Inc.

Copyright (C) 2007 Chris Wilson

Permission is hereby granted, without written agreement and without license or royalty fees, to use, copy, modify, and distribute this software and its documentation for any purpose, provided that the above copyright notice and the following two paragraphs appear in all copies of this software.

IN NO EVENT SHALL THE COPYRIGHT HOLDER BE LIABLE TO ANY PARTY FOR DIRECT, INDIRECT, SPECIAL, INCIDENTAL, OR CONSEQUENTIAL DAMAGES ARISING OUT OF THE USE OF THIS SOFTWARE AND ITS DOCUMENTATION, EVEN

IF THE COPYRIGHT HOLDER HAS BEEN ADVISED OF THE POSSIBILITY OF SUCH DAMAGE.

THE COPYRIGHT HOLDER SPECIFICALLY DISCLAIMS ANY WARRANTIES, INCLUDING, BUT NOT LIMITED TO, THE IMPLIED WARRANTIES OF MERCHANTABILITY AND FITNESS FOR A PARTICULAR PURPOSE. THE SOFTWARE PROVIDED HEREUNDER IS ON AN "AS IS" BASIS, AND THE COPYRIGHT HOLDER HAS NO OBLIGATION TO PROVIDE MAINTENANCE, SUPPORT, UPDATES, ENHANCEMENTS, OR MODIFICATIONS.

51.pixman

/*

- * Copyright 1987, 1988, 1989, 1998 The Open Group
- * Copyright 1987, 1988, 1989 Digital Equipment Corporation
- * Copyright 1999, 2004, 2008 Keith Packard
- * Copyright 2000 SuSE, Inc.
- * Copyright 2000 Keith Packard, member of The XFree86 Project, Inc.
- * Copyright 2004, 2005, 2007, 2008, 2009, 2010 Red Hat, Inc.
- * Copyright 2004 Nicholas Miell
- * Copyright 2005 Lars Knoll & Zack Rusin, Trolltech
- * Copyright 2005 Trolltech AS
- * Copyright 2007 Luca Barbato
- * Copyright 2008 Aaron Plattner, NVIDIA Corporation
- * Copyright 2008 Rodrigo Kumpera
- * Copyright 2008 André Tupinambá
- * Copyright 2008 Mozilla Corporation
- * Copyright 2008 Frederic Plourde
- * Copyright 2009, Oracle and/or its affiliates. All rights reserved.

* Copyright 2009, 2010 Nokia Corporation

*

* Permission is hereby granted, free of charge, to any person obtaining a
* copy of this software and associated documentation files (the "Software"),
* to deal in the Software without restriction, including without limitation
* the rights to use, copy, modify, merge, publish, distribute, sublicense,
* and/or sell copies of the Software, and to permit persons to whom the
* Software is furnished to do so, subject to the following conditions:

*

* The above copyright notice and this permission notice (including the next
* paragraph) shall be included in all copies or substantial portions of the
* Software.

*

* THE SOFTWARE IS PROVIDED "AS IS", WITHOUT WARRANTY OF ANY KIND, EXPRESS
OR
* IMPLIED, INCLUDING BUT NOT LIMITED TO THE WARRANTIES OF
MERCHANTABILITY,
* FITNESS FOR A PARTICULAR PURPOSE AND NONINFRINGEMENT. IN NO EVENT
SHALL

* THE AUTHORS OR COPYRIGHT HOLDERS BE LIABLE FOR ANY CLAIM, DAMAGES OR OTHER

* LIABILITY, WHETHER IN AN ACTION OF CONTRACT, TORT OR OTHERWISE, ARISING FROM, OUT OF OR IN CONNECTION WITH THE SOFTWARE OR THE USE OR OTHER DEALINGS IN THE SOFTWARE.

*/

52. Protocol Buffers

Copyright 2008, Google Inc.

All rights reserved.

Redistribution and use in source and binary forms, with or without modification, are permitted provided that the following conditions are met:

- * Redistributions of source code must retain the above copyright notice, this list of conditions and the following disclaimer.

- * Redistributions in binary form must reproduce the above copyright notice, this list of conditions and the following disclaimer in the documentation and/or other materials provided with the distribution.

- * Neither the name of Google Inc. nor the names of its contributors may be used to endorse or promote products derived from this software without specific prior written permission.

THIS SOFTWARE IS PROVIDED BY THE COPYRIGHT HOLDERS AND CONTRIBUTORS "AS IS" AND ANY EXPRESS OR IMPLIED WARRANTIES, INCLUDING, BUT NOT LIMITED TO,

THE IMPLIED WARRANTIES OF MERCHANTABILITY AND FITNESS FOR A PARTICULAR PURPOSE ARE DISCLAIMED. IN NO EVENT SHALL THE COPYRIGHT OWNER OR CONTRIBUTORS BE LIABLE FOR ANY DIRECT, INDIRECT, INCIDENTAL, SPECIAL, EXEMPLARY, OR CONSEQUENTIAL DAMAGES (INCLUDING, BUT NOT LIMITED TO, PROCUREMENT OF SUBSTITUTE GOODS OR SERVICES; LOSS OF USE, DATA, OR PROFITS; OR BUSINESS INTERRUPTION) HOWEVER CAUSED AND ON ANY THEORY OF LIABILITY, WHETHER IN CONTRACT, STRICT LIABILITY, OR TORT (INCLUDING NEGLIGENCE OR OTHERWISE) ARISING IN ANY WAY OUT OF THE USE OF THIS SOFTWARE, EVEN IF ADVISED OF THE POSSIBILITY OF SUCH DAMAGE.

Code generated by the Protocol Buffer compiler is owned by the owner of the input file used when generating it. This code is not standalone and requires a support library to be linked with it. This support library is itself covered by the above license.

53.[servlet.jar](#)

Apache License

Version 2.0, January 2004

<http://www.apache.org/licenses/>

TERMS AND CONDITIONS FOR USE, REPRODUCTION, AND DISTRIBUTION

1. Definitions.

"License" shall mean the terms and conditions for use, reproduction, and distribution as defined by Sections 1 through 9 of this document.

"Licensor" shall mean the copyright owner or entity authorized by the copyright owner that is granting the License.

"Legal Entity" shall mean the union of the acting entity and all other entities that control, are controlled by, or are under common control with that entity. For the purposes of this definition, "control" means (i) the power, direct or indirect, to cause the direction or management of such entity, whether by contract or otherwise, or (ii) ownership of fifty percent (50%) or more of the outstanding shares, or (iii) beneficial ownership of such entity.

"You" (or "Your") shall mean an individual or Legal Entity exercising permissions granted by this License.

"Source" form shall mean the preferred form for making modifications, including but not limited to software source code, documentation source, and configuration files.

"Object" form shall mean any form resulting from mechanical transformation or translation of a Source form, including but not limited to compiled object code, generated documentation, and conversions to other media types.

"Work" shall mean the work of authorship, whether in Source or Object form, made available under the License, as indicated by a copyright notice that is included in or attached to the work (an example is provided in the Appendix below).

"Derivative Works" shall mean any work, whether in Source or Object form, that is based on (or derived from) the Work and for which the editorial revisions, annotations, elaborations, or other modifications represent, as a whole, an original work of authorship. For the purposes of this License, Derivative Works shall not include works that remain separable from, or merely link (or bind by name) to the interfaces of, the Work and Derivative Works thereof.

"Contribution" shall mean any work of authorship, including the original version of the Work and any modifications or additions to that Work or Derivative Works thereof, that is intentionally submitted to Licensor for inclusion in the Work by the copyright owner or by an individual or Legal Entity authorized to submit on behalf of the copyright owner. For the purposes of this definition, "submitted" means any form of

electronic, verbal, or written communication sent to the Licensor or its representatives, including but not limited to communication on electronic mailing lists, source code control systems, and issue tracking systems that are managed by, or on behalf of, the Licensor for the purpose of discussing and improving the Work, but excluding communication that is conspicuously marked or otherwise designated in writing by the copyright owner as "Not a Contribution."

"Contributor" shall mean Licensor and any individual or Legal Entity on behalf of whom a Contribution has been received by Licensor and subsequently incorporated within the Work.

2. Grant of Copyright License.

Subject to the terms and conditions of this License, each Contributor hereby grants to You a perpetual, worldwide, non-exclusive, no-charge, royalty-free, irrevocable copyright license to reproduce, prepare Derivative Works of, publicly display, publicly perform, sublicense, and distribute the Work and such Derivative Works in Source or Object form.

3. Grant of Patent License.

Subject to the terms and conditions of this License, each Contributor hereby grants to You a perpetual, worldwide, non-exclusive, no-charge, royalty-free, irrevocable (except as stated in this section) patent license to make, have made, use, offer to sell,

sell, import, and otherwise transfer the Work, where such license applies only to those patent claims licensable by such Contributor that are necessarily infringed by their Contribution(s) alone or by combination of their Contribution(s) with the Work to which such Contribution(s) was submitted. If You institute patent litigation against any entity (including a cross-claim or counterclaim in a lawsuit) alleging that the Work or a Contribution incorporated within the Work constitutes direct or contributory patent infringement, then any patent licenses granted to You under this License for that Work shall terminate as of the date such litigation is filed.

4. Redistribution.

You may reproduce and distribute copies of the Work or Derivative Works thereof in any medium, with or without modifications, and in Source or Object form, provided that You meet the following conditions:

You must give any other recipients of the Work or Derivative Works a copy of this License; and

You must cause any modified files to carry prominent notices stating that You changed the files; and

You must retain, in the Source form of any Derivative Works that You distribute, all copyright, patent, trademark, and attribution notices from the Source form of the

Work, excluding those notices that do not pertain to any part of the Derivative Works; and

If the Work includes a "NOTICE" text file as part of its distribution, then any Derivative Works that You distribute must include a readable copy of the attribution notices contained within such NOTICE file, excluding those notices that do not pertain to any part of the Derivative Works, in at least one of the following places: within a NOTICE text file distributed as part of the Derivative Works; within the Source form or documentation, if provided along with the Derivative Works; or, within a display generated by the Derivative Works, if and wherever such third-party notices normally appear. The contents of the NOTICE file are for informational purposes only and do not modify the License. You may add Your own attribution notices within Derivative Works that You distribute, alongside or as an addendum to the NOTICE text from the Work, provided that such additional attribution notices cannot be construed as modifying the License.

You may add Your own copyright statement to Your modifications and may provide additional or different license terms and conditions for use, reproduction, or distribution of Your modifications, or for any such Derivative Works as a whole, provided Your use, reproduction, and distribution of the Work otherwise complies with the conditions stated in this License.

5. Submission of Contributions.

Unless You explicitly state otherwise, any Contribution intentionally submitted for inclusion in the Work by You to the Licensor shall be under the terms and conditions of this License, without any additional terms or conditions. Notwithstanding the above, nothing herein shall supersede or modify the terms of any separate license agreement you may have executed with Licensor regarding such Contributions.

6. Trademarks.

This License does not grant permission to use the trade names, trademarks, service marks, or product names of the Licensor, except as required for reasonable and customary use in describing the origin of the Work and reproducing the content of the NOTICE file.

7. Disclaimer of Warranty.

Unless required by applicable law or agreed to in writing, Licensor provides the Work (and each Contributor provides its Contributions) on an "AS IS" BASIS, WITHOUT WARRANTIES OR CONDITIONS OF ANY KIND, either express or implied, including, without limitation, any warranties or conditions of TITLE, NON-INFRINGEMENT, MERCHANTABILITY, or FITNESS FOR A PARTICULAR PURPOSE. You are solely responsible for determining the appropriateness of using or redistributing the Work

and assume any risks associated with Your exercise of permissions under this License.

8. Limitation of Liability.

In no event and under no legal theory, whether in tort (including negligence), contract, or otherwise, unless required by applicable law (such as deliberate and grossly negligent acts) or agreed to in writing, shall any Contributor be liable to You for damages, including any direct, indirect, special, incidental, or consequential damages of any character arising as a result of this License or out of the use or inability to use the Work (including but not limited to damages for loss of goodwill, work stoppage, computer failure or malfunction, or any and all other commercial damages or losses), even if such Contributor has been advised of the possibility of such damages.

9. Accepting Warranty or Additional Liability.

While redistributing the Work or Derivative Works thereof, You may choose to offer, and charge a fee for, acceptance of support, warranty, indemnity, or other liability obligations and/or rights consistent with this License. However, in accepting such obligations, You may act only on Your own behalf and on Your sole responsibility, not on behalf of any other Contributor, and only if You agree to indemnify, defend, and hold each Contributor harmless for any liability incurred by, or claims asserted

against, such Contributor by reason of your accepting any such warranty or additional liability.

END OF TERMS AND CONDITIONS

APPENDIX: How to apply the Apache License to your work

To apply the Apache License to your work, attach the following boilerplate notice, with the fields enclosed by brackets "[]" replaced with your own identifying information. (Don't include the brackets!) The text should be enclosed in the appropriate comment syntax for the file format. We also recommend that a file or class name and description of purpose be included on the same "printed page" as the copyright notice for easier identification within third-party archives.

Copyright [yyyy] [name of copyright owner]

Licensed under the Apache License, Version 2.0 (the "License");
you may not use this file except in compliance with the License.

You may obtain a copy of the License at

<http://www.apache.org/licenses/LICENSE-2.0>

Unless required by applicable law or agreed to in writing, software

distributed under the License is distributed on an "AS IS" BASIS,
WITHOUT WARRANTIES OR CONDITIONS OF ANY KIND, either express or implied.
See the License for the specific language governing permissions and
limitations under the License.

54.SQLite

SQLite Copyright

All of the code and documentation in SQLite has been dedicated to the public domain by the authors. All code authors, and representatives of the companies they work for, have signed affidavits dedicating their contributions to the public domain and originals of those signed affidavits are stored in a firesafe at the main offices of Hwaci. Anyone is free to copy, modify, publish, use, compile, sell, or distribute the original SQLite code, either in source code form or as a compiled binary, for any purpose, commercial or non-commercial, and by any means.

The previous paragraph applies to the deliverable code and documentation in SQLite – those parts of the SQLite library that you actually bundle and ship with a larger

application. Some scripts used as part of the build process (for example the "configure" scripts generated by autoconf) might fall under other open-source licenses. Nothing from these build scripts ever reaches the final deliverable SQLite library, however, and so the licenses associated with those scripts should not be a factor in assessing your rights to copy and use the SQLite library.

All of the deliverable code in SQLite has been written from scratch. No code has been taken from other projects or from the open internet. Every line of code can be traced back to its original author, and all of those authors have public domain dedications on file. So the SQLite code base is clean and is uncontaminated with licensed code from other projects.

55.tablesorter

Copyright (c) 2014 Christian Bach

Permission is hereby granted, free of charge, to any person obtaining a copy of this software and associated documentation files (the "Software"), to deal in the Software without restriction, including without limitation the rights to use, copy, modify, merge, publish, distribute, sublicense, and/or sell copies of the Software, and to permit persons to whom the Software is furnished to do so, subject to the following conditions:

The above copyright notice and this permission notice shall be included in all copies or substantial portions of the Software.

THE SOFTWARE IS PROVIDED "AS IS", WITHOUT WARRANTY OF ANY KIND, EXPRESS OR IMPLIED, INCLUDING BUT NOT LIMITED TO THE WARRANTIES OF MERCHANTABILITY, FITNESS FOR A PARTICULAR PURPOSE AND NONINFRINGEMENT. IN NO EVENT SHALL THE AUTHORS OR COPYRIGHT HOLDERS BE LIABLE FOR ANY CLAIM, DAMAGES OR OTHER LIABILITY, WHETHER IN AN ACTION OF CONTRACT, TORT OR OTHERWISE, ARISING FROM, OUT OF OR IN CONNECTION WITH THE SOFTWARE OR THE USE OR OTHER DEALINGS IN THE SOFTWARE.

56.wpa_supplicant-2.9

wpa_supplicant and hostapd

Copyright (c) 2002–2019, Jouni Malinen <j@w1.fi> and contributors

All Rights Reserved.

These programs are licensed under the BSD license (the one with advertisement clause removed).

If you are submitting changes to the project, please see CONTRIBUTIONS file for more instructions.

This package may include either wpa_supplicant, hostapd, or both. See README file respective subdirectories (wpa_supplicant/README or hostapd/README) for more details.

Source code files were moved around in v0.6.x releases and compared to earlier releases, the programs are now built by first going to a subdirectory (wpa_supplicant

or hostapd) and creating build configuration (.config) and running 'make' there (for Linux/BSD/cygwin builds).

License

This software may be distributed, used, and modified under the terms of BSD license:

Redistribution and use in source and binary forms, with or without modification, are permitted provided that the following conditions are met:

1. Redistributions of source code must retain the above copyright notice, this list of conditions and the following disclaimer.
2. Redistributions in binary form must reproduce the above copyright notice, this list of conditions and the following disclaimer in the documentation and/or other materials provided with the distribution.

3. Neither the name(s) of the above-listed copyright holder(s) nor the names of its contributors may be used to endorse or promote products derived from this software without specific prior written permission.

THIS SOFTWARE IS PROVIDED BY THE COPYRIGHT HOLDERS AND CONTRIBUTORS "AS IS" AND ANY EXPRESS OR IMPLIED WARRANTIES, INCLUDING, BUT NOT LIMITED TO, THE IMPLIED WARRANTIES OF MERCHANTABILITY AND FITNESS FOR A PARTICULAR PURPOSE ARE DISCLAIMED. IN NO EVENT SHALL THE COPYRIGHT OWNER OR CONTRIBUTORS BE LIABLE FOR ANY DIRECT, INDIRECT, INCIDENTAL, SPECIAL, EXEMPLARY, OR CONSEQUENTIAL DAMAGES (INCLUDING, BUT NOT LIMITED TO, PROCUREMENT OF SUBSTITUTE GOODS OR SERVICES; LOSS OF USE, DATA, OR PROFITS; OR BUSINESS INTERRUPTION) HOWEVER CAUSED AND ON ANY THEORY OF LIABILITY, WHETHER IN CONTRACT, STRICT LIABILITY, OR TORT (INCLUDING NEGLIGENCE OR OTHERWISE) ARISING IN ANY WAY OUT OF THE USE OF THIS SOFTWARE, EVEN IF ADVISED OF THE POSSIBILITY OF SUCH DAMAGE.

57.X Window System

Copyright 1984 – 1996, 1998, 2002 The Open Group

Permission to use, copy, modify, distribute, and sell this software and its documentation for any purpose is hereby granted without fee, provided that the above copyright notice appear in all copies and that both that copyright notice and this permission notice appear in supporting documentation.

The above copyright notice and this permission notice shall be included in all copies or substantial portions of the Software.

THE SOFTWARE IS PROVIDED "AS IS", WITHOUT WARRANTY OF ANY KIND, EXPRESS OR IMPLIED, INCLUDING BUT NOT LIMITED TO THE WARRANTIES OF MERCHANTABILITY, FITNESS FOR A PARTICULAR PURPOSE AND NONINFRINGEMENT. IN NO EVENT SHALL THE OPEN GROUP BE LIABLE FOR ANY CLAIM, DAMAGES OR OTHER LIABILITY, WHETHER IN

AN ACTION OF CONTRACT, TORT OR OTHERWISE, ARISING FROM, OUT OF OR IN CONNECTION WITH THE SOFTWARE OR THE USE OR OTHER DEALINGS IN THE SOFTWARE.

Except as contained in this notice, the name of The Open Group shall not be used in advertising or otherwise to promote the sale, use or other dealings in this Software without prior written authorization from The Open Group.

Copyright (c) 1991, 2002, 2004 – 2009 Oracle and/or its affiliates. All rights reserved.

Permission is hereby granted, free of charge, to any person obtaining a copy of this software and associated documentation files (the "Software"), to deal in the Software without restriction, including without limitation the rights to use, copy, modify, merge, publish, distribute, sublicense, and/or sell copies of the Software, and to permit persons to whom the Software is furnished to do so, subject to the following conditions:

The above copyright notice and this permission notice (including the next paragraph) shall be included in all copies or substantial portions of the Software.

THE SOFTWARE IS PROVIDED "AS IS", WITHOUT WARRANTY OF ANY KIND, EXPRESS OR IMPLIED, INCLUDING BUT NOT LIMITED TO THE WARRANTIES OF MERCHANTABILITY, FITNESS FOR A PARTICULAR PURPOSE AND NONINFRINGEMENT. IN NO EVENT SHALL THE AUTHORS OR COPYRIGHT HOLDERS BE LIABLE FOR ANY CLAIM, DAMAGES OR OTHER LIABILITY, WHETHER IN AN ACTION OF CONTRACT, TORT OR OTHERWISE, ARISING FROM, OUT OF OR IN CONNECTION WITH THE SOFTWARE OR THE USE OR OTHER DEALINGS IN THE SOFTWARE.

Copyright © 1999 – 2001, 2003, 2004, 2008 Keith Packard

Permission to use, copy, modify, distribute, and sell this software and its documentation for any purpose is hereby granted without fee, provided that the above copyright notice appear in all copies and that both that

copyright notice and this permission notice appear in supporting documentation, and that the name of Keith Packard not be used in advertising or publicity pertaining to distribution of the software without specific, written prior permission. Keith Packard makes no representations about the suitability of this software for any purpose. It is provided "as is" without express or implied warranty.

KEITH PACKARD DISCLAIMS ALL WARRANTIES WITH REGARD TO THIS SOFTWARE, INCLUDING ALL IMPLIED WARRANTIES OF MERCHANTABILITY AND FITNESS, IN NO EVENT SHALL KEITH PACKARD BE LIABLE FOR ANY SPECIAL, INDIRECT OR CONSEQUENTIAL DAMAGES OR ANY DAMAGES WHATSOEVER RESULTING FROM LOSS OF USE, DATA OR PROFITS, WHETHER IN AN ACTION OF CONTRACT, NEGLIGENCE OR OTHER TORTIOUS ACTION, ARISING OUT OF OR IN CONNECTION WITH THE USE OR PERFORMANCE OF THIS SOFTWARE.

Copyright © 2001,2003 Keith Packard

Copyright © 2007 Eric Anholt

Permission to use, copy, modify, distribute, and sell this software and its documentation for any purpose is hereby granted without fee, provided that the above copyright notice appear in all copies and that both that copyright notice and this permission notice appear in supporting documentation, and that the name of Keith Packard not be used in advertising or publicity pertaining to distribution of the software without specific, written prior permission. Keith Packard makes no representations about the suitability of this software for any purpose. It is provided "as is" without express or implied warranty.

KEITH PACKARD DISCLAIMS ALL WARRANTIES WITH REGARD TO THIS SOFTWARE, INCLUDING ALL IMPLIED WARRANTIES OF MERCHANTABILITY AND FITNESS, IN NO EVENT SHALL KEITH PACKARD BE LIABLE FOR ANY SPECIAL, INDIRECT OR CONSEQUENTIAL DAMAGES OR ANY DAMAGES WHATSOEVER RESULTING FROM LOSS OF USE, DATA OR PROFITS, WHETHER IN AN ACTION OF CONTRACT, NEGLIGENCE OR OTHER TORTIOUS ACTION, ARISING OUT OF OR IN CONNECTION WITH THE USE OR PERFORMANCE OF THIS SOFTWARE.

Copyright © 2007, 2009 Red Hat, Inc.

Permission is hereby granted, free of charge, to any person obtaining a copy of this software and associated documentation files (the "Software"), to deal in the Software without restriction, including without limitation the rights to use, copy, modify, merge, publish, distribute, and/or sell copies of the Software, and to permit persons to whom the Software is furnished to do so, provided that the above copyright notice(s) and this permission notice appear in all copies of the Software and that both the above copyright notice(s) and this permission notice appear in supporting documentation.

THE SOFTWARE IS PROVIDED "AS IS", WITHOUT WARRANTY OF ANY KIND, EXPRESS OR IMPLIED, INCLUDING BUT NOT LIMITED TO THE WARRANTIES OF MERCHANTABILITY, FITNESS FOR A PARTICULAR PURPOSE AND NONINFRINGEMENT OF THIRD PARTY RIGHTS. IN NO EVENT SHALL THE COPYRIGHT HOLDER OR HOLDERS INCLUDED IN THIS NOTICE BE LIABLE FOR ANY CLAIM, OR ANY SPECIAL INDIRECT OR CONSE-

QUENTIAL DAMAGES, OR ANY DAMAGES WHATSOEVER RESULTING FROM LOSS OF USE, DATA OR PROFITS, WHETHER IN AN ACTION OF CONTRACT, NEGLIGENCE OR OTHER TORTIOUS ACTION, ARISING OUT OF OR IN CONNECTION WITH THE USE OR PERFORMANCE OF THIS SOFTWARE.

Except as contained in this notice, the name of a copyright holder shall not be used in advertising or otherwise to promote the sale, use or other dealings in this Software without prior written authorization of the copyright holder.

Copyright 1990, 1991 Network Computing Devices;

Portions Copyright 1987 by Digital Equipment Corporation

Permission to use, copy, modify, distribute, and sell this software and its documentation for any purpose is hereby granted without fee, provided that the above copyright notice appear in all copies and that both that copyright notice and this permission notice appear in supporting documentation, and that the names of Network Computing Devices or Digital

not be used in advertising or publicity pertaining to distribution of the software without specific, written prior permission.

Network Computing Devices and Digital make no representations about the suitability of this software for any purpose. It is provided "as is" without express or implied warranty.

NETWORK COMPUTING DEVICES AND DIGITAL DISCLAIM ALL WARRANTIES WITH REGARD TO THIS SOFTWARE, INCLUDING ALL IMPLIED WARRANTIES OF MERCHANTABILITY AND FITNESS, IN NO EVENT SHALL NETWORK COMPUTING DEVICES OR DIGITAL BE LIABLE FOR ANY SPECIAL, INDIRECT OR CONSEQUENTIAL DAMAGES OR ANY DAMAGES WHATSOEVER RESULTING FROM LOSS OF USE, DATA OR PROFITS, WHETHER IN AN ACTION OF CONTRACT, NEGLIGENCE OR OTHER TORTIOUS ACTION, ARISING OUT OF OR IN CONNECTION WITH THE USE OR PERFORMANCE OF THIS SOFTWARE.

Copyright 1987 - 1991, 1993, 1996, 1997 by Digital Equipment Corporation, Maynard, Massachusetts.

All Rights Reserved

Permission to use, copy, modify, and distribute this software and its documentation for any purpose and without fee is hereby granted, provided that the above copyright notice appear in all copies and that both that copyright notice and this permission notice appear in supporting documentation, and that the name of Digital not be used in advertising or publicity pertaining to distribution of the software without specific, written prior permission.

DIGITAL DISCLAIMS ALL WARRANTIES WITH REGARD TO THIS SOFTWARE, INCLUDING ALL IMPLIED WARRANTIES OF MERCHANTABILITY AND FITNESS, IN NO EVENT SHALL DIGITAL BE LIABLE FOR ANY SPECIAL, INDIRECT OR CONSEQUENTIAL DAMAGES OR ANY DAMAGES WHATSOEVER RESULTING FROM LOSS OF USE, DATA OR PROFITS, WHETHER IN AN ACTION OF CONTRACT, NEGLIGENCE OR OTHER TORTIOUS ACTION, ARISING OUT OF OR IN CONNECTION WITH THE USE OR PERFORMANCE OF THIS SOFTWARE.

Copyright (c) 1997, 1999 – 2003 The XFree86 Project Inc.

All Rights Reserved.

The above copyright notice and this permission notice shall be included in all copies or substantial portions of the Software.

THE SOFTWARE IS PROVIDED "AS IS", WITHOUT WARRANTY OF ANY KIND, EXPRESS OR IMPLIED, INCLUDING BUT NOT LIMITED TO THE WARRANTIES OF MERCHANTABILITY, FITNESS FOR A PARTICULAR PURPOSE AND NONINFRINGEMENT. IN NO EVENT SHALL THE OPEN GROUP BE LIABLE FOR ANY CLAIM, DAMAGES OR OTHER LIABILITY, WHETHER IN AN ACTION OF CONTRACT, TORT OR OTHERWISE, ARISING FROM, OUT OF OR IN CONNECTION WITH THE SOFTWARE OR THE USE OR OTHER DEALINGS IN THE SOFTWARE.

Except as contained in this notice, the name of The XFree86 Project Inc. shall not be used in advertising or otherwise to promote the sale, use or other dealings in this Software without prior written

authorization from The XFree86 Project Inc..

Copyright (C) 1991–2000 Silicon Graphics, Inc. All Rights Reserved.

Permission is hereby granted, free of charge, to any person obtaining a copy of this software and associated documentation files (the "Software"), to deal in the Software without restriction, including without limitation the rights to use, copy, modify, merge, publish, distribute, sublicense, and/or sell copies of the Software, and to permit persons to whom the Software is furnished to do so, subject to the following conditions:

The above copyright notice including the dates of first publication and either this permission notice or a reference to

<http://oss.sgi.com/projects/FreeB/>

shall be included in all copies or substantial portions of the Software.

THE SOFTWARE IS PROVIDED "AS IS", WITHOUT WARRANTY OF ANY KIND, EXPRESS

OR IMPLIED, INCLUDING BUT NOT LIMITED TO THE WARRANTIES OF
MERCHANTABILITY,
FITNESS FOR A PARTICULAR PURPOSE AND NONINFRINGEMENT. IN NO EVENT SHALL
SILICON GRAPHICS, INC. BE LIABLE FOR ANY CLAIM, DAMAGES OR OTHER LIABILITY,
WHETHER IN AN ACTION OF CONTRACT, TORT OR OTHERWISE, ARISING FROM, OUT
OF
OR IN CONNECTION WITH THE SOFTWARE OR THE USE OR OTHER DEALINGS IN THE
SOFTWARE.

Except as contained in this notice, the name of Silicon Graphics, Inc.
shall not be used in advertising or otherwise to promote the sale, use or
other dealings in this Software without prior written authorization from
Silicon Graphics, Inc.

Copyright 1984 - 1989, 1994, 1995 by Hewlett-Packard Company

All Rights Reserved

Permission to use, copy, modify, and distribute this software and its

documentation for any purpose and without fee is hereby granted, provided that the above copyright notice appear in all copies and that both that copyright notice and this permission notice appear in supporting documentation, and that the name of Hewlett-Packard not be used in advertising or publicity pertaining to distribution of the software without specific, written prior permission.

HEWLETT-PACKARD DISCLAIMS ALL WARRANTIES WITH REGARD TO THIS SOFTWARE, INCLUDING

ALL IMPLIED WARRANTIES OF MERCHANTABILITY AND FITNESS, IN NO EVENT SHALL HEWLETT-PACKARD BE LIABLE FOR ANY SPECIAL, INDIRECT OR CONSEQUENTIAL DAMAGES OR

ANY DAMAGES WHATSOEVER RESULTING FROM LOSS OF USE, DATA OR PROFITS, WHETHER IN AN ACTION OF CONTRACT, NEGLIGENCE OR OTHER TORTIOUS ACTION, ARISING OUT OF OR IN CONNECTION WITH THE USE OR PERFORMANCE OF THIS SOFTWARE.

Except as contained in this notice, the name of the Hewlett-Packard Company shall not be used in advertising or otherwise to promote the

sale, use or other dealings in this Software without prior written authorization from the Hewlett-Packard Company.

Copyright (c) 1993 – 1997 by Silicon Graphics Computer Systems, Inc.

Permission to use, copy, modify, and distribute this software and its documentation for any purpose and without fee is hereby granted, provided that the above copyright notice appear in all copies and that both that copyright notice and this permission notice appear in supporting documentation, and that the name of Silicon Graphics not be used in advertising or publicity pertaining to distribution of the software without specific prior written permission.

Silicon Graphics makes no representation about the suitability of this software for any purpose. It is provided "as is" without any express or implied warranty.

SILICON GRAPHICS DISCLAIMS ALL WARRANTIES WITH REGARD TO THIS

SOFTWARE, INCLUDING ALL IMPLIED WARRANTIES OF MERCHANTABILITY AND FITNESS FOR A PARTICULAR PURPOSE. IN NO EVENT SHALL SILICON GRAPHICS BE LIABLE FOR ANY SPECIAL, INDIRECT OR CONSEQUENTIAL DAMAGES OR ANY DAMAGES WHATSOEVER RESULTING FROM LOSS OF USE, DATA OR PROFITS, WHETHER IN AN ACTION OF CONTRACT, NEGLIGENCE OR OTHER TORTIOUS ACTION, ARISING OUT OF OR IN CONNECTION WITH THE USE OR PERFORMANCE OF THIS SOFTWARE.

Copyright (c) 1998–2001 by Juliusz Chroboczek

Permission is hereby granted, free of charge, to any person obtaining a copy of this software and associated documentation files (the "Software"), to deal in the Software without restriction, including without limitation the rights to use, copy, modify, merge, publish, distribute, sublicense, and/or sell copies of the Software, and to permit persons to whom the Software is furnished to do so, subject to the following conditions:

The above copyright notice and this permission notice shall be included in

all copies or substantial portions of the Software.

THE SOFTWARE IS PROVIDED "AS IS", WITHOUT WARRANTY OF ANY KIND, EXPRESS OR IMPLIED, INCLUDING BUT NOT LIMITED TO THE WARRANTIES OF MERCHANTABILITY, FITNESS FOR A PARTICULAR PURPOSE AND NONINFRINGEMENT. IN NO EVENT SHALL THE AUTHORS OR COPYRIGHT HOLDERS BE LIABLE FOR ANY CLAIM, DAMAGES OR OTHER LIABILITY, WHETHER IN AN ACTION OF CONTRACT, TORT OR OTHERWISE, ARISING FROM, OUT OF OR IN CONNECTION WITH THE SOFTWARE OR THE USE OR OTHER DEALINGS IN THE SOFTWARE.

(C) Copyright IBM Corporation 2006, 2007

(C) Copyright Eric Anholt 2006

Copyright 2007, 2008, 2009 Sun Microsystems, Inc.

Copyright 2009 Red Hat, Inc.

All Rights Reserved.

Permission is hereby granted, free of charge, to any person obtaining a copy of this software and associated documentation files (the "Software"), to deal in the Software without restriction, including without limitation on the rights to use, copy, modify, merge, publish, distribute, sub license, and/or sell copies of the Software, and to permit persons to whom the Software is furnished to do so, subject to the following conditions:

The above copyright notice and this permission notice (including the next paragraph) shall be included in all copies or substantial portions of the Software.

THE SOFTWARE IS PROVIDED "AS IS", WITHOUT WARRANTY OF ANY KIND, EXPRESS OR IMPLIED, INCLUDING BUT NOT LIMITED TO THE WARRANTIES OF MERCHANTABILITY, FITNESS FOR A PARTICULAR PURPOSE AND NON-INFRINGEMENT. IN NO EVENT SHALL

IBM AND/OR THEIR SUPPLIERS BE LIABLE FOR ANY CLAIM, DAMAGES OR OTHER LIABILITY, WHETHER IN AN ACTION OF CONTRACT, TORT OR OTHERWISE, ARISING

FROM, OUT OF OR IN CONNECTION WITH THE SOFTWARE OR THE USE OR OTHER
DEALINGS
IN THE SOFTWARE.

Copyright (c) 2008 Juan Romero Pardines

Copyright (c) 2008 Mark Kettenis

Permission to use, copy, modify, and distribute this software for any
purpose with or without fee is hereby granted, provided that the above
copyright notice and this permission notice appear in all copies.

THE SOFTWARE IS PROVIDED "AS IS" AND THE AUTHOR DISCLAIMS ALL WARRANTIES
WITH REGARD TO THIS SOFTWARE INCLUDING ALL IMPLIED WARRANTIES OF
MERCHANTABILITY AND FITNESS. IN NO EVENT SHALL THE AUTHOR BE LIABLE FOR
ANY SPECIAL, DIRECT, INDIRECT, OR CONSEQUENTIAL DAMAGES OR ANY DAMAGES
WHATSOEVER RESULTING FROM LOSS OF USE, DATA OR PROFITS, WHETHER IN AN
ACTION OF CONTRACT, NEGLIGENCE OR OTHER TORTIOUS ACTION, ARISING OUT
OF

OR IN CONNECTION WITH THE USE OR PERFORMANCE OF THIS SOFTWARE.

Copyright (C) 2003–2006,2008 Jamey Sharp, Josh Triplett

Copyright © 2009 Red Hat, Inc.

Copyright 1990–1992,1999,2000,2004,2009,2010 Oracle and/or its affiliates.

All rights reserved.

Permission is hereby granted, free of charge, to any person obtaining a copy of this software and associated documentation files (the "Software"), to deal in the Software without restriction, including without limitation the rights to use, copy, modify, merge, publish, distribute, sublicense, and/or sell copies of the Software, and to permit persons to whom the Software is furnished to do so, subject to the following conditions:

The above copyright notice and this permission notice (including the next paragraph) shall be included in all copies or substantial portions of the Software.

THE SOFTWARE IS PROVIDED "AS IS", WITHOUT WARRANTY OF ANY KIND, EXPRESS OR IMPLIED, INCLUDING BUT NOT LIMITED TO THE WARRANTIES OF MERCHANTABILITY, FITNESS FOR A PARTICULAR PURPOSE AND NONINFRINGEMENT. IN NO EVENT SHALL THE AUTHORS OR COPYRIGHT HOLDERS BE LIABLE FOR ANY CLAIM, DAMAGES OR OTHER LIABILITY, WHETHER IN AN ACTION OF CONTRACT, TORT OR OTHERWISE, ARISING FROM, OUT OF OR IN CONNECTION WITH THE SOFTWARE OR THE USE OR OTHER DEALINGS IN THE SOFTWARE.

Copyright 1985, 1986, 1987, 1988, 1989, 1990, 1991, 1994, 1996 X Consortium
Copyright 2000 The XFree86 Project, Inc.

Permission is hereby granted, free of charge, to any person obtaining a copy of this software and associated documentation files (the "Software"), to deal in the Software without restriction, including without limitation the rights to use, copy, modify, merge, publish, distribute, sublicense, and/or sell copies of the Software, and to

permit persons to whom the Software is furnished to do so, subject to the following conditions:

The above copyright notice and this permission notice shall be included in all copies or substantial portions of the Software.

THE SOFTWARE IS PROVIDED "AS IS", WITHOUT WARRANTY OF ANY KIND, EXPRESS OR IMPLIED, INCLUDING BUT NOT LIMITED TO THE WARRANTIES OF MERCHANTABILITY, FITNESS FOR A PARTICULAR PURPOSE AND NONINFRINGEMENT. IN NO EVENT SHALL THE X CONSORTIUM BE LIABLE FOR ANY CLAIM, DAMAGES OR OTHER LIABILITY, WHETHER IN AN ACTION OF CONTRACT, TORT OR OTHERWISE, ARISING FROM, OUT OF OR IN CONNECTION WITH THE SOFTWARE OR THE USE OR OTHER DEALINGS IN THE SOFTWARE.

Except as contained in this notice, the name of the X Consortium shall not be used in advertising or otherwise to promote the sale, use or other dealings in this Software without prior written authorization from the X Consortium.

Copyright 1985 – 1991 by Digital Equipment Corporation

Portions Copyright 1990, 1991 by Tektronix, Inc.

Permission to use, copy, modify and distribute this documentation for any purpose and without fee is hereby granted, provided that the above copyright notice appears in all copies and that both that copyright notice and this permission notice appear in all copies, and that the names of Digital and Tektronix not be used in in advertising or publicity pertaining to this documentation without specific, written prior permission.

Digital and Tektronix makes no representations about the suitability of this documentation for any purpose.

It is provided ``as is" without express or implied warranty.

Copyright (c) 1999 – 2000 Free Software Foundation, Inc.

Permission is hereby granted, free of charge, to any person obtaining a copy of this software and associated documentation files (the "Software"), to deal

in the Software without restriction, including without limitation the rights to use, copy, modify, merge, publish, distribute, sublicense, and/or sell copies of the Software, and to permit persons to whom the Software is furnished to do so, subject to the following conditions:

The above copyright notice and this permission notice shall be included in all copies or substantial portions of the Software.

THE SOFTWARE IS PROVIDED "AS IS", WITHOUT WARRANTY OF ANY KIND, EXPRESS OR IMPLIED, INCLUDING BUT NOT LIMITED TO THE WARRANTIES OF MERCHANTABILITY, FITNESS FOR A PARTICULAR PURPOSE AND NONINFRINGEMENT. IN NO EVENT SHALL THE FREE SOFTWARE FOUNDATION BE LIABLE FOR ANY CLAIM, DAMAGES OR OTHER LIABILITY, WHETHER IN AN ACTION OF CONTRACT, TORT OR OTHERWISE, ARISING FROM, OUT OF OR IN CONNECTION WITH THE SOFTWARE OR THE USE OR OTHER DEALINGS IN THE SOFTWARE.

Except as contained in this notice, the name of the Free Software Foundation shall not be used in advertising or otherwise to promote the sale, use or other dealings in this Software without prior written authorization from the Free Software Foundation.

(c) Copyright 1990 1991 Tektronix, Inc.

All Rights Reserved

This file is a component of an X Window System-specific implementation of Xcms based on the TekColor Color Management System. TekColor is a trademark of Tektronix, Inc. The term "TekHVC" designates a particular color space that is the subject of U.S. Patent No. 4,985,853 (equivalent foreign patents pending). Permission is hereby granted to use, copy, modify, sell, and otherwise distribute this software and its documentation for any purpose and without fee, provided that:

1. This copyright, permission, and disclaimer notice is reproduced in all copies of this software and any modification thereof and in

supporting documentation;

2. Any color-handling application which displays TekHVC color

coordinates identifies these as TekHVC color coordinates in any

interface that displays these coordinates and in any associated

documentation;

3. The term "TekHVC" is always used, and is only used, in association

with the mathematical derivations of the TekHVC Color Space,

including those provided in this file and any equivalent pathways and

mathematical derivations, regardless of digital (e.g., floating point

or integer) representation.

Tektronix makes no representation about the suitability of this software

for any purpose. It is provided "as is" and with all faults.

TEKTRONIX DISCLAIMS ALL WARRANTIES APPLICABLE TO THIS SOFTWARE,

INCLUDING THE IMPLIED WARRANTIES OF MERCHANTABILITY AND FITNESS FOR A

PARTICULAR PURPOSE. IN NO EVENT SHALL TEKTRONIX BE LIABLE FOR ANY

SPECIAL, INDIRECT OR CONSEQUENTIAL DAMAGES OR ANY DAMAGES WHATSOEVER

RESULTING FROM LOSS OF USE, DATA, OR PROFITS, WHETHER IN AN ACTION OF

CONTRACT, NEGLIGENCE, OR OTHER TORTIOUS ACTION, ARISING OUT OF OR IN CONNECTION WITH THE USE OR THE PERFORMANCE OF THIS SOFTWARE.

Copyright 1992 by Oki Technosystems Laboratory, Inc.

Copyright 1992 by Fuji Xerox Co., Ltd.

Permission to use, copy, modify, distribute, and sell this software and its documentation for any purpose is hereby granted without fee, provided that the above copyright notice appear in all copies and that both that copyright notice and this permission notice appear in supporting documentation, and that the name of Oki Technosystems Laboratory and Fuji Xerox not be used in advertising or publicity pertaining to distribution of the software without specific, written prior permission.

Oki Technosystems Laboratory and Fuji Xerox make no representations about the suitability of this software for any purpose. It is provided "as is" without express or implied warranty.

OKI TECHNOSYSTEMS LABORATORY AND FUJI XEROX DISCLAIM ALL WARRANTIES WITH REGARD TO THIS SOFTWARE, INCLUDING ALL IMPLIED WARRANTIES OF MERCHANTABILITY AND FITNESS, IN NO EVENT SHALL OKI TECHNOSYSTEMS LABORATORY AND FUJI XEROX BE LIABLE FOR ANY SPECIAL, INDIRECT OR CONSEQUENTIAL DAMAGES OR ANY DAMAGES WHATSOEVER RESULTING FROM LOSS OF USE, DATA OR PROFITS, WHETHER IN AN ACTION OF CONTRACT, NEGLIGENCE OR OTHER TORTIOUS ACTION, ARISING OUT OF OR IN CONNECTION WITH THE USE OR PERFORMANCE OF THIS SOFTWARE.

Copyright 1990 - 1994 by FUJITSU LIMITED

Permission to use, copy, modify, distribute, and sell this software and its documentation for any purpose is hereby granted without fee, provided that the above copyright notice appear in all copies and that both that copyright notice and this permission notice appear in supporting documentation, and that the name of FUJITSU LIMITED not be used in advertising or publicity pertaining to distribution of the software without specific, written prior permission.

FUJITSU LIMITED makes no representations about the suitability of this software for any purpose.

It is provided "as is" without express or implied warranty.

FUJITSU LIMITED DISCLAIM ALL WARRANTIES WITH REGARD TO THIS SOFTWARE, INCLUDING ALL IMPLIED WARRANTIES OF MERCHANTABILITY AND FITNESS, IN NO EVENT SHALL FUJITSU LIMITED BE LIABLE FOR ANY SPECIAL, INDIRECT OR CONSEQUENTIAL DAMAGES OR ANY DAMAGES WHATSOEVER RESULTING FROM LOSS OF USE, DATA OR PROFITS, WHETHER IN AN ACTION OF CONTRACT, NEGLIGENCE OR OTHER TORTIOUS ACTION, ARISING OUT OF OR IN CONNECTION WITH THE USE OR PERFORMANCE OF THIS SOFTWARE.

Copyright (c) 1995 David E. Wexelblat. All rights reserved

Permission is hereby granted, free of charge, to any person obtaining a copy of this software and associated documentation files (the "Software"), to deal in the Software without restriction, including

without limitation the rights to use, copy, modify, merge, publish, distribute, sublicense, and/or sell copies of the Software, and to permit persons to whom the Software is furnished to do so, subject to the following conditions:

The above copyright notice and this permission notice shall be included in all copies or substantial portions of the Software.

THE SOFTWARE IS PROVIDED "AS IS", WITHOUT WARRANTY OF ANY KIND, EXPRESS OR IMPLIED, INCLUDING BUT NOT LIMITED TO THE WARRANTIES OF MERCHANTABILITY, FITNESS FOR A PARTICULAR PURPOSE AND NONINFRINGEMENT. IN NO EVENT SHALL DAVID E. WEXELBLAT BE LIABLE FOR ANY CLAIM, DAMAGES OR OTHER LIABILITY, WHETHER IN AN ACTION OF CONTRACT, TORT OR OTHERWISE, ARISING FROM, OUT OF OR IN CONNECTION WITH THE SOFTWARE OR THE USE OR OTHER DEALINGS IN THE SOFTWARE.

Except as contained in this notice, the name of David E. Wexelblat shall not be used in advertising or otherwise to promote the sale, use or other dealings in this Software without prior written authorization

from David E. Wexelblat.

Copyright 1990, 1991 by OMRON Corporation

Permission to use, copy, modify, distribute, and sell this software and its documentation for any purpose is hereby granted without fee, provided that the above copyright notice appear in all copies and that both that copyright notice and this permission notice appear in supporting documentation, and that the name OMRON not be used in advertising or publicity pertaining to distribution of the software without specific, written prior permission. OMRON makes no representations about the suitability of this software for any purpose. It is provided "as is" without express or implied warranty.

OMRON DISCLAIMS ALL WARRANTIES WITH REGARD TO THIS SOFTWARE, INCLUDING ALL IMPLIED WARRANTIES OF MERCHANTABILITY AND FITNESS, IN NO EVENT SHALL OMRON BE LIABLE FOR ANY SPECIAL, INDIRECT OR

CONSEQUENTIAL DAMAGES OR ANY DAMAGES WHATSOEVER RESULTING FROM LOSS OF USE, DATA OR PROFITS, WHETHER IN AN ACTION OF CONTRACT, NEGLIGENCE OR OTHER TORTUOUS ACTION, ARISING OUT OF OR IN CONNECTION WITH THE USE OR PERFORMANCE OF THIS SOFTWARE.

Copyright 1985, 1986, 1987, 1988, 1989, 1990, 1991 by

Digital Equipment Corporation

Portions Copyright 1990, 1991 by Tektronix, Inc

Rewritten for X.org by Chris Lee <clee@freedesktop.org>

Permission to use, copy, modify, distribute, and sell this documentation for any purpose and without fee is hereby granted, provided that the above copyright notice and this permission notice appear in all copies.

Chris Lee makes no representations about the suitability for any purpose of the information in this document. It is provided "as-is" without express or implied warranty.

Copyright 1993 by Digital Equipment Corporation, Maynard, Massachusetts,

Copyright 1994 by FUJITSU LIMITED

Copyright 1994 by Sony Corporation

All Rights Reserved

Permission to use, copy, modify, and distribute this software and its documentation for any purpose and without fee is hereby granted, provided that the above copyright notice appear in all copies and that both that copyright notice and this permission notice appear in supporting documentation, and that the names of Digital, FUJITSU LIMITED and Sony Corporation not be used in advertising or publicity pertaining to distribution of the software without specific, written prior permission.

DIGITAL, FUJITSU LIMITED AND SONY CORPORATION DISCLAIMS ALL WARRANTIES WITH REGARD TO THIS SOFTWARE, INCLUDING ALL IMPLIED WARRANTIES OF

MERCHANTABILITY AND FITNESS, IN NO EVENT SHALL DIGITAL, FUJITSU LIMITED AND SONY CORPORATION BE LIABLE FOR ANY SPECIAL, INDIRECT OR CONSEQUENTIAL DAMAGES OR ANY DAMAGES WHATSOEVER RESULTING FROM LOSS OF USE, DATA OR PROFITS, WHETHER IN AN ACTION OF CONTRACT, NEGLIGENCE OR OTHER TORTIOUS ACTION, ARISING OUT OF OR IN CONNECTION WITH THE USE OR PERFORMANCE OF THIS SOFTWARE.

Copyright 1991 by the Open Software Foundation

Permission to use, copy, modify, distribute, and sell this software and its documentation for any purpose is hereby granted without fee, provided that the above copyright notice appear in all copies and that both that copyright notice and this permission notice appear in supporting documentation, and that the name of Open Software Foundation not be used in advertising or publicity pertaining to distribution of the software without specific, written prior permission. Open Software Foundation makes no representations about the suitability of this

software for any purpose. It is provided "as is" without express or implied warranty.

OPEN SOFTWARE FOUNDATION DISCLAIMS ALL WARRANTIES WITH REGARD TO THIS SOFTWARE, INCLUDING ALL IMPLIED WARRANTIES OF MERCHANTABILITY AND FITNESS, IN NO EVENT SHALL OPEN SOFTWARE FOUNDATION BE LIABLE FOR ANY SPECIAL, INDIRECT OR CONSEQUENTIAL DAMAGES OR ANY DAMAGES

WHATSOEVER RESULTING FROM LOSS OF USE, DATA OR PROFITS, WHETHER IN AN ACTION OF CONTRACT, NEGLIGENCE OR OTHER TORTIOUS ACTION, ARISING OUT OF OR IN CONNECTION WITH THE USE OR PERFORMANCE OF THIS SOFTWARE.

Copyright 1990, 1991, 1992, 1993, 1994 by FUJITSU LIMITED

Copyright 1993, 1994 by Sony Corporation

Permission to use, copy, modify, distribute, and sell this software and its documentation for any purpose is hereby granted without fee, provided

that the above copyright notice appear in all copies and that both that copyright notice and this permission notice appear in supporting documentation, and that the name of FUJITSU LIMITED and Sony Corporation not be used in advertising or publicity pertaining to distribution of the software without specific, written prior permission. FUJITSU LIMITED and Sony Corporation makes no representations about the suitability of this software for any purpose. It is provided "as is" without express or implied warranty.

FUJITSU LIMITED AND SONY CORPORATION DISCLAIMS ALL WARRANTIES WITH REGARD TO THIS SOFTWARE, INCLUDING ALL IMPLIED WARRANTIES OF MERCHANTABILITY AND FITNESS, IN NO EVENT SHALL FUJITSU LIMITED OR SONY CORPORATION BE LIABLE FOR ANY SPECIAL, INDIRECT OR CONSEQUENTIAL DAMAGES OR ANY DAMAGES WHATSOEVER RESULTING FROM LOSS OF USE, DATA OR PROFITS, WHETHER IN AN ACTION OF CONTRACT,

NEGLIGENCE OR OTHER TORTIOUS ACTION, ARISING OUT OF OR IN CONNECTION
WITH THE
USE OR PERFORMANCE OF THIS SOFTWARE.

Copyright 1991, 1992, 1993, 1994 by FUJITSU LIMITED

Copyright 1993 by Digital Equipment Corporation

Permission to use, copy, modify, distribute, and sell this software
and its documentation for any purpose is hereby granted without fee,
provided that the above copyright notice appear in all copies and that
both that copyright notice and this permission notice appear in
supporting documentation, and that the name of FUJITSU LIMITED and
Digital Equipment Corporation not be used in advertising or publicity
pertaining to distribution of the software without specific, written
prior permission. FUJITSU LIMITED and Digital Equipment Corporation
makes no representations about the suitability of this software for
any purpose. It is provided "as is" without express or implied
warranty.

FUJITSU LIMITED AND DIGITAL EQUIPMENT CORPORATION DISCLAIM ALL WARRANTIES WITH REGARD TO THIS SOFTWARE, INCLUDING ALL IMPLIED WARRANTIES OF MERCHANTABILITY AND FITNESS, IN NO EVENT SHALL FUJITSU LIMITED AND DIGITAL EQUIPMENT CORPORATION BE LIABLE FOR ANY SPECIAL, INDIRECT OR CONSEQUENTIAL DAMAGES OR ANY DAMAGES WHATSOEVER RESULTING FROM LOSS OF USE, DATA OR PROFITS, WHETHER IN AN ACTION OF CONTRACT, NEGLIGENCE OR OTHER TORTIOUS ACTION, ARISING OUT OF OR IN CONNECTION WITH THE USE OR PERFORMANCE OF THIS SOFTWARE.

Copyright 1992, 1993 by FUJITSU LIMITED

Copyright 1993 by Fujitsu Open Systems Solutions, Inc.

Copyright 1994 by Sony Corporation

Permission to use, copy, modify, distribute and sell this software and its documentation for any purpose is hereby granted without fee, provided that the above copyright notice appear in all copies and

that both that copyright notice and this permission notice appear in supporting documentation, and that the name of FUJITSU LIMITED, Fujitsu Open Systems Solutions, Inc. and Sony Corporation not be used in advertising or publicity pertaining to distribution of the software without specific, written prior permission.

FUJITSU LIMITED, Fujitsu Open Systems Solutions, Inc. and Sony Corporation make no representations about the suitability of this software for any purpose. It is provided "as is" without express or implied warranty.

FUJITSU LIMITED, FUJITSU OPEN SYSTEMS SOLUTIONS, INC. AND SONY CORPORATION DISCLAIM ALL WARRANTIES WITH REGARD TO THIS SOFTWARE, INCLUDING ALL IMPLIED WARRANTIES OF MERCHANTABILITY AND FITNESS, IN NO EVENT SHALL FUJITSU OPEN SYSTEMS SOLUTIONS, INC., FUJITSU LIMITED AND SONY CORPORATION BE LIABLE FOR ANY SPECIAL, INDIRECT OR CONSEQUENTIAL DAMAGES OR ANY DAMAGES WHATSOEVER RESULTING FROM LOSS OF USE, DATA OR PROFITS, WHETHER IN AN ACTION OF CONTRACT, NEGLIGENCE OR OTHER TORTIOUS ACTION, ARISING OUT OF OR IN CONNECTION WITH THE USE OR PERFORMANCE OF THIS SOFTWARE.

Copyright 1993 by SunSoft, Inc.

Copyright 1999–2000 by Bruno Haible

Permission to use, copy, modify, distribute, and sell this software and its documentation for any purpose is hereby granted without fee, provided that the above copyright notice appear in all copies and that both that copyright notice and this permission notice appear in supporting documentation, and that the names of SunSoft, Inc. and Bruno Haible not be used in advertising or publicity pertaining to distribution of the software without specific, written prior permission. SunSoft, Inc. and Bruno Haible make no representations about the suitability of this software for any purpose. It is provided "as is" without express or implied warranty.

SunSoft Inc. AND Bruno Haible DISCLAIM ALL WARRANTIES WITH REGARD TO THIS SOFTWARE, INCLUDING ALL IMPLIED WARRANTIES OF MERCHANTABILITY AND FITNESS, IN NO EVENT SHALL SunSoft, Inc. OR Bruno Haible BE LIABLE

FOR ANY SPECIAL, INDIRECT OR CONSEQUENTIAL DAMAGES OR ANY DAMAGES WHATSOEVER RESULTING FROM LOSS OF USE, DATA OR PROFITS, WHETHER IN AN ACTION OF CONTRACT, NEGLIGENCE OR OTHER TORTIOUS ACTION, ARISING OUT OF OR IN CONNECTION WITH THE USE OR PERFORMANCE OF THIS SOFTWARE.

Copyright 1991 by the Open Software Foundation

Copyright 1993 by the TOSHIBA Corp.

Permission to use, copy, modify, distribute, and sell this software and its documentation for any purpose is hereby granted without fee, provided that the above copyright notice appear in all copies and that both that copyright notice and this permission notice appear in supporting documentation, and that the names of Open Software Foundation and TOSHIBA not be used in advertising or publicity pertaining to distribution of the software without specific, written prior permission. Open Software Foundation and TOSHIBA make no representations about the suitability of this software for any purpose. It is provided "as is" without express or implied warranty.

OPEN SOFTWARE FOUNDATION AND TOSHIBA DISCLAIM ALL WARRANTIES WITH REGARD TO

THIS SOFTWARE, INCLUDING ALL IMPLIED WARRANTIES OF MERCHANTABILITY AND FITNESS, IN NO EVENT SHALL OPEN SOFTWARE FOUNDATION OR TOSHIBA BE LIABLE FOR ANY SPECIAL, INDIRECT OR CONSEQUENTIAL DAMAGES OR ANY DAMAGES

WHATSOEVER RESULTING FROM LOSS OF USE, DATA OR PROFITS, WHETHER IN AN ACTION OF CONTRACT, NEGLIGENCE OR OTHER TORTIOUS ACTION, ARISING OUT OF OR IN CONNECTION WITH THE USE OR PERFORMANCE OF THIS SOFTWARE.

Copyright 1988 by Wyse Technology, Inc., San Jose, Ca.,

All Rights Reserved

Permission to use, copy, modify, and distribute this software and its documentation for any purpose and without fee is hereby granted, provided that the above copyright notice appear in all copies and that

both that copyright notice and this permission notice appear in supporting documentation, and that the name Wyse not be used in advertising or publicity pertaining to distribution of the software without specific, written prior permission.

WYSE DISCLAIMS ALL WARRANTIES WITH REGARD TO THIS SOFTWARE, INCLUDING ALL IMPLIED WARRANTIES OF MERCHANTABILITY AND FITNESS, IN NO EVENT SHALL DIGITAL BE LIABLE FOR ANY SPECIAL, INDIRECT OR CONSEQUENTIAL DAMAGES OR ANY DAMAGES WHATSOEVER RESULTING FROM LOSS OF USE, DATA OR PROFITS, WHETHER IN AN ACTION OF CONTRACT, NEGLIGENCE OR OTHER TORTIOUS ACTION, ARISING OUT OF OR IN CONNECTION WITH THE USE OR PERFORMANCE OF THIS SOFTWARE.

Copyright 1991 by the Open Software Foundation

Copyright 1993, 1994 by the Sony Corporation

Permission to use, copy, modify, distribute, and sell this software and its documentation for any purpose is hereby granted without fee, provided that

the above copyright notice appear in all copies and that both that copyright notice and this permission notice appear in supporting documentation, and that the names of Open Software Foundation and Sony Corporation not be used in advertising or publicity pertaining to distribution of the software without specific, written prior permission.

Open Software Foundation and Sony Corporation make no representations about the suitability of this software for any purpose.

It is provided "as is" without express or implied warranty.

OPEN SOFTWARE FOUNDATION AND SONY CORPORATION DISCLAIM ALL WARRANTIES WITH REGARD TO THIS SOFTWARE, INCLUDING ALL IMPLIED WARRANTIES OF MERCHANTABILITY AND FITNESS, IN NO EVENT SHALL OPEN SOFTWARE FOUNDATION OR SONY CORPORATION BE LIABLE FOR ANY SPECIAL, INDIRECT OR CONSEQUENTIAL DAMAGES OR ANY DAMAGES WHATSOEVER RESULTING FROM LOSS OF USE, DATA OR PROFITS, WHETHER IN AN ACTION OF CONTRACT, NEGLIGENCE OR OTHER TORTIOUS ACTION, ARISING OUT OF OR IN CONNECTION WITH THE USE OR

PERFORMANCE OF THIS SOFTWARE.

Copyright 1992, 1993 by FUJITSU LIMITED

Copyright 1993 by Fujitsu Open Systems Solutions, Inc.

Permission to use, copy, modify, distribute and sell this software and its documentation for any purpose is hereby granted without fee, provided that the above copyright notice appear in all copies and that both that copyright notice and this permission notice appear in supporting documentation, and that the name of FUJITSU LIMITED and Fujitsu Open Systems Solutions, Inc. not be used in advertising or publicity pertaining to distribution of the software without specific, written prior permission.

FUJITSU LIMITED and Fujitsu Open Systems Solutions, Inc. makes no representations about the suitability of this software for any purpose.

It is provided "as is" without express or implied warranty.

FUJITSU LIMITED AND FUJITSU OPEN SYSTEMS SOLUTIONS, INC. DISCLAIMS ALL

WARRANTIES WITH REGARD TO THIS SOFTWARE, INCLUDING ALL IMPLIED
WARRANTIES
OF MERCHANTABILITY AND FITNESS, IN NO EVENT SHALL FUJITSU OPEN SYSTEMS
SOLUTIONS, INC. AND FUJITSU LIMITED BE LIABLE FOR ANY SPECIAL, INDIRECT
OR CONSEQUENTIAL DAMAGES OR ANY DAMAGES WHATSOEVER RESULTING FROM
LOSS OF
USE, DATA OR PROFITS, WHETHER IN AN ACTION OF CONTRACT, NEGLIGENCE OR
OTHER
TORTIOUS ACTION, ARISING OUT OF OR IN CONNECTION WITH THE USE OR
PERFORMANCE
OF THIS SOFTWARE.

Copyright 1993, 1994 by Sony Corporation

Permission to use, copy, modify, distribute, and sell this software
and its documentation for any purpose is hereby granted without fee,
provided that the above copyright notice appear in all copies and
that both that copyright notice and this permission notice appear

in supporting documentation, and that the name of Sony Corporation not be used in advertising or publicity pertaining to distribution of the software without specific, written prior permission.

Sony Corporation makes no representations about the suitability of this software for any purpose. It is provided "as is" without express or implied warranty.

SONY CORPORATION DISCLAIMS ALL WARRANTIES WITH REGARD TO THIS SOFTWARE, INCLUDING ALL IMPLIED WARRANTIES OF MERCHANTABILITY AND FITNESS, IN NO EVENT SHALL SONY CORPORATION BE LIABLE FOR ANY SPECIAL, INDIRECT OR CONSEQUENTIAL DAMAGES OR ANY DAMAGES WHATSOEVER RESULTING FROM LOSS OF USE, DATA OR PROFITS, WHETHER IN AN ACTION OF CONTRACT, NEGLIGENCE OR OTHER TORTIOUS ACTION, ARISING OUT OF OR IN CONNECTION WITH THE USE OR PERFORMANCE OF THIS SOFTWARE.

Copyright 1986, 1998 The Open Group

Copyright (c) 2000 The XFree86 Project, Inc.

Permission to use, copy, modify, distribute, and sell this software and its documentation for any purpose is hereby granted without fee, provided that the above copyright notice appear in all copies and that both that copyright notice and this permission notice appear in supporting documentation.

The above copyright notice and this permission notice shall be included in all copies or substantial portions of the Software.

THE SOFTWARE IS PROVIDED "AS IS", WITHOUT WARRANTY OF ANY KIND, EXPRESS OR IMPLIED, INCLUDING BUT NOT LIMITED TO THE WARRANTIES OF MERCHANTABILITY, FITNESS FOR A PARTICULAR PURPOSE AND NONINFRINGEMENT. IN NO EVENT SHALL THE X CONSORTIUM OR THE XFREE86 PROJECT BE LIABLE FOR ANY CLAIM, DAMAGES OR OTHER LIABILITY, WHETHER IN AN ACTION OF CONTRACT, TORT OR OTHERWISE, ARISING FROM,

OUT OF OR IN CONNECTION WITH THE SOFTWARE OR THE USE OR OTHER DEALINGS
IN THE
SOFTWARE.

Except as contained in this notice, the name of the X Consortium or of the
XFree86 Project shall not be used in advertising or otherwise to promote the
sale, use or other dealings in this Software without prior written
authorization from the X Consortium and the XFree86 Project.

Copyright 1990, 1991 by OMRON Corporation, NTT Software Corporation,
and Nippon Telegraph and Telephone Corporation

Copyright 1991 by the Open Software Foundation

Copyright 1993 by the FUJITSU LIMITED

Permission to use, copy, modify, distribute, and sell this software and its
documentation for any purpose is hereby granted without fee, provided that
the above copyright notice appear in all copies and that both that
copyright notice and this permission notice appear in supporting

documentation, and that the names of OMRON, NTT Software, NTT, and Open Software Foundation not be used in advertising or publicity pertaining to distribution of the software without specific, written prior permission. OMRON, NTT Software, NTT, and Open Software Foundation make no representations about the suitability of this software for any purpose. It is provided "as is" without express or implied warranty.

OMRON, NTT SOFTWARE, NTT, AND OPEN SOFTWARE FOUNDATION
DISCLAIM ALL WARRANTIES WITH REGARD TO THIS SOFTWARE, INCLUDING
ALL IMPLIED WARRANTIES OF MERCHANTABILITY AND FITNESS, IN NO EVENT
SHALL OMRON, NTT SOFTWARE, NTT, OR OPEN SOFTWARE FOUNDATION BE
LIABLE FOR ANY SPECIAL, INDIRECT OR CONSEQUENTIAL DAMAGES OR ANY
DAMAGES
WHATSOEVER RESULTING FROM LOSS OF USE, DATA OR PROFITS, WHETHER IN AN
ACTION OF CONTRACT, NEGLIGENCE OR OTHER TORTIOUS ACTION, ARISING OUT
OF
OR IN CONNECTION WITH THE USE OR PERFORMANCE OF THIS SOFTWARE.

Copyright 1988 by Wyse Technology, Inc., San Jose, Ca,

Copyright 1987 by Digital Equipment Corporation, Maynard, Massachusetts,

All Rights Reserved

Permission to use, copy, modify, and distribute this software and its documentation for any purpose and without fee is hereby granted, provided that the above copyright notice appear in all copies and that both that copyright notice and this permission notice appear in supporting documentation, and that the name Digital not be used in advertising or publicity pertaining to distribution of the software without specific, written prior permission.

DIGITAL AND WYSE DISCLAIM ALL WARRANTIES WITH REGARD TO THIS SOFTWARE, INCLUDING ALL IMPLIED WARRANTIES OF MERCHANTABILITY AND FITNESS, IN NO EVENT SHALL DIGITAL OR WYSE BE LIABLE FOR ANY SPECIAL, INDIRECT OR CONSEQUENTIAL DAMAGES OR ANY DAMAGES WHATSOEVER RESULTING FROM LOSS OF

USE, DATA OR PROFITS, WHETHER IN AN ACTION OF CONTRACT, NEGLIGENCE OR OTHER TORTIOUS ACTION, ARISING OUT OF OR IN CONNECTION WITH THE USE OR PERFORMANCE OF THIS SOFTWARE.

Copyright 1991, 1992 by Fuji Xerox Co., Ltd.

Copyright 1992, 1993, 1994 by FUJITSU LIMITED

Permission to use, copy, modify, distribute, and sell this software and its documentation for any purpose is hereby granted without fee, provided that the above copyright notice appear in all copies and that both that copyright notice and this permission notice appear in supporting documentation, and that the name of Fuji Xerox, FUJITSU LIMITED not be used in advertising or publicity pertaining to distribution of the software without specific, written prior permission. Fuji Xerox, FUJITSU LIMITED make no representations about the suitability of this software for any purpose. It is provided "as is" without express or implied warranty.

FUJI XEROX, FUJITSU LIMITED DISCLAIM ALL WARRANTIES WITH REGARD TO THIS SOFTWARE, INCLUDING ALL IMPLIED WARRANTIES OF MERCHANTABILITY AND FITNESS, IN NO EVENT SHALL FUJI XEROX, FUJITSU LIMITED BE LIABLE FOR ANY SPECIAL, INDIRECT OR CONSEQUENTIAL DAMAGES OR ANY DAMAGES WHATSOEVER RESULTING FROM LOSS OF USE, DATA OR PROFITS, WHETHER IN AN ACTION OF CONTRACT, NEGLIGENCE OR OTHER TORTIOUS ACTION, ARISING OUT OF OR IN CONNECTION WITH THE USE OR PERFORMANCE OF THIS SOFTWARE.

Copyright 2006 Josh Triplett

Permission is hereby granted, free of charge, to any person obtaining a copy of this software and associated documentation files (the "Software"), to deal in the Software without restriction, including without limitation the rights to use, copy, modify, merge, publish, distribute, sublicense, and/or sell copies of the Software, and to permit persons to whom the Software is furnished to do so, subject to the following conditions:

The above copyright notice and this permission notice shall be included in all copies or substantial portions of the Software.

THE SOFTWARE IS PROVIDED "AS IS", WITHOUT WARRANTY OF ANY KIND, EXPRESS OR IMPLIED, INCLUDING BUT NOT LIMITED TO THE WARRANTIES OF MERCHANTABILITY, FITNESS FOR A PARTICULAR PURPOSE AND NONINFRINGEMENT. IN NO EVENT SHALL THE X CONSORTIUM BE LIABLE FOR ANY CLAIM, DAMAGES OR OTHER LIABILITY, WHETHER IN AN ACTION OF CONTRACT, TORT OR OTHERWISE, ARISING FROM, OUT OF OR IN CONNECTION WITH THE SOFTWARE OR THE USE OR OTHER DEALINGS IN THE SOFTWARE.

(c) Copyright 1996 by Sebastien Marineau and Holger Veit

<marineau@genie.uottawa.ca>

<Holger.Veit@gmd.de>

Permission is hereby granted, free of charge, to any person obtaining a copy of this software and associated documentation files (the "Software"),

to deal in the Software without restriction, including without limitation the rights to use, copy, modify, merge, publish, distribute, sublicense, and/or sell copies of the Software, and to permit persons to whom the Software is furnished to do so, subject to the following conditions:

The above copyright notice and this permission notice shall be included in all copies or substantial portions of the Software.

THE SOFTWARE IS PROVIDED "AS IS", WITHOUT WARRANTY OF ANY KIND, EXPRESS OR IMPLIED, INCLUDING BUT NOT LIMITED TO THE WARRANTIES OF MERCHANTABILITY, FITNESS FOR A PARTICULAR PURPOSE AND NONINFRINGEMENT. IN NO EVENT SHALL

HOLGER VEIT BE LIABLE FOR ANY CLAIM, DAMAGES OR OTHER LIABILITY, WHETHER IN AN ACTION OF CONTRACT, TORT OR OTHERWISE, ARISING FROM, OUT OF OR IN CONNECTION WITH THE SOFTWARE OR THE USE OR OTHER DEALINGS IN THE SOFTWARE.

Except as contained in this notice, the name of Sebastien Marineau or Holger Veit

shall not be used in advertising or otherwise to promote the sale, use or other dealings in this Software without prior written authorization from Holger Veit or Sebastien Marineau.

Copyright 1990, 1991 by OMRON Corporation, NTT Software Corporation,
and Nippon Telegraph and Telephone Corporation

Copyright 1991 by the Open Software Foundation

Copyright 1993 by the TOSHIBA Corp.

Copyright 1993, 1994 by Sony Corporation

Copyright 1993, 1994 by the FUJITSU LIMITED

Permission to use, copy, modify, distribute, and sell this software and its documentation for any purpose is hereby granted without fee, provided that the above copyright notice appear in all copies and that both that copyright notice and this permission notice appear in supporting documentation, and that the names of OMRON, NTT Software, NTT, Open Software Foundation, and Sony Corporation not be used in advertising or publicity pertaining to distribution of the software without specific,

written prior permission. OMRON, NTT Software, NTT, Open Software Foundation, and Sony Corporation make no representations about the suitability of this software for any purpose. It is provided "as is" without express or implied warranty.

OMRON, NTT SOFTWARE, NTT, OPEN SOFTWARE FOUNDATION, AND SONY CORPORATION DISCLAIM ALL WARRANTIES WITH REGARD TO THIS SOFTWARE, INCLUDING ALL IMPLIED WARRANTIES OF MERCHANTABILITY AND FITNESS, IN NO EVENT SHALL OMRON, NTT SOFTWARE, NTT, OPEN SOFTWARE FOUNDATION, OR SONY CORPORATION BE LIABLE FOR ANY SPECIAL, INDIRECT OR CONSEQUENTIAL DAMAGES OR ANY DAMAGES WHATSOEVER RESULTING FROM LOSS OF USE, DATA OR PROFITS, WHETHER IN AN ACTION OF CONTRACT, NEGLIGENCE OR OTHER TORTIOUS ACTION, ARISING OUT OF OR IN CONNECTION WITH THE USE OR PERFORMANCE OF THIS SOFTWARE.

Copyright 2000 by Bruno Haible

Permission to use, copy, modify, distribute, and sell this software and its documentation for any purpose is hereby granted without fee, provided that the above copyright notice appear in all copies and that both that copyright notice and this permission notice appear in supporting documentation, and that the name of Bruno Haible not be used in advertising or publicity pertaining to distribution of the software without specific, written prior permission. Bruno Haible makes no representations about the suitability of this software for any purpose. It is provided "as is" without express or implied warranty.

Bruno Haible DISCLAIMS ALL WARRANTIES WITH REGARD TO THIS SOFTWARE, INCLUDING ALL IMPLIED WARRANTIES OF MERCHANTABILITY AND FITNESS, IN NO EVENT SHALL Bruno Haible BE LIABLE FOR ANY SPECIAL, INDIRECT OR CONSEQUENTIAL DAMAGES OR ANY DAMAGES WHATSOEVER RESULTING FROM LOSS OF USE, DATA OR PROFITS, WHETHER IN AN ACTION OF CONTRACT, NEGLIGENCE OR OTHER TORTIOUS ACTION, ARISING OUT OF OR IN CONNECTION WITH THE USE

OR PERFORMANCE OF THIS SOFTWARE.

Copyright (c) 2007–2009, Troy D. Hanson

All rights reserved.

Redistribution and use in source and binary forms, with or without modification, are permitted provided that the following conditions are met:

Redistributions of source code must retain the above copyright notice, this list of conditions and the following disclaimer.

THIS SOFTWARE IS PROVIDED BY THE COPYRIGHT HOLDERS AND CONTRIBUTORS "AS IS" AND ANY EXPRESS OR IMPLIED WARRANTIES, INCLUDING, BUT NOT LIMITED TO, THE IMPLIED WARRANTIES OF MERCHANTABILITY AND FITNESS FOR A PARTICULAR PURPOSE ARE DISCLAIMED. IN NO EVENT SHALL THE COPYRIGHT OWNER OR CONTRIBUTORS BE LIABLE FOR ANY DIRECT, INDIRECT, INCIDENTAL, SPECIAL, EXEMPLARY, OR CONSEQUENTIAL DAMAGES (INCLUDING, BUT NOT LIMITED TO,

PROCUREMENT OF SUBSTITUTE GOODS OR SERVICES; LOSS OF USE, DATA, OR PROFITS; OR BUSINESS INTERRUPTION) HOWEVER CAUSED AND ON ANY THEORY OF LIABILITY, WHETHER IN CONTRACT, STRICT LIABILITY, OR TORT (INCLUDING NEGLIGENCE OR OTHERWISE) ARISING IN ANY WAY OUT OF THE USE OF THIS SOFTWARE, EVEN IF ADVISED OF THE POSSIBILITY OF SUCH DAMAGE.

Copyright 1992, 1993 by TOSHIBA Corp.

Permission to use, copy, modify, and distribute this software and its documentation for any purpose and without fee is hereby granted, provided that the above copyright notice appear in all copies and that both that copyright notice and this permission notice appear in supporting documentation, and that the name of TOSHIBA not be used in advertising or publicity pertaining to distribution of the software without specific, written prior permission. TOSHIBA make no representations about the suitability of this software for any purpose. It is provided "as is" without express or implied warranty.

TOSHIBA DISCLAIM ALL WARRANTIES WITH REGARD TO THIS SOFTWARE, INCLUDING ALL IMPLIED WARRANTIES OF MERCHANTABILITY AND FITNESS, IN NO EVENT SHALL TOSHIBA BE LIABLE FOR ANY SPECIAL, INDIRECT OR CONSEQUENTIAL DAMAGES OR ANY DAMAGES WHATSOEVER RESULTING FROM LOSS OF USE, DATA OR PROFITS, WHETHER IN AN ACTION OF CONTRACT, NEGLIGENCE OR OTHER TORTIOUS ACTION, ARISING OUT OF OR IN CONNECTION WITH THE USE OR PERFORMANCE OF THIS SOFTWARE.

Copyright IBM Corporation 1993

All Rights Reserved

License to use, copy, modify, and distribute this software and its documentation for any purpose and without fee is hereby granted, provided that the above copyright notice appear in all copies and that both that copyright notice and this permission notice appear in supporting documentation, and that the name of IBM not be used in advertising or publicity pertaining to distribution of the

software without specific, written prior permission.

IBM DISCLAIMS ALL WARRANTIES WITH REGARD TO THIS SOFTWARE, INCLUDING ALL IMPLIED WARRANTIES OF MERCHANTABILITY, FITNESS, AND NONINFRINGEMENT OF THIRD PARTY RIGHTS, IN NO EVENT SHALL IBM BE LIABLE FOR ANY SPECIAL, INDIRECT OR CONSEQUENTIAL DAMAGES OR ANY DAMAGES WHATSOEVER RESULTING FROM LOSS OF USE, DATA OR PROFITS, WHETHER IN AN ACTION OF CONTRACT, NEGLIGENCE OR OTHER TORTIOUS ACTION, ARISING OUT OF OR IN CONNECTION WITH THE USE OR PERFORMANCE OF THIS SOFTWARE.

Copyright 1990, 1991 by OMRON Corporation, NTT Software Corporation,
and Nippon Telegraph and Telephone Corporation

Permission to use, copy, modify, distribute, and sell this software and its documentation for any purpose is hereby granted without fee, provided that the above copyright notice appear in all copies and that both that copyright notice and this permission notice appear in supporting

documentation, and that the names of OMRON, NTT Software, and NTT not be used in advertising or publicity pertaining to distribution of the software without specific, written prior permission. OMRON, NTT Software, and NTT make no representations about the suitability of this software for any purpose. It is provided "as is" without express or implied warranty.

OMRON, NTT SOFTWARE, AND NTT, DISCLAIM ALL WARRANTIES WITH REGARD TO THIS SOFTWARE, INCLUDING ALL IMPLIED WARRANTIES OF MERCHANTABILITY AND FITNESS, IN NO EVENT SHALL OMRON, NTT SOFTWARE, OR NTT, BE LIABLE FOR ANY SPECIAL, INDIRECT OR CONSEQUENTIAL DAMAGES OR ANY DAMAGES WHATSOEVER RESULTING FROM LOSS OF USE, DATA OR PROFITS, WHETHER IN AN ACTION OF CONTRACT, NEGLIGENCE OR OTHER TORTIOUS ACTION, ARISING OUT OF OR IN CONNECTION WITH THE USE OR PERFORMANCE OF THIS SOFTWARE.

Copyright (C) 2001–2006 Bart Massey, Jamey Sharp, and Josh Triplett.

All Rights Reserved.

Permission is hereby granted, free of charge, to any person obtaining a copy of this software and associated documentation files (the "Software"), to deal in the Software without restriction, including without limitation the rights to use, copy, modify, merge, publish, distribute, sublicense, and/or sell copies of the Software, and to permit persons to whom the Software is furnished to do so, subject to the following conditions:

The above copyright notice and this permission notice shall be included in all copies or substantial portions of the Software.

THE SOFTWARE IS PROVIDED "AS IS", WITHOUT WARRANTY OF ANY KIND, EXPRESS OR IMPLIED, INCLUDING BUT NOT LIMITED TO THE WARRANTIES OF MERCHANTABILITY, FITNESS FOR A PARTICULAR PURPOSE AND NONINFRINGEMENT. IN NO EVENT SHALL THE AUTHORS

BE LIABLE FOR ANY CLAIM, DAMAGES OR OTHER LIABILITY, WHETHER
IN AN ACTION OF CONTRACT, TORT OR OTHERWISE, ARISING FROM,
OUT OF OR IN CONNECTION WITH THE SOFTWARE OR THE USE OR
OTHER DEALINGS IN THE SOFTWARE.

Except as contained in this notice, the names of the authors
or their institutions shall not be used in advertising or
otherwise to promote the sale, use or other dealings in this
Software without prior written authorization from the
authors.

Copyright 1988 - 1990, 1992, 1994, 1995 Network Computing Devices

Permission to use, copy, modify, distribute, and sell this software and its
documentation for any purpose is hereby granted without fee, provided that
the above copyright notice appear in all copies and that both that
copyright notice and this permission notice appear in supporting
documentation, and that the name of NCD. not be used in advertising or

publicity pertaining to distribution of the software without specific, written prior permission. NCD. makes no representations about the suitability of this software for any purpose. It is provided "as is" without express or implied warranty.

NCD. DISCLAIMS ALL WARRANTIES WITH REGARD TO THIS SOFTWARE, INCLUDING ALL IMPLIED WARRANTIES OF MERCHANTABILITY AND FITNESS, IN NO EVENT SHALL NCD. BE LIABLE FOR ANY SPECIAL, INDIRECT OR CONSEQUENTIAL DAMAGES OR ANY DAMAGES WHATSOEVER RESULTING FROM LOSS OF USE, DATA OR PROFITS, WHETHER IN AN ACTION OF CONTRACT, NEGLIGENCE OR OTHER TORTIOUS ACTION, ARISING OUT OF OR IN CONNECTION WITH THE USE OR PERFORMANCE OF THIS SOFTWARE.

Copyright 1991,1993 by Digital Equipment Corporation, Maynard, Massachusetts, and Olivetti Research Limited, Cambridge, England.

All Rights Reserved

Permission to use, copy, modify, and distribute this software and its documentation for any purpose and without fee is hereby granted, provided that the above copyright notice appear in all copies and that both that copyright notice and this permission notice appear in supporting documentation, and that the names of Digital or Olivetti not be used in advertising or publicity pertaining to distribution of the software without specific, written prior permission.

DIGITAL AND OLIVETTI DISCLAIM ALL WARRANTIES WITH REGARD TO THIS SOFTWARE, INCLUDING ALL IMPLIED WARRANTIES OF MERCHANTABILITY AND FITNESS, IN NO EVENT SHALL THEY BE LIABLE FOR ANY SPECIAL, INDIRECT OR CONSEQUENTIAL DAMAGES OR ANY DAMAGES WHATSOEVER RESULTING FROM LOSS OF USE, DATA OR PROFITS, WHETHER IN AN ACTION OF CONTRACT, NEGLIGENCE OR OTHER TORTIOUS ACTION, ARISING OUT OF OR IN CONNECTION WITH THE USE OR PERFORMANCE OF THIS SOFTWARE.

Copyright 1999, 2005, 2006 Sun Microsystems, Inc. All rights reserved.

Permission is hereby granted, free of charge, to any person obtaining a copy of this software and associated documentation files (the "Software"), to deal in the Software without restriction, including without limitation the rights to use, copy, modify, merge, publish, distribute, sublicense, and/or sell copies of the Software, and to permit persons to whom the Software is furnished to do so, subject to the following conditions:

The above copyright notice and this permission notice (including the next paragraph) shall be included in all copies or substantial portions of the Software.

THE SOFTWARE IS PROVIDED "AS IS", WITHOUT WARRANTY OF ANY KIND, EXPRESS OR IMPLIED, INCLUDING BUT NOT LIMITED TO THE WARRANTIES OF MERCHANTABILITY, FITNESS FOR A PARTICULAR PURPOSE AND NONINFRINGEMENT. IN NO EVENT SHALL THE AUTHORS OR COPYRIGHT HOLDERS BE LIABLE FOR ANY CLAIM, DAMAGES OR OTHER LIABILITY, WHETHER IN AN ACTION OF CONTRACT, TORT OR OTHERWISE, ARISING

FROM, OUT OF OR IN CONNECTION WITH THE SOFTWARE OR THE USE OR OTHER DEALINGS IN THE SOFTWARE.

Copyright (c) 1989 X Consortium, Inc. and Digital Equipment Corporation.

Copyright (c) 1992 X Consortium, Inc. and Intergraph Corporation.

Copyright (c) 1993 X Consortium, Inc. and Silicon Graphics, Inc.

Copyright (c) 1994, 1995 X Consortium, Inc. and Hewlett-Packard Company.

Permission to use, copy, modify, and distribute this documentation for any purpose and without fee is hereby granted, provided that the above copyright notice and this permission notice appear in all copies.

Digital Equipment Corporation, Intergraph Corporation, Silicon

Graphics, Hewlett-Packard, and the X Consortium make no

representations about the suitability for any purpose of the

information in this document. This documentation is provided ``as is''

without express or implied warranty.

Copyright © 2007 Red Hat, Inc

Copyright © 2008,2009 Sun Microsystems, Inc. All rights reserved.

Permission is hereby granted, free of charge, to any person obtaining a copy of this software and associated documentation files (the "Software"), to deal in the Software without restriction, including without limitation the rights to use, copy, modify, merge, publish, distribute, sublicense, and/or sell copies of the Software, and to permit persons to whom the Software is furnished to do so, subject to the following conditions:

The above copyright notice and this permission notice (including the next paragraph) shall be included in all copies or substantial portions of the Software.

THE SOFTWARE IS PROVIDED "AS IS", WITHOUT WARRANTY OF ANY KIND, EXPRESS OR IMPLIED, INCLUDING BUT NOT LIMITED TO THE WARRANTIES OF MERCHANTABILITY, FITNESS FOR A PARTICULAR PURPOSE AND NONINFRINGEMENT. IN NO EVENT SHALL THE AUTHORS OR COPYRIGHT HOLDERS BE LIABLE FOR ANY CLAIM, DAMAGES OR OTHER

LIABILITY, WHETHER IN AN ACTION OF CONTRACT, TORT OR OTHERWISE, ARISING FROM, OUT OF OR IN CONNECTION WITH THE SOFTWARE OR THE USE OR OTHER DEALINGS IN THE SOFTWARE.

Copyright (c) 1997 by Mark Leisher

Copyright (c) 1998–2003 by Juliusz Chroboczek

Copyright (c) 1998 Go Watanabe, All rights reserved.

Copyright (c) 1998 Kazushi (Jam) Marukawa, All rights reserved.

Copyright (c) 1998 Takuya SHIOZAKI, All rights reserved.

Copyright (c) 1998 X–TrueType Server Project, All rights reserved.

Copyright (c) 2003–2004 After X–TT Project, All rights reserved.

Permission is hereby granted, free of charge, to any person obtaining a copy of this software and associated documentation files (the "Software"), to deal in the Software without restriction, including without limitation the rights to use, copy, modify, merge, publish, distribute, sublicense, and/or sell copies of the Software, and to permit persons to whom the Software is furnished to do so, subject to the following conditions:

The above copyright notice and this permission notice shall be included in all copies or substantial portions of the Software.

THE SOFTWARE IS PROVIDED "AS IS", WITHOUT WARRANTY OF ANY KIND, EXPRESS OR IMPLIED, INCLUDING BUT NOT LIMITED TO THE WARRANTIES OF MERCHANTABILITY, FITNESS FOR A PARTICULAR PURPOSE AND NONINFRINGEMENT. IN NO EVENT SHALL THE AUTHORS OR COPYRIGHT HOLDERS BE LIABLE FOR ANY CLAIM, DAMAGES OR OTHER LIABILITY, WHETHER IN AN ACTION OF CONTRACT, TORT OR OTHERWISE, ARISING FROM, OUT OF OR IN CONNECTION WITH THE SOFTWARE OR THE USE OR OTHER DEALINGS IN THE SOFTWARE.

Copyright 1999, 2000 SuSE, Inc.

Permission to use, copy, modify, distribute, and sell this software and its documentation for any purpose is hereby granted without fee, provided that

the above copyright notice appear in all copies and that both that copyright notice and this permission notice appear in supporting documentation, and that the name of SuSE not be used in advertising or publicity pertaining to distribution of the software without specific, written prior permission. SuSE makes no representations about the suitability of this software for any purpose. It is provided "as is" without express or implied warranty.

SUSE DISCLAIMS ALL WARRANTIES WITH REGARD TO THIS SOFTWARE, INCLUDING ALL IMPLIED WARRANTIES OF MERCHANTABILITY AND FITNESS, IN NO EVENT SHALL SUSE BE LIABLE FOR ANY SPECIAL, INDIRECT OR CONSEQUENTIAL DAMAGES OR ANY DAMAGES WHATSOEVER RESULTING FROM LOSS OF USE, DATA OR PROFITS, WHETHER IN AN ACTION OF CONTRACT, NEGLIGENCE OR OTHER TORTIOUS ACTION, ARISING OUT OF OR IN CONNECTION WITH THE USE OR PERFORMANCE OF THIS SOFTWARE.

Copyright (c) 1991, 1993

The Regents of the University of California. All rights reserved.

Redistribution and use in source and binary forms, with or without modification, are permitted provided that the following conditions are met:

1. Redistributions of source code must retain the above copyright notice, this list of conditions and the following disclaimer.
2. Redistributions in binary form must reproduce the above copyright notice, this list of conditions and the following disclaimer in the documentation and/or other materials provided with the distribution.
3. All advertising materials mentioning features or use of this software must display the following acknowledgement:

This product includes software developed by the University of California, Berkeley and its contributors.
4. Neither the name of the University nor the names of its contributors may be used to endorse or promote products derived from this software without specific prior written permission.

THIS SOFTWARE IS PROVIDED BY THE REGENTS AND CONTRIBUTORS ``AS IS" AND ANY EXPRESS OR IMPLIED WARRANTIES, INCLUDING, BUT NOT LIMITED TO, THE IMPLIED WARRANTIES OF MERCHANTABILITY AND FITNESS FOR A PARTICULAR PURPOSE ARE DISCLAIMED. IN NO EVENT SHALL THE REGENTS OR CONTRIBUTORS BE LIABLE FOR ANY DIRECT, INDIRECT, INCIDENTAL, SPECIAL, EXEMPLARY, OR CONSEQUENTIAL DAMAGES (INCLUDING, BUT NOT LIMITED TO, PROCUREMENT OF SUBSTITUTE GOODS OR SERVICES; LOSS OF USE, DATA, OR PROFITS; OR BUSINESS INTERRUPTION) HOWEVER CAUSED AND ON ANY THEORY OF LIABILITY, WHETHER IN CONTRACT, STRICT LIABILITY, OR TORT (INCLUDING NEGLIGENCE OR OTHERWISE) ARISING IN ANY WAY OUT OF THE USE OF THIS SOFTWARE, EVEN IF ADVISED OF THE POSSIBILITY OF SUCH DAMAGE.

Copyright (c) 1998-1999 Shunsuke Akiyama <akiyama@jp.FreeBSD.org>.

All rights reserved.

Copyright (c) 1998-1999 X-TrueType Server Project, All rights reserved.

Redistribution and use in source and binary forms, with or without modification, are permitted provided that the following conditions are met:

1. Redistributions of source code must retain the above copyright notice, this list of conditions and the following disclaimer.
2. Redistributions in binary form must reproduce the above copyright notice, this list of conditions and the following disclaimer in the documentation and/or other materials provided with the distribution.

THIS SOFTWARE IS PROVIDED BY THE AUTHOR AND CONTRIBUTORS "AS IS" AND ANY EXPRESS OR IMPLIED WARRANTIES, INCLUDING, BUT NOT LIMITED TO, THE IMPLIED WARRANTIES OF MERCHANTABILITY AND FITNESS FOR A PARTICULAR PURPOSE ARE DISCLAIMED. IN NO EVENT SHALL THE AUTHOR OR CONTRIBUTORS BE LIABLE FOR ANY DIRECT, INDIRECT, INCIDENTAL, SPECIAL, EXEMPLARY, OR CONSEQUENTIAL DAMAGES (INCLUDING, BUT NOT LIMITED TO, PROCUREMENT OF SUBSTITUTE GOODS OR SERVICES; LOSS OF USE, DATA, OR PROFITS; OR BUSINESS INTERRUPTION)

HOWEVER CAUSED AND ON ANY THEORY OF LIABILITY, WHETHER IN CONTRACT,
STRICT
LIABILITY, OR TORT (INCLUDING NEGLIGENCE OR OTHERWISE) ARISING IN ANY WAY
OUT OF THE USE OF THIS SOFTWARE, EVEN IF ADVISED OF THE POSSIBILITY OF
SUCH DAMAGE.

Copyright © 2000 Compaq Computer Corporation

Copyright © 2002 Hewlett-Packard Company

Copyright © 2006 Intel Corporation

Permission to use, copy, modify, distribute, and sell this software and its
documentation for any purpose is hereby granted without fee, provided that
the above copyright notice appear in all copies and that both that copyright
notice and this permission notice appear in supporting documentation, and
that the name of the copyright holders not be used in advertising or
publicity pertaining to distribution of the software without specific,
written prior permission. The copyright holders make no representations
about the suitability of this software for any purpose. It is provided "as

is" without express or implied warranty.

THE COPYRIGHT HOLDERS DISCLAIM ALL WARRANTIES WITH REGARD TO THIS SOFTWARE,

INCLUDING ALL IMPLIED WARRANTIES OF MERCHANTABILITY AND FITNESS, IN NO EVENT SHALL THE COPYRIGHT HOLDERS BE LIABLE FOR ANY SPECIAL, INDIRECT OR CONSEQUENTIAL DAMAGES OR ANY DAMAGES WHATSOEVER RESULTING FROM LOSS OF USE,

DATA OR PROFITS, WHETHER IN AN ACTION OF CONTRACT, NEGLIGENCE OR OTHER TORTIOUS ACTION, ARISING OUT OF OR IN CONNECTION WITH THE USE OR PERFORMANCE OF THIS SOFTWARE.

Copyright 1991 by Digital Equipment Corporation, Maynard, Massachusetts, and the Massachusetts Institute of Technology, Cambridge, Massachusetts.

All Rights Reserved

Permission to use, copy, modify, and distribute this software and its documentation for any purpose and without fee is hereby granted, provided that the above copyright notice appear in all copies and that both that copyright notice and this permission notice appear in supporting documentation, and that the names of Digital or MIT not be used in advertising or publicity pertaining to distribution of the software without specific, written prior permission.

DIGITAL DISCLAIMS ALL WARRANTIES WITH REGARD TO THIS SOFTWARE, INCLUDING ALL IMPLIED WARRANTIES OF MERCHANTABILITY AND FITNESS, IN NO EVENT SHALL DIGITAL BE LIABLE FOR ANY SPECIAL, INDIRECT OR CONSEQUENTIAL DAMAGES OR ANY DAMAGES WHATSOEVER RESULTING FROM LOSS OF USE, DATA OR PROFITS, WHETHER IN AN ACTION OF CONTRACT, NEGLIGENCE OR OTHER TORTIOUS ACTION, ARISING OUT OF OR IN CONNECTION WITH THE USE OR PERFORMANCE OF THIS SOFTWARE.

Permission is hereby granted, free of charge, to any person obtaining a copy of this software and associated documentation files (the "Software"), to deal

in the Software without restriction, including without limitation the rights to use, copy, modify, merge, publish, distribute, sublicense, and/or sell copies of the Software, and to permit persons to whom the Software is furnished to do so, subject to the following conditions:

The above copyright notice and this permission notice shall be included in all copies or substantial portions of the Software.

THE SOFTWARE IS PROVIDED "AS IS", WITHOUT WARRANTY OF ANY KIND, EXPRESS OR IMPLIED, INCLUDING BUT NOT LIMITED TO THE WARRANTIES OF MERCHANTABILITY, FITNESS FOR A PARTICULAR PURPOSE AND NONINFRINGEMENT. IN NO EVENT SHALL THE XFREE86 PROJECT BE LIABLE FOR ANY CLAIM, DAMAGES OR OTHER LIABILITY, WHETHER IN AN ACTION OF CONTRACT, TORT OR OTHERWISE, ARISING FROM, OUT OF OR IN CONNECTION WITH THE SOFTWARE OR THE USE OR OTHER DEALINGS IN THE SOFTWARE.

Except as contained in this notice, the name of the XFree86 Project shall not

be used in advertising or otherwise to promote the sale, use or other dealings in this Software without prior written authorization from the XFree86 Project.

Copyright (c) 2004 The Unichrome Project. All rights reserved.

Permission is hereby granted, free of charge, to any person obtaining a copy of this software and associated documentation files (the "Software"), to deal in the Software without restriction, including without limitation the rights to use, copy, modify, merge, publish, distribute, sublicense, and/or sell copies of the Software, and to permit persons to whom the Software is furnished to do so, subject to the following conditions:

The above copyright notice and this permission notice shall be included in all copies or substantial portions of the Software.

THE SOFTWARE IS PROVIDED "AS IS", WITHOUT WARRANTY OF ANY KIND, EXPRESS OR IMPLIED, INCLUDING BUT NOT LIMITED TO THE WARRANTIES OF MERCHANTABILITY,

FITNESS FOR A PARTICULAR PURPOSE AND NONINFRINGEMENT. IN NO EVENT SHALL THE AUTHOR(S) OR COPYRIGHT HOLDER(S) BE LIABLE FOR ANY CLAIM, DAMAGES OR OTHER LIABILITY, WHETHER IN AN ACTION OF CONTRACT, TORT OR OTHERWISE, ARISING FROM, OUT OF OR IN CONNECTION WITH THE SOFTWARE OR THE USE OR OTHER DEALINGS IN THE SOFTWARE.

Copyright (C) 2001–2006 Bart Massey, Jamey Sharp, and Josh Triplett.

All Rights Reserved.

Permission is hereby granted, free of charge, to any person obtaining a copy of this software and associated documentation files (the "Software"), to deal in the Software without restriction, including without limitation the rights to use, copy, modify, merge, publish, distribute, sublicense, and/or sell copies of the Software, and to permit persons to whom the Software is furnished to do so,

subject to the following conditions:

The above copyright notice and this permission notice shall be included in all copies or substantial portions of the Software.

THE SOFTWARE IS PROVIDED "AS IS", WITHOUT WARRANTY OF ANY KIND, EXPRESS OR IMPLIED, INCLUDING BUT NOT LIMITED TO THE WARRANTIES OF MERCHANTABILITY, FITNESS FOR A PARTICULAR PURPOSE AND NONINFRINGEMENT. IN NO EVENT SHALL THE AUTHORS BE LIABLE FOR ANY CLAIM, DAMAGES OR OTHER LIABILITY, WHETHER IN AN ACTION OF CONTRACT, TORT OR OTHERWISE, ARISING FROM, OUT OF OR IN CONNECTION WITH THE SOFTWARE OR THE USE OR OTHER DEALINGS IN THE SOFTWARE.

Except as contained in this notice, the names of the authors or their institutions shall not be used in advertising or otherwise to promote the sale, use or other dealings in this Software without prior written authorization from the

authors.

Copyright © 2006–2008 Peter Hutterer

Permission is hereby granted, free of charge, to any person obtaining a copy of this software and associated documentation files (the "Software"), to deal in the Software without restriction, including without limitation the rights to use, copy, modify, merge, publish, distribute, sublicense, and/or sell copies of the Software, and to permit persons to whom the Software is furnished to do so, subject to the following conditions:

The above copyright notice and this permission notice (including the next paragraph) shall be included in all copies or substantial portions of the Software.

THE SOFTWARE IS PROVIDED "AS IS", WITHOUT WARRANTY OF ANY KIND, EXPRESS OR IMPLIED, INCLUDING BUT NOT LIMITED TO THE WARRANTIES OF MERCHANTABILITY,

FITNESS FOR A PARTICULAR PURPOSE AND NONINFRINGEMENT. IN NO EVENT SHALL

THE AUTHORS OR COPYRIGHT HOLDERS BE LIABLE FOR ANY CLAIM, DAMAGES OR OTHER

LIABILITY, WHETHER IN AN ACTION OF CONTRACT, TORT OR OTHERWISE, ARISING FROM, OUT OF OR IN CONNECTION WITH THE SOFTWARE OR THE USE OR OTHER DEALINGS IN THE SOFTWARE.

Copyright 1990,91 by Thomas Roell, Dinkelscherben, Germany.

Copyright 1993 by David Dawes <dawes@xfree86.org>

Copyright 2002 by SuSE Linux AG, Author: Egbert Eich

Copyright 1994–2002 by The XFree86 Project, Inc.

Copyright 2002 by Paul Elliott

Copyright © 2008 University of South Australia

Copyright 2008 by Chris Salch

Copyright © 2008, 2009 Red Hat, Inc.

Permission to use, copy, modify, distribute, and sell this software

and its documentation for any purpose is hereby granted without fee, provided that the above copyright notice appear in all copies and that both that copyright notice and this permission notice appear in supporting documentation, and that the name of the authors not be used in advertising or publicity pertaining to distribution of the software without specific, written prior permission. The authors make no representations about the suitability of this software for any purpose. It is provided "as is" without express or implied warranty.

THE AUTHORS DISCLAIM ALL WARRANTIES WITH REGARD TO THIS SOFTWARE, INCLUDING ALL IMPLIED WARRANTIES OF MERCHANTABILITY AND FITNESS, IN NO EVENT SHALL THE AUTHORS BE LIABLE FOR ANY SPECIAL, INDIRECT OR CONSEQUENTIAL DAMAGES OR ANY DAMAGES WHATSOEVER RESULTING FROM LOSS OF USE, DATA OR PROFITS, WHETHER IN AN ACTION OF CONTRACT, NEGLIGENCE OR OTHER TORTIOUS ACTION, ARISING OUT OF OR IN CONNECTION WITH THE USE OR PERFORMANCE OF THIS SOFTWARE.

Copyright 2005 Adam Jackson.

Permission is hereby granted, free of charge, to any person obtaining a copy of this software and associated documentation files (the "Software"), to deal in the Software without restriction, including without limitation on the rights to use, copy, modify, merge, publish, distribute, sublicense, and/or sell copies of the Software, and to permit persons to whom the Software is furnished to do so, subject to the following conditions:

The above copyright notice and this permission notice (including the next paragraph) shall be included in all copies or substantial portions of the Software.

THE SOFTWARE IS PROVIDED "AS IS", WITHOUT WARRANTY OF ANY KIND, EXPRESS OR IMPLIED, INCLUDING BUT NOT LIMITED TO THE WARRANTIES OF MERCHANTABILITY, FITNESS FOR A PARTICULAR PURPOSE AND NON-INFRINGEMENT. IN NO EVENT SHALL ADAM JACKSON BE LIABLE FOR ANY CLAIM, DAMAGES OR OTHER LIABILITY, WHETHER

IN AN ACTION OF CONTRACT, TORT OR OTHERWISE, ARISING FROM, OUT OF OR IN CONNECTION WITH THE SOFTWARE OR THE USE OR OTHER DEALINGS IN THE SOFTWARE.

Copyright (c) 1992–2003 by The XFree86 Project, Inc.

Copyright 1997 by Metro Link, Inc.

Permission is hereby granted, free of charge, to any person obtaining a copy of this software and associated documentation files (the "Software"), to deal in the Software without restriction, including without limitation the rights to use, copy, modify, merge, publish, distribute, sublicense, and/or sell copies of the Software, and to permit persons to whom the Software is furnished to do so, subject to the following conditions:

The above copyright notice and this permission notice shall be included in all copies or substantial portions of the Software.

THE SOFTWARE IS PROVIDED "AS IS", WITHOUT WARRANTY OF ANY KIND, EXPRESS OR

IMPLIED, INCLUDING BUT NOT LIMITED TO THE WARRANTIES OF MERCHANTABILITY,
FITNESS FOR A PARTICULAR PURPOSE AND NONINFRINGEMENT. IN NO EVENT
SHALL
THE COPYRIGHT HOLDER(S) OR AUTHOR(S) BE LIABLE FOR ANY CLAIM, DAMAGES OR
OTHER LIABILITY, WHETHER IN AN ACTION OF CONTRACT, TORT OR OTHERWISE,
ARISING FROM, OUT OF OR IN CONNECTION WITH THE SOFTWARE OR THE USE OR
OTHER DEALINGS IN THE SOFTWARE.

Except as contained in this notice, the name of the copyright holder(s)
and author(s) shall not be used in advertising or otherwise to promote
the sale, use or other dealings in this Software without prior written
authorization from the copyright holder(s) and author(s).

Copyright 1990,91 by Thomas Roell, Dinkelscherben, Germany.

Copyright 1993 by David Dawes <dawes@xfree86.org>

Permission to use, copy, modify, distribute, and sell this software and its
documentation for any purpose is hereby granted without fee, provided that

the above copyright notice appear in all copies and that both that copyright notice and this permission notice appear in supporting documentation, and that the names of Thomas Roell and David Dawes not be used in advertising or publicity pertaining to distribution of the software without specific, written prior permission. Thomas Roell and David Dawes make no representations about the suitability of this software for any purpose. It is provided "as is" without express or implied warranty.

THOMAS ROELL AND DAVID DAWES DISCLAIM ALL WARRANTIES WITH REGARD TO THIS SOFTWARE, INCLUDING ALL IMPLIED WARRANTIES OF MERCHANTABILITY AND FITNESS.

IN NO EVENT SHALL THOMAS ROELL OR DAVID DAWES BE LIABLE FOR ANY SPECIAL, INDIRECT OR CONSEQUENTIAL DAMAGES OR ANY DAMAGES WHATSOEVER RESULTING FROM

LOSS OF USE, DATA OR PROFITS, WHETHER IN AN ACTION OF CONTRACT, NEGLIGENCE

OR OTHER TORTIOUS ACTION, ARISING OUT OF OR IN CONNECTION WITH THE USE OR

PERFORMANCE OF THIS SOFTWARE.

Copyright 1992 by Rich Murphey <Rich@Rice.edu>

Copyright 1993 by David Dawes <dawes@xfree86.org>

Permission to use, copy, modify, distribute, and sell this software and its documentation for any purpose is hereby granted without fee, provided that the above copyright notice appear in all copies and that both that copyright notice and this permission notice appear in supporting documentation, and that the names of Rich Murphey and David Dawes not be used in advertising or publicity pertaining to distribution of the software without specific, written prior permission. Rich Murphey and David Dawes make no representations about the suitability of this software for any purpose. It is provided "as is" without express or implied warranty.

RICH MURPHEY AND DAVID DAWES DISCLAIM ALL WARRANTIES WITH REGARD TO THIS SOFTWARE, INCLUDING ALL IMPLIED WARRANTIES OF MERCHANTABILITY AND

FITNESS, IN NO EVENT SHALL RICH MURPHEY OR DAVID DAWES BE LIABLE FOR ANY SPECIAL, INDIRECT OR CONSEQUENTIAL DAMAGES OR ANY DAMAGES WHATSOEVER RESULTING FROM LOSS OF USE, DATA OR PROFITS, WHETHER IN AN ACTION OF CONTRACT, NEGLIGENCE OR OTHER TORTIOUS ACTION, ARISING OUT OF OR IN CONNECTION WITH THE USE OR PERFORMANCE OF THIS SOFTWARE.

Copyright 1992 by Orest Zborowski <obz@Kodak.com>

Copyright 1993 by David Dawes <dawes@xfree86.org>

Permission to use, copy, modify, distribute, and sell this software and its documentation for any purpose is hereby granted without fee, provided that the above copyright notice appear in all copies and that both that copyright notice and this permission notice appear in supporting documentation, and that the names of Orest Zborowski and David Dawes not be used in advertising or publicity pertaining to distribution of the software without specific, written prior permission. Orest Zborowski and David Dawes make no representations about the suitability of this

software for any purpose. It is provided "as is" without express or implied warranty.

OREST ZBOROWSKI AND DAVID DAWES DISCLAIMS ALL WARRANTIES WITH REGARD TO THIS SOFTWARE, INCLUDING ALL IMPLIED WARRANTIES OF MERCHANTABILITY AND FITNESS, IN NO EVENT SHALL OREST ZBOROWSKI OR DAVID DAWES BE LIABLE FOR ANY SPECIAL, INDIRECT OR CONSEQUENTIAL DAMAGES OR ANY DAMAGES WHATSOEVER RESULTING FROM LOSS OF USE, DATA OR PROFITS, WHETHER IN AN ACTION OF CONTRACT, NEGLIGENCE OR OTHER TORTIOUS ACTION, ARISING OUT OF OR IN CONNECTION WITH THE USE OR PERFORMANCE OF THIS SOFTWARE.

Portions based on kbdrate.c from util-linux 2.9t, which is

Copyright 1992 Rickard E. Faith. Distributed under the GPL.

This program comes with ABSOLUTELY NO WARRANTY.

Copyright 1990,91 by Thomas Roell, Dinkelscherben, Germany

Copyright 1993 by David Dawes <dawes@XFree86.org>

Copyright 1999 by David Holland <davidh@iquest.net)

Permission to use, copy, modify, distribute, and sell this software and its documentation for any purpose is hereby granted without fee, provided that the above copyright notice appear in all copies and that both that copyright notice and this permission notice appear in supporting documentation, and that the names of Thomas Roell, David Dawes, and David Holland not be used in advertising or publicity pertaining to distribution of the software without specific, written prior permission. Thomas Roell, David Dawes, and David Holland make no representations about the suitability of this software for any purpose. It is provided "as is" without express or implied warranty.

THOMAS ROELL, DAVID DAWES, AND DAVID HOLLAND DISCLAIM ALL WARRANTIES
WITH
REGARD TO THIS SOFTWARE, INCLUDING ALL IMPLIED WARRANTIES OF
MERCHANTABILITY

AND FITNESS. IN NO EVENT SHALL THOMAS ROELL, DAVID DAWES, OR DAVID
HOLLAND
BE LIABLE FOR ANY SPECIAL, INDIRECT OR CONSEQUENTIAL DAMAGES OR ANY
DAMAGES
WHATSOEVER RESULTING FROM LOSS OF USE, DATA OR PROFITS, WHETHER IN AN
ACTION
OF CONTRACT, NEGLIGENCE OR OTHER TORTIOUS ACTION, ARISING OUT OF OR IN
CONNECTION WITH THE USE OR PERFORMANCE OF THIS SOFTWARE.

Copyright 1990,91 by Thomas Roell, Dinkelscherben, Germany.

Copyright 1993 by David Dawes <dawes@xfree86.org>

Copyright 2002 by SuSE Linux AG, Author: Egbert Eich

Copyright 1994–2002 by The XFree86 Project, Inc.

Copyright 2002 by Paul Elliott

Permission to use, copy, modify, distribute, and sell this software and its
documentation for any purpose is hereby granted without fee, provided that
the above copyright notice appear in all copies and that both that

copyright notice and this permission notice appear in supporting documentation, and that the names of copyright holders not be used in advertising or publicity pertaining to distribution of the software without specific, written prior permission. The copyright holders make no representations about the suitability of this software for any purpose. It is provided "as is" without express or implied warranty.

THE COPYRIGHT HOLDERS DISCLAIM ALL WARRANTIES WITH REGARD TO THIS SOFTWARE, INCLUDING ALL IMPLIED WARRANTIES OF MERCHANTABILITY AND FITNESS, IN NO EVENT SHALL THE COPYRIGHT HOLDERS BE LIABLE FOR ANY SPECIAL, INDIRECT OR CONSEQUENTIAL DAMAGES OR ANY DAMAGES WHATSOEVER RESULTING FROM LOSS OF USE, DATA OR PROFITS, WHETHER IN AN ACTION OF CONTRACT, NEGLIGENCE OR OTHER TORTIOUS ACTION, ARISING OUT OF OR IN CONNECTION WITH THE USE OR PERFORMANCE OF THIS SOFTWARE.

Copyright 1998 by Kazutaka YOKOTA <yokota@zodiac.mech.utsunomiya-u.ac.jp>

Permission to use, copy, modify, distribute, and sell this software and its documentation for any purpose is hereby granted without fee, provided that the above copyright notice appear in all copies and that both that copyright notice and this permission notice appear in supporting documentation, and that the name of Kazutaka YOKOTA not be used in advertising or publicity pertaining to distribution of the software without specific, written prior permission. Kazutaka YOKOTA makes no representations about the suitability of this software for any purpose. It is provided "as is" without express or implied warranty.

KAZUTAKA YOKOTA DISCLAIMS ALL WARRANTIES WITH REGARD TO THIS SOFTWARE, INCLUDING ALL IMPLIED WARRANTIES OF MERCHANTABILITY AND FITNESS, IN NO EVENT SHALL KAZUTAKA YOKOTA BE LIABLE FOR ANY SPECIAL, INDIRECT OR CONSEQUENTIAL DAMAGES OR ANY DAMAGES WHATSOEVER RESULTING FROM LOSS OF USE, DATA OR PROFITS, WHETHER IN AN ACTION OF CONTRACT, NEGLIGENCE OR OTHER TORTIOUS ACTION, ARISING OUT OF OR IN CONNECTION WITH THE USE OR PERFORMANCE OF THIS SOFTWARE.

Copyright 1997,1998 by UCHIYAMA Yasushi

Permission to use, copy, modify, distribute, and sell this software and its documentation for any purpose is hereby granted without fee, provided that the above copyright notice appear in all copies and that both that copyright notice and this permission notice appear in supporting documentation, and that the name of UCHIYAMA Yasushi not be used in advertising or publicity pertaining to distribution of the software without specific, written prior permission. UCHIYAMA Yasushi makes no representations about the suitability of this software for any purpose. It is provided "as is" without express or implied warranty.

UCHIYAMA YASUSHI DISCLAIMS ALL WARRANTIES WITH REGARD TO THIS SOFTWARE, INCLUDING ALL IMPLIED WARRANTIES OF MERCHANTABILITY AND FITNESS, IN NO EVENT SHALL UCHIYAMA YASUSHI BE LIABLE FOR ANY SPECIAL, INDIRECT OR CONSEQUENTIAL DAMAGES OR ANY DAMAGES WHATSOEVER RESULTING FROM LOSS OF USE, DATA OR PROFITS, WHETHER IN AN ACTION OF CONTRACT, NEGLIGENCE OR OTHER

TORTIOUS ACTION, ARISING OUT OF OR IN CONNECTION WITH THE USE OR PERFORMANCE OF THIS SOFTWARE.

Copyright 2001 – 2005 by J. Kean Johnston <jkj@sco.com>

Permission to use, copy, modify, distribute, and sell this software and its documentation for any purpose is hereby granted without fee, provided that the above copyright notice appear in all copies and that both that copyright notice and this permission notice appear in supporting documentation, and that the name J. Kean Johnston not be used in advertising or publicity pertaining to distribution of the software without specific, written prior permission. J. Kean Johnston makes no representations about the suitability of this software for any purpose. It is provided "as is" without express or implied warranty.

J. KEAN JOHNSTON DISCLAIMS ALL WARRANTIES WITH REGARD TO THIS SOFTWARE, INCLUDING ALL IMPLIED WARRANTIES OF MERCHANTABILITY AND FITNESS, IN NO EVENT SHALL J. KEAN JOHNSTON BE LIABLE FOR ANY SPECIAL, INDIRECT OR

CONSEQUENTIAL DAMAGES OR ANY DAMAGES WHATSOEVER RESULTING FROM LOSS OF USE, DATA OR PROFITS, WHETHER IN AN ACTION OF CONTRACT, NEGLIGENCE OR OTHER TORTIOUS ACTION, ARISING OUT OF OR IN CONNECTION WITH THE USE OR PERFORMANCE OF THIS SOFTWARE.

Copyright 2002, 2003, 2005 Tungsten Graphics, Inc., Cedar Park, Texas.

All Rights Reserved.

Permission is hereby granted, free of charge, to any person obtaining a copy of this software and associated documentation files (the "Software"), to deal in the Software without restriction, including without limitation the rights to use, copy, modify, merge, publish, distribute, sub license, and/or sell copies of the Software, and to permit persons to whom the Software is furnished to do so, subject to the following conditions:

The above copyright notice and this permission notice (including the

next paragraph) shall be included in all copies or substantial portions of the Software.

THE SOFTWARE IS PROVIDED "AS IS", WITHOUT WARRANTY OF ANY KIND, EXPRESS OR IMPLIED, INCLUDING BUT NOT LIMITED TO THE WARRANTIES OF MERCHANTABILITY, FITNESS FOR A PARTICULAR PURPOSE AND NON-INFRINGEMENT. IN NO EVENT SHALL TUNGSTEN GRAPHICS AND/OR ITS SUPPLIERS BE LIABLE FOR ANY CLAIM, DAMAGES OR OTHER LIABILITY, WHETHER IN AN ACTION OF CONTRACT, TORT OR OTHERWISE, ARISING FROM, OUT OF OR IN CONNECTION WITH THE SOFTWARE OR THE USE OR OTHER DEALINGS IN THE SOFTWARE.

Copyright (c) 2005 Jesse Barnes <jbarnes@virtuousgeek.org>

Copyright © 2002 David Dawes

Copyright 1998-1999 Precision Insight, Inc., Cedar Park, Texas.

All Rights Reserved.

Permission is hereby granted, free of charge, to any person obtaining a copy of this software and associated documentation files (the

"Software"), to deal in the Software without restriction, including without limitation the rights to use, copy, modify, merge, publish, distribute, sub license, and/or sell copies of the Software, and to permit persons to whom the Software is furnished to do so, subject to the following conditions:

The above copyright notice and this permission notice (including the next paragraph) shall be included in all copies or substantial portions of the Software.

THE SOFTWARE IS PROVIDED "AS IS", WITHOUT WARRANTY OF ANY KIND, EXPRESS OR IMPLIED, INCLUDING BUT NOT LIMITED TO THE WARRANTIES OF MERCHANTABILITY, FITNESS FOR A PARTICULAR PURPOSE AND NON-INFRINGEMENT. IN NO EVENT SHALL PRECISION INSIGHT AND/OR ITS SUPPLIERS BE LIABLE FOR ANY CLAIM, DAMAGES OR OTHER LIABILITY, WHETHER IN AN ACTION OF CONTRACT, TORT OR OTHERWISE, ARISING FROM, OUT OF OR IN CONNECTION WITH THE SOFTWARE OR THE USE OR OTHER DEALINGS IN THE SOFTWARE.

Copyright © 2006 – 2010 Intel Corporation

Copyright © 2007 Red Hat, Inc.

Permission is hereby granted, free of charge, to any person obtaining a copy of this software and associated documentation files (the "Software"), to deal in the Software without restriction, including without limitation the rights to use, copy, modify, merge, publish, distribute, sublicense, and/or sell copies of the Software, and to permit persons to whom the Software is furnished to do so, subject to the following conditions:

The above copyright notice and this permission notice (including the next paragraph) shall be included in all copies or substantial portions of the Software.

THE SOFTWARE IS PROVIDED "AS IS", WITHOUT WARRANTY OF ANY KIND, EXPRESS OR IMPLIED, INCLUDING BUT NOT LIMITED TO THE WARRANTIES OF MERCHANTABILITY, FITNESS FOR A PARTICULAR PURPOSE AND NONINFRINGEMENT. IN NO EVENT SHALL THE AUTHORS OR COPYRIGHT HOLDERS BE LIABLE FOR ANY CLAIM, DAMAGES OR OTHER

LIABILITY, WHETHER IN AN ACTION OF CONTRACT, TORT OR OTHERWISE, ARISING FROM, OUT OF OR IN CONNECTION WITH THE SOFTWARE OR THE USE OR OTHER DEALINGS IN THE SOFTWARE.

Copyright 2000 by Alan Hourihane, Sychdyn, North Wales, UK.

Permission to use, copy, modify, distribute, and sell this software and its documentation for any purpose is hereby granted without fee, provided that the above copyright notice appear in all copies and that both that copyright notice and this permission notice appear in supporting documentation, and that the name of Alan Hourihane not be used in advertising or publicity pertaining to distribution of the software without specific, written prior permission. Alan Hourihane makes no representations about the suitability of this software for any purpose. It is provided "as is" without express or implied warranty.

ALAN HOURIHANE DISCLAIMS ALL WARRANTIES WITH REGARD TO THIS SOFTWARE,

INCLUDING ALL IMPLIED WARRANTIES OF MERCHANTABILITY AND FITNESS, IN NO EVENT SHALL ALAN HOURIHANE BE LIABLE FOR ANY SPECIAL, INDIRECT OR CONSEQUENTIAL DAMAGES OR ANY DAMAGES WHATSOEVER RESULTING FROM LOSS OF USE, DATA OR PROFITS, WHETHER IN AN ACTION OF CONTRACT, NEGLIGENCE OR OTHER TORTIOUS ACTION, ARISING OUT OF OR IN CONNECTION WITH THE USE OR PERFORMANCE OF THIS SOFTWARE.

Copyright 2000 Intel Corporation. All Rights Reserved.

Permission is hereby granted, free of charge, to any person obtaining a copy of this software and associated documentation files (the "Software"), to deal in the Software without restriction, including without limitation the rights to use, copy, modify, merge, publish, distribute, sub license, and/or sell copies of the Software, and to permit persons to whom the Software is furnished to do so, subject to the following conditions:

The above copyright notice and this permission notice (including the

next paragraph) shall be included in all copies or substantial portions of the Software.

THE SOFTWARE IS PROVIDED "AS IS", WITHOUT WARRANTY OF ANY KIND, EXPRESS OR IMPLIED, INCLUDING BUT NOT LIMITED TO THE WARRANTIES OF MERCHANTABILITY, FITNESS FOR A PARTICULAR PURPOSE AND NON-INFRINGEMENT. IN NO EVENT SHALL INTEL, AND/OR ITS SUPPLIERS BE LIABLE FOR ANY CLAIM, DAMAGES OR OTHER LIABILITY, WHETHER IN AN ACTION OF CONTRACT, TORT OR OTHERWISE, ARISING FROM, OUT OF OR IN CONNECTION WITH THE SOFTWARE OR THE USE OR OTHER DEALINGS IN THE SOFTWARE.

Copyright 2001 VA Linux Systems Inc., Fremont, California.

Copyright © 2002 by David Dawes

All Rights Reserved.

Permission is hereby granted, free of charge, to any person obtaining a copy of this software and associated documentation files (the "Software"), to deal in the Software without restriction, including without limitation

on the rights to use, copy, modify, merge, publish, distribute, sub
license, and/or sell copies of the Software, and to permit persons to whom
the Software is furnished to do so, subject to the following conditions:

The above copyright notice and this permission notice (including the next
paragraph) shall be included in all copies or substantial portions of the
Software.

THE SOFTWARE IS PROVIDED "AS IS", WITHOUT WARRANTY OF ANY KIND, EXPRESS OR
IMPLIED, INCLUDING BUT NOT LIMITED TO THE WARRANTIES OF MERCHANTABILITY,
FITNESS FOR A PARTICULAR PURPOSE AND NON-INFRINGEMENT. IN NO EVENT SHALL
ATI, VA LINUX SYSTEMS AND/OR THEIR SUPPLIERS BE LIABLE FOR ANY CLAIM,
DAMAGES OR OTHER LIABILITY, WHETHER IN AN ACTION OF CONTRACT, TORT OR
OTHERWISE, ARISING FROM, OUT OF OR IN CONNECTION WITH THE SOFTWARE OR
THE
USE OR OTHER DEALINGS IN THE SOFTWARE.

Copyright © 2000–2001 Juliusz Chroboczek

Copyright © 1998 Egbert Eich

Copyright © 2006–2007 Intel Corporation

Copyright © 2006 Nokia Corporation

Copyright © 2006–2008 Peter Hutterer

Copyright © 2006 Adam Jackson

Copyright © 2009 NVIDIA Corporation

Copyright © 1999 Keith Packard

Copyright © 2007–2009 Red Hat, Inc.

Copyright © 2005–2008 Daniel Stone

Copyright © 2006–2009 Simon Thum

Copyright © 1987, 2003–2006, 2008–2009 Sun Microsystems, Inc.

Copyright © 2006 Luc Verhaegen

Permission is hereby granted, free of charge, to any person obtaining a copy of this software and associated documentation files (the "Software"), to deal in the Software without restriction, including without limitation the rights to use, copy, modify, merge, publish, distribute, sublicense, and/or sell copies of the Software, and to permit persons to whom the Software is furnished to do so, subject to the following conditions:

The above copyright notice and this permission notice (including the next paragraph) shall be included in all copies or substantial portions of the Software.

THE SOFTWARE IS PROVIDED "AS IS", WITHOUT WARRANTY OF ANY KIND, EXPRESS OR IMPLIED, INCLUDING BUT NOT LIMITED TO THE WARRANTIES OF MERCHANTABILITY, FITNESS FOR A PARTICULAR PURPOSE AND NONINFRINGEMENT. IN NO EVENT SHALL THE AUTHORS OR COPYRIGHT HOLDERS BE LIABLE FOR ANY CLAIM, DAMAGES OR OTHER LIABILITY, WHETHER IN AN ACTION OF CONTRACT, TORT OR OTHERWISE, ARISING FROM, OUT OF OR IN CONNECTION WITH THE SOFTWARE OR THE USE OR OTHER DEALINGS IN THE SOFTWARE.

Copyright (C) 1994–2003 The XFree86 Project, Inc. All Rights Reserved.

Copyright (C) Colin Harrison 2005–2008

Permission is hereby granted, free of charge, to any person obtaining a copy of this software and associated documentation files (the "Software"), to deal in the Software without restriction, including without limitation the rights to use, copy, modify, merge, publish, distribute, sublicense, and/or sell copies of the Software, and to permit persons to whom the Software is furnished to do so, subject to the following conditions:

The above copyright notice and this permission notice shall be included in all copies or substantial portions of the Software.

THE SOFTWARE IS PROVIDED "AS IS", WITHOUT WARRANTY OF ANY KIND, EXPRESS OR IMPLIED, INCLUDING BUT NOT LIMITED TO THE WARRANTIES OF MERCHANTABILITY, FIT-
NESS FOR A PARTICULAR PURPOSE AND NONINFRINGEMENT. IN NO EVENT SHALL
THE
XFREE86 PROJECT BE LIABLE FOR ANY CLAIM, DAMAGES OR OTHER LIABILITY,
WHETHER IN
AN ACTION OF CONTRACT, TORT OR OTHERWISE, ARISING FROM, OUT OF OR IN
CONNECTION

WITH THE SOFTWARE OR THE USE OR OTHER DEALINGS IN THE SOFTWARE.

Except as contained in this notice, the name of the XFree86 Project shall not be used in advertising or otherwise to promote the sale, use or other dealings in this Software without prior written authorization from the XFree86 Project.

Copyright 1985–1998, 2001 The Open Group

Copyright 2002 Red Hat Inc., Durham, North Carolina.

Permission to use, copy, modify, distribute, and sell this software and its documentation for any purpose is hereby granted without fee, provided that the above copyright notice appear in all copies and that both that copyright notice and this permission notice appear in supporting documentation.

The above copyright notice and this permission notice shall be included in all copies or substantial portions of the Software.

THE SOFTWARE IS PROVIDED "AS IS", WITHOUT WARRANTY OF ANY KIND, EXPRESS OR IMPLIED, INCLUDING BUT NOT LIMITED TO THE WARRANTIES OF MERCHANTABILITY, FITNESS FOR A PARTICULAR PURPOSE AND NONINFRINGEMENT. IN NO EVENT SHALL THE OPEN GROUP BE LIABLE FOR ANY CLAIM, DAMAGES OR OTHER LIABILITY, WHETHER IN AN ACTION OF CONTRACT, TORT OR OTHERWISE, ARISING FROM, OUT OF OR IN CONNECTION WITH THE SOFTWARE OR THE USE OR OTHER DEALINGS IN THE SOFTWARE.

Except as contained in this notice, the name of The Open Group shall not be used in advertising or otherwise to promote the sale, use or other dealings in this Software without prior written authorization from The Open Group.

Copyright (c) 1987, 1989–1990, 1992–1995 X Consortium

Permission is hereby granted, free of charge, to any person obtaining a copy of this software and associated documentation files (the "Software"), to deal

in the Software without restriction, including without limitation the rights to use, copy, modify, merge, publish, distribute, sublicense, and/or sell copies of the Software, and to permit persons to whom the Software is furnished to do so, subject to the following conditions:

The above copyright notice and this permission notice shall be included in all copies or substantial portions of the Software.

THE SOFTWARE IS PROVIDED "AS IS", WITHOUT WARRANTY OF ANY KIND, EXPRESS OR IMPLIED, INCLUDING BUT NOT LIMITED TO THE WARRANTIES OF MERCHANTABILITY, FITNESS FOR A PARTICULAR PURPOSE AND NONINFRINGEMENT. IN NO EVENT SHALL THE X CONSORTIUM BE LIABLE FOR ANY CLAIM, DAMAGES OR OTHER LIABILITY, WHETHER IN AN ACTION OF CONTRACT, TORT OR OTHERWISE, ARISING FROM, OUT OF OR IN CONNECTION WITH THE SOFTWARE OR THE USE OR OTHER DEALINGS IN THE SOFTWARE.

Except as contained in this notice, the name of the X Consortium shall not be

used in advertising or otherwise to promote the sale, use or other dealings in this Software without prior written authorization from the X Consortium.

Copyright © 1999–2000 SuSE, Inc.

Copyright © 2007, 2008 Red Hat, Inc.

Permission to use, copy, modify, distribute, and sell this software and its documentation for any purpose is hereby granted without fee, provided that the above copyright notice appear in all copies and that both that copyright notice and this permission notice appear in supporting documentation, and that the name of SuSE not be used in advertising or publicity pertaining to distribution of the software without specific, written prior permission. SuSE makes no representations about the suitability of this software for any purpose. It is provided "as is" without express or implied warranty.

SuSE DISCLAIMS ALL WARRANTIES WITH REGARD TO THIS SOFTWARE, INCLUDING ALL

IMPLIED WARRANTIES OF MERCHANTABILITY AND FITNESS, IN NO EVENT SHALL SuSE
BE LIABLE FOR ANY SPECIAL, INDIRECT OR CONSEQUENTIAL DAMAGES OR ANY
DAMAGES
WHATSOEVER RESULTING FROM LOSS OF USE, DATA OR PROFITS, WHETHER IN AN
ACTION
OF CONTRACT, NEGLIGENCE OR OTHER TORTIOUS ACTION, ARISING OUT OF OR IN
CONNECTION WITH THE USE OR PERFORMANCE OF THIS SOFTWARE.

Copyright 1987–1991, 1993 by Digital Equipment Corporation, Maynard,
Massachusetts.

Copyright 1991 Massachusetts Institute of Technology, Cambridge, Massachusetts.

Copyright 1991, 1993 Olivetti Research Limited, Cambridge, England.

All Rights Reserved

Permission to use, copy, modify, and distribute this software and its
documentation for any purpose and without fee is hereby granted,
provided that the above copyright notice appear in all copies and that

both that copyright notice and this permission notice appear in supporting documentation, and that the name of Digital not be used in advertising or publicity pertaining to distribution of the software without specific, written prior permission.

DIGITAL DISCLAIMS ALL WARRANTIES WITH REGARD TO THIS SOFTWARE, INCLUDING ALL IMPLIED WARRANTIES OF MERCHANTABILITY AND FITNESS, IN NO EVENT SHALL DIGITAL BE LIABLE FOR ANY SPECIAL, INDIRECT OR CONSEQUENTIAL DAMAGES OR ANY DAMAGES WHATSOEVER RESULTING FROM LOSS OF USE, DATA OR PROFITS, WHETHER IN AN ACTION OF CONTRACT, NEGLIGENCE OR OTHER TORTIOUS ACTION, ARISING OUT OF OR IN CONNECTION WITH THE USE OR PERFORMANCE OF THIS SOFTWARE.

Copyright 1987 by Digital Equipment Corporation, Maynard, Massachusetts,
Copyright 1994 Quarterdeck Office Systems.

All Rights Reserved

Permission to use, copy, modify, and distribute this software and its documentation for any purpose and without fee is hereby granted, provided that the above copyright notice appear in all copies and that both that copyright notice and this permission notice appear in supporting documentation, and that the names of Digital and Quarterdeck not be used in advertising or publicity pertaining to distribution of the software without specific, written prior permission.

DIGITAL AND QUARTERDECK DISCLAIM ALL WARRANTIES WITH REGARD TO THIS SOFTWARE, INCLUDING ALL IMPLIED WARRANTIES OF MERCHANTABILITY AND FITNESS, IN NO EVENT SHALL DIGITAL BE LIABLE FOR ANY SPECIAL, INDIRECT OR CONSEQUENTIAL DAMAGES OR ANY DAMAGES WHATSOEVER RESULTING FROM LOSS OF USE, DATA OR PROFITS, WHETHER IN AN ACTION OF CONTRACT, NEGLIGENCE OR OTHER TORTIOUS ACTION, ARISING OUT OF OR IN CONNECTION WITH THE USE OR PERFORMANCE OF THIS SOFTWARE.

Copyright 1997 Digital Equipment Corporation.

All rights reserved.

This software is furnished under license and may be used and copied only in accordance with the following terms and conditions. Subject to these conditions, you may download, copy, install, use, modify and distribute this software in source and/or binary form. No title or ownership is transferred hereby.

1) Any source code used, modified or distributed must reproduce and retain this copyright notice and list of conditions as they appear in the source file.

2) No right is granted to use any trade name, trademark, or logo of Digital Equipment Corporation. Neither the "Digital Equipment Corporation" name nor any trademark or logo of Digital Equipment Corporation may be used to endorse or promote products derived from this software without the prior written permission of Digital Equipment Corporation.

3) This software is provided "AS-IS" and any express or implied warranties, including but not limited to, any implied warranties of merchantability, fitness for a particular purpose, or non-infringement are disclaimed. In no event shall DIGITAL be liable for any damages whatsoever, and in particular, DIGITAL shall not be liable for special, indirect, consequential, or incidental damages or damages for lost profits, loss of revenue or loss of use, whether such damages arise in contract, negligence, tort, under statute, in equity, at law or otherwise, even if advised of the possibility of such damage.

Copyright 2001–2005 Red Hat Inc., Durham, North Carolina.

Copyright (c) 2003 by the XFree86 Project, Inc.

All Rights Reserved.

Permission is hereby granted, free of charge, to any person obtaining a copy of this software and associated documentation files (the "Software"), to deal in the Software without restriction, including without limitation on the rights to use, copy, modify, merge,

publish, distribute, sublicense, and/or sell copies of the Software,
and to permit persons to whom the Software is furnished to do so,
subject to the following conditions:

The above copyright notice and this permission notice (including the
next paragraph) shall be included in all copies or substantial
portions of the Software.

THE SOFTWARE IS PROVIDED "AS IS", WITHOUT WARRANTY OF ANY KIND,
EXPRESS OR IMPLIED, INCLUDING BUT NOT LIMITED TO THE WARRANTIES OF
MERCHANTABILITY, FITNESS FOR A PARTICULAR PURPOSE AND
NON-INFRINGEMENT. IN NO EVENT SHALL RED HAT AND/OR THEIR SUPPLIERS
BE LIABLE FOR ANY CLAIM, DAMAGES OR OTHER LIABILITY, WHETHER IN AN
ACTION OF CONTRACT, TORT OR OTHERWISE, ARISING FROM, OUT OF OR IN
CONNECTION WITH THE SOFTWARE OR THE USE OR OTHER DEALINGS IN THE
SOFTWARE.

Copyright © 2006 Red Hat, Inc.

(C) Copyright 1998–1999 Precision Insight, Inc., Cedar Park, Texas.

All Rights Reserved.

Permission is hereby granted, free of charge, to any person obtaining a copy of this software and associated documentation files (the "Software"), to deal in the Software without restriction, including without limitation the rights to use, copy, modify, merge, publish, distribute, sub license, and/or sell copies of the Software, and to permit persons to whom the Software is furnished to do so, subject to the following conditions:

The above copyright notice and this permission notice (including the next paragraph) shall be included in all copies or substantial portions of the Software.

THE SOFTWARE IS PROVIDED "AS IS", WITHOUT WARRANTY OF ANY KIND, EXPRESS OR IMPLIED, INCLUDING BUT NOT LIMITED TO THE WARRANTIES OF MERCHANTABILITY, FITNESS FOR A PARTICULAR PURPOSE AND NON–INFRINGEMENT. IN NO EVENT SHALL

RED HAT, INC, OR PRECISION INSIGHT AND/OR THEIR SUPPLIERS BE LIABLE FOR ANY

CLAIM, DAMAGES OR OTHER LIABILITY, WHETHER IN AN ACTION OF CONTRACT,
TORT
OR OTHERWISE, ARISING FROM, OUT OF OR IN CONNECTION WITH THE SOFTWARE
OR
THE USE OR OTHER DEALINGS IN THE SOFTWARE.

Copyright (c) 1995 X Consortium

Copyright 2004 Red Hat Inc., Durham, North Carolina.

All Rights Reserved.

Permission is hereby granted, free of charge, to any person obtaining
a copy of this software and associated documentation files (the
"Software"), to deal in the Software without restriction, including
without limitation on the rights to use, copy, modify, merge,
publish, distribute, sublicense, and/or sell copies of the Software,
and to permit persons to whom the Software is furnished to do so,
subject to the following conditions:

The above copyright notice and this permission notice shall be included in all copies or substantial portions of the Software.

THE SOFTWARE IS PROVIDED "AS IS", WITHOUT WARRANTY OF ANY KIND, EXPRESS OR IMPLIED, INCLUDING BUT NOT LIMITED TO THE WARRANTIES OF MERCHANTABILITY, FITNESS FOR A PARTICULAR PURPOSE AND NON-INFRINGEMENT. IN NO EVENT SHALL RED HAT, THE X CONSORTIUM, AND/OR THEIR SUPPLIERS BE LIABLE FOR ANY CLAIM, DAMAGES OR OTHER LIABILITY, WHETHER IN AN ACTION OF CONTRACT, TORT OR OTHERWISE, ARISING FROM, OUT OF OR IN CONNECTION WITH THE SOFTWARE OR THE USE OR OTHER DEALINGS IN THE SOFTWARE.

Except as contained in this notice, the name of the X Consortium shall not be used in advertising or otherwise to promote the sale, use or other dealings in this Software without prior written authorization from the X Consortium.

Copyright 1998–2000 Precision Insight, Inc., Cedar Park, Texas.

Copyright 2000 VA Linux Systems, Inc.

Copyright (c) 2002, 2008, 2009 Apple Computer, Inc.

Copyright (c) 2003–2004 Torrey T. Lyons.

All Rights Reserved.

Permission is hereby granted, free of charge, to any person obtaining a copy of this software and associated documentation files (the "Software"), to deal in the Software without restriction, including without limitation the rights to use, copy, modify, merge, publish, distribute, sub license, and/or sell copies of the Software, and to permit persons to whom the Software is furnished to do so, subject to the following conditions:

The above copyright notice and this permission notice (including the next paragraph) shall be included in all copies or substantial portions of the Software.

THE SOFTWARE IS PROVIDED "AS IS", WITHOUT WARRANTY OF ANY KIND, EXPRESS OR IMPLIED, INCLUDING BUT NOT LIMITED TO THE WARRANTIES OF

MERCHANTABILITY, FITNESS FOR A PARTICULAR PURPOSE AND NON-INFRINGEMENT.
IN NO EVENT SHALL PRECISION INSIGHT AND/OR ITS SUPPLIERS BE LIABLE FOR
ANY CLAIM, DAMAGES OR OTHER LIABILITY, WHETHER IN AN ACTION OF CONTRACT,
TORT OR OTHERWISE, ARISING FROM, OUT OF OR IN CONNECTION WITH THE
SOFTWARE OR THE USE OR OTHER DEALINGS IN THE SOFTWARE.

(C) Copyright IBM Corporation 2002 – 2007

All Rights Reserved.

Permission is hereby granted, free of charge, to any person obtaining a
copy of this software and associated documentation files (the "Software"),
to deal in the Software without restriction, including without limitation
the rights to use, copy, modify, merge, publish, distribute, sub license,
and/or sell copies of the Software, and to permit persons to whom the
Software is furnished to do so, subject to the following conditions:

The above copyright notice and this permission notice (including the next
paragraph) shall be included in all copies or substantial portions of the

Software.

THE SOFTWARE IS PROVIDED "AS IS", WITHOUT WARRANTY OF ANY KIND, EXPRESS OR IMPLIED, INCLUDING BUT NOT LIMITED TO THE WARRANTIES OF MERCHANTABILITY, FITNESS FOR A PARTICULAR PURPOSE AND NON-INFRINGEMENT. IN NO EVENT SHALL IBM, AND/OR THEIR SUPPLIERS BE LIABLE FOR ANY CLAIM, DAMAGES OR OTHER LIABILITY, WHETHER IN AN ACTION OF CONTRACT, TORT OR OTHERWISE, ARISING FROM, OUT OF OR IN CONNECTION WITH THE SOFTWARE OR THE USE OR OTHER DEALINGS IN THE SOFTWARE.

Copyright (c) 1997, 1998 Metro Link Incorporated

Permission is hereby granted, free of charge, to any person obtaining a copy of this software and associated documentation files (the "Software"), to deal in the Software without restriction, including without limitation

the rights to use, copy, modify, merge, publish, distribute, sublicense, and/or sell copies of the Software, and to permit persons to whom the Software is furnished to do so, subject to the following conditions:

The above copyright notice and this permission notice shall be included in all copies or substantial portions of the Software.

THE SOFTWARE IS PROVIDED "AS IS", WITHOUT WARRANTY OF ANY KIND, EXPRESS OR IMPLIED, INCLUDING BUT NOT LIMITED TO THE WARRANTIES OF MERCHANTABILITY, FITNESS FOR A PARTICULAR PURPOSE AND NONINFRINGEMENT. IN NO EVENT SHALL

THE X CONSORTIUM BE LIABLE FOR ANY CLAIM, DAMAGES OR OTHER LIABILITY, WHETHER IN AN ACTION OF CONTRACT, TORT OR OTHERWISE, ARISING FROM, OUT OF OR IN CONNECTION WITH THE SOFTWARE OR THE USE OR OTHER DEALINGS IN THE SOFTWARE.

Except as contained in this notice, the name of the Metro Link shall not be used in advertising or otherwise to promote the sale, use or other dealings

in this Software without prior written authorization from Metro Link.

Copyright 1995–1998 by Metro Link, Inc.

Copyright (c) 1997 Matthieu Herrb

Permission to use, copy, modify, distribute, and sell this software and its documentation for any purpose is hereby granted without fee, provided that the above copyright notice appear in all copies and that both that copyright notice and this permission notice appear in supporting documentation, and that the name of Metro Link, Inc. not be used in advertising or publicity pertaining to distribution of the software without specific, written prior permission. Metro Link, Inc. makes no representations about the suitability of this software for any purpose.

It is provided "as is" without express or implied warranty.

METRO LINK, INC. DISCLAIMS ALL WARRANTIES WITH REGARD TO THIS SOFTWARE, INCLUDING ALL IMPLIED WARRANTIES OF MERCHANTABILITY AND FITNESS, IN NO EVENT SHALL METRO LINK, INC. BE LIABLE FOR ANY SPECIAL, INDIRECT OR

CONSEQUENTIAL DAMAGES OR ANY DAMAGES WHATSOEVER RESULTING FROM LOSS OF USE, DATA OR PROFITS, WHETHER IN AN ACTION OF CONTRACT, NEGLIGENCE OR OTHER TORTIOUS ACTION, ARISING OUT OF OR IN CONNECTION WITH THE USE OR PERFORMANCE OF THIS SOFTWARE.

Copyright (c) 2000 by Conectiva S.A. (<http://www.conectiva.com>)

Permission is hereby granted, free of charge, to any person obtaining a copy of this software and associated documentation files (the "Software"), to deal in the Software without restriction, including without limitation the rights to use, copy, modify, merge, publish, distribute, sublicense, and/or sell copies of the Software, and to permit persons to whom the Software is furnished to do so, subject to the following conditions:

The above copyright notice and this permission notice shall be included in all copies or substantial portions of the Software.

THE SOFTWARE IS PROVIDED "AS IS", WITHOUT WARRANTY OF ANY KIND, EXPRESS OR IMPLIED, INCLUDING BUT NOT LIMITED TO THE WARRANTIES OF MERCHANTABILITY, FITNESS FOR A PARTICULAR PURPOSE AND NONINFRINGEMENT. IN NO EVENT SHALL CONECTIVA LINUX BE LIABLE FOR ANY CLAIM, DAMAGES OR OTHER LIABILITY, WHETHER IN AN ACTION OF CONTRACT, TORT OR OTHERWISE, ARISING FROM, OUT OF OR IN CONNECTION WITH THE SOFTWARE OR THE USE OR OTHER DEALINGS IN THE SOFTWARE.

Except as contained in this notice, the name of Conectiva Linux shall not be used in advertising or otherwise to promote the sale, use or other dealings in this Software without prior written authorization from Conectiva Linux.

Copyright (c) 2001, Andy Ritger aritger@nvidia.com

All rights reserved.

Redistribution and use in source and binary forms, with or without modification, are permitted provided that the following conditions are met:

- o Redistributions of source code must retain the above copyright notice, this list of conditions and the following disclaimer.
- o Redistributions in binary form must reproduce the above copyright notice, this list of conditions and the following disclaimer in the documentation and/or other materials provided with the distribution.
- o Neither the name of NVIDIA nor the names of its contributors may be used to endorse or promote products derived from this software without specific prior written permission.

THIS SOFTWARE IS PROVIDED BY THE COPYRIGHT HOLDERS AND CONTRIBUTORS "AS IS" AND ANY EXPRESS OR IMPLIED WARRANTIES, INCLUDING, BUT NOT LIMITED TO, THE IMPLIED WARRANTIES OF MERCHANTABILITY AND FITNESS FOR A PARTICULAR PURPOSE ARE DISCLAIMED. IN NO EVENT SHALL THE REGENTS OR CONTRIBUTORS BE LIABLE FOR ANY DIRECT, INDIRECT,

INCIDENTAL, SPECIAL, EXEMPLARY, OR CONSEQUENTIAL DAMAGES (INCLUDING, BUT NOT LIMITED TO, PROCUREMENT OF SUBSTITUTE GOODS OR SERVICES; LOSS OF USE, DATA, OR PROFITS; OR BUSINESS INTERRUPTION) HOWEVER CAUSED AND ON ANY THEORY OF LIABILITY, WHETHER IN CONTRACT, STRICT LIABILITY, OR TORT (INCLUDING NEGLIGENCE OR OTHERWISE) ARISING IN ANY WAY OUT OF THE USE OF THIS SOFTWARE, EVEN IF ADVISED OF THE POSSIBILITY OF SUCH DAMAGE.

Copyright 1992 Vrije Universiteit, The Netherlands

Permission to use, copy, modify, and distribute this software and its documentation for any purpose and without fee is hereby granted, provided that the above copyright notice appear in all copies and that both that copyright notice and this permission notice appear in supporting documentation, and that the name of the Vrije Universiteit not be used in advertising or publicity pertaining to distribution of the software without specific, written prior permission. The Vrije Universiteit makes no representations about the suitability of this software for any purpose.

It is provided "as is" without express or implied warranty.

The Vrije Universiteit DISCLAIMS ALL WARRANTIES WITH REGARD TO THIS SOFTWARE,

INCLUDING ALL IMPLIED WARRANTIES OF MERCHANTABILITY AND FITNESS, IN NO EVENT SHALL The Vrije Universiteit BE LIABLE FOR ANY SPECIAL, INDIRECT OR CONSEQUENTIAL DAMAGES OR ANY DAMAGES WHATSOEVER RESULTING FROM LOSS OF USE,

DATA OR PROFITS, WHETHER IN AN ACTION OF CONTRACT, NEGLIGENCE OR OTHER TORTIOUS ACTION, ARISING OUT OF OR IN CONNECTION WITH THE USE OR PERFORMANCE OF THIS SOFTWARE.

Copyright 1998 by Concurrent Computer Corporation

Permission to use, copy, modify, distribute, and sell this software and its documentation for any purpose is hereby granted without fee, provided that the above copyright notice appear in all copies and that both that copyright notice and this permission notice appear in

supporting documentation, and that the name of Concurrent Computer Corporation not be used in advertising or publicity pertaining to distribution of the software without specific, written prior permission. Concurrent Computer Corporation makes no representations about the suitability of this software for any purpose. It is provided "as is" without express or implied warranty.

CONCURRENT COMPUTER CORPORATION DISCLAIMS ALL WARRANTIES WITH REGARD TO THIS SOFTWARE, INCLUDING ALL IMPLIED WARRANTIES OF MERCHANTABILITY AND FITNESS, IN NO EVENT SHALL CONCURRENT COMPUTER CORPORATION BE LIABLE FOR ANY SPECIAL, INDIRECT OR CONSEQUENTIAL DAMAGES OR ANY DAMAGES WHATSOEVER RESULTING FROM LOSS OF USE, DATA OR PROFITS, WHETHER IN AN ACTION OF CONTRACT, NEGLIGENCE OR OTHER TORTIOUS ACTION, ARISING OUT OF OR IN CONNECTION WITH THE USE OR PERFORMANCE OF THIS SOFTWARE.

Copyright © 2004 Nokia

Permission to use, copy, modify, distribute, and sell this software and its documentation for any purpose is hereby granted without fee, provided that the above copyright notice appear in all copies and that both that copyright notice and this permission notice appear in supporting documentation, and that the name of Nokia not be used in advertising or publicity pertaining to distribution of the software without specific, written prior permission. Nokia makes no representations about the suitability of this software for any purpose. It is provided "as is" without express or implied warranty.

NOKIA DISCLAIMS ALL WARRANTIES WITH REGARD TO THIS SOFTWARE, INCLUDING ALL IMPLIED WARRANTIES OF MERCHANTABILITY AND FITNESS, IN NO EVENT SHALL NOKIA BE LIABLE FOR ANY SPECIAL, INDIRECT OR CONSEQUENTIAL DAMAGES OR ANY DAMAGES WHATSOEVER RESULTING FROM LOSS OF USE, DATA OR PROFITS, WHETHER IN AN ACTION OF CONTRACT, NEGLIGENCE OR OTHER TORTIOUS ACTION, ARISING OUT OF OR IN CONNECTION WITH THE USE OR PERFORMANCE OF THIS SOFTWARE.

(c)Copyright 1988,1991 Adobe Systems Incorporated.

All rights reserved.

Permission to use, copy, modify, distribute, and sublicense this software and its documentation for any purpose and without fee is hereby granted, provided that the above copyright notices appear in all copies and that both those copyright notices and this permission notice appear in supporting documentation and that the name of Adobe Systems Incorporated not be used in advertising or publicity pertaining to distribution of the software without specific, written prior permission. No trademark license to use the Adobe trademarks is hereby granted. If the Adobe trademark "Display PostScript"(tm) is used to describe this software, its functionality or for any other purpose, such use shall be limited to a statement that this software works in conjunction with the Display PostScript system. Proper trademark attribution to reflect Adobe's ownership of the trademark shall be given whenever any such reference to the Display PostScript system is made.

ADOBE MAKES NO REPRESENTATIONS ABOUT THE SUITABILITY OF THE SOFTWARE FOR ANY PURPOSE. IT IS PROVIDED "AS IS" WITHOUT EXPRESS OR IMPLIED WARRANTY. ADOBE DISCLAIMS ALL WARRANTIES WITH REGARD TO THIS SOFTWARE, INCLUDING ALL IMPLIED WARRANTIES OF MERCHANTABILITY, FITNESS FOR A PARTICULAR PURPOSE AND NON-INFRINGEMENT OF THIRD PARTY RIGHTS. IN NO EVENT SHALL ADOBE BE LIABLE TO YOU OR ANY OTHER PARTY FOR ANY SPECIAL, INDIRECT, OR CONSEQUENTIAL DAMAGES OR ANY DAMAGES WHATSOEVER WHETHER IN AN ACTION OF CONTRACT, NEGLIGENCE, STRICT LIABILITY OR ANY OTHER ACTION ARISING OUT OF OR IN CONNECTION WITH THE USE OR PERFORMANCE OF THIS SOFTWARE. ADOBE WILL NOT PROVIDE ANY TRAINING OR OTHER SUPPORT FOR THE SOFTWARE.

Adobe, PostScript, and Display PostScript are trademarks of Adobe Systems Incorporated which may be registered in certain jurisdictions.

Copyright 1989 Network Computing Devices, Inc., Mountain View, California.

Permission to use, copy, modify, and distribute this software and its documentation for any purpose and without fee is hereby granted, provided that the above copyright notice appear in all copies and that both that copyright notice and this permission notice appear in supporting documentation, and that the name of N.C.D. not be used in advertising or publicity pertaining to distribution of the software without specific, written prior permission. N.C.D. makes no representations about the suitability of this software for any purpose. It is provided "as is" without express or implied warranty.

Copyright 1992, 1993 Data General Corporation;

Copyright 1992, 1993 OMRON Corporation

Permission to use, copy, modify, distribute, and sell this software and its documentation for any purpose is hereby granted without fee, provided that the above copyright notice appear in all copies and that both that copyright notice and this permission notice appear in supporting documentation, and that neither the name OMRON or DATA GENERAL be used in advertising or publicity pertaining to distribution of the software without specific, written prior permission of the party whose name is to be used. Neither OMRON or DATA GENERAL make any representation about the suitability of this software for any purpose. It is provided "as is" without express or implied warranty.

OMRON AND DATA GENERAL EACH DISCLAIM ALL WARRANTIES WITH REGARD TO THIS SOFTWARE, INCLUDING ALL IMPLIED WARRANTIES OF MERCHANTABILITY AND FITNESS, IN NO EVENT SHALL OMRON OR DATA GENERAL BE LIABLE FOR ANY SPECIAL, INDIRECT

OR CONSEQUENTIAL DAMAGES OR ANY DAMAGES WHATSOEVER RESULTING FROM
LOSS OF USE,
DATA OR PROFITS, WHETHER IN AN ACTION OF CONTRACT, NEGLIGENCE OR OTHER
TORTIOUS ACTION, ARISING OUT OF OR IN CONNECTION WITH THE USE OR
PERFORMANCE
OF THIS SOFTWARE.

Copyright © 1998–2004, 2006 Keith Packard

Copyright © 2000–2002 Keith Packard, member of The XFree86 Project, Inc.

Copyright (c) 2002 Apple Computer, Inc.

Copyright (c) 2003 Torrey T. Lyons.

All Rights Reserved.

Permission to use, copy, modify, distribute, and sell this software and its
documentation for any purpose is hereby granted without fee, provided that
the above copyright notice appear in all copies and that both that
copyright notice and this permission notice appear in supporting
documentation, and that the name of Keith Packard not be used in

advertising or publicity pertaining to distribution of the software without specific, written prior permission. Keith Packard makes no representations about the suitability of this software for any purpose. It is provided "as is" without express or implied warranty.

KEITH PACKARD DISCLAIMS ALL WARRANTIES WITH REGARD TO THIS SOFTWARE, INCLUDING ALL IMPLIED WARRANTIES OF MERCHANTABILITY AND FITNESS, IN NO EVENT SHALL KEITH PACKARD BE LIABLE FOR ANY SPECIAL, INDIRECT OR CONSEQUENTIAL DAMAGES OR ANY DAMAGES WHATSOEVER RESULTING FROM LOSS OF USE, DATA OR PROFITS, WHETHER IN AN ACTION OF CONTRACT, NEGLIGENCE OR OTHER TORTIOUS ACTION, ARISING OUT OF OR IN CONNECTION WITH THE USE OR PERFORMANCE OF THIS SOFTWARE.

Copyright © 1999 Keith Packard

Copyright © 2000 Compaq Computer Corporation

Copyright © 2002 MontaVista Software Inc.

Copyright © 2005 OpenedHand Ltd.

Copyright © 2006 Nokia Corporation

Permission to use, copy, modify, distribute, and sell this software and its documentation for any purpose is hereby granted without fee, provided that the above copyright notice appear in all copies and that both that copyright notice and this permission notice appear in supporting documentation, and that the name of the authors and/or copyright holders not be used in advertising or publicity pertaining to distribution of the software without specific, written prior permission. The authors and/or copyright holders make no representations about the suitability of this software for any purpose. It is provided "as is" without express or implied warranty.

THE AUTHORS AND/OR COPYRIGHT HOLDERS DISCLAIM ALL WARRANTIES WITH REGARD

TO THIS SOFTWARE, INCLUDING ALL IMPLIED WARRANTIES OF MERCHANTABILITY AND FITNESS, IN NO EVENT SHALL THE AUTHORS AND/OR COPYRIGHT HOLDERS BE LIABLE FOR ANY SPECIAL, INDIRECT OR CONSEQUENTIAL DAMAGES OR ANY DAMAGES

WHATSOEVER RESULTING FROM LOSS OF USE, DATA OR PROFITS, WHETHER IN AN ACTION OF CONTRACT, NEGLIGENCE OR OTHER TORTIOUS ACTION, ARISING OUT OF OR IN CONNECTION WITH THE USE OR PERFORMANCE OF THIS SOFTWARE.

Copyright 1993 by Davor Matic

Permission to use, copy, modify, distribute, and sell this software and its documentation for any purpose is hereby granted without fee, provided that the above copyright notice appear in all copies and that both that copyright notice and this permission notice appear in supporting documentation. Davor Matic makes no representations about the suitability of this software for any purpose. It is provided "as is" without express or implied warranty.

Copyright (C) 2001–2004 Harold L Hunt II All Rights Reserved.

Copyright (C) Colin Harrison 2005–2008

Permission is hereby granted, free of charge, to any person obtaining a copy of this software and associated documentation files (the "Software"), to deal in the Software without restriction, including without limitation the rights to use, copy, modify, merge, publish, distribute, sublicense, and/or sell copies of the Software, and to permit persons to whom the Software is furnished to do so, subject to the following conditions:

The above copyright notice and this permission notice shall be included in all copies or substantial portions of the Software.

THE SOFTWARE IS PROVIDED "AS IS", WITHOUT WARRANTY OF ANY KIND, EXPRESS OR IMPLIED, INCLUDING BUT NOT LIMITED TO THE WARRANTIES OF MERCHANTABILITY, FITNESS FOR A PARTICULAR PURPOSE AND NONINFRINGEMENT. IN NO EVENT SHALL HAROLD L HUNT II BE LIABLE FOR ANY CLAIM, DAMAGES OR OTHER LIABILITY, WHETHER IN AN ACTION OF CONTRACT, TORT OR OTHERWISE, ARISING FROM, OUT OF OR IN CONNECTION WITH THE SOFTWARE OR THE USE OR OTHER DEALINGS IN THE SOFTWARE.

Except as contained in this notice, the name of Harold L Hunt II shall not be used in advertising or otherwise to promote the sale, use or other dealings in this Software without prior written authorization from Harold L Hunt II.

Copyright 1990,91 by Thomas Roell, Dinkelscherben, Germany.

Permission to use, copy, modify, distribute, and sell this software and its documentation for any purpose is hereby granted without fee, provided that the above copyright notice appear in all copies and that both that copyright notice and this permission notice appear in supporting documentation, and that the name of Thomas Roell not be used in advertising or publicity pertaining to distribution of the software without specific, written prior permission. Thomas Roell makes no representations about the suitability of this software for any purpose. It is provided "as is" without express or implied warranty.

THOMAS ROELL DISCLAIMS ALL WARRANTIES WITH REGARD TO THIS SOFTWARE, INCLUDING ALL IMPLIED WARRANTIES OF MERCHANTABILITY AND FITNESS, IN NO EVENT SHALL THOMAS ROELL BE LIABLE FOR ANY SPECIAL, INDIRECT OR CONSEQUENTIAL DAMAGES OR ANY DAMAGES WHATSOEVER RESULTING FROM LOSS OF USE, DATA OR PROFITS, WHETHER IN AN ACTION OF CONTRACT, NEGLIGENCE OR OTHER TORTIOUS ACTION, ARISING OUT OF OR IN CONNECTION WITH THE USE OR PERFORMANCE OF THIS SOFTWARE.

Copyright 1990,91 by Thomas Roell, Dinkelscherben, Germany

Copyright 1993 by David Wexelblat <dwex@goblin.org>

Permission to use, copy, modify, distribute, and sell this software and its documentation for any purpose is hereby granted without fee, provided that the above copyright notice appear in all copies and that both that copyright notice and this permission notice appear in supporting documentation, and that the names of Thomas Roell and David Wexelblat not be used in advertising or publicity pertaining to distribution of

the software without specific, written prior permission. Thomas Roell and David Wexelblat makes no representations about the suitability of this software for any purpose. It is provided "as is" without express or implied warranty.

THOMAS ROELL AND DAVID WEXELBLAT DISCLAIMS ALL WARRANTIES WITH REGARD TO THIS SOFTWARE, INCLUDING ALL IMPLIED WARRANTIES OF MERCHANTABILITY AND FITNESS, IN NO EVENT SHALL THOMAS ROELL OR DAVID WEXELBLAT BE LIABLE FOR ANY SPECIAL, INDIRECT OR CONSEQUENTIAL DAMAGES OR ANY DAMAGES WHATSOEVER RESULTING FROM LOSS OF USE, DATA OR PROFITS, WHETHER IN AN ACTION OF CONTRACT, NEGLIGENCE OR OTHER TORTIOUS ACTION, ARISING OUT OF OR IN CONNECTION WITH THE USE OR PERFORMANCE OF THIS SOFTWARE.

Copyright 1990,91,92,93 by Thomas Roell, Germany.

Copyright 1991,92,93 by SGCS (Snitily Graphics Consulting Services), USA.

Permission to use, copy, modify, distribute, and sell this software and its documentation for any purpose is hereby granted without fee, provided that the above copyright notice appear in all copies and that both that copyright notice and this permission notice appear in supporting documentation, and that the name of Thomas Roell nor SGCS be used in advertising or publicity pertaining to distribution of the software without specific, written prior permission.

Thomas Roell nor SGCS makes no representations about the suitability of this software for any purpose. It is provided "as is" without express or implied warranty.

THOMAS ROELL AND SGCS DISCLAIMS ALL WARRANTIES WITH REGARD TO THIS SOFTWARE, INCLUDING ALL IMPLIED WARRANTIES OF MERCHANTABILITY AND FITNESS, IN NO EVENT SHALL THOMAS ROELL OR SGCS BE LIABLE FOR ANY SPECIAL, INDIRECT OR CONSEQUENTIAL DAMAGES OR ANY DAMAGES WHATSOEVER RESULTING FROM LOSS OF USE, DATA OR PROFITS, WHETHER IN AN ACTION OF CONTRACT, NEGLIGENCE OR OTHER TORTIOUS ACTION, ARISING OUT OF OR IN CONNECTION WITH THE USE OR PERFORMANCE OF THIS SOFTWARE.

Copyright 1998 by Alan Hourihane, Wigan, England.

Copyright 2000–2002 by Alan Hourihane, Flint Mountain, North Wales.

Permission to use, copy, modify, distribute, and sell this software and its documentation for any purpose is hereby granted without fee, provided that the above copyright notice appear in all copies and that both that copyright notice and this permission notice appear in supporting documentation, and that the name of Alan Hourihane not be used in advertising or publicity pertaining to distribution of the software without specific, written prior permission. Alan Hourihane makes no representations about the suitability of this software for any purpose. It is provided "as is" without express or implied warranty.

ALAN HOURIHANE DISCLAIMS ALL WARRANTIES WITH REGARD TO THIS SOFTWARE, INCLUDING ALL IMPLIED WARRANTIES OF MERCHANTABILITY AND FITNESS, IN NO EVENT SHALL ALAN HOURIHANE BE LIABLE FOR ANY SPECIAL, INDIRECT OR CONSEQUENTIAL DAMAGES OR ANY DAMAGES WHATSOEVER RESULTING FROM LOSS OF USE,

DATA OR PROFITS, WHETHER IN AN ACTION OF CONTRACT, NEGLIGENCE OR OTHER TORTIOUS ACTION, ARISING OUT OF OR IN CONNECTION WITH THE USE OR PERFORMANCE OF THIS SOFTWARE.

Copyright 1995 Kaleb S. KEITHLEY

Permission is hereby granted, free of charge, to any person obtaining a copy of this software and associated documentation files (the "Software"), to deal in the Software without restriction, including without limitation the rights to use, copy, modify, merge, publish, distribute, sublicense, and/or sell copies of the Software, and to permit persons to whom the Software is furnished to do so, subject to the following conditions:

The above copyright notice and this permission notice shall be included in all copies or substantial portions of the Software.

THE SOFTWARE IS PROVIDED "AS IS", WITHOUT WARRANTY OF ANY KIND,

EXPRESS OR IMPLIED, INCLUDING BUT NOT LIMITED TO THE WARRANTIES OF MERCHANTABILITY, FITNESS FOR A PARTICULAR PURPOSE AND NONINFRINGEMENT. IN NO EVENT SHALL Kaleb S. KEITHLEY BE LIABLE FOR ANY CLAIM, DAMAGES OR OTHER LIABILITY, WHETHER IN AN ACTION OF CONTRACT, TORT OR OTHERWISE, ARISING FROM, OUT OF OR IN CONNECTION WITH THE SOFTWARE OR THE USE OR OTHER DEALINGS IN THE SOFTWARE.

Except as contained in this notice, the name of Kaleb S. KEITHLEY shall not be used in advertising or otherwise to promote the sale, use or other dealings in this Software without prior written authorization from Kaleb S. KEITHLEY

Copyright (c) 1997 Matthieu Herrb

Permission to use, copy, modify, distribute, and sell this software and its documentation for any purpose is hereby granted without fee, provided that the above copyright notice appear in all copies and that both that copyright notice and this permission notice appear in supporting

documentation, and that the name of Matthieu Herrb not be used in advertising or publicity pertaining to distribution of the software without specific, written prior permission. Matthieu Herrb makes no representations about the suitability of this software for any purpose.

It is provided "as is" without express or implied warranty.

MATTHIEU HERRB DISCLAIMS ALL WARRANTIES WITH REGARD TO THIS SOFTWARE, INCLUDING ALL IMPLIED WARRANTIES OF MERCHANTABILITY AND FITNESS, IN NO EVENT SHALL MATTHIEU HERRB BE LIABLE FOR ANY SPECIAL, INDIRECT OR CONSEQUENTIAL DAMAGES OR ANY DAMAGES WHATSOEVER RESULTING FROM LOSS OF USE, DATA OR PROFITS, WHETHER IN AN ACTION OF CONTRACT, NEGLIGENCE OR OTHER TORTIOUS ACTION, ARISING OUT OF OR IN CONNECTION WITH THE USE OR PERFORMANCE OF THIS SOFTWARE.

Copyright 2004, Egbert Eich

Permission is hereby granted, free of charge, to any person obtaining a copy

of this software and associated documentation files (the "Software"), to deal in the Software without restriction, including without limitation the rights to use, copy, modify, merge, publish, distribute, sublicense, and/or sell copies of the Software, and to permit persons to whom the Software is furnished to do so, subject to the following conditions:

The above copyright notice and this permission notice shall be included in all copies or substantial portions of the Software.

THE SOFTWARE IS PROVIDED "AS IS", WITHOUT WARRANTY OF ANY KIND, EXPRESS OR IMPLIED, INCLUDING BUT NOT LIMITED TO THE WARRANTIES OF MERCHANTABILITY, FITNESS FOR A PARTICULAR PURPOSE AND NONINFRINGEMENT. IN NO EVENT SHALL

EGBERT EICH BE LIABLE FOR ANY CLAIM, DAMAGES OR OTHER LIABILITY, WHETHER IN AN ACTION OF CONTRACT, TORT OR OTHERWISE, ARISING FROM, OUT OF OR IN CONNECTION WITH THE SOFTWARE OR THE USE OR OTHER DEALINGS IN THE SOFTWARE.

CON-

Except as contained in this notice, the name of Egbert Eich shall not

be used in advertising or otherwise to promote the sale, use or other dealings in this Software without prior written authorization from Egbert Eich.

Copyright 1993 by David Wexelblat <dwex@goblin.org>

Copyright 2005 by Kean Johnston <jkj@sco.com>

Copyright 1993 by David McCullough <davidm@stallion.oz.au>

Permission to use, copy, modify, distribute, and sell this software and its documentation for any purpose is hereby granted without fee, provided that the above copyright notice appear in all copies and that both that copyright notice and this permission notice appear in supporting documentation, and that the name of David Wexelblat not be used in advertising or publicity pertaining to distribution of the software without specific, written prior permission. David Wexelblat makes no representations about the suitability of this software for any purpose. It is provided "as is" without express or implied warranty.

DAVID WEXELBLAT DISCLAIMS ALL WARRANTIES WITH REGARD TO THIS SOFTWARE,

INCLUDING ALL IMPLIED WARRANTIES OF MERCHANTABILITY AND FITNESS, IN NO EVENT SHALL DAVID WEXELBLAT BE LIABLE FOR ANY SPECIAL, INDIRECT OR CONSEQUENTIAL DAMAGES OR ANY DAMAGES WHATSOEVER RESULTING FROM LOSS OF USE, DATA OR PROFITS, WHETHER IN AN ACTION OF CONTRACT, NEGLIGENCE OR OTHER TORTIOUS ACTION, ARISING OUT OF OR IN CONNECTION WITH THE USE OR PERFORMANCE OF THIS SOFTWARE.

Copyright 1992 by Orest Zborowski <obz@Kodak.com>

Copyright 1993 by David Wexelblat <dwex@goblin.org>

Permission to use, copy, modify, distribute, and sell this software and its documentation for any purpose is hereby granted without fee, provided that the above copyright notice appear in all copies and that both that copyright notice and this permission notice appear in supporting documentation, and that the names of Orest Zborowski and David Wexelblat not be used in advertising or publicity pertaining to distribution of the software without specific, written prior permission. Orest Zborowski

and David Wexelblat make no representations about the suitability of this software for any purpose. It is provided "as is" without express or implied warranty.

OREST ZBOROWSKI AND DAVID WEXELBLAT DISCLAIMS ALL WARRANTIES WITH REGARD TO THIS SOFTWARE, INCLUDING ALL IMPLIED WARRANTIES OF MERCHANTABILITY AND FITNESS, IN NO EVENT SHALL OREST ZBOROWSKI OR DAVID WEXELBLAT BE LIABLE FOR ANY SPECIAL, INDIRECT OR CONSEQUENTIAL DAMAGES OR ANY DAMAGES WHATSOEVER RESULTING FROM LOSS OF USE, DATA OR PROFITS, WHETHER IN AN ACTION OF CONTRACT, NEGLIGENCE OR OTHER TORTIOUS ACTION, ARISING OUT OF OR IN CONNECTION WITH THE USE OR PERFORMANCE OF THIS SOFTWARE.

Copyright 1995-1999 by Frederic Lepied, France. <fred@sugix.frmug.fr.net>

Permission to use, copy, modify, distribute, and sell this software and its

documentation for any purpose is hereby granted without fee, provided that the above copyright notice appear in all copies and that both that copyright notice and this permission notice appear in supporting documentation, and that the name of Frederic Lepied not be used in advertising or publicity pertaining to distribution of the software without specific, written prior permission. Frederic Lepied makes no representations about the suitability of this software for any purpose. It is provided "as is" without express or implied warranty.

FREDERIC LEPIED DISCLAIMS ALL WARRANTIES WITH REGARD TO THIS SOFTWARE,
INCLUDING ALL IMPLIED WARRANTIES OF MERCHANTABILITY AND FITNESS, IN NO EVENT SHALL FREDERIC LEPIED BE LIABLE FOR ANY SPECIAL, INDIRECT OR CONSEQUENTIAL DAMAGES OR ANY DAMAGES WHATSOEVER RESULTING FROM LOSS OF USE, DATA OR PROFITS, WHETHER IN AN ACTION OF CONTRACT, NEGLIGENCE OR OTHER

TORTIOUS ACTION, ARISING OUT OF OR IN CONNECTION WITH THE USE
OR
PERFORMANCE OF THIS SOFTWARE.

Copyright 1992 by Rich Murphey <Rich@Rice.edu>

Copyright 1993 by David Wexelblat <dwex@goblin.org>

Permission to use, copy, modify, distribute, and sell this software and its documentation for any purpose is hereby granted without fee, provided that the above copyright notice appear in all copies and that both that copyright notice and this permission notice appear in supporting documentation, and that the names of Rich Murphey and David Wexelblat not be used in advertising or publicity pertaining to distribution of the software without specific, written prior permission. Rich Murphey and David Wexelblat make no representations about the suitability of this software for any purpose. It is provided "as is" without express or implied warranty.

RICH MURPHEY AND DAVID WEXELBLAT DISCLAIM ALL WARRANTIES WITH REGARD TO THIS SOFTWARE, INCLUDING ALL IMPLIED WARRANTIES OF MERCHANTABILITY AND FITNESS, IN NO EVENT SHALL RICH MURPHEY OR DAVID WEXELBLAT BE LIABLE FOR ANY SPECIAL, INDIRECT OR CONSEQUENTIAL DAMAGES OR ANY DAMAGES WHATSOEVER RESULTING FROM LOSS OF USE, DATA OR PROFITS, WHETHER IN AN ACTION OF CONTRACT, NEGLIGENCE OR OTHER TORTIOUS ACTION, ARISING OUT OF OR IN CONNECTION WITH THE USE OR PERFORMANCE OF THIS SOFTWARE.

Copyright © 2003–2004 Anders Carlsson

Permission to use, copy, modify, distribute, and sell this software and its documentation for any purpose is hereby granted without fee, provided that the above copyright notice appear in all copies and that both that copyright notice and this permission notice appear in supporting documentation, and that the name of Anders Carlsson not be used in advertising or publicity pertaining to distribution of the software without

specific, written prior permission. Anders Carlsson makes no representations about the suitability of this software for any purpose. It is provided "as is" without express or implied warranty.

ANDERS CARLSSON DISCLAIMS ALL WARRANTIES WITH REGARD TO THIS SOFTWARE, INCLUDING ALL IMPLIED WARRANTIES OF MERCHANTABILITY AND FITNESS, IN NO EVENT SHALL ANDERS CARLSSON BE LIABLE FOR ANY SPECIAL, INDIRECT OR CONSEQUENTIAL DAMAGES OR ANY DAMAGES WHATSOEVER RESULTING FROM LOSS OF USE, DATA OR PROFITS, WHETHER IN AN ACTION OF CONTRACT, NEGLIGENCE OR OTHER TORTIOUS ACTION, ARISING OUT OF OR IN CONNECTION WITH THE USE OR PERFORMANCE OF THIS SOFTWARE.

Copyright (C) 2003 Anders Carlsson

Copyright © 2003–2004 Eric Anholt

Copyright © 2004 Keith Packard

Permission to use, copy, modify, distribute, and sell this software and its

documentation for any purpose is hereby granted without fee, provided that the above copyright notice appear in all copies and that both that copyright notice and this permission notice appear in supporting documentation, and that the name of Eric Anholt not be used in advertising or publicity pertaining to distribution of the software without specific, written prior permission. Eric Anholt makes no representations about the suitability of this software for any purpose. It is provided "as is" without express or implied warranty.

ERIC ANHOLT DISCLAIMS ALL WARRANTIES WITH REGARD TO THIS SOFTWARE, INCLUDING ALL IMPLIED WARRANTIES OF MERCHANTABILITY AND FITNESS, IN NO EVENT SHALL ERIC ANHOLT BE LIABLE FOR ANY SPECIAL, INDIRECT OR CONSEQUENTIAL DAMAGES OR ANY DAMAGES WHATSOEVER RESULTING FROM LOSS OF USE, DATA OR PROFITS, WHETHER IN AN ACTION OF CONTRACT, NEGLIGENCE OR OTHER TORTIOUS ACTION, ARISING OUT OF OR IN CONNECTION WITH THE USE OR PERFORMANCE OF THIS SOFTWARE.

Copyright (c) 1998 Todd C. Miller <Todd.Miller@courtesan.com>

Permission to use, copy, modify, and distribute this software for any purpose with or without fee is hereby granted, provided that the above copyright notice and this permission notice appear in all copies.

THE SOFTWARE IS PROVIDED "AS IS" AND TODD C. MILLER DISCLAIMS ALL WARRANTIES WITH REGARD TO THIS SOFTWARE INCLUDING ALL IMPLIED WARRANTIES OF MERCHANTABILITY AND FITNESS. IN NO EVENT SHALL TODD C. MILLER BE LIABLE FOR ANY SPECIAL, DIRECT, INDIRECT, OR CONSEQUENTIAL DAMAGES OR ANY DAMAGES WHATSOEVER RESULTING FROM LOSS OF USE, DATA OR PROFITS, WHETHER IN AN ACTION OF CONTRACT, NEGLIGENCE OR OTHER TORTIOUS ACTION, ARISING OUT OF OR IN CONNECTION WITH THE USE OR PERFORMANCE OF THIS SOFTWARE.

Copyright © 2003–2004 Philip Blundell

Permission to use, copy, modify, distribute, and sell this software and its documentation for any purpose is hereby granted without fee, provided that the above copyright notice appear in all copies and that both that copyright notice and this permission notice appear in supporting documentation, and that the name of Philip Blundell not be used in advertising or publicity pertaining to distribution of the software without specific, written prior permission. Philip Blundell makes no representations about the suitability of this software for any purpose. It is provided "as is" without express or implied warranty.

PHILIP BLUNDELL DISCLAIMS ALL WARRANTIES WITH REGARD TO THIS SOFTWARE, INCLUDING ALL IMPLIED WARRANTIES OF MERCHANTABILITY AND FITNESS, IN NO EVENT SHALL PHILIP BLUNDELL BE LIABLE FOR ANY SPECIAL, INDIRECT OR CONSEQUENTIAL DAMAGES OR ANY DAMAGES WHATSOEVER RESULTING FROM LOSS OF USE, DATA OR PROFITS, WHETHER IN AN ACTION OF CONTRACT, NEGLIGENCE OR OTHER TORTIOUS ACTION, ARISING OUT OF OR IN CONNECTION WITH THE USE OR PERFORMANCE OF THIS SOFTWARE.

Copyright (c) 1994–2003 by The XFree86 Project, Inc.

Copyright 1997 by Metro Link, Inc.

Copyright 2003 by David H. Dawes.

Copyright 2003 by X–Oz Technologies.

Copyright (c) 2004, X.Org Foundation

Permission is hereby granted, free of charge, to any person obtaining a copy of this software and associated documentation files (the "Software"), to deal in the Software without restriction, including without limitation the rights to use, copy, modify, merge, publish, distribute, sublicense, and/or sell copies of the Software, and to permit persons to whom the Software is furnished to do so, subject to the following conditions:

The above copyright notice and this permission notice shall be included in all copies or substantial portions of the Software.

THE SOFTWARE IS PROVIDED "AS IS", WITHOUT WARRANTY OF ANY KIND, EXPRESS OR IMPLIED, INCLUDING BUT NOT LIMITED TO THE WARRANTIES OF MERCHANTABILITY, FITNESS FOR A PARTICULAR PURPOSE AND NONINFRINGEMENT. IN NO EVENT SHALL

THE COPYRIGHT HOLDER(S) OR AUTHOR(S) BE LIABLE FOR ANY CLAIM, DAMAGES OR OTHER LIABILITY, WHETHER IN AN ACTION OF CONTRACT, TORT OR OTHERWISE, ARISING FROM, OUT OF OR IN CONNECTION WITH THE SOFTWARE OR THE USE OR OTHER DEALINGS IN THE SOFTWARE.

Except as contained in this notice, the name of the copyright holder(s) and author(s) shall not be used in advertising or otherwise to promote the sale, use or other dealings in this Software without prior written authorization from the copyright holder(s) and author(s).

Copyright 1990,91 by Thomas Roell, Dinkelscherben, Germany

Copyright 1993 by David Wexelblat <dwex@goblin.org>

Copyright 1999 by David Holland <davidh@iquest.net>

Copyright © 2000 Compaq Computer Corporation

Copyright © 2002 Hewlett-Packard Company

Copyright © 2004, 2005, 2008 Red Hat, Inc.

Copyright © 2004 Nicholas Miell

Copyright © 2005 Trolltech AS

Copyright © 2006 Intel Corporation

Copyright © 2004 – 2007 Keith Packard

Copyright © 2008 George Sapountzis <gsap7@yahoo.gr>

Permission to use, copy, modify, distribute, and sell this software and its documentation for any purpose is hereby granted without fee, provided that the above copyright notice appear in all copies and that both that copyright notice and this permission notice appear in supporting documentation, and that the name of the copyright holders not be used in advertising or publicity pertaining to distribution of the software without specific, written prior permission. The copyright holders make no representations about the suitability of this software for any purpose. It is provided "as is" without express or implied warranty.

THE COPYRIGHT HOLDERS DISCLAIM ALL WARRANTIES WITH REGARD TO THIS

SOFTWARE, INCLUDING ALL IMPLIED WARRANTIES OF MERCHANTABILITY AND FITNESS, IN NO EVENT SHALL THE COPYRIGHT HOLDERS BE LIABLE FOR ANY SPECIAL, INDIRECT OR CONSEQUENTIAL DAMAGES OR ANY DAMAGES WHATSOEVER RESULTING FROM LOSS OF USE, DATA OR PROFITS, WHETHER IN AN ACTION OF CONTRACT, NEGLIGENCE OR OTHER TORTIOUS ACTION, ARISING OUT OF OR IN CONNECTION WITH THE USE OR PERFORMANCE OF THIS SOFTWARE.

Copyright © 2000 Keith Packard, member of The XFree86 Project, Inc.

2005 Lars Knoll & Zack Rusin, Trolltech

Permission to use, copy, modify, distribute, and sell this software and its documentation for any purpose is hereby granted without fee, provided that the above copyright notice appear in all copies and that both that copyright notice and this permission notice appear in supporting documentation, and that the name of Keith Packard not be used in advertising or publicity pertaining to distribution of the software without specific, written prior permission. Keith Packard makes no

representations about the suitability of this software for any purpose. It is provided "as is" without express or implied warranty.

THE COPYRIGHT HOLDERS DISCLAIM ALL WARRANTIES WITH REGARD TO THIS SOFTWARE, INCLUDING ALL IMPLIED WARRANTIES OF MERCHANTABILITY AND FITNESS, IN NO EVENT SHALL THE COPYRIGHT HOLDERS BE LIABLE FOR ANY SPECIAL, INDIRECT OR CONSEQUENTIAL DAMAGES OR ANY DAMAGES WHATSOEVER RESULTING FROM LOSS OF USE, DATA OR PROFITS, WHETHER IN AN ACTION OF CONTRACT, NEGLIGENCE OR OTHER TORTIOUS ACTION, ARISING OUT OF OR IN CONNECTION WITH THE USE OR PERFORMANCE OF THIS SOFTWARE.

Copyright 1987, 1998 The Open Group

Copyright © 1998–1999, 2001 The XFree86 Project, Inc.

Copyright © 2000 VA Linux Systems, Inc.

Copyright (c) 2000, 2001 Nokia Home Communications

Copyright © 2007, 2008 Red Hat, Inc.

All rights reserved.

Permission is hereby granted, free of charge, to any person obtaining a copy of this software and associated documentation files (the "Software"), to deal in the Software without restriction, including without limitation the rights to use, copy, modify, merge, publish, distribute, and/or sell copies of the Software, and to permit persons to whom the Software is furnished to do so, provided that the above copyright notice(s) and this permission notice appear in all copies of the Software and that both the above copyright notice(s) and this permission notice appear in supporting documentation.

THE SOFTWARE IS PROVIDED "AS IS", WITHOUT WARRANTY OF ANY KIND, EXPRESS OR IMPLIED, INCLUDING BUT NOT LIMITED TO THE WARRANTIES OF MERCHANTABILITY, FITNESS FOR A PARTICULAR PURPOSE AND NONINFRINGEMENT OF THIRD PARTY RIGHTS. IN NO EVENT SHALL THE COPYRIGHT HOLDER OR HOLDERS INCLUDED IN THIS NOTICE BE LIABLE FOR ANY CLAIM, OR ANY SPECIAL INDIRECT OR CONSEQUENTIAL DAMAGES, OR ANY DAMAGES WHATSOEVER RESULTING FROM LOSS OF USE, DATA OR PROFITS, WHETHER IN AN ACTION OF CONTRACT,

NEGLIGENCE OR OTHER TORTIOUS ACTION, ARISING OUT OF OR IN CONNECTION WITH THE USE OR PERFORMANCE OF THIS SOFTWARE.

Except as contained in this notice, the name of a copyright holder shall not be used in advertising or otherwise to promote the sale, use or other dealings in this Software without prior written authorization of the copyright holder.

Copyright 1996 by Thomas E. Dickey <dickey@clark.net>

All Rights Reserved

Permission to use, copy, modify, and distribute this software and its documentation for any purpose and without fee is hereby granted, provided that the above copyright notice appear in all copies and that both that copyright notice and this permission notice appear in supporting documentation, and that the name of the above listed copyright holder(s) not be used in advertising or publicity pertaining

to distribution of the software without specific, written prior permission.

THE ABOVE LISTED COPYRIGHT HOLDER(S) DISCLAIM ALL WARRANTIES WITH REGARD TO THIS SOFTWARE, INCLUDING ALL IMPLIED WARRANTIES OF MERCHANTABILITY AND FITNESS, IN NO EVENT SHALL THE ABOVE LISTED COPYRIGHT HOLDER(S) BE LIABLE FOR ANY SPECIAL, INDIRECT OR CONSEQUENTIAL DAMAGES OR ANY DAMAGES

WHATSOEVER RESULTING FROM LOSS OF USE, DATA OR PROFITS, WHETHER IN AN ACTION OF CONTRACT, NEGLIGENCE OR OTHER TORTIOUS ACTION, ARISING OUT OF OR IN CONNECTION WITH THE USE OR PERFORMANCE OF THIS SOFTWARE.

Copyright 1998-1999 Precision Insight, Inc., Cedar Park, Texas.

Copyright (c) 2001 Andreas Monitzer.

Copyright (c) 2001-2004 Greg Parker.

Copyright (c) 2001-2004 Torrey T. Lyons

Copyright (c) 2002-2003 Apple Computer, Inc.

Copyright (c) 2004–2005 Alexander Gottwald

Copyright (c) 2002–2009 Apple Inc.

Copyright (c) 2007 Jeremy Huddleston

All Rights Reserved.

Permission is hereby granted, free of charge, to any person obtaining a copy of this software and associated documentation files (the "Software"), to deal in the Software without restriction, including without limitation the rights to use, copy, modify, merge, publish, distribute, sublicense, and/or sell copies of the Software, and to permit persons to whom the Software is furnished to do so, subject to the following conditions:

The above copyright notice and this permission notice shall be included in all copies or substantial portions of the Software.

THE SOFTWARE IS PROVIDED "AS IS", WITHOUT WARRANTY OF ANY KIND, EXPRESS OR IMPLIED, INCLUDING BUT NOT LIMITED TO THE WARRANTIES OF MERCHANTABILITY, FITNESS FOR A PARTICULAR PURPOSE AND NONINFRINGEMENT. IN NO EVENT SHALL THE ABOVE LISTED COPYRIGHT HOLDER(S) BE LIABLE FOR ANY CLAIM, DAMAGES OR

OTHER LIABILITY, WHETHER IN AN ACTION OF CONTRACT, TORT OR OTHERWISE,
ARISING FROM, OUT OF OR IN CONNECTION WITH THE SOFTWARE OR THE USE OR
OTHER
DEALINGS IN THE SOFTWARE.

Except as contained in this notice, the name(s) of the above copyright
holders shall not be used in advertising or otherwise to promote the sale,
use or other dealings in this Software without prior written authorization.

Copyright (C) 1999,2000 by Eric Sunshine <sunshine@sunshineco.com>

Copyright (C) 2001–2005 by Thomas Winischhofer, Vienna, Austria.

All rights reserved.

Redistribution and use in source and binary forms, with or without
modification, are permitted provided that the following conditions are met:

1. Redistributions of source code must retain the above copyright

notice, this list of conditions and the following disclaimer.

2. Redistributions in binary form must reproduce the above copyright

notice, this list of conditions and the following disclaimer in the

documentation and/or other materials provided with the distribution.

3. The name of the author may not be used to endorse or promote products

derived from this software without specific prior written permission.

THIS SOFTWARE IS PROVIDED BY THE AUTHOR ``AS IS" AND ANY EXPRESS OR
IMPLIED WARRANTIES, INCLUDING, BUT NOT LIMITED TO, THE IMPLIED WARRANTIES
OF MERCHANTABILITY AND FITNESS FOR A PARTICULAR PURPOSE ARE DISCLAIMED.

IN

NO EVENT SHALL THE AUTHOR BE LIABLE FOR ANY DIRECT, INDIRECT, INCIDENTAL,
SPECIAL, EXEMPLARY, OR CONSEQUENTIAL DAMAGES (INCLUDING, BUT NOT LIMITED
TO, PROCUREMENT OF SUBSTITUTE GOODS OR SERVICES; LOSS OF USE, DATA, OR
PROFITS; OR BUSINESS INTERRUPTION) HOWEVER CAUSED AND ON ANY THEORY OF
LIABILITY, WHETHER IN CONTRACT, STRICT LIABILITY, OR TORT (INCLUDING
NEGLIGENCE OR OTHERWISE) ARISING IN ANY WAY OUT OF THE USE OF THIS
SOFTWARE, EVEN IF ADVISED OF THE POSSIBILITY OF SUCH DAMAGE.

Copyright (C) 2005 Bogdan D. bogdand@users.sourceforge.net

Permission is hereby granted, free of charge, to any person obtaining a copy of this software and associated documentation files (the "Software"), to deal in the Software without restriction, including without limitation the rights to use, copy, modify, merge, publish, distribute, sublicense, and/or sell copies of the Software, and to permit persons to whom the Software is furnished to do so, subject to the following conditions:

The above copyright notice and this permission notice shall be included in all copies or substantial portions of the Software.

THE SOFTWARE IS PROVIDED "AS IS", WITHOUT WARRANTY OF ANY KIND, EXPRESS OR IMPLIED, INCLUDING BUT NOT LIMITED TO THE WARRANTIES OF MERCHANTABILITY, FITNESS FOR A PARTICULAR PURPOSE AND NONINFRINGEMENT. IN NO EVENT SHALL THE AUTHOR BE LIABLE FOR ANY CLAIM, DAMAGES OR OTHER LIABILITY, WHETHER IN AN

ACTION OF CONTRACT, TORT OR OTHERWISE, ARISING FROM, OUT OF OR IN CONNECTION

WITH THE SOFTWARE OR THE USE OR OTHER DEALINGS IN THE SOFTWARE.

Except as contained in this notice, the name of the author shall not be used in advertising or otherwise to promote the sale, use or other dealings in this Software without prior written authorization from the author.

Copyright © 2002 David Dawes

Permission is hereby granted, free of charge, to any person obtaining a copy of this software and associated documentation files (the "Software"), to deal in the Software without restriction, including without limitation the rights to use, copy, modify, merge, publish, distribute, sublicense, and/or sell copies of the Software, and to permit persons to whom the Software is furnished to do so, subject to the following conditions:

The above copyright notice and this permission notice shall be included in

all copies or substantial portions of the Software.

THE SOFTWARE IS PROVIDED "AS IS", WITHOUT WARRANTY OF ANY KIND, EXPRESS OR IMPLIED, INCLUDING BUT NOT LIMITED TO THE WARRANTIES OF MERCHANTABILITY, FITNESS FOR A PARTICULAR PURPOSE AND NONINFRINGEMENT. IN NO EVENT SHALL

THE AUTHOR(S) BE LIABLE FOR ANY CLAIM, DAMAGES OR OTHER LIABILITY, WHETHER IN AN ACTION OF CONTRACT, TORT OR OTHERWISE, ARISING FROM, OUT OF OR IN CONNECTION WITH THE SOFTWARE OR THE USE OR OTHER DEALINGS IN THE SOFTWARE.

Except as contained in this notice, the name of the author(s) shall not be used in advertising or otherwise to promote the sale, use or other dealings in this Software without prior written authorization from the author(s).

Copyright (C) 1996–1999 SciTech Software, Inc.

Copyright (C) David Mosberger-Tang

Copyright (C) 1999 Egbert Eich

Copyright (C) 2008 Bart Trojanowski, Symbio Technologies, LLC

Permission to use, copy, modify, distribute, and sell this software and its documentation for any purpose is hereby granted without fee, provided that the above copyright notice appear in all copies and that both that copyright notice and this permission notice appear in supporting documentation, and that the name of the authors not be used in advertising or publicity pertaining to distribution of the software without specific, written prior permission. The authors makes no representations about the suitability of this software for any purpose. It is provided "as is" without express or implied warranty.

THE AUTHORS DISCLAIMS ALL WARRANTIES WITH REGARD TO THIS SOFTWARE, INCLUDING ALL IMPLIED WARRANTIES OF MERCHANTABILITY AND FITNESS, IN NO EVENT SHALL THE AUTHORS BE LIABLE FOR ANY SPECIAL, INDIRECT OR CONSEQUENTIAL DAMAGES OR ANY DAMAGES WHATSOEVER RESULTING FROM LOSS OF

USE, DATA OR PROFITS, WHETHER IN AN ACTION OF CONTRACT, NEGLIGENCE OR OTHER TORTIOUS ACTION, ARISING OUT OF OR IN CONNECTION WITH THE USE OR PERFORMANCE OF THIS SOFTWARE.

Copyright 2005–2006 Luc Verhaegen.

Permission is hereby granted, free of charge, to any person obtaining a copy of this software and associated documentation files (the "Software"), to deal in the Software without restriction, including without limitation the rights to use, copy, modify, merge, publish, distribute, sublicense, and/or sell copies of the Software, and to permit persons to whom the Software is furnished to do so, subject to the following conditions:

The above copyright notice and this permission notice shall be included in all copies or substantial portions of the Software.

THE SOFTWARE IS PROVIDED "AS IS", WITHOUT WARRANTY OF ANY KIND, EXPRESS OR IMPLIED, INCLUDING BUT NOT LIMITED TO THE WARRANTIES OF MERCHANTABILITY,

FITNESS FOR A PARTICULAR PURPOSE AND NONINFRINGEMENT. IN NO EVENT SHALL

THE COPYRIGHT HOLDER(S) OR AUTHOR(S) BE LIABLE FOR ANY CLAIM, DAMAGES OR OTHER LIABILITY, WHETHER IN AN ACTION OF CONTRACT, TORT OR OTHERWISE, ARISING FROM, OUT OF OR IN CONNECTION WITH THE SOFTWARE OR THE USE OR OTHER DEALINGS IN THE SOFTWARE.

Copyright 1995 by Robin Cutshaw <robin@XFree86.Org>

Copyright 2000 by Egbert Eich

Copyright 2002 by David Dawes

Permission to use, copy, modify, distribute, and sell this software and its documentation for any purpose is hereby granted without fee, provided that the above copyright notice appear in all copies and that both that copyright notice and this permission notice appear in supporting documentation, and that the names of the above listed copyright holder(s) not be used in advertising or publicity pertaining to distribution of the software without specific, written prior permission. The above listed

copyright holder(s) make(s) no representations about the suitability of this software for any purpose. It is provided "as is" without express or implied warranty.

THE ABOVE LISTED COPYRIGHT HOLDER(S) DISCLAIM(S) ALL WARRANTIES WITH REGARD

TO THIS SOFTWARE, INCLUDING ALL IMPLIED WARRANTIES OF MERCHANTABILITY AND FITNESS, IN NO EVENT SHALL THE ABOVE LISTED COPYRIGHT HOLDER(S) BE LIABLE FOR ANY SPECIAL, INDIRECT OR CONSEQUENTIAL DAMAGES OR ANY DAMAGES WHATSOEVER RESULTING FROM LOSS OF USE, DATA OR PROFITS, WHETHER

IN AN ACTION OF CONTRACT, NEGLIGENCE OR OTHER TORTIOUS ACTION, ARISING OUT OF OR IN CONNECTION WITH THE USE OR PERFORMANCE OF THIS SOFTWARE.

Copyright 1997–2004 by Marc Aurele La France (TSI @ UQV), tsi@xfree86.org

Permission to use, copy, modify, distribute, and sell this software and its documentation for any purpose is hereby granted without fee, provided that

the above copyright notice appear in all copies and that both that copyright notice and this permission notice appear in supporting documentation, and that the name of Marc Aurele La France not be used in advertising or publicity pertaining to distribution of the software without specific, written prior permission. Marc Aurele La France makes no representations about the suitability of this software for any purpose. It is provided "as-is" without express or implied warranty.

MARC AURELE LA FRANCE DISCLAIMS ALL WARRANTIES WITH REGARD TO THIS SOFTWARE, INCLUDING ALL IMPLIED WARRANTIES OF MERCHANTABILITY AND FITNESS. IN NO EVENT SHALL MARC AURELE LA FRANCE BE LIABLE FOR ANY SPECIAL, INDIRECT OR CONSEQUENTIAL DAMAGES OR ANY DAMAGES WHATSOEVER RESULTING FROM LOSS OF USE, DATA OR PROFITS, WHETHER IN AN ACTION OF CONTRACT, NEGLIGENCE OR OTHER TORTIOUS ACTION, ARISING OUT OF OR IN CONNECTION WITH THE USE OR PERFORMANCE OF THIS SOFTWARE.

Copyright 1990, 1991 by Thomas Roell, Dinkelscherben, Germany

Copyright 1992 by David Dawes <dawes@XFree86.org>

Copyright 1992 by Jim Tsillas <jtsilla@damon.ccs.northeastern.edu>

Copyright 1992 by Rich Murphey <Rich@Rice.edu>

Copyright 1992 by Robert Baron <Robert.Baron@ernst.mach.cs.cmu.edu>

Copyright 1992 by Orest Zborowski <obz@eskimo.com>

Copyright 1993 by Vrije Universiteit, The Netherlands

Copyright 1993 by David Wexelblat <dwex@XFree86.org>

Copyright 1994, 1996 by Holger Veit <Holger.Veit@gmd.de>

Copyright 1997 by Takis Psarogiannakopoulos <takis@dpmms.cam.ac.uk>

Copyright 1994–2003 by The XFree86 Project, Inc

Permission to use, copy, modify, distribute, and sell this software and its documentation for any purpose is hereby granted without fee, provided that the above copyright notice appear in all copies and that both that copyright notice and this permission notice appear in supporting documentation, and that the names of the above listed copyright holders not be used in advertising or publicity pertaining to distribution of

the software without specific, written prior permission. The above listed copyright holders make no representations about the suitability of this software for any purpose. It is provided "as is" without express or implied warranty.

THE ABOVE LISTED COPYRIGHT HOLDERS DISCLAIM ALL WARRANTIES WITH REGARD TO THIS SOFTWARE, INCLUDING ALL IMPLIED WARRANTIES OF MERCHANTABILITY AND FITNESS, IN NO EVENT SHALL THE ABOVE LISTED COPYRIGHT HOLDERS BE LIABLE FOR ANY SPECIAL, INDIRECT OR CONSEQUENTIAL DAMAGES OR ANY DAMAGES WHATSOEVER RESULTING FROM LOSS OF USE, DATA OR PROFITS, WHETHER IN AN ACTION OF CONTRACT, NEGLIGENCE OR OTHER TORTIOUS ACTION, ARISING OUT OF OR IN CONNECTION WITH THE USE OR PERFORMANCE OF THIS SOFTWARE.

Copyright (C) 2000 Jakub Jelinek (jakub@redhat.com)

Permission is hereby granted, free of charge, to any person obtaining a copy of this software and associated documentation files (the "Software"), to deal

in the Software without restriction, including without limitation the rights to use, copy, modify, merge, publish, distribute, sublicense, and/or sell copies of the Software, and to permit persons to whom the Software is furnished to do so, subject to the following conditions:

The above copyright notice and this permission notice shall be included in all copies or substantial portions of the Software.

THE SOFTWARE IS PROVIDED "AS IS", WITHOUT WARRANTY OF ANY KIND, EXPRESS OR IMPLIED, INCLUDING BUT NOT LIMITED TO THE WARRANTIES OF MERCHANTABILITY, FITNESS FOR A PARTICULAR PURPOSE AND NONINFRINGEMENT. IN NO EVENT SHALL

JAKUB JELINEK BE LIABLE FOR ANY CLAIM, DAMAGES OR OTHER LIABILITY, WHETHER IN AN ACTION OF CONTRACT, TORT OR OTHERWISE, ARISING FROM, OUT OF OR IN CONNECTION WITH THE SOFTWARE OR THE USE OR OTHER DEALINGS IN THE SOFTWARE.

Copyright (C) 2000 Keith Packard

2004 Eric Anholt

2005 Zack Rusin

Permission to use, copy, modify, distribute, and sell this software and its documentation for any purpose is hereby granted without fee, provided that the above copyright notice appear in all copies and that both that copyright notice and this permission notice appear in supporting documentation, and that the name of copyright holders not be used in advertising or publicity pertaining to distribution of the software without specific, written prior permission. Copyright holders make no representations about the suitability of this software for any purpose. It is provided "as is" without express or implied warranty.

THE COPYRIGHT HOLDERS DISCLAIM ALL WARRANTIES WITH REGARD TO THIS SOFTWARE, INCLUDING ALL IMPLIED WARRANTIES OF MERCHANTABILITY AND FITNESS, IN NO EVENT SHALL THE COPYRIGHT HOLDERS BE LIABLE FOR ANY SPECIAL, INDIRECT OR CONSEQUENTIAL DAMAGES OR ANY DAMAGES WHATSOEVER RESULTING FROM LOSS OF USE, DATA OR PROFITS, WHETHER IN AN ACTION OF CONTRACT, NEGLIGENCE OR OTHER TORTIOUS ACTION, ARISING

OUT OF OR IN CONNECTION WITH THE USE OR PERFORMANCE OF THIS SOFTWARE.

Copyright © 2007 OpenedHand Ltd

Permission to use, copy, modify, distribute, and sell this software and its documentation for any purpose is hereby granted without fee, provided that the above copyright notice appear in all copies and that both that copyright notice and this permission notice appear in supporting documentation, and that the name of OpenedHand Ltd not be used in advertising or publicity pertaining to distribution of the software without specific, written prior permission. OpenedHand Ltd makes no representations about the suitability of this software for any purpose. It is provided "as is" without express or implied warranty.

OpenedHand Ltd DISCLAIMS ALL WARRANTIES WITH REGARD TO THIS SOFTWARE, INCLUDING ALL IMPLIED WARRANTIES OF MERCHANTABILITY AND FITNESS, IN NO EVENT SHALL OpenedHand Ltd BE LIABLE FOR ANY SPECIAL, INDIRECT OR

CONSEQUENTIAL DAMAGES OR ANY DAMAGES WHATSOEVER RESULTING FROM LOSS OF USE, DATA OR PROFITS, WHETHER IN AN ACTION OF CONTRACT, NEGLIGENCE OR OTHER TORTIOUS ACTION, ARISING OUT OF OR IN CONNECTION WITH THE USE OR PERFORMANCE OF THIS SOFTWARE.

Copyright (c) 1989, 1990, 1993, 1994

The Regents of the University of California. All rights reserved.

This code is derived from software contributed to Berkeley by
Chris Torek.

This code is derived from software contributed to Berkeley by
Michael Rendell of Memorial University of Newfoundland.

Redistribution and use in source and binary forms, with or without
modification, are permitted provided that the following conditions
are met:

1. Redistributions of source code must retain the above copyright notice, this list of conditions and the following disclaimer.
2. Redistributions in binary form must reproduce the above copyright notice, this list of conditions and the following disclaimer in the documentation and/or other materials provided with the distribution.
4. Neither the name of the University nor the names of its contributors may be used to endorse or promote products derived from this software without specific prior written permission.

THIS SOFTWARE IS PROVIDED BY THE REGENTS AND CONTRIBUTORS "AS IS" AND ANY EXPRESS OR IMPLIED WARRANTIES, INCLUDING, BUT NOT LIMITED TO, THE IMPLIED WARRANTIES OF MERCHANTABILITY AND FITNESS FOR A PARTICULAR PURPOSE ARE DISCLAIMED. IN NO EVENT SHALL THE REGENTS OR CONTRIBUTORS BE LIABLE FOR ANY DIRECT, INDIRECT, INCIDENTAL, SPECIAL, EXEMPLARY, OR CONSEQUENTIAL DAMAGES (INCLUDING, BUT NOT LIMITED TO, PROCUREMENT OF SUBSTITUTE GOODS OR SERVICES; LOSS OF USE, DATA, OR PROFITS; OR BUSINESS INTERRUPTION)

HOWEVER CAUSED AND ON ANY THEORY OF LIABILITY, WHETHER IN CONTRACT,
STRICT
LIABILITY, OR TORT (INCLUDING NEGLIGENCE OR OTHERWISE) ARISING IN ANY WAY
OUT OF THE USE OF THIS SOFTWARE, EVEN IF ADVISED OF THE POSSIBILITY OF
SUCH DAMAGE.

Copyright 1987 by Apollo Computer Inc., Chelmsford, Massachusetts.

Copyright 1989 by Hewlett-Packard Company.

All Rights Reserved

Permission to use, duplicate, change, and distribute this software and
its documentation for any purpose and without fee is granted, provided
that the above copyright notice appear in such copy and that this
copyright notice appear in all supporting documentation, and that the
names of Apollo Computer Inc., the Hewlett-Packard Company, or the X
Consortium not be used in advertising or publicity pertaining to
distribution of the software without written prior permission.

HEWLETT-PACKARD MAKES NO WARRANTY OF ANY KIND WITH REGARD TO THIS SOFTWARE, INCLUDING, BUT NOT LIMITED TO, THE IMPLIED WARRANTIES OF MERCHANTABILITY AND FITNESS FOR A PARTICULAR PURPOSE. Hewlett-Packard shall not be liable for errors contained herein or direct, indirect, special, incidental or consequential damages in connection with the furnishing, performance, or use of this material.

Copyright 1993, 1994 NCR Corporation – Dayton, Ohio, USA

All Rights Reserved

Permission to use, copy, modify, and distribute this software and its documentation for any purpose and without fee is hereby granted, provided that the above copyright notice appear in all copies and that both that copyright notice and this permission notice appear in supporting documentation, and that the name NCR not be used in advertising

or publicity pertaining to distribution of the software without specific, written prior permission. NCR makes no representations about the suitability of this software for any purpose. It is provided "as is" without express or implied warranty.

NCR DISCLAIMS ALL WARRANTIES WITH REGARD TO THIS SOFTWARE, INCLUDING ALL IMPLIED WARRANTIES OF MERCHANTABILITY AND FITNESS, IN NO EVENT SHALL NCR BE LIABLE FOR ANY SPECIAL, INDIRECT OR CONSEQUENTIAL DAMAGES OR ANY DAMAGES WHATSOEVER RESULTING FROM LOSS OF USE, DATA OR PROFITS, WHETHER IN AN ACTION OF CONTRACT, NEGLIGENCE OR OTHER TORTIOUS ACTION, ARISING OUT OF OR IN CONNECTION WITH THE USE OR PERFORMANCE OF THIS SOFTWARE.

(c) Copyright 1996 by Sebastien Marineau and Holger Veit

<marineau@genie.uottawa.ca>

<Holger.Veit@gmd.de>

Permission is hereby granted, free of charge, to any person obtaining a

copy of this software and associated documentation files (the "Software"),
to deal in the Software without restriction, including without limitation
the rights to use, copy, modify, merge, publish, distribute, sublicense,
and/or sell copies of the Software, and to permit persons to whom the
Software is furnished to do so, subject to the following conditions:

The above copyright notice and this permission notice shall be included in
all copies or substantial portions of the Software.

THE SOFTWARE IS PROVIDED "AS IS", WITHOUT WARRANTY OF ANY KIND, EXPRESS OR
IMPLIED, INCLUDING BUT NOT LIMITED TO THE WARRANTIES OF MERCHANTABILITY,
FITNESS FOR A PARTICULAR PURPOSE AND NONINFRINGEMENT. IN NO EVENT
SHALL
HOLGER VEIT BE LIABLE FOR ANY CLAIM, DAMAGES OR OTHER LIABILITY,
WHETHER IN AN ACTION OF CONTRACT, TORT OR OTHERWISE, ARISING FROM, OUT
OF
OR IN CONNECTION WITH THE SOFTWARE OR THE USE OR OTHER DEALINGS IN THE
SOFTWARE.

Except as contained in this notice, the name of Sebastien Marineau or Holger Veit shall not be used in advertising or otherwise to promote the sale, use or other dealings in this Software without prior written authorization from Holger Veit or Sebastien Marineau.

Copyright © 2003 Keith Packard, Noah Levitt

Permission to use, copy, modify, distribute, and sell this software and its documentation for any purpose is hereby granted without fee, provided that the above copyright notice appear in all copies and that both that copyright notice and this permission notice appear in supporting documentation, and that the name of Keith Packard not be used in advertising or publicity pertaining to distribution of the software without specific, written prior permission. Keith Packard makes no representations about the suitability of this software for any purpose. It is provided "as is" without express or implied warranty.

KEITH PACKARD DISCLAIMS ALL WARRANTIES WITH REGARD TO THIS SOFTWARE,

INCLUDING ALL IMPLIED WARRANTIES OF MERCHANTABILITY AND FITNESS, IN NO EVENT SHALL KEITH PACKARD BE LIABLE FOR ANY SPECIAL, INDIRECT OR CONSEQUENTIAL DAMAGES OR ANY DAMAGES WHATSOEVER RESULTING FROM LOSS OF USE, DATA OR PROFITS, WHETHER IN AN ACTION OF CONTRACT, NEGLIGENCE OR OTHER TORTIOUS ACTION, ARISING OUT OF OR IN CONNECTION WITH THE USE OR PERFORMANCE OF THIS SOFTWARE.

58.xf86-video-intel

Copyright 2002 Tungsten Graphics, Inc., Cedar Park, Texas.

Copyright 2003 Tungsten Graphics, Inc., Cedar Park, Texas.

Copyright 2005 Tungsten Graphics, Inc., Cedar Park, Texas.

All Rights Reserved.

Permission is hereby granted, free of charge, to any person obtaining a copy of this software and associated documentation files (the "Software"), to deal in the Software without restriction, including without limitation the rights to use, copy, modify, merge, publish, distribute, sub license, and/or sell copies of the Software, and to permit persons to whom the Software is furnished to do so, subject to the following conditions:

The above copyright notice and this permission notice (including the next paragraph) shall be included in all copies or substantial portions of the Software.

THE SOFTWARE IS PROVIDED "AS IS", WITHOUT WARRANTY OF ANY KIND, EXPRESS OR IMPLIED, INCLUDING BUT NOT LIMITED TO THE WARRANTIES OF MERCHANTABILITY, FITNESS FOR A PARTICULAR PURPOSE AND NON-INFRINGEMENT. IN NO EVENT SHALL TUNGSTEN GRAPHICS AND/OR ITS SUPPLIERS BE LIABLE FOR ANY CLAIM, DAMAGES OR OTHER LIABILITY, WHETHER IN AN ACTION OF CONTRACT, TORT OR OTHERWISE, ARISING FROM, OUT OF OR IN CONNECTION WITH THE SOFTWARE OR THE USE OR OTHER DEALINGS IN THE SOFTWARE.

Copyright (c) 2005 Jesse Barnes <jbarnes@virtuousgeek.org>

Copyright © 2002 David Dawes

Copyright 1998-1999 Precision Insight, Inc., Cedar Park, Texas.

All Rights Reserved.

Permission is hereby granted, free of charge, to any person obtaining a copy of this software and associated documentation files (the "Software"), to deal in the Software without restriction, including without limitation the rights to use, copy, modify, merge, publish, distribute, sub license, and/or sell copies of the Software, and to

permit persons to whom the Software is furnished to do so, subject to the following conditions:

The above copyright notice and this permission notice (including the next paragraph) shall be included in all copies or substantial portions of the Software.

THE SOFTWARE IS PROVIDED "AS IS", WITHOUT WARRANTY OF ANY KIND, EXPRESS OR IMPLIED, INCLUDING BUT NOT LIMITED TO THE WARRANTIES OF MERCHANTABILITY, FITNESS FOR A PARTICULAR PURPOSE AND NON-INFRINGEMENT. IN NO EVENT SHALL PRECISION INSIGHT AND/OR ITS SUPPLIERS BE LIABLE FOR ANY CLAIM, DAMAGES OR OTHER LIABILITY, WHETHER IN AN ACTION OF CONTRACT, TORT OR OTHERWISE, ARISING FROM, OUT OF OR IN CONNECTION WITH THE SOFTWARE OR THE USE OR OTHER DEALINGS IN THE SOFTWARE.

Copyright © 2006 Intel Corporation

Copyright © 2006,2010 Intel Corporation

Copyright © 2007 Intel Corporation

Copyright © 2008 Intel Corporation

Copyright © 2009 Intel Corporation

Copyright © 2007 Red Hat, Inc.

Permission is hereby granted, free of charge, to any person obtaining a copy of this software and associated documentation files (the "Software"), to deal in the Software without restriction, including without limitation the rights to use, copy, modify, merge, publish, distribute, sublicense, and/or sell copies of the Software, and to permit persons to whom the Software is furnished to do so, subject to the following conditions:

The above copyright notice and this permission notice (including the next paragraph) shall be included in all copies or substantial portions of the Software.

THE SOFTWARE IS PROVIDED "AS IS", WITHOUT WARRANTY OF ANY KIND, EXPRESS OR IMPLIED, INCLUDING BUT NOT LIMITED TO THE WARRANTIES OF MERCHANTABILITY, FITNESS FOR A PARTICULAR PURPOSE AND NONINFRINGEMENT. IN NO EVENT SHALL

THE AUTHORS OR COPYRIGHT HOLDERS BE LIABLE FOR ANY CLAIM, DAMAGES OR OTHER LIABILITY, WHETHER IN AN ACTION OF CONTRACT, TORT OR OTHERWISE, ARISING FROM, OUT OF OR IN CONNECTION WITH THE SOFTWARE OR THE USE OR OTHER DEALINGS IN THE SOFTWARE.

Copyright 2000 by Alan Hourihane, Sychdyn, North Wales, UK.

Permission to use, copy, modify, distribute, and sell this software and its documentation for any purpose is hereby granted without fee, provided that the above copyright notice appear in all copies and that both that copyright notice and this permission notice appear in supporting documentation, and that the name of Alan Hourihane not be used in advertising or publicity pertaining to distribution of the software without specific, written prior permission. Alan Hourihane makes no representations about the suitability of this software for any purpose. It is provided "as is" without express or implied warranty.

ALAN HOURIHANE DISCLAIMS ALL WARRANTIES WITH REGARD TO THIS SOFTWARE, INCLUDING ALL IMPLIED WARRANTIES OF MERCHANTABILITY AND FITNESS, IN NO EVENT SHALL ALAN HOURIHANE BE LIABLE FOR ANY SPECIAL, INDIRECT OR CONSEQUENTIAL DAMAGES OR ANY DAMAGES WHATSOEVER RESULTING FROM LOSS OF USE, DATA OR PROFITS, WHETHER IN AN ACTION OF CONTRACT, NEGLIGENCE OR OTHER TORTIOUS ACTION, ARISING OUT OF OR IN CONNECTION WITH THE USE OR PERFORMANCE OF THIS SOFTWARE.

Copyright 2000 Intel Corporation. All Rights Reserved.

Permission is hereby granted, free of charge, to any person obtaining a copy of this software and associated documentation files (the "Software"), to deal in the Software without restriction, including without limitation the rights to use, copy, modify, merge, publish, distribute, sub license, and/or sell copies of the Software, and to permit persons to whom the Software is furnished to do so, subject to the following conditions:

The above copyright notice and this permission notice (including the next paragraph) shall be included in all copies or substantial portions of the Software.

THE SOFTWARE IS PROVIDED "AS IS", WITHOUT WARRANTY OF ANY KIND, EXPRESS OR IMPLIED, INCLUDING BUT NOT LIMITED TO THE WARRANTIES OF MERCHANTABILITY, FITNESS FOR A PARTICULAR PURPOSE AND NON-INFRINGEMENT. IN NO EVENT SHALL INTEL, AND/OR ITS SUPPLIERS BE LIABLE FOR ANY CLAIM, DAMAGES OR OTHER LIABILITY, WHETHER IN AN ACTION OF CONTRACT, TORT OR OTHERWISE, ARISING FROM, OUT OF OR IN CONNECTION WITH THE SOFTWARE OR THE USE OR OTHER DEALINGS IN THE SOFTWARE.

Copyright 2001 VA Linux Systems Inc., Fremont, California.

Copyright © 2002 by David Dawes

All Rights Reserved.

Permission is hereby granted, free of charge, to any person obtaining a

copy of this software and associated documentation files (the "Software"),
to deal in the Software without restriction, including without limitation
on the rights to use, copy, modify, merge, publish, distribute, sub
license, and/or sell copies of the Software, and to permit persons to whom
the Software is furnished to do so, subject to the following conditions:

The above copyright notice and this permission notice (including the next
paragraph) shall be included in all copies or substantial portions of the
Software.

THE SOFTWARE IS PROVIDED "AS IS", WITHOUT WARRANTY OF ANY KIND, EXPRESS OR
IMPLIED, INCLUDING BUT NOT LIMITED TO THE WARRANTIES OF MERCHANTABILITY,
FITNESS FOR A PARTICULAR PURPOSE AND NON-INFRINGEMENT. IN NO EVENT SHALL
ATI, VA LINUX SYSTEMS AND/OR THEIR SUPPLIERS BE LIABLE FOR ANY CLAIM,
DAMAGES OR OTHER LIABILITY, WHETHER IN AN ACTION OF CONTRACT, TORT OR
OTHERWISE, ARISING FROM, OUT OF OR IN CONNECTION WITH THE SOFTWARE OR
THE
USE OR OTHER DEALINGS IN THE SOFTWARE.

Copyright © 1999 Keith Packard

Copyright ® 2001 Keith Packard

Copyright © 2000, 2008 Keith Packard

Permission to use, copy, modify, distribute, and sell this software and its documentation for any purpose is hereby granted without fee, provided that the above copyright notice appear in all copies and that both that copyright notice and this permission notice appear in supporting documentation, and that the name of Keith Packard not be used in advertising or publicity pertaining to distribution of the software without specific, written prior permission. Keith Packard makes no representations about the suitability of this software for any purpose. It is provided "as is" without express or implied warranty.

KEITH PACKARD DISCLAIMS ALL WARRANTIES WITH REGARD TO THIS SOFTWARE, INCLUDING ALL IMPLIED WARRANTIES OF MERCHANTABILITY AND FITNESS, IN NO EVENT SHALL KEITH PACKARD BE LIABLE FOR ANY SPECIAL, INDIRECT OR CONSEQUENTIAL DAMAGES OR ANY DAMAGES WHATSOEVER RESULTING FROM LOSS OF USE,

DATA OR PROFITS, WHETHER IN AN ACTION OF CONTRACT, NEGLIGENCE OR OTHER TORTIOUS ACTION, ARISING OUT OF OR IN CONNECTION WITH THE USE OR PERFORMANCE OF THIS SOFTWARE.

59.xkeyboard-config

Copyright 1996 by Joseph Moss

Copyright (C) 2002–2007 Free Software Foundation, Inc.

Copyright (C) Dmitry Golubev <lastguru@mail.ru>, 2003–2004

Copyright (C) 2004, Gregory Mokhin <mokhin@bog.msu.ru>

Copyright (C) 2006 Erdal Ronahî

Permission to use, copy, modify, distribute, and sell this software and its documentation for any purpose is hereby granted without fee, provided that the above copyright notice appear in all copies and that both that copyright notice and this permission notice appear in supporting documentation, and that the name of the copyright holder(s) not be used in

advertising or publicity pertaining to distribution of the software without specific, written prior permission. The copyright holder(s) makes no representations about the suitability of this software for any purpose. It is provided "as is" without express or implied warranty.

THE COPYRIGHT HOLDER(S) DISCLAIMS ALL WARRANTIES WITH REGARD TO THIS SOFTWARE,

INCLUDING ALL IMPLIED WARRANTIES OF MERCHANTABILITY AND FITNESS, IN NO EVENT SHALL THE COPYRIGHT HOLDER(S) BE LIABLE FOR ANY SPECIAL, INDIRECT OR CONSEQUENTIAL DAMAGES OR ANY DAMAGES WHATSOEVER RESULTING FROM LOSS OF USE,

DATA OR PROFITS, WHETHER IN AN ACTION OF CONTRACT, NEGLIGENCE OR OTHER TORTIOUS ACTION, ARISING OUT OF OR IN CONNECTION WITH THE USE OR PERFORMANCE OF THIS SOFTWARE.

Copyright (c) 1996 Digital Equipment Corporation

Permission is hereby granted, free of charge, to any person obtaining

a copy of this software and associated documentation files (the "Software"), to deal in the Software without restriction, including without limitation the rights to use, copy, modify, merge, publish, distribute, sublicense, and sell copies of the Software, and to permit persons to whom the Software is furnished to do so, subject to the following conditions:

The above copyright notice and this permission notice shall be included in all copies or substantial portions of the Software.

THE SOFTWARE IS PROVIDED "AS IS", WITHOUT WARRANTY OF ANY KIND, EXPRESS OR IMPLIED, INCLUDING BUT NOT LIMITED TO THE WARRANTIES OF MERCHANTABILITY, FITNESS FOR A PARTICULAR PURPOSE AND NONINFRINGEMENT. IN NO EVENT SHALL DIGITAL EQUIPMENT CORPORATION BE LIABLE FOR ANY CLAIM, DAMAGES OR OTHER LIABILITY, WHETHER IN AN ACTION OF CONTRACT, TORT OR OTHERWISE, ARISING FROM, OUT OF OR IN CONNECTION WITH THE SOFTWARE OR THE USE OR OTHER DEALINGS IN THE SOFTWARE.

Except as contained in this notice, the name of the Digital Equipment

Corporation shall not be used in advertising or otherwise to promote the sale, use or other dealings in this Software without prior written authorization from Digital Equipment Corporation.

Copyright 1996, 1998 The Open Group

Permission to use, copy, modify, distribute, and sell this software and its documentation for any purpose is hereby granted without fee, provided that the above copyright notice appear in all copies and that both that copyright notice and this permission notice appear in supporting documentation.

The above copyright notice and this permission notice shall be included in all copies or substantial portions of the Software.

THE SOFTWARE IS PROVIDED "AS IS", WITHOUT WARRANTY OF ANY KIND, EXPRESS OR IMPLIED, INCLUDING BUT NOT LIMITED TO THE WARRANTIES OF MERCHANTABILITY, FITNESS FOR A PARTICULAR PURPOSE AND NONINFRINGEMENT.

IN NO EVENT SHALL THE OPEN GROUP BE LIABLE FOR ANY CLAIM, DAMAGES OR OTHER LIABILITY, WHETHER IN AN ACTION OF CONTRACT, TORT OR OTHERWISE, ARISING FROM, OUT OF OR IN CONNECTION WITH THE SOFTWARE OR THE USE OR OTHER DEALINGS IN THE SOFTWARE.

Except as contained in this notice, the name of The Open Group shall not be used in advertising or otherwise to promote the sale, use or other dealings in this Software without prior written authorization from The Open Group.

Copyright 2004–2005 Sun Microsystems, Inc. All rights reserved.

Permission is hereby granted, free of charge, to any person obtaining a copy of this software and associated documentation files (the "Software"), to deal in the Software without restriction, including without limitation the rights to use, copy, modify, merge, publish, distribute, sublicense, and/or sell copies of the Software, and to permit persons to whom the Software is furnished to do so, subject to the following conditions:

The above copyright notice and this permission notice (including the next paragraph) shall be included in all copies or substantial portions of the Software.

THE SOFTWARE IS PROVIDED "AS IS", WITHOUT WARRANTY OF ANY KIND, EXPRESS OR IMPLIED, INCLUDING BUT NOT LIMITED TO THE WARRANTIES OF MERCHANTABILITY, FITNESS FOR A PARTICULAR PURPOSE AND NONINFRINGEMENT. IN NO EVENT SHALL THE AUTHORS OR COPYRIGHT HOLDERS BE LIABLE FOR ANY CLAIM, DAMAGES OR OTHER LIABILITY, WHETHER IN AN ACTION OF CONTRACT, TORT OR OTHERWISE, ARISING FROM, OUT OF OR IN CONNECTION WITH THE SOFTWARE OR THE USE OR OTHER DEALINGS IN THE SOFTWARE.

Copyright (c) 1996 by Silicon Graphics Computer Systems, Inc.

Permission to use, copy, modify, and distribute this

software and its documentation for any purpose and without fee is hereby granted, provided that the above copyright notice appear in all copies and that both that copyright notice and this permission notice appear in supporting documentation, and that the name of Silicon Graphics not be used in advertising or publicity pertaining to distribution of the software without specific prior written permission.

Silicon Graphics makes no representation about the suitability of this software for any purpose. It is provided "as is" without any express or implied warranty.

SILICON GRAPHICS DISCLAIMS ALL WARRANTIES WITH REGARD TO THIS SOFTWARE, INCLUDING ALL IMPLIED WARRANTIES OF MERCHANTABILITY AND FITNESS FOR A PARTICULAR PURPOSE. IN NO EVENT SHALL SILICON GRAPHICS BE LIABLE FOR ANY SPECIAL, INDIRECT OR CONSEQUENTIAL DAMAGES OR ANY DAMAGES WHATSOEVER RESULTING FROM LOSS OF USE, DATA OR PROFITS, WHETHER IN AN ACTION OF CONTRACT, NEGLIGENCE OR OTHER TORTIOUS ACTION, ARISING OUT OF OR IN CONNECTION WITH THE USE OR PERFORMANCE OF THIS SOFTWARE.

Copyright (c) 1996 X Consortium

Permission is hereby granted, free of charge, to any person obtaining a copy of this software and associated documentation files (the "Software"), to deal in the Software without restriction, including without limitation the rights to use, copy, modify, merge, publish, distribute, sublicense, and/or sell copies of the Software, and to permit persons to whom the Software is furnished to do so, subject to the following conditions:

The above copyright notice and this permission notice shall be included in all copies or substantial portions of the Software.

THE SOFTWARE IS PROVIDED "AS IS", WITHOUT WARRANTY OF ANY KIND, EXPRESS OR IMPLIED, INCLUDING BUT NOT LIMITED TO THE WARRANTIES OF MERCHANTABILITY, FITNESS FOR A PARTICULAR PURPOSE AND NONINFRINGEMENT. IN NO EVENT SHALL THE X CONSORTIUM BE LIABLE FOR ANY CLAIM, DAMAGES OR

OTHER LIABILITY, WHETHER IN AN ACTION OF CONTRACT, TORT OR OTHERWISE, ARISING FROM, OUT OF OR IN CONNECTION WITH THE SOFTWARE OR THE USE OR OTHER DEALINGS IN THE SOFTWARE.

Except as contained in this notice, the name of the X Consortium shall not be used in advertising or otherwise to promote the sale, use or other dealings in this Software without prior written authorization from the X Consortium.

Copyright (C) 2004, 2006 Ævar Arnfjörð Bjarmason <avarab@gmail.com>

Permission to use, copy, modify, distribute, and sell this software and its documentation for any purpose is hereby granted without fee, provided that the above copyright notice appear in all copies and that both that copyright notice and this permission notice appear in supporting documentation.

The above copyright notice and this permission notice shall be

included in all copies or substantial portions of the Software.

THE SOFTWARE IS PROVIDED "AS IS", WITHOUT WARRANTY OF ANY KIND, EXPRESS OR IMPLIED, INCLUDING BUT NOT LIMITED TO THE WARRANTIES OF MERCHANTABILITY, FITNESS FOR A PARTICULAR PURPOSE AND NONINFRINGEMENT. IN NO EVENT SHALL THE OPEN GROUP BE LIABLE FOR ANY CLAIM, DAMAGES OR OTHER LIABILITY, WHETHER IN AN ACTION OF CONTRACT, TORT OR OTHERWISE, ARISING FROM, OUT OF OR IN CONNECTION WITH THE SOFTWARE OR THE USE OR OTHER DEALINGS IN THE SOFTWARE.

Except as contained in this notice, the name of a copyright holder shall not be used in advertising or otherwise to promote the sale, use or other dealings in this Software without prior written authorization of the copyright holder.

Copyright (C) 1999, 2000 by Anton Zinoviev <anton@lml.bas.bg>

This software may be used, modified, copied, distributed, and sold,

in both source and binary form provided that the above copyright and these terms are retained. Under no circumstances is the author responsible for the proper functioning of this software, nor does the author assume any responsibility for damages incurred with its use.

Permission is granted to anyone to use, distribute and modify this file in any way, provided that the above copyright notice is left intact and the author of the modification summarizes the changes in this header.

This file is distributed without any expressed or implied warranty.

60.Xrandr

Copyright (c) 2001 Keith Packard, member of The XFree86 Project, Inc.

Copyright (c) 2002 Hewlett Packard Company, Inc.

Copyright (c) 2006 Intel Corporation

Permission to use, copy, modify, distribute, and sell this software and its documentation for any purpose is hereby granted without fee, provided that the above copyright notice appear in all copies and that both that copyright notice and this permission notice appear in supporting documentation, and that the name of the copyright holders not be used in advertising or publicity pertaining to distribution of the software without specific, written prior permission. The copyright holders make no representations about the suitability of this software for any purpose. It is provided "as is" without express or implied warranty.

THE COPYRIGHT HOLDERS DISCLAIM ALL WARRANTIES WITH REGARD TO THIS SOFTWARE,

INCLUDING ALL IMPLIED WARRANTIES OF MERCHANTABILITY AND FITNESS, IN NO

EVENT SHALL THE COPYRIGHT HOLDERS BE LIABLE FOR ANY SPECIAL, INDIRECT OR
CONSEQUENTIAL DAMAGES OR ANY DAMAGES WHATSOEVER RESULTING FROM LOSS
OF USE,
DATA OR PROFITS, WHETHER IN AN ACTION OF CONTRACT, NEGLIGENCE OR OTHER
TORTIOUS ACTION, ARISING OUT OF OR IN CONNECTION WITH THE USE OR
PERFORMANCE
OF THIS SOFTWARE.

61.[Device Driver for Realtek RTL8111EP](#)

62.[Device Driver for REALTEK RTL8153](#)

63.[fusermount](#)

64.[Iptables](#)

65.[Linux](#)

66.[lvm2](#)

67.[WLAN USB Driver](#)

GNU GENERAL PUBLIC LICENSE

Version 2, June 1991

Copyright (C) 1989, 1991 Free Software Foundation, Inc.

51 Franklin Street, Fifth Floor, Boston, MA 02110-1301, USA

Everyone is permitted to copy and distribute verbatim copies

of this license document, but changing it is not allowed.

Preamble

The licenses for most software are designed to take away your freedom to share and change it. By contrast, the GNU General Public License is intended to guarantee your freedom to share and change free software--to make sure the software is free for all

its users. This General Public License applies to most of the Free Software Foundation's software and to any other program whose authors commit to using it. (Some other Free Software Foundation software is covered by the GNU Lesser General Public License instead.) You can apply it to your programs, too.

When we speak of free software, we are referring to freedom, not price. Our General Public Licenses are designed to make sure that you have the freedom to distribute copies of free software (and charge for this service if you wish), that you receive source code or can get it if you want it, that you can change the software or use pieces of it in new free programs; and that you know you can do these things.

To protect your rights, we need to make restrictions that forbid anyone to deny you these rights or to ask you to surrender the rights. These restrictions translate to certain responsibilities for you if you distribute copies of the software, or if you modify it.

For example, if you distribute copies of such a program, whether gratis or for a fee, you must give the recipients all the rights that you have. You must make sure that

they, too, receive or can get the source code. And you must show them these terms so they know their rights.

We protect your rights with two steps: (1) copyright the software, and (2) offer you this license which gives you legal permission to copy, distribute and/or modify the software.

Also, for each author's protection and ours, we want to make certain that everyone understands that there is no warranty for this free software. If the software is modified by someone else and passed on, we want its recipients to know that what they have is not the original, so that any problems introduced by others will not reflect on the original authors' reputations.

Finally, any free program is threatened constantly by software patents. We wish to avoid the danger that redistributors of a free program will individually obtain patent licenses, in effect making the program proprietary. To prevent this, we have made it clear that any patent must be licensed for everyone's free use or not licensed at all.

The precise terms and conditions for copying, distribution and modification follow.

TERMS AND CONDITIONS FOR COPYING, DISTRIBUTION AND MODIFICATION

0. This License applies to any program or other work which contains a notice placed by the copyright holder saying it may be distributed under the terms of this General Public License. The "Program", below, refers to any such program or work, and a "work based on the Program" means either the Program or any derivative work under copyright law: that is to say, a work containing the Program or a portion of it, either verbatim or with modifications and/or translated into another language. (Hereinafter, translation is included without limitation in the term "modification".) Each licensee is addressed as "you".

Activities other than copying, distribution and modification are not covered by this License; they are outside its scope. The act of running the Program is not restricted, and the output from the Program is covered only if its contents constitute a work based on the Program (independent of having been made by running the Program). Whether that is true depends on what the Program does.

1. You may copy and distribute verbatim copies of the Program's source code as you receive it, in any medium, provided that you conspicuously and appropriately publish on each copy an appropriate copyright notice and disclaimer of warranty;

keep intact all the notices that refer to this License and to the absence of any warranty; and give any other recipients of the Program a copy of this License along with the Program.

You may charge a fee for the physical act of transferring a copy, and you may at your option offer warranty protection in exchange for a fee.

2. You may modify your copy or copies of the Program or any portion of it, thus forming a work based on the Program, and copy and distribute such modifications or work under the terms of Section 1 above, provided that you also meet all of these conditions:

a) You must cause the modified files to carry prominent notices stating that you changed the files and the date of any change.

b) You must cause any work that you distribute or publish, that in whole or in part contains or is derived from the Program or any part thereof, to be licensed as a whole at no charge to all third parties under the terms of this License.

c) If the modified program normally reads commands interactively when run, you must cause it, when started running for such interactive use in the most ordinary way, to print or display an announcement including an appropriate copyright notice and a notice that there is no warranty (or else, saying that you provide a warranty) and that users may redistribute the program under these conditions, and telling the user how to view a copy of this License. (Exception: if the Program itself is interactive but does not normally print such an announcement, your work based on the Program is not required to print an announcement.)

These requirements apply to the modified work as a whole. If identifiable sections of that work are not derived from the Program, and can be reasonably considered independent and separate works in themselves, then this License, and its terms, do not apply to those sections when you distribute them as separate works. But when you distribute the same sections as part of a whole which is a work based on the Program, the distribution of the whole must be on the terms of this License, whose permissions for other licensees extend to the entire whole, and thus to each and every part regardless of who wrote it.

Thus, it is not the intent of this section to claim rights or contest your rights to work written entirely by you; rather, the intent is to exercise the right to control the distribution of derivative or collective works based on the Program.

In addition, mere aggregation of another work not based on the Program with the Program (or with a work based on the Program) on a volume of a storage or distribution medium does not bring the other work under the scope of this License.

3. You may copy and distribute the Program (or a work based on it, under Section 2) in object code or executable form under the terms of Sections 1 and 2 above provided that you also do one of the following:

a) Accompany it with the complete corresponding machine-readable source code, which must be distributed under the terms of Sections 1 and 2 above on a medium customarily used for software interchange; or,

b) Accompany it with a written offer, valid for at least three years, to give any third party, for a charge no more than your cost of physically performing source distribution, a complete machine-readable copy of the corresponding source code,

to be distributed under the terms of Sections 1 and 2 above on a medium customarily used for software interchange; or,

c) Accompany it with the information you received as to the offer to distribute corresponding source code. (This alternative is allowed only for noncommercial distribution and only if you received the program in object code or executable form with such an offer, in accord with Subsection b above.)

The source code for a work means the preferred form of the work for making modifications to it. For an executable work, complete source code means all the source code for all modules it contains, plus any associated interface definition files, plus the scripts used to control compilation and installation of the executable.

However, as a special exception, the source code distributed need not include anything that is normally distributed (in either source or binary form) with the major components (compiler, kernel, and so on) of the operating system on which the executable runs, unless that component itself accompanies the executable.

If distribution of executable or object code is made by offering access to copy from a designated place, then offering equivalent access to copy the source code from the

same place counts as distribution of the source code, even though third parties are not compelled to copy the source along with the object code.

4. You may not copy, modify, sublicense, or distribute the Program except as expressly provided under this License. Any attempt otherwise to copy, modify, sublicense or distribute the Program is void, and will automatically terminate your rights under this License. However, parties who have received copies, or rights, from you under this License will not have their licenses terminated so long as such parties remain in full compliance.

5. You are not required to accept this License, since you have not signed it. However, nothing else grants you permission to modify or distribute the Program or its derivative works. These actions are prohibited by law if you do not accept this License. Therefore, by modifying or distributing the Program (or any work based on the Program), you indicate your acceptance of this License to do so, and all its terms and conditions for copying, distributing or modifying the Program or works based on it.

6. Each time you redistribute the Program (or any work based on the Program), the recipient automatically receives a license from the original licensor to copy, distribute or modify the Program subject to these terms and conditions. You may not impose any further restrictions on the recipients' exercise of the rights granted herein. You are not responsible for enforcing compliance by third parties to this License.

7. If, as a consequence of a court judgment or allegation of patent infringement or for any other reason (not limited to patent issues), conditions are imposed on you (whether by court order, agreement or otherwise) that contradict the conditions of this License, they do not excuse you from the conditions of this License. If you cannot distribute so as to satisfy simultaneously your obligations under this License and any other pertinent obligations, then as a consequence you may not distribute the Program at all. For example, if a patent license would not permit royalty-free redistribution of the Program by all those who receive copies directly or indirectly through you, then the only way you could satisfy both it and this License would be to refrain entirely from distribution of the Program.

If any portion of this section is held invalid or unenforceable under any particular circumstance, the balance of the section is intended to apply and the section as a whole is intended to apply in other circumstances.

It is not the purpose of this section to induce you to infringe any patents or other property right claims or to contest validity of any such claims; this section has the sole purpose of protecting the integrity of the free software distribution system, which is implemented by public license practices. Many people have made generous contributions to the wide range of software distributed through that system in reliance on consistent application of that system; it is up to the author/donor to decide if he or she is willing to distribute software through any other system and a licensee cannot impose that choice.

This section is intended to make thoroughly clear what is believed to be a consequence of the rest of this License.

8. If the distribution and/or use of the Program is restricted in certain countries either by patents or by copyrighted interfaces, the original copyright holder who places the Program under this License may add an explicit geographical distribution

limitation excluding those countries, so that distribution is permitted only in or among countries not thus excluded. In such case, this License incorporates the limitation as if written in the body of this License.

9. The Free Software Foundation may publish revised and/or new versions of the General Public License from time to time. Such new versions will be similar in spirit to the present version, but may differ in detail to address new problems or concerns.

Each version is given a distinguishing version number. If the Program specifies a version number of this License which applies to it and "any later version", you have the option of following the terms and conditions either of that version or of any later version published by the Free Software Foundation. If the Program does not specify a version number of this License, you may choose any version ever published by the Free Software Foundation.

10. If you wish to incorporate parts of the Program into other free programs whose distribution conditions are different, write to the author to ask for permission. For software which is copyrighted by the Free Software Foundation, write to the Free Software Foundation; we sometimes make exceptions for this. Our decision will be

guided by the two goals of preserving the free status of all derivatives of our free software and of promoting the sharing and reuse of software generally.

NO WARRANTY

11. BECAUSE THE PROGRAM IS LICENSED FREE OF CHARGE, THERE IS NO WARRANTY FOR THE PROGRAM, TO THE EXTENT PERMITTED BY APPLICABLE LAW. EXCEPT WHEN OTHERWISE STATED IN WRITING THE COPYRIGHT HOLDERS AND/OR OTHER PARTIES PROVIDE THE PROGRAM "AS IS" WITHOUT WARRANTY OF ANY KIND, EITHER EXPRESSED OR IMPLIED, INCLUDING, BUT NOT LIMITED TO, THE IMPLIED WARRANTIES OF MERCHANTABILITY AND FITNESS FOR A PARTICULAR PURPOSE. THE ENTIRE RISK AS TO THE QUALITY AND PERFORMANCE OF THE PROGRAM IS WITH YOU. SHOULD THE PROGRAM PROVE DEFECTIVE, YOU ASSUME THE COST OF ALL NECESSARY SERVICING, REPAIR OR CORRECTION.

12. IN NO EVENT UNLESS REQUIRED BY APPLICABLE LAW OR AGREED TO IN WRITING WILL ANY COPYRIGHT HOLDER, OR ANY OTHER PARTY WHO MAY MODIFY AND/OR REDISTRIBUTE THE PROGRAM AS PERMITTED ABOVE, BE LIABLE TO YOU FOR DAMAGES, INCLUDING ANY GENERAL, SPECIAL, INCIDENTAL OR CONSEQUENTIAL

DAMAGES ARISING OUT OF THE USE OR INABILITY TO USE THE PROGRAM (INCLUDING BUT NOT LIMITED TO LOSS OF DATA OR DATA BEING RENDERED INACCURATE OR LOSSES SUSTAINED BY YOU OR THIRD PARTIES OR A FAILURE OF THE PROGRAM TO OPERATE WITH ANY OTHER PROGRAMS), EVEN IF SUCH HOLDER OR OTHER PARTY HAS BEEN ADVISED OF THE POSSIBILITY OF SUCH DAMAGES.

END OF TERMS AND CONDITIONS

How to Apply These Terms to Your New Programs

If you develop a new program, and you want it to be of the greatest possible use to the public, the best way to achieve this is to make it free software which everyone can redistribute and change under these terms.

To do so, attach the following notices to the program. It is safest to attach them to the start of each source file to most effectively convey the exclusion of warranty; and each file should have at least the "copyright" line and a pointer to where the full notice is found.

one line to give the program's name and an idea of what it does.

Copyright (C) yyyy name of author

This program is free software; you can redistribute it and/or modify it under the terms of the GNU General Public License as published by the Free Software Foundation; either version 2 of the License, or (at your option) any later version.

This program is distributed in the hope that it will be useful, but WITHOUT ANY WARRANTY; without even the implied warranty of MERCHANTABILITY or FITNESS FOR A PARTICULAR PURPOSE. See the GNU General Public License for more details.

You should have received a copy of the GNU General Public License along with this program; if not, write to the Free Software Foundation, Inc., 51 Franklin Street, Fifth Floor, Boston, MA 02110-1301, USA.

Also add information on how to contact you by electronic and paper mail.

If the program is interactive, make it output a short notice like this when it starts in an interactive mode:

Gnomovision version 69, Copyright (C) year name of author

Gnomovision comes with ABSOLUTELY NO WARRANTY; for details

type ``show w'`. This is free software, and you are welcome

to redistribute it under certain conditions; type ``show c'`

for details.

The hypothetical commands ``show w'` and ``show c'` should show the appropriate parts of the General Public License. Of course, the commands you use may be called something other than ``show w'` and ``show c'`; they could even be mouse-clicks or menu items--whatever suits your program.

You should also get your employer (if you work as a programmer) or your school, if any, to sign a "copyright disclaimer" for the program, if necessary. Here is a sample; alter the names:

Yoyodyne, Inc., hereby disclaims all copyright

interest in the program ``Gnomovision'`

(which makes passes at compilers) written

by James Hacker.

signature of Ty Coon, 1 April 1989

Ty Coon, President of Vice

This General Public License does not permit incorporating your program into proprietary programs. If your program is a subroutine library, you may consider it more useful to permit linking proprietary applications with the library. If this is what you want to do, use the GNU Lesser General Public License instead of this License.

68.ALSA Library

69.atk

70.cairo

71.clutter

72.clutter-gst

73.clutter-gtk

74.glib

75.glibc

76.gst--plugins-good

77.gstreamer

78.GTK+

79.json-glib

80.libfuse

81.Libnl

82.libusb

83.webkit

GNU LESSER GENERAL PUBLIC LICENSE

Version 2.1, February 1999

Copyright (C) 1991, 1999 Free Software Foundation, Inc.

51 Franklin Street, Fifth Floor, Boston, MA 02110-1301 USA

Everyone is permitted to copy and distribute verbatim copies
of this license document, but changing it is not allowed.

[This is the first released version of the Lesser GPL. It also counts
as the successor of the GNU Library Public License, version 2, hence
the version number 2.1.]

Preamble

The licenses for most software are designed to take away your freedom to share and change it. By contrast, the GNU General Public Licenses are intended to guarantee your freedom to share and change free software--to make sure the software is free for all its users.

This license, the Lesser General Public License, applies to some specially designated software packages--typically libraries--of the Free Software Foundation and other authors who decide to use it. You can use it too, but we suggest you first think carefully about whether this license or the ordinary General Public License is the better strategy to use in any particular case, based on the explanations below.

When we speak of free software, we are referring to freedom of use, not price. Our General Public Licenses are designed to make sure that you have the freedom to distribute copies of free software (and charge for this service if you wish); that you receive source code or can get it if you want it; that you can change the software and use pieces of it in new free programs; and that you are informed that you can do these things.

To protect your rights, we need to make restrictions that forbid distributors to deny you these rights or to ask you to surrender these rights. These restrictions translate to certain responsibilities for you if you distribute copies of the library or if you modify it.

For example, if you distribute copies of the library, whether gratis or for a fee, you must give the recipients all the rights that we gave you. You must make sure that they, too, receive or can get the source code. If you link other code with the library, you must provide complete object files to the recipients, so that they can relink them with the library after making changes to the library and recompiling it. And you must show them these terms so they know their rights.

We protect your rights with a two-step method: (1) we copyright the library, and (2) we offer you this license, which gives you legal permission to copy, distribute and/or modify the library.

To protect each distributor, we want to make it very clear that there is no warranty for the free library. Also, if the library is modified by someone else and passed on, the recipients should know that what they have is not the original version, so that the original author's reputation will not be affected by problems that might be introduced by others.

Finally, software patents pose a constant threat to the existence of any free program. We wish to make sure that a company cannot effectively restrict the users of a free program by obtaining a restrictive license from a patent holder. Therefore, we insist that any patent license obtained for a version of the library must be consistent with the full freedom of use specified in this license.

Most GNU software, including some libraries, is covered by the ordinary GNU General Public License. This license, the GNU Lesser General Public License, applies to certain designated libraries, and is quite different from the ordinary General Public License. We use this license for certain libraries in order to permit linking those libraries into non-free programs.

When a program is linked with a library, whether statically or using a shared library, the combination of the two is legally speaking a combined work, a derivative of the original library. The ordinary General Public License therefore permits such linking

only if the entire combination fits its criteria of freedom. The Lesser General Public License permits more lax criteria for linking other code with the library.

We call this license the "Lesser" General Public License because it does Less to protect the user's freedom than the ordinary General Public License. It also provides other free software developers Less of an advantage over competing non-free programs. These disadvantages are the reason we use the ordinary General Public License for many libraries. However, the Lesser license provides advantages in certain special circumstances.

For example, on rare occasions, there may be a special need to encourage the widest possible use of a certain library, so that it becomes a de-facto standard. To achieve this, non-free programs must be allowed to use the library. A more frequent case is that a free library does the same job as widely used non-free libraries. In this case, there is little to gain by limiting the free library to free software only, so we use the Lesser General Public License.

In other cases, permission to use a particular library in non-free programs enables a greater number of people to use a large body of free software. For example, permission to use the GNU C Library in non-free programs enables many more people to use the whole GNU operating system, as well as its variant, the GNU/Linux operating system.

Although the Lesser General Public License is Less protective of the users' freedom, it does ensure that the user of a program that is linked with the Library has the freedom and the wherewithal to run that program using a modified version of the Library.

The precise terms and conditions for copying, distribution and modification follow. Pay close attention to the difference between a "work based on the library" and a "work that uses the library". The former contains code derived from the library, whereas the latter must be combined with the library in order to run.

TERMS AND CONDITIONS FOR COPYING, DISTRIBUTION AND MODIFICATION

0. This License Agreement applies to any software library or other program which contains a notice placed by the copyright holder or other authorized party saying it may be distributed under the terms of this Lesser General Public License (also called "this License"). Each licensee is addressed as "you".

A "library" means a collection of software functions and/or data prepared so as to be conveniently linked with application programs (which use some of those functions and data) to form executables.

The "Library", below, refers to any such software library or work which has been distributed under these terms. A "work based on the Library" means either the Library or any derivative work under copyright law: that is to say, a work containing

the Library or a portion of it, either verbatim or with modifications and/or translated straightforwardly into another language. (Hereinafter, translation is included without limitation in the term "modification".)

"Source code" for a work means the preferred form of the work for making modifications to it. For a library, complete source code means all the source code for all modules it contains, plus any associated interface definition files, plus the scripts used to control compilation and installation of the library.

Activities other than copying, distribution and modification are not covered by this License; they are outside its scope. The act of running a program using the Library is not restricted, and output from such a program is covered only if its contents constitute a work based on the Library (independent of the use of the Library in a tool for writing it). Whether that is true depends on what the Library does and what the program that uses the Library does.

1. You may copy and distribute verbatim copies of the Library's complete source code as you receive it, in any medium, provided that you conspicuously and appropriately publish on each copy an appropriate copyright notice and disclaimer of warranty; keep intact all the notices that refer to this License and to the absence of any warranty; and distribute a copy of this License along with the Library.

You may charge a fee for the physical act of transferring a copy, and you may at your option offer warranty protection in exchange for a fee.

2. You may modify your copy or copies of the Library or any portion of it, thus forming a work based on the Library, and copy and distribute such modifications or work under the terms of Section 1 above, provided that you also meet all of these conditions:

- a) The modified work must itself be a software library.
- b) You must cause the files modified to carry prominent notices stating that you changed the files and the date of any change.
- c) You must cause the whole of the work to be licensed at no charge to all third parties under the terms of this License.
- d) If a facility in the modified Library refers to a function or a table of data to be supplied by an application program that uses the facility, other than as an argument passed when the facility is invoked, then you must make a good faith effort to ensure that, in the event an application does not supply such function or table, the facility still operates, and performs whatever part of its purpose remains meaningful.

(For example, a function in a library to compute square roots has a purpose that is entirely well-defined independent of the application. Therefore, Subsection 2d

requires that any application-supplied function or table used by this function must be optional: if the application does not supply it, the square root function must still compute square roots.)

These requirements apply to the modified work as a whole. If identifiable sections of that work are not derived from the Library, and can be reasonably considered independent and separate works in themselves, then this License, and its terms, do not apply to those sections when you distribute them as separate works. But when you distribute the same sections as part of a whole which is a work based on the Library, the distribution of the whole must be on the terms of this License, whose permissions for other licensees extend to the entire whole, and thus to each and every part regardless of who wrote it.

Thus, it is not the intent of this section to claim rights or contest your rights to work written entirely by you; rather, the intent is to exercise the right to control the distribution of derivative or collective works based on the Library.

In addition, mere aggregation of another work not based on the Library with the Library (or with a work based on the Library) on a volume of a storage or distribution medium does not bring the other work under the scope of this License.

3. You may opt to apply the terms of the ordinary GNU General Public License instead of this License to a given copy of the Library. To do this, you must alter all the

notices that refer to this License, so that they refer to the ordinary GNU General Public License, version 2, instead of to this License. (If a newer version than version 2 of the ordinary GNU General Public License has appeared, then you can specify that version instead if you wish.) Do not make any other change in these notices.

Once this change is made in a given copy, it is irreversible for that copy, so the ordinary GNU General Public License applies to all subsequent copies and derivative works made from that copy.

This option is useful when you wish to copy part of the code of the Library into a program that is not a library.

4. You may copy and distribute the Library (or a portion or derivative of it, under Section 2) in object code or executable form under the terms of Sections 1 and 2 above provided that you accompany it with the complete corresponding machine-readable source code, which must be distributed under the terms of Sections 1 and 2 above on a medium customarily used for software interchange.

If distribution of object code is made by offering access to copy from a designated place, then offering equivalent access to copy the source code from the same place satisfies the requirement to distribute the source code, even though third parties are not compelled to copy the source along with the object code.

5. A program that contains no derivative of any portion of the Library, but is designed to work with the Library by being compiled or linked with it, is called a "work that uses the Library". Such a work, in isolation, is not a derivative work of the Library, and therefore falls outside the scope of this License.

However, linking a "work that uses the Library" with the Library creates an executable that is a derivative of the Library (because it contains portions of the Library), rather than a "work that uses the library". The executable is therefore covered by this License. Section 6 states terms for distribution of such executables.

When a "work that uses the Library" uses material from a header file that is part of the Library, the object code for the work may be a derivative work of the Library even though the source code is not. Whether this is true is especially significant if the work can be linked without the Library, or if the work is itself a library. The threshold for this to be true is not precisely defined by law.

If such an object file uses only numerical parameters, data structure layouts and accessors, and small macros and small inline functions (ten lines or less in length), then the use of the object file is unrestricted, regardless of whether it is legally a derivative work. (Executables containing this object code plus portions of the Library will still fall under Section 6.)

Otherwise, if the work is a derivative of the Library, you may distribute the object code for the work under the terms of Section 6. Any executables containing that work also fall under Section 6, whether or not they are linked directly with the Library itself.

6. As an exception to the Sections above, you may also combine or link a "work that uses the Library" with the Library to produce a work containing portions of the Library, and distribute that work under terms of your choice, provided that the terms permit modification of the work for the customer's own use and reverse engineering for debugging such modifications.

You must give prominent notice with each copy of the work that the Library is used in it and that the Library and its use are covered by this License. You must supply a copy of this License. If the work during execution displays copyright notices, you must include the copyright notice for the Library among them, as well as a reference directing the user to the copy of this License. Also, you must do one of these things:

- a) Accompany the work with the complete corresponding machine-readable source code for the Library including whatever changes were used in the work (which must be distributed under Sections 1 and 2 above); and, if the work is an executable linked with the Library, with the complete machine-readable "work that uses the Library", as object code and/or source code, so that the user can modify the Library

and then relink to produce a modified executable containing the modified Library. (It is understood that the user who changes the contents of definitions files in the Library will not necessarily be able to recompile the application to use the modified definitions.)

- b) Use a suitable shared library mechanism for linking with the Library. A suitable mechanism is one that (1) uses at run time a copy of the library already present on the user's computer system, rather than copying library functions into the executable, and (2) will operate properly with a modified version of the library, if the user installs one, as long as the modified version is interface-compatible with the version that the work was made with.
- c) Accompany the work with a written offer, valid for at least three years, to give the same user the materials specified in Subsection 6a, above, for a charge no more than the cost of performing this distribution.
- d) If distribution of the work is made by offering access to copy from a designated place, offer equivalent access to copy the above specified materials from the same place.
- e) Verify that the user has already received a copy of these materials or that you have already sent this user a copy.

For an executable, the required form of the "work that uses the Library" must include any data and utility programs needed for reproducing the executable from it.

However, as a special exception, the materials to be distributed need not include anything that is normally distributed (in either source or binary form) with the major components (compiler, kernel, and so on) of the operating system on which the executable runs, unless that component itself accompanies the executable.

It may happen that this requirement contradicts the license restrictions of other proprietary libraries that do not normally accompany the operating system. Such a contradiction means you cannot use both them and the Library together in an executable that you distribute.

7. You may place library facilities that are a work based on the Library side-by-side in a single library together with other library facilities not covered by this License, and distribute such a combined library, provided that the separate distribution of the work based on the Library and of the other library facilities is otherwise permitted, and provided that you do these two things:

- a) Accompany the combined library with a copy of the same work based on the Library, uncombined with any other library facilities. This must be distributed under the terms of the Sections above.

· b) Give prominent notice with the combined library of the fact that part of it is a work based on the Library, and explaining where to find the accompanying uncombined form of the same work.

8. You may not copy, modify, sublicense, link with, or distribute the Library except as expressly provided under this License. Any attempt otherwise to copy, modify, sublicense, link with, or distribute the Library is void, and will automatically terminate your rights under this License. However, parties who have received copies, or rights, from you under this License will not have their licenses terminated so long as such parties remain in full compliance.

9. You are not required to accept this License, since you have not signed it. However, nothing else grants you permission to modify or distribute the Library or its derivative works. These actions are prohibited by law if you do not accept this License. Therefore, by modifying or distributing the Library (or any work based on the Library), you indicate your acceptance of this License to do so, and all its terms and conditions for copying, distributing or modifying the Library or works based on it.

10. Each time you redistribute the Library (or any work based on the Library), the recipient automatically receives a license from the original licensor to copy, distribute, link with or modify the Library subject to these terms and conditions. You

may not impose any further restrictions on the recipients' exercise of the rights granted herein. You are not responsible for enforcing compliance by third parties with this License.

11. If, as a consequence of a court judgment or allegation of patent infringement or for any other reason (not limited to patent issues), conditions are imposed on you (whether by court order, agreement or otherwise) that contradict the conditions of this License, they do not excuse you from the conditions of this License. If you cannot distribute so as to satisfy simultaneously your obligations under this License and any other pertinent obligations, then as a consequence you may not distribute the Library at all. For example, if a patent license would not permit royalty-free redistribution of the Library by all those who receive copies directly or indirectly through you, then the only way you could satisfy both it and this License would be to refrain entirely from distribution of the Library.

If any portion of this section is held invalid or unenforceable under any particular circumstance, the balance of the section is intended to apply, and the section as a whole is intended to apply in other circumstances.

It is not the purpose of this section to induce you to infringe any patents or other property right claims or to contest validity of any such claims; this section has the sole purpose of protecting the integrity of the free software distribution system

which is implemented by public license practices. Many people have made generous contributions to the wide range of software distributed through that system in reliance on consistent application of that system; it is up to the author/donor to decide if he or she is willing to distribute software through any other system and a licensee cannot impose that choice.

This section is intended to make thoroughly clear what is believed to be a consequence of the rest of this License.

12. If the distribution and/or use of the Library is restricted in certain countries either by patents or by copyrighted interfaces, the original copyright holder who places the Library under this License may add an explicit geographical distribution limitation excluding those countries, so that distribution is permitted only in or among countries not thus excluded. In such case, this License incorporates the limitation as if written in the body of this License.

13. The Free Software Foundation may publish revised and/or new versions of the Lesser General Public License from time to time. Such new versions will be similar in spirit to the present version, but may differ in detail to address new problems or concerns.

Each version is given a distinguishing version number. If the Library specifies a version number of this License which applies to it and "any later version", you have

the option of following the terms and conditions either of that version or of any later version published by the Free Software Foundation. If the Library does not specify a license version number, you may choose any version ever published by the Free Software Foundation.

14. If you wish to incorporate parts of the Library into other free programs whose distribution conditions are incompatible with these, write to the author to ask for permission. For software which is copyrighted by the Free Software Foundation, write to the Free Software Foundation; we sometimes make exceptions for this. Our decision will be guided by the two goals of preserving the free status of all derivatives of our free software and of promoting the sharing and reuse of software generally.

NO WARRANTY

15. BECAUSE THE LIBRARY IS LICENSED FREE OF CHARGE, THERE IS NO WARRANTY FOR THE LIBRARY, TO THE EXTENT PERMITTED BY APPLICABLE LAW. EXCEPT WHEN OTHERWISE STATED IN WRITING THE COPYRIGHT HOLDERS AND/OR OTHER PARTIES PROVIDE THE LIBRARY "AS IS" WITHOUT WARRANTY OF ANY KIND, EITHER EXPRESSED OR IMPLIED, INCLUDING, BUT NOT LIMITED TO, THE IMPLIED WARRANTIES OF MERCHANTABILITY AND FITNESS FOR A PARTICULAR PURPOSE. THE ENTIRE RISK AS TO THE QUALITY AND PERFORMANCE OF THE LIBRARY IS WITH YOU. SHOULD THE

LIBRARY PROVE DEFECTIVE, YOU ASSUME THE COST OF ALL NECESSARY SERVICING, REPAIR OR CORRECTION.

16. IN NO EVENT UNLESS REQUIRED BY APPLICABLE LAW OR AGREED TO IN WRITING WILL ANY COPYRIGHT HOLDER, OR ANY OTHER PARTY WHO MAY MODIFY AND/OR REDISTRIBUTE THE LIBRARY AS PERMITTED ABOVE, BE LIABLE TO YOU FOR DAMAGES, INCLUDING ANY GENERAL, SPECIAL, INCIDENTAL OR CONSEQUENTIAL DAMAGES ARISING OUT OF THE USE OR INABILITY TO USE THE LIBRARY (INCLUDING BUT NOT LIMITED TO LOSS OF DATA OR DATA BEING RENDERED INACCURATE OR LOSSES SUSTAINED BY YOU OR THIRD PARTIES OR A FAILURE OF THE LIBRARY TO OPERATE WITH ANY OTHER SOFTWARE), EVEN IF SUCH HOLDER OR OTHER PARTY HAS BEEN ADVISED OF THE POSSIBILITY OF SUCH DAMAGES.

END OF TERMS AND CONDITIONS

How to Apply These Terms to Your New Libraries

If you develop a new library, and you want it to be of the greatest possible use to the public, we recommend making it free software that everyone can redistribute and change. You can do so by permitting redistribution under these terms (or, alternatively, under the terms of the ordinary General Public License).

To apply these terms, attach the following notices to the library. It is safest to attach them to the start of each source file to most effectively convey the exclusion of

warranty; and each file should have at least the "copyright" line and a pointer to where the full notice is found.

one line to give the library's name and an idea of what it does.

Copyright (C) year name of author

This library is free software; you can redistribute it and/or modify it under the terms of the GNU Lesser General Public License as published by the Free Software Foundation; either version 2.1 of the License, or (at your option) any later version.

This library is distributed in the hope that it will be useful, but WITHOUT ANY WARRANTY; without even the implied warranty of MERCHANTABILITY or FITNESS FOR A PARTICULAR PURPOSE. See the GNU Lesser General Public License for more details.

You should have received a copy of the GNU Lesser General Public License along with this library; if not, write to the Free Software Foundation, Inc., 51 Franklin Street, Fifth Floor, Boston, MA 02110-1301 USA

Also add information on how to contact you by electronic and paper mail.

You should also get your employer (if you work as a programmer) or your school, if any, to sign a "copyright disclaimer" for the library, if necessary. Here is a sample; alter the names:

Yoyodyne, Inc., hereby disclaims all copyright interest in
the library `Frob' (a library for tweaking knobs) written
by James Random Hacker.

signature of Ty Coon, 1 April 1990

Ty Coon, President of Vice

That's all there is to it!

84.gst--plugins-base

GNU LESSER GENERAL PUBLIC LICENSE

Version 2.1, February 1999

Copyright (C) 1991, 1999 Free Software Foundation, Inc.

51 Franklin Street, Fifth Floor, Boston, MA 02110-1301 USA

Everyone is permitted to copy and distribute verbatim copies of this license document, but changing it is not allowed.

[This is the first released version of the Lesser GPL. It also counts as the successor of the GNU Library Public License, version 2, hence the version number 2.1.]

Preamble

The licenses for most software are designed to take away your freedom to share and change it. By contrast, the GNU General Public Licenses are intended to guarantee your freedom to share and change free software--to make sure the software is free for all its users.

This license, the Lesser General Public License, applies to some specially designated software packages--typically libraries--of the Free Software Foundation and other authors who decide to use it. You can use it too, but we suggest you first think carefully about whether this license or the ordinary General Public License is the better strategy to use in any particular case, based on the explanations below.

When we speak of free software, we are referring to freedom of use, not price. Our General Public Licenses are designed to make sure that you have the freedom to distribute copies of free software (and charge for this service if you wish); that you receive source code or can get it if you want it; that you can change the software and use pieces of it in new free programs; and that you are informed that you can do these things.

To protect your rights, we need to make restrictions that forbid distributors to deny you these rights or to ask you to surrender these rights. These restrictions translate to certain responsibilities for you if you distribute copies of the library or if you modify it.

For example, if you distribute copies of the library, whether gratis or for a fee, you must give the recipients all the rights that we gave you. You must make sure that they, too, receive or can get the source code. If you link other code with the library, you must provide complete object files to the recipients, so that they can relink them with the library after making changes to the library and recompiling it. And you must show them these terms so they know their rights.

We protect your rights with a two-step method: (1) we copyright the library, and (2) we offer you this license, which gives you legal permission to copy, distribute and/or modify the library.

To protect each distributor, we want to make it very clear that there is no warranty for the free library. Also, if the library is modified by someone else and passed on, the recipients should know that what they

have is not the original version, so that the original author's reputation will not be affected by problems that might be introduced by others.

Finally, software patents pose a constant threat to the existence of any free program. We wish to make sure that a company cannot effectively restrict the users of a free program by obtaining a restrictive license from a patent holder. Therefore, we insist that any patent license obtained for a version of the library must be consistent with the full freedom of use specified in this license.

Most GNU software, including some libraries, is covered by the ordinary GNU General Public License. This license, the GNU Lesser General Public License, applies to certain designated libraries, and is quite different from the ordinary General Public License. We use this license for certain libraries in order to permit linking those libraries into non-free programs.

When a program is linked with a library, whether statically or using a shared library, the combination of the two is legally speaking a combined work, a derivative of the original library. The ordinary General Public License therefore permits such linking only if the entire combination fits its criteria of freedom.

The Lesser General Public License permits more lax criteria for linking other code with the library.

We call this license the "Lesser" General Public License because it does Less to protect the user's freedom than the ordinary General Public License. It also provides other free software developers Less of an advantage over competing non-free programs. These disadvantages are the reason we use the ordinary General Public License for many libraries. However, the Lesser license provides advantages in certain special circumstances.

For example, on rare occasions, there may be a special need to encourage the widest possible use of a certain library, so that it becomes a de-facto standard. To achieve this, non-free programs must be allowed to use the library. A more frequent case is that a free library does the same job as widely used non-free libraries. In this case, there is little to gain by limiting the free library to free software only, so we use the Lesser General Public License.

In other cases, permission to use a particular library in non-free programs enables a greater number of people to use a large body of free software. For example, permission to use the GNU C Library in non-free programs enables many more people to use the whole GNU operating system, as well as its variant, the GNU/Linux operating system.

Although the Lesser General Public License is Less protective of the users' freedom, it does ensure that the user of a program that is linked with the Library has the freedom and the wherewithal to run that program using a modified version of the Library.

The precise terms and conditions for copying, distribution and modification follow. Pay close attention to the difference between a "work based on the library" and a "work that uses the library". The former contains code derived from the library, whereas the latter must be combined with the library in order to run.

TERMS AND CONDITIONS FOR COPYING, DISTRIBUTION AND MODIFICATION

0. This License Agreement applies to any software library or other program which contains a notice placed by the copyright holder or other authorized party saying it may be distributed under the terms of this Lesser General Public License (also called "this License"). Each licensee is addressed as "you".

A "library" means a collection of software functions and/or data prepared so as to be conveniently linked with application programs (which use some of those functions and data) to form executables.

The "Library", below, refers to any such software library or work which has been distributed under these terms. A "work based on the Library" means either the Library or any derivative work under copyright law: that is to say, a work containing the Library or a portion of it, either verbatim or with modifications and/or translated straightforwardly into another language. (Hereinafter, translation is included without limitation in the term "modification".)

"Source code" for a work means the preferred form of the work for making modifications to it. For a library, complete source code means all the source code for all modules it contains, plus any associated interface definition files, plus the scripts used to control compilation and installation of the library.

Activities other than copying, distribution and modification are not covered by this License; they are outside its scope. The act of running a program using the Library is not restricted, and output from such a program is covered only if its contents constitute a work based on the Library (independent of the use of the Library in a tool for writing it). Whether that is true depends on what the Library does and what the program that uses the Library does.

1. You may copy and distribute verbatim copies of the Library's complete source code as you receive it, in any medium, provided that you conspicuously and appropriately publish on each copy an appropriate copyright notice and disclaimer of warranty; keep intact all the notices that refer to this License and to the absence of any warranty; and distribute a copy of this License along with the Library.

You may charge a fee for the physical act of transferring a copy, and you may at your option offer warranty protection in exchange for a fee.

2. You may modify your copy or copies of the Library or any portion of it, thus forming a work based on the Library, and copy and distribute such modifications or work under the terms of Section 1 above, provided that you also meet all of these conditions:

- a) The modified work must itself be a software library.
- b) You must cause the files modified to carry prominent notices stating that you changed the files and the date of any change.
- c) You must cause the whole of the work to be licensed at no charge to all third parties under the terms of this License.
- d) If a facility in the modified Library refers to a function or a table of data to be supplied by an application program that uses the facility, other than as an argument passed when the facility is invoked, then you must make a good faith effort to ensure that, in the event an application does not supply such function or table, the facility still operates, and performs whatever part of its purpose remains meaningful. (For example, a function in a library to compute square roots has a purpose that is entirely well-defined independent of the application. Therefore, Subsection 2d requires that any application-supplied function

or table used by this function must be optional: if the application does not supply it, the square root function must still compute square roots.)

These requirements apply to the modified work as a whole. If identifiable sections of that work are not derived from the Library, and can be reasonably considered independent and separate works in themselves, then this License, and its terms, do not apply to those sections when you distribute them as separate works. But when you distribute the same sections as part of a whole which is a work based on the Library, the distribution of the whole must be on the terms of this License, whose permissions for other licensees extend to the entire whole, and thus to each and every part regardless of who wrote it.

Thus, it is not the intent of this section to claim rights or contest your rights to work written entirely by you; rather, the intent is to exercise the right to control the distribution of derivative or collective works based on the Library.

In addition, mere aggregation of another work not based on the Library with the Library (or with a work based on the Library) on a volume of a storage or distribution medium does not bring the other work under the scope of this License.

3. You may opt to apply the terms of the ordinary GNU General Public License instead of this License to a given copy of the Library. To do this, you must alter all the notices that refer to this License, so that they refer to the ordinary GNU General Public License, version 2, instead of to this License. (If a newer version than version 2 of the ordinary GNU General Public License has appeared, then you can specify that version instead if you wish.) Do not make any other change in these notices.

Once this change is made in a given copy, it is irreversible for that copy, so the ordinary GNU General Public License applies to all subsequent copies and derivative works made from that copy.

This option is useful when you wish to copy part of the code of the Library into a program that is not a library.

4. You may copy and distribute the Library (or a portion or derivative of it, under Section 2) in object code or executable form under the terms of Sections 1 and 2 above provided that you accompany it with the complete corresponding machine-readable source code, which must be distributed under the terms of Sections 1 and 2 above on a medium customarily used for software interchange.

If distribution of object code is made by offering access to copy from a designated place, then offering equivalent access to copy the source code from the same place satisfies the requirement to distribute the source code, even though third parties are not compelled to copy the source along with the object code.

5. A program that contains no derivative of any portion of the Library, but is designed to work with the Library by being compiled or linked with it, is called a "work that uses the Library". Such a work, in isolation, is not a derivative work of the Library, and therefore falls outside the scope of this License.

However, linking a "work that uses the Library" with the Library creates an executable that is a derivative of the Library (because it contains portions of the Library), rather than a "work that uses the library". The executable is therefore covered by this License. Section 6 states terms for distribution of such executables. When a "work that uses the Library" uses material from a header file that is part of the Library, the object code for the work may be a derivative work of the Library even though the source code is not. Whether

this is true is especially significant if the work can be linked without the Library, or if the work is itself a library. The threshold for this to be true is not precisely defined by law.

If such an object file uses only numerical parameters, data structure layouts and accessors, and small macros and small inline functions (ten lines or less in length), then the use of the object file is unrestricted, regardless of whether it is legally a derivative work. (Executables containing this object code plus portions of the Library will still fall under Section 6.)

Otherwise, if the work is a derivative of the Library, you may distribute the object code for the work under the terms of Section 6. Any executables containing that work also fall under Section 6, whether or not they are linked directly with the Library itself.

6. As an exception to the Sections above, you may also combine or link a "work that uses the Library" with the Library to produce a work containing portions of the Library, and distribute that work under terms of your choice, provided that the terms permit modification of the work for the customer's own use and reverse engineering for debugging such modifications.

You must give prominent notice with each copy of the work that the Library is used in it and that the Library and its use are covered by this License. You must supply a copy of this License. If the work during execution displays copyright notices, you must include the copyright notice for the Library among them, as well as a reference directing the user to the copy of this License. Also, you must do one of these things:

- a) Accompany the work with the complete corresponding machine-readable source code for the Library including whatever changes were used in the work (which must be distributed under Sections 1 and 2 above); and, if the work is an executable linked with the Library, with the complete machine-readable "work that uses the Library", as object code and/or source code, so that the user can modify the Library and then relink to produce a modified executable containing the modified Library. (It is understood that the user who changes the contents of definitions files in the Library will not necessarily be able to recompile the application to use the modified definitions.)
- b) Use a suitable shared library mechanism for linking with the Library. A suitable mechanism is one that (1) uses at run time a copy of the library already present on the user's computer system, rather than copying library functions into the executable, and (2) will operate properly with a modified version of the library, if the user installs one, as long as the modified version is interface-compatible with the version that the work was made with.
- c) Accompany the work with a written offer, valid for at least three years, to give the same user the materials specified in Subsection 6a, above, for a charge no more than the cost of performing this distribution.
- d) If distribution of the work is made by offering access to copy from a designated place, offer equivalent access to copy the above specified materials from the same place.
- e) Verify that the user has already received a copy of these materials or that you have already sent this user a copy.

For an executable, the required form of the "work that uses the Library" must include any data and utility programs needed for reproducing the executable from it. However, as a special exception, the materials to

be distributed need not include anything that is normally distributed (in either source or binary form) with the major components (compiler, kernel, and so on) of the operating system on which the executable runs, unless that component itself accompanies the executable.

It may happen that this requirement contradicts the license restrictions of other proprietary libraries that do not normally accompany the operating system. Such a contradiction means you cannot use both them and the Library together in an executable that you distribute.

7. You may place library facilities that are a work based on the Library side-by-side in a single library together with other library facilities not covered by this License, and distribute such a combined library, provided that the separate distribution of the work based on the Library and of the other library facilities is otherwise permitted, and provided that you do these two things:

- a) Accompany the combined library with a copy of the same work based on the Library, uncombined with any other library facilities. This must be distributed under the terms of the Sections above.
- b) Give prominent notice with the combined library of the fact that part of it is a work based on the Library, and explaining where to find the accompanying uncombined form of the same work.

8. You may not copy, modify, sublicense, link with, or distribute the Library except as expressly provided under this License. Any attempt otherwise to copy, modify, sublicense, link with, or distribute the Library is void, and will automatically terminate your rights under this License. However, parties who have received copies, or rights, from you under this License will not have their licenses terminated so long as such parties remain in full compliance.

9. You are not required to accept this License, since you have not signed it. However, nothing else grants you permission to modify or distribute the Library or its derivative works. These actions are prohibited by law if you do not accept this License. Therefore, by modifying or distributing the Library (or any work based on the Library), you indicate your acceptance of this License to do so, and all its terms and conditions for copying, distributing or modifying the Library or works based on it.

10. Each time you redistribute the Library (or any work based on the Library), the recipient automatically receives a license from the original licensor to copy, distribute, link with or modify the Library subject to these terms and conditions. You may not impose any further restrictions on the recipients' exercise of the rights granted herein. You are not responsible for enforcing compliance by third parties with this License.

11. If, as a consequence of a court judgment or allegation of patent infringement or for any other reason (not limited to patent issues), conditions are imposed on you (whether by court order, agreement or otherwise) that contradict the conditions of this License, they do not excuse you from the conditions of this License. If you cannot distribute so as to satisfy simultaneously your obligations under this License and any other pertinent obligations, then as a consequence you may not distribute the Library at all. For example, if a patent license would not permit royalty-free redistribution of the Library by all those who receive copies directly or indirectly through you, then the only way you could satisfy both it and this License would be to refrain entirely from distribution of the Library.

If any portion of this section is held invalid or unenforceable under any particular circumstance, the balance of the section is intended to apply, and the section as a whole is intended to apply in other circumstances.

It is not the purpose of this section to induce you to infringe any patents or other property right claims or to contest validity of any such claims; this section has the sole purpose of protecting the integrity of the free software distribution system which is implemented by public license practices. Many people have made generous contributions to the wide range of software distributed through that system in reliance on consistent application of that system; it is up to the author/donor to decide if he or she is willing to distribute software through any other system and a licensee cannot impose that choice.

This section is intended to make thoroughly clear what is believed to be a consequence of the rest of this License.

12. If the distribution and/or use of the Library is restricted in certain countries either by patents or by copyrighted interfaces, the original copyright holder who places the Library under this License may add an explicit geographical distribution limitation excluding those countries, so that distribution is permitted only in or among countries not thus excluded. In such case, this License incorporates the limitation as if written in the body of this License.

13. The Free Software Foundation may publish revised and/or new versions of the Lesser General Public License from time to time. Such new versions will be similar in spirit to the present version, but may differ in detail to address new problems or concerns.

Each version is given a distinguishing version number. If the Library specifies a version number of this License which applies to it and "any later version", you have the option of following the terms and conditions either of that version or of any later version published by the Free Software Foundation. If the Library does not specify a license version number, you may choose any version ever published by the Free Software Foundation.

14. If you wish to incorporate parts of the Library into other free programs whose distribution conditions are incompatible with these, write to the author to ask for permission. For software which is copyrighted by the Free Software Foundation, write to the Free Software Foundation; we sometimes make exceptions for this. Our decision will be guided by the two goals of preserving the free status of all derivatives of our free software and of promoting the sharing and reuse of software generally.

NO WARRANTY

15. BECAUSE THE LIBRARY IS LICENSED FREE OF CHARGE, THERE IS NO WARRANTY FOR THE LIBRARY, TO THE EXTENT PERMITTED BY APPLICABLE LAW. EXCEPT WHEN OTHERWISE STATED IN WRITING THE COPYRIGHT HOLDERS AND/OR OTHER PARTIES PROVIDE THE LIBRARY "AS IS" WITHOUT WARRANTY OF ANY KIND, EITHER EXPRESSED OR IMPLIED, INCLUDING, BUT NOT LIMITED TO, THE IMPLIED WARRANTIES OF MERCHANTABILITY AND FITNESS FOR A PARTICULAR PURPOSE. THE ENTIRE RISK AS TO THE QUALITY AND PERFORMANCE OF THE LIBRARY IS WITH YOU. SHOULD THE LIBRARY

PROVE DEFECTIVE, YOU ASSUME THE COST OF ALL NECESSARY SERVICING, REPAIR OR CORRECTION.

16. IN NO EVENT UNLESS REQUIRED BY APPLICABLE LAW OR AGREED TO IN WRITING WILL ANY COPYRIGHT HOLDER, OR ANY OTHER PARTY WHO MAY MODIFY AND/OR REDISTRIBUTE THE LIBRARY AS PERMITTED ABOVE, BE LIABLE TO YOU FOR DAMAGES, INCLUDING ANY GENERAL, SPECIAL, INCIDENTAL OR CONSEQUENTIAL DAMAGES ARISING OUT OF THE USE OR INABILITY TO USE THE LIBRARY (INCLUDING BUT NOT LIMITED TO LOSS OF DATA OR DATA BEING RENDERED INACCURATE OR LOSSES SUSTAINED BY YOU OR THIRD PARTIES OR A FAILURE OF THE LIBRARY TO OPERATE WITH ANY OTHER SOFTWARE), EVEN IF SUCH HOLDER OR OTHER PARTY HAS BEEN ADVISED OF THE POSSIBILITY OF SUCH DAMAGES.

END OF TERMS AND CONDITIONS

How to Apply These Terms to Your New Libraries

If you develop a new library, and you want it to be of the greatest possible use to the public, we recommend making it free software that everyone can redistribute and change. You can do so by permitting redistribution under these terms (or, alternatively, under the terms of the ordinary General Public License).

To apply these terms, attach the following notices to the library. It is safest to attach them to the start of each source file to most effectively convey the exclusion of warranty; and each file should have at least the "copyright" line and a pointer to where the full notice is found.

one line to give the library's name and an idea of what it does.

Copyright (C) year name of author

This library is free software; you can redistribute it and/or modify it under the terms of the GNU Lesser General Public License as published by the Free Software Foundation; either version 2.1 of the License, or (at your option) any later version.

This library is distributed in the hope that it will be useful, but WITHOUT ANY WARRANTY; without even the implied warranty of MERCHANTABILITY or FITNESS FOR A PARTICULAR PURPOSE. See the GNU Lesser General Public License for more details.

You should have received a copy of the GNU Lesser General Public License along with this library; if not, write to the Free Software Foundation, Inc., 51 Franklin Street, Fifth Floor, Boston, MA 02110-1301 USA
Also add information on how to contact you by electronic and paper mail.

You should also get your employer (if you work as a programmer) or your school, if any, to sign a "copyright disclaimer" for the library, if necessary. Here is a sample; alter the names:

Yoyodyne, Inc., hereby disclaims all copyright interest in
the library `Frob' (a library for tweaking knobs) written
by James Random Hacker.

signature of Ty Coon, 1 April 1990

Ty Coon, President of Vice

That's all there is to it!

Copyright (c) 2003-2004, Mark Borgerding

All rights reserved.

Redistribution and use in source and binary forms, with or without modification, are permitted provided that the following conditions are met:

- * Redistributions of source code must retain the above copyright notice, this list of conditions and the following disclaimer.
- * Redistributions in binary form must reproduce the above copyright notice, this list of conditions and the following disclaimer in the documentation and/or other materials provided with the distribution.
- * Neither the author nor the names of any contributors may be used to endorse or promote products derived from this software without specific prior written permission.

THIS SOFTWARE IS PROVIDED BY THE COPYRIGHT HOLDERS AND CONTRIBUTORS "AS IS" AND ANY EXPRESS OR IMPLIED WARRANTIES, INCLUDING, BUT NOT LIMITED TO, THE IMPLIED WARRANTIES OF MERCHANTABILITY AND FITNESS FOR A PARTICULAR PURPOSE ARE DISCLAIMED. IN NO EVENT SHALL THE COPYRIGHT OWNER OR CONTRIBUTORS BE LIABLE FOR ANY DIRECT, INDIRECT, INCIDENTAL, SPECIAL, EXEMPLARY, OR CONSEQUENTIAL DAMAGES (INCLUDING, BUT NOT LIMITED TO, PROCUREMENT OF SUBSTITUTE GOODS OR SERVICES; LOSS OF USE, DATA, OR PROFITS; OR BUSINESS INTERRUPTION) HOWEVER CAUSED AND ON ANY THEORY OF LIABILITY, WHETHER IN CONTRACT, STRICT LIABILITY, OR TORT (INCLUDING NEGLIGENCE OR OTHERWISE) ARISING IN ANY WAY OUT OF THE USE OF THIS SOFTWARE, EVEN IF ADVISED OF THE POSSIBILITY OF SUCH DAMAGE.

* Image Scaling Functions (4 tap)
* Copyright (c) 2005 David A. Schleef <ds@schleef.org>
* Copyright (c) 2009 Sebastian Dröge <sebastian.droege@collabora.co.uk>
* All rights reserved.
*
* Redistribution and use in source and binary forms, with or without
* modification, are permitted provided that the following conditions
* are met:
* 1. Redistributions of source code must retain the above copyright
* notice, this list of conditions and the following disclaimer.
* 2. Redistributions in binary form must reproduce the above copyright
* notice, this list of conditions and the following disclaimer in the
* documentation and/or other materials provided with the distribution.
*
* THIS SOFTWARE IS PROVIDED BY THE AUTHOR ``AS IS'' AND ANY EXPRESS OR
* IMPLIED WARRANTIES, INCLUDING, BUT NOT LIMITED TO, THE IMPLIED
* WARRANTIES OF MERCHANTABILITY AND FITNESS FOR A PARTICULAR PURPOSE
* ARE DISCLAIMED. IN NO EVENT SHALL THE AUTHOR BE LIABLE FOR ANY DIRECT,
* INDIRECT, INCIDENTAL, SPECIAL, EXEMPLARY, OR CONSEQUENTIAL DAMAGES
* (INCLUDING, BUT NOT LIMITED TO, PROCUREMENT OF SUBSTITUTE GOODS OR
* SERVICES; LOSS OF USE, DATA, OR PROFITS; OR BUSINESS INTERRUPTION)
* HOWEVER CAUSED AND ON ANY THEORY OF LIABILITY, WHETHER IN CONTRACT,
* STRICT LIABILITY, OR TORT (INCLUDING NEGLIGENCE OR OTHERWISE) ARISING
* IN ANY WAY OUT OF THE USE OF THIS SOFTWARE, EVEN IF ADVISED OF THE
* POSSIBILITY OF SUCH DAMAGE.

* Image Scaling Functions (4 tap)
* Copyright (c) 2005 David A. Schleef <ds@schleef.org>
* All rights reserved.
*
* Redistribution and use in source and binary forms, with or without
* modification, are permitted provided that the following conditions
* are met:
* 1. Redistributions of source code must retain the above copyright
* notice, this list of conditions and the following disclaimer.
* 2. Redistributions in binary form must reproduce the above copyright
* notice, this list of conditions and the following disclaimer in the

* documentation and/or other materials provided with the distribution.

*

* THIS SOFTWARE IS PROVIDED BY THE AUTHOR ``AS IS" AND ANY EXPRESS OR
* IMPLIED WARRANTIES, INCLUDING, BUT NOT LIMITED TO, THE IMPLIED
* WARRANTIES OF MERCHANTABILITY AND FITNESS FOR A PARTICULAR PURPOSE
* ARE DISCLAIMED. IN NO EVENT SHALL THE AUTHOR BE LIABLE FOR ANY DIRECT,
* INDIRECT, INCIDENTAL, SPECIAL, EXEMPLARY, OR CONSEQUENTIAL DAMAGES
* (INCLUDING, BUT NOT LIMITED TO, PROCUREMENT OF SUBSTITUTE GOODS OR
* SERVICES; LOSS OF USE, DATA, OR PROFITS; OR BUSINESS INTERRUPTION)
* HOWEVER CAUSED AND ON ANY THEORY OF LIABILITY, WHETHER IN CONTRACT,
* STRICT LIABILITY, OR TORT (INCLUDING NEGLIGENCE OR OTHERWISE) ARISING
* IN ANY WAY OUT OF THE USE OF THIS SOFTWARE, EVEN IF ADVISED OF THE
* POSSIBILITY OF SUCH DAMAGE.

* Image Scaling Functions

* Copyright (c) 2010 Sebastian Dröge <sebastian.droege@collabora.co.uk>

* All rights reserved.

*

* Redistribution and use in source and binary forms, with or without
* modification, are permitted provided that the following conditions
* are met:

* 1. Redistributions of source code must retain the above copyright
* notice, this list of conditions and the following disclaimer.

* 2. Redistributions in binary form must reproduce the above copyright
* notice, this list of conditions and the following disclaimer in the
* documentation and/or other materials provided with the distribution.

*

* THIS SOFTWARE IS PROVIDED BY THE AUTHOR ``AS IS" AND ANY EXPRESS OR
* IMPLIED WARRANTIES, INCLUDING, BUT NOT LIMITED TO, THE IMPLIED
* WARRANTIES OF MERCHANTABILITY AND FITNESS FOR A PARTICULAR PURPOSE
* ARE DISCLAIMED. IN NO EVENT SHALL THE AUTHOR BE LIABLE FOR ANY DIRECT,
* INDIRECT, INCIDENTAL, SPECIAL, EXEMPLARY, OR CONSEQUENTIAL DAMAGES
* (INCLUDING, BUT NOT LIMITED TO, PROCUREMENT OF SUBSTITUTE GOODS OR
* SERVICES; LOSS OF USE, DATA, OR PROFITS; OR BUSINESS INTERRUPTION)
* HOWEVER CAUSED AND ON ANY THEORY OF LIABILITY, WHETHER IN CONTRACT,
* STRICT LIABILITY, OR TORT (INCLUDING NEGLIGENCE OR OTHERWISE) ARISING
* IN ANY WAY OUT OF THE USE OF THIS SOFTWARE, EVEN IF ADVISED OF THE

* POSSIBILITY OF SUCH DAMAGE.

85.iproute

GNU GENERAL PUBLIC LICENSE

Version 2, June 1991

Copyright (C) 1989, 1991 Free Software Foundation, Inc.

51 Franklin St, Fifth Floor, Boston, MA 02110-1301 USA

Everyone is permitted to copy and distribute verbatim copies of this license document, but changing it is not allowed.

Preamble

The licenses for most software are designed to take away your freedom to share and change it. By contrast, the GNU General Public License is intended to guarantee your freedom to share and change free software--to make sure the software is free for all its users. This General Public License applies to most of the Free Software Foundation's software and to any other program whose authors commit to using it. (Some other Free Software Foundation software is covered by the GNU Library General Public License instead.) You can apply it to your programs, too.

When we speak of free software, we are referring to freedom, not price. Our General Public Licenses are designed to make sure that you have the freedom to distribute copies of free software (and charge for this service if you wish), that you receive source code or can get it if you want it, that you can change the software or use pieces of it in new free programs; and that you know you can do these things.

To protect your rights, we need to make restrictions that forbid anyone to deny you these rights or to ask you to surrender the rights. These restrictions translate to certain responsibilities for you if you distribute copies of the software, or if you modify it.

For example, if you distribute copies of such a program, whether gratis or for a fee, you must give the recipients all the rights that you have. You must make sure that they, too, receive or can get the

source code. And you must show them these terms so they know their rights.

We protect your rights with two steps: (1) copyright the software, and (2) offer you this license which gives you legal permission to copy, distribute and/or modify the software.

Also, for each author's protection and ours, we want to make certain that everyone understands that there is no warranty for this free software. If the software is modified by someone else and passed on, we want its recipients to know that what they have is not the original, so that any problems introduced by others will not reflect on the original authors' reputations.

Finally, any free program is threatened constantly by software patents. We wish to avoid the danger that redistributors of a free program will individually obtain patent licenses, in effect making the program proprietary. To prevent this, we have made it clear that any patent must be licensed for everyone's free use or not licensed at all.

The precise terms and conditions for copying, distribution and modification follow.

GNU GENERAL PUBLIC LICENSE

TERMS AND CONDITIONS FOR COPYING, DISTRIBUTION AND MODIFICATION

0. This License applies to any program or other work which contains a notice placed by the copyright holder saying it may be distributed under the terms of this General Public License. The "Program", below, refers to any such program or work, and a "work based on the Program" means either the Program or any derivative work under copyright law: that is to say, a work containing the Program or a portion of it, either verbatim or with modifications and/or translated into another language. (Hereinafter, translation is included without limitation in the term "modification".) Each licensee is addressed as "you".

Activities other than copying, distribution and modification are not covered by this License; they are outside its scope. The act of

running the Program is not restricted, and the output from the Program is covered only if its contents constitute a work based on the Program (independent of having been made by running the Program). Whether that is true depends on what the Program does.

1. You may copy and distribute verbatim copies of the Program's source code as you receive it, in any medium, provided that you conspicuously and appropriately publish on each copy an appropriate copyright notice and disclaimer of warranty; keep intact all the notices that refer to this License and to the absence of any warranty; and give any other recipients of the Program a copy of this License along with the Program.

You may charge a fee for the physical act of transferring a copy, and you may at your option offer warranty protection in exchange for a fee.

2. You may modify your copy or copies of the Program or any portion of it, thus forming a work based on the Program, and copy and distribute such modifications or work under the terms of Section 1 above, provided that you also meet all of these conditions:

a) You must cause the modified files to carry prominent notices stating that you changed the files and the date of any change.

b) You must cause any work that you distribute or publish, that in whole or in part contains or is derived from the Program or any part thereof, to be licensed as a whole at no charge to all third parties under the terms of this License.

c) If the modified program normally reads commands interactively when run, you must cause it, when started running for such interactive use in the most ordinary way, to print or display an announcement including an appropriate copyright notice and a notice that there is no warranty (or else, saying that you provide a warranty) and that users may redistribute the program under these conditions, and telling the user how to view a copy of this License. (Exception: if the Program itself is interactive but does not normally print such an announcement, your work based on

the Program is not required to print an announcement.)

These requirements apply to the modified work as a whole. If identifiable sections of that work are not derived from the Program, and can be reasonably considered independent and separate works in themselves, then this License, and its terms, do not apply to those sections when you distribute them as separate works. But when you distribute the same sections as part of a whole which is a work based on the Program, the distribution of the whole must be on the terms of this License, whose permissions for other licensees extend to the entire whole, and thus to each and every part regardless of who wrote it.

Thus, it is not the intent of this section to claim rights or contest your rights to work written entirely by you; rather, the intent is to exercise the right to control the distribution of derivative or collective works based on the Program.

In addition, mere aggregation of another work not based on the Program with the Program (or with a work based on the Program) on a volume of a storage or distribution medium does not bring the other work under the scope of this License.

3. You may copy and distribute the Program (or a work based on it, under Section 2) in object code or executable form under the terms of Sections 1 and 2 above provided that you also do one of the following:

- a) Accompany it with the complete corresponding machine-readable source code, which must be distributed under the terms of Sections 1 and 2 above on a medium customarily used for software interchange; or,
- b) Accompany it with a written offer, valid for at least three years, to give any third party, for a charge no more than your cost of physically performing source distribution, a complete machine-readable copy of the corresponding source code, to be distributed under the terms of Sections 1 and 2 above on a medium customarily used for software interchange; or,
- c) Accompany it with the information you received as to the offer

to distribute corresponding source code. (This alternative is allowed only for noncommercial distribution and only if you received the program in object code or executable form with such an offer, in accord with Subsection b above.)

The source code for a work means the preferred form of the work for making modifications to it. For an executable work, complete source code means all the source code for all modules it contains, plus any associated interface definition files, plus the scripts used to control compilation and installation of the executable. However, as a special exception, the source code distributed need not include anything that is normally distributed (in either source or binary form) with the major components (compiler, kernel, and so on) of the operating system on which the executable runs, unless that component itself accompanies the executable.

If distribution of executable or object code is made by offering access to copy from a designated place, then offering equivalent access to copy the source code from the same place counts as distribution of the source code, even though third parties are not compelled to copy the source along with the object code.

4. You may not copy, modify, sublicense, or distribute the Program except as expressly provided under this License. Any attempt otherwise to copy, modify, sublicense or distribute the Program is void, and will automatically terminate your rights under this License. However, parties who have received copies, or rights, from you under this License will not have their licenses terminated so long as such parties remain in full compliance.

5. You are not required to accept this License, since you have not signed it. However, nothing else grants you permission to modify or distribute the Program or its derivative works. These actions are prohibited by law if you do not accept this License. Therefore, by modifying or distributing the Program (or any work based on the Program), you indicate your acceptance of this License to do so, and all its terms and conditions for copying, distributing or modifying the Program or works based on it.

6. Each time you redistribute the Program (or any work based on the Program), the recipient automatically receives a license from the original licensor to copy, distribute or modify the Program subject to these terms and conditions. You may not impose any further restrictions on the recipients' exercise of the rights granted herein. You are not responsible for enforcing compliance by third parties to this License.

7. If, as a consequence of a court judgment or allegation of patent infringement or for any other reason (not limited to patent issues), conditions are imposed on you (whether by court order, agreement or otherwise) that contradict the conditions of this License, they do not excuse you from the conditions of this License. If you cannot distribute so as to satisfy simultaneously your obligations under this License and any other pertinent obligations, then as a consequence you may not distribute the Program at all. For example, if a patent license would not permit royalty-free redistribution of the Program by all those who receive copies directly or indirectly through you, then the only way you could satisfy both it and this License would be to refrain entirely from distribution of the Program.

If any portion of this section is held invalid or unenforceable under any particular circumstance, the balance of the section is intended to apply and the section as a whole is intended to apply in other circumstances.

It is not the purpose of this section to induce you to infringe any patents or other property right claims or to contest validity of any such claims; this section has the sole purpose of protecting the integrity of the free software distribution system, which is implemented by public license practices. Many people have made generous contributions to the wide range of software distributed through that system in reliance on consistent application of that system; it is up to the author/donor to decide if he or she is willing to distribute software through any other system and a licensee cannot impose that choice.

This section is intended to make thoroughly clear what is believed to be a consequence of the rest of this License.

8. If the distribution and/or use of the Program is restricted in certain countries either by patents or by copyrighted interfaces, the original copyright holder who places the Program under this License may add an explicit geographical distribution limitation excluding those countries, so that distribution is permitted only in or among countries not thus excluded. In such case, this License incorporates the limitation as if written in the body of this License.

9. The Free Software Foundation may publish revised and/or new versions of the General Public License from time to time. Such new versions will be similar in spirit to the present version, but may differ in detail to address new problems or concerns.

Each version is given a distinguishing version number. If the Program specifies a version number of this License which applies to it and "any later version", you have the option of following the terms and conditions either of that version or of any later version published by the Free Software Foundation. If the Program does not specify a version number of this License, you may choose any version ever published by the Free Software Foundation.

10. If you wish to incorporate parts of the Program into other free programs whose distribution conditions are different, write to the author to ask for permission. For software which is copyrighted by the Free Software Foundation, write to the Free Software Foundation; we sometimes make exceptions for this. Our decision will be guided by the two goals of preserving the free status of all derivatives of our free software and of promoting the sharing and reuse of software generally.

NO WARRANTY

11. BECAUSE THE PROGRAM IS LICENSED FREE OF CHARGE, THERE IS NO WARRANTY FOR THE PROGRAM, TO THE EXTENT PERMITTED BY APPLICABLE LAW. EXCEPT WHEN OTHERWISE STATED IN WRITING THE COPYRIGHT HOLDERS AND/OR OTHER PARTIES PROVIDE THE PROGRAM "AS IS" WITHOUT WARRANTY OF ANY KIND, EITHER EXPRESSED

OR IMPLIED, INCLUDING, BUT NOT LIMITED TO, THE IMPLIED WARRANTIES OF MERCHANTABILITY AND FITNESS FOR A PARTICULAR PURPOSE. THE ENTIRE RISK AS TO THE QUALITY AND PERFORMANCE OF THE PROGRAM IS WITH YOU. SHOULD THE PROGRAM PROVE DEFECTIVE, YOU ASSUME THE COST OF ALL NECESSARY SERVICING, REPAIR OR CORRECTION.

12. IN NO EVENT UNLESS REQUIRED BY APPLICABLE LAW OR AGREED TO IN WRITING WILL ANY COPYRIGHT HOLDER, OR ANY OTHER PARTY WHO MAY MODIFY AND/OR REDISTRIBUTE THE PROGRAM AS PERMITTED ABOVE, BE LIABLE TO YOU FOR DAMAGES, INCLUDING ANY GENERAL, SPECIAL, INCIDENTAL OR CONSEQUENTIAL DAMAGES ARISING OUT OF THE USE OR INABILITY TO USE THE PROGRAM (INCLUDING BUT NOT LIMITED TO LOSS OF DATA OR DATA BEING RENDERED INACCURATE OR LOSSES SUSTAINED BY YOU OR THIRD PARTIES OR A FAILURE OF THE PROGRAM TO OPERATE WITH ANY OTHER PROGRAMS), EVEN IF SUCH HOLDER OR OTHER PARTY HAS BEEN ADVISED OF THE POSSIBILITY OF SUCH DAMAGES.

END OF TERMS AND CONDITIONS

How to Apply These Terms to Your New Programs

If you develop a new program, and you want it to be of the greatest possible use to the public, the best way to achieve this is to make it free software which everyone can redistribute and change under these terms.

To do so, attach the following notices to the program. It is safest to attach them to the start of each source file to most effectively convey the exclusion of warranty; and each file should have at least the "copyright" line and a pointer to where the full notice is found.

<one line to give the program's name and a brief idea of what it does.>

Copyright (C) <year> <name of author>

This program is free software; you can redistribute it and/or modify it under the terms of the GNU General Public License as published by the Free Software Foundation; either version 2 of the License, or (at your option) any later version.

This program is distributed in the hope that it will be useful,

but WITHOUT ANY WARRANTY; without even the implied warranty of MERCHANTABILITY or FITNESS FOR A PARTICULAR PURPOSE. See the GNU General Public License for more details.

You should have received a copy of the GNU General Public License along with this program; if not, write to the Free Software Foundation, Inc., 51 Franklin St, Fifth Floor, Boston, MA 02110-1301 USA

Also add information on how to contact you by electronic and paper mail.

If the program is interactive, make it output a short notice like this when it starts in an interactive mode:

```
Gnomovision version 69, Copyright (C) year name of author
Gnomovision comes with ABSOLUTELY NO WARRANTY; for details type `show w'.
This is free software, and you are welcome to redistribute it
under certain conditions; type `show c' for details.
```

The hypothetical commands ``show w'` and ``show c'` should show the appropriate parts of the General Public License. Of course, the commands you use may be called something other than ``show w'` and ``show c'`; they could even be mouse-clicks or menu items--whatever suits your program.

You should also get your employer (if you work as a programmer) or your school, if any, to sign a "copyright disclaimer" for the program, if necessary. Here is a sample; alter the names:

```
Yoyodyne, Inc., hereby disclaims all copyright interest in the program
`Gnomovision' (which makes passes at compilers) written by James Hacker.
```

```
<signature of Ty Coon>, 1 April 1989
Ty Coon, President of Vice
```

This General Public License does not permit incorporating your program into proprietary programs. If your program is a subroutine library, you may consider it more useful to permit linking proprietary applications with the library. If this is what you want to do, use the GNU Library General

Public License instead of this License.

* Copyright (c) 1982, 1986, 1993

* The Regents of the University of California. All rights reserved.

*

* Redistribution and use in source and binary forms, with or without

* modification, are permitted provided that the following conditions

* are met:

* 1. Redistributions of source code must retain the above copyright

* notice, this list of conditions and the following disclaimer.

* 2. Redistributions in binary form must reproduce the above copyright

* notice, this list of conditions and the following disclaimer in the

* documentation and/or other materials provided with the distribution.

* 4. Neither the name of the University nor the names of its contributors

* may be used to endorse or promote products derived from this software

* without specific prior written permission.

*

* THIS SOFTWARE IS PROVIDED BY THE REGENTS AND CONTRIBUTORS ``AS IS" AND

* ANY EXPRESS OR IMPLIED WARRANTIES, INCLUDING, BUT NOT LIMITED TO, THE

* IMPLIED WARRANTIES OF MERCHANTABILITY AND FITNESS FOR A PARTICULAR PURPOSE

* ARE DISCLAIMED. IN NO EVENT SHALL THE REGENTS OR CONTRIBUTORS BE LIABLE

* FOR ANY DIRECT, INDIRECT, INCIDENTAL, SPECIAL, EXEMPLARY, OR CONSEQUENTIAL

* DAMAGES (INCLUDING, BUT NOT LIMITED TO, PROCUREMENT OF SUBSTITUTE GOODS

* OR SERVICES; LOSS OF USE, DATA, OR PROFITS; OR BUSINESS INTERRUPTION)

* HOWEVER CAUSED AND ON ANY THEORY OF LIABILITY, WHETHER IN CONTRACT, STRICT

* LIABILITY, OR TORT (INCLUDING NEGLIGENCE OR OTHERWISE) ARISING IN ANY WAY

* OUT OF THE USE OF THIS SOFTWARE, EVEN IF ADVISED OF THE POSSIBILITY OF

* SUCH DAMAGE.

86. Jersey

Eclipse Public License – v 2.0

THE ACCOMPANYING PROGRAM IS PROVIDED UNDER THE TERMS OF THIS ECLIPSE PUBLIC LICENSE ("AGREEMENT"). ANY USE, REPRODUCTION OR DISTRIBUTION OF THE PROGRAM CONSTITUTES RECIPIENT'S ACCEPTANCE OF THIS AGREEMENT.

1. DEFINITIONS

"Contribution" means:

a) in the case of the initial Contributor, the initial content Distributed under this Agreement, and

b) in the case of each subsequent Contributor:

- i) changes to the Program, and
- ii) additions to the Program;

where such changes and/or additions to the Program originate from and are Distributed by that particular Contributor. A Contribution "originates" from a Contributor if it was added to the Program by such Contributor itself or anyone acting on such Contributor's behalf. Contributions do not include changes or additions to the Program that are not Modified Works.

"Contributor" means any person or entity that Distributes the Program.

"Licensed Patents" mean patent claims licensable by a Contributor which are necessarily infringed by the use or sale of its Contribution alone or when combined with the Program.

"Program" means the Contributions Distributed in accordance with this Agreement.

"Recipient" means anyone who receives the Program under this Agreement or any Secondary License (as applicable), including Contributors.

"Derivative Works" shall mean any work, whether in Source Code or other form, that is based on (or derived from) the Program and for which the editorial revisions, annotations, elaborations, or other modifications represent, as a whole, an original work of authorship.

"Modified Works" shall mean any work in Source Code or other form that results from an addition to, deletion from, or modification of the contents of the Program, including, for purposes of clarity any new file in Source Code form that contains any contents of the Program. Modified Works shall not include works that contain only declarations, interfaces, types, classes, structures, or files of the Program solely in each case in order to link to, bind by name, or subclass the Program or Modified Works thereof.

"Distribute" means the acts of a) distributing or b) making available in any manner that enables the transfer of a copy.

"Source Code" means the form of a Program preferred for making modifications, including but not limited to software source code, documentation source, and configuration files.

"Secondary License" means either the GNU General Public License, Version 2.0, or any later versions of that license, including any exceptions or additional permissions as identified by the initial Contributor.

2. GRANT OF RIGHTS

a) Subject to the terms of this Agreement, each Contributor hereby grants Recipient a non-exclusive, worldwide, royalty-free copyright license to reproduce, prepare Derivative Works of, publicly display, publicly perform, Distribute and sublicense the Contribution of such Contributor, if any, and such Derivative Works.

b) Subject to the terms of this Agreement, each Contributor hereby grants Recipient a non-exclusive, worldwide, royalty-free patent license under Licensed Patents to make, use, sell, offer to sell, import and otherwise transfer the Contribution of such Contributor,

if any, in Source Code or other form. This patent license shall apply to the combination of the Contribution and the Program if, at the time the Contribution is added by the Contributor, such addition of the Contribution causes such combination to be covered by the Licensed Patents. The patent license shall not apply to any other combinations which include the Contribution. No hardware per se is licensed hereunder.

c) Recipient understands that although each Contributor grants the licenses to its Contributions set forth herein, no assurances are provided by any Contributor that the Program does not infringe the patent or other intellectual property rights of any other entity. Each Contributor disclaims any liability to Recipient for claims brought by any other entity based on infringement of intellectual property rights or otherwise. As a condition to exercising the rights and licenses granted hereunder, each Recipient hereby assumes sole responsibility to secure any other intellectual property rights needed, if any. For example, if a third party patent license is required to allow Recipient to Distribute the Program, it is Recipient's responsibility to acquire that license before distributing the Program.

d) Each Contributor represents that to its knowledge it has sufficient copyright rights in its Contribution, if any, to grant the copyright license set forth in this Agreement.

e) Notwithstanding the terms of any Secondary License, no Contributor makes additional grants to any Recipient (other than those set forth in this Agreement) as a result of such Recipient's receipt of the Program under the terms of a Secondary License (if permitted under the terms of Section 3).

3. REQUIREMENTS

3.1 If a Contributor Distributes the Program in any form, then:

a) the Program must also be made available as Source Code, in accordance with section 3.2, and the Contributor must accompany

the Program with a statement that the Source Code for the Program is available under this Agreement, and informs Recipients how to obtain it in a reasonable manner on or through a medium customarily used for software exchange; and

b) the Contributor may Distribute the Program under a license different than this Agreement, provided that such license:

i) effectively disclaims on behalf of all other Contributors all warranties and conditions, express and implied, including warranties or conditions of title and non-infringement, and implied warranties or conditions of merchantability and fitness for a particular purpose;

ii) effectively excludes on behalf of all other Contributors all liability for damages, including direct, indirect, special, incidental and consequential damages, such as lost profits;

iii) does not attempt to limit or alter the recipients' rights in the Source Code under section 3.2; and

iv) requires any subsequent distribution of the Program by any party to be under a license that satisfies the requirements of this section 3.

3.2 When the Program is Distributed as Source Code:

a) it must be made available under this Agreement, or if the Program (i) is combined with other material in a separate file or files made available under a Secondary License, and (ii) the initial Contributor attached to the Source Code the notice described in Exhibit A of this Agreement, then the Program may be made available under the terms of such Secondary Licenses, and

b) a copy of this Agreement must be included with each copy of the Program.

3.3 Contributors may not remove or alter any copyright, patent, trademark, attribution notices, disclaimers of warranty, or limitations

of liability ("notices") contained within the Program from any copy of the Program which they Distribute, provided that Contributors may add their own appropriate notices.

4. COMMERCIAL DISTRIBUTION

Commercial distributors of software may accept certain responsibilities with respect to end users, business partners and the like. While this license is intended to facilitate the commercial use of the Program, the Contributor who includes the Program in a commercial product offering should do so in a manner which does not create potential liability for other Contributors. Therefore, if a Contributor includes the Program in a commercial product offering, such Contributor ("Commercial Contributor") hereby agrees to defend and indemnify every other Contributor ("Indemnified Contributor") against any losses, damages and costs (collectively "Losses") arising from claims, lawsuits and other legal actions brought by a third party against the Indemnified Contributor to the extent caused by the acts or omissions of such Commercial Contributor in connection with its distribution of the Program in a commercial product offering. The obligations in this section do not apply to any claims or Losses relating to any actual or alleged intellectual property infringement. In order to qualify, an Indemnified Contributor must: a) promptly notify the Commercial Contributor in writing of such claim, and b) allow the Commercial Contributor to control, and cooperate with the Commercial Contributor in, the defense and any related settlement negotiations. The Indemnified Contributor may participate in any such claim at its own expense.

For example, a Contributor might include the Program in a commercial product offering, Product X. That Contributor is then a Commercial Contributor. If that Commercial Contributor then makes performance claims, or offers warranties related to Product X, those performance claims and warranties are such Commercial Contributor's responsibility alone. Under this section, the Commercial Contributor would have to defend claims against the other Contributors related to those performance claims and warranties, and if a court requires any other Contributor to pay any damages as a result, the Commercial Contributor must pay those damages.

5. NO WARRANTY

EXCEPT AS EXPRESSLY SET FORTH IN THIS AGREEMENT, AND TO THE EXTENT PERMITTED BY APPLICABLE LAW, THE PROGRAM IS PROVIDED ON AN "AS IS" BASIS, WITHOUT WARRANTIES OR CONDITIONS OF ANY KIND, EITHER EXPRESS OR IMPLIED INCLUDING, WITHOUT LIMITATION, ANY WARRANTIES OR CONDITIONS OF TITLE, NON-INFRINGEMENT, MERCHANTABILITY OR FITNESS FOR A PARTICULAR PURPOSE. Each Recipient is solely responsible for determining the appropriateness of using and distributing the Program and assumes all risks associated with its exercise of rights under this Agreement, including but not limited to the risks and costs of program errors, compliance with applicable laws, damage to or loss of data, programs or equipment, and unavailability or interruption of operations.

6. DISCLAIMER OF LIABILITY

EXCEPT AS EXPRESSLY SET FORTH IN THIS AGREEMENT, AND TO THE EXTENT PERMITTED BY APPLICABLE LAW, NEITHER RECIPIENT NOR ANY CONTRIBUTORS SHALL HAVE ANY LIABILITY FOR ANY DIRECT, INDIRECT, INCIDENTAL, SPECIAL, EXEMPLARY, OR CONSEQUENTIAL DAMAGES (INCLUDING WITHOUT LIMITATION LOST PROFITS), HOWEVER CAUSED AND ON ANY THEORY OF LIABILITY, WHETHER IN CONTRACT, STRICT LIABILITY, OR TORT (INCLUDING NEGLIGENCE OR OTHERWISE) ARISING IN ANY WAY OUT OF THE USE OR DISTRIBUTION OF THE PROGRAM OR THE EXERCISE OF ANY RIGHTS GRANTED HEREUNDER, EVEN IF ADVISED OF THE POSSIBILITY OF SUCH DAMAGES.

7. GENERAL

If any provision of this Agreement is invalid or unenforceable under applicable law, it shall not affect the validity or enforceability of the remainder of the terms of this Agreement, and without further action by the parties hereto, such provision shall be reformed to the minimum extent necessary to make such provision valid and enforceable.

If Recipient institutes patent litigation against any entity (including a cross-claim or counterclaim in a lawsuit) alleging that the Program itself (excluding combinations of the Program with other software

or hardware) infringes such Recipient's patent(s), then such Recipient's rights granted under Section 2(b) shall terminate as of the date such litigation is filed.

All Recipient's rights under this Agreement shall terminate if it fails to comply with any of the material terms or conditions of this Agreement and does not cure such failure in a reasonable period of time after becoming aware of such noncompliance. If all Recipient's rights under this Agreement terminate, Recipient agrees to cease use and distribution of the Program as soon as reasonably practicable. However, Recipient's obligations under this Agreement and any licenses granted by Recipient relating to the Program shall continue and survive.

Everyone is permitted to copy and distribute copies of this Agreement, but in order to avoid inconsistency the Agreement is copyrighted and may only be modified in the following manner. The Agreement Steward reserves the right to publish new versions (including revisions) of this Agreement from time to time. No one other than the Agreement Steward has the right to modify this Agreement. The Eclipse Foundation is the initial Agreement Steward. The Eclipse Foundation may assign the responsibility to serve as the Agreement Steward to a suitable separate entity. Each new version of the Agreement will be given a distinguishing version number. The Program (including Contributions) may always be Distributed subject to the version of the Agreement under which it was received. In addition, after a new version of the Agreement is published, Contributor may elect to Distribute the Program (including its Contributions) under the new version.

Except as expressly stated in Sections 2(a) and 2(b) above, Recipient receives no rights or licenses to the intellectual property of any Contributor under this Agreement, whether expressly, by implication, estoppel or otherwise. All rights in the Program not expressly granted under this Agreement are reserved. Nothing in this Agreement is intended to be enforceable by any entity that is not a Contributor or Recipient. No third-party beneficiary rights are created under this Agreement.

Exhibit A – Form of Secondary Licenses Notice

"This Source Code may also be made available under the following Secondary Licenses when the conditions for such availability set forth in the Eclipse Public License, v. 2.0 are satisfied: {name license(s), version(s), and exceptions or additional permissions here}."

Simply including a copy of this Agreement, including this Exhibit A is not sufficient to license the Source Code under Secondary Licenses.

If it is not possible or desirable to put the notice in a particular file, then You may include the notice in a location (such as a LICENSE file in a relevant directory) where a recipient would be likely to look for such a notice.

You may add additional accurate notices of copyright ownership.

The GNU General Public License (GPL) Version 2, June 1991

Copyright (C) 1989, 1991 Free Software Foundation, Inc.
51 Franklin Street, Fifth Floor
Boston, MA 02110-1335
USA

Everyone is permitted to copy and distribute verbatim copies of this license document, but changing it is not allowed.

Preamble

The licenses for most software are designed to take away your freedom to share and change it. By contrast, the GNU General Public License is intended to guarantee your freedom to share and change free software--to make sure the software is free for all its users. This General Public License applies to most of the Free Software Foundation's software and to any other program whose authors commit to using it. (Some other Free Software Foundation software is covered by the GNU Library General Public License instead.) You can apply it to your programs, too.

When we speak of free software, we are referring to freedom, not price. Our General Public Licenses are designed to make sure that you have the freedom to distribute copies of free software (and charge for this service if you wish), that you receive source code or can get it if you want it, that you can change the software or use pieces of it in new free programs; and that you know you can do these things.

To protect your rights, we need to make restrictions that forbid anyone to deny you these rights or to ask you to surrender the rights. These restrictions translate to certain responsibilities for you if you distribute copies of the software, or if you modify it.

For example, if you distribute copies of such a program, whether gratis or for a fee, you must give the recipients all the rights that you have. You must make sure that they, too, receive or can get the source code. And you must show them these terms so they know their rights.

We protect your rights with two steps: (1) copyright the software, and (2) offer you this license which gives you legal permission to copy, distribute and/or modify the software.

Also, for each author's protection and ours, we want to make certain that everyone understands that there is no warranty for this free software. If the software is modified by someone else and passed on, we want its recipients to know that what they have is not the original, so that any problems introduced by others will not reflect on the original authors' reputations.

Finally, any free program is threatened constantly by software patents. We wish to avoid the danger that redistributors of a free program will individually obtain patent licenses, in effect making the program proprietary. To prevent this, we have made it clear that any patent must be licensed for everyone's free use or not licensed at all.

The precise terms and conditions for copying, distribution and modification follow.

TERMS AND CONDITIONS FOR COPYING, DISTRIBUTION AND MODIFICATION

0. This License applies to any program or other work which contains a notice placed by the copyright holder saying it may be distributed under the terms of this General Public License. The "Program", below, refers to any such program or work, and a "work based on the Program" means either the Program or any derivative work under copyright law: that is to say, a work containing the Program or a portion of it, either verbatim or with modifications and/or translated into another language. (Hereinafter, translation is included without limitation in the term "modification".) Each licensee is addressed as "you".

Activities other than copying, distribution and modification are not covered by this License; they are outside its scope. The act of running the Program is not restricted, and the output from the Program is covered only if its contents constitute a work based on the Program (independent of having been made by running the Program). Whether that is true depends on what the Program does.

1. You may copy and distribute verbatim copies of the Program's source code as you receive it, in any medium, provided that you conspicuously and appropriately publish on each copy an appropriate copyright notice and disclaimer of warranty; keep intact all the notices that refer to this License and to the absence of any warranty; and give any other recipients of the Program a copy of this License along with the Program.

You may charge a fee for the physical act of transferring a copy, and you may at your option offer warranty protection in exchange for a fee.

2. You may modify your copy or copies of the Program or any portion of it, thus forming a work based on the Program, and copy and distribute such modifications or work under the terms of Section 1 above, provided that you also meet all of these conditions:

a) You must cause the modified files to carry prominent notices stating that you changed the files and the date of any change.

b) You must cause any work that you distribute or publish, that in whole or in part contains or is derived from the Program or any part

thereof, to be licensed as a whole at no charge to all third parties under the terms of this License.

c) If the modified program normally reads commands interactively when run, you must cause it, when started running for such interactive use in the most ordinary way, to print or display an announcement including an appropriate copyright notice and a notice that there is no warranty (or else, saying that you provide a warranty) and that users may redistribute the program under these conditions, and telling the user how to view a copy of this License. (Exception: if the Program itself is interactive but does not normally print such an announcement, your work based on the Program is not required to print an announcement.)

These requirements apply to the modified work as a whole. If identifiable sections of that work are not derived from the Program, and can be reasonably considered independent and separate works in themselves, then this License, and its terms, do not apply to those sections when you distribute them as separate works. But when you distribute the same sections as part of a whole which is a work based on the Program, the distribution of the whole must be on the terms of this License, whose permissions for other licensees extend to the entire whole, and thus to each and every part regardless of who wrote it.

Thus, it is not the intent of this section to claim rights or contest your rights to work written entirely by you; rather, the intent is to exercise the right to control the distribution of derivative or collective works based on the Program.

In addition, mere aggregation of another work not based on the Program with the Program (or with a work based on the Program) on a volume of a storage or distribution medium does not bring the other work under the scope of this License.

3. You may copy and distribute the Program (or a work based on it, under Section 2) in object code or executable form under the terms of Sections 1 and 2 above provided that you also do one of the following:

- a) Accompany it with the complete corresponding machine-readable source code, which must be distributed under the terms of Sections 1 and 2 above on a medium customarily used for software interchange; or,

- b) Accompany it with a written offer, valid for at least three years, to give any third party, for a charge no more than your cost of physically performing source distribution, a complete machine-readable copy of the corresponding source code, to be distributed under the terms of Sections 1 and 2 above on a medium customarily used for software interchange; or,

- c) Accompany it with the information you received as to the offer to distribute corresponding source code. (This alternative is allowed only for noncommercial distribution and only if you received the program in object code or executable form with such an offer, in accord with Subsection b above.)

The source code for a work means the preferred form of the work for making modifications to it. For an executable work, complete source code means all the source code for all modules it contains, plus any associated interface definition files, plus the scripts used to control compilation and installation of the executable. However, as a special exception, the source code distributed need not include anything that is normally distributed (in either source or binary form) with the major components (compiler, kernel, and so on) of the operating system on which the executable runs, unless that component itself accompanies the executable.

If distribution of executable or object code is made by offering access to copy from a designated place, then offering equivalent access to copy the source code from the same place counts as distribution of the source code, even though third parties are not compelled to copy the source along with the object code.

4. You may not copy, modify, sublicense, or distribute the Program except as expressly provided under this License. Any attempt otherwise to copy, modify, sublicense or distribute the Program is void, and will automatically terminate your rights under this License. However, parties

who have received copies, or rights, from you under this License will not have their licenses terminated so long as such parties remain in full compliance.

5. You are not required to accept this License, since you have not signed it. However, nothing else grants you permission to modify or distribute the Program or its derivative works. These actions are prohibited by law if you do not accept this License. Therefore, by modifying or distributing the Program (or any work based on the Program), you indicate your acceptance of this License to do so, and all its terms and conditions for copying, distributing or modifying the Program or works based on it.

6. Each time you redistribute the Program (or any work based on the Program), the recipient automatically receives a license from the original licensor to copy, distribute or modify the Program subject to these terms and conditions. You may not impose any further restrictions on the recipients' exercise of the rights granted herein. You are not responsible for enforcing compliance by third parties to this License.

7. If, as a consequence of a court judgment or allegation of patent infringement or for any other reason (not limited to patent issues), conditions are imposed on you (whether by court order, agreement or otherwise) that contradict the conditions of this License, they do not excuse you from the conditions of this License. If you cannot distribute so as to satisfy simultaneously your obligations under this License and any other pertinent obligations, then as a consequence you may not distribute the Program at all. For example, if a patent license would not permit royalty-free redistribution of the Program by all those who receive copies directly or indirectly through you, then the only way you could satisfy both it and this License would be to refrain entirely from distribution of the Program.

If any portion of this section is held invalid or unenforceable under any particular circumstance, the balance of the section is intended to apply and the section as a whole is intended to apply in other circumstances.

It is not the purpose of this section to induce you to infringe any patents or other property right claims or to contest validity of any such claims; this section has the sole purpose of protecting the integrity of the free software distribution system, which is implemented by public license practices. Many people have made generous contributions to the wide range of software distributed through that system in reliance on consistent application of that system; it is up to the author/donor to decide if he or she is willing to distribute software through any other system and a licensee cannot impose that choice.

This section is intended to make thoroughly clear what is believed to be a consequence of the rest of this License.

8. If the distribution and/or use of the Program is restricted in certain countries either by patents or by copyrighted interfaces, the original copyright holder who places the Program under this License may add an explicit geographical distribution limitation excluding those countries, so that distribution is permitted only in or among countries not thus excluded. In such case, this License incorporates the limitation as if written in the body of this License.

9. The Free Software Foundation may publish revised and/or new versions of the General Public License from time to time. Such new versions will be similar in spirit to the present version, but may differ in detail to address new problems or concerns.

Each version is given a distinguishing version number. If the Program specifies a version number of this License which applies to it and "any later version", you have the option of following the terms and conditions either of that version or of any later version published by the Free Software Foundation. If the Program does not specify a version number of this License, you may choose any version ever published by the Free Software Foundation.

10. If you wish to incorporate parts of the Program into other free programs whose distribution conditions are different, write to the author to ask for permission. For software which is copyrighted by the Free Software Foundation, write to the Free Software Foundation; we

sometimes make exceptions for this. Our decision will be guided by the two goals of preserving the free status of all derivatives of our free software and of promoting the sharing and reuse of software generally.

NO WARRANTY

11. BECAUSE THE PROGRAM IS LICENSED FREE OF CHARGE, THERE IS NO WARRANTY FOR THE PROGRAM, TO THE EXTENT PERMITTED BY APPLICABLE LAW. EXCEPT WHEN OTHERWISE STATED IN WRITING THE COPYRIGHT HOLDERS AND/OR OTHER PARTIES PROVIDE THE PROGRAM "AS IS" WITHOUT WARRANTY OF ANY KIND, EITHER EXPRESSED OR IMPLIED, INCLUDING, BUT NOT LIMITED TO, THE IMPLIED WARRANTIES OF MERCHANTABILITY AND FITNESS FOR A PARTICULAR PURPOSE. THE ENTIRE RISK AS TO THE QUALITY AND PERFORMANCE OF THE PROGRAM IS WITH YOU. SHOULD THE PROGRAM PROVE DEFECTIVE, YOU ASSUME THE COST OF ALL NECESSARY SERVICING, REPAIR OR CORRECTION.

12. IN NO EVENT UNLESS REQUIRED BY APPLICABLE LAW OR AGREED TO IN WRITING WILL ANY COPYRIGHT HOLDER, OR ANY OTHER PARTY WHO MAY MODIFY AND/OR REDISTRIBUTE THE PROGRAM AS PERMITTED ABOVE, BE LIABLE TO YOU FOR DAMAGES, INCLUDING ANY GENERAL, SPECIAL, INCIDENTAL OR CONSEQUENTIAL DAMAGES ARISING OUT OF THE USE OR INABILITY TO USE THE PROGRAM (INCLUDING BUT NOT LIMITED TO LOSS OF DATA OR DATA BEING RENDERED INACCURATE OR LOSSES SUSTAINED BY YOU OR THIRD PARTIES OR A FAILURE OF THE PROGRAM TO OPERATE WITH ANY OTHER PROGRAMS), EVEN IF SUCH HOLDER OR OTHER PARTY HAS BEEN ADVISED OF THE POSSIBILITY OF SUCH DAMAGES.

END OF TERMS AND CONDITIONS

How to Apply These Terms to Your New Programs

If you develop a new program, and you want it to be of the greatest possible use to the public, the best way to achieve this is to make it free software which everyone can redistribute and change under these terms.

To do so, attach the following notices to the program. It is safest to attach them to the start of each source file to most effectively convey the exclusion of warranty; and each file should have at least the "copyright" line and a pointer to where the full notice is found.

One line to give the program's name and a brief idea of what it does.

Copyright (C) <year> <name of author>

This program is free software; you can redistribute it and/or modify it under the terms of the GNU General Public License as published by the Free Software Foundation; either version 2 of the License, or (at your option) any later version.

This program is distributed in the hope that it will be useful, but WITHOUT ANY WARRANTY; without even the implied warranty of MERCHANTABILITY or FITNESS FOR A PARTICULAR PURPOSE. See the GNU General Public License for more details.

You should have received a copy of the GNU General Public License along with this program; if not, write to the Free Software Foundation, Inc., 51 Franklin Street, Fifth Floor, Boston, MA 02110-1335 USA

Also add information on how to contact you by electronic and paper mail.

If the program is interactive, make it output a short notice like this when it starts in an interactive mode:

```
Gnomovision version 69, Copyright (C) year name of author
Gnomovision comes with ABSOLUTELY NO WARRANTY; for details type
`show w'. This is free software, and you are welcome to redistribute
it under certain conditions; type `show c' for details.
```

The hypothetical commands `show w' and `show c' should show the appropriate parts of the General Public License. Of course, the commands you use may be called something other than `show w' and `show c'; they could even be mouse-clicks or menu items--whatever suits your program.

You should also get your employer (if you work as a programmer) or your school, if any, to sign a "copyright disclaimer" for the program, if necessary. Here is a sample; alter the names:

```
Yoyodyne, Inc., hereby disclaims all copyright interest in the
```

program `Gnomovision' (which makes passes at compilers) written by James Hacker.

signature of Ty Coon, 1 April 1989

Ty Coon, President of Vice

This General Public License does not permit incorporating your program into proprietary programs. If your program is a subroutine library, you may consider it more useful to permit linking proprietary applications with the library. If this is what you want to do, use the GNU Library General Public License instead of this License.

CLASSPATH EXCEPTION

Linking this library statically or dynamically with other modules is making a combined work based on this library. Thus, the terms and conditions of the GNU General Public License version 2 cover the whole combination.

As a special exception, the copyright holders of this library give you permission to link this library with independent modules to produce an executable, regardless of the license terms of these independent modules, and to copy and distribute the resulting executable under terms of your choice, provided that you also meet, for each linked independent module, the terms and conditions of the license of that module. An independent module is a module which is not derived from or based on this library. If you modify this library, you may extend this exception to your version of the library, but you are not obligated to do so. If you do not wish to do so, delete this exception statement from your version.

87.pango (except OpenTypeCode)

GNU LESSER GENERAL PUBLIC LICENSE

Version 2.1, February 1999

Copyright (C) 1991, 1999 Free Software Foundation, Inc.

51 Franklin Street, Fifth Floor, Boston, MA 02110-1301 USA

Everyone is permitted to copy and distribute verbatim copies
of this license document, but changing it is not allowed.

[This is the first released version of the Lesser GPL. It also counts
as the successor of the GNU Library Public License, version 2, hence
the version number 2.1.]

Preamble

The licenses for most software are designed to take away your freedom to share and
change it. By contrast, the GNU General Public Licenses are intended to guarantee
your freedom to share and change free software--to make sure the software is free
for all its users.

This license, the Lesser General Public License, applies to some specially designated
software packages--typically libraries--of the Free Software Foundation and other

authors who decide to use it. You can use it too, but we suggest you first think carefully about whether this license or the ordinary General Public License is the better strategy to use in any particular case, based on the explanations below.

When we speak of free software, we are referring to freedom of use, not price. Our General Public Licenses are designed to make sure that you have the freedom to distribute copies of free software (and charge for this service if you wish); that you receive source code or can get it if you want it; that you can change the software and use pieces of it in new free programs; and that you are informed that you can do these things.

To protect your rights, we need to make restrictions that forbid distributors to deny you these rights or to ask you to surrender these rights. These restrictions translate to certain responsibilities for you if you distribute copies of the library or if you modify it.

For example, if you distribute copies of the library, whether gratis or for a fee, you must give the recipients all the rights that we gave you. You must make sure that they, too, receive or can get the source code. If you link other code with the library, you must provide complete object files to the recipients, so that they can relink them with the library after making changes to the library and recompiling it. And you must show them these terms so they know their rights.

We protect your rights with a two-step method: (1) we copyright the library, and (2) we offer you this license, which gives you legal permission to copy, distribute and/or modify the library.

To protect each distributor, we want to make it very clear that there is no warranty for the free library. Also, if the library is modified by someone else and passed on, the recipients should know that what they have is not the original version, so that the original author's reputation will not be affected by problems that might be introduced by others.

Finally, software patents pose a constant threat to the existence of any free program. We wish to make sure that a company cannot effectively restrict the users of a free program by obtaining a restrictive license from a patent holder. Therefore, we insist that any patent license obtained for a version of the library must be consistent with the full freedom of use specified in this license.

Most GNU software, including some libraries, is covered by the ordinary GNU General Public License. This license, the GNU Lesser General Public License, applies to certain designated libraries, and is quite different from the ordinary General Public License.

We use this license for certain libraries in order to permit linking those libraries into non-free programs.

When a program is linked with a library, whether statically or using a shared library, the combination of the two is legally speaking a combined work, a derivative of the original library. The ordinary General Public License therefore permits such linking only if the entire combination fits its criteria of freedom. The Lesser General Public License permits more lax criteria for linking other code with the library.

We call this license the "Lesser" General Public License because it does Less to protect the user's freedom than the ordinary General Public License. It also provides other free software developers Less of an advantage over competing non-free programs. These disadvantages are the reason we use the ordinary General Public License for many libraries. However, the Lesser license provides advantages in certain special circumstances.

For example, on rare occasions, there may be a special need to encourage the widest possible use of a certain library, so that it becomes a de-facto standard. To achieve this, non-free programs must be allowed to use the library. A more frequent case is that a free library does the same job as widely used non-free libraries. In this case, there is little to gain by limiting the free library to free software only, so we use the Lesser General Public License.

In other cases, permission to use a particular library in non-free programs enables a greater number of people to use a large body of free software. For example,

permission to use the GNU C Library in non-free programs enables many more people to use the whole GNU operating system, as well as its variant, the GNU/Linux operating system.

Although the Lesser General Public License is Less protective of the users' freedom, it does ensure that the user of a program that is linked with the Library has the freedom and the wherewithal to run that program using a modified version of the Library.

The precise terms and conditions for copying, distribution and modification follow.

Pay close attention to the difference between a "work based on the library" and a "work that uses the library". The former contains code derived from the library, whereas the latter must be combined with the library in order to run.

TERMS AND CONDITIONS FOR COPYING, DISTRIBUTION AND MODIFICATION

0. This License Agreement applies to any software library or other program which contains a notice placed by the copyright holder or other authorized party saying it may be distributed under the terms of this Lesser General Public License (also called "this License"). Each licensee is addressed as "you".

A "library" means a collection of software functions and/or data prepared so as to be conveniently linked with application programs (which use some of those functions and data) to form executables.

The "Library", below, refers to any such software library or work which has been distributed under these terms. A "work based on the Library" means either the Library or any derivative work under copyright law: that is to say, a work containing the Library or a portion of it, either verbatim or with modifications and/or translated straightforwardly into another language. (Hereinafter, translation is included without limitation in the term "modification".)

"Source code" for a work means the preferred form of the work for making modifications to it. For a library, complete source code means all the source code for all modules it contains, plus any associated interface definition files, plus the scripts used to control compilation and installation of the library.

Activities other than copying, distribution and modification are not covered by this License; they are outside its scope. The act of running a program using the Library is not restricted, and output from such a program is covered only if its contents constitute a work based on the Library (independent of the use of the Library in a tool for writing it). Whether that is true depends on what the Library does and what the program that uses the Library does.

1. You may copy and distribute verbatim copies of the Library's complete source code as you receive it, in any medium, provided that you conspicuously and appropriately publish on each copy an appropriate copyright notice and disclaimer

of warranty; keep intact all the notices that refer to this License and to the absence of any warranty; and distribute a copy of this License along with the Library.

You may charge a fee for the physical act of transferring a copy, and you may at your option offer warranty protection in exchange for a fee.

2. You may modify your copy or copies of the Library or any portion of it, thus forming a work based on the Library, and copy and distribute such modifications or work under the terms of Section 1 above, provided that you also meet all of these conditions:

- a) The modified work must itself be a software library.
- b) You must cause the files modified to carry prominent notices stating that you changed the files and the date of any change.
- c) You must cause the whole of the work to be licensed at no charge to all third parties under the terms of this License.
- d) If a facility in the modified Library refers to a function or a table of data to be supplied by an application program that uses the facility, other than as an argument passed when the facility is invoked, then you must make a good faith effort to ensure that, in the event an application does not supply such function or table, the facility still operates, and performs whatever part of its purpose remains meaningful.

(For example, a function in a library to compute square roots has a purpose that is entirely well-defined independent of the application. Therefore, Subsection 2d requires that any application-supplied function or table used by this function must be optional: if the application does not supply it, the square root function must still compute square roots.)

These requirements apply to the modified work as a whole. If identifiable sections of that work are not derived from the Library, and can be reasonably considered independent and separate works in themselves, then this License, and its terms, do not apply to those sections when you distribute them as separate works. But when you distribute the same sections as part of a whole which is a work based on the Library, the distribution of the whole must be on the terms of this License, whose permissions for other licensees extend to the entire whole, and thus to each and every part regardless of who wrote it.

Thus, it is not the intent of this section to claim rights or contest your rights to work written entirely by you; rather, the intent is to exercise the right to control the distribution of derivative or collective works based on the Library.

In addition, mere aggregation of another work not based on the Library with the Library (or with a work based on the Library) on a volume of a storage or distribution medium does not bring the other work under the scope of this License.

3. You may opt to apply the terms of the ordinary GNU General Public License instead of this License to a given copy of the Library. To do this, you must alter all the notices that refer to this License, so that they refer to the ordinary GNU General Public License, version 2, instead of to this License. (If a newer version than version 2 of the ordinary GNU General Public License has appeared, then you can specify that version instead if you wish.) Do not make any other change in these notices.

Once this change is made in a given copy, it is irreversible for that copy, so the ordinary GNU General Public License applies to all subsequent copies and derivative works made from that copy.

This option is useful when you wish to copy part of the code of the Library into a program that is not a library.

4. You may copy and distribute the Library (or a portion or derivative of it, under Section 2) in object code or executable form under the terms of Sections 1 and 2 above provided that you accompany it with the complete corresponding machine-readable source code, which must be distributed under the terms of Sections 1 and 2 above on a medium customarily used for software interchange.

If distribution of object code is made by offering access to copy from a designated place, then offering equivalent access to copy the source code from the same place

satisfies the requirement to distribute the source code, even though third parties are not compelled to copy the source along with the object code.

5. A program that contains no derivative of any portion of the Library, but is designed to work with the Library by being compiled or linked with it, is called a "work that uses the Library". Such a work, in isolation, is not a derivative work of the Library, and therefore falls outside the scope of this License.

However, linking a "work that uses the Library" with the Library creates an executable that is a derivative of the Library (because it contains portions of the Library), rather than a "work that uses the library". The executable is therefore covered by this License. Section 6 states terms for distribution of such executables.

When a "work that uses the Library" uses material from a header file that is part of the Library, the object code for the work may be a derivative work of the Library even though the source code is not. Whether this is true is especially significant if the work can be linked without the Library, or if the work is itself a library. The threshold for this to be true is not precisely defined by law.

If such an object file uses only numerical parameters, data structure layouts and accessors, and small macros and small inline functions (ten lines or less in length), then the use of the object file is unrestricted, regardless of whether it is legally a

derivative work. (Executables containing this object code plus portions of the Library will still fall under Section 6.)

Otherwise, if the work is a derivative of the Library, you may distribute the object code for the work under the terms of Section 6. Any executables containing that work also fall under Section 6, whether or not they are linked directly with the Library itself.

6. As an exception to the Sections above, you may also combine or link a "work that uses the Library" with the Library to produce a work containing portions of the Library, and distribute that work under terms of your choice, provided that the terms permit modification of the work for the customer's own use and reverse engineering for debugging such modifications.

You must give prominent notice with each copy of the work that the Library is used in it and that the Library and its use are covered by this License. You must supply a copy of this License. If the work during execution displays copyright notices, you must include the copyright notice for the Library among them, as well as a reference directing the user to the copy of this License. Also, you must do one of these things:

- a) Accompany the work with the complete corresponding machine-readable source code for the Library including whatever changes were used in the work (which must be distributed under Sections 1 and 2 above); and, if the work is an executable

linked with the Library, with the complete machine-readable "work that uses the Library", as object code and/or source code, so that the user can modify the Library and then relink to produce a modified executable containing the modified Library. (It is understood that the user who changes the contents of definitions files in the Library will not necessarily be able to recompile the application to use the modified definitions.)

- b) Use a suitable shared library mechanism for linking with the Library. A suitable mechanism is one that (1) uses at run time a copy of the library already present on the user's computer system, rather than copying library functions into the executable, and (2) will operate properly with a modified version of the library, if the user installs one, as long as the modified version is interface-compatible with the version that the work was made with.
- c) Accompany the work with a written offer, valid for at least three years, to give the same user the materials specified in Subsection 6a, above, for a charge no more than the cost of performing this distribution.
- d) If distribution of the work is made by offering access to copy from a designated place, offer equivalent access to copy the above specified materials from the same place.

- e) Verify that the user has already received a copy of these materials or that you have already sent this user a copy.

For an executable, the required form of the "work that uses the Library" must include any data and utility programs needed for reproducing the executable from it.

However, as a special exception, the materials to be distributed need not include anything that is normally distributed (in either source or binary form) with the major components (compiler, kernel, and so on) of the operating system on which the executable runs, unless that component itself accompanies the executable.

It may happen that this requirement contradicts the license restrictions of other proprietary libraries that do not normally accompany the operating system. Such a contradiction means you cannot use both them and the Library together in an executable that you distribute.

7. You may place library facilities that are a work based on the Library side-by-side in a single library together with other library facilities not covered by this License, and distribute such a combined library, provided that the separate distribution of the work based on the Library and of the other library facilities is otherwise permitted, and provided that you do these two things:

- a) Accompany the combined library with a copy of the same work based on the Library, uncombined with any other library facilities. This must be distributed under the terms of the Sections above.
- b) Give prominent notice with the combined library of the fact that part of it is a work based on the Library, and explaining where to find the accompanying uncombined form of the same work.

8. You may not copy, modify, sublicense, link with, or distribute the Library except as expressly provided under this License. Any attempt otherwise to copy, modify, sublicense, link with, or distribute the Library is void, and will automatically terminate your rights under this License. However, parties who have received copies, or rights, from you under this License will not have their licenses terminated so long as such parties remain in full compliance.

9. You are not required to accept this License, since you have not signed it. However, nothing else grants you permission to modify or distribute the Library or its derivative works. These actions are prohibited by law if you do not accept this License. Therefore, by modifying or distributing the Library (or any work based on the Library), you indicate your acceptance of this License to do so, and all its terms and conditions for copying, distributing or modifying the Library or works based on it.

10. Each time you redistribute the Library (or any work based on the Library), the recipient automatically receives a license from the original licensor to copy, distribute, link with or modify the Library subject to these terms and conditions. You may not impose any further restrictions on the recipients' exercise of the rights granted herein. You are not responsible for enforcing compliance by third parties with this License.

11. If, as a consequence of a court judgment or allegation of patent infringement or for any other reason (not limited to patent issues), conditions are imposed on you (whether by court order, agreement or otherwise) that contradict the conditions of this License, they do not excuse you from the conditions of this License. If you cannot distribute so as to satisfy simultaneously your obligations under this License and any other pertinent obligations, then as a consequence you may not distribute the Library at all. For example, if a patent license would not permit royalty-free redistribution of the Library by all those who receive copies directly or indirectly through you, then the only way you could satisfy both it and this License would be to refrain entirely from distribution of the Library.

If any portion of this section is held invalid or unenforceable under any particular circumstance, the balance of the section is intended to apply, and the section as a whole is intended to apply in other circumstances.

It is not the purpose of this section to induce you to infringe any patents or other property right claims or to contest validity of any such claims; this section has the sole purpose of protecting the integrity of the free software distribution system which is implemented by public license practices. Many people have made generous contributions to the wide range of software distributed through that system in reliance on consistent application of that system; it is up to the author/donor to decide if he or she is willing to distribute software through any other system and a licensee cannot impose that choice.

This section is intended to make thoroughly clear what is believed to be a consequence of the rest of this License.

12. If the distribution and/or use of the Library is restricted in certain countries either by patents or by copyrighted interfaces, the original copyright holder who places the Library under this License may add an explicit geographical distribution limitation excluding those countries, so that distribution is permitted only in or among countries not thus excluded. In such case, this License incorporates the limitation as if written in the body of this License.

13. The Free Software Foundation may publish revised and/or new versions of the Lesser General Public License from time to time. Such new versions will be similar in

spirit to the present version, but may differ in detail to address new problems or concerns.

Each version is given a distinguishing version number. If the Library specifies a version number of this License which applies to it and "any later version", you have the option of following the terms and conditions either of that version or of any later version published by the Free Software Foundation. If the Library does not specify a license version number, you may choose any version ever published by the Free Software Foundation.

14. If you wish to incorporate parts of the Library into other free programs whose distribution conditions are incompatible with these, write to the author to ask for permission. For software which is copyrighted by the Free Software Foundation, write to the Free Software Foundation; we sometimes make exceptions for this. Our decision will be guided by the two goals of preserving the free status of all derivatives of our free software and of promoting the sharing and reuse of software generally.

NO WARRANTY

15. BECAUSE THE LIBRARY IS LICENSED FREE OF CHARGE, THERE IS NO WARRANTY FOR THE LIBRARY, TO THE EXTENT PERMITTED BY APPLICABLE LAW. EXCEPT WHEN OTHERWISE STATED IN WRITING THE COPYRIGHT HOLDERS AND/OR OTHER PARTIES

PROVIDE THE LIBRARY "AS IS" WITHOUT WARRANTY OF ANY KIND, EITHER EXPRESSED OR IMPLIED, INCLUDING, BUT NOT LIMITED TO, THE IMPLIED WARRANTIES OF MERCHANTABILITY AND FITNESS FOR A PARTICULAR PURPOSE. THE ENTIRE RISK AS TO THE QUALITY AND PERFORMANCE OF THE LIBRARY IS WITH YOU. SHOULD THE LIBRARY PROVE DEFECTIVE, YOU ASSUME THE COST OF ALL NECESSARY SERVICING, REPAIR OR CORRECTION.

16. IN NO EVENT UNLESS REQUIRED BY APPLICABLE LAW OR AGREED TO IN WRITING WILL ANY COPYRIGHT HOLDER, OR ANY OTHER PARTY WHO MAY MODIFY AND/OR REDISTRIBUTE THE LIBRARY AS PERMITTED ABOVE, BE LIABLE TO YOU FOR DAMAGES, INCLUDING ANY GENERAL, SPECIAL, INCIDENTAL OR CONSEQUENTIAL DAMAGES ARISING OUT OF THE USE OR INABILITY TO USE THE LIBRARY (INCLUDING BUT NOT LIMITED TO LOSS OF DATA OR DATA BEING RENDERED INACCURATE OR LOSSES SUSTAINED BY YOU OR THIRD PARTIES OR A FAILURE OF THE LIBRARY TO OPERATE WITH ANY OTHER SOFTWARE), EVEN IF SUCH HOLDER OR OTHER PARTY HAS BEEN ADVISED OF THE POSSIBILITY OF SUCH DAMAGES.

END OF TERMS AND CONDITIONS

How to Apply These Terms to Your New Libraries

If you develop a new library, and you want it to be of the greatest possible use to the public, we recommend making it free software that everyone can redistribute and

change. You can do so by permitting redistribution under these terms (or, alternatively, under the terms of the ordinary General Public License).

To apply these terms, attach the following notices to the library. It is safest to attach them to the start of each source file to most effectively convey the exclusion of warranty; and each file should have at least the "copyright" line and a pointer to where the full notice is found.

one line to give the library's name and an idea of what it does.

Copyright (C) year name of author

This library is free software; you can redistribute it and/or modify it under the terms of the GNU Lesser General Public License as published by the Free Software Foundation; either version 2.1 of the License, or (at your option) any later version.

This library is distributed in the hope that it will be useful, but WITHOUT ANY WARRANTY; without even the implied warranty of MERCHANTABILITY or FITNESS FOR A PARTICULAR PURPOSE. See the GNU Lesser General Public License for more details.

You should have received a copy of the GNU Lesser General Public

License along with this library; if not, write to the Free Software

Foundation, Inc., 51 Franklin Street, Fifth Floor, Boston, MA 02110-1301 USA

Also add information on how to contact you by electronic and paper mail.

You should also get your employer (if you work as a programmer) or your school, if any, to sign a "copyright disclaimer" for the library, if necessary. Here is a sample;

alter the names:

Yoyodyne, Inc., hereby disclaims all copyright interest in

the library `Frob' (a library for tweaking knobs) written

by James Random Hacker.

signature of Ty Coon, 1 April 1990

Ty Coon, President of Vice

That's all there is to it!

88.Squid

GNU GENERAL PUBLIC LICENSE

Version 2, June 1991

Copyright (C) 1989, 1991 Free Software Foundation, Inc.

59 Temple Place, Suite 330, Boston, MA 02111, USA

Everyone is permitted to copy and distribute verbatim copies

of this license document, but changing it is not allowed.

Preamble

The licenses for most software are designed to take away your freedom to share and change it. By contrast, the GNU General Public License is intended to guarantee your freedom to share and change free software--to make sure the software is free for all its users. This General Public License applies to most of the Free Software Foundation's software and to any other program whose authors commit to using it. (Some other Free Software Foundation software is covered by the GNU Library General Public License instead.) You can apply it to your programs, too.

When we speak of free software, we are referring to freedom, not price. Our General Public Licenses are designed to make sure that you have the freedom to distribute copies of free software (and charge for this service if you wish), that you receive source code or can get it if you want it, that you can change the software or use pieces of it in new free programs; and that you know you can do these things.

To protect your rights, we need to make restrictions that forbid anyone to deny you these rights or to ask you to surrender the rights. These restrictions translate to certain responsibilities for you if you distribute copies of the software, or if you modify it.

For example, if you distribute copies of such a program, whether gratis or for a fee, you must give the recipients all the rights that you have. You must make sure that they, too, receive or can get the source code. And you must show them these terms so they know their rights.

We protect your rights with two steps: (1) copyright the software, and (2) offer you this license which gives you legal permission to copy, distribute and/or modify the software.

Also, for each author's protection and ours, we want to make certain that everyone understands that there is no warranty for this free

software. If the software is modified by someone else and passed on, we want its recipients to know that what they have is not the original, so that any problems introduced by others will not reflect on the original authors' reputations.

Finally, any free program is threatened constantly by software patents. We wish to avoid the danger that redistributors of a free program will individually obtain patent licenses, in effect making the program proprietary. To prevent this, we have made it clear that any patent must be licensed for everyone's free use or not licensed at all.

The precise terms and conditions for copying, distribution and modification follow.

GNU GENERAL PUBLIC LICENSE

TERMS AND CONDITIONS FOR COPYING, DISTRIBUTION AND MODIFICATION

0. This License applies to any program or other work which contains a notice placed by the copyright holder saying it may be distributed under the terms of this General Public License. The "Program", below, refers to any such program or work, and a "work based on the Program" means either the Program or any derivative work under copyright law: that is to say, a work containing the Program or a portion of it, either verbatim or with modifications and/or translated into another language. (Hereinafter, translation is included without limitation in the term "modification".) Each licensee is addressed as "you".

Activities other than copying, distribution and modification are not covered by this License; they are outside its scope. The act of running the Program is not restricted, and the output from the Program is covered only if its contents constitute a work based on the Program (independent of having been made by running the Program). Whether that is true depends on what the Program does.

1. You may copy and distribute verbatim copies of the Program's source code as you receive it, in any medium, provided that you conspicuously and appropriately publish on each copy an appropriate copyright notice and disclaimer of warranty; keep intact all the

notices that refer to this License and to the absence of any warranty; and give any other recipients of the Program a copy of this License along with the Program.

You may charge a fee for the physical act of transferring a copy, and you may at your option offer warranty protection in exchange for a fee.

2. You may modify your copy or copies of the Program or any portion of it, thus forming a work based on the Program, and copy and distribute such modifications or work under the terms of Section 1 above, provided that you also meet all of these conditions:

a) You must cause the modified files to carry prominent notices stating that you changed the files and the date of any change.

b) You must cause any work that you distribute or publish, that in whole or in part contains or is derived from the Program or any part thereof, to be licensed as a whole at no charge to all third parties under the terms of this License.

c) If the modified program normally reads commands interactively when run, you must cause it, when started running for such interactive use in the most ordinary way, to print or display an announcement including an appropriate copyright notice and a notice that there is no warranty (or else, saying that you provide a warranty) and that users may redistribute the program under these conditions, and telling the user how to view a copy of this License. (Exception: if the Program itself is interactive but does not normally print such an announcement, your work based on the Program is not required to print an announcement.)

These requirements apply to the modified work as a whole. If identifiable sections of that work are not derived from the Program, and can be reasonably considered independent and separate works in themselves, then this License, and its terms, do not apply to those sections when you distribute them as separate works. But when you distribute the same sections as part of a whole which is a work based on the Program, the distribution of the whole must be on the terms of

this License, whose permissions for other licensees extend to the entire whole, and thus to each and every part regardless of who wrote it.

Thus, it is not the intent of this section to claim rights or contest your rights to work written entirely by you; rather, the intent is to exercise the right to control the distribution of derivative or collective works based on the Program.

In addition, mere aggregation of another work not based on the Program with the Program (or with a work based on the Program) on a volume of a storage or distribution medium does not bring the other work under the scope of this License.

3. You may copy and distribute the Program (or a work based on it, under Section 2) in object code or executable form under the terms of Sections 1 and 2 above provided that you also do one of the following:

a) Accompany it with the complete corresponding machine-readable source code, which must be distributed under the terms of Sections 1 and 2 above on a medium customarily used for software interchange; or,

b) Accompany it with a written offer, valid for at least three years, to give any third party, for a charge no more than your cost of physically performing source distribution, a complete machine-readable copy of the corresponding source code, to be distributed under the terms of Sections 1 and 2 above on a medium customarily used for software interchange; or,

c) Accompany it with the information you received as to the offer to distribute corresponding source code. (This alternative is allowed only for noncommercial distribution and only if you received the program in object code or executable form with such an offer, in accord with Subsection b above.)

The source code for a work means the preferred form of the work for making modifications to it. For an executable work, complete source code means all the source code for all modules it contains, plus any associated interface definition files, plus the scripts used to

control compilation and installation of the executable. However, as a special exception, the source code distributed need not include anything that is normally distributed (in either source or binary form) with the major components (compiler, kernel, and so on) of the operating system on which the executable runs, unless that component itself accompanies the executable.

If distribution of executable or object code is made by offering access to copy from a designated place, then offering equivalent access to copy the source code from the same place counts as distribution of the source code, even though third parties are not compelled to copy the source along with the object code.

4. You may not copy, modify, sublicense, or distribute the Program except as expressly provided under this License. Any attempt otherwise to copy, modify, sublicense or distribute the Program is void, and will automatically terminate your rights under this License. However, parties who have received copies, or rights, from you under this License will not have their licenses terminated so long as such parties remain in full compliance.

5. You are not required to accept this License, since you have not signed it. However, nothing else grants you permission to modify or distribute the Program or its derivative works. These actions are prohibited by law if you do not accept this License. Therefore, by modifying or distributing the Program (or any work based on the Program), you indicate your acceptance of this License to do so, and all its terms and conditions for copying, distributing or modifying the Program or works based on it.

6. Each time you redistribute the Program (or any work based on the Program), the recipient automatically receives a license from the original licensor to copy, distribute or modify the Program subject to these terms and conditions. You may not impose any further restrictions on the recipients' exercise of the rights granted herein. You are not responsible for enforcing compliance by third parties to this License.

7. If, as a consequence of a court judgment or allegation of patent infringement or for any other reason (not limited to patent issues), conditions are imposed on you (whether by court order, agreement or otherwise) that contradict the conditions of this License, they do not excuse you from the conditions of this License. If you cannot distribute so as to satisfy simultaneously your obligations under this License and any other pertinent obligations, then as a consequence you may not distribute the Program at all. For example, if a patent license would not permit royalty-free redistribution of the Program by all those who receive copies directly or indirectly through you, then the only way you could satisfy both it and this License would be to refrain entirely from distribution of the Program.

If any portion of this section is held invalid or unenforceable under any particular circumstance, the balance of the section is intended to apply and the section as a whole is intended to apply in other circumstances.

It is not the purpose of this section to induce you to infringe any patents or other property right claims or to contest validity of any such claims; this section has the sole purpose of protecting the integrity of the free software distribution system, which is implemented by public license practices. Many people have made generous contributions to the wide range of software distributed through that system in reliance on consistent application of that system; it is up to the author/donor to decide if he or she is willing to distribute software through any other system and a licensee cannot impose that choice.

This section is intended to make thoroughly clear what is believed to be a consequence of the rest of this License.

8. If the distribution and/or use of the Program is restricted in certain countries either by patents or by copyrighted interfaces, the original copyright holder who places the Program under this License may add an explicit geographical distribution limitation excluding those countries, so that distribution is permitted only in or among countries not thus excluded. In such case, this License incorporates

the limitation as if written in the body of this License.

9. The Free Software Foundation may publish revised and/or new versions of the General Public License from time to time. Such new versions will be similar in spirit to the present version, but may differ in detail to address new problems or concerns.

Each version is given a distinguishing version number. If the Program specifies a version number of this License which applies to it and "any later version", you have the option of following the terms and conditions either of that version or of any later version published by the Free Software Foundation. If the Program does not specify a version number of this License, you may choose any version ever published by the Free Software Foundation.

10. If you wish to incorporate parts of the Program into other free programs whose distribution conditions are different, write to the author to ask for permission. For software which is copyrighted by the Free Software Foundation, write to the Free Software Foundation; we sometimes make exceptions for this. Our decision will be guided by the two goals of preserving the free status of all derivatives of our free software and of promoting the sharing and reuse of software generally.

NO WARRANTY

11. BECAUSE THE PROGRAM IS LICENSED FREE OF CHARGE, THERE IS NO WARRANTY FOR THE PROGRAM, TO THE EXTENT PERMITTED BY APPLICABLE LAW. EXCEPT WHEN OTHERWISE STATED IN WRITING THE COPYRIGHT HOLDERS AND/OR OTHER PARTIES PROVIDE THE PROGRAM "AS IS" WITHOUT WARRANTY OF ANY KIND, EITHER EXPRESSED OR IMPLIED, INCLUDING, BUT NOT LIMITED TO, THE IMPLIED WARRANTIES OF MERCHANTABILITY AND FITNESS FOR A PARTICULAR PURPOSE. THE ENTIRE RISK AS TO THE QUALITY AND PERFORMANCE OF THE PROGRAM IS WITH YOU. SHOULD THE PROGRAM PROVE DEFECTIVE, YOU ASSUME THE COST OF ALL NECESSARY SERVICING, REPAIR OR CORRECTION.

12. IN NO EVENT UNLESS REQUIRED BY APPLICABLE LAW OR AGREED TO IN WRITING WILL ANY COPYRIGHT HOLDER, OR ANY OTHER PARTY WHO MAY MODIFY AND/OR REDISTRIBUTE THE PROGRAM AS PERMITTED ABOVE, BE LIABLE TO YOU FOR DAMAGES,

INCLUDING ANY GENERAL, SPECIAL, INCIDENTAL OR CONSEQUENTIAL DAMAGES ARISING OUT OF THE USE OR INABILITY TO USE THE PROGRAM (INCLUDING BUT NOT LIMITED TO LOSS OF DATA OR DATA BEING RENDERED INACCURATE OR LOSSES SUSTAINED BY YOU OR THIRD PARTIES OR A FAILURE OF THE PROGRAM TO OPERATE WITH ANY OTHER PROGRAMS), EVEN IF SUCH HOLDER OR OTHER PARTY HAS BEEN ADVISED OF THE POSSIBILITY OF SUCH DAMAGES.

END OF TERMS AND CONDITIONS

Appendix: How to Apply These Terms to Your New Programs

If you develop a new program, and you want it to be of the greatest possible use to the public, the best way to achieve this is to make it free software which everyone can redistribute and change under these terms.

To do so, attach the following notices to the program. It is safest to attach them to the start of each source file to most effectively convey the exclusion of warranty; and each file should have at least the "copyright" line and a pointer to where the full notice is found.

<one line to give the program's name and a brief idea of what it does.>
Copyright (C) 19yy <name of author>

This program is free software; you can redistribute it and/or modify it under the terms of the GNU General Public License as published by the Free Software Foundation; either version 2 of the License, or (at your option) any later version.

This program is distributed in the hope that it will be useful, but WITHOUT ANY WARRANTY; without even the implied warranty of MERCHANTABILITY or FITNESS FOR A PARTICULAR PURPOSE. See the GNU General Public License for more details.

You should have received a copy of the GNU General Public License along with this program; if not, write to the Free Software Foundation, Inc., 59 Temple Place, Suite 330, Boston, MA 02111, USA.

Also add information on how to contact you by electronic and paper mail.

If the program is interactive, make it output a short notice like this when it starts in an interactive mode:

```
Gnomovision version 69, Copyright (C) 19yy name of author
Gnomovision comes with ABSOLUTELY NO WARRANTY; for details type `show w'.
This is free software, and you are welcome to redistribute it
under certain conditions; type `show c' for details.
```

The hypothetical commands `show w' and `show c' should show the appropriate parts of the General Public License. Of course, the commands you use may be called something other than `show w' and `show c'; they could even be mouse-clicks or menu items--whatever suits your program.

You should also get your employer (if you work as a programmer) or your school, if any, to sign a "copyright disclaimer" for the program, if necessary. Here is a sample; alter the names:

```
Yoyodyne, Inc., hereby disclaims all copyright interest in the program
`Gnomovision' (which makes passes at compilers) written by James Hacker.
```

```
<signature of Ty Coon>, 1 April 1989
Ty Coon, President of Vice
```

This General Public License does not permit incorporating your program into proprietary programs. If your program is a subroutine library, you may consider it more useful to permit linking proprietary applications with the library. If this is what you want to do, use the GNU Library General Public License instead of this License.

```
////////////////////////////////////
```

GNU LESSER GENERAL PUBLIC LICENSE

Version 2.1, February 1999

Copyright (C) 1991, 1999 Free Software Foundation, Inc.
51 Franklin Street, Fifth Floor, Boston, MA 02110-1301 USA

Everyone is permitted to copy and distribute verbatim copies of this license document, but changing it is not allowed.

[This is the first released version of the Lesser GPL. It also counts as the successor of the GNU Library Public License, version 2, hence the version number 2.1.]

Preamble

The licenses for most software are designed to take away your freedom to share and change it. By contrast, the GNU General Public Licenses are intended to guarantee your freedom to share and change free software--to make sure the software is free for all its users.

This license, the Lesser General Public License, applies to some specially designated software packages--typically libraries--of the Free Software Foundation and other authors who decide to use it. You can use it too, but we suggest you first think carefully about whether this license or the ordinary General Public License is the better strategy to use in any particular case, based on the explanations below.

When we speak of free software, we are referring to freedom of use, not price. Our General Public Licenses are designed to make sure that you have the freedom to distribute copies of free software (and charge for this service if you wish); that you receive source code or can get it if you want it; that you can change the software and use pieces of it in new free programs; and that you are informed that you can do these things.

To protect your rights, we need to make restrictions that forbid distributors to deny you these rights or to ask you to surrender these rights. These restrictions translate to certain responsibilities for you if you distribute copies of the library or if you modify it.

For example, if you distribute copies of the library, whether gratis or for a fee, you must give the recipients all the rights that we gave you. You must make sure that they, too, receive or can get the source code. If you link other code with the library, you must provide

complete object files to the recipients, so that they can relink them with the library after making changes to the library and recompiling it. And you must show them these terms so they know their rights.

We protect your rights with a two-step method: (1) we copyright the library, and (2) we offer you this license, which gives you legal permission to copy, distribute and/or modify the library.

To protect each distributor, we want to make it very clear that there is no warranty for the free library. Also, if the library is modified by someone else and passed on, the recipients should know that what they have is not the original version, so that the original author's reputation will not be affected by problems that might be introduced by others.

Finally, software patents pose a constant threat to the existence of any free program. We wish to make sure that a company cannot effectively restrict the users of a free program by obtaining a restrictive license from a patent holder. Therefore, we insist that any patent license obtained for a version of the library must be consistent with the full freedom of use specified in this license.

Most GNU software, including some libraries, is covered by the ordinary GNU General Public License. This license, the GNU Lesser General Public License, applies to certain designated libraries, and is quite different from the ordinary General Public License. We use this license for certain libraries in order to permit linking those libraries into non-free programs.

When a program is linked with a library, whether statically or using a shared library, the combination of the two is legally speaking a combined work, a derivative of the original library. The ordinary General Public License therefore permits such linking only if the entire combination fits its criteria of freedom. The Lesser General Public License permits more lax criteria for linking other code with the library.

We call this license the "Lesser" General Public License because it

does Less to protect the user's freedom than the ordinary General Public License. It also provides other free software developers Less of an advantage over competing non-free programs. These disadvantages are the reason we use the ordinary General Public License for many libraries. However, the Lesser license provides advantages in certain special circumstances.

For example, on rare occasions, there may be a special need to encourage the widest possible use of a certain library, so that it becomes a de-facto standard. To achieve this, non-free programs must be allowed to use the library. A more frequent case is that a free library does the same job as widely used non-free libraries. In this case, there is little to gain by limiting the free library to free software only, so we use the Lesser General Public License.

In other cases, permission to use a particular library in non-free programs enables a greater number of people to use a large body of free software. For example, permission to use the GNU C Library in non-free programs enables many more people to use the whole GNU operating system, as well as its variant, the GNU/Linux operating system.

Although the Lesser General Public License is Less protective of the users' freedom, it does ensure that the user of a program that is linked with the Library has the freedom and the wherewithal to run that program using a modified version of the Library.

The precise terms and conditions for copying, distribution and modification follow. Pay close attention to the difference between a "work based on the library" and a "work that uses the library". The former contains code derived from the library, whereas the latter must be combined with the library in order to run.

GNU LESSER GENERAL PUBLIC LICENSE TERMS AND CONDITIONS FOR COPYING, DISTRIBUTION AND MODIFICATION

0. This License Agreement applies to any software library or other program which contains a notice placed by the copyright holder or

other authorized party saying it may be distributed under the terms of this Lesser General Public License (also called "this License"). Each licensee is addressed as "you".

A "library" means a collection of software functions and/or data prepared so as to be conveniently linked with application programs (which use some of those functions and data) to form executables.

The "Library", below, refers to any such software library or work which has been distributed under these terms. A "work based on the Library" means either the Library or any derivative work under copyright law: that is to say, a work containing the Library or a portion of it, either verbatim or with modifications and/or translated straightforwardly into another language. (Hereinafter, translation is included without limitation in the term "modification".)

"Source code" for a work means the preferred form of the work for making modifications to it. For a library, complete source code means all the source code for all modules it contains, plus any associated interface definition files, plus the scripts used to control compilation and installation of the library.

Activities other than copying, distribution and modification are not covered by this License; they are outside its scope. The act of running a program using the Library is not restricted, and output from such a program is covered only if its contents constitute a work based on the Library (independent of the use of the Library in a tool for writing it). Whether that is true depends on what the Library does and what the program that uses the Library does.

1. You may copy and distribute verbatim copies of the Library's complete source code as you receive it, in any medium, provided that you conspicuously and appropriately publish on each copy an appropriate copyright notice and disclaimer of warranty; keep intact all the notices that refer to this License and to the absence of any warranty; and distribute a copy of this License along with the Library.

You may charge a fee for the physical act of transferring a copy, and you may at your option offer warranty protection in exchange for a fee.

2. You may modify your copy or copies of the Library or any portion of it, thus forming a work based on the Library, and copy and distribute such modifications or work under the terms of Section 1 above, provided that you also meet all of these conditions:

a) The modified work must itself be a software library.

b) You must cause the files modified to carry prominent notices stating that you changed the files and the date of any change.

c) You must cause the whole of the work to be licensed at no charge to all third parties under the terms of this License.

d) If a facility in the modified Library refers to a function or a table of data to be supplied by an application program that uses the facility, other than as an argument passed when the facility is invoked, then you must make a good faith effort to ensure that, in the event an application does not supply such function or table, the facility still operates, and performs whatever part of its purpose remains meaningful.

(For example, a function in a library to compute square roots has a purpose that is entirely well-defined independent of the application. Therefore, Subsection 2d requires that any application-supplied function or table used by this function must be optional: if the application does not supply it, the square root function must still compute square roots.)

These requirements apply to the modified work as a whole. If identifiable sections of that work are not derived from the Library, and can be reasonably considered independent and separate works in themselves, then this License, and its terms, do not apply to those sections when you distribute them as separate works. But when you distribute the same sections as part of a whole which is a work based

on the Library, the distribution of the whole must be on the terms of this License, whose permissions for other licensees extend to the entire whole, and thus to each and every part regardless of who wrote it.

Thus, it is not the intent of this section to claim rights or contest your rights to work written entirely by you; rather, the intent is to exercise the right to control the distribution of derivative or collective works based on the Library.

In addition, mere aggregation of another work not based on the Library with the Library (or with a work based on the Library) on a volume of a storage or distribution medium does not bring the other work under the scope of this License.

3. You may opt to apply the terms of the ordinary GNU General Public License instead of this License to a given copy of the Library. To do this, you must alter all the notices that refer to this License, so that they refer to the ordinary GNU General Public License, version 2, instead of to this License. (If a newer version than version 2 of the ordinary GNU General Public License has appeared, then you can specify that version instead if you wish.) Do not make any other change in these notices.

Once this change is made in a given copy, it is irreversible for that copy, so the ordinary GNU General Public License applies to all subsequent copies and derivative works made from that copy.

This option is useful when you wish to copy part of the code of the Library into a program that is not a library.

4. You may copy and distribute the Library (or a portion or derivative of it, under Section 2) in object code or executable form under the terms of Sections 1 and 2 above provided that you accompany it with the complete corresponding machine-readable source code, which must be distributed under the terms of Sections 1 and 2 above on a medium customarily used for software interchange.

If distribution of object code is made by offering access to copy from a designated place, then offering equivalent access to copy the source code from the same place satisfies the requirement to distribute the source code, even though third parties are not compelled to copy the source along with the object code.

5. A program that contains no derivative of any portion of the Library, but is designed to work with the Library by being compiled or linked with it, is called a "work that uses the Library". Such a work, in isolation, is not a derivative work of the Library, and therefore falls outside the scope of this License.

However, linking a "work that uses the Library" with the Library creates an executable that is a derivative of the Library (because it contains portions of the Library), rather than a "work that uses the library". The executable is therefore covered by this License. Section 6 states terms for distribution of such executables.

When a "work that uses the Library" uses material from a header file that is part of the Library, the object code for the work may be a derivative work of the Library even though the source code is not. Whether this is true is especially significant if the work can be linked without the Library, or if the work is itself a library. The threshold for this to be true is not precisely defined by law.

If such an object file uses only numerical parameters, data structure layouts and accessors, and small macros and small inline functions (ten lines or less in length), then the use of the object file is unrestricted, regardless of whether it is legally a derivative work. (Executables containing this object code plus portions of the Library will still fall under Section 6.)

Otherwise, if the work is a derivative of the Library, you may distribute the object code for the work under the terms of Section 6. Any executables containing that work also fall under Section 6, whether or not they are linked directly with the Library itself.

6. As an exception to the Sections above, you may also combine or

link a "work that uses the Library" with the Library to produce a work containing portions of the Library, and distribute that work under terms of your choice, provided that the terms permit modification of the work for the customer's own use and reverse engineering for debugging such modifications.

You must give prominent notice with each copy of the work that the Library is used in it and that the Library and its use are covered by this License. You must supply a copy of this License. If the work during execution displays copyright notices, you must include the copyright notice for the Library among them, as well as a reference directing the user to the copy of this License. Also, you must do one of these things:

a) Accompany the work with the complete corresponding machine-readable source code for the Library including whatever changes were used in the work (which must be distributed under Sections 1 and 2 above); and, if the work is an executable linked with the Library, with the complete machine-readable "work that uses the Library", as object code and/or source code, so that the user can modify the Library and then relink to produce a modified executable containing the modified Library. (It is understood that the user who changes the contents of definitions files in the Library will not necessarily be able to recompile the application to use the modified definitions.)

b) Use a suitable shared library mechanism for linking with the Library. A suitable mechanism is one that (1) uses at run time a copy of the library already present on the user's computer system, rather than copying library functions into the executable, and (2) will operate properly with a modified version of the library, if the user installs one, as long as the modified version is interface-compatible with the version that the work was made with.

c) Accompany the work with a written offer, valid for at least three years, to give the same user the materials specified in Subsection 6a, above, for a charge no more than the cost of performing this distribution.

d) If distribution of the work is made by offering access to copy from a designated place, offer equivalent access to copy the above specified materials from the same place.

e) Verify that the user has already received a copy of these materials or that you have already sent this user a copy.

For an executable, the required form of the "work that uses the Library" must include any data and utility programs needed for reproducing the executable from it. However, as a special exception, the materials to be distributed need not include anything that is normally distributed (in either source or binary form) with the major components (compiler, kernel, and so on) of the operating system on which the executable runs, unless that component itself accompanies the executable.

It may happen that this requirement contradicts the license restrictions of other proprietary libraries that do not normally accompany the operating system. Such a contradiction means you cannot use both them and the Library together in an executable that you distribute.

7. You may place library facilities that are a work based on the Library side-by-side in a single library together with other library facilities not covered by this License, and distribute such a combined library, provided that the separate distribution of the work based on the Library and of the other library facilities is otherwise permitted, and provided that you do these two things:

a) Accompany the combined library with a copy of the same work based on the Library, uncombined with any other library facilities. This must be distributed under the terms of the Sections above.

b) Give prominent notice with the combined library of the fact that part of it is a work based on the Library, and explaining where to find the accompanying uncombined form of the same work.

8. You may not copy, modify, sublicense, link with, or distribute the Library except as expressly provided under this License. Any attempt otherwise to copy, modify, sublicense, link with, or distribute the Library is void, and will automatically terminate your rights under this License. However, parties who have received copies, or rights, from you under this License will not have their licenses terminated so long as such parties remain in full compliance.

9. You are not required to accept this License, since you have not signed it. However, nothing else grants you permission to modify or distribute the Library or its derivative works. These actions are prohibited by law if you do not accept this License. Therefore, by modifying or distributing the Library (or any work based on the Library), you indicate your acceptance of this License to do so, and all its terms and conditions for copying, distributing or modifying the Library or works based on it.

10. Each time you redistribute the Library (or any work based on the Library), the recipient automatically receives a license from the original licensor to copy, distribute, link with or modify the Library subject to these terms and conditions. You may not impose any further restrictions on the recipients' exercise of the rights granted herein. You are not responsible for enforcing compliance by third parties with this License.

11. If, as a consequence of a court judgment or allegation of patent infringement or for any other reason (not limited to patent issues), conditions are imposed on you (whether by court order, agreement or otherwise) that contradict the conditions of this License, they do not excuse you from the conditions of this License. If you cannot distribute so as to satisfy simultaneously your obligations under this License and any other pertinent obligations, then as a consequence you may not distribute the Library at all. For example, if a patent license would not permit royalty-free redistribution of the Library by all those who receive copies directly or indirectly through you, then the only way you could satisfy both it and this License would be to refrain entirely from distribution of the Library.

If any portion of this section is held invalid or unenforceable under any particular circumstance, the balance of the section is intended to apply, and the section as a whole is intended to apply in other circumstances.

It is not the purpose of this section to induce you to infringe any patents or other property right claims or to contest validity of any such claims; this section has the sole purpose of protecting the integrity of the free software distribution system which is implemented by public license practices. Many people have made generous contributions to the wide range of software distributed through that system in reliance on consistent application of that system; it is up to the author/donor to decide if he or she is willing to distribute software through any other system and a licensee cannot impose that choice.

This section is intended to make thoroughly clear what is believed to be a consequence of the rest of this License.

12. If the distribution and/or use of the Library is restricted in certain countries either by patents or by copyrighted interfaces, the original copyright holder who places the Library under this License may add an explicit geographical distribution limitation excluding those countries, so that distribution is permitted only in or among countries not thus excluded. In such case, this License incorporates the limitation as if written in the body of this License.

13. The Free Software Foundation may publish revised and/or new versions of the Lesser General Public License from time to time. Such new versions will be similar in spirit to the present version, but may differ in detail to address new problems or concerns.

Each version is given a distinguishing version number. If the Library specifies a version number of this License which applies to it and "any later version", you have the option of following the terms and conditions either of that version or of any later version published by the Free Software Foundation. If the Library does not specify a license version number, you may choose any version ever published by

the Free Software Foundation.

14. If you wish to incorporate parts of the Library into other free programs whose distribution conditions are incompatible with these, write to the author to ask for permission. For software which is copyrighted by the Free Software Foundation, write to the Free Software Foundation; we sometimes make exceptions for this. Our decision will be guided by the two goals of preserving the free status of all derivatives of our free software and of promoting the sharing and reuse of software generally.

NO WARRANTY

15. BECAUSE THE LIBRARY IS LICENSED FREE OF CHARGE, THERE IS NO WARRANTY FOR THE LIBRARY, TO THE EXTENT PERMITTED BY APPLICABLE LAW. EXCEPT WHEN OTHERWISE STATED IN WRITING THE COPYRIGHT HOLDERS AND/OR OTHER PARTIES PROVIDE THE LIBRARY "AS IS" WITHOUT WARRANTY OF ANY KIND, EITHER EXPRESSED OR IMPLIED, INCLUDING, BUT NOT LIMITED TO, THE IMPLIED WARRANTIES OF MERCHANTABILITY AND FITNESS FOR A PARTICULAR PURPOSE. THE ENTIRE RISK AS TO THE QUALITY AND PERFORMANCE OF THE LIBRARY IS WITH YOU. SHOULD THE LIBRARY PROVE DEFECTIVE, YOU ASSUME THE COST OF ALL NECESSARY SERVICING, REPAIR OR CORRECTION.

16. IN NO EVENT UNLESS REQUIRED BY APPLICABLE LAW OR AGREED TO IN WRITING WILL ANY COPYRIGHT HOLDER, OR ANY OTHER PARTY WHO MAY MODIFY AND/OR REDISTRIBUTE THE LIBRARY AS PERMITTED ABOVE, BE LIABLE TO YOU FOR DAMAGES, INCLUDING ANY GENERAL, SPECIAL, INCIDENTAL OR CONSEQUENTIAL DAMAGES ARISING OUT OF THE USE OR INABILITY TO USE THE LIBRARY (INCLUDING BUT NOT LIMITED TO LOSS OF DATA OR DATA BEING RENDERED INACCURATE OR LOSSES SUSTAINED BY YOU OR THIRD PARTIES OR A FAILURE OF THE LIBRARY TO OPERATE WITH ANY OTHER SOFTWARE), EVEN IF SUCH HOLDER OR OTHER PARTY HAS BEEN ADVISED OF THE POSSIBILITY OF SUCH DAMAGES.

END OF TERMS AND CONDITIONS

How to Apply These Terms to Your New Libraries

If you develop a new library, and you want it to be of the greatest possible use to the public, we recommend making it free software that everyone can redistribute and change. You can do so by permitting redistribution under these terms (or, alternatively, under the terms of the ordinary General Public License).

To apply these terms, attach the following notices to the library. It is safest to attach them to the start of each source file to most effectively convey the exclusion of warranty; and each file should have at least the "copyright" line and a pointer to where the full notice is found.

<one line to give the library's name and a brief idea of what it does.>

Copyright (C) <year> <name of author>

This library is free software; you can redistribute it and/or modify it under the terms of the GNU Lesser General Public License as published by the Free Software Foundation; either version 2.1 of the License, or (at your option) any later version.

This library is distributed in the hope that it will be useful, but WITHOUT ANY WARRANTY; without even the implied warranty of MERCHANTABILITY or FITNESS FOR A PARTICULAR PURPOSE. See the GNU Lesser General Public License for more details.

You should have received a copy of the GNU Lesser General Public License along with this library; if not, write to the Free Software Foundation, Inc., 51 Franklin Street, Fifth Floor, Boston, MA 02110-1301 USA

Also add information on how to contact you by electronic and paper mail.

You should also get your employer (if you work as a programmer) or your school, if any, to sign a "copyright disclaimer" for the library, if necessary. Here is a sample; alter the names:

Yoyodyne, Inc., hereby disclaims all copyright interest in the library `Frob' (a library for tweaking knobs) written by James Random Hacker.

<signature of Ty Coon>, 1 April 1990

Ty Coon, President of Vice

That's all there is to it!

=====
=====

* Translation Snippets provided by Squid Project Translators held in
* copyright for open distribution.

*

* Translation Snippets provided by Rosetta Project Translators held in
* copyright for open distribution.

*

* Copyright 2009

*

* Redistribution and use in source and binary forms, with or without
* modification, are permitted provided that the following conditions
* are met:

* 1. Redistributions of source code must retain the above copyright
* notice, this list of conditions and the following disclaimer.

* 2. Redistributions in binary form must reproduce the above copyright
* notice, this list of conditions and the following disclaimer in the
* documentation and/or other materials provided with the distribution.

* 3. Neither the name of the University nor the names of its contributors
* may be used to endorse or promote products derived from this software
* without specific prior written permission.

*

* THIS SOFTWARE IS PROVIDED BY THE REGENTS AND CONTRIBUTORS ``AS IS" AND
* ANY EXPRESS OR IMPLIED WARRANTIES, INCLUDING, BUT NOT LIMITED TO, THE
* IMPLIED WARRANTIES OF MERCHANTABILITY AND FITNESS FOR A PARTICULAR
PURPOSE

* ARE DISCLAIMED. IN NO EVENT SHALL THE REGENTS OR CONTRIBUTORS BE LIABLE
* FOR ANY DIRECT, INDIRECT, INCIDENTAL, SPECIAL, EXEMPLARY, OR CONSEQUENTIAL
* DAMAGES (INCLUDING, BUT NOT LIMITED TO, PROCUREMENT OF SUBSTITUTE GOODS
* OR SERVICES; LOSS OF USE, DATA, OR PROFITS; OR BUSINESS INTERRUPTION)

* HOWEVER CAUSED AND ON ANY THEORY OF LIABILITY, WHETHER IN CONTRACT,
STRICT

* LIABILITY, OR TORT (INCLUDING NEGLIGENCE OR OTHERWISE) ARISING IN ANY WAY

* OUT OF THE USE OF THIS SOFTWARE, EVEN IF ADVISED OF THE POSSIBILITY OF
* SUCH DAMAGE.

see TRANSLATORS file for current contributing translators holding copyrights.

* Livingston Enterprises, Inc.

* 6920 Koll Center Parkway

* Pleasanton, CA 94566

*

* Copyright 1992 Livingston Enterprises, Inc.

*

* Permission to use, copy, modify, and distribute this software for any
* purpose and without fee is hereby granted, provided that this
* copyright and permission notice appear on all copies and supporting
* documentation, the name of Livingston Enterprises, Inc. not be used
* in advertising or publicity pertaining to distribution of the
* program without specific prior permission, and notice be given
* in supporting documentation that copying and distribution is by
* permission of Livingston Enterprises, Inc.

*

* Livingston Enterprises, Inc. makes no representations about
* the suitability of this software for any purpose. It is
* provided "as is" without express or implied warranty.

*

* The new parts of the code is Copyright (C) 1998 R.M. van Selm <selm@cistron.nl>

* with modifications

* Copyright (C) 2004 Henrik Nordstrom <hno@squid-cache.org>

* Copyright (C) 2006 Henrik Nordstrom hno@squid-cache.org

=====
=====

Copyright (C) 2004 Henrik Nordstrom

Permission to use, copy, modify, and distribute this software for any purpose
and without fee is hereby granted, provided that this copyright and permission
notice appear on all copies and supporting documentation, the name of Henrik

Nordstrom. not be used in advertising or publicity pertaining to distribution of the program without specific prior permission.

The author makes no representations about the suitability of this documentation for any purpose. It is provided "as is" without express or implied warranty.

Henrik Nordstrom <hno@squid-cache.org>

=====
=====

Copyright 1988, 1989 by Carnegie Mellon University

All Rights Reserved

Permission to use, copy, modify, and distribute this software and its documentation for any purpose and without fee is hereby granted, provided that the above copyright notice appear in all copies and that both that copyright notice and this permission notice appear in supporting documentation, and that the name of CMU not be used in advertising or publicity pertaining to distribution of the software without specific, written prior permission.

CMU DISCLAIMS ALL WARRANTIES WITH REGARD TO THIS SOFTWARE, INCLUDING ALL IMPLIED WARRANTIES OF MERCHANTABILITY AND FITNESS, IN NO EVENT SHALL CMU BE LIABLE FOR ANY SPECIAL, INDIRECT OR CONSEQUENTIAL DAMAGES OR ANY DAMAGES WHATSOEVER RESULTING FROM LOSS OF USE, DATA OR PROFITS, WHETHER IN AN ACTION OF CONTRACT, NEGLIGENCE OR OTHER TORTIOUS ACTION, ARISING OUT OF OR IN CONNECTION WITH THE USE OR PERFORMANCE OF THIS SOFTWARE.

* Copyright 1997 by Carnegie Mellon University

*

* All Rights Reserved

*

* Permission to use, copy, modify, and distribute this software and its

* documentation for any purpose and without fee is hereby granted,

* provided that the above copyright notice appear in all copies and that

* both that copyright notice and this permission notice appear in
* supporting documentation, and that the name of CMU not be
* used in advertising or publicity pertaining to distribution of the
* software without specific, written prior permission.
*
* CMU DISCLAIMS ALL WARRANTIES WITH REGARD TO THIS SOFTWARE, INCLUDING
* ALL IMPLIED WARRANTIES OF MERCHANTABILITY AND FITNESS, IN NO EVENT SHALL
* CMU BE LIABLE FOR ANY SPECIAL, INDIRECT OR CONSEQUENTIAL DAMAGES OR
* ANY DAMAGES WHATSOEVER RESULTING FROM LOSS OF USE, DATA OR PROFITS,
* WHETHER IN AN ACTION OF CONTRACT, NEGLIGENCE OR OTHER TORTIOUS ACTION,
* ARISING OUT OF OR IN CONNECTION WITH THE USE OR PERFORMANCE OF THIS
* SOFTWARE.
*
* Author: Ryan Troll ryan+@andrew.cmu.edu

// Author: Jens-S. Voেকler <voeckler@rvs.uni-hannover.de>

// (c) 1997 Lehrgebiet Rechnernetze und Verteilte Systeme

// Universit?t Hannover, Germany

//

// Permission to use, copy, modify, distribute, and sell this software
// and its documentation for any purpose is hereby granted without fee,
// provided that (i) the above copyright notices and this permission
// notice appear in all copies of the software and related documentation,
// and (ii) the names of the Lehrgebiet Rechnernetze und Verteilte
// Systeme and the University of Hannover may not be used in any
// advertising or publicity relating to the software without the
// specific, prior written permission of Lehrgebiet Rechnernetze und
// Verteilte Systeme and the University of Hannover.

//

// THE SOFTWARE IS PROVIDED "AS-IS" AND WITHOUT WARRANTY OF ANY KIND,
// EXPRESS, IMPLIED OR OTHERWISE, INCLUDING WITHOUT LIMITATION, ANY
// WARRANTY OF MERCHANTABILITY OR FITNESS FOR A PARTICULAR PURPOSE.

//

// IN NO EVENT SHALL THE LEHRGEBIET RECHNERNETZE UND VERTEILTE SYSTEME OR
// THE UNIVERSITY OF HANNOVER BE LIABLE FOR ANY SPECIAL, INCIDENTAL,
// INDIRECT OR CONSEQUENTIAL DAMAGES OF ANY KIND, OR ANY DAMAGES
// WHATSOEVER RESULTING FROM LOSS OF USE, DATA OR PROFITS, WHETHER OR NOT

// ADVISED OF THE POSSIBILITY OF DAMAGE, AND ON ANY THEORY OF LIABILITY,
// ARISING OUT OF OR IN CONNECTION WITH THE USE OR PERFORMANCE OF THIS
// SOFTWARE.

=====

// (c) 1997 - 2000 Lehrgebiet Rechnernetze und Verteilte Systeme
// Universit?t Hannover, Germany
//

// Permission to use, copy, modify, distribute, and sell this software
// and its documentation for any purpose is hereby granted without fee,
// provided that (i) the above copyright notices and this permission
// notice appear in all copies of the software and related documentation,
// and (ii) the names of the Lehrgebiet Rechnernetze und Verteilte
// Systeme and the University of Hannover may not be used in any
// advertising or publicity relating to the software without the
// specific, prior written permission of Lehrgebiet Rechnernetze und
// Verteilte Systeme and the University of Hannover.

// THE SOFTWARE IS PROVIDED "AS-IS" AND WITHOUT WARRANTY OF ANY KIND,
// EXPRESS, IMPLIED OR OTHERWISE, INCLUDING WITHOUT LIMITATION, ANY
// WARRANTY OF MERCHANTABILITY OR FITNESS FOR A PARTICULAR PURPOSE.

// IN NO EVENT SHALL THE LEHRGEBIET RECHNERNETZE UND VERTEILTE SYSTEME OR
// THE UNIVERSITY OF HANNOVER BE LIABLE FOR ANY SPECIAL, INCIDENTAL,
// INDIRECT OR CONSEQUENTIAL DAMAGES OF ANY KIND, OR ANY DAMAGES
// WHATSOEVER RESULTING FROM LOSS OF USE, DATA OR PROFITS, WHETHER OR NOT
// ADVISED OF THE POSSIBILITY OF DAMAGE, AND ON ANY THEORY OF LIABILITY,
// ARISING OUT OF OR IN CONNECTION WITH THE USE OR PERFORMANCE OF THIS
// SOFTWARE.

// Author: Jens-S. Vo?ckler <voeckler@rvs.uni-hannover.de>
//
// File: socket.hh
// Sun May 3 1998

```
//  
// (c) 1998 Lehrgebiet Rechnernetze und Verteilte Systeme  
// Universit?t Hannover, Germany  
//  
// Books: W. Richard Steven, "Advanced Programming in the UNIX Environment",  
// Addison-Wesley, 1992.  
//  
// Permission to use, copy, modify, distribute, and sell this software  
// and its documentation for any purpose is hereby granted without fee,  
// provided that (i) the above copyright notices and this permission  
// notice appear in all copies of the software and related documentation,  
// and (ii) the names of the Lehrgebiet Rechnernetze und Verteilte  
// Systeme and the University of Hannover may not be used in any  
// advertising or publicity relating to the software without the  
// specific, prior written permission of Lehrgebiet Rechnernetze und  
// Verteilte Systeme and the University of Hannover.  
//  
// THE SOFTWARE IS PROVIDED "AS-IS" AND WITHOUT WARRANTY OF ANY KIND,  
// EXPRESS, IMPLIED OR OTHERWISE, INCLUDING WITHOUT LIMITATION, ANY  
// WARRANTY OF MERCHANTABILITY OR FITNESS FOR A PARTICULAR PURPOSE.  
//  
// IN NO EVENT SHALL THE LEHRGEBIET RECHNERNETZE UND VERTEILTE SYSTEME OR  
// THE UNIVERSITY OF HANNOVER BE LIABLE FOR ANY SPECIAL, INCIDENTAL,  
// INDIRECT OR CONSEQUENTIAL DAMAGES OF ANY KIND, OR ANY DAMAGES  
// WHATSOEVER RESULTING FROM LOSS OF USE, DATA OR PROFITS, WHETHER OR NOT  
// ADVISED OF THE POSSIBILITY OF DAMAGE, AND ON ANY THEORY OF LIABILITY,  
// ARISING OUT OF OR IN CONNECTION WITH THE USE OR PERFORMANCE OF THIS  
// SOFTWARE.  
//  
// Revision 1.3 1999/01/19 11:00:50 voeckler  
// Linux glibc2 fixes for socket size parameters.  
//  
// Revision 1.2 1998/08/27 15:23:39 voeckler  
// added TCP_NODELAY options at several places.  
//  
// Revision 1.1 1998/08/13 21:52:55 voeckler  
// Initial revision
```

```
// Author: Jens-S. Voeckler <voeckler@rvs.uni-hannover.de>
//
// File: squid-tlv.cc
// Tue Jun 15 1999
//
// (c) 1999 Lehrgebiet Rechnernetze und Verteilte Systeme
// Universit?t Hannover, Germany
//
// Permission to use, copy, modify, distribute, and sell this software
// and its documentation for any purpose is hereby granted without fee,
// provided that (i) the above copyright notices and this permission
// notice appear in all copies of the software and related documentation,
// and (ii) the names of the Lehrgebiet Rechnernetze und Verteilte
// Systeme and the University of Hannover may not be used in any
// advertising or publicity relating to the software without the
// specific, prior written permission of Lehrgebiet Rechnernetze und
// Verteilte Systeme and the University of Hannover.
//
// THE SOFTWARE IS PROVIDED "AS-IS" AND WITHOUT WARRANTY OF ANY KIND,
// EXPRESS, IMPLIED OR OTHERWISE, INCLUDING WITHOUT LIMITATION, ANY
// WARRANTY OF MERCHANTABILITY OR FITNESS FOR A PARTICULAR PURPOSE.
//
// IN NO EVENT SHALL THE LEHRGEBIET RECHNERNETZE UND VERTEILTE SYSTEME OR
// THE UNIVERSITY OF HANNOVER BE LIABLE FOR ANY SPECIAL, INCIDENTAL,
// INDIRECT OR CONSEQUENTIAL DAMAGES OF ANY KIND, OR ANY DAMAGES
// WHATSOEVER RESULTING FROM LOSS OF USE, DATA OR PROFITS, WHETHER OR NOT
// ADVISED OF THE POSSIBILITY OF DAMAGE, AND ON ANY THEORY OF LIABILITY,
// ARISING OUT OF OR IN CONNECTION WITH THE USE OR PERFORMANCE OF THIS
// SOFTWARE.
//
// Revision 1.1 1999/06/15 21:10:16 voeckler
// Initial revision
//
// Author: Jens-S. Voeckler <voeckler@rvs.uni-hannover.de>
//
// File: conffile.cc
// Fri Sep 15 2000
```

```
//
// (c) 2000 Lehrgebiet Rechnernetze und Verteilte Systeme
// Universit?t Hannover, Germany
//
// Permission to use, copy, modify, distribute, and sell this software
// and its documentation for any purpose is hereby granted without fee,
// provided that (i) the above copyright notices and this permission
// notice appear in all copies of the software and related documentation,
// and (ii) the names of the Lehrgebiet Rechnernetze und Verteilte
// Systeme and the University of Hannover may not be used in any
// advertising or publicity relating to the software without the
// specific, prior written permission of Lehrgebiet Rechnernetze und
// Verteilte Systeme and the University of Hannover.
//
// THE SOFTWARE IS PROVIDED "AS-IS" AND WITHOUT WARRANTY OF ANY KIND,
// EXPRESS, IMPLIED OR OTHERWISE, INCLUDING WITHOUT LIMITATION, ANY
// WARRANTY OF MERCHANTABILITY OR FITNESS FOR A PARTICULAR PURPOSE.
//
// IN NO EVENT SHALL THE LEHRGEBIET RECHNERNETZE UND VERTEILTE SYSTEME OR
// THE UNIVERSITY OF HANNOVER BE LIABLE FOR ANY SPECIAL, INCIDENTAL,
// INDIRECT OR CONSEQUENTIAL DAMAGES OF ANY KIND, OR ANY DAMAGES
// WHATSOEVER RESULTING FROM LOSS OF USE, DATA OR PROFITS, WHETHER OR NOT
// ADVISED OF THE POSSIBILITY OF DAMAGE, AND ON ANY THEORY OF LIABILITY,
// ARISING OUT OF OR IN CONNECTION WITH THE USE OR PERFORMANCE OF THIS
// SOFTWARE.
//
// Revision 1.1 2000/09/21 09:44:53 voeckler
// Initial revision

// Author: Jens-S. V?ckler <voeckler@rvs.uni-hannover.de>
//
// File: convert.hh
// Thu Oct 30 1997
//
// (c) 1997 Lehrgebiet Rechnernetze und Verteilte Systeme
// Universit?t Hannover, Germany
//
// Permission to use, copy, modify, distribute, and sell this software
```

```
// and its documentation for any purpose is hereby granted without fee,  
// provided that (i) the above copyright notices and this permission  
// notice appear in all copies of the software and related documentation,  
// and (ii) the names of the Lehrgebiet Rechnernetze und Verteilte  
// Systeme and the University of Hannover may not be used in any  
// advertising or publicity relating to the software without the  
// specific, prior written permission of Lehrgebiet Rechnernetze und  
// Verteilte Systeme and the University of Hannover.  
//  
// THE SOFTWARE IS PROVIDED "AS-IS" AND WITHOUT WARRANTY OF ANY KIND,  
// EXPRESS, IMPLIED OR OTHERWISE, INCLUDING WITHOUT LIMITATION, ANY  
// WARRANTY OF MERCHANTABILITY OR FITNESS FOR A PARTICULAR PURPOSE.  
//  
// IN NO EVENT SHALL THE LEHRGEBIET RECHNERNETZE UND VERTEILTE SYSTEME OR  
// THE UNIVERSITY OF HANNOVER BE LIABLE FOR ANY SPECIAL, INCIDENTAL,  
// INDIRECT OR CONSEQUENTIAL DAMAGES OF ANY KIND, OR ANY DAMAGES  
// WHATSOEVER RESULTING FROM LOSS OF USE, DATA OR PROFITS, WHETHER OR NOT  
// ADVISED OF THE POSSIBILITY OF DAMAGE, AND ON ANY THEORY OF LIABILITY,  
// ARISING OUT OF OR IN CONNECTION WITH THE USE OR PERFORMANCE OF THIS  
// SOFTWARE.  
//  
// Revision 1.2 1999/01/19 11:00:50 voeckler  
// added bool type workaround.  
//  
// Revision 1.1 1998/08/13 21:38:04 voeckler  
// Initial revision  
  
// Author: Jens-S. V?ckler <voeckler@rvs.uni-hannover.de>  
//  
// File: copyout.cc  
// Tue Jun 15 1999  
//  
// (c) 1999 Lehrgebiet Rechnernetze und Verteilte Systeme  
// Universit?t Hannover, Germany  
//  
// Permission to use, copy, modify, distribute, and sell this software  
// and its documentation for any purpose is hereby granted without fee,  
// provided that (i) the above copyright notices and this permission
```

```
// notice appear in all copies of the software and related documentation,  
// and (ii) the names of the Lehrgebiet Rechnernetze und Verteilte  
// Systeme and the University of Hannover may not be used in any  
// advertising or publicity relating to the software without the  
// specific, prior written permission of Lehrgebiet Rechnernetze und  
// Verteilte Systeme and the University of Hannover.  
//  
// THE SOFTWARE IS PROVIDED "AS-IS" AND WITHOUT WARRANTY OF ANY KIND,  
// EXPRESS, IMPLIED OR OTHERWISE, INCLUDING WITHOUT LIMITATION, ANY  
// WARRANTY OF MERCHANTABILITY OR FITNESS FOR A PARTICULAR PURPOSE.  
//  
// IN NO EVENT SHALL THE LEHRGEBIET RECHNERNETZE UND VERTEILTE SYSTEME OR  
// THE UNIVERSITY OF HANNOVER BE LIABLE FOR ANY SPECIAL, INCIDENTAL,  
// INDIRECT OR CONSEQUENTIAL DAMAGES OF ANY KIND, OR ANY DAMAGES  
// WHATSOEVER RESULTING FROM LOSS OF USE, DATA OR PROFITS, WHETHER OR NOT  
// ADVISED OF THE POSSIBILITY OF DAMAGE, AND ON ANY THEORY OF LIABILITY,  
// ARISING OUT OF OR IN CONNECTION WITH THE USE OR PERFORMANCE OF THIS  
// SOFTWARE.  
//  
// Revision 1.2 1999/06/16 13:05:26 voeckler  
// mmap file copying on Solaris.  
//  
// Revision 1.1 1999/06/15 21:10:47 voeckler  
// Initial revision
```

* Copyright (c) 2009-2014, Treehouse Networks Ltd. New Zealand

* All rights reserved.

*

* Redistribution and use in source and binary forms, with or without

* modification, are permitted provided that the following conditions

* are met:

*

* 1. Redistributions of source code must retain the above copyright

* notice, this list of conditions and the following disclaimer.

*

* 2. Redistributions in binary form must reproduce the above copyright

* notice, this list of conditions and the following disclaimer in the

* documentation and/or other materials provided with the distribution.

*

* THIS SOFTWARE IS PROVIDED BY THE COPYRIGHT HOLDERS AND CONTRIBUTORS
* "AS IS" AND ANY EXPRESS OR IMPLIED WARRANTIES, INCLUDING, BUT NOT
* LIMITED TO, THE IMPLIED WARRANTIES OF MERCHANTABILITY AND FITNESS
* FOR A PARTICULAR PURPOSE ARE DISCLAIMED. IN NO EVENT SHALL THE
* COPYRIGHT HOLDER OR CONTRIBUTORS BE LIABLE FOR ANY DIRECT, INDIRECT,
* INCIDENTAL, SPECIAL, EXEMPLARY, OR CONSEQUENTIAL DAMAGES (INCLUDING,
* BUT NOT LIMITED TO, PROCUREMENT OF SUBSTITUTE GOODS OR SERVICES;
* LOSS OF USE, DATA, OR PROFITS; OR BUSINESS INTERRUPTION) HOWEVER
* CAUSED AND ON ANY THEORY OF LIABILITY, WHETHER IN CONTRACT, STRICT
* LIABILITY, OR TORT (INCLUDING NEGLIGENCE OR OTHERWISE) ARISING IN
* ANY WAY OUT OF THE USE OF THIS SOFTWARE, EVEN IF ADVISED OF THE
* POSSIBILITY OF SUCH DAMAGE.

* Copyright 2004 The Aerospace Corporation. All rights reserved.

*

* Redistribution and use in source and binary forms, with or without
* modification, are permitted provided that the following conditions
* are met:

*

- * 1. Redistributions of source code must retain the above copyright
* notice, this list of conditions, and the following disclaimer.
- * 2. Redistributions in binary form must reproduce the above copyright
* notice, this list of conditions, and the following disclaimer in the
* documentation and/or other materials provided with the distribution.
- * 3. The name of The Aerospace Corporation may not be used to endorse or
* promote products derived from this software.

*

* THIS SOFTWARE IS PROVIDED BY THE AEROSPACE CORPORATION "AS IS" AND
* ANY EXPRESS OR IMPLIED WARRANTIES, INCLUDING, BUT NOT LIMITED TO, THE
* IMPLIED WARRANTIES OF MERCHANTABILITY AND FITNESS FOR A PARTICULAR
* PURPOSE
* ARE DISCLAIMED. IN NO EVENT SHALL THE AEROSPACE CORPORATION BE LIABLE
* FOR ANY DIRECT, INDIRECT, INCIDENTAL, SPECIAL, EXEMPLARY, OR CONSEQUENTIAL
* DAMAGES (INCLUDING, BUT NOT LIMITED TO, PROCUREMENT OF SUBSTITUTE GOODS
* OR SERVICES; LOSS OF USE, DATA, OR PROFITS; OR BUSINESS INTERRUPTION)
* HOWEVER CAUSED AND ON ANY THEORY OF LIABILITY, WHETHER IN CONTRACT,
* STRICT

* LIABILITY, OR TORT (INCLUDING NEGLIGENCE OR OTHERWISE) ARISING IN ANY WAY
* OUT OF THE USE OF THIS SOFTWARE, EVEN IF ADVISED OF THE POSSIBILITY OF
* SUCH DAMAGE.

*

* Copyright (c) 1995

* Bill Paul <wpaul@ctr.columbia.edu>. All rights reserved.

*

* Redistribution and use in source and binary forms, with or without
* modification, are permitted provided that the following conditions
* are met:

* 1. Redistributions of source code must retain the above copyright
* notice, this list of conditions and the following disclaimer.

* 2. Redistributions in binary form must reproduce the above copyright
* notice, this list of conditions and the following disclaimer in the
* documentation and/or other materials provided with the distribution.

* 3. All advertising materials mentioning features or use of this software
* must display the following acknowledgement:

* This product includes software developed by Bill Paul.

* 4. Neither the name of the author nor the names of any co-contributors
* may be used to endorse or promote products derived from this software
* without specific prior written permission.

*

* THIS SOFTWARE IS PROVIDED BY Bill Paul AND CONTRIBUTORS ``AS IS'' AND
* ANY EXPRESS OR IMPLIED WARRANTIES, INCLUDING, BUT NOT LIMITED TO, THE
* IMPLIED WARRANTIES OF MERCHANTABILITY AND FITNESS FOR A PARTICULAR
* PURPOSE

* ARE DISCLAIMED. IN NO EVENT SHALL THE REGENTS OR CONTRIBUTORS BE LIABLE
* FOR ANY DIRECT, INDIRECT, INCIDENTAL, SPECIAL, EXEMPLARY, OR CONSEQUENTIAL
* DAMAGES (INCLUDING, BUT NOT LIMITED TO, PROCUREMENT OF SUBSTITUTE GOODS
* OR SERVICES; LOSS OF USE, DATA, OR PROFITS; OR BUSINESS INTERRUPTION)
* HOWEVER CAUSED AND ON ANY THEORY OF LIABILITY, WHETHER IN CONTRACT,
* STRICT

* LIABILITY, OR TORT (INCLUDING NEGLIGENCE OR OTHERWISE) ARISING IN ANY WAY
* OUT OF THE USE OF THIS SOFTWARE, EVEN IF ADVISED OF THE POSSIBILITY OF
* SUCH DAMAGE.

*

* EUI-64 conversion and lookup routines

* Copyright (C) 1995, 1996, 1997, and 1998 WIDE Project.

* All rights reserved.

*

* Redistribution and use in source and binary forms, with or without

* modification, are permitted provided that the following conditions

* are met:

* 1. Redistributions of source code must retain the above copyright

* notice, this list of conditions and the following disclaimer.

* 2. Redistributions in binary form must reproduce the above copyright

* notice, this list of conditions and the following disclaimer in the

* documentation and/or other materials provided with the distribution.

* 3. Neither the name of the project nor the names of its contributors

* may be used to endorse or promote products derived from this software

* without specific prior written permission.

*

* THIS SOFTWARE IS PROVIDED BY THE PROJECT AND CONTRIBUTORS ``AS IS'' AND

* ANY EXPRESS OR IMPLIED WARRANTIES, INCLUDING, BUT NOT LIMITED TO, THE

* IMPLIED WARRANTIES OF MERCHANTABILITY AND FITNESS FOR A PARTICULAR

PURPOSE

* ARE DISCLAIMED. IN NO EVENT SHALL THE PROJECT OR CONTRIBUTORS BE LIABLE

* FOR ANY DIRECT, INDIRECT, INCIDENTAL, SPECIAL, EXEMPLARY, OR CONSEQUENTIAL

* DAMAGES (INCLUDING, BUT NOT LIMITED TO, PROCUREMENT OF SUBSTITUTE GOODS

* OR SERVICES; LOSS OF USE, DATA, OR PROFITS; OR BUSINESS INTERRUPTION)

* HOWEVER CAUSED AND ON ANY THEORY OF LIABILITY, WHETHER IN CONTRACT,

STRICT

* LIABILITY, OR TORT (INCLUDING NEGLIGENCE OR OTHERWISE) ARISING IN ANY WAY

* OUT OF THE USE OF THIS SOFTWARE, EVEN IF ADVISED OF THE POSSIBILITY OF

* SUCH DAMAGE.

*

* Copyright (c) 1980, 1983, 1988, 1993

* The Regents of the University of California. All rights reserved.

*

* Redistribution and use in source and binary forms, with or without

* modification, are permitted provided that the following conditions

* are met:

* 1. Redistributions of source code must retain the above copyright

* notice, this list of conditions and the following disclaimer.

* 2. Redistributions in binary form must reproduce the above copyright
* notice, this list of conditions and the following disclaimer in the
* documentation and/or other materials provided with the distribution.
* 3. All advertising materials mentioning features or use of this software
* must display the following acknowledgement:
* This product includes software developed by the University of
* California, Berkeley and its contributors.
* 4. Neither the name of the University nor the names of its contributors
* may be used to endorse or promote products derived from this software
* without specific prior written permission.
*
* THIS SOFTWARE IS PROVIDED BY THE REGENTS AND CONTRIBUTORS ``AS IS" AND
* ANY EXPRESS OR IMPLIED WARRANTIES, INCLUDING, BUT NOT LIMITED TO, THE
* IMPLIED WARRANTIES OF MERCHANTABILITY AND FITNESS FOR A PARTICULAR
PURPOSE
* ARE DISCLAIMED. IN NO EVENT SHALL THE REGENTS OR CONTRIBUTORS BE LIABLE
* FOR ANY DIRECT, INDIRECT, INCIDENTAL, SPECIAL, EXEMPLARY, OR CONSEQUENTIAL
* DAMAGES (INCLUDING, BUT NOT LIMITED TO, PROCUREMENT OF SUBSTITUTE GOODS
* OR SERVICES; LOSS OF USE, DATA, OR PROFITS; OR BUSINESS INTERRUPTION)
* HOWEVER CAUSED AND ON ANY THEORY OF LIABILITY, WHETHER IN CONTRACT,
STRICT
* LIABILITY, OR TORT (INCLUDING NEGLIGENCE OR OTHERWISE) ARISING IN ANY WAY
* OUT OF THE USE OF THIS SOFTWARE, EVEN IF ADVISED OF THE POSSIBILITY OF
* SUCH DAMAGE.

* Copyright (c) 1987, 1993, 1994

* The Regents of the University of California. All rights reserved.

*

* Redistribution and use in source and binary forms, with or without
* modification, are permitted provided that the following conditions
* are met:
* 1. Redistributions of source code must retain the above copyright
* notice, this list of conditions and the following disclaimer.
* 2. Redistributions in binary form must reproduce the above copyright
* notice, this list of conditions and the following disclaimer in the
* documentation and/or other materials provided with the distribution.
* 3. Neither the name of the University nor the names of its contributors
* may be used to endorse or promote products derived from this software

* without specific prior written permission.

*

* THIS SOFTWARE IS PROVIDED BY THE REGENTS AND CONTRIBUTORS ``AS IS" AND

* ANY EXPRESS OR IMPLIED WARRANTIES, INCLUDING, BUT NOT LIMITED TO, THE

* IMPLIED WARRANTIES OF MERCHANTABILITY AND FITNESS FOR A PARTICULAR
PURPOSE

* ARE DISCLAIMED. IN NO EVENT SHALL THE REGENTS OR CONTRIBUTORS BE LIABLE

* FOR ANY DIRECT, INDIRECT, INCIDENTAL, SPECIAL, EXEMPLARY, OR CONSEQUENTIAL

* DAMAGES (INCLUDING, BUT NOT LIMITED TO, PROCUREMENT OF SUBSTITUTE GOODS
* OR SERVICES; LOSS OF USE, DATA, OR PROFITS; OR BUSINESS INTERRUPTION)

* HOWEVER CAUSED AND ON ANY THEORY OF LIABILITY, WHETHER IN CONTRACT,
STRICT

* LIABILITY, OR TORT (INCLUDING NEGLIGENCE OR OTHERWISE) ARISING IN ANY WAY

* OUT OF THE USE OF THIS SOFTWARE, EVEN IF ADVISED OF THE POSSIBILITY OF

* SUCH DAMAGE.

* Copyright (c) 1988, 1989, 1993

* The Regents of the University of California. All rights reserved.

*

* Redistribution and use in source and binary forms, with or without

* modification, are permitted provided that the following conditions

* are met:

* 1. Redistributions of source code must retain the above copyright

* notice, this list of conditions and the following disclaimer.

* 2. Redistributions in binary form must reproduce the above copyright

* notice, this list of conditions and the following disclaimer in the

* documentation and/or other materials provided with the distribution.

* 3. Neither the name of the University nor the names of its contributors

* may be used to endorse or promote products derived from this software

* without specific prior written permission.

*

* THIS SOFTWARE IS PROVIDED BY THE REGENTS AND CONTRIBUTORS ``AS IS" AND

* ANY EXPRESS OR IMPLIED WARRANTIES, INCLUDING, BUT NOT LIMITED TO, THE

* IMPLIED WARRANTIES OF MERCHANTABILITY AND FITNESS FOR A PARTICULAR
PURPOSE

* ARE DISCLAIMED. IN NO EVENT SHALL THE REGENTS OR CONTRIBUTORS BE LIABLE

* FOR ANY DIRECT, INDIRECT, INCIDENTAL, SPECIAL, EXEMPLARY, OR CONSEQUENTIAL

* DAMAGES (INCLUDING, BUT NOT LIMITED TO, PROCUREMENT OF SUBSTITUTE GOODS

* OR SERVICES; LOSS OF USE, DATA, OR PROFITS; OR BUSINESS INTERRUPTION)
* HOWEVER CAUSED AND ON ANY THEORY OF LIABILITY, WHETHER IN CONTRACT,
STRICT
* LIABILITY, OR TORT (INCLUDING NEGLIGENCE OR OTHERWISE) ARISING IN ANY WAY
* OUT OF THE USE OF THIS SOFTWARE, EVEN IF ADVISED OF THE POSSIBILITY OF
* SUCH DAMAGE.

* Copyright (c) 1990, 1993

* The Regents of the University of California. All rights reserved.

*

* This code is derived from software contributed to Berkeley by

* Chris Torek.

*

* Redistribution and use in source and binary forms, with or without

* modification, are permitted provided that the following conditions

* are met:

* 1. Redistributions of source code must retain the above copyright

* notice, this list of conditions and the following disclaimer.

* 2. Redistributions in binary form must reproduce the above copyright

* notice, this list of conditions and the following disclaimer in the

* documentation and/or other materials provided with the distribution.

* 3. Neither the name of the University nor the names of its contributors

* may be used to endorse or promote products derived from this software

* without specific prior written permission.

*

* THIS SOFTWARE IS PROVIDED BY THE REGENTS AND CONTRIBUTORS ``AS IS'' AND

* ANY EXPRESS OR IMPLIED WARRANTIES, INCLUDING, BUT NOT LIMITED TO, THE

* IMPLIED WARRANTIES OF MERCHANTABILITY AND FITNESS FOR A PARTICULAR
PURPOSE

* ARE DISCLAIMED. IN NO EVENT SHALL THE REGENTS OR CONTRIBUTORS BE LIABLE

* FOR ANY DIRECT, INDIRECT, INCIDENTAL, SPECIAL, EXEMPLARY, OR CONSEQUENTIAL

* DAMAGES (INCLUDING, BUT NOT LIMITED TO, PROCUREMENT OF SUBSTITUTE GOODS

* OR SERVICES; LOSS OF USE, DATA, OR PROFITS; OR BUSINESS INTERRUPTION)

* HOWEVER CAUSED AND ON ANY THEORY OF LIABILITY, WHETHER IN CONTRACT,
STRICT

* LIABILITY, OR TORT (INCLUDING NEGLIGENCE OR OTHERWISE) ARISING IN ANY WAY

* OUT OF THE USE OF THIS SOFTWARE, EVEN IF ADVISED OF THE POSSIBILITY OF

* SUCH DAMAGE.

* Copyright (c) 2004 by Internet Systems Consortium, Inc. ("ISC")

* Copyright (c) 1996,1999 by Internet Software Consortium.

*

* Permission to use, copy, modify, and distribute this software for any
* purpose with or without fee is hereby granted, provided that the above
* copyright notice and this permission notice appear in all copies.

*

* THE SOFTWARE IS PROVIDED "AS IS" AND ISC DISCLAIMS ALL WARRANTIES
* WITH REGARD TO THIS SOFTWARE INCLUDING ALL IMPLIED WARRANTIES OF
* MERCHANTABILITY AND FITNESS. IN NO EVENT SHALL ISC BE LIABLE FOR
* ANY SPECIAL, DIRECT, INDIRECT, OR CONSEQUENTIAL DAMAGES OR ANY DAMAGES
* WHATSOEVER RESULTING FROM LOSS OF USE, DATA OR PROFITS, WHETHER IN AN
* ACTION OF CONTRACT, NEGLIGENCE OR OTHER TORTIOUS ACTION, ARISING OUT
* OF OR IN CONNECTION WITH THE USE OR PERFORMANCE OF THIS SOFTWARE.

* Copyright (c) 2007 Todd C. Miller <Todd.Miller@courtesan.com>

*

* Permission to use, copy, modify, and distribute this software for any
* purpose with or without fee is hereby granted, provided that the above
* copyright notice and this permission notice appear in all copies.

*

* THE SOFTWARE IS PROVIDED "AS IS" AND THE AUTHOR DISCLAIMS ALL WARRANTIES
* WITH REGARD TO THIS SOFTWARE INCLUDING ALL IMPLIED WARRANTIES OF
* MERCHANTABILITY AND FITNESS. IN NO EVENT SHALL THE AUTHOR BE LIABLE FOR
* ANY SPECIAL, DIRECT, INDIRECT, OR CONSEQUENTIAL DAMAGES OR ANY DAMAGES
* WHATSOEVER RESULTING FROM LOSS OF USE, DATA OR PROFITS, WHETHER IN AN
* ACTION OF CONTRACT, NEGLIGENCE OR OTHER TORTIOUS ACTION, ARISING OUT OF
* OR IN CONNECTION WITH THE USE OR PERFORMANCE OF THIS SOFTWARE.

Copyright 1988, 1989 by Carnegie Mellon University

All Rights Reserved

Permission to use, copy, modify, and distribute this software and its
documentation for any purpose and without fee is hereby granted,
provided that the above copyright notice appear in all copies and that
both that copyright notice and this permission notice appear in

supporting documentation, and that the name of CMU not be used in advertising or publicity pertaining to distribution of the software without specific, written prior permission.

CMU DISCLAIMS ALL WARRANTIES WITH REGARD TO THIS SOFTWARE, INCLUDING ALL IMPLIED WARRANTIES OF MERCHANTABILITY AND FITNESS, IN NO EVENT SHALL CMU BE LIABLE FOR ANY SPECIAL, INDIRECT OR CONSEQUENTIAL DAMAGES OR ANY DAMAGES WHATSOEVER RESULTING FROM LOSS OF USE, DATA OR PROFITS, WHETHER IN AN ACTION OF CONTRACT, NEGLIGENCE OR OTHER TORTIOUS ACTION, ARISING OUT OF OR IN CONNECTION WITH THE USE OR PERFORMANCE OF THIS SOFTWARE.

* -

* Portions Copyright (c) 1993 by Digital Equipment Corporation.

*

* Permission to use, copy, modify, and distribute this software for any
* purpose with or without fee is hereby granted, provided that the above
* copyright notice and this permission notice appear in all copies, and that
* the name of Digital Equipment Corporation not be used in advertising or
* publicity pertaining to distribution of the document or software without
* specific, written prior permission.

*

* THE SOFTWARE IS PROVIDED "AS IS" AND DIGITAL EQUIPMENT CORP. DISCLAIMS ALL
* WARRANTIES WITH REGARD TO THIS SOFTWARE, INCLUDING ALL IMPLIED
WARRANTIES
* OF MERCHANTABILITY AND FITNESS. IN NO EVENT SHALL DIGITAL EQUIPMENT
* CORPORATION BE LIABLE FOR ANY SPECIAL, DIRECT, INDIRECT, OR CONSEQUENTIAL
* DAMAGES OR ANY DAMAGES WHATSOEVER RESULTING FROM LOSS OF USE, DATA OR
* PROFITS, WHETHER IN AN ACTION OF CONTRACT, NEGLIGENCE OR OTHER TORTIOUS
* ACTION, ARISING OUT OF OR IN CONNECTION WITH THE USE OR PERFORMANCE OF
THIS
* SOFTWARE.

Copyright 1989 by Carnegie Mellon University

All Rights Reserved

Permission to use, copy, modify, and distribute this software and its

documentation for any purpose and without fee is hereby granted, provided that the above copyright notice appear in all copies and that both that copyright notice and this permission notice appear in supporting documentation, and that the name of CMU not be used in advertising or publicity pertaining to distribution of the software without specific, written prior permission.

CMU DISCLAIMS ALL WARRANTIES WITH REGARD TO THIS SOFTWARE, INCLUDING ALL IMPLIED WARRANTIES OF MERCHANTABILITY AND FITNESS, IN NO EVENT SHALL CMU BE LIABLE FOR ANY SPECIAL, INDIRECT OR CONSEQUENTIAL DAMAGES OR ANY DAMAGES WHATSOEVER RESULTING FROM LOSS OF USE, DATA OR PROFITS, WHETHER IN AN ACTION OF CONTRACT, NEGLIGENCE OR OTHER TORTIOUS ACTION, ARISING OUT OF OR IN CONNECTION WITH THE USE OR PERFORMANCE OF THIS SOFTWARE.

// (c) 1999 Lehrgebiet Rechnernetze und Verteilte Systeme

// Universität Hannover, Germany

//

// Permission to use, copy, modify, distribute, and sell this software

// and its documentation for any purpose is hereby granted without fee,

// provided that (i) the above copyright notices and this permission

// notice appear in all copies of the software and related documentation,

// and (ii) the names of the Lehrgebiet Rechnernetze und Verteilte

// Systeme and the University of Hannover may not be used in any

// advertising or publicity relating to the software without the

// specific, prior written permission of Lehrgebiet Rechnernetze und

// Verteilte Systeme and the University of Hannover.

//

// THE SOFTWARE IS PROVIDED "AS-IS" AND WITHOUT WARRANTY OF ANY KIND,

// EXPRESS, IMPLIED OR OTHERWISE, INCLUDING WITHOUT LIMITATION, ANY

// WARRANTY OF MERCHANTABILITY OR FITNESS FOR A PARTICULAR PURPOSE.

//

// IN NO EVENT SHALL THE LEHRGEBIET RECHNERNETZE UND VERTEILTE SYSTEME OR

// THE UNIVERSITY OF HANNOVER BE LIABLE FOR ANY SPECIAL, INCIDENTAL,

// INDIRECT OR CONSEQUENTIAL DAMAGES OF ANY KIND, OR ANY DAMAGES

// WHATSOEVER RESULTING FROM LOSS OF USE, DATA OR PROFITS, WHETHER OR NOT

// ADVISED OF THE POSSIBILITY OF DAMAGE, AND ON ANY THEORY OF LIABILITY,

// ARISING OUT OF OR IN CONNECTION WITH THE USE OR PERFORMANCE OF THIS

// SOFTWARE.

* Livingston Enterprises, Inc.

* 6920 Koll Center Parkway

* Pleasanton, CA 94566

*

* Copyright 1992 Livingston Enterprises, Inc.

* Copyright 1997 Cistron Internet Services B.V.

*

* Permission to use, copy, modify, and distribute this software for any
* purpose and without fee is hereby granted, provided that this
* copyright and permission notice appear on all copies and supporting
* documentation, the name of Livingston Enterprises, Inc. not be used
* in advertising or publicity pertaining to distribution of the
* program without specific prior permission, and notice be given
* in supporting documentation that copying and distribution is by
* permission of Livingston Enterprises, Inc.

*

* Livingston Enterprises, Inc. makes no representations about
* the suitability of this software for any purpose. It is
* provided "as is" without express or implied warranty.

This program is based on code from Livingston Enterprises, Inc. and parts are

COPYRIGHT NOTICE SQUID_RAD_AUTH

Copyright (C) 1992-1995 Livingston Enterprises, Inc and Cistron Internet Services
B.V. who both have given permission to modify and distribute those parts. The new
parts of the code is Copyright (C) 1998 R.M. van Selm <selm@cistron.nl> with
modifications Copyright (C) 2004 Henrik Nordstrom <hno@squid-cache.org>

Permission to use, copy, modify, and distribute this software for any purpose
and without fee is hereby granted, provided that this copyright and permission
notice appear on all copies and supporting documentation, the name of
Livingston Enterprises, Inc. not be used in advertising or publicity pertaining
to distribution of the program without specific prior permission, and notice be
given in supporting documentation that copying and distribution is by
permission of Livingston Enterprises, Inc. and Cistron Internet Services B.V.

Neither Livingston Enterprises, Inc. nor Cistron Internet Services B.V. nor I (R.M. van Selm) make representations about the suitability of this software for any purpose. It is provided "as is" without express or implied warranty.

```
// Author: Jens-S. Voeckler <voeckler@rvs.uni-hannover.de>
// File: signal.cc
// Date: Sat Feb 28 1998
// Compiler: gcc 2.7.2.x series
//
// Books: W. Richard Steven, "Advanced Programming in the UNIX Environment",
// Addison-Wesley, 1992.
//
// (c) 1998 Lehrgebiet Rechnernetze und Verteilte Systeme
// Universit?t Hannover, Germany
//
// Permission to use, copy, modify, distribute, and sell this software
// and its documentation for any purpose is hereby granted without fee,
// provided that (i) the above copyright notices and this permission
// notice appear in all copies of the software and related documentation,
// and (ii) the names of the Lehrgebiet Rechnernetze und Verteilte
// Systeme and the University of Hannover may not be used in any
// advertising or publicity relating to the software without the
// specific, prior written permission of Lehrgebiet Rechnernetze und
// Verteilte Systeme and the University of Hannover.
//
// THE SOFTWARE IS PROVIDED "AS-IS" AND WITHOUT WARRANTY OF ANY KIND,
// EXPRESS, IMPLIED OR OTHERWISE, INCLUDING WITHOUT LIMITATION, ANY
// WARRANTY OF MERCHANTABILITY OR FITNESS FOR A PARTICULAR PURPOSE.
//
// IN NO EVENT SHALL THE LEHRGEBIET RECHNERNETZE UND VERTEILTE SYSTEME OR
// THE UNIVERSITY OF HANNOVER BE LIABLE FOR ANY SPECIAL, INCIDENTAL,
// INDIRECT OR CONSEQUENTIAL DAMAGES OF ANY KIND, OR ANY DAMAGES
// WHATSOEVER RESULTING FROM LOSS OF USE, DATA OR PROFITS, WHETHER OR NOT
// ADVISED OF THE POSSIBILITY OF DAMAGE, AND ON ANY THEORY OF LIABILITY,
// ARISING OUT OF OR IN CONNECTION WITH THE USE OR PERFORMANCE OF THIS
// SOFTWARE.
```

=====
=====

compat/os/opensolaris_10_netdb.h:

* Copyright (c) 2001 Mike Barcroft <mike@FreeBSD.org>

* Copyright (c) 1990, 1993

* The Regents of the University of California. All rights reserved.

*

* This code is derived from software contributed to Berkeley by

* Chris Torek.

*

* Redistribution and use in source and binary forms, with or without

* modification, are permitted provided that the following conditions

* are met:

* 1. Redistributions of source code must retain the above copyright

* notice, this list of conditions and the following disclaimer.

* 2. Redistributions in binary form must reproduce the above copyright

* notice, this list of conditions and the following disclaimer in the

* documentation and/or other materials provided with the distribution.

* 3. Neither the name of the University nor the names of its contributors

* may be used to endorse or promote products derived from this software

* without specific prior written permission.

*

* THIS SOFTWARE IS PROVIDED BY THE REGENTS AND CONTRIBUTORS ``AS IS" AND

* ANY EXPRESS OR IMPLIED WARRANTIES, INCLUDING, BUT NOT LIMITED TO, THE

* IMPLIED WARRANTIES OF MERCHANTABILITY AND FITNESS FOR A PARTICULAR

PURPOSE

* ARE DISCLAIMED. IN NO EVENT SHALL THE REGENTS OR CONTRIBUTORS BE LIABLE

* FOR ANY DIRECT, INDIRECT, INCIDENTAL, SPECIAL, EXEMPLARY, OR CONSEQUENTIAL

* DAMAGES (INCLUDING, BUT NOT LIMITED TO, PROCUREMENT OF SUBSTITUTE GOODS

* OR SERVICES; LOSS OF USE, DATA, OR PROFITS; OR BUSINESS INTERRUPTION)

* HOWEVER CAUSED AND ON ANY THEORY OF LIABILITY, WHETHER IN CONTRACT,

STRICT

* LIABILITY, OR TORT (INCLUDING NEGLIGENCE OR OTHERWISE) ARISING IN ANY WAY

* OUT OF THE USE OF THIS SOFTWARE, EVEN IF ADVISED OF THE POSSIBILITY OF

* SUCH DAMAGE.

=====
=====

(C) Copyright Ion Gaztanaga 2005-2009.
Distributed under the Boost Software License, Version 1.0

Boost Software License - Version 1.0 - August 17th, 2003

Permission is hereby granted, free of charge, to any person or organization obtaining a copy of the software and accompanying documentation covered by this license (the "Software") to use, reproduce, display, distribute, execute, and transmit the Software, and to prepare derivative works of the Software, and to permit third-parties to whom the Software is furnished to do so, all subject to the following:

The copyright notices in the Software and this entire statement, including the above license grant, this restriction and the following disclaimer, must be included in all copies of the Software, in whole or in part, and all derivative works of the Software, unless such copies or derivative works are solely in the form of machine-executable object code generated by a source language processor.

THE SOFTWARE IS PROVIDED "AS IS", WITHOUT WARRANTY OF ANY KIND, EXPRESS OR IMPLIED, INCLUDING BUT NOT LIMITED TO THE WARRANTIES OF MERCHANTABILITY, FITNESS FOR A PARTICULAR PURPOSE, TITLE AND NON-INFRINGEMENT. IN NO EVENT SHALL THE COPYRIGHT HOLDERS OR ANYONE DISTRIBUTING THE SOFTWARE BE LIABLE FOR ANY DAMAGES OR OTHER LIABILITY, WHETHER IN CONTRACT, TORT OR OTHERWISE, ARISING FROM, OUT OF OR IN CONNECTION WITH THE SOFTWARE OR THE USE OR OTHER DEALINGS IN THE SOFTWARE.

=====
=====

This originates from X11R5 (mit/util/scripts/install.sh), which was
later released in X11R6 (xc/config/util/install.sh) with the
following copyright and license.

Copyright (C) 1994 X Consortium

```
#
# Permission is hereby granted, free of charge, to any person obtaining a copy
# of this software and associated documentation files (the "Software"), to
# deal in the Software without restriction, including without limitation the
# rights to use, copy, modify, merge, publish, distribute, sublicense, and/or
# sell copies of the Software, and to permit persons to whom the Software is
# furnished to do so, subject to the following conditions:
#
# The above copyright notice and this permission notice shall be included in
# all copies or substantial portions of the Software.
#
# THE SOFTWARE IS PROVIDED "AS IS", WITHOUT WARRANTY OF ANY KIND, EXPRESS OR
# IMPLIED, INCLUDING BUT NOT LIMITED TO THE WARRANTIES OF MERCHANTABILITY,
# FITNESS FOR A PARTICULAR PURPOSE AND NONINFRINGEMENT. IN NO EVENT SHALL
# THE
# X CONSORTIUM BE LIABLE FOR ANY CLAIM, DAMAGES OR OTHER LIABILITY, WHETHER
# IN
# AN ACTION OF CONTRACT, TORT OR OTHERWISE, ARISING FROM, OUT OF OR IN
# CONNEC-
# TION WITH THE SOFTWARE OR THE USE OR OTHER DEALINGS IN THE SOFTWARE. +
#
# Except as contained in this notice, the name of the X Consortium shall not
# be used in advertising or otherwise to promote the sale, use or other deal-
# ings in this Software without prior written authorization from the X Consor-
# tium.
#
# FSF changes to this file are in the public domain.
#
# Calling this script install-sh is preferred over install.sh, to prevent
# 'make' implicit rules from creating a file called install from it
# when there is no Makefile.
#
# This script is compatible with the BSD install script, but was written
# from scratch.
```

DO NOT TRANSLATE OR LOCALIZE.

%% This notice is provided with respect to ASM Bytecode Manipulation Framework v5.0, which may be included with JRE 8, and JDK 8, and OpenJDK 8.

--- begin of LICENSE ---

Copyright (c) 2000-2011 France Telecom
All rights reserved.

Redistribution and use in source and binary forms, with or without modification, are permitted provided that the following conditions are met:

1. Redistributions of source code must retain the above copyright notice, this list of conditions and the following disclaimer.
2. Redistributions in binary form must reproduce the above copyright notice, this list of conditions and the following disclaimer in the documentation and/or other materials provided with the distribution.
3. Neither the name of the copyright holders nor the names of its contributors may be used to endorse or promote products derived from this software without specific prior written permission.

THIS SOFTWARE IS PROVIDED BY THE COPYRIGHT HOLDERS AND CONTRIBUTORS "AS IS" AND ANY EXPRESS OR IMPLIED WARRANTIES, INCLUDING, BUT NOT LIMITED TO, THE IMPLIED WARRANTIES OF MERCHANTABILITY AND FITNESS FOR A PARTICULAR PURPOSE ARE DISCLAIMED. IN NO EVENT SHALL THE COPYRIGHT OWNER OR CONTRIBUTORS BE LIABLE FOR ANY DIRECT, INDIRECT, INCIDENTAL, SPECIAL, EXEMPLARY, OR

CONSEQUENTIAL DAMAGES (INCLUDING, BUT NOT LIMITED TO,
PROCUREMENT OF
SUBSTITUTE GOODS OR SERVICES; LOSS OF USE, DATA, OR PROFITS; OR
BUSINESS
INTERRUPTION) HOWEVER CAUSED AND ON ANY THEORY OF LIABILITY,
WHETHER IN
CONTRACT, STRICT LIABILITY, OR TORT (INCLUDING NEGLIGENCE OR
OTHERWISE)
ARISING IN ANY WAY OUT OF THE USE OF THIS SOFTWARE, EVEN IF ADVISED
OF
THE POSSIBILITY OF SUCH DAMAGE.

--- end of LICENSE ---

%% This notice is provided with respect to BSDiff v4.3, which may be
included with JRE 8, JDK 8, and OpenJDK 8.

--- begin of LICENSE ---

Copyright 2003-2005 Colin Percival
All rights reserved

Redistribution and use in source and binary forms, with or without
modification, are permitted providing that the following conditions
are met:

1. Redistributions of source code must retain the above copyright
notice, this list of conditions and the following disclaimer.
2. Redistributions in binary form must reproduce the above copyright
notice, this list of conditions and the following disclaimer in the
documentation and/or other materials provided with the distribution.

THIS SOFTWARE IS PROVIDED BY THE AUTHOR ``AS IS" AND ANY EXPRESS OR
IMPLIED WARRANTIES, INCLUDING, BUT NOT LIMITED TO, THE IMPLIED
WARRANTIES OF MERCHANTABILITY AND FITNESS FOR A PARTICULAR

PURPOSE

ARE DISCLAIMED. IN NO EVENT SHALL THE AUTHOR BE LIABLE FOR ANY DIRECT, INDIRECT, INCIDENTAL, SPECIAL, EXEMPLARY, OR CONSEQUENTIAL DAMAGES (INCLUDING, BUT NOT LIMITED TO, PROCUREMENT OF SUBSTITUTE GOODS

OR SERVICES; LOSS OF USE, DATA, OR PROFITS; OR BUSINESS INTERRUPTION)

HOWEVER CAUSED AND ON ANY THEORY OF LIABILITY, WHETHER IN CONTRACT,

STRICT LIABILITY, OR TORT (INCLUDING NEGLIGENCE OR OTHERWISE) ARISING

IN ANY WAY OUT OF THE USE OF THIS SOFTWARE, EVEN IF ADVISED OF THE POSSIBILITY OF SUCH DAMAGE.

--- end of LICENSE ---

%% This notice is provided with respect to CodeViewer 1.0, which may be included with JDK 8.

--- begin of LICENSE ---

Copyright 1999 by CoolServlets.com.

Any errors or suggested improvements to this class can be reported as instructed on CoolServlets.com. We hope you enjoy this program... your comments will encourage further development! This software is distributed under the terms of the BSD License. Redistribution and use in source and binary forms, with or without modification, are permitted provided that the following conditions are met:

1. Redistributions of source code must retain the above copyright notice, this list of conditions and the following disclaimer.
2. Redistributions in binary form must reproduce the above copyright notice,

this list of conditions and the following disclaimer in the documentation and/or other materials provided with the distribution.

Neither name of CoolServlets.com nor the names of its contributors may be used to endorse or promote products derived from this software without specific prior written permission.

THIS SOFTWARE IS PROVIDED BY COOLSERVLETS.COM AND CONTRIBUTORS
"AS IS" AND
ANY EXPRESS OR IMPLIED WARRANTIES, INCLUDING, BUT NOT LIMITED TO,
THE IMPLIED
WARRANTIES OF MERCHANTABILITY AND FITNESS FOR A PARTICULAR
PURPOSE ARE
DISCLAIMED. IN NO EVENT SHALL THE AUTHOR OR CONTRIBUTORS BE
LIABLE FOR ANY
DIRECT, INDIRECT, INCIDENTAL, SPECIAL, EXEMPLARY, OR CONSEQUENTIAL
DAMAGES
(INCLUDING, BUT NOT LIMITED TO, PROCUREMENT OF SUBSTITUTE GOODS
OR SERVICES;
LOSS OF USE, DATA, OR PROFITS; OR BUSINESS INTERRUPTION) HOWEVER
CAUSED AND ON
ANY THEORY OF LIABILITY, WHETHER IN CONTRACT, STRICT LIABILITY, OR
TORT
(INCLUDING NEGLIGENCE OR OTHERWISE) ARISING IN ANY WAY OUT OF THE
USE OF THIS
SOFTWARE, EVEN IF ADVISED OF THE POSSIBILITY OF SUCH DAMAGE."

--- end of LICENSE ---

%% This notice is provided with respect to Cryptix AES 3.2.0, which may be included with JRE 8, JDK 8, and OpenJDK 8.

--- begin of LICENSE ---

Cryptix General License

Copyright (c) 1995-2005 The Cryptix Foundation Limited.

All rights reserved.

Redistribution and use in source and binary forms, with or without modification, are permitted provided that the following conditions are met:

1. Redistributions of source code must retain the copyright notice, this list of conditions and the following disclaimer.
2. Redistributions in binary form must reproduce the above copyright notice, this list of conditions and the following disclaimer in the documentation and/or other materials provided with the distribution.

THIS SOFTWARE IS PROVIDED BY THE CRYPTIX FOUNDATION LIMITED AND CONTRIBUTORS ``AS IS" AND ANY EXPRESS OR IMPLIED WARRANTIES, INCLUDING, BUT NOT LIMITED TO, THE IMPLIED WARRANTIES OF MERCHANTABILITY AND FITNESS FOR A PARTICULAR PURPOSE ARE DISCLAIMED.

IN NO EVENT SHALL THE CRYPTIX FOUNDATION LIMITED OR CONTRIBUTORS BE

LIABLE FOR ANY DIRECT, INDIRECT, INCIDENTAL, SPECIAL, EXEMPLARY, OR CONSEQUENTIAL DAMAGES (INCLUDING, BUT NOT LIMITED TO, PROCUREMENT OF

SUBSTITUTE GOODS OR SERVICES; LOSS OF USE, DATA, OR PROFITS; OR BUSINESS INTERRUPTION) HOWEVER CAUSED AND ON ANY THEORY OF LIABILITY,

WHETHER IN CONTRACT, STRICT LIABILITY, OR TORT (INCLUDING NEGLIGENCE

OR OTHERWISE) ARISING IN ANY WAY OUT OF THE USE OF THIS SOFTWARE, EVEN

IF ADVISED OF THE POSSIBILITY OF SUCH DAMAGE.

--- end of LICENSE ---

%% This notice is provided with respect to CUP Parser Generator for
Java 0.10k, which may be included with JRE 8, JDK 8, and OpenJDK 8.

--- begin of LICENSE ---

Copyright 1996-1999 by Scott Hudson, Frank Flannery, C. Scott Ananian

Permission to use, copy, modify, and distribute this software and its
documentation for any purpose and without fee is hereby granted, provided
that the above copyright notice appear in all copies and that both the
copyright notice and this permission notice and warranty disclaimer appear in
supporting documentation, and that the names of the authors or their
employers not be used in advertising or publicity pertaining to distribution of
the software without specific, written prior permission.

The authors and their employers disclaim all warranties with regard to
this software, including all implied warranties of merchantability and fitness.
In no event shall the authors or their employers be liable for any special,
indirect or consequential damages or any damages whatsoever resulting from
loss of use, data or profits, whether in an action of contract, negligence or
other tortious action, arising out of or in connection with the use or
performance of this software.

--- end of LICENSE ---

%% This notice is provided with respect to Document Object Model (DOM) Level 2
& 3, which may be included with JRE 8, JDK 8, and OpenJDK 8.

--- begin of LICENSE ---

W3C SOFTWARE NOTICE AND LICENSE

<http://www.w3.org/Consortium/Legal/2002/copyright-software-20021231>

This work (and included software, documentation such as READMEs, or other related items) is being provided by the copyright holders under the following license. By obtaining, using and/or copying this work, you (the licensee) agree that you have read, understood, and will comply with the following terms and conditions.

Permission to copy, modify, and distribute this software and its documentation, with or without modification, for any purpose and without fee or royalty is hereby granted, provided that you include the following on ALL copies of the software and documentation or portions thereof, including modifications:

1. The full text of this NOTICE in a location viewable to users of the redistributed or derivative work.
2. Any pre-existing intellectual property disclaimers, notices, or terms and conditions. If none exist, the W3C Software Short Notice should be included (hypertext is preferred, text is permitted) within the body of any redistributed or derivative code.
3. Notice of any changes or modifications to the files, including the date changes were made. (We recommend you provide URIs to the location from which the code is derived.)

THIS SOFTWARE AND DOCUMENTATION IS PROVIDED "AS IS," AND COPYRIGHT HOLDERS MAKE NO REPRESENTATIONS OR WARRANTIES, EXPRESS OR IMPLIED, INCLUDING BUT NOT LIMITED TO, WARRANTIES OF MERCHANTABILITY OR FITNESS FOR ANY PARTICULAR PURPOSE OR THAT THE USE OF THE SOFTWARE OR DOCUMENTATION WILL

NOT INFRINGE ANY
THIRD PARTY PATENTS,COPYRIGHTS, TRADEMARKS OR OTHER RIGHTS.

COPYRIGHT HOLDERS WILL NOT BE LIABLE FOR ANY DIRECT, INDIRECT,
SPECIAL
OR CONSEQUENTIAL DAMAGES ARISING OUT OF ANY USE OF THE
SOFTWARE OR

DOCUMENTATION. The name and trademarks of copyright holders may NOT be
used

in advertising or publicity pertaining to the software without specific,
written prior permission. Title to copyright in this software and any
associated documentation will at all times remain with copyright holders.

This formulation of W3C's notice and license became active on December 31
2002. This version removes the copyright ownership notice such that this
license can be used with materials other than those owned by the W3C, reflects
that ERCIM is now a host of the W3C, includes references to this specific
dated version of the license, and removes the ambiguous grant of "use".
Otherwise, this version is the same as the previous version and is written so
as to preserve the Free Software Foundation's assessment of GPL compatibility
and OSI's certification under the Open Source Definition. Please see our
Copyright FAQ for common questions about using materials from our site,
including specific terms and conditions for packages like libwww, Amaya, and
Jigsaw. Other questions about this notice can be directed to
site-policy@w3.org.

--- end of LICENSE ---

%% This notice is provided with respect to Dynalink v0.5, which may be
included with JRE 8, JDK 8, and OpenJDK 8.

--- begin of LICENSE ---

Copyright (c) 2009-2013, Attila Szegedi

All rights reserved. Redistribution and use in source and binary forms, with or without modification, are permitted provided that the following conditions are met: * Redistributions of source code must retain the above copyright notice, this list of conditions and the following disclaimer. * Redistributions in binary form must reproduce the above copyright notice, this list of conditions and the following disclaimer in the documentation and/or other materials provided with the distribution. * Neither the name of Attila Szegedi nor the names of its contributors may be used to endorse or promote products derived from this software without specific prior written permission.

THIS SOFTWARE IS PROVIDED BY THE COPYRIGHT HOLDERS AND CONTRIBUTORS "AS IS" AND ANY EXPRESS OR IMPLIED WARRANTIES, INCLUDING, BUT NOT LIMITED TO, THE IMPLIED WARRANTIES OF MERCHANTABILITY AND FITNESS FOR A PARTICULAR PURPOSE ARE DISCLAIMED. IN NO EVENT SHALL THE COPYRIGHT HOLDER OR CONTRIBUTORS BE LIABLE FOR ANY DIRECT, INDIRECT, INCIDENTAL, SPECIAL, EXEMPLARY, OR CONSEQUENTIAL DAMAGES (INCLUDING, BUT NOT LIMITED TO, PROCUREMENT OF SUBSTITUTE GOODS OR SERVICES; LOSS OF USE, DATA, OR PROFITS; OR BUSINESS INTERRUPTION) HOWEVER CAUSED AND ON ANY THEORY OF LIABILITY, WHETHER IN CONTRACT, STRICT LIABILITY, OR TORT (INCLUDING NEGLIGENCE OR OTHERWISE) ARISING IN ANY WAY OUT OF THE USE OF THIS SOFTWARE, EVEN IF ADVISED OF THE POSSIBILITY OF SUCH DAMAGE.

--- end of LICENSE ---

%% This notice is provided with respect to Elliptic Curve Cryptography, which
may be included with JRE 8, JDK 8, and OpenJDK 8.

You are receiving a copy of the Elliptic Curve Cryptography library in source
form with the JDK 8 and OpenJDK 8 source distributions, and as object code in
the JRE 8 & JDK 8 runtimes.

In the case of the JRE 8 & JDK 8 runtimes, the terms of the Oracle license do
NOT apply to the Elliptic Curve Cryptography library; it is licensed under the
following license, separately from Oracle's JDK & JRE. If you do not wish to
install the Elliptic Curve Cryptography library, you may delete the library
named libsunec.so (on Solaris and Linux systems) or sunec.dll (on Windows
systems) from the JRE bin directory reserved for native libraries.

--- begin of LICENSE ---

GNU LESSER GENERAL PUBLIC LICENSE
Version 2.1, February 1999

Copyright (C) 1991, 1999 Free Software Foundation, Inc.
51 Franklin Street, Fifth Floor, Boston, MA 02110-1301 USA
Everyone is permitted to copy and distribute verbatim copies
of this license document, but changing it is not allowed.

[This is the first released version of the Lesser GPL. It also counts
as the successor of the GNU Library Public License, version 2, hence
the version number 2.1.]

Preamble

The licenses for most software are designed to take away your
freedom to share and change it. By contrast, the GNU General Public
Licenses are intended to guarantee your freedom to share and change

free software--to make sure the software is free for all its users.

This license, the Lesser General Public License, applies to some specially designated software packages--typically libraries--of the Free Software Foundation and other authors who decide to use it. You can use it too, but we suggest you first think carefully about whether this license or the ordinary General Public License is the better strategy to use in any particular case, based on the explanations below.

When we speak of free software, we are referring to freedom of use, not price. Our General Public Licenses are designed to make sure that you have the freedom to distribute copies of free software (and charge for this service if you wish); that you receive source code or can get it if you want it; that you can change the software and use pieces of it in new free programs; and that you are informed that you can do these things.

To protect your rights, we need to make restrictions that forbid distributors to deny you these rights or to ask you to surrender these rights. These restrictions translate to certain responsibilities for you if you distribute copies of the library or if you modify it.

For example, if you distribute copies of the library, whether gratis or for a fee, you must give the recipients all the rights that we gave you. You must make sure that they, too, receive or can get the source code. If you link other code with the library, you must provide complete object files to the recipients, so that they can relink them with the library after making changes to the library and recompiling it. And you must show them these terms so they know their rights.

We protect your rights with a two-step method: (1) we copyright the library, and (2) we offer you this license, which gives you legal permission to copy, distribute and/or modify the library.

To protect each distributor, we want to make it very clear that there is no warranty for the free library. Also, if the library is

modified by someone else and passed on, the recipients should know that what they have is not the original version, so that the original author's reputation will not be affected by problems that might be introduced by others.

Finally, software patents pose a constant threat to the existence of any free program. We wish to make sure that a company cannot effectively restrict the users of a free program by obtaining a restrictive license from a patent holder. Therefore, we insist that any patent license obtained for a version of the library must be consistent with the full freedom of use specified in this license.

Most GNU software, including some libraries, is covered by the ordinary GNU General Public License. This license, the GNU Lesser General Public License, applies to certain designated libraries, and is quite different from the ordinary General Public License. We use this license for certain libraries in order to permit linking those libraries into non-free programs.

When a program is linked with a library, whether statically or using a shared library, the combination of the two is legally speaking a combined work, a derivative of the original library. The ordinary General Public License therefore permits such linking only if the entire combination fits its criteria of freedom. The Lesser General Public License permits more lax criteria for linking other code with the library.

We call this license the "Lesser" General Public License because it does Less to protect the user's freedom than the ordinary General Public License. It also provides other free software developers Less of an advantage over competing non-free programs. These disadvantages are the reason we use the ordinary General Public License for many libraries. However, the Lesser license provides advantages in certain special circumstances.

For example, on rare occasions, there may be a special need to encourage the widest possible use of a certain library, so that it becomes a de-facto standard. To achieve this, non-free programs must be allowed to use the library. A more frequent case is that a free library does the same job as widely used non-free libraries. In this case, there is little to gain by limiting the free library to free

software only, so we use the Lesser General Public License.

In other cases, permission to use a particular library in non-free programs enables a greater number of people to use a large body of free software. For example, permission to use the GNU C Library in non-free programs enables many more people to use the whole GNU operating system, as well as its variant, the GNU/Linux operating system.

Although the Lesser General Public License is Less protective of the users' freedom, it does ensure that the user of a program that is linked with the Library has the freedom and the wherewithal to run that program using a modified version of the Library.

The precise terms and conditions for copying, distribution and modification follow. Pay close attention to the difference between a "work based on the library" and a "work that uses the library". The former contains code derived from the library, whereas the latter must be combined with the library in order to run.

GNU LESSER GENERAL PUBLIC LICENSE
TERMS AND CONDITIONS FOR COPYING, DISTRIBUTION AND
MODIFICATION

0. This License Agreement applies to any software library or other program which contains a notice placed by the copyright holder or other authorized party saying it may be distributed under the terms of this Lesser General Public License (also called "this License").

Each licensee is addressed as "you".

A "library" means a collection of software functions and/or data prepared so as to be conveniently linked with application programs (which use some of those functions and data) to form executables.

The "Library", below, refers to any such software library or work which has been distributed under these terms. A "work based on the Library" means either the Library or any derivative work under copyright law: that is to say, a work containing the Library or a portion of it, either verbatim or with modifications and/or translated straightforwardly into another language. (Hereinafter, translation is included without limitation in the term "modification".)

"Source code" for a work means the preferred form of the work for making modifications to it. For a library, complete source code means all the source code for all modules it contains, plus any associated interface definition files, plus the scripts used to control compilation and installation of the library.

Activities other than copying, distribution and modification are not covered by this License; they are outside its scope. The act of running a program using the Library is not restricted, and output from such a program is covered only if its contents constitute a work based on the Library (independent of the use of the Library in a tool for writing it). Whether that is true depends on what the Library does and what the program that uses the Library does.

1. You may copy and distribute verbatim copies of the Library's complete source code as you receive it, in any medium, provided that you conspicuously and appropriately publish on each copy an appropriate copyright notice and disclaimer of warranty; keep intact all the notices that refer to this License and to the absence of any warranty; and distribute a copy of this License along with the Library.

You may charge a fee for the physical act of transferring a copy, and you may at your option offer warranty protection in exchange for a fee.

2. You may modify your copy or copies of the Library or any portion of it, thus forming a work based on the Library, and copy and distribute such modifications or work under the terms of Section 1 above, provided that you also meet all of these conditions:

- a) The modified work must itself be a software library.
- b) You must cause the files modified to carry prominent notices stating that you changed the files and the date of any change.
- c) You must cause the whole of the work to be licensed at no charge to all third parties under the terms of this License.
- d) If a facility in the modified Library refers to a function or a table of data to be supplied by an application program that uses the facility, other than as an argument passed when the facility is invoked, then you must make a good faith effort to ensure that, in the event an application does not supply such function or table, the facility still operates, and performs whatever part of its purpose remains meaningful.

(For example, a function in a library to compute square roots has a purpose that is entirely well-defined independent of the application. Therefore, Subsection 2d requires that any application-supplied function or table used by this function must be optional: if the application does not supply it, the square root function must still compute square roots.)

These requirements apply to the modified work as a whole. If identifiable sections of that work are not derived from the Library, and can be reasonably considered independent and separate works in themselves, then this License, and its terms, do not apply to those sections when you distribute them as separate works. But when you distribute the same sections as part of a whole which is a work based on the Library, the distribution of the whole must be on the terms of this License, whose permissions for other licensees extend to the

entire whole, and thus to each and every part regardless of who wrote it.

Thus, it is not the intent of this section to claim rights or contest your rights to work written entirely by you; rather, the intent is to exercise the right to control the distribution of derivative or collective works based on the Library.

In addition, mere aggregation of another work not based on the Library with the Library (or with a work based on the Library) on a volume of a storage or distribution medium does not bring the other work under the scope of this License.

3. You may opt to apply the terms of the ordinary GNU General Public License instead of this License to a given copy of the Library. To do this, you must alter all the notices that refer to this License, so that they refer to the ordinary GNU General Public License, version 2, instead of to this License. (If a newer version than version 2 of the ordinary GNU General Public License has appeared, then you can specify that version instead if you wish.) Do not make any other change in these notices.

Once this change is made in a given copy, it is irreversible for that copy, so the ordinary GNU General Public License applies to all subsequent copies and derivative works made from that copy.

This option is useful when you wish to copy part of the code of the Library into a program that is not a library.

4. You may copy and distribute the Library (or a portion or derivative of it, under Section 2) in object code or executable form under the terms of Sections 1 and 2 above provided that you accompany it with the complete corresponding machine-readable source code, which must be distributed under the terms of Sections 1 and 2 above on a medium customarily used for software interchange.

If distribution of object code is made by offering access to copy from a designated place, then offering equivalent access to copy the source code from the same place satisfies the requirement to distribute the source code, even though third parties are not compelled to copy the source along with the object code.

5. A program that contains no derivative of any portion of the Library, but is designed to work with the Library by being compiled or linked with it, is called a "work that uses the Library". Such a work, in isolation, is not a derivative work of the Library, and therefore falls outside the scope of this License.

However, linking a "work that uses the Library" with the Library creates an executable that is a derivative of the Library (because it contains portions of the Library), rather than a "work that uses the library". The executable is therefore covered by this License. Section 6 states terms for distribution of such executables.

When a "work that uses the Library" uses material from a header file that is part of the Library, the object code for the work may be a derivative work of the Library even though the source code is not. Whether this is true is especially significant if the work can be

linked without the Library, or if the work is itself a library. The threshold for this to be true is not precisely defined by law.

If such an object file uses only numerical parameters, data structure layouts and accessors, and small macros and small inline functions (ten lines or less in length), then the use of the object file is unrestricted, regardless of whether it is legally a derivative work. (Executables containing this object code plus portions of the Library will still fall under Section 6.)

Otherwise, if the work is a derivative of the Library, you may distribute the object code for the work under the terms of Section 6. Any executables containing that work also fall under Section 6, whether or not they are linked directly with the Library itself.

6. As an exception to the Sections above, you may also combine or link a "work that uses the Library" with the Library to produce a work containing portions of the Library, and distribute that work under terms of your choice, provided that the terms permit modification of the work for the customer's own use and reverse engineering for debugging such modifications.

You must give prominent notice with each copy of the work that the Library is used in it and that the Library and its use are covered by this License. You must supply a copy of this License. If the work during execution displays copyright notices, you must include the copyright notice for the Library among them, as well as a reference directing the user to the copy of this License. Also, you must do one of these things:

a) Accompany the work with the complete corresponding machine-readable source code for the Library including whatever changes were used in the work (which must be distributed under Sections 1 and 2 above); and, if the work is an executable linked with the Library, with the complete machine-readable "work that uses the Library", as object code and/or source code, so that the user can modify the Library and then relink to produce a modified executable containing the modified Library. (It is understood that the user who changes the contents of definitions files in the Library will not necessarily be able to recompile the application to use the modified definitions.)

b) Use a suitable shared library mechanism for linking with the Library. A suitable mechanism is one that (1) uses at run time a copy of the library already present on the user's computer system, rather than copying library functions into the executable, and (2) will operate properly with a modified version of the library, if the user installs one, as long as the modified version is interface-compatible with the version that the work was made with.

c) Accompany the work with a written offer, valid for at

least three years, to give the same user the materials specified in Subsection 6a, above, for a charge no more than the cost of performing this distribution.

d) If distribution of the work is made by offering access to copy from a designated place, offer equivalent access to copy the above specified materials from the same place.

e) Verify that the user has already received a copy of these materials or that you have already sent this user a copy.

For an executable, the required form of the "work that uses the Library" must include any data and utility programs needed for reproducing the executable from it. However, as a special exception, the materials to be distributed need not include anything that is normally distributed (in either source or binary form) with the major components (compiler, kernel, and so on) of the operating system on which the executable runs, unless that component itself accompanies the executable.

It may happen that this requirement contradicts the license restrictions of other proprietary libraries that do not normally accompany the operating system. Such a contradiction means you cannot use both them and the Library together in an executable that you distribute.

7. You may place library facilities that are a work based on the Library side-by-side in a single library together with other library facilities not covered by this License, and distribute such a combined library, provided that the separate distribution of the work based on the Library and of the other library facilities is otherwise permitted, and provided that you do these two things:

a) Accompany the combined library with a copy of the same work based on the Library, uncombined with any other library facilities. This must be distributed under the terms of the Sections above.

b) Give prominent notice with the combined library of the fact that part of it is a work based on the Library, and explaining where to find the accompanying uncombined form of the same work.

8. You may not copy, modify, sublicense, link with, or distribute the Library except as expressly provided under this License. Any attempt otherwise to copy, modify, sublicense, link with, or distribute the Library is void, and will automatically terminate your rights under this License. However, parties who have received copies, or rights, from you under this License will not have their licenses terminated so long as such parties remain in full compliance.

9. You are not required to accept this License, since you have not signed it. However, nothing else grants you permission to modify or distribute the Library or its derivative works. These actions are prohibited by law if you do not accept this License. Therefore, by modifying or distributing the Library (or any work based on the Library), you indicate your acceptance of this License to do so, and all its terms and conditions for copying, distributing or modifying the Library or works based on it.

10. Each time you redistribute the Library (or any work based on the Library), the recipient automatically receives a license from the original licensor to copy, distribute, link with or modify the Library

subject to these terms and conditions. You may not impose any further restrictions on the recipients' exercise of the rights granted herein.

You are not responsible for enforcing compliance by third parties with this License.

11. If, as a consequence of a court judgment or allegation of patent infringement or for any other reason (not limited to patent issues), conditions are imposed on you (whether by court order, agreement or otherwise) that contradict the conditions of this License, they do not excuse you from the conditions of this License. If you cannot distribute so as to satisfy simultaneously your obligations under this License and any other pertinent obligations, then as a consequence you may not distribute the Library at all. For example, if a patent license would not permit royalty-free redistribution of the Library by all those who receive copies directly or indirectly through you, then the only way you could satisfy both it and this License would be to refrain entirely from distribution of the Library.

If any portion of this section is held invalid or unenforceable under any particular circumstance, the balance of the section is intended to apply, and the section as a whole is intended to apply in other circumstances.

It is not the purpose of this section to induce you to infringe any patents or other property right claims or to contest validity of any such claims; this section has the sole purpose of protecting the integrity of the free software distribution system which is implemented by public license practices. Many people have made generous contributions to the wide range of software distributed through that system in reliance on consistent application of that system; it is up to the author/donor to decide if he or she is willing to distribute software through any other system and a licensee cannot impose that choice.

This section is intended to make thoroughly clear what is believed to be a consequence of the rest of this License.

12. If the distribution and/or use of the Library is restricted in certain countries either by patents or by copyrighted interfaces, the original copyright holder who places the Library under this License may add an explicit geographical distribution limitation excluding those countries, so that distribution is permitted only in or among countries not thus

excluded. In such case, this License incorporates the limitation as if written in the body of this License.

13. The Free Software Foundation may publish revised and/or new versions of the Lesser General Public License from time to time. Such new versions will be similar in spirit to the present version, but may differ in detail to address new problems or concerns.

Each version is given a distinguishing version number. If the Library specifies a version number of this License which applies to it and "any later version", you have the option of following the terms and conditions either of that version or of any later version published by the Free Software Foundation. If the Library does not specify a license version number, you may choose any version ever published by the Free Software Foundation.

14. If you wish to incorporate parts of the Library into other free programs whose distribution conditions are incompatible with these, write to the author to ask for permission. For software which is copyrighted by the Free Software Foundation, write to the Free Software Foundation; we sometimes make exceptions for this. Our decision will be guided by the two goals of preserving the free status of all derivatives of our free software and of promoting the sharing and reuse of software generally.

NO WARRANTY

15. BECAUSE THE LIBRARY IS LICENSED FREE OF CHARGE, THERE IS NO WARRANTY FOR THE LIBRARY, TO THE EXTENT PERMITTED BY APPLICABLE LAW.

EXCEPT WHEN OTHERWISE STATED IN WRITING THE COPYRIGHT HOLDERS AND/OR

OTHER PARTIES PROVIDE THE LIBRARY "AS IS" WITHOUT WARRANTY OF ANY KIND, EITHER EXPRESSED OR IMPLIED, INCLUDING, BUT NOT LIMITED TO, THE

IMPLIED WARRANTIES OF MERCHANTABILITY AND FITNESS FOR A PARTICULAR

PURPOSE. THE ENTIRE RISK AS TO THE QUALITY AND PERFORMANCE OF THE

LIBRARY IS WITH YOU. SHOULD THE LIBRARY PROVE DEFECTIVE, YOU ASSUME

THE COST OF ALL NECESSARY SERVICING, REPAIR OR CORRECTION.

16. IN NO EVENT UNLESS REQUIRED BY APPLICABLE LAW OR AGREED TO IN

WRITING WILL ANY COPYRIGHT HOLDER, OR ANY OTHER PARTY WHO MAY MODIFY

AND/OR REDISTRIBUTE THE LIBRARY AS PERMITTED ABOVE, BE LIABLE TO YOU

FOR DAMAGES, INCLUDING ANY GENERAL, SPECIAL, INCIDENTAL OR

CONSEQUENTIAL DAMAGES ARISING OUT OF THE USE OR INABILITY TO USE THE

LIBRARY (INCLUDING BUT NOT LIMITED TO LOSS OF DATA OR DATA BEING
RENDERED INACCURATE OR LOSSES SUSTAINED BY YOU OR THIRD PARTIES
OR A
FAILURE OF THE LIBRARY TO OPERATE WITH ANY OTHER SOFTWARE), EVEN
IF
SUCH HOLDER OR OTHER PARTY HAS BEEN ADVISED OF THE POSSIBILITY
OF SUCH
DAMAGES.

END OF TERMS AND CONDITIONS

How to Apply These Terms to Your New Libraries

If you develop a new library, and you want it to be of the greatest possible use to the public, we recommend making it free software that everyone can redistribute and change. You can do so by permitting redistribution under these terms (or, alternatively, under the terms of the ordinary General Public License).

To apply these terms, attach the following notices to the library. It is safest to attach them to the start of each source file to most effectively convey the exclusion of warranty; and each file should have at least the "copyright" line and a pointer to where the full notice is found.

```
<one line to give the library's name and a brief idea of what it does.>  
Copyright (C) <year> <name of author>
```

```
This library is free software; you can redistribute it and/or  
modify it under the terms of the GNU Lesser General Public  
License as published by the Free Software Foundation; either  
version 2.1 of the License, or (at your option) any later version.
```

```
This library is distributed in the hope that it will be useful,  
but WITHOUT ANY WARRANTY; without even the implied warranty of  
MERCHANTABILITY or FITNESS FOR A PARTICULAR PURPOSE. See the  
GNU  
Lesser General Public License for more details.
```

```
You should have received a copy of the GNU Lesser General Public  
License along with this library; if not, write to the Free Software  
Foundation, Inc., 51 Franklin Street, Fifth Floor, Boston, MA 02110-1301 USA
```

Also add information on how to contact you by electronic and paper mail.

You should also get your employer (if you work as a programmer) or your school, if any, to sign a "copyright disclaimer" for the library, if necessary. Here is a sample; alter the names:

Yoyodyne, Inc., hereby disclaims all copyright interest in the library `Frob' (a library for tweaking knobs) written by James Random Hacker.

<signature of Ty Coon>, 1 April 1990

Ty Coon, President of Vice

That's all there is to it!

--- end of LICENSE ---

%% This notice is provided with respect to ECMAScript Language Specification ECMA-262 Edition 5.1 which may be included with JRE 8, JDK 8, and OpenJDK 8.

--- begin of LICENSE ---

Copyright notice

Copyright c 2011 Ecma International

Ecma International

Rue du Rhone 114

CH-1204 Geneva

Tel: +41 22 849 6000

Fax: +41 22 849 6001

Web: <http://www.ecma-international.org>

This document and possible translations of it may be copied and furnished to others, and derivative works that comment on or otherwise explain it or assist in its implementation may be prepared, copied, published, and distributed, in whole or in part, without restriction of any kind, provided that the above copyright notice and this section are included on all such copies and derivative works. However, this document itself may not be modified in any way, including by removing the copyright notice or references to Ecma International, except as needed for the purpose of developing any document or deliverable produced by

Ecma International (in which case the rules applied to copyrights must be followed) or as required to translate it into languages other than English. The limited permissions granted above are perpetual and will not be revoked by Ecma International or its successors or assigns. This document and the information contained herein is provided on an "AS IS" basis and ECMA INTERNATIONAL DISCLAIMS ALL WARRANTIES, EXPRESS OR IMPLIED, INCLUDING BUT NOT LIMITED TO ANY WARRANTY THAT THE USE OF THE INFORMATION HEREIN WILL NOT INFRINGE ANY OWNERSHIP RIGHTS OR ANY IMPLIED WARRANTIES OF MERCHANTABILITY OR FITNESS FOR A PARTICULAR PURPOSE." Software License

All Software contained in this document ("Software") is protected by copyright and is being made available under the "BSD License", included below. This Software may be subject to third party rights (rights from parties other than Ecma International), including patent rights, and no licenses under such third party rights are granted under this license even if the third party concerned is a member of Ecma International. SEE THE ECMA CODE OF CONDUCT IN PATENT MATTERS

AVAILABLE AT <http://www.ecma-international.org/memento/codeofconduct.htm> FOR INFORMATION REGARDING THE LICENSING OF PATENT CLAIMS THAT ARE REQUIRED TO

IMPLEMENT ECMA INTERNATIONAL STANDARDS*. Redistribution and use in source and

binary forms, with or without modification, are permitted provided that the following conditions are met:

1. Redistributions of source code must retain the above copyright notice, this list of conditions and the following disclaimer.
2. Redistributions in binary form must reproduce the above copyright notice, this list of conditions and the following disclaimer in the documentation and/or other materials provided with the distribution.
3. Neither the name of the authors nor Ecma International may be used to endorse

or promote products derived from this software without specific prior written permission.

THIS SOFTWARE IS PROVIDED BY THE ECMA INTERNATIONAL "AS IS" AND ANY EXPRESS OR IMPLIED WARRANTIES, INCLUDING, BUT NOT LIMITED TO, THE IMPLIED WARRANTIES OF MERCHANTABILITY AND FITNESS FOR A PARTICULAR PURPOSE ARE DISCLAIMED. IN NO EVENT SHALL ECMA INTERNATIONAL BE LIABLE FOR ANY DIRECT, INDIRECT, INCIDENTAL, SPECIAL, EXEMPLARY, OR CONSEQUENTIAL DAMAGES (INCLUDING, BUT NOT LIMITED TO, PROCUREMENT OF SUBSTITUTE GOODS OR SERVICES; LOSS OF USE, DATA, OR PROFITS; OR BUSINESS INTERRUPTION) HOWEVER CAUSED AND ON ANY THEORY OF LIABILITY, WHETHER IN CONTRACT, STRICT LIABILITY, OR TORT (INCLUDING NEGLIGENCE OR OTHERWISE) ARISING IN ANY WAY OUT OF THE USE OF THIS SOFTWARE, EVEN IF ADVISED OF THE POSSIBILITY OF SUCH DAMAGE.

--- end of LICENSE ---

%% This notice is provided with respect to Dynalink library which is included with the Nashorn technology.

--- begin of LICENSE ---

Copyright (c) 2009-2013, Attila Szegedi

Redistribution and use in source and binary forms, with or without modification, are permitted provided that the following conditions are met:

- * Redistributions of source code must retain the above copyright notice, this list of conditions and the following disclaimer.
- * Redistributions in binary form must reproduce the above copyright

notice, this list of conditions and the following disclaimer in the documentation and/or other materials provided with the distribution.

* Neither the name of the copyright holder nor the names of contributors may be used to endorse or promote products derived from this software without specific prior written permission.

THIS SOFTWARE IS PROVIDED BY THE COPYRIGHT HOLDERS AND CONTRIBUTORS "AS IS" AND ANY EXPRESS OR IMPLIED WARRANTIES, INCLUDING, BUT NOT LIMITED TO, THE IMPLIED WARRANTIES OF MERCHANTABILITY AND FITNESS FOR A PARTICULAR PURPOSE ARE DISCLAIMED. IN NO EVENT SHALL COPYRIGHT HOLDER BE LIABLE FOR ANY DIRECT, INDIRECT, INCIDENTAL, SPECIAL, EXEMPLARY, OR CONSEQUENTIAL DAMAGES (INCLUDING, BUT NOT LIMITED TO, PROCUREMENT OF SUBSTITUTE GOODS OR SERVICES; LOSS OF USE, DATA, OR PROFITS; OR BUSINESS INTERRUPTION) HOWEVER CAUSED AND ON ANY THEORY OF LIABILITY, WHETHER IN CONTRACT, STRICT LIABILITY, OR TORT (INCLUDING NEGLIGENCE OR OTHERWISE) ARISING IN ANY WAY OUT OF THE USE OF THIS SOFTWARE, EVEN IF ADVISED OF THE POSSIBILITY OF SUCH DAMAGE.

--- end of LICENSE ---

%% This notice is provided with respect to Joni library which is included with the Nashorn technology.

--- begin of LICENSE ---

Permission is hereby granted, free of charge, to any person obtaining a copy of this software and associated documentation files (the "Software"), to deal in the Software without restriction, including without limitation the rights to use, copy, modify, merge, publish, distribute, sublicense, and/or sell copies of the Software, and to permit persons to whom the Software is furnished to do

so, subject to the following conditions:

The above copyright notice and this permission notice shall be included in all copies or substantial portions of the Software.

THE SOFTWARE IS PROVIDED "AS IS", WITHOUT WARRANTY OF ANY KIND, EXPRESS OR IMPLIED, INCLUDING BUT NOT LIMITED TO THE WARRANTIES OF MERCHANTABILITY, FITNESS FOR A PARTICULAR PURPOSE AND NONINFRINGEMENT. IN NO EVENT SHALL THE AUTHORS OR COPYRIGHT HOLDERS BE LIABLE FOR ANY CLAIM, DAMAGES OR OTHER LIABILITY, WHETHER IN AN ACTION OF CONTRACT, TORT OR OTHERWISE, ARISING FROM, OUT OF OR IN CONNECTION WITH THE SOFTWARE OR THE USE OR OTHER DEALINGS IN THE SOFTWARE.

--- end of LICENSE ---

%% This notice is provided with respect to FontConfig 2.5, which may be included with JRE 8, JDK 8, and OpenJDK 8 source distributions on Linux and Solaris.

--- begin of LICENSE ---

Copyright c 2001,2003 Keith Packard

Permission to use, copy, modify, distribute, and sell this software and its documentation for any purpose is hereby granted without fee, provided that the above copyright notice appear in all copies and that both that copyright notice and this permission notice appear in supporting documentation, and that the name of Keith Packard not be used in advertising or publicity pertaining

to distribution of the software without specific, written prior permission.

Keith Packard makes no representations about the suitability of this software for any purpose. It is provided "as is" without express or implied warranty.

KEITH PACKARD DISCLAIMS ALL WARRANTIES WITH REGARD TO THIS SOFTWARE, INCLUDING ALL IMPLIED WARRANTIES OF MERCHANTABILITY AND FITNESS, IN NO EVENT SHALL KEITH PACKARD BE LIABLE FOR ANY SPECIAL, INDIRECT OR CONSEQUENTIAL DAMAGES OR ANY DAMAGES WHATSOEVER RESULTING FROM LOSS OF USE, DATA OR PROFITS, WHETHER IN AN ACTION OF CONTRACT, NEGLIGENCE OR OTHER TORTIOUS ACTION, ARISING OUT OF OR IN CONNECTION WITH THE USE OR PERFORMANCE OF THIS SOFTWARE.

--- end of LICENSE ---

%% This notice is provided with respect to IAIK PKCS#11 Wrapper, which may be included with JRE 8, JDK 8, and OpenJDK 8.

--- begin of LICENSE ---

IAIK PKCS#11 Wrapper License

Copyright (c) 2002 Graz University of Technology. All rights reserved.

Redistribution and use in source and binary forms, with or without modification, are permitted provided that the following conditions are met:

1. Redistributions of source code must retain the above copyright notice, this list of conditions and the following disclaimer.

2. Redistributions in binary form must reproduce the above copyright notice, this list of conditions and the following disclaimer in the documentation and/or other materials provided with the distribution.

3. The end-user documentation included with the redistribution, if any, must include the following acknowledgment:

"This product includes software developed by IAIK of Graz University of Technology."

Alternately, this acknowledgment may appear in the software itself, if and wherever such third-party acknowledgments normally appear.

4. The names "Graz University of Technology" and "IAIK of Graz University of Technology" must not be used to endorse or promote products derived from this software without prior written permission.

5. Products derived from this software may not be called "IAIK PKCS Wrapper", nor may "IAIK" appear in their name, without prior written permission of Graz University of Technology.

THIS SOFTWARE IS PROVIDED "AS IS" AND ANY EXPRESSED OR IMPLIED WARRANTIES, INCLUDING, BUT NOT LIMITED TO, THE IMPLIED WARRANTIES OF MERCHANTABILITY AND FITNESS FOR A PARTICULAR PURPOSE ARE DISCLAIMED. IN NO EVENT SHALL THE LICENSOR BE LIABLE FOR ANY DIRECT, INDIRECT, INCIDENTAL, SPECIAL, EXEMPLARY, OR CONSEQUENTIAL DAMAGES (INCLUDING, BUT NOT LIMITED TO, PROCUREMENT OF SUBSTITUTE GOODS OR SERVICES; LOSS OF USE, DATA, OR PROFITS; OR BUSINESS INTERRUPTION) HOWEVER CAUSED AND ON ANY THEORY OF LIABILITY, WHETHER IN CONTRACT, STRICT LIABILITY, OR TORT (INCLUDING NEGLIGENCE OR

OTHERWISE)

ARISING IN ANY WAY OUT OF THE USE OF THIS SOFTWARE, EVEN IF ADVISED
OF THE
POSSIBILITY OF SUCH DAMAGE.

--- end of LICENSE ---

%% This notice is provided with respect to ICU4C 4.0.1 and ICU4J 4.4, which
may be included with JRE 8, JDK 8, and OpenJDK 8.

--- begin of LICENSE ---

Copyright (c) 1995-2010 International Business Machines Corporation and others

All rights reserved.

Permission is hereby granted, free of charge, to any person obtaining a copy
of this software and associated documentation files (the "Software"), to deal
in the Software without restriction, including without limitation the rights
to use, copy, modify, merge, publish, distribute, and/or sell copies of the
Software, and to permit persons to whom the Software is furnished to do so,
provided that the above copyright notice(s) and this permission notice appear
in all copies of the Software and that both the above copyright notice(s) and
this permission notice appear in supporting documentation.

THE SOFTWARE IS PROVIDED "AS IS", WITHOUT WARRANTY OF ANY KIND,
EXPRESS OR
IMPLIED, INCLUDING BUT NOT LIMITED TO THE WARRANTIES OF
MERCHANTABILITY,
FITNESS FOR A PARTICULAR PURPOSE AND NONINFRINGEMENT OF THIRD
PARTY RIGHTS. IN
NO EVENT SHALL THE COPYRIGHT HOLDER OR HOLDERS INCLUDED IN THIS
NOTICE BE
LIABLE FOR ANY CLAIM, OR ANY SPECIAL INDIRECT OR CONSEQUENTIAL

DAMAGES, OR ANY
DAMAGES WHATSOEVER RESULTING FROM LOSS OF USE, DATA OR PROFITS,
WHETHER IN AN
ACTION OF CONTRACT, NEGLIGENCE OR OTHER TORTIOUS ACTION, ARISING
OUT OF OR IN
CONNECTION WITH THE USE OR PERFORMANCE OF THIS SOFTWARE.

Except as contained in this notice, the name of a copyright holder shall not
be used in advertising or otherwise to promote the sale, use or other dealings
in this Software without prior written authorization of the copyright holder.
All trademarks and registered trademarks mentioned herein are the property of
their respective owners.

--- end of LICENSE ---

%% This notice is provided with respect to IJG JPEG 6b, which may be
included with JRE 8, JDK 8, and OpenJDK 8.

--- begin of LICENSE ---

This software is copyright (C) 1991-1998, Thomas G. Lane.
All Rights Reserved except as specified below.

Permission is hereby granted to use, copy, modify, and distribute this
software (or portions thereof) for any purpose, without fee, subject to these
conditions:

- (1) If any part of the source code for this software is distributed, then this
README file must be included, with this copyright and no-warranty notice
unaltered; and any additions, deletions, or changes to the original files
must be clearly indicated in accompanying documentation.
- (2) If only executable code is distributed, then the accompanying
documentation must state that "this software is based in part on the work of
the Independent JPEG Group".
- (3) Permission for use of this software is granted only if the user accepts

full responsibility for any undesirable consequences; the authors accept NO LIABILITY for damages of any kind.

These conditions apply to any software derived from or based on the IJG code, not just to the unmodified library. If you use our work, you ought to acknowledge us.

Permission is NOT granted for the use of any IJG author's name or company name in advertising or publicity relating to this software or products derived from it. This software may be referred to only as "the Independent JPEG Group's software".

We specifically permit and encourage the use of this software as the basis of commercial products, provided that all warranty or liability claims are assumed by the product vendor.

--- end of LICENSE ---

%% This notice is provided with respect to Joni v1.1.9, which may be included with JRE 8, JDK 8, and OpenJDK 8.

--- begin of LICENSE ---

Permission is hereby granted, free of charge, to any person obtaining a copy of this software and associated documentation files (the "Software"), to deal in the Software without restriction, including without limitation the rights to use, copy, modify, merge, publish, distribute, sublicense, and/or sell copies of the Software, and to permit persons to whom the Software is furnished to do so, subject to the following conditions:

The above copyright notice and this permission notice shall be included in all copies or substantial portions of the Software.

THE SOFTWARE IS PROVIDED "AS IS", WITHOUT WARRANTY OF ANY KIND,

EXPRESS OR
IMPLIED, INCLUDING BUT NOT LIMITED TO THE WARRANTIES OF
MERCHANTABILITY,
FITNESS FOR A PARTICULAR PURPOSE AND NONINFRINGEMENT. IN NO
EVENT SHALL THE
AUTHORS OR COPYRIGHT HOLDERS BE LIABLE FOR ANY CLAIM, DAMAGES
OR OTHER
LIABILITY, WHETHER IN AN ACTION OF CONTRACT, TORT OR OTHERWISE,
ARISING FROM,
OUT OF OR IN CONNECTION WITH THE SOFTWARE OR THE USE OR OTHER
DEALINGS IN THE
SOFTWARE.

--- end of LICENSE ---

%% This notice is provided with respect to JOpt-Simple v3.0, which may be
included with JRE 8, JDK 8, and OpenJDK 8.

--- begin of LICENSE ---

Copyright (c) 2004-2009 Paul R. Holser, Jr.

Permission is hereby granted, free of charge, to any person obtaining
a copy of this software and associated documentation files (the
"Software"), to deal in the Software without restriction, including
without limitation the rights to use, copy, modify, merge, publish,
distribute, sublicense, and/or sell copies of the Software, and to
permit persons to whom the Software is furnished to do so, subject to
the following conditions:

The above copyright notice and this permission notice shall be
included in all copies or substantial portions of the Software.

THE SOFTWARE IS PROVIDED "AS IS", WITHOUT WARRANTY OF ANY KIND,

EXPRESS OR IMPLIED, INCLUDING BUT NOT LIMITED TO THE WARRANTIES
OF
MERCHANTABILITY, FITNESS FOR A PARTICULAR PURPOSE AND
NONINFRINGEMENT. IN NO EVENT SHALL THE AUTHORS OR COPYRIGHT
HOLDERS BE
LIABLE FOR ANY CLAIM, DAMAGES OR OTHER LIABILITY, WHETHER IN AN
ACTION
OF CONTRACT, TORT OR OTHERWISE, ARISING FROM, OUT OF OR IN
CONNECTION
WITH THE SOFTWARE OR THE USE OR OTHER DEALINGS IN THE SOFTWARE.

--- end of LICENSE ---

%% This notice is provided with respect to JSON, which may be included
with JRE 8 & JDK 8.

--- begin of LICENSE ---

Copyright (c) 2002 JSON.org

Permission is hereby granted, free of charge, to any person obtaining a copy
of this software and associated documentation files (the "Software"), to deal
in the Software without restriction, including without limitation the rights
to use, copy, modify, merge, publish, distribute, sublicense, and/or sell
copies of the Software, and to permit persons to whom the Software is
furnished to do so, subject to the following conditions:

The above copyright notice and this permission notice shall be included in all
copies or substantial portions of the Software.

The Software shall be used for Good, not Evil.

THE SOFTWARE IS PROVIDED "AS IS", WITHOUT WARRANTY OF ANY KIND,
EXPRESS OR

IMPLIED, INCLUDING BUT NOT LIMITED TO THE WARRANTIES OF
MERCHANTABILITY,
FITNESS FOR A PARTICULAR PURPOSE AND NONINFRINGEMENT. IN NO
EVENT SHALL THE
AUTHORS OR COPYRIGHT HOLDERS BE LIABLE FOR ANY CLAIM, DAMAGES
OR OTHER
LIABILITY, WHETHER IN AN ACTION OF CONTRACT, TORT OR OTHERWISE,
ARISING FROM,
OUT OF OR IN CONNECTION WITH THE SOFTWARE OR THE USE OR OTHER
DEALINGS IN THE
SOFTWARE.

--- end of LICENSE ---

%% This notice is provided with respect to Kerberos functionality, which
which may be included with JRE 8, JDK 8, and OpenJDK 8.

--- begin of LICENSE ---

(C) Copyright IBM Corp. 1999 All Rights Reserved.
Copyright 1997 The Open Group Research Institute. All rights reserved.

--- end of LICENSE ---

%% This notice is provided with respect to Kerberos functionality from
FundsXpress, INC., which may be included with JRE 8, JDK 8, and OpenJDK 8.

--- begin of LICENSE ---

Copyright (C) 1998 by the FundsXpress, INC.

All rights reserved.

Export of this software from the United States of America may require a specific license from the United States Government. It is the responsibility of any person or organization contemplating export to obtain such a license before exporting.

WITHIN THAT CONSTRAINT, permission to use, copy, modify, and distribute this software and its documentation for any purpose and without fee is hereby granted, provided that the above copyright notice appear in all copies and that both that copyright notice and this permission notice appear in supporting documentation, and that the name of FundsXpress. not be used in advertising or publicity pertaining to distribution of the software without specific, written prior permission. FundsXpress makes no representations about the suitability of this software for any purpose. It is provided "as is" without express or implied warranty.

THIS SOFTWARE IS PROVIDED ``AS IS" AND WITHOUT ANY EXPRESS OR IMPLIED WARRANTIES, INCLUDING, WITHOUT LIMITATION, THE IMPLIED WARRANTIES OF MERCHANTABILITY AND FITNESS FOR A PARTICULAR PURPOSE.

--- end of LICENSE ---

%% This notice is provided with respect to Kronos OpenGL headers, which may be included with JDK 8 and OpenJDK 8 source distributions.

--- begin of LICENSE ---

Copyright (c) 2007 The Khronos Group Inc.

Permission is hereby granted, free of charge, to any person obtaining a copy of this software and/or associated documentation files (the "Materials"), to

deal in the Materials without restriction, including without limitation the rights to use, copy, modify, merge, publish, distribute, sublicense, and/or sell copies of the Materials, and to permit persons to whom the Materials are furnished to do so, subject to the following conditions:

The above copyright notice and this permission notice shall be included in all copies or substantial portions of the Materials.

THE MATERIALS ARE PROVIDED "AS IS", WITHOUT WARRANTY OF ANY KIND, EXPRESS OR IMPLIED, INCLUDING BUT NOT LIMITED TO THE WARRANTIES OF MERCHANTABILITY, FITNESS FOR A PARTICULAR PURPOSE AND NONINFRINGEMENT. IN NO EVENT SHALL THE AUTHORS OR COPYRIGHT HOLDERS BE LIABLE FOR ANY CLAIM, DAMAGES OR OTHER LIABILITY, WHETHER IN AN ACTION OF CONTRACT, TORT OR OTHERWISE, ARISING FROM, OUT OF OR IN CONNECTION WITH THE MATERIALS OR THE USE OR OTHER DEALINGS IN THE MATERIALS.

--- end of LICENSE ---

%% Portions Copyright Eastman Kodak Company 1992

%% This notice is provided with respect to libpng 1.5.4, which may be included with JRE 8, JDK 8, and OpenJDK 8.

--- begin of LICENSE ---

This copy of the libpng notices is provided for your convenience. In case of

any discrepancy between this copy and the notices in the file png.h that is included in the libpng distribution, the latter shall prevail.

COPYRIGHT NOTICE, DISCLAIMER, and LICENSE:

If you modify libpng you may insert additional notices immediately following this sentence.

This code is released under the libpng license.

libpng versions 1.2.6, August 15, 2004, through 1.5.4, July 7, 2011, are Copyright (c) 2004, 2006-2011 Glenn Randers-Pehrson, and are distributed according to the same disclaimer and license as libpng-1.2.5 with the following individual added to the list of Contributing Authors

Cosmin Truta

libpng versions 1.0.7, July 1, 2000, through 1.2.5 - October 3, 2002, are Copyright (c) 2000-2002 Glenn Randers-Pehrson, and are distributed according to the same disclaimer and license as libpng-1.0.6 with the following individuals added to the list of Contributing Authors

Simon-Pierre Cadieux

Eric S. Raymond

Gilles Vollant

and with the following additions to the disclaimer:

There is no warranty against interference with your enjoyment of the library or against infringement. There is no warranty that our efforts or the library will fulfill any of your particular purposes or needs. This library is provided with all faults, and the entire risk of satisfactory quality, performance, accuracy, and effort is with the user.

libpng versions 0.97, January 1998, through 1.0.6, March 20, 2000, are

Copyright (c) 1998, 1999 Glenn Randers-Pehrson, and are distributed according to the same disclaimer and license as libpng-0.96, with the following individuals added to the list of Contributing Authors:

Tom Lane
Glenn Randers-Pehrson
Willem van Schaik

libpng versions 0.89, June 1996, through 0.96, May 1997, are Copyright (c) 1996, 1997 Andreas Dilger Distributed according to the same disclaimer and license as libpng-0.88, with the following individuals added to the list of Contributing Authors:

John Bowler
Kevin Bracey
Sam Bushell
Magnus Holmgren
Greg Roelofs
Tom Tanner

libpng versions 0.5, May 1995, through 0.88, January 1996, are Copyright (c) 1995, 1996 Guy Eric Schalnat, Group 42, Inc.

For the purposes of this copyright and license, "Contributing Authors" is defined as the following set of individuals:

Andreas Dilger
Dave Martindale
Guy Eric Schalnat
Paul Schmidt
Tim Wegner

The PNG Reference Library is supplied "AS IS". The Contributing Authors and Group 42, Inc. disclaim all warranties, expressed or implied, including, without limitation, the warranties of merchantability and of fitness for any purpose. The Contributing Authors and Group 42, Inc.

assume no liability for direct, indirect, incidental, special, exemplary, or consequential damages, which may result from the use of the PNG Reference Library, even if advised of the possibility of such damage.

Permission is hereby granted to use, copy, modify, and distribute this source code, or portions hereof, for any purpose, without fee, subject to the following restrictions:

1. The origin of this source code must not be misrepresented.
2. Altered versions must be plainly marked as such and must not be misrepresented as being the original source.
3. This Copyright notice may not be removed or altered from any source or altered source distribution.

The Contributing Authors and Group 42, Inc. specifically permit, without fee, and encourage the use of this source code as a component to supporting the PNG file format in commercial products. If you use this source code in a product, acknowledgment is not required but would be appreciated.

A "png_get_copyright" function is available, for convenient use in "about" boxes and the like:

```
printf("%s",png_get_copyright(NULL));
```

Also, the PNG logo (in PNG format, of course) is supplied in the files "pngbar.png" and "pngbar.jpg (88x31) and "pngnow.png" (98x31).

Libpng is OSI Certified Open Source Software. OSI Certified Open Source is a certification mark of the Open Source Initiative.

Glenn Randers-Pehrson
glennrp at users.sourceforge.net

July 7, 2011

--- end of LICENSE ---

%% This notice is provided with respect to libungif 4.1.3, which may be included with JRE 8, JDK 8, and OpenJDK 8.

--- begin of LICENSE ---

The GIFLIB distribution is Copyright (c) 1997 Eric S. Raymond

Permission is hereby granted, free of charge, to any person obtaining a copy of this software and associated documentation files (the "Software"), to deal in the Software without restriction, including without limitation the rights to use, copy, modify, merge, publish, distribute, sublicense, and/or sell copies of the Software, and to permit persons to whom the Software is furnished to do so, subject to the following conditions:

The above copyright notice and this permission notice shall be included in all copies or substantial portions of the Software.

THE SOFTWARE IS PROVIDED "AS IS", WITHOUT WARRANTY OF ANY KIND, EXPRESS OR IMPLIED, INCLUDING BUT NOT LIMITED TO THE WARRANTIES OF MERCHANTABILITY, FITNESS FOR A PARTICULAR PURPOSE AND NONINFRINGEMENT. IN NO EVENT SHALL THE AUTHORS OR COPYRIGHT HOLDERS BE LIABLE FOR ANY CLAIM, DAMAGES OR OTHER LIABILITY, WHETHER IN AN ACTION OF CONTRACT, TORT OR OTHERWISE, ARISING FROM, OUT OF OR IN CONNECTION WITH THE SOFTWARE OR THE USE OR OTHER DEALINGS IN THE SOFTWARE.

--- end of LICENSE ---

%% This notice is provided with respect to Little CMS 2.5, which may be included with JRE 8, JDK 8, and OpenJDK 8.

--- begin of LICENSE ---

Little CMS
Copyright (c) 1998-2011 Marti Maria Saguer

Permission is hereby granted, free of charge, to any person obtaining a copy of this software and associated documentation files (the "Software"), to deal in the Software without restriction, including without limitation the rights to use, copy, modify, merge, publish, distribute, sublicense, and/or sell copies of the Software, and to permit persons to whom the Software is furnished to do so, subject to the following conditions:

The above copyright notice and this permission notice shall be included in all copies or substantial portions of the Software.

THE SOFTWARE IS PROVIDED "AS IS", WITHOUT WARRANTY OF ANY KIND, EXPRESS OR IMPLIED, INCLUDING BUT NOT LIMITED TO THE WARRANTIES OF MERCHANTABILITY, FITNESS FOR A PARTICULAR PURPOSE AND NONINFRINGEMENT. IN NO EVENT SHALL THE AUTHORS OR COPYRIGHT HOLDERS BE LIABLE FOR ANY CLAIM, DAMAGES OR OTHER LIABILITY, WHETHER IN AN ACTION OF CONTRACT, TORT OR OTHERWISE, ARISING FROM, OUT OF OR IN CONNECTION WITH THE SOFTWARE OR THE USE OR OTHER DEALINGS IN THE SOFTWARE.

--- end of LICENSE ---

%% Lucida is a registered trademark or trademark of Bigelow & Holmes in the
U.S. and other countries.

%% This notice is provided with respect to Mesa 3D Graphics Library v4.1,
which may be included with JRE 8, JDK 8, and OpenJDK 8 source distributions.

--- begin of LICENSE ---

Mesa 3-D graphics library
Version: 4.1

Copyright (C) 1999-2002 Brian Paul All Rights Reserved.

Permission is hereby granted, free of charge, to any person obtaining a
copy of this software and associated documentation files (the "Software"),
to deal in the Software without restriction, including without limitation
the rights to use, copy, modify, merge, publish, distribute, sublicense,
and/or sell copies of the Software, and to permit persons to whom the
Software is furnished to do so, subject to the following conditions:

The above copyright notice and this permission notice shall be included
in all copies or substantial portions of the Software.

THE SOFTWARE IS PROVIDED "AS IS", WITHOUT WARRANTY OF ANY KIND,
EXPRESS
OR IMPLIED, INCLUDING BUT NOT LIMITED TO THE WARRANTIES OF
MERCHANTABILITY,
FITNESS FOR A PARTICULAR PURPOSE AND NONINFRINGEMENT. IN NO
EVENT SHALL

BRIAN PAUL BE LIABLE FOR ANY CLAIM, DAMAGES OR OTHER LIABILITY,
WHETHER IN
AN ACTION OF CONTRACT, TORT OR OTHERWISE, ARISING FROM, OUT OF OR
IN
CONNECTION WITH THE SOFTWARE OR THE USE OR OTHER DEALINGS IN
THE SOFTWARE.

--- end of LICENSE ---

%% This notice is provided with respect to Mozilla Network Security
Services (NSS), which is supplied with the JDK test suite in the OpenJDK
source code repository. It is licensed under Mozilla Public License (MPL),
version 2.0.

The NSS libraries are supplied in executable form, built from unmodified
NSS source code labeled with the "NSS_3.13.1_RTM" release tag.

The NSS source code is available in the OpenJDK source code repository at:
jdk/test/sun/security/pkcs11/nss/src

The NSS libraries are available in the OpenJDK source code repository at:
jdk/test/sun/security/pkcs11/nss/lib

--- begin of LICENSE ---

Mozilla Public License Version 2.0

=====

1. Definitions

1.1. "Contributor"

means each individual or legal entity that creates, contributes to
the creation of, or owns Covered Software.

1.2. "Contributor Version"

means the combination of the Contributions of others (if any) used by a Contributor and that particular Contributor's Contribution.

1.3. "Contribution"

means Covered Software of a particular Contributor.

1.4. "Covered Software"

means Source Code Form to which the initial Contributor has attached the notice in Exhibit A, the Executable Form of such Source Code Form, and Modifications of such Source Code Form, in each case including portions thereof.

1.5. "Incompatible With Secondary Licenses"

means

(a) that the initial Contributor has attached the notice described in Exhibit B to the Covered Software; or

(b) that the Covered Software was made available under the terms of version 1.1 or earlier of the License, but not also under the terms of a Secondary License.

1.6. "Executable Form"

means any form of the work other than Source Code Form.

1.7. "Larger Work"

means a work that combines Covered Software with other material, in a separate file or files, that is not Covered Software.

1.8. "License"

means this document.

1.9. "Licensable"

means having the right to grant, to the maximum extent possible,

whether at the time of the initial grant or subsequently, any and all of the rights conveyed by this License.

1.10. "Modifications"

means any of the following:

(a) any file in Source Code Form that results from an addition to, deletion from, or modification of the contents of Covered Software; or

(b) any new file in Source Code Form that contains any Covered Software.

1.11. "Patent Claims" of a Contributor

means any patent claim(s), including without limitation, method, process, and apparatus claims, in any patent Licensable by such Contributor that would be infringed, but for the grant of the License, by the making, using, selling, offering for sale, having made, import, or transfer of either its Contributions or its Contributor Version.

1.12. "Secondary License"

means either the GNU General Public License, Version 2.0, the GNU Lesser General Public License, Version 2.1, the GNU Affero General Public License, Version 3.0, or any later versions of those licenses.

1.13. "Source Code Form"

means the form of the work preferred for making modifications.

1.14. "You" (or "Your")

means an individual or a legal entity exercising rights under this License. For legal entities, "You" includes any entity that controls, is controlled by, or is under common control with You. For purposes of this definition, "control" means (a) the power, direct or indirect, to cause the direction or management of such entity,

whether by contract or otherwise, or (b) ownership of more than fifty percent (50%) of the outstanding shares or beneficial ownership of such entity.

2. License Grants and Conditions

2.1. Grants

Each Contributor hereby grants You a world-wide, royalty-free, non-exclusive license:

- (a) under intellectual property rights (other than patent or trademark) Licensable by such Contributor to use, reproduce, make available, modify, display, perform, distribute, and otherwise exploit its Contributions, either on an unmodified basis, with Modifications, or as part of a Larger Work; and
- (b) under Patent Claims of such Contributor to make, use, sell, offer for sale, have made, import, and otherwise transfer either its Contributions or its Contributor Version.

2.2. Effective Date

The licenses granted in Section 2.1 with respect to any Contribution become effective for each Contribution on the date the Contributor first distributes such Contribution.

2.3. Limitations on Grant Scope

The licenses granted in this Section 2 are the only rights granted under this License. No additional rights or licenses will be implied from the distribution or licensing of Covered Software under this License. Notwithstanding Section 2.1(b) above, no patent license is granted by a Contributor:

(a) for any code that a Contributor has removed from Covered Software;
or

(b) for infringements caused by: (i) Your and any other third party's modifications of Covered Software, or (ii) the combination of its Contributions with other software (except as part of its Contributor Version); or

(c) under Patent Claims infringed by Covered Software in the absence of its Contributions.

This License does not grant any rights in the trademarks, service marks, or logos of any Contributor (except as may be necessary to comply with the notice requirements in Section 3.4).

2.4. Subsequent Licenses

No Contributor makes additional grants as a result of Your choice to distribute the Covered Software under a subsequent version of this License (see Section 10.2) or under the terms of a Secondary License (if permitted under the terms of Section 3.3).

2.5. Representation

Each Contributor represents that the Contributor believes its Contributions are its original creation(s) or it has sufficient rights to grant the rights to its Contributions conveyed by this License.

2.6. Fair Use

This License is not intended to limit any rights You have under applicable copyright doctrines of fair use, fair dealing, or other equivalents.

2.7. Conditions

Sections 3.1, 3.2, 3.3, and 3.4 are conditions of the licenses granted in Section 2.1.

3. Responsibilities

3.1. Distribution of Source Form

All distribution of Covered Software in Source Code Form, including any Modifications that You create or to which You contribute, must be under the terms of this License. You must inform recipients that the Source Code Form of the Covered Software is governed by the terms of this License, and how they can obtain a copy of this License. You may not attempt to alter or restrict the recipients' rights in the Source Code Form.

3.2. Distribution of Executable Form

If You distribute Covered Software in Executable Form then:

- (a) such Covered Software must also be made available in Source Code Form, as described in Section 3.1, and You must inform recipients of the Executable Form how they can obtain a copy of such Source Code Form by reasonable means in a timely manner, at a charge no more than the cost of distribution to the recipient; and
- (b) You may distribute such Executable Form under the terms of this License, or sublicense it under different terms, provided that the license for the Executable Form does not attempt to limit or alter the recipients' rights in the Source Code Form under this License.

3.3. Distribution of a Larger Work

You may create and distribute a Larger Work under terms of Your choice, provided that You also comply with the requirements of this License for the Covered Software. If the Larger Work is a combination of Covered

Software with a work governed by one or more Secondary Licenses, and the Covered Software is not Incompatible With Secondary Licenses, this License permits You to additionally distribute such Covered Software under the terms of such Secondary License(s), so that the recipient of the Larger Work may, at their option, further distribute the Covered Software under the terms of either this License or such Secondary License(s).

3.4. Notices

You may not remove or alter the substance of any license notices (including copyright notices, patent notices, disclaimers of warranty, or limitations of liability) contained within the Source Code Form of the Covered Software, except that You may alter any license notices to the extent required to remedy known factual inaccuracies.

3.5. Application of Additional Terms

You may choose to offer, and to charge a fee for, warranty, support, indemnity or liability obligations to one or more recipients of Covered Software. However, You may do so only on Your own behalf, and not on behalf of any Contributor. You must make it absolutely clear that any such warranty, support, indemnity, or liability obligation is offered by You alone, and You hereby agree to indemnify every Contributor for any liability incurred by such Contributor as a result of warranty, support, indemnity or liability terms You offer. You may include additional disclaimers of warranty and limitations of liability specific to any jurisdiction.

4. Inability to Comply Due to Statute or Regulation

If it is impossible for You to comply with any of the terms of this License with respect to some or all of the Covered Software due to statute, judicial order, or regulation then You must: (a) comply with the terms of this License to the maximum extent possible; and (b)

describe the limitations and the code they affect. Such description must be placed in a text file included with all distributions of the Covered Software under this License. Except to the extent prohibited by statute or regulation, such description must be sufficiently detailed for a recipient of ordinary skill to be able to understand it.

5. Termination

5.1. The rights granted under this License will terminate automatically if You fail to comply with any of its terms. However, if You become compliant, then the rights granted under this License from a particular Contributor are reinstated (a) provisionally, unless and until such Contributor explicitly and finally terminates Your grants, and (b) on an ongoing basis, if such Contributor fails to notify You of the non-compliance by some reasonable means prior to 60 days after You have come back into compliance. Moreover, Your grants from a particular Contributor are reinstated on an ongoing basis if such Contributor notifies You of the non-compliance by some reasonable means, this is the first time You have received notice of non-compliance with this License from such Contributor, and You become compliant prior to 30 days after Your receipt of the notice.

5.2. If You initiate litigation against any entity by asserting a patent infringement claim (excluding declaratory judgment actions, counter-claims, and cross-claims) alleging that a Contributor Version directly or indirectly infringes any patent, then the rights granted to You by any and all Contributors for the Covered Software under Section 2.1 of this License shall terminate.

5.3. In the event of termination under Sections 5.1 or 5.2 above, all end user license agreements (excluding distributors and resellers) which have been validly granted by You or Your distributors under this License prior to termination shall survive termination.

* *
* 6. Disclaimer of Warranty *
* ----- *

* *
* Covered Software is provided under this License on an "as is" *
* basis, without warranty of any kind, either expressed, implied, or *
* statutory, including, without limitation, warranties that the *
* Covered Software is free of defects, merchantable, fit for a *
* particular purpose or non-infringing. The entire risk as to the *
* quality and performance of the Covered Software is with You. *
* Should any Covered Software prove defective in any respect, You *
* (not any Contributor) assume the cost of any necessary servicing, *
* repair, or correction. This disclaimer of warranty constitutes an *
* essential part of this License. No use of any Covered Software is *
* authorized under this License except under this disclaimer. *
* *

* *
* 7. Limitation of Liability *
* ----- *

* *
* Under no circumstances and under no legal theory, whether tort *
* (including negligence), contract, or otherwise, shall any *
* Contributor, or anyone who distributes Covered Software as *
* permitted above, be liable to You for any direct, indirect, *
* special, incidental, or consequential damages of any character *
* including, without limitation, damages for lost profits, loss of *
* goodwill, work stoppage, computer failure or malfunction, or any *
* and all other commercial damages or losses, even if such party *
* shall have been informed of the possibility of such damages. This *
* limitation of liability shall not apply to liability for death or *
* personal injury resulting from such party's negligence to the *
* extent applicable law prohibits such limitation. Some *
* jurisdictions do not allow the exclusion or limitation of *

* incidental or consequential damages, so this exclusion and *
* limitation may not apply to You. *
* *

8. Litigation

Any litigation relating to this License may be brought only in the courts of a jurisdiction where the defendant maintains its principal place of business and such litigation shall be governed by laws of that jurisdiction, without reference to its conflict-of-law provisions. Nothing in this Section shall prevent a party's ability to bring cross-claims or counter-claims.

9. Miscellaneous

This License represents the complete agreement concerning the subject matter hereof. If any provision of this License is held to be unenforceable, such provision shall be reformed only to the extent necessary to make it enforceable. Any law or regulation which provides that the language of a contract shall be construed against the drafter shall not be used to construe this License against a Contributor.

10. Versions of the License

10.1. New Versions

Mozilla Foundation is the license steward. Except as provided in Section 10.3, no one other than the license steward has the right to modify or publish new versions of this License. Each version will be given a distinguishing version number.

10.2. Effect of New Versions

You may distribute the Covered Software under the terms of the version of the License under which You originally received the Covered Software, or under the terms of any subsequent version published by the license steward.

10.3. Modified Versions

If you create software not governed by this License, and you want to create a new license for such software, you may create and use a modified version of this License if you rename the license and remove any references to the name of the license steward (except to note that such modified license differs from this License).

10.4. Distributing Source Code Form that is Incompatible With Secondary Licenses

If You choose to distribute Source Code Form that is Incompatible With Secondary Licenses under the terms of this version of the License, the notice described in Exhibit B of this License must be attached.

Exhibit A - Source Code Form License Notice

This Source Code Form is subject to the terms of the Mozilla Public License, v. 2.0. If a copy of the MPL was not distributed with this file, You can obtain one at <http://mozilla.org/MPL/2.0/>.

If it is not possible or desirable to put the notice in a particular file, then You may include the notice in a location (such as a LICENSE file in a relevant directory) where a recipient would be likely to look for such a notice.

You may add additional accurate notices of copyright ownership.

Exhibit B - "Incompatible With Secondary Licenses" Notice

This Source Code Form is "Incompatible With Secondary Licenses", as defined by the Mozilla Public License, v. 2.0.

--- end of LICENSE ---

%% This notice is provided with respect to PC/SC Lite for Suse Linux v.1.1.1, which may be included with JRE 8, JDK 8, and OpenJDK 8 on Linux and Solaris.

--- begin of LICENSE ---

Copyright (c) 1999-2004 David Corcoran <corcoran@linuxnet.com>
Copyright (c) 1999-2004 Ludovic Rousseau <ludovic.rousseau (at) free.fr>
All rights reserved.

Redistribution and use in source and binary forms, with or without modification, are permitted provided that the following conditions are met:

1. Redistributions of source code must retain the above copyright notice, this list of conditions and the following disclaimer.
2. Redistributions in binary form must reproduce the above copyright notice, this list of conditions and the following disclaimer in the documentation and/or other materials provided with the distribution.
3. All advertising materials mentioning features or use of this software must display the following acknowledgement:
 This product includes software developed by:
 David Corcoran <corcoran@linuxnet.com>
 <http://www.linuxnet.com> (MUSCLE)
4. The name of the author may not be used to endorse or promote products derived from this software without specific prior written permission.

Changes to this license can be made only by the copyright author with

explicit written consent.

THIS SOFTWARE IS PROVIDED BY THE AUTHOR ``AS IS" AND ANY EXPRESS OR IMPLIED WARRANTIES, INCLUDING, BUT NOT LIMITED TO, THE IMPLIED WARRANTIES

OF MERCHANTABILITY AND FITNESS FOR A PARTICULAR PURPOSE ARE DISCLAIMED.

IN NO EVENT SHALL THE AUTHOR BE LIABLE FOR ANY DIRECT, INDIRECT, INCIDENTAL, SPECIAL, EXEMPLARY, OR CONSEQUENTIAL DAMAGES (INCLUDING, BUT

NOT LIMITED TO, PROCUREMENT OF SUBSTITUTE GOODS OR SERVICES; LOSS OF USE,

DATA, OR PROFITS; OR BUSINESS INTERRUPTION) HOWEVER CAUSED AND ON ANY

THEORY OF LIABILITY, WHETHER IN CONTRACT, STRICT LIABILITY, OR TORT (INCLUDING NEGLIGENCE OR OTHERWISE) ARISING IN ANY WAY OUT OF THE USE OF

THIS SOFTWARE, EVEN IF ADVISED OF THE POSSIBILITY OF SUCH DAMAGE.

--- end of LICENSE ---

%% This notice is provided with respect to PorterStemmer v4, which may be included with JRE 8, JDK 8, and OpenJDK 8.

--- begin of LICENSE ---

See: <http://tartarus.org/~martin/PorterStemmer>

The software is completely free for any purpose, unless notes at the head of the program text indicates otherwise (which is rare). In any case, the notes about licensing are never more restrictive than the BSD License.

In every case where the software is not written by me (Martin Porter), this licensing arrangement has been endorsed by the contributor, and it is

therefore unnecessary to ask the contributor again to confirm it.

I have not asked any contributors (or their employers, if they have them) for proofs that they have the right to distribute their software in this way.

--- end of LICENSE ---

%% This notice is provided with respect to Relax NG Object/Parser v.20050510,
which may be included with JRE 8, JDK 8, and OpenJDK 8.

--- begin of LICENSE ---

Copyright (c) Kohsuke Kawaguchi

Permission is hereby granted, free of charge, to any person obtaining a copy of this software and associated documentation files (the "Software"), to deal in the Software without restriction, including without limitation the rights to use, copy, modify, merge, publish, distribute, sublicense, and/or sell copies of the Software, and to permit persons to whom the Software is furnished to do so, subject to the following conditions: The above copyright notice and this permission notice shall be included in all copies or substantial portions of the Software.

THE SOFTWARE IS PROVIDED "AS IS", WITHOUT WARRANTY OF ANY KIND, EXPRESS OR IMPLIED, INCLUDING BUT NOT LIMITED TO THE WARRANTIES OF MERCHANTABILITY, FITNESS FOR A PARTICULAR PURPOSE AND NONINFRINGEMENT. IN NO EVENT SHALL THE AUTHORS OR COPYRIGHT HOLDERS BE LIABLE FOR ANY CLAIM, DAMAGES OR OTHER LIABILITY, WHETHER IN AN ACTION OF CONTRACT, TORT OR OTHERWISE, ARISING FROM, OUT OF OR IN CONNECTION WITH THE SOFTWARE OR THE USE OR OTHER

DEALINGS IN THE
SOFTWARE.

--- end of LICENSE ---

%% This notice is provided with respect to RelaxNGCC v1.12, which may be
included with JRE 8, JDK 8, and OpenJDK 8.

--- begin of LICENSE ---

Copyright (c) 2000-2003 Daisuke Okajima and Kohsuke Kawaguchi.
All rights reserved.

Redistribution and use in source and binary forms, with or without
modification, are permitted provided that the following conditions are met:

1. Redistributions of source code must retain the above copyright notice, this
list of conditions and the following disclaimer.
2. Redistributions in binary form must reproduce the above copyright notice,
this list of conditions and the following disclaimer in the documentation
and/or other materials provided with the distribution.
3. The end-user documentation included with the redistribution, if any, must
include the following acknowledgment:

"This product includes software developed by Daisuke Okajima
and Kohsuke Kawaguchi (<http://relaxngcc.sf.net/>)."

Alternately, this acknowledgment may appear in the software itself, if and
wherever such third-party acknowledgments normally appear.

4. The names of the copyright holders must not be used to endorse or promote
products derived from this software without prior written permission. For

written permission, please contact the copyright holders.

5. Products derived from this software may not be called "RELAXNGCC", nor may "RELAXNGCC" appear in their name, without prior written permission of the copyright holders.

THIS SOFTWARE IS PROVIDED "AS IS" AND ANY EXPRESSED OR IMPLIED WARRANTIES, INCLUDING, BUT NOT LIMITED TO, THE IMPLIED WARRANTIES OF MERCHANTABILITY AND FITNESS FOR A PARTICULAR PURPOSE ARE DISCLAIMED. IN NO EVENT SHALL THE APACHE SOFTWARE FOUNDATION OR ITS CONTRIBUTORS BE LIABLE FOR ANY DIRECT, INDIRECT, INCIDENTAL, SPECIAL, EXEMPLARY, OR CONSEQUENTIAL DAMAGES (INCLUDING, BUT NOT LIMITED TO, PROCUREMENT OF SUBSTITUTE GOODS OR SERVICES; LOSS OF USE, DATA, OR PROFITS; OR BUSINESS INTERRUPTION) HOWEVER CAUSED AND ON ANY THEORY OF LIABILITY, WHETHER IN CONTRACT, STRICT LIABILITY, OR TORT (INCLUDING NEGLIGENCE OR OTHERWISE) ARISING IN ANY WAY OUT OF THE USE OF THIS SOFTWARE, EVEN IF ADVISED OF THE POSSIBILITY OF SUCH DAMAGE.

--- end of LICENSE ---

%% This notice is provided with respect to SAX 2.0.1, which may be included with JRE 8, JDK 8, and OpenJDK 8.

--- begin of LICENSE ---

SAX is free!

In fact, it's not possible to own a license to SAX, since it's been placed in the public domain.

No Warranty

Because SAX is released to the public domain, there is no warranty for the design or for the software implementation, to the extent permitted by applicable law. Except when otherwise stated in writing the copyright holders and/or other parties provide SAX "as is" without warranty of any kind, either expressed or implied, including, but not limited to, the implied warranties of merchantability and fitness for a particular purpose. The entire risk as to the quality and performance of SAX is with you. Should SAX prove defective, you assume the cost of all necessary servicing, repair or correction.

In no event unless required by applicable law or agreed to in writing will any copyright holder, or any other party who may modify and/or redistribute SAX, be liable to you for damages, including any general, special, incidental or consequential damages arising out of the use or inability to use SAX (including but not limited to loss of data or data being rendered inaccurate or losses sustained by you or third parties or a failure of the SAX to operate with any other programs), even if such holder or other party has been advised of the possibility of such damages.

Copyright Disclaimers

This page includes statements to that effect by David Megginson, who would have been able to claim copyright for the original work. SAX 1.0

Version 1.0 of the Simple API for XML (SAX), created collectively by the membership of the XML-DEV mailing list, is hereby released into the public domain.

No one owns SAX: you may use it freely in both commercial and non-commercial applications, bundle it with your software distribution, include it on a CD-ROM, list the source code in a book, mirror the documentation at your own

web site, or use it in any other way you see fit.

David Megginson, sax@megginson.com

1998-05-11

SAX 2.0

I hereby abandon any property rights to SAX 2.0 (the Simple API for XML), and release all of the SAX 2.0 source code, compiled code, and documentation contained in this distribution into the Public Domain. SAX comes with NO WARRANTY or guarantee of fitness for any purpose.

David Megginson, david@megginson.com

2000-05-05

--- end of LICENSE ---

%% This notice is provided with respect to SoftFloat version 2b, which may be included with JRE 8, JDK 8, and OpenJDK 8 on Linux/ARM.

--- begin of LICENSE ---

Use of any of this software is governed by the terms of the license below:

SoftFloat was written by me, John R. Hauser. This work was made possible in part by the International Computer Science Institute, located at Suite 600, 1947 Center Street, Berkeley, California 94704. Funding was partially provided by the National Science Foundation under grant MIP-9311980. The original version of this code was written as part of a project to build a fixed-point vector processor in collaboration with the University of California at Berkeley, overseen by Profs. Nelson Morgan and John Wawrzynek.

THIS SOFTWARE IS DISTRIBUTED AS IS, FOR FREE. Although reasonable effort has been made to avoid it, THIS SOFTWARE MAY CONTAIN FAULTS THAT WILL AT

TIMES RESULT IN INCORRECT BEHAVIOR. USE OF THIS SOFTWARE IS RESTRICTED TO PERSONS AND ORGANIZATIONS WHO CAN AND WILL TAKE FULL RESPONSIBILITY FOR ALL LOSSES, COSTS, OR OTHER PROBLEMS THEY INCUR DUE TO THE SOFTWARE, AND WHO FURTHERMORE EFFECTIVELY INDEMNIFY JOHN HAUSER AND THE INTERNATIONAL COMPUTER SCIENCE INSTITUTE (possibly via similar legal warning) AGAINST ALL LOSSES, COSTS, OR OTHER PROBLEMS INCURRED BY THEIR CUSTOMERS AND CLIENTS DUE TO THE SOFTWARE.

Derivative works are acceptable, even for commercial purposes, provided that the minimal documentation requirements stated in the source code are satisfied.

--- end of LICENSE ---

%% This notice is provided with respect to Sparkle 1.5,
which may be included with JRE 8 on Mac OS X.

--- begin of LICENSE ---

Copyright (c) 2012 Sparkle.org and Andy Matuschak

Permission is hereby granted, free of charge, to any person obtaining a copy of this software and associated documentation files (the "Software"), to deal in the Software without restriction, including without limitation the rights to use, copy, modify, merge, publish, distribute, sublicense, and/or sell copies of the Software, and to permit persons to whom the Software is furnished to do so, subject to the following conditions:

The above copyright notice and this permission notice shall be included in all

copies or substantial portions of the Software.

THE SOFTWARE IS PROVIDED "AS IS", WITHOUT WARRANTY OF ANY KIND,
EXPRESS OR
IMPLIED, INCLUDING BUT NOT LIMITED TO THE WARRANTIES OF
MERCHANTABILITY,
FITNESS FOR A PARTICULAR PURPOSE AND NONINFRINGEMENT. IN NO
EVENT SHALL THE
AUTHORS OR COPYRIGHT HOLDERS BE LIABLE FOR ANY CLAIM, DAMAGES
OR OTHER
LIABILITY, WHETHER IN AN ACTION OF CONTRACT, TORT OR OTHERWISE,
ARISING FROM,
OUT OF OR IN CONNECTION WITH THE SOFTWARE OR THE USE OR OTHER
DEALINGS IN THE
SOFTWARE.

--- end of LICENSE ---

%% Portions licensed from Taligent, Inc.

%% This notice is provided with respect to Thai Dictionary, which may be
included with JRE 8, JDK 8, and OpenJDK 8.

--- begin of LICENSE ---

Copyright (C) 1982 The Royal Institute, Thai Royal Government.

Copyright (C) 1998 National Electronics and Computer Technology Center,
National Science and Technology Development Agency,
Ministry of Science Technology and Environment,
Thai Royal Government.

Permission is hereby granted, free of charge, to any person obtaining a copy of this software and associated documentation files (the "Software"), to deal in the Software without restriction, including without limitation the rights to use, copy, modify, merge, publish, distribute, sublicense, and/or sell copies of the Software, and to permit persons to whom the Software is furnished to do so, subject to the following conditions:

The above copyright notice and this permission notice shall be included in all copies or substantial portions of the Software.

THE SOFTWARE IS PROVIDED "AS IS", WITHOUT WARRANTY OF ANY KIND, EXPRESS OR IMPLIED, INCLUDING BUT NOT LIMITED TO THE WARRANTIES OF MERCHANTABILITY, FITNESS FOR A PARTICULAR PURPOSE AND NONINFRINGEMENT. IN NO EVENT SHALL THE AUTHORS OR COPYRIGHT HOLDERS BE LIABLE FOR ANY CLAIM, DAMAGES OR OTHER LIABILITY, WHETHER IN AN ACTION OF CONTRACT, TORT OR OTHERWISE, ARISING FROM, OUT OF OR IN CONNECTION WITH THE SOFTWARE OR THE USE OR OTHER DEALINGS IN THE SOFTWARE.

--- end of LICENSE ---

%% This notice is provided with respect to Unicode 6.2.0 & CLDR 21.0.1 which may be included with JRE 8, JDK 8, and OpenJDK 8.

--- begin of LICENSE ---

Unicode Terms of Use

For the general privacy policy governing access to this site, see the Unicode

Privacy Policy. For trademark usage, see the UnicodeR Consortium Name and Trademark Usage Policy.

A. Unicode Copyright.

1. Copyright c 1991-2013 Unicode, Inc. All rights reserved.
2. Certain documents and files on this website contain a legend indicating that "Modification is permitted." Any person is hereby authorized, without fee, to modify such documents and files to create derivative works conforming to the UnicodeR Standard, subject to Terms and Conditions herein.
3. Any person is hereby authorized, without fee, to view, use, reproduce, and distribute all documents and files solely for informational purposes in the creation of products supporting the Unicode Standard, subject to the Terms and Conditions herein.
4. Further specifications of rights and restrictions pertaining to the use of the particular set of data files known as the "Unicode Character Database" can be found in Exhibit 1.
5. Each version of the Unicode Standard has further specifications of rights and restrictions of use. For the book editions (Unicode 5.0 and earlier), these are found on the back of the title page. The online code charts carry specific restrictions. All other files, including online documentation of the core specification for Unicode 6.0 and later, are covered under these general Terms of Use.
6. No license is granted to "mirror" the Unicode website where a fee is charged for access to the "mirror" site.
7. Modification is not permitted with respect to this document. All copies of this document must be verbatim.

B. Restricted Rights Legend. Any technical data or software which is licensed to the United States of America, its agencies and/or instrumentalities

under this Agreement is commercial technical data or commercial computer software developed exclusively at private expense as defined in FAR 2.101, or DFARS 252.227-7014 (June 1995), as applicable. For technical data, use, duplication, or disclosure by the Government is subject to restrictions as set forth in DFARS 202.227-7015 Technical Data, Commercial and Items (Nov 1995) and this Agreement. For Software, in accordance with FAR 12-212 or DFARS 227-7202, as applicable, use, duplication or disclosure by the Government is subject to the restrictions set forth in this Agreement.

C. Warranties and Disclaimers.

1. This publication and/or website may include technical or typographical errors or other inaccuracies . Changes are periodically added to the information herein; these changes will be incorporated in new editions of the publication and/or website. Unicode may make improvements and/or changes in the product(s) and/or program(s) described in this publication and/or website at any time.

2. If this file has been purchased on magnetic or optical media from Unicode, Inc. the sole and exclusive remedy for any claim will be exchange of the defective media within ninety (90) days of original purchase.

3. EXCEPT AS PROVIDED IN SECTION C.2, THIS PUBLICATION AND/OR SOFTWARE IS

PROVIDED "AS IS" WITHOUT WARRANTY OF ANY KIND EITHER EXPRESS, IMPLIED,

OR STATUTORY, INCLUDING, BUT NOT LIMITED TO, ANY WARRANTIES OF

MERCHANTABILITY, FITNESS FOR A PARTICULAR PURPOSE, OR NON-INFRINGEMENT.

UNICODE AND ITS LICENSORS ASSUME NO RESPONSIBILITY FOR ERRORS OR

OMISSIONS IN THIS PUBLICATION AND/OR SOFTWARE OR OTHER DOCUMENTS WHICH

ARE REFERENCED BY OR LINKED TO THIS PUBLICATION OR THE UNICODE WEBSITE.

D. Waiver of Damages. In no event shall Unicode or its licensors be liable for any special, incidental, indirect or consequential damages of any kind, or any damages whatsoever, whether or not Unicode was advised of the possibility of the damage, including, without limitation, those resulting from the following: loss of use, data or profits, in connection with the use, modification or distribution of this information or its derivatives.

E. Trademarks & Logos.

1. The Unicode Word Mark and the Unicode Logo are trademarks of Unicode, Inc. “The Unicode Consortium” and “Unicode, Inc.” are trade names of Unicode, Inc. Use of the information and materials found on this website indicates your acknowledgement of Unicode, Inc.’s exclusive worldwide rights in the Unicode Word Mark, the Unicode Logo, and the Unicode trade names.
2. The Unicode Consortium Name and Trademark Usage Policy (“Trademark Policy”) are incorporated herein by reference and you agree to abide by the provisions of the Trademark Policy, which may be changed from time to time in the sole discretion of Unicode, Inc.
3. All third party trademarks referenced herein are the property of their respective owners.

Miscellaneous.

1. Jurisdiction and Venue. This server is operated from a location in the State of California, United States of America. Unicode makes no representation that the materials are appropriate for use in other locations. If you access this server from other locations, you are responsible for compliance with local laws. This Agreement, all use of this site and any claims and damages resulting from use of this site are governed solely by the laws of the State of California without regard to any principles which would apply the laws of a different jurisdiction. The user agrees that any disputes regarding this site shall be resolved solely in the courts located in Santa Clara County, California. The user agrees said courts have personal jurisdiction and agree to waive any

right to transfer the dispute to any other forum.

2. **Modification by Unicode.** Unicode shall have the right to modify this Agreement at any time by posting it to this site. The user may not assign any part of this Agreement without Unicode's prior written consent.
3. **Taxes.** The user agrees to pay any taxes arising from access to this website or use of the information herein, except for those based on Unicode's net income.
4. **Severability.** If any provision of this Agreement is declared invalid or unenforceable, the remaining provisions of this Agreement shall remain in effect.
5. **Entire Agreement.** This Agreement constitutes the entire agreement between the parties.

EXHIBIT 1

UNICODE, INC. LICENSE AGREEMENT - DATA FILES AND SOFTWARE

Unicode Data Files include all data files under the directories <http://www.unicode.org/Public/>, <http://www.unicode.org/reports/>, and <http://www.unicode.org/cldr/data/>. Unicode Data Files do not include PDF online code charts under the directory <http://www.unicode.org/Public/>. Software includes any source code published in the Unicode Standard or under the directories <http://www.unicode.org/Public/>, <http://www.unicode.org/reports/>, and <http://www.unicode.org/cldr/data/>.

NOTICE TO USER: Carefully read the following legal agreement. BY DOWNLOADING, INSTALLING, COPYING OR OTHERWISE USING UNICODE INC.'S DATA FILES ("DATA FILES"), AND/OR SOFTWARE ("SOFTWARE"), YOU UNEQUIVOCALLY ACCEPT, AND AGREE TO BE BOUND BY, ALL OF THE TERMS AND CONDITIONS OF THIS AGREEMENT. IF

YOU DO NOT
AGREE, DO NOT DOWNLOAD, INSTALL, COPY, DISTRIBUTE OR USE THE DATA
FILES OR
SOFTWARE.

COPYRIGHT AND PERMISSION NOTICE

Copyright c 1991-2012 Unicode, Inc. All rights reserved. Distributed under the
Terms of Use in <http://www.unicode.org/copyright.html>.

Permission is hereby granted, free of charge, to any person obtaining a copy
of the Unicode data files and any associated documentation (the "Data Files")
or Unicode software and any associated documentation (the "Software") to deal
in the Data Files or Software without restriction, including without
limitation the rights to use, copy, modify, merge, publish, distribute, and/or
sell copies of the Data Files or Software, and to permit persons to whom the
Data Files or Software are furnished to do so, provided that (a) the above
copyright notice(s) and this permission notice appear with all copies of the
Data Files or Software, (b) both the above copyright notice(s) and this
permission notice appear in associated documentation, and (c) there is clear
notice in each modified Data File or in the Software as well as in the
documentation associated with the Data File(s) or Software that the data or
software has been modified.

THE DATA FILES AND SOFTWARE ARE PROVIDED "AS IS", WITHOUT
WARRANTY OF ANY
KIND, EXPRESS OR IMPLIED, INCLUDING BUT NOT LIMITED TO THE
WARRANTIES OF
MERCHANTABILITY, FITNESS FOR A PARTICULAR PURPOSE AND
NONINFRINGEMENT OF THIRD
PARTY RIGHTS. IN NO EVENT SHALL THE COPYRIGHT HOLDER OR HOLDERS
INCLUDED IN
THIS NOTICE BE LIABLE FOR ANY CLAIM, OR ANY SPECIAL INDIRECT OR
CONSEQUENTIAL
DAMAGES, OR ANY DAMAGES WHATSOEVER RESULTING FROM LOSS OF USE,
DATA OR

PROFITS, WHETHER IN AN ACTION OF CONTRACT, NEGLIGENCE OR OTHER
TORTIOUS
ACTION, ARISING OUT OF OR IN CONNECTION WITH THE USE OR
PERFORMANCE OF THE
DATA FILES OR SOFTWARE.

Except as contained in this notice, the name of a copyright holder shall not
be used in advertising or otherwise to promote the sale, use or other dealings
in these Data Files or Software without prior written authorization of the
copyright holder.

Unicode and the Unicode logo are trademarks of Unicode, Inc. in the United
States and other countries. All third party trademarks referenced herein are
the property of their respective owners.

--- end of LICENSE ---

%% This notice is provided with respect to UPX v3.01, which may be included
with JRE 8 on Windows.

--- begin of LICENSE ---

Use of any of this software is governed by the terms of the license below:

```
00000      000 0000000000.      0000000  00000
`888'      `8' `888  `Y88.  `8888  d8'
888        8  888  .d88'   Y888..8P
888        8  88800088P'   `8888'
888        8  888                .8PY888.
`88.      .8'  888                d8' `888b
`YbodP'    o888o                o888o  o88888o
```

The Ultimate Packer for eXecutables
Copyright (c) 1996-2000 Markus Oberhumer & Laszlo Molnar
<http://wildsau.idv.uni-linz.ac.at/mfx/upx.html>
<http://www.nexus.hu/upx>
<http://upx.tsx.org>

PLEASE CAREFULLY READ THIS LICENSE AGREEMENT, ESPECIALLY IF YOU
PLAN
TO MODIFY THE UPX SOURCE CODE OR USE A MODIFIED UPX VERSION.

ABSTRACT

=====

UPX and UCL are copyrighted software distributed under the terms
of the GNU General Public License (hereinafter the "GPL").

The stub which is imbedded in each UPX compressed program is part
of UPX and UCL, and contains code that is under our copyright. The
terms of the GNU General Public License still apply as compressing
a program is a special form of linking with our stub.

As a special exception we grant the free usage of UPX for all
executables, including commercial programs.

See below for details and restrictions.

COPYRIGHT

=====

UPX and UCL are copyrighted software. All rights remain with the authors.

UPX is Copyright (C) 1996-2000 Markus Franz Xaver Johannes Oberhumer

UPX is Copyright (C) 1996-2000 Laszlo Molnar

UCL is Copyright (C) 1996-2000 Markus Franz Xaver Johannes Oberhumer

GNU GENERAL PUBLIC LICENSE

UPX and the UCL library are free software; you can redistribute them and/or modify them under the terms of the GNU General Public License as published by the Free Software Foundation; either version 2 of the License, or (at your option) any later version.

UPX and UCL are distributed in the hope that they will be useful, but WITHOUT ANY WARRANTY; without even the implied warranty of MERCHANTABILITY or FITNESS FOR A PARTICULAR PURPOSE. See the GNU General Public License for more details.

You should have received a copy of the GNU General Public License along with this program; see the file COPYING.

SPECIAL EXCEPTION FOR COMPRESSED EXECUTABLES

The stub which is imbedded in each UPX compressed program is part of UPX and UCL, and contains code that is under our copyright. The terms of the GNU General Public License still apply as compressing a program is a special form of linking with our stub.

Hereby Markus F.X.J. Oberhumer and Laszlo Molnar grant you special permission to freely use and distribute all UPX compressed programs (including commercial ones), subject to the following restrictions:

1. You must compress your program with a completely unmodified UPX version; either with our precompiled version, or (at your option) with a self compiled version of the unmodified UPX sources as distributed by us.

2. This also implies that the UPX stub must be completely unmodified, i.e. the stub imbedded in your compressed program must be byte-identical to the stub that is produced by the official unmodified UPX version.
3. The decompressor and any other code from the stub must exclusively get used by the unmodified UPX stub for decompressing your program at program startup. No portion of the stub may get read, copied, called or otherwise get used or accessed by your program.

ANNOTATIONS

=====

- You can use a modified UPX version or modified UPX stub only for programs that are compatible with the GNU General Public License.

- We grant you special permission to freely use and distribute all UPX compressed programs. But any modification of the UPX stub (such as, but not limited to, removing our copyright string or making your program non-decompressible) will immediately revoke your right to use and distribute a UPX compressed program.

- UPX is not a software protection tool; by requiring that you use the unmodified UPX version for your proprietary programs we make sure that any user can decompress your program. This protects both you and your users as nobody can hide malicious code - any program that cannot be decompressed is highly suspicious by definition.

- You can integrate all or part of UPX and UCL into projects that are compatible with the GNU GPL, but obviously you cannot grant any special exceptions beyond the GPL for our code in your project.

- We want to actively support manufacturers of virus scanners and similar security software. Please contact us if you would like to incorporate parts of UPX or UCL into such a product.

Markus F.X.J. Oberhumer
markus.oberhumer@jk.uni-linz.ac.at

Laszlo Molnar
ml1050@cdata.tvnet.hu

Linz, Austria, 25 Feb 2000

Additional License(s)

The UPX license file is at <http://upx.sourceforge.net/upx-license.html>.

--- end of LICENSE ---

%% This notice is provided with respect to Xfree86-VidMode Extension 1.0,
which may be included with JRE 8, JDK 8, and OpenJDK 8 on Linux and Solaris.

--- begin of LICENSE ---

Version 1.1 of XFree86 ProjectLicence.

Copyright (C) 1994-2004 The XFree86 Project, Inc. All rights reserved.

Permission is hereby granted, free of charge, to any person obtaining a copy of this software and associated documentation files (the "Software"), to deal in the Software without restriction, including without limitation the rights to use, copy, modify, merge, publish, distribute, sublicense, and/or sell copies of the Software, and to permit persons to whom the Software is furnished to do so, subject to the following conditions:

1. Redistributions of source code must retain the above copyright notice, this list of conditions, and the following disclaimer.
2. Redistributions in binary form must reproduce the above copyright notice, this list of conditions and the following disclaimer in the documentation

and/or other materials provided with the distribution, and in the same place and form as other copyright, license and disclaimer information.

3. The end-user documentation included with the redistribution, if any, must include the following acknowledgment: "This product includes software developed by The XFree86 Project, Inc (<http://www.xfree86.org/>) and its contributors", in the same place and form as other third-party acknowledgments. Alternately, this acknowledgment may appear in the software itself, in the same form and location as other such third-party acknowledgments.

4. Except as contained in this notice, the name of The XFree86 Project, Inc shall not be used in advertising or otherwise to promote the sale, use or other dealings in this Software without prior written authorization from The XFree86 Project, Inc.

THIS SOFTWARE IS PROVIDED "AS IS" AND ANY EXPRESSED OR IMPLIED WARRANTIES, INCLUDING, BUT NOT LIMITED TO, THE IMPLIED WARRANTIES OF MERCHANTABILITY AND FITNESS FOR A PARTICULAR PURPOSE ARE DISCLAIMED. IN NO EVENT SHALL THE XFREE86 PROJECT, INC OR ITS CONTRIBUTORS BE LIABLE FOR ANY DIRECT, INDIRECT, INCIDENTAL, SPECIAL, EXEMPLARY, OR CONSEQUENTIAL DAMAGES (INCLUDING, BUT NOT LIMITED TO, PROCUREMENT OF SUBSTITUTE GOODS OR SERVICES; LOSS OF USE, DATA, OR PROFITS; OR BUSINESS INTERRUPTION) HOWEVER CAUSED AND ON ANY THEORY OF LIABILITY, WHETHER IN CONTRACT, STRICT LIABILITY, OR TORT (INCLUDING NEGLIGENCE OR OTHERWISE) ARISING IN ANY WAY OUT OF THE USE OF THIS SOFTWARE, EVEN IF ADVISED OF THE POSSIBILITY OF SUCH DAMAGE.

--- end of LICENSE ---

%% This notice is provided with respect to X Window System 6.8.2, which may be included with JRE 8, JDK 8, and OpenJDK 8 on Linux and Solaris.

--- begin of LICENSE ---

Licenses

The X.Org Foundation March 2004

1. Introduction

The X.org Foundation X Window System distribution is a compilation of code and documentation from many sources. This document is intended primarily as a guide to the licenses used in the distribution: you must check each file and/or package for precise redistribution terms. None-the-less, this summary may be useful to many users. No software incorporating the XFree86 1.1 license has been incorporated.

This document is based on the compilation from XFree86.

2. XFree86 License

XFree86 code without an explicit copyright is covered by the following copyright/license:

Copyright (C) 1994-2003 The XFree86 Project, Inc. All Rights Reserved.

Permission is hereby granted, free of charge, to any person obtaining a copy of this software and associated documentation files (the "Software"), to deal in the Software without restriction, including without limitation the rights to use, copy, modify, merge, publish, distribute, sublicense, and/or sell copies of the Software, and to permit persons to whom the Software is

furnished to do so, subject to the following conditions:

The above copyright notice and this permission notice shall be included in all copies or substantial portions of the Software.

THE SOFTWARE IS PROVIDED "AS IS", WITHOUT WARRANTY OF ANY KIND, EXPRESS OR IMPLIED, INCLUDING BUT NOT LIMITED TO THE WARRANTIES OF MERCHANTABILITY, FITNESS FOR A PARTICULAR PURPOSE AND NONINFRINGEMENT. IN NO EVENT SHALL THE XFREE86 PROJECT BE LIABLE FOR ANY CLAIM, DAMAGES OR OTHER LIABILITY, WHETHER IN AN ACTION OF CONTRACT, TORT OR OTHERWISE, ARISING FROM, OUT OF OR IN CONNECTION WITH THE SOFTWARE OR THE USE OR OTHER DEALINGS IN THE SOFTWARE.

Except as contained in this notice, the name of the XFree86 Project shall not be used in advertising or otherwise to promote the sale, use or other dealings in this Software without prior written authorization from the XFree86 Project.

3. Other Licenses

Portions of code are covered by the following licenses/copyrights. See individual files for the copyright dates.

3.1. X/MIT Copyrights

3.1.1. X Consortium

Copyright (C) <date> X Consortium

Permission is hereby granted, free of charge, to any person obtaining a copy of this software and associated documentation files (the "Software"), to deal in the Software without restriction, including without limitation the rights

to use, copy, modify, merge, publish, distribute, sublicense, and/or sell copies of the Software, and to permit persons to whom the Software is furnished to do so, subject to the following conditions:

The above copyright notice and this permission notice shall be included in all copies or substantial portions of the Software.

THE SOFTWARE IS PROVIDED "AS IS", WITHOUT WARRANTY OF ANY KIND, EXPRESS OR IMPLIED, INCLUDING BUT NOT LIMITED TO THE WARRANTIES OF MERCHANTABILITY, FITNESS FOR A PARTICULAR PURPOSE AND NONINFRINGEMENT. IN NO EVENT SHALL THE X CONSORTIUM BE LIABLE FOR ANY CLAIM, DAMAGES OR OTHER LIABILITY, WHETHER IN AN ACTION OF CONTRACT, TORT OR OTHERWISE, ARISING FROM, OUT OF OR IN CONNECTION WITH THE SOFTWARE OR THE USE OR OTHER DEALINGS IN THE SOFTWARE.

Except as contained in this notice, the name of the X Consortium shall not be used in advertising or otherwise to promote the sale, use or other dealings in this Software without prior written authorization from the X Consortium.

X Window System is a trademark of X Consortium, Inc.

3.1.2. The Open Group

Copyright <date> The Open Group

Permission to use, copy, modify, distribute, and sell this software and its documentation for any purpose is hereby granted without fee, provided that the above copyright notice appear in all copies and that both that copyright notice and this permission notice appear in supporting documentation.

The above copyright notice and this permission notice shall be included in all copies or substantial portions of the Software.

THE SOFTWARE IS PROVIDED "AS IS", WITHOUT WARRANTY OF ANY KIND, EXPRESS OR IMPLIED, INCLUDING BUT NOT LIMITED TO THE WARRANTIES OF MERCHANTABILITY, FITNESS FOR A PARTICULAR PURPOSE AND NONINFRINGEMENT. IN NO EVENT SHALL THE OPEN GROUP BE LIABLE FOR ANY CLAIM, DAMAGES OR OTHER LIABILITY, WHETHER IN AN ACTION OF CONTRACT, TORT OR OTHERWISE, ARISING FROM, OUT OF OR IN CONNECTION WITH THE SOFTWARE OR THE USE OR OTHER DEALINGS IN THE SOFTWARE.

Except as contained in this notice, the name of The Open Group shall not be used in advertising or otherwise to promote the sale, use or other dealings in this Software without prior written authorization from The Open Group. 3.2. Berkeley-based copyrights:

o

3.2.1. General

Redistribution and use in source and binary forms, with or without modification, are permitted provided that the following conditions are met:

1. Redistributions of source code must retain the above copyright notice, this list of conditions and the following disclaimer.
2. Redistributions in binary form must reproduce the above copyright notice, this list of conditions and the following disclaimer in the documentation and/or other materials provided with the distribution.
3. The name of the author may not be used to endorse or promote products derived from this software without specific prior written permission.

THIS SOFTWARE IS PROVIDED BY THE AUTHOR "AS IS" AND ANY EXPRESS OR IMPLIED

WARRANTIES, INCLUDING, BUT NOT LIMITED TO, THE IMPLIED WARRANTIES OF MERCHANTABILITY AND FITNESS FOR A PARTICULAR PURPOSE ARE DISCLAIMED. IN NO EVENT SHALL THE AUTHOR BE LIABLE FOR ANY DIRECT, INDIRECT, INCIDENTAL, SPECIAL, EXEMPLARY, OR CONSEQUENTIAL DAMAGES (INCLUDING, BUT NOT LIMITED TO, PROCUREMENT OF SUBSTITUTE GOODS OR SERVICES; LOSS OF USE, DATA, OR PROFITS; OR BUSINESS INTERRUPTION) HOWEVER CAUSED AND ON ANY THEORY OF LIABILITY, WHETHER IN CONTRACT, STRICT LIABILITY, OR TORT (INCLUDING NEGLIGENCE OR OTHERWISE) ARISING IN ANY WAY OUT OF THE USE OF THIS SOFTWARE, EVEN IF ADVISED OF THE POSSIBILITY OF SUCH DAMAGE. 3.2.2. UCB/LBL

Copyright (c) 1993 The Regents of the University of California. All rights reserved.

This software was developed by the Computer Systems Engineering group at Lawrence Berkeley Laboratory under DARPA contract BG 91-66 and contributed to Berkeley.

All advertising materials mentioning features or use of this software must display the following acknowledgement: This product includes software developed by the University of California, Lawrence Berkeley Laboratory.

Redistribution and use in source and binary forms, with or without modification, are permitted provided that the following conditions are met:

1. Redistributions of source code must retain the above copyright notice, this list of conditions and the following disclaimer.
2. Redistributions in binary form must reproduce the above copyright

notice, this list of conditions and the following disclaimer in the documentation and/or other materials provided with the distribution.

3. All advertising materials mentioning features or use of this software must display the following acknowledgement: This product includes software developed by the University of California, Berkeley and its contributors.

4. Neither the name of the University nor the names of its contributors may be used to endorse or promote products derived from this software without specific prior written permission.

THIS SOFTWARE IS PROVIDED BY THE REGENTS AND CONTRIBUTORS "AS IS" AND ANY EXPRESS OR IMPLIED WARRANTIES, INCLUDING, BUT NOT LIMITED TO, THE IMPLIED WARRANTIES OF MERCHANTABILITY AND FITNESS FOR A PARTICULAR PURPOSE ARE DISCLAIMED. IN NO EVENT SHALL THE REGENTS OR CONTRIBUTORS BE LIABLE FOR ANY DIRECT, INDIRECT, INCIDENTAL, SPECIAL, EXEMPLARY, OR CONSEQUENTIAL DAMAGES (INCLUDING, BUT NOT LIMITED TO, PROCUREMENT OF SUBSTITUTE GOODS OR SERVICES; LOSS OF USE, DATA, OR PROFITS; OR BUSINESS INTERRUPTION) HOWEVER CAUSED AND ON ANY THEORY OF LIABILITY, WHETHER IN CONTRACT, STRICT LIABILITY, OR TORT (INCLUDING NEGLIGENCE OR OTHERWISE) ARISING IN ANY WAY OUT OF THE USE OF THIS SOFTWARE, EVEN IF ADVISED OF THE POSSIBILITY OF SUCH DAMAGE. 3.2.3.

The
NetBSD Foundation, Inc.

Copyright (c) 2003 The NetBSD Foundation, Inc. All rights reserved.

This code is derived from software contributed to The NetBSD Foundation by Ben

Collver <collver1@attbi.com>

Redistribution and use in source and binary forms, with or without modification, are permitted provided that the following conditions are met:

1. Redistributions of source code must retain the above copyright notice, this list of conditions and the following disclaimer.
2. Redistributions in binary form must reproduce the above copyright notice, this list of conditions and the following disclaimer in the documentation and/or other materials provided with the distribution.
3. All advertising materials mentioning features or use of this software must display the following acknowledgement: This product includes software developed by the NetBSD Foundation, Inc. and its contributors.
4. Neither the name of The NetBSD Foundation nor the names of its contributors may be used to endorse or promote products derived from this software without specific prior written permission.

THIS SOFTWARE IS PROVIDED BY THE NETBSD FOUNDATION, INC. AND CONTRIBUTORS ``AS IS'' AND ANY EXPRESS OR IMPLIED WARRANTIES, INCLUDING, BUT NOT LIMITED TO, THE IMPLIED WARRANTIES OF MERCHANTABILITY AND FITNESS FOR A PARTICULAR PURPOSE ARE DISCLAIMED. IN NO EVENT SHALL THE FOUNDATION OR CONTRIBUTORS BE LIABLE FOR ANY DIRECT, INDIRECT, INCIDENTAL, SPECIAL, EXEMPLARY, OR CONSEQUENTIAL DAMAGES (INCLUDING, BUT NOT LIMITED TO, PROCUREMENT OF SUBSTITUTE GOODS OR SERVICES; LOSS OF USE, DATA, OR PROFITS; OR BUSINESS INTERRUPTION) HOWEVER CAUSED AND ON ANY THEORY OF LIABILITY, WHETHER IN CONTRACT, STRICT LIABILITY, OR TORT

(INCLUDING NEGLIGENCE OR OTHERWISE) ARISING IN ANY WAY OUT OF THE USE OF THIS

SOFTWARE, EVEN IF ADVISED OF THE POSSIBILITY OF SUCH DAMAGE. 3.2.4.

Theodore

Ts'o.

Copyright Theodore Ts'o, 1994, 1995, 1996, 1997, 1998, 1999. All rights reserved.

Redistribution and use in source and binary forms, with or without modification, are permitted provided that the following conditions are met:

1. Redistributions of source code must retain the above copyright notice, and the entire permission notice in its entirety, including the disclaimer of warranties.
2. Redistributions in binary form must reproduce the above copyright notice, this list of conditions and the following disclaimer in the documentation and/or other materials provided with the distribution.
3. The name of the author may not be used to endorse or promote products derived from this software without specific prior written permission.

THIS SOFTWARE IS PROVIDED "AS IS" AND ANY EXPRESS OR IMPLIED WARRANTIES,

INCLUDING, BUT NOT LIMITED TO, THE IMPLIED WARRANTIES OF MERCHANTABILITY AND

FITNESS FOR A PARTICULAR PURPOSE, ALL OF WHICH ARE HEREBY DISCLAIMED. IN NO

EVENT SHALL THE AUTHOR BE LIABLE FOR ANY DIRECT, INDIRECT, INCIDENTAL,

SPECIAL, EXEMPLARY, OR CONSEQUENTIAL DAMAGES (INCLUDING, BUT NOT LIMITED TO,

PROCUREMENT OF SUBSTITUTE GOODS OR SERVICES; LOSS OF USE, DATA, OR PROFITS; OR

BUSINESS INTERRUPTION) HOWEVER CAUSED AND ON ANY THEORY OF

LIABILITY, WHETHER
IN CONTRACT, STRICT LIABILITY, OR TORT (INCLUDING NEGLIGENCE OR
OTHERWISE)
ARISING IN ANY WAY OUT OF THE USE OF THIS SOFTWARE, EVEN IF NOT
ADVISED OF THE
POSSIBILITY OF SUCH DAMAGE. 3.2.5. Theo de Raadt and Damien Miller

Copyright (c) 1995,1999 Theo de Raadt. All rights reserved. Copyright (c)
2001-2002 Damien Miller. All rights reserved.

Redistribution and use in source and binary forms, with or without
modification, are permitted provided that the following conditions are met:

1. Redistributions of source code must retain the above copyright notice,
this list of conditions and the following disclaimer.
2. Redistributions in binary form must reproduce the above copyright
notice, this list of conditions and the following disclaimer in the
documentation and/or other materials provided with the distribution.

THIS SOFTWARE IS PROVIDED BY THE AUTHOR ``AS IS" AND ANY EXPRESS OR
IMPLIED
WARRANTIES, INCLUDING, BUT NOT LIMITED TO, THE IMPLIED WARRANTIES
OF
MERCHANTABILITY AND FITNESS FOR A PARTICULAR PURPOSE ARE
DISCLAIMED. IN NO
EVENT SHALL THE AUTHOR BE LIABLE FOR ANY DIRECT, INDIRECT,
INCIDENTAL,
SPECIAL, EXEMPLARY, OR CONSEQUENTIAL DAMAGES (INCLUDING, BUT
NOT LIMITED TO,
PROCUREMENT OF SUBSTITUTE GOODS OR SERVICES; LOSS OF USE, DATA,
OR PROFITS; OR
BUSINESS INTERRUPTION) HOWEVER CAUSED AND ON ANY THEORY OF
LIABILITY, WHETHER
IN CONTRACT, STRICT LIABILITY, OR TORT (INCLUDING NEGLIGENCE OR
OTHERWISE)

ARISING IN ANY WAY OUT OF THE USE OF THIS SOFTWARE, EVEN IF ADVISED OF THE POSSIBILITY OF SUCH DAMAGE. 3.2.6. Todd C. Miller

Copyright (c) 1998 Todd C. Miller <Todd.Miller@courtesan.com>

Permission to use, copy, modify, and distribute this software for any purpose with or without fee is hereby granted, provided that the above copyright notice and this permission notice appear in all copies.

THE SOFTWARE IS PROVIDED "AS IS" AND TODD C. MILLER DISCLAIMS ALL WARRANTIES WITH REGARD TO THIS SOFTWARE INCLUDING ALL IMPLIED WARRANTIES OF MERCHANTABILITY AND FITNESS. IN NO EVENT SHALL TODD C. MILLER BE LIABLE FOR ANY SPECIAL, DIRECT, INDIRECT, OR CONSEQUENTIAL DAMAGES OR ANY DAMAGES WHATSOEVER RESULTING FROM LOSS OF USE, DATA OR PROFITS, WHETHER IN AN ACTION OF CONTRACT, NEGLIGENCE OR OTHER TORTIOUS ACTION, ARISING OUT OF OR IN CONNECTION WITH THE USE OR PERFORMANCE OF THIS SOFTWARE. 3.2.7. Thomas Winischhofer

Copyright (C) 2001-2004 Thomas Winischhofer

Redistribution and use in source and binary forms, with or without modification, are permitted provided that the following conditions are met:

1. Redistributions of source code must retain the above copyright notice, this list of conditions and the following disclaimer.
2. Redistributions in binary form must reproduce the above copyright notice, this list of conditions and the following disclaimer in the

documentation and/or other materials provided with the distribution.

3. The name of the author may not be used to endorse or promote products derived from this software without specific prior written permission.

THIS SOFTWARE IS PROVIDED BY THE AUTHOR ``AS IS" AND ANY EXPRESSED OR IMPLIED WARRANTIES, INCLUDING, BUT NOT LIMITED TO, THE IMPLIED WARRANTIES OF MERCHANTABILITY AND FITNESS FOR A PARTICULAR PURPOSE ARE DISCLAIMED. IN NO EVENT SHALL THE AUTHOR BE LIABLE FOR ANY DIRECT, INDIRECT, INCIDENTAL, SPECIAL, EXEMPLARY, OR CONSEQUENTIAL DAMAGES (INCLUDING, BUT NOT LIMITED TO, PROCUREMENT OF SUBSTITUTE GOODS OR SERVICES; LOSS OF USE, DATA, OR PROFITS; OR BUSINESS INTERRUPTION) HOWEVER CAUSED AND ON ANY THEORY OF LIABILITY, WHETHER IN CONTRACT, STRICT LIABILITY, OR TORT (INCLUDING NEGLIGENCE OR OTHERWISE) ARISING IN ANY WAY OUT OF THE USE OF THIS SOFTWARE, EVEN IF ADVISED OF THE POSSIBILITY OF SUCH DAMAGE. 3.3. NVIDIA Corp

Copyright (c) 1996 NVIDIA, Corp. All rights reserved.

NOTICE TO USER: The source code is copyrighted under U.S. and international laws. NVIDIA, Corp. of Sunnyvale, California owns the copyright and as design patents pending on the design and interface of the NV chips. Users and possessors of this source code are hereby granted a nonexclusive, royalty-free copyright and design patent license to use this code in individual and commercial software.

Any use of this source code must include, in the user documentation and internal comments to the code, notices to the end user as follows:

Copyright (c) 1996 NVIDIA, Corp. NVIDIA design patents pending in the U.S. and foreign countries.

NVIDIA, CORP. MAKES NO REPRESENTATION ABOUT THE SUITABILITY OF THIS SOURCE CODE FOR ANY PURPOSE. IT IS PROVIDED "AS IS" WITHOUT EXPRESS OR IMPLIED WARRANTY OF ANY KIND. NVIDIA, CORP. DISCLAIMS ALL WARRANTIES WITH REGARD TO THIS SOURCE CODE, INCLUDING ALL IMPLIED WARRANTIES OF MERCHANTABILITY AND FITNESS FOR A PARTICULAR PURPOSE. IN NO EVENT SHALL NVIDIA, CORP. BE LIABLE FOR ANY SPECIAL, INDIRECT, INCIDENTAL, OR CONSEQUENTIAL DAMAGES, OR ANY DAMAGES WHATSOEVER RESULTING FROM LOSS OF USE, DATA OR PROFITS, WHETHER IN AN ACTION OF CONTRACT, NEGLIGENCE OR OTHER TORTIOUS ACTION, ARISING OUT OF OR IN CONNECTION WITH THE USE OR PERFORMANCE OF THIS SOURCE CODE.

3.4. GLX Public

License

GLX PUBLIC LICENSE (Version 1.0 (2/11/99)) ("License")

Subject to any third party claims, Silicon Graphics, Inc. ("SGI") hereby grants permission to Recipient (defined below), under Recipient's copyrights in the Original Software (defined below), to use, copy, modify, merge, publish, distribute, sublicense and/or sell copies of Subject Software (defined below), and to permit persons to whom the Subject Software is furnished in accordance with this License to do the same, subject to all of the following terms and conditions, which Recipient accepts by engaging in any such use, copying, modifying, merging, publishing, distributing, sublicensing or selling:

1. Definitions.

(a) "Original Software" means source code of computer software code which is described in Exhibit A as Original Software.

(b) "Modifications" means any addition to or deletion from the substance or structure of either the Original Software or any previous Modifications. When Subject Software is released as a series of files, a Modification means (i) any addition to or deletion from the contents of a file containing Original Software or previous Modifications and (ii) any new file that contains any part of the Original Code or previous Modifications.

(c) "Subject Software" means the Original Software or Modifications or the combination of the Original Software and Modifications, or portions of any of the foregoing.

(d) "Recipient" means an individual or a legal entity exercising rights under, and complying with all of the terms of, this License. For legal entities, "Recipient" includes any entity which controls, is controlled by, or is under common control with Recipient. For purposes of this definition, "control" of an entity means (a) the power, direct or indirect, to direct or manage such entity, or (b) ownership of fifty percent (50%) or more of the outstanding shares or beneficial ownership of such entity.

2. Redistribution of Source Code Subject to These Terms. Redistributions of Subject Software in source code form must retain the notice set forth in Exhibit A, below, in every file. A copy of this License must be included in any documentation for such Subject Software where the recipients' rights relating to Subject Software are described. Recipient may distribute the source code version of Subject Software under a license of Recipient's choice, which may contain terms different from this License, provided that (i) Recipient is in compliance with the terms of this License, and (ii) the license terms include this Section 2 and Sections 3, 4, 7, 8, 10, 12 and 13 of this License, which terms may not be modified or superseded by any other terms

of such license. If Recipient distributes the source code version under a different license Recipient must make it absolutely clear that any terms which differ from this License are offered by Recipient alone, not by SGI. Recipient hereby agrees to indemnify SGI for any liability incurred by SGI as a result of any such terms Recipient offers.

3. Redistribution in Executable Form. The notice set forth in Exhibit A must be conspicuously included in any notice in an executable version of Subject Software, related documentation or collateral in which Recipient describes the user's rights relating to the Subject Software. Recipient may distribute the executable version of Subject Software under a license of Recipient's choice, which may contain terms different from this License, provided that (i) Recipient is in compliance with the terms of this License, and (ii) the license terms include this Section 3 and Sections 4, 7, 8, 10, 12 and 13 of this License, which terms may not be modified or superseded by any other terms of such license. If Recipient distributes the executable version under a different license Recipient must make it absolutely clear that any terms which differ from this License are offered by Recipient alone, not by SGI. Recipient hereby agrees to indemnify SGI for any liability incurred by SGI as a result of any such terms Recipient offers.

4. Termination. This License and the rights granted hereunder will terminate automatically if Recipient fails to comply with terms herein and fails to cure such breach within 30 days of the breach. Any sublicense to the Subject Software which is properly granted shall survive any termination of this License absent termination by the terms of such sublicense. Provisions which, by their nature, must remain in effect beyond the termination of this License shall survive.

5. No Trademark Rights. This License does not grant any rights to use any trade name, trademark or service mark whatsoever. No trade name, trademark or service mark of SGI may be used to endorse or promote products derived from the Subject Software without prior written permission of SGI.

6. No Other Rights. This License does not grant any rights with respect to the OpenGL API or to any software or hardware implementation thereof or to any

other software whatsoever, nor shall any other rights or licenses not expressly granted hereunder arise by implication, estoppel or otherwise with respect to the Subject Software. Title to and ownership of the Original Software at all times remains with SGI. All rights in the Original Software not expressly granted under this License are reserved.

7. Compliance with Laws; Non-Infringement. Recipient shall comply with all applicable laws and regulations in connection with use and distribution of the Subject Software, including but not limited to, all export and import control laws and regulations of the U.S. government and other countries. Recipient may not distribute Subject Software that (i) in any way infringes (directly or contributorily) the rights (including patent, copyright, trade secret, trademark or other intellectual property rights of any kind) of any other person or entity or (ii) breaches any representation or warranty, express, implied or statutory, which under any applicable law it might be deemed to have been distributed.

8. Claims of Infringement. If Recipient at any time has knowledge of any one or more third party claims that reproduction, modification, use, distribution, import or sale of Subject Software (including particular functionality or code incorporated in Subject Software) infringes the third party's intellectual property rights, Recipient must place in a well-identified web page bearing the title "LEGAL" a description of each such claim and a description of the party making each such claim in sufficient detail that a user of the Subject Software will know whom to contact regarding the claim. Also, upon gaining such knowledge of any such claim, Recipient must conspicuously include the URL for such web page in the Exhibit A notice required under Sections 2 and 3, above, and in the text of any related documentation, license agreement or collateral in which Recipient describes end user's rights relating to the Subject Software. If Recipient obtains such knowledge after it makes Subject Software available to any other person or entity, Recipient shall take other steps (such as notifying appropriate mailing lists or newsgroups) reasonably calculated to inform those who received the Subject Software that new knowledge has been obtained.

9. DISCLAIMER OF WARRANTY. SUBJECT SOFTWARE IS PROVIDED ON AN "AS

IS" BASIS,
WITHOUT WARRANTY OF ANY KIND, EITHER EXPRESSED OR IMPLIED,
INCLUDING, WITHOUT
LIMITATION, WARRANTIES THAT THE SUBJECT SOFTWARE IS FREE OF
DEFECTS,
MERCHANTABLE, FIT FOR A PARTICULAR PURPOSE OR NON- INFRINGING.
SGI ASSUMES NO
RISK AS TO THE QUALITY AND PERFORMANCE OF THE SOFTWARE. SHOULD
ANY SOFTWARE
PROVE DEFECTIVE IN ANY RESPECT, SGI ASSUMES NO COST OR LIABILITY
FOR ANY
SERVICING, REPAIR OR CORRECTION. THIS DISCLAIMER OF WARRANTY
CONSTITUTES AN
ESSENTIAL PART OF THIS LICENSE. NO USE OF ANY SUBJECT SOFTWARE IS
AUTHORIZED
HEREUNDER EXCEPT UNDER THIS DISCLAIMER.

10. LIMITATION OF LIABILITY. UNDER NO CIRCUMSTANCES AND UNDER NO
LEGAL THEORY,
WHETHER TORT (INCLUDING, WITHOUT LIMITATION, NEGLIGENCE OR
STRICT LIABILITY),
CONTRACT, OR OTHERWISE, SHALL SGI OR ANY SGI LICENSOR BE LIABLE
FOR ANY
DIRECT, INDIRECT, SPECIAL, INCIDENTAL, OR CONSEQUENTIAL DAMAGES
OF ANY
CHARACTER INCLUDING, WITHOUT LIMITATION, DAMAGES FOR LOSS OF
GOODWILL, WORK
STOPPAGE, LOSS OF DATA, COMPUTER FAILURE OR MALFUNCTION, OR ANY
AND ALL OTHER
COMMERCIAL DAMAGES OR LOSSES, EVEN IF SUCH PARTY SHALL HAVE
BEEN INFORMED OF
THE POSSIBILITY OF SUCH DAMAGES. THIS LIMITATION OF LIABILITY SHALL
NOT APPLY
TO LIABILITY FOR DEATH OR PERSONAL INJURY RESULTING FROM SGI's
NEGLIGENCE TO
THE EXTENT APPLICABLE LAW PROHIBITS SUCH LIMITATION. SOME

JURISDICTIONS DO NOT
ALLOW THE EXCLUSION OR LIMITATION OF INCIDENTAL OR
CONSEQUENTIAL DAMAGES, SO
THAT EXCLUSION AND LIMITATION MAY NOT APPLY TO RECIPIENT.

11. Indemnity. Recipient shall be solely responsible for damages arising, directly or indirectly, out of its utilization of rights under this License. Recipient will defend, indemnify and hold harmless Silicon Graphics, Inc. from and against any loss, liability, damages, costs or expenses (including the payment of reasonable attorneys fees) arising out of Recipient's use, modification, reproduction and distribution of the Subject Software or out of any representation or warranty made by Recipient.

12. U.S. Government End Users. The Subject Software is a "commercial item" consisting of "commercial computer software" as such terms are defined in title 48 of the Code of Federal Regulations and all U.S. Government End Users acquire only the rights set forth in this License and are subject to the terms of this License.

13. Miscellaneous. This License represents the complete agreement concerning subject matter hereof. If any provision of this License is held to be unenforceable, such provision shall be reformed so as to achieve as nearly as possible the same economic effect as the original provision and the remainder of this License will remain in effect. This License shall be governed by and construed in accordance with the laws of the United States and the State of California as applied to agreements entered into and to be performed entirely within California between California residents. Any litigation relating to this License shall be subject to the exclusive jurisdiction of the Federal Courts of the Northern District of California (or, absent subject matter jurisdiction in such courts, the courts of the State of California), with venue lying exclusively in Santa Clara County, California, with the losing party responsible for costs, including without limitation, court costs and reasonable attorneys fees and expenses. The application of the United Nations Convention on Contracts for the International Sale of Goods is expressly excluded. Any law or regulation which provides that the language of a contract shall be construed against the drafter shall not apply to this License.

Exhibit A

The contents of this file are subject to Sections 2, 3, 4, 7, 8, 10, 12 and 13 of the GLX Public License Version 1.0 (the "License"). You may not use this file except in compliance with those sections of the License. You may obtain a copy of the License at Silicon Graphics, Inc., attn: Legal Services, 2011 N. Shoreline Blvd., Mountain View, CA 94043 or at <http://www.sgi.com/software/opensource/glx/license.html>.

Software distributed under the License is distributed on an "AS IS" basis. ALL WARRANTIES ARE DISCLAIMED, INCLUDING, WITHOUT LIMITATION, ANY IMPLIED WARRANTIES OF MERCHANTABILITY, OF FITNESS FOR A PARTICULAR PURPOSE OR OF NON-INFRINGEMENT. See the License for the specific language governing rights and limitations under the License.

The Original Software is GLX version 1.2 source code, released February, 1999. The developer of the Original Software is Silicon Graphics, Inc. Those portions of the Subject Software created by Silicon Graphics, Inc. are Copyright (c) 1991-9 Silicon Graphics, Inc. All Rights Reserved. 3.5. CID Font Code Public License

CID FONT CODE PUBLIC LICENSE (Version 1.0 (3/31/99))("License")

Subject to any applicable third party claims, Silicon Graphics, Inc. ("SGI") hereby grants permission to Recipient (defined below), under SGI's copyrights in the Original Software (defined below), to use, copy, modify, merge, publish, distribute, sublicense and/or sell copies of Subject Software (defined below) in both source code and executable form, and to permit persons to whom the Subject Software is furnished in accordance with this License to do the same, subject to all of the following terms and conditions, which Recipient accepts by engaging in any such use, copying, modifying, merging, publication, distributing, sublicensing or selling:

1. Definitions.

a. "Original Software" means source code of computer software code that is described in Exhibit A as Original Software.

b. "Modifications" means any addition to or deletion from the substance or structure of either the Original Software or any previous Modifications. When Subject Software is released as a series of files, a Modification means (i) any addition to or deletion from the contents of a file containing Original Software or previous Modifications and (ii) any new file that contains any part of the Original Code or previous Modifications.

c. "Subject Software" means the Original Software or Modifications or the combination of the Original Software and Modifications, or portions of any of the foregoing.

d. "Recipient" means an individual or a legal entity exercising rights under the terms of this License. For legal entities, "Recipient" includes any entity that controls, is controlled by, or is under common control with Recipient. For purposes of this definition, "control" of an entity means (i) the power, direct or indirect, to direct or manage such entity, or (ii) ownership of fifty percent (50%) or more of the outstanding shares or beneficial ownership of such entity.

e. "Required Notice" means the notice set forth in Exhibit A to this License.

f. "Accompanying Technology" means any software or other technology that is not a Modification and that is distributed or made publicly available by Recipient with the Subject Software. Separate software files that do not contain any Original Software or any previous Modification shall not be deemed a Modification, even if such software files are aggregated as part of a product, or in any medium of storage, with any file that does contain Original Software or any previous Modification.

2. License Terms. All distribution of the Subject Software must be made subject to the terms of this License. A copy of this License and the Required Notice must be included in any documentation for Subject Software where Recipient's rights relating to Subject Software and/or any Accompanying Technology are described. Distributions of Subject Software in source code form must also include the Required Notice in every file distributed. In addition, a ReadMe file entitled "Important Legal Notice" must be distributed with each distribution of one or more files that incorporate Subject Software. That file must be included with distributions made in both source code and executable form. A copy of the License and the Required Notice must be included in that file. Recipient may distribute Accompanying Technology under a license of Recipient's choice, which may contain terms different from this License, provided that (i) Recipient is in compliance with the terms of this License, (ii) such other license terms do not modify or supersede the terms of this License as applicable to the Subject Software, (iii) Recipient hereby indemnifies SGI for any liability incurred by SGI as a result of the distribution of Accompanying Technology or the use of other license terms.

3. Termination. This License and the rights granted hereunder will terminate automatically if Recipient fails to comply with terms herein and fails to cure such breach within 30 days of the breach. Any sublicense to the Subject Software that is properly granted shall survive any termination of this License absent termination by the terms of such sublicense. Provisions which, by their nature, must remain in effect beyond the termination of this License shall survive.

4. Trademark Rights. This License does not grant any rights to use any trade name, trademark or service mark whatsoever. No trade name, trademark or service mark of SGI may be used to endorse or promote products derived from or incorporating any Subject Software without prior written permission of SGI.

5. No Other Rights. No rights or licenses not expressly granted hereunder shall arise by implication, estoppel or otherwise. Title to and ownership of the Original Software at all times remains with SGI. All rights in the Original Software not expressly granted under this License are reserved.

6. Compliance with Laws; Non-Infringement. Recipient shall comply with all applicable laws and regulations in connection with use and distribution of the Subject Software, including but not limited to, all export and import control laws and regulations of the U.S. government and other countries. Recipient may not distribute Subject Software that (i) in any way infringes (directly or contributorily) the rights (including patent, copyright, trade secret, trademark or other intellectual property rights of any kind) of any other person or entity, or (ii) breaches any representation or warranty, express, implied or statutory, which under any applicable law it might be deemed to have been distributed.

7. Claims of Infringement. If Recipient at any time has knowledge of any one or more third party claims that reproduction, modification, use, distribution, import or sale of Subject Software (including particular functionality or code incorporated in Subject Software) infringes the third party's intellectual property rights, Recipient must place in a well-identified web page bearing the title "LEGAL" a description of each such claim and a description of the party making each such claim in sufficient detail that a user of the Subject Software will know whom to contact regarding the claim. Also, upon gaining such knowledge of any such claim, Recipient must conspicuously include the URL for such web page in the Required Notice, and in the text of any related documentation, license agreement or collateral in which Recipient describes end user's rights relating to the Subject Software. If Recipient obtains such knowledge after it makes Subject Software available to any other person or entity, Recipient shall take other steps (such as notifying appropriate mailing lists or newsgroups) reasonably calculated to provide such knowledge to those who received the Subject Software.

8. DISCLAIMER OF WARRANTY. SUBJECT SOFTWARE IS PROVIDED ON AN "AS IS" BASIS, WITHOUT WARRANTY OF ANY KIND, EITHER EXPRESSED OR IMPLIED, INCLUDING, WITHOUT LIMITATION, WARRANTIES THAT THE SUBJECT SOFTWARE IS FREE OF DEFECTS, MERCHANTABILITY, FIT FOR A PARTICULAR PURPOSE OR NON-INFRINGEMENT. SGI ASSUMES NO

RISK AS TO THE QUALITY AND PERFORMANCE OF THE SOFTWARE. SHOULD ANY SOFTWARE PROVE DEFECTIVE IN ANY RESPECT, SGI ASSUMES NO COST OR LIABILITY FOR ANY SERVICING, REPAIR OR CORRECTION. THIS DISCLAIMER OF WARRANTY CONSTITUTES AN ESSENTIAL PART OF THIS LICENSE. NO USE OF ANY SUBJECT SOFTWARE IS AUTHORIZED HEREUNDER EXCEPT UNDER THIS DISCLAIMER.

9. LIMITATION OF LIABILITY. UNDER NO CIRCUMSTANCES AND UNDER NO LEGAL THEORY, WHETHER TORT (INCLUDING, WITHOUT LIMITATION, NEGLIGENCE OR STRICT LIABILITY), CONTRACT, OR OTHERWISE, SHALL SGI OR ANY SGI LICENSOR BE LIABLE FOR ANY CLAIM, DAMAGES OR OTHER LIABILITY, WHETHER IN AN ACTION OF CONTRACT, TORT OR OTHERWISE, ARISING FROM, OUT OF OR IN CONNECTION WITH THE SUBJECT SOFTWARE OR THE USE OR OTHER DEALINGS IN THE SUBJECT SOFTWARE. SOME JURISDICTIONS DO NOT ALLOW THE EXCLUSION OR LIMITATION OF CERTAIN DAMAGES, SO THIS EXCLUSION AND LIMITATION MAY NOT APPLY TO RECIPIENT TO THE EXTENT SO DISALLOWED.

10. Indemnity. Recipient shall be solely responsible for damages arising, directly or indirectly, out of its utilization of rights under this License. Recipient will defend, indemnify and hold SGI and its successors and assigns harmless from and against any loss, liability, damages, costs or expenses (including the payment of reasonable attorneys fees) arising out of (Recipient's use, modification, reproduction and distribution of the Subject Software or out of any representation or warranty made by Recipient.

11. U.S. Government End Users. The Subject Software is a "commercial item"

consisting of "commercial computer software" as such terms are defined in title 48 of the Code of Federal Regulations and all U.S. Government End Users acquire only the rights set forth in this License and are subject to the terms of this License.

12. Miscellaneous. This License represents the complete agreement concerning subject matter hereof. If any provision of this License is held to be unenforceable by any judicial or administrative authority having proper jurisdiction with respect thereto, such provision shall be reformed so as to achieve as nearly as possible the same economic effect as the original provision and the remainder of this License will remain in effect. This License shall be governed by and construed in accordance with the laws of the United States and the State of California as applied to agreements entered into and to be performed entirely within California between California residents. Any litigation relating to this License shall be subject to the exclusive jurisdiction of the Federal Courts of the Northern District of California (or, absent subject matter jurisdiction in such courts, the courts of the State of California), with venue lying exclusively in Santa Clara County, California, with the losing party responsible for costs, including without limitation, court costs and reasonable attorneys fees and expenses. The application of the United Nations Convention on Contracts for the International Sale of Goods is expressly excluded. Any law or regulation that provides that the language of a contract shall be construed against the drafter shall not apply to this License.

Exhibit A

Copyright (c) 1994-1999 Silicon Graphics, Inc.

The contents of this file are subject to the CID Font Code Public License Version 1.0 (the "License"). You may not use this file except in compliance with the License. You may obtain a copy of the License at Silicon Graphics, Inc., attn: Legal Services, 2011 N. Shoreline Blvd., Mountain View, CA 94043 or at <http://www.sgi.com/software/opensource/cid/license.html>

Software distributed under the License is distributed on an "AS IS" basis. ALL

WARRANTIES ARE DISCLAIMED, INCLUDING, WITHOUT LIMITATION, ANY IMPLIED

WARRANTIES OF MERCHANTABILITY, OF FITNESS FOR A PARTICULAR PURPOSE OR OF

NON-INFRINGEMENT. See the License for the specific language governing rights and limitations under the License.

The Original Software (as defined in the License) is CID font code that was developed by Silicon Graphics, Inc. Those portions of the Subject Software (as defined in the License) that were created by Silicon Graphics, Inc. are Copyright (c) 1994-1999 Silicon Graphics, Inc. All Rights Reserved.

[NOTE: When using this text in connection with Subject Software delivered solely in object code form, Recipient may replace the words "this file" with "this software" in both the first and second sentences.] 3.6. Bitstream Vera Fonts Copyright

The fonts have a generous copyright, allowing derivative works (as long as "Bitstream" or "Vera" are not in the names), and full redistribution (so long as they are not *sold* by themselves). They can be bundled, redistributed and sold with any software.

The fonts are distributed under the following copyright:

Copyright (c) 2003 by Bitstream, Inc. All Rights Reserved. Bitstream Vera is a trademark of Bitstream, Inc.

Permission is hereby granted, free of charge, to any person obtaining a copy of the fonts accompanying this license ("Fonts") and associated documentation files (the "Font Software"), to reproduce and distribute the Font Software, including without limitation the rights to use, copy, merge, publish, distribute, and/or sell copies of the Font Software, and to permit persons to whom the Font Software is furnished to do so, subject to the following conditions:

The above copyright and trademark notices and this permission notice shall be

included in all copies of one or more of the Font Software typefaces.

The Font Software may be modified, altered, or added to, and in particular the designs of glyphs or characters in the Fonts may be modified and additional glyphs or characters may be added to the Fonts, only if the fonts are renamed to names not containing either the words "Bitstream" or the word "Vera".

This License becomes null and void to the extent applicable to Fonts or Font Software that has been modified and is distributed under the "Bitstream Vera" names.

The Font Software may be sold as part of a larger software package but no copy of one or more of the Font Software typefaces may be sold by itself.

THE FONT SOFTWARE IS PROVIDED "AS IS", WITHOUT WARRANTY OF ANY KIND, EXPRESS OR IMPLIED, INCLUDING BUT NOT LIMITED TO ANY WARRANTIES OF MERCHANTABILITY, FITNESS FOR A PARTICULAR PURPOSE AND NONINFRINGEMENT OF COPYRIGHT, PATENT, TRADEMARK, OR OTHER RIGHT. IN NO EVENT SHALL BITSTREAM OR THE GNOME FOUNDATION BE LIABLE FOR ANY CLAIM, DAMAGES OR OTHER LIABILITY, INCLUDING ANY GENERAL, SPECIAL, INDIRECT, INCIDENTAL, OR CONSEQUENTIAL DAMAGES, WHETHER IN AN ACTION OF CONTRACT, TORT OR OTHERWISE, ARISING FROM, OUT OF THE USE OR INABILITY TO USE THE FONT SOFTWARE OR FROM OTHER DEALINGS IN THE FONT SOFTWARE.

Except as contained in this notice, the names of Gnome, the Gnome Foundation, and Bitstream Inc., shall not be used in advertising or otherwise to promote the sale, use or other dealings in this Font Software without prior written authorization from the Gnome Foundation or Bitstream Inc., respectively. For further information, contact: fonts at gnome dot org. 3.7. Bigelow & Holmes

Inc and URW++ GmbH Luxi font license

Luxi fonts copyright (c) 2001 by Bigelow & Holmes Inc. Luxi font instruction code copyright (c) 2001 by URW++ GmbH. All Rights Reserved. Luxi is a registered trademark of Bigelow & Holmes Inc.

Permission is hereby granted, free of charge, to any person obtaining a copy of these Fonts and associated documentation files (the "Font Software"), to deal in the Font Software, including without limitation the rights to use, copy, merge, publish, distribute, sublicense, and/or sell copies of the Font Software, and to permit persons to whom the Font Software is furnished to do so, subject to the following conditions:

The above copyright and trademark notices and this permission notice shall be included in all copies of one or more of the Font Software.

The Font Software may not be modified, altered, or added to, and in particular the designs of glyphs or characters in the Fonts may not be modified nor may additional glyphs or characters be added to the Fonts. This License becomes null and void when the Fonts or Font Software have been modified.

THE FONT SOFTWARE IS PROVIDED "AS IS", WITHOUT WARRANTY OF ANY KIND, EXPRESS OR IMPLIED, INCLUDING BUT NOT LIMITED TO ANY WARRANTIES OF MERCHANTABILITY, FITNESS FOR A PARTICULAR PURPOSE AND NONINFRINGEMENT OF COPYRIGHT, PATENT, TRADEMARK, OR OTHER RIGHT. IN NO EVENT SHALL BIGELOW & HOLMES INC. OR URW++ GMBH. BE LIABLE FOR ANY CLAIM, DAMAGES OR OTHER LIABILITY, INCLUDING ANY GENERAL, SPECIAL, INDIRECT, INCIDENTAL, OR CONSEQUENTIAL DAMAGES, WHETHER IN AN ACTION OF CONTRACT, TORT OR OTHERWISE, ARISING FROM, OUT OF THE USE OR INABILITY TO USE THE FONT SOFTWARE OR FROM OTHER DEALINGS IN THE

FONT
SOFTWARE.

Except as contained in this notice, the names of Bigelow & Holmes Inc. and URW++ GmbH. shall not be used in advertising or otherwise to promote the sale, use or other dealings in this Font Software without prior written authorization from Bigelow & Holmes Inc. and URW++ GmbH.

For further information, contact:

info@urwpp.de or design@bigelowandholmes.com

--- end of LICENSE ---

%% This notice is provided with respect to zlib v1.2.5, which may be included with JRE 8, JDK 8, and OpenJDK 8.

--- begin of LICENSE ---

version 1.2.5, July 18th, 2005

Copyright (C) 1995-2005 Jean-loup Gailly and Mark Adler

This software is provided 'as-is', without any express or implied warranty. In no event will the authors be held liable for any damages arising from the use of this software.

Permission is granted to anyone to use this software for any purpose, including commercial applications, and to alter it and redistribute it freely, subject to the following restrictions:

1. The origin of this software must not be misrepresented; you must not claim that you wrote the original software. If you use this software

in a product, an acknowledgment in the product documentation would be appreciated but is not required.

2. Altered source versions must be plainly marked as such, and must not be misrepresented as being the original software.
3. This notice may not be removed or altered from any source distribution.

Jean-loup Gailly
jloup@gzip.org

Mark Adler
madler@alumni.caltech.edu

--- end of LICENSE ---

%% This notice is provided with respect to the following which may be included with JRE 8, JDK 8, and OpenJDK 8, except where noted:

Apache Commons Math 2.2
Apache Derby 10.10.1.2 [included with JDK 8]
Apache Jakarta BCEL 5.2
Apache Jakarta Regexp 1.4
Apache Santuario XML Security for Java 1.5.4
Apache Xalan-Java 2.7.1
Apache Xerces Java 2.10.0
Apache XML Resolver 1.1
Dynalink 0.5

--- begin of LICENSE ---

Apache License
Version 2.0, January 2004
<http://www.apache.org/licenses/>

TERMS AND CONDITIONS FOR USE, REPRODUCTION, AND DISTRIBUTION

1. Definitions.

"License" shall mean the terms and conditions for use, reproduction, and distribution as defined by Sections 1 through 9 of this document.

"Licensor" shall mean the copyright owner or entity authorized by the copyright owner that is granting the License.

"Legal Entity" shall mean the union of the acting entity and all other entities that control, are controlled by, or are under common control with that entity. For the purposes of this definition, "control" means (i) the power, direct or indirect, to cause the direction or management of such entity, whether by contract or otherwise, or (ii) ownership of fifty percent (50%) or more of the outstanding shares, or (iii) beneficial ownership of such entity.

"You" (or "Your") shall mean an individual or Legal Entity exercising permissions granted by this License.

"Source" form shall mean the preferred form for making modifications, including but not limited to software source code, documentation source, and configuration files.

"Object" form shall mean any form resulting from mechanical transformation or translation of a Source form, including but not limited to compiled object code, generated documentation, and conversions to other media types.

"Work" shall mean the work of authorship, whether in Source or Object form, made available under the License, as indicated by a copyright notice that is included in or attached to the work (an example is provided in the Appendix below).

"Derivative Works" shall mean any work, whether in Source or Object form, that is based on (or derived from) the Work and for which the editorial revisions, annotations, elaborations, or other modifications represent, as a whole, an original work of authorship. For the purposes

of this License, Derivative Works shall not include works that remain separable from, or merely link (or bind by name) to the interfaces of, the Work and Derivative Works thereof.

"Contribution" shall mean any work of authorship, including the original version of the Work and any modifications or additions to that Work or Derivative Works thereof, that is intentionally submitted to Licensor for inclusion in the Work by the copyright owner or by an individual or Legal Entity authorized to submit on behalf of the copyright owner. For the purposes of this definition, "submitted" means any form of electronic, verbal, or written communication sent to the Licensor or its representatives, including but not limited to communication on electronic mailing lists, source code control systems, and issue tracking systems that are managed by, or on behalf of, the Licensor for the purpose of discussing and improving the Work, but excluding communication that is conspicuously marked or otherwise designated in writing by the copyright owner as "Not a Contribution."

"Contributor" shall mean Licensor and any individual or Legal Entity on behalf of whom a Contribution has been received by Licensor and subsequently incorporated within the Work.

2. Grant of Copyright License. Subject to the terms and conditions of this License, each Contributor hereby grants to You a perpetual, worldwide, non-exclusive, no-charge, royalty-free, irrevocable copyright license to reproduce, prepare Derivative Works of, publicly display, publicly perform, sublicense, and distribute the Work and such Derivative Works in Source or Object form.
3. Grant of Patent License. Subject to the terms and conditions of this License, each Contributor hereby grants to You a perpetual, worldwide, non-exclusive, no-charge, royalty-free, irrevocable (except as stated in this section) patent license to make, have made, use, offer to sell, sell, import, and otherwise transfer the Work, where such license applies only to those patent claims licensable by such Contributor that are necessarily infringed by their

Contribution(s) alone or by combination of their Contribution(s) with the Work to which such Contribution(s) was submitted. If You institute patent litigation against any entity (including a cross-claim or counterclaim in a lawsuit) alleging that the Work or a Contribution incorporated within the Work constitutes direct or contributory patent infringement, then any patent licenses granted to You under this License for that Work shall terminate as of the date such litigation is filed.

4. Redistribution. You may reproduce and distribute copies of the Work or Derivative Works thereof in any medium, with or without modifications, and in Source or Object form, provided that You meet the following conditions:
 - (a) You must give any other recipients of the Work or Derivative Works a copy of this License; and
 - (b) You must cause any modified files to carry prominent notices stating that You changed the files; and
 - (c) You must retain, in the Source form of any Derivative Works that You distribute, all copyright, patent, trademark, and attribution notices from the Source form of the Work, excluding those notices that do not pertain to any part of the Derivative Works; and
 - (d) If the Work includes a "NOTICE" text file as part of its distribution, then any Derivative Works that You distribute must include a readable copy of the attribution notices contained within such NOTICE file, excluding those notices that do not pertain to any part of the Derivative Works, in at least one of the following places: within a NOTICE text file distributed as part of the Derivative Works; within the Source form or documentation, if provided along with the Derivative Works; or, within a display generated by the Derivative Works, if and wherever such third-party notices normally appear. The contents

of the NOTICE file are for informational purposes only and do not modify the License. You may add Your own attribution notices within Derivative Works that You distribute, alongside or as an addendum to the NOTICE text from the Work, provided that such additional attribution notices cannot be construed as modifying the License.

You may add Your own copyright statement to Your modifications and may provide additional or different license terms and conditions for use, reproduction, or distribution of Your modifications, or for any such Derivative Works as a whole, provided Your use, reproduction, and distribution of the Work otherwise complies with the conditions stated in this License.

5. Submission of Contributions. Unless You explicitly state otherwise, any Contribution intentionally submitted for inclusion in the Work by You to the Licensor shall be under the terms and conditions of this License, without any additional terms or conditions.

Notwithstanding the above, nothing herein shall supersede or modify the terms of any separate license agreement you may have executed with Licensor regarding such Contributions.

6. Trademarks. This License does not grant permission to use the trade names, trademarks, service marks, or product names of the Licensor, except as required for reasonable and customary use in describing the origin of the Work and reproducing the content of the NOTICE file.

7. Disclaimer of Warranty. Unless required by applicable law or agreed to in writing, Licensor provides the Work (and each Contributor provides its Contributions) on an "AS IS" BASIS, WITHOUT WARRANTIES OR CONDITIONS OF ANY KIND, either express or implied, including, without limitation, any warranties or conditions of TITLE, NON-INFRINGEMENT, MERCHANTABILITY, or FITNESS FOR A PARTICULAR PURPOSE. You are solely responsible for determining the appropriateness of using or redistributing the Work and assume any risks associated with Your exercise of permissions under this License.

8. **Limitation of Liability.** In no event and under no legal theory, whether in tort (including negligence), contract, or otherwise, unless required by applicable law (such as deliberate and grossly negligent acts) or agreed to in writing, shall any Contributor be liable to You for damages, including any direct, indirect, special, incidental, or consequential damages of any character arising as a result of this License or out of the use or inability to use the Work (including but not limited to damages for loss of goodwill, work stoppage, computer failure or malfunction, or any and all other commercial damages or losses), even if such Contributor has been advised of the possibility of such damages.

9. **Accepting Warranty or Additional Liability.** While redistributing the Work or Derivative Works thereof, You may choose to offer, and charge a fee for, acceptance of support, warranty, indemnity, or other liability obligations and/or rights consistent with this License. However, in accepting such obligations, You may act only on Your own behalf and on Your sole responsibility, not on behalf of any other Contributor, and only if You agree to indemnify, defend, and hold each Contributor harmless for any liability incurred by, or claims asserted against, such Contributor by reason of your accepting any such warranty or additional liability.

END OF TERMS AND CONDITIONS

APPENDIX: How to apply the Apache License to your work.

To apply the Apache License to your work, attach the following boilerplate notice, with the fields enclosed by brackets "[]" replaced with your own identifying information. (Don't include the brackets!) The text should be enclosed in the appropriate comment syntax for the file format. We also recommend that a file or class name and description of purpose be included on the same "printed page" as the copyright notice for easier identification within third-party archives.

Copyright [yyyy] [name of copyright owner]

Licensed under the Apache License, Version 2.0 (the "License");
you may not use this file except in compliance with the License.
You may obtain a copy of the License at

<http://www.apache.org/licenses/LICENSE-2.0>

Unless required by applicable law or agreed to in writing, software
distributed under the License is distributed on an "AS IS" BASIS,
WITHOUT WARRANTIES OR CONDITIONS OF ANY KIND, either express or
implied.

See the License for the specific language governing permissions and
limitations under the License.

--- end of LICENSE ---

This Font Software is licensed under the SIL Open Font License, Version 1.1.

This license is copied below, and is also available with a FAQ at: <http://scripts.sil.org/OFL>

SIL OPEN FONT LICENSE Version 1.1 - 26 February 2007

PREAMBLE

The goals of the Open Font License (OFL) are to stimulate worldwide development of collaborative font projects, to support the font creation efforts of academic and linguistic communities, and to provide a free and open framework in which fonts may be shared and improved in partnership with others.

The OFL allows the licensed fonts to be used, studied, modified and redistributed freely as long as they are not sold by themselves. The fonts, including any derivative works, can be bundled, embedded, redistributed and/or sold with any software provided that any reserved names are not used by derivative works. The fonts and derivatives, however, cannot be released under any other type of license. The requirement for fonts to remain under this license does not apply to any document created using the fonts or their derivatives.

DEFINITIONS

"Font Software" refers to the set of files released by the Copyright Holder(s) under this license and clearly marked as such. This may include source files, build scripts and documentation.

"Reserved Font Name" refers to any names specified as such after the copyright statement(s).

"Original Version" refers to the collection of Font Software components as distributed by the Copyright Holder(s).

"Modified Version" refers to any derivative made by adding to, deleting, or substituting -- in part or in whole -- any of the components of the Original Version, by changing formats or by porting the Font Software to a new environment.

"Author" refers to any designer, engineer, programmer, technical writer or other person who contributed to the Font Software.

PERMISSION & CONDITIONS

Permission is hereby granted, free of charge, to any person obtaining a copy of the Font Software, to use, study, copy, merge, embed, modify, redistribute, and sell modified and unmodified copies of the Font Software, subject to the following conditions:

- 1) Neither the Font Software nor any of its individual components, in Original or Modified Versions, may be sold by itself.
- 2) Original or Modified Versions of the Font Software may be bundled, redistributed and/or sold with any software, provided that each copy contains the above copyright notice and this license. These can be included either as stand-alone text files, human-readable headers or in the appropriate machine-readable metadata fields within text or binary files as long as those fields can be easily viewed by the user.
- 3) No Modified Version of the Font Software may use the Reserved Font Name(s) unless explicit written permission is granted by the corresponding Copyright Holder. This restriction only applies to the primary font name as presented to the users.
- 4) The name(s) of the Copyright Holder(s) or the Author(s) of the Font Software shall not be used to promote, endorse or advertise any Modified Version, except to acknowledge the contribution(s) of the Copyright Holder(s) and the Author(s) or with their explicit written permission.
- 5) The Font Software, modified or unmodified, in part or in whole, must be distributed entirely under this license, and must not be distributed under any other license. The requirement for fonts to remain under this license does not apply to any document created using the Font Software.

TERMINATION

This license becomes null and void if any of the above conditions are not met.

DISCLAIMER

THE FONT SOFTWARE IS PROVIDED "AS IS", WITHOUT WARRANTY OF ANY KIND, EXPRESS OR IMPLIED, INCLUDING BUT NOT LIMITED TO ANY WARRANTIES OF MERCHANTABILITY, FITNESS FOR A PARTICULAR PURPOSE AND NONINFRINGEMENT OF COPYRIGHT, PATENT, TRADEMARK, OR OTHER RIGHT. IN NO EVENT SHALL THE COPYRIGHT HOLDER BE LIABLE FOR ANY CLAIM, DAMAGES OR OTHER LIABILITY, INCLUDING ANY GENERAL, SPECIAL, INDIRECT, INCIDENTAL, OR CONSEQUENTIAL DAMAGES, WHETHER IN AN ACTION OF CONTRACT, TORT OR OTHERWISE, ARISING FROM, OUT OF THE USE OR INABILITY TO USE THE FONT SOFTWARE OR FROM OTHER DEALINGS IN THE FONT SOFTWARE.