

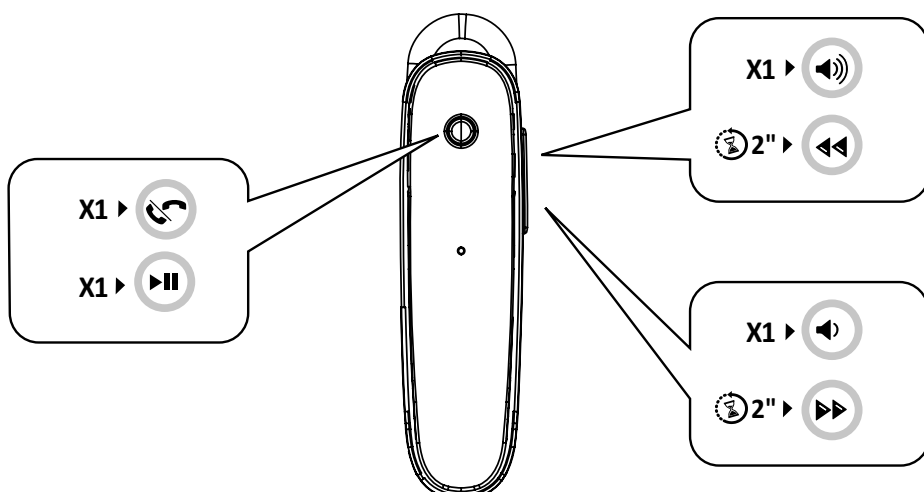

SCORE
BTSCOREK

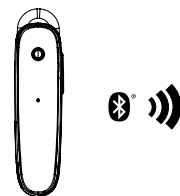
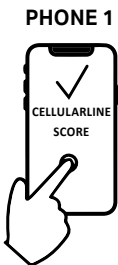
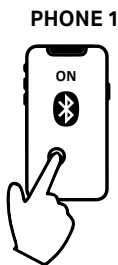
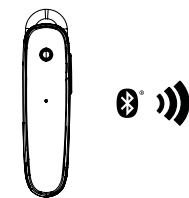
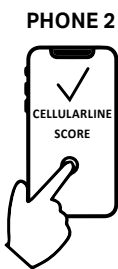
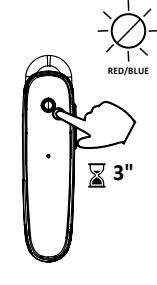
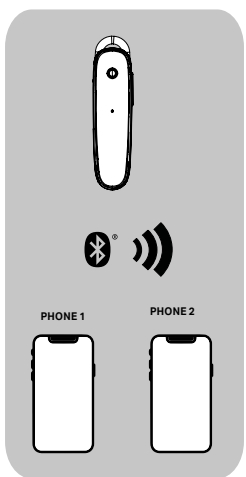
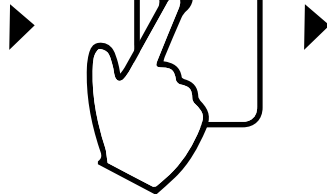
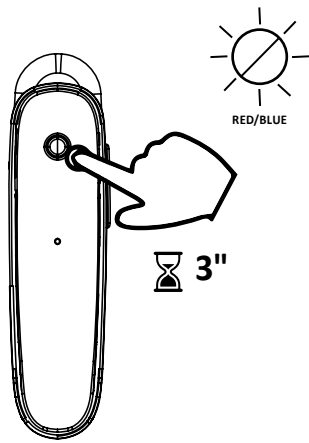
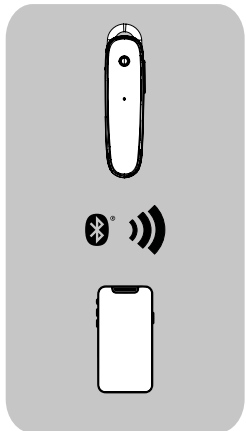
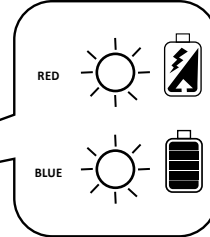
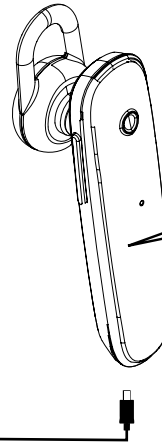
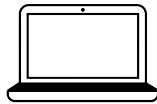
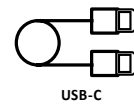
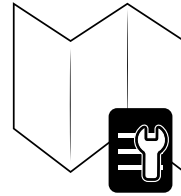
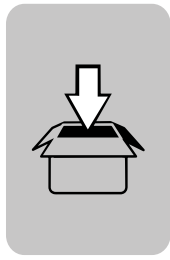

EN - Technical specifications:
Bluetooth® / version: 5.3
Supported profiles: Headset - Handsfree - A2DP - AVRCP
Range / metres: 10
Bluetooth® Frequency Range / Mhz: 2402-2480
Battery Voltage / Volts: 3.7
Battery capacity / mAh: 50
USB-C port Voltage (V) / Volts: 5
USB-C port current (A) / Ampere: 0.2
Maximum EIRP: 1.08dBm
Talk Time / hours/ approx.: 6
Play Time / hours/ approx.: 12
Charging / hours/ approx.: 1.5
Weight / grams: 7.2

IT - Specifiche tecniche:
Bluetooth® / versione: 5.3
Profili supportati: Headset - Handsfree - A2DP - AVRCP
Portata / metri: 10
Bluetooth® Gamma di frequenze / Mhz: 2402-2480
Tensione della batteria / Volt: 3.7
Capacità della batteria / mAh: 50
USB-C port Voltage (V) / Volt: 5
USB-C port current (A) / Ampere: 0.2
Maximum EIRP: 1.08dBm
Talk Time / ore-circa: 6
Play Time / ore-circa: 12
Ricarica / ore-circa: 1.5
Peso / grammi: 7.2

FR - Caractéristiques techniques:
Bluetooth® / version: 5.3
Profils supportés: Headset - Mainlibre - A2DP - AVRCP
Portée / mètres: 10
Bluetooth® Gamme de fréquences / Mhz: 2402-2480
Tension de la batterie / Volt: 3.7
Capacité de la batterie / mAh: 50
Tension du port USB-C (V) / Volt: 5
Courant du port USB-C (A) / Ampère: 0.2
PIRE max: 1.08dBm
Autonomie en stand-by / heures (environ): 60
Autonomie en conversation / heures (environ): 6
Autonomie en lecture / heures (environ): 12
Recharge / heures (environ): 1.5
Poids / grammes: 7.2

DE - Technische Daten:
Bluetooth® / Version: 5.3
Unterstützte Profile: Headset - Handsfree - A2DP - AVRCP
Reichweite / Meter: 10
Bluetooth®-Frequenzbereich / Mhz: 2402-2480
Akkuspannung / Volt: 3.7
Akkukapazität / mAh: 50
USB-C-Anschluss Spannung (V) / Volt: 5
USB-C-Anschluss Strom (A) / Ampere: 0.2
Maximale EIRP: 1.08dBm
Gesprächszeit / Stunden ca.: 6
Musikwiedergabezeit / Stunden ca.: 12
Aufladen / Stunden ca.: 1.5
Gewicht / Gramm: 7.2

ES - Especificaciones técnicas:
Bluetooth® (versión): 5.3
Perfiles admitidos: Headset - Handsfree - A2DP - AVRCP
Alcance (metros): 10
Rango de frecuencia Bluetooth® (MHz): 2402-2480
Voltaje de la batería (volts): 3.7
Capacidad de la batería (mAh): 50
Voltaje del puerto USB-C (volts): 5
Corriente del puerto USB-C (amperios): 0.2
Potencia isotrópica radiada equivalente máxima: 1.08dBm
Tiempo de conversación (horas aprox.): 6
Tiempo de reproducción (horas aprox.): 12
Recarga (horas aprox.): 1.5
Peso (gramos): 7.2

TR - Teknik özellikler:
Bluetooth® / sürümü: 5.3
Desteklenen profiller: Kulaklık - Eller Serbest - A2DP - AVRCP
Kapsama alanı / metre: 10
Bluetooth® Frekans Aralığı / Mhz: 2402-2480
Pili Voltajı / Volt: 3.7
Pili Kapasitesi / mAh: 50
USB-C port Gerilimi (V) / Volt: 5
USB-C port akımı (A) / Amper: 0.2
Maksimum EIRP: 1.08dBm
Konuşma Süresi / saat-yaklaşık: 6
Çalma Süresi / saat-yaklaşık: 12
Tekrar ykle / saat-yaklaşık: 1.5
Ağırlık / gram: 7.2

NL - Technische kenmerken:
Bluetooth® / versie: 5.3
Ondersteunde profielen: Headset - Handsfree - A2DP - AVRCP
Bereik / meter: 10
Bluetooth® Frequentiebereik / Mhz: 2402-2480
Batterijspanning / Volt: 3.7
Batterijcapaciteit / mAh: 50
Spanning USB-C-poort (V) / Volt: 5
Stroomsterkte USB-C-poort (A) / Ampère: 0.2
Maximum EIRP: 1.08dBm
Tijdsduur in gesprek / uur-circa: 6
Afspeltijd / uur-circa: 12
Opladttijd / uur-circa: 1.5
Gewicht / gram: 7.2

FI - Tekniset tiedot:
Bluetooth® / versio: 5.3
Tuetut profiilit: Headset - Handsfree - A2DP - AVRCP
Kantavuus / metri: 10
Bluetooth® taajuusalue / Mhz: 2402-2480
Akun jännite / Voltti: 3.7
Akun kapasiteetti / mAh: 50
USB-C -portin jännite (V) / Voltti: 5
USB-C -portin virta (A) / Ampeeri: 0.2
Maks. EIRP: 1.08dBm
Puheaika / tuntia-noin: 6
Musikinkuuntelu-aika / tuntia-noin: 12
Lataaminen / tuntia-noin: 1.5
Paino / grammaa: 7.2

SV - Tekniska specifikationer:
Bluetooth® / version: 5.3
Profiler som stöds: Headset - Handsfree - A2DP - AVRCP
Räckvidd / meter: 10
Bluetooth® frekvensvidd / Mhz: 2402-2480
Batterispänning / Volt: 3.7
Batterikapacitet / mAh: 50
USB-C-portens spänning (V) / Volt: 5
USB-C-portens ström (A) / Ampere: 0.2
Maximal EIRP: 1.08dBm
Samtalstid / timmar cirka: 6
Speltid / timmar cirka: 12
Laddning / timmar cirka: 1.5
Vikt / gram: 7.2

DA - Tekniske data:
Bluetooth® / version: 5.3
Understøttede profiler: Headset - Handsfree - A2DP - AVRCP
Rækkevidde / meter: 10
Bluetooth® frekvensområde / Mhz: 2402-2480
Batterispænding / Volt: 3.7
Batteriets kapacitet / mAh: 50
USB-C-portens spænding (V) / Volt: 5
USB-C-portens strøm (A) / Ampere: 0.2
Maksimum EIRP: 1.08dBm
Taletid / timer-cirka: 6
Afspilningstid / timer-cirka: 12
Opladning / timer-cirka: 1.5
Vægt / gram: 7.2

