



CLASSIC

10712





 [LEGO.com/classic](https://www.lego.com/classic)

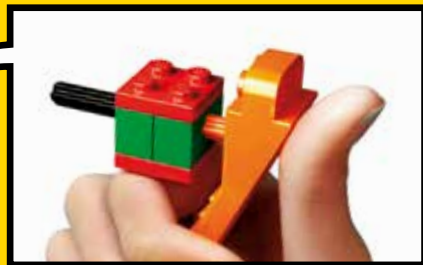



LEGO.com/brickseparator

 Easy building
Einfach zu bauen
Construction facile
Costruzione facile
Construcción fácil
Construção fácil
Kezdő építőknek
简单拼砌

 Medium building
Mittelschwer
Construction intermédiaire
Costruzione media
Construcción intermedia
Construção intermédia
Gyakorló építőknek
中级拼砌



 Advanced building
Fortgeschritten
Construction avancée
Costruzione avanzata
Construcción avanzada
Construção avançada
Tapasztalt építőknek
高级拼砌



Page

 6

Page

 18



Page
Seite
Page
Pagina
Página
Página
oldalszám
页码

Page
26



Page
48



Page
40



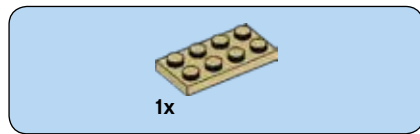

1

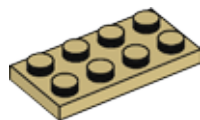



2x

2

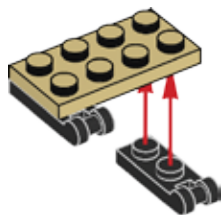

1x

3

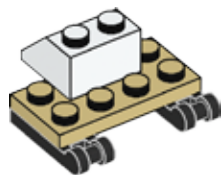

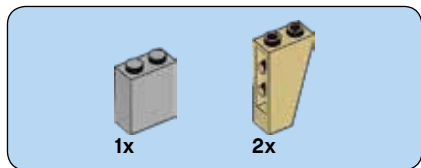

4

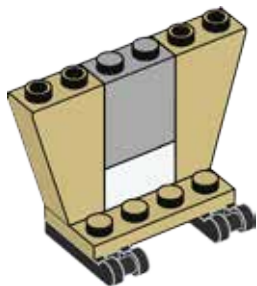

8

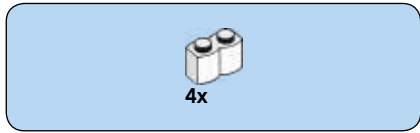

5

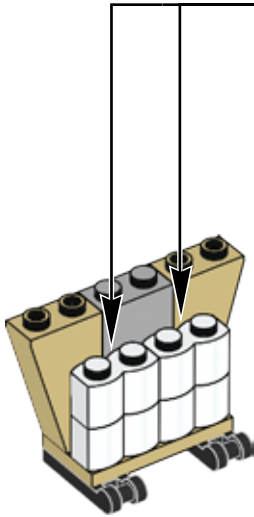
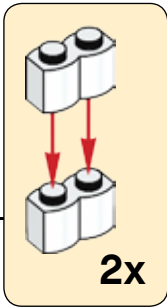

6

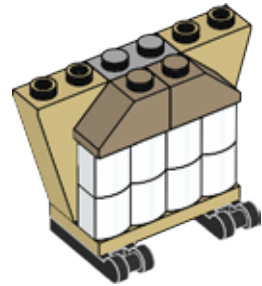



1x



2x

7

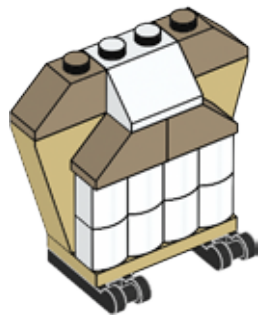



2x



1x

8

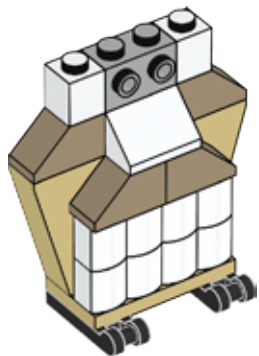

1x



1x

9

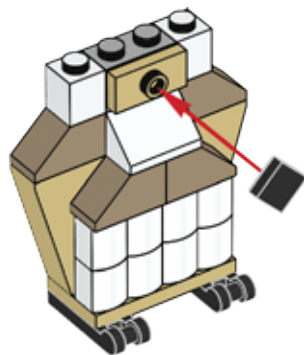



1x

10





2x

11

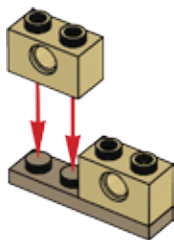

1x

12

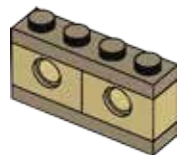



1x



1x

13

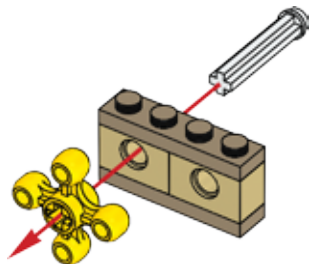

14



1x



1x

14

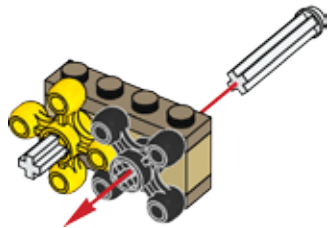

1x

15

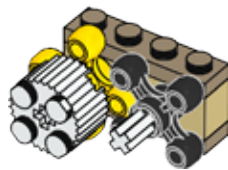

16

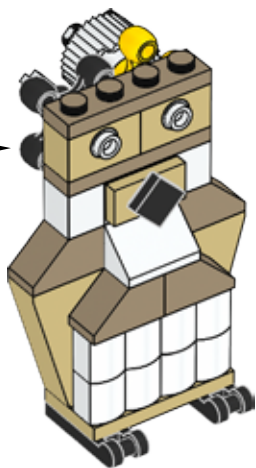
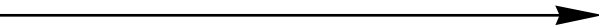



2x



2x

17

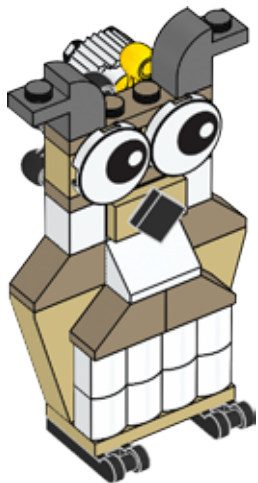

LEGO.com/classic

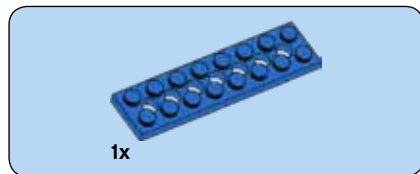

1

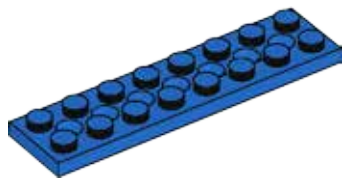



3x

2

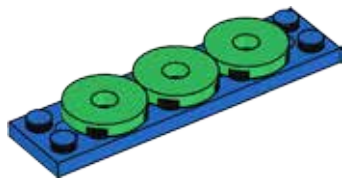

2x

3

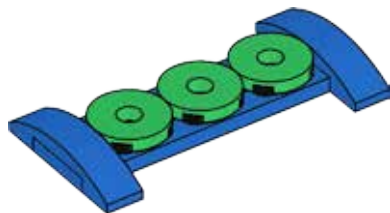

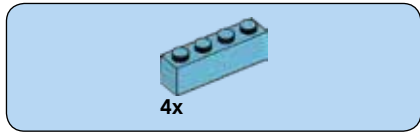

4

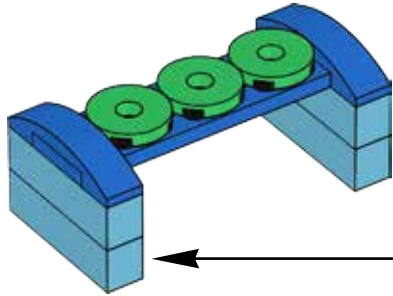
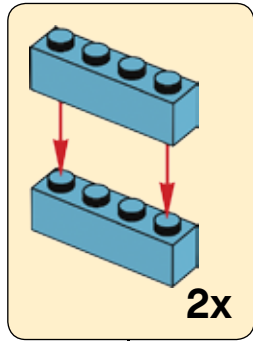

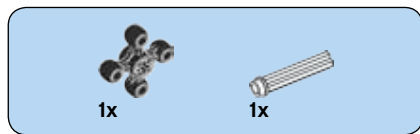

5

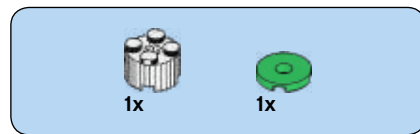
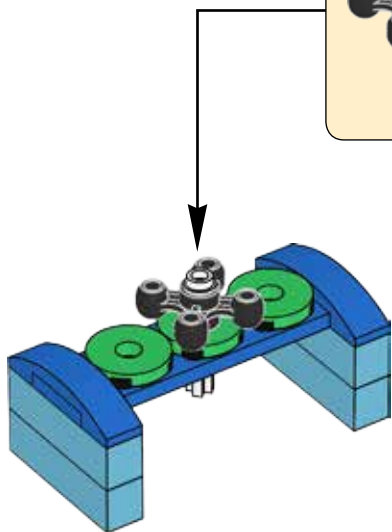
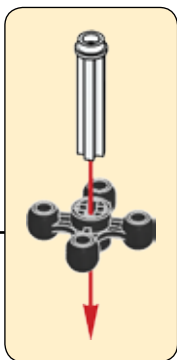

6

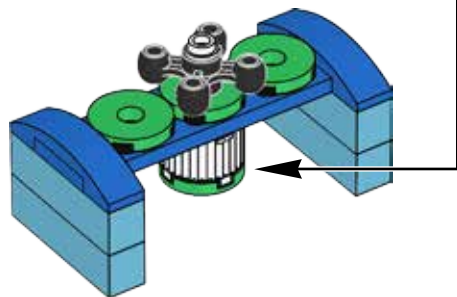
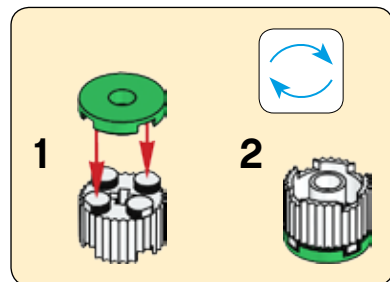



7

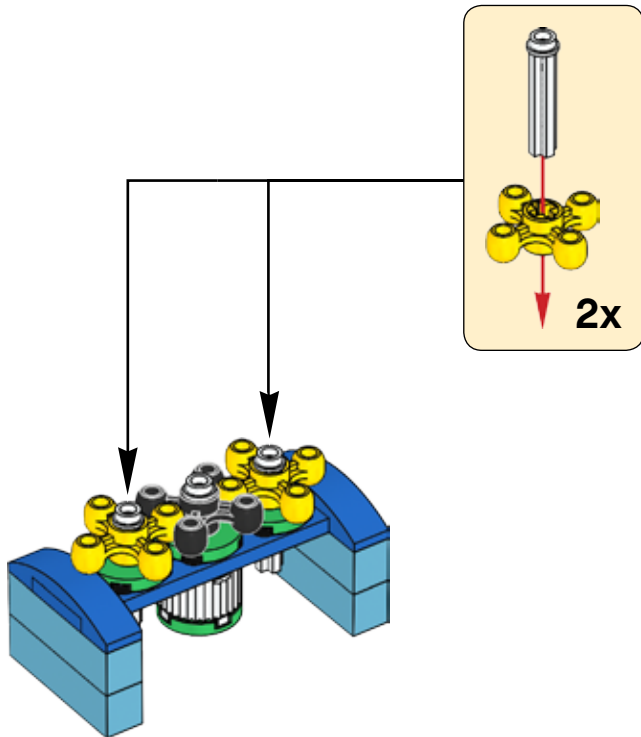



3x

8

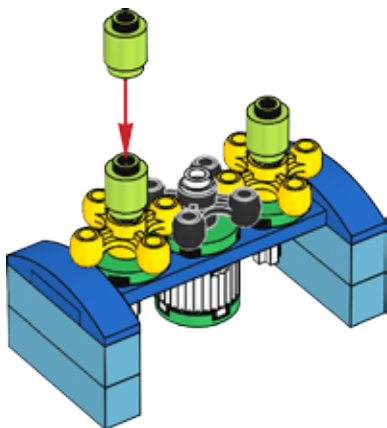

1x



2x

9

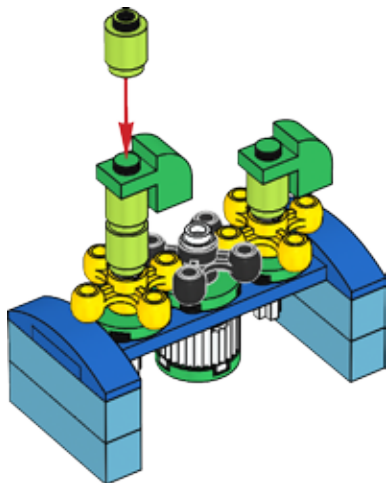



2x

10

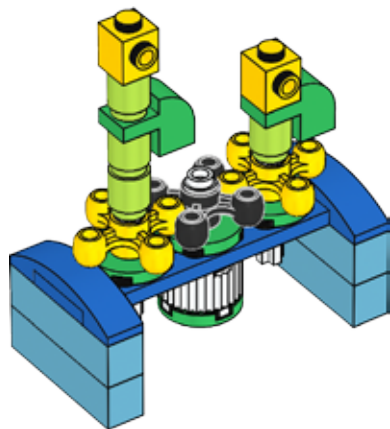

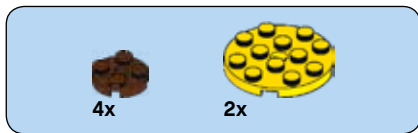

11

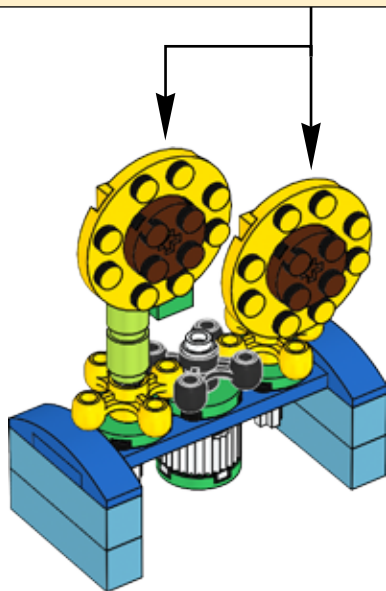
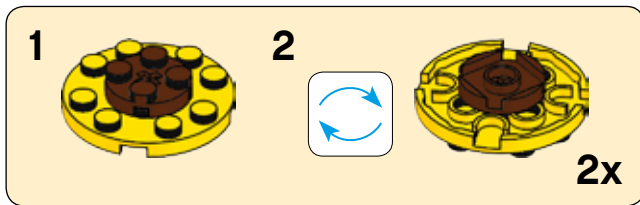

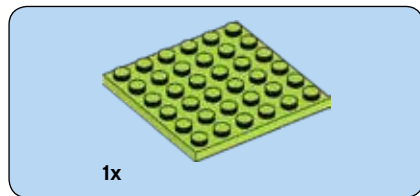

1



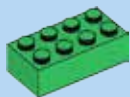

1x

2

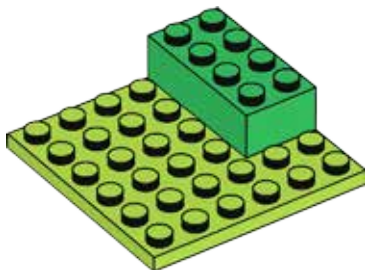



2x

3

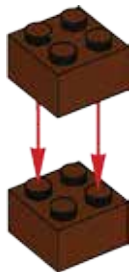

2x

4





5



6

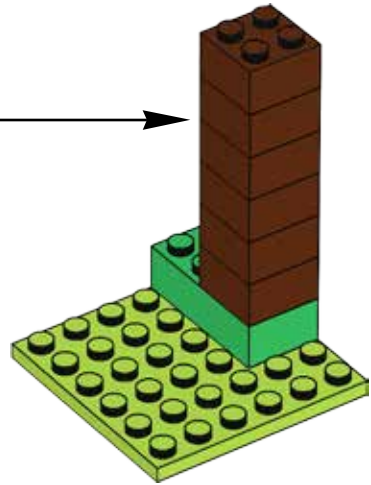

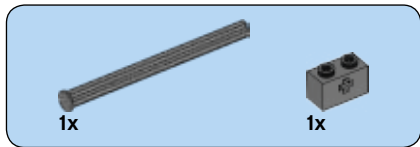
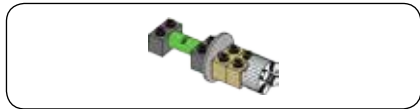

7

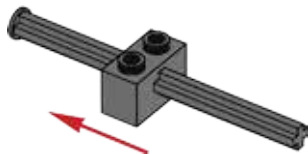



8

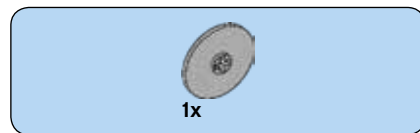
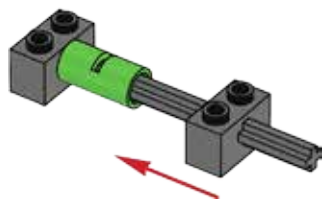

9

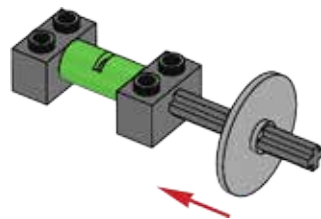



2x

10

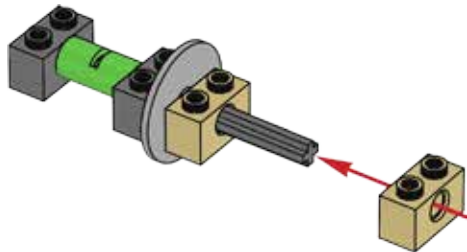



1x

11

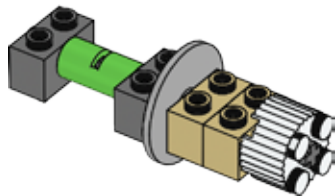

12

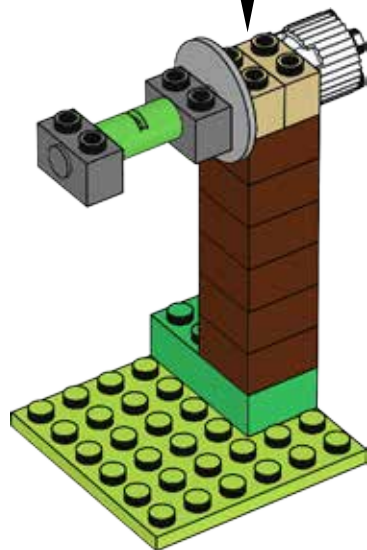



1x

13

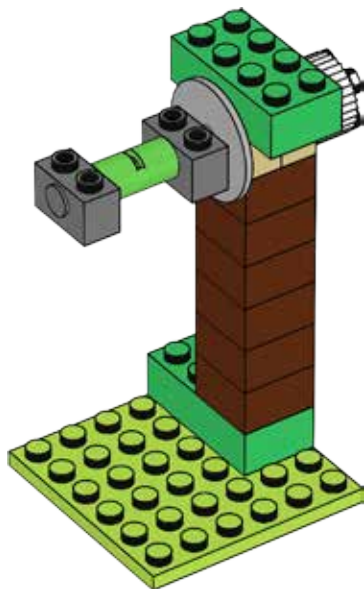



1x



1x

14



1x



1x

15

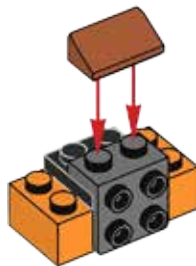



2x



1x

16

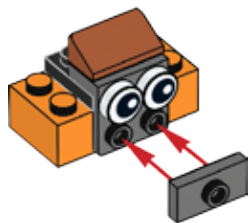

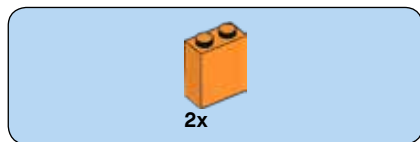

17

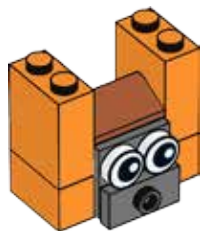

18

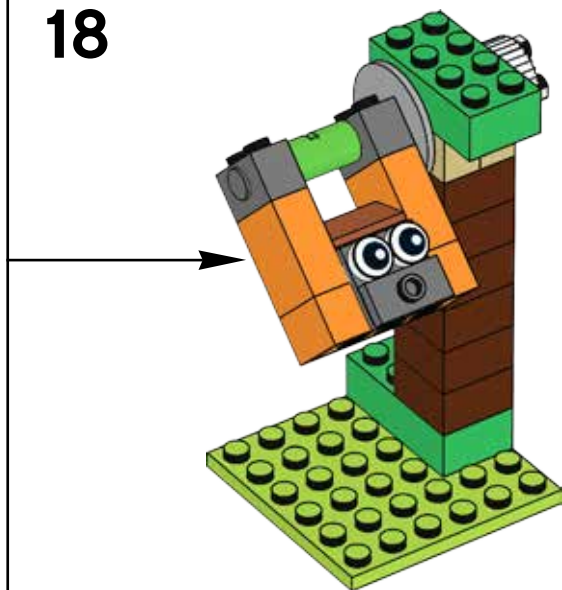

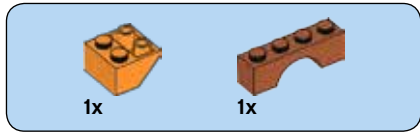

19

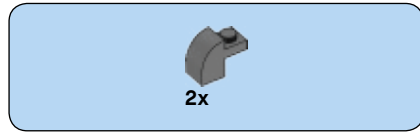
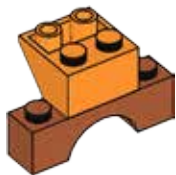

20

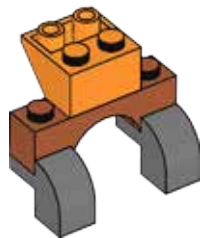

21

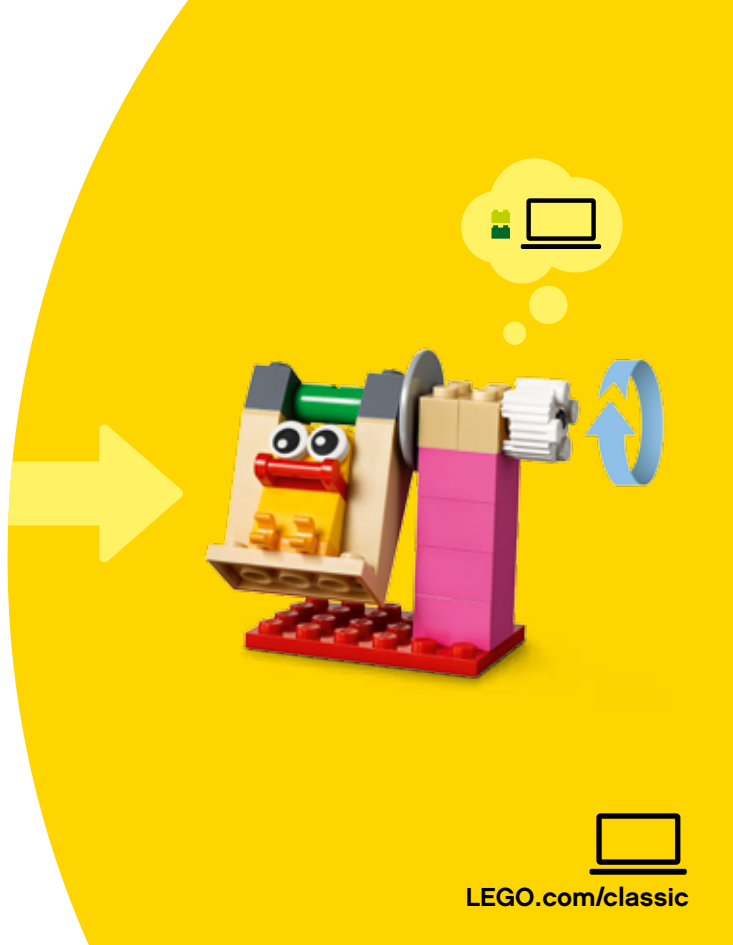
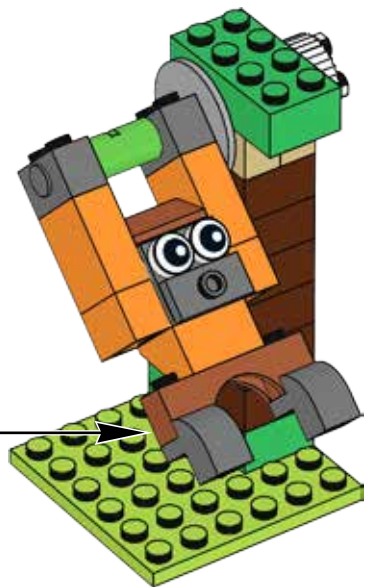

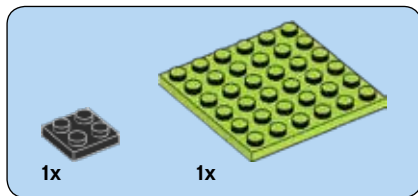

1

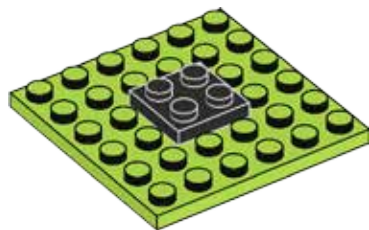



2

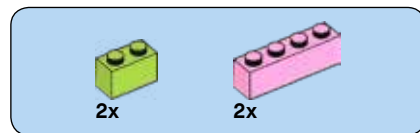
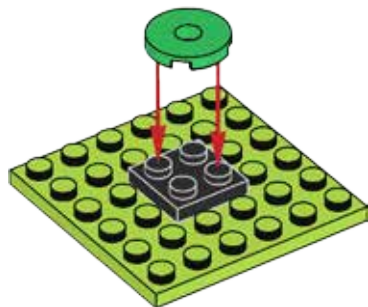

3

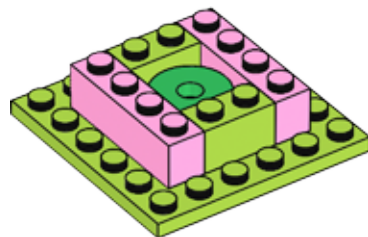



4

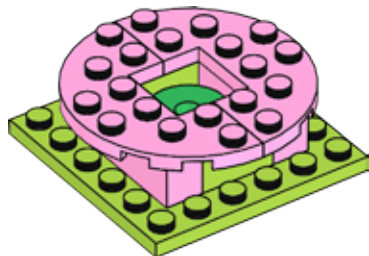

5

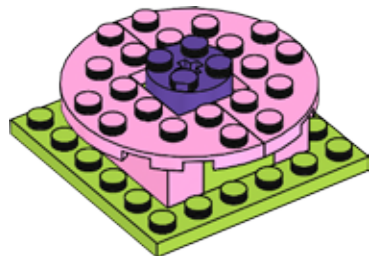

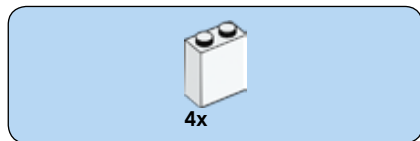

6

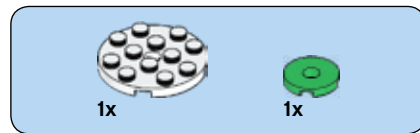
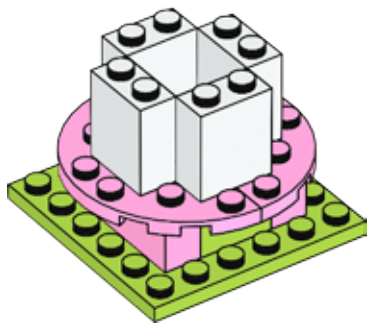

7

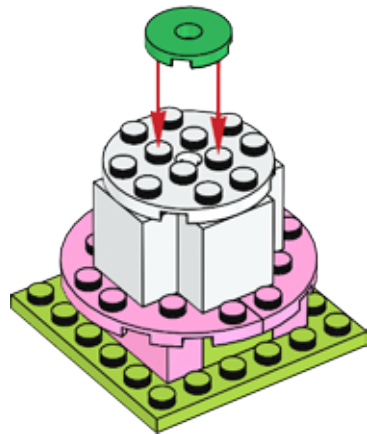

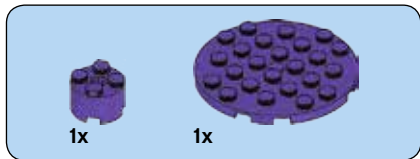

8



9





4x



4x

10



4x



4x

11

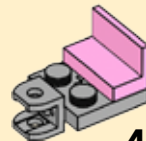

4x

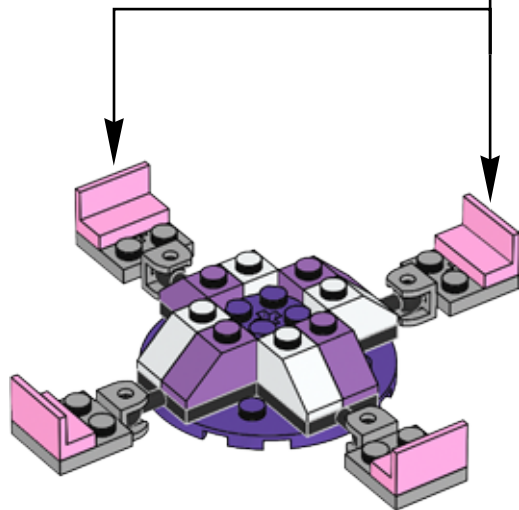

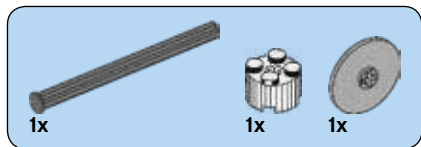

12

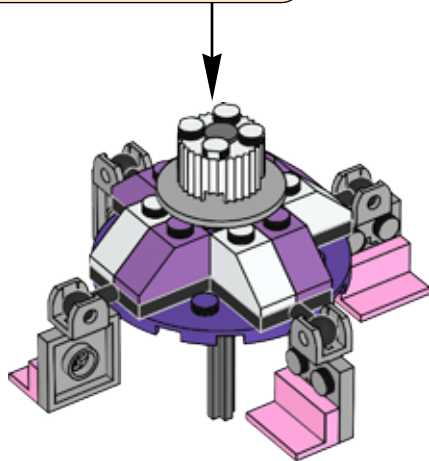
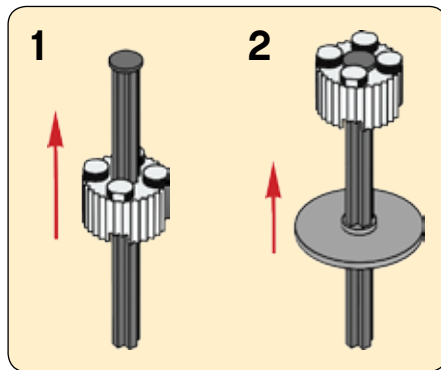

13

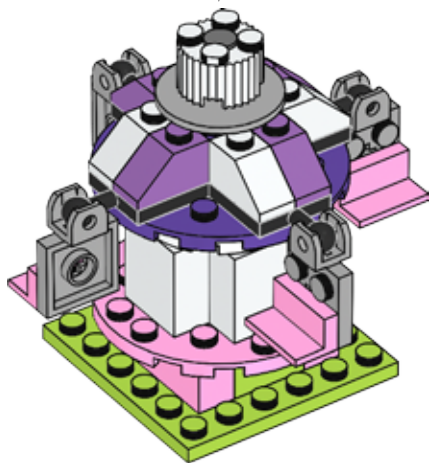

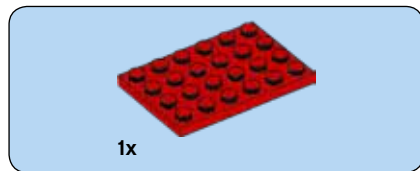

1



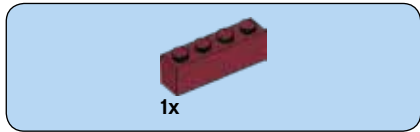

2

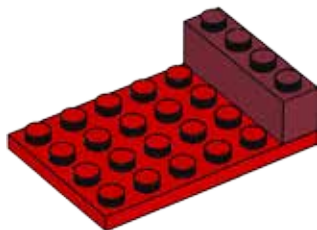

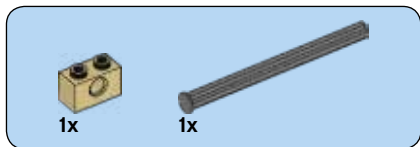
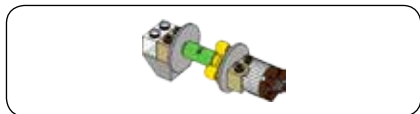

3

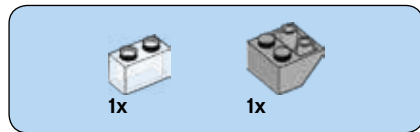
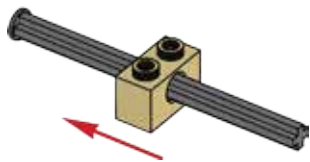

4

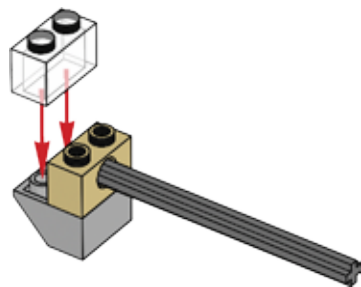

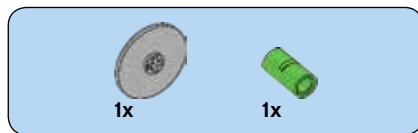

5

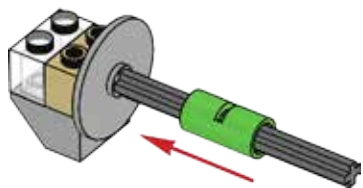

6

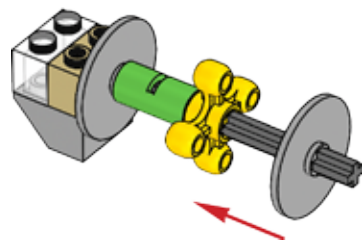



1x



1x

7

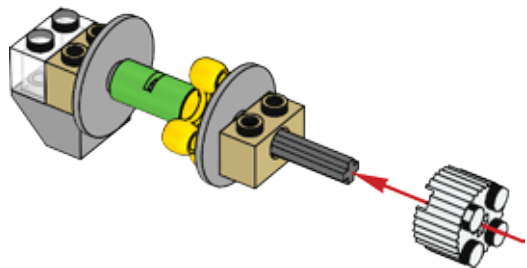

1x

8

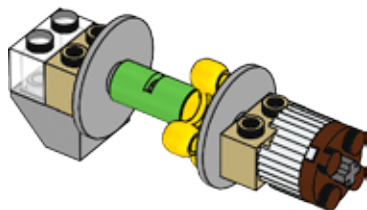

9

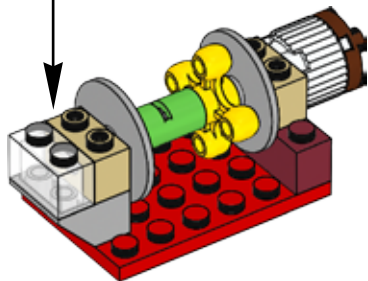

2x



1x

10

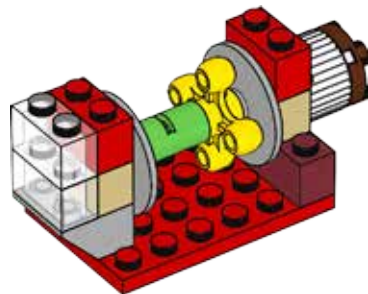

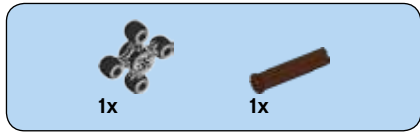

11

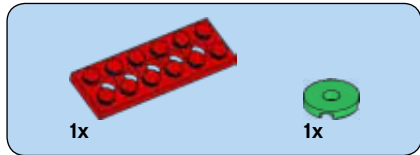

12

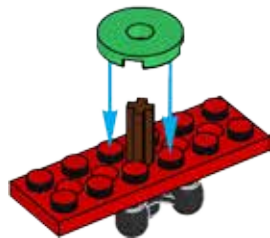



1x

13

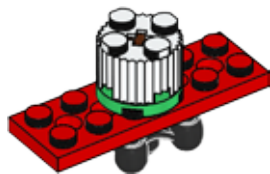

14

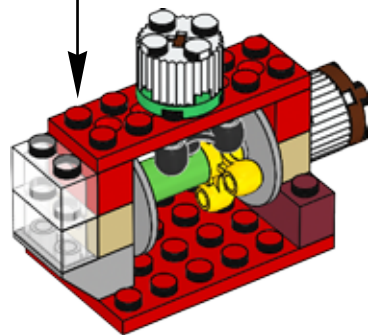

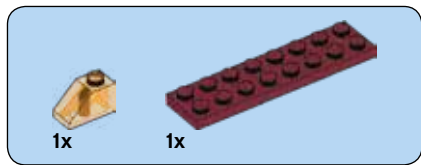

15

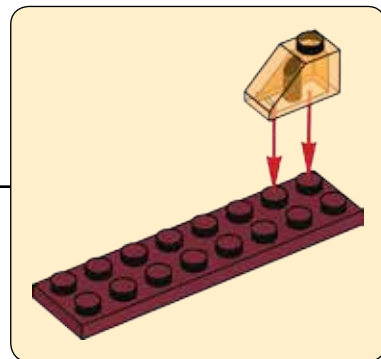
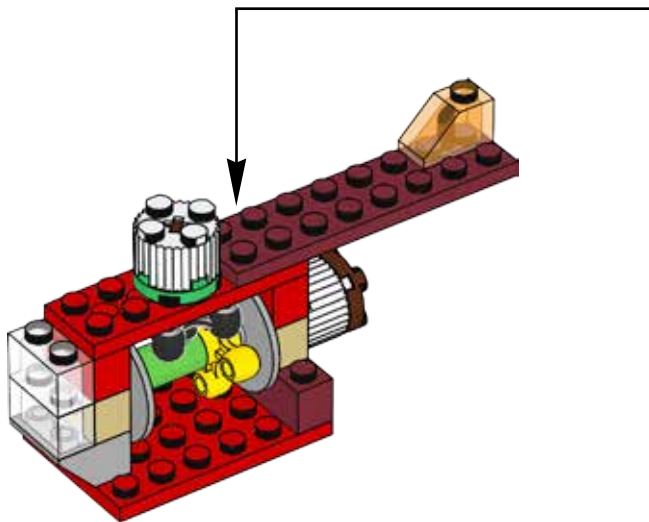



2x

16

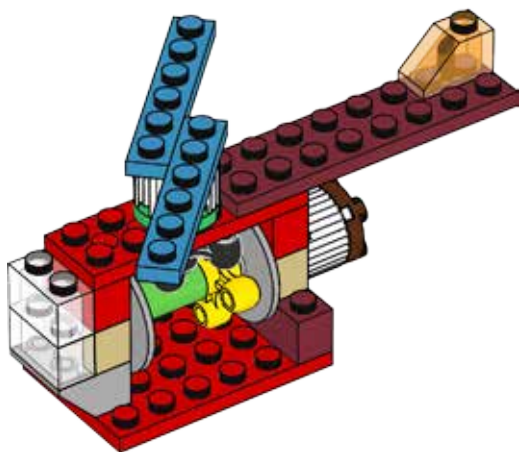

2x

17

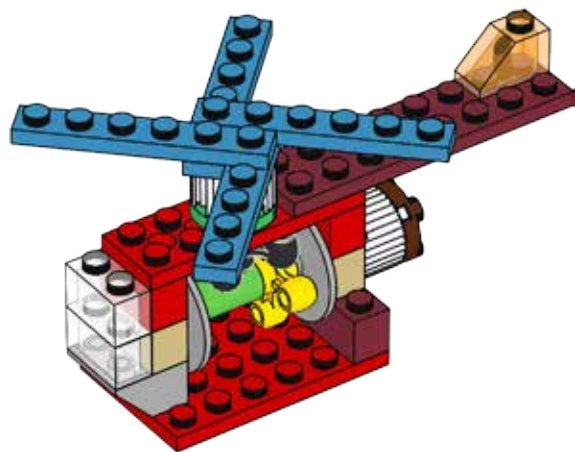



1x

18

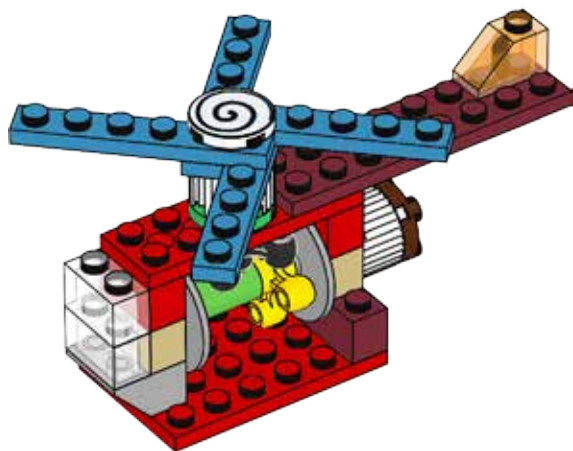

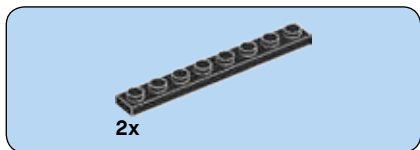
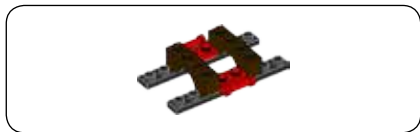

19

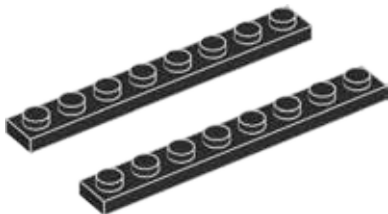

20

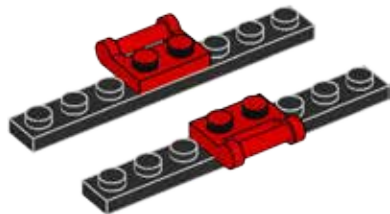



2x

21

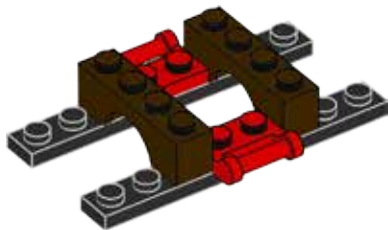

22

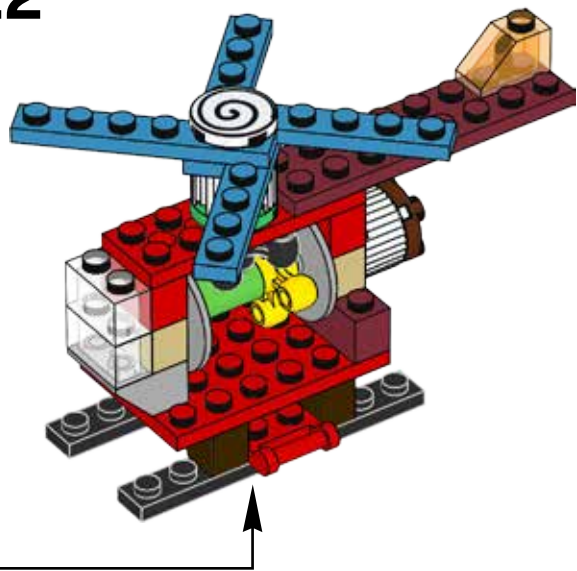

What will you build for Mr. Stareyes' adventures?

Was wirst du für Mr. Stareyes Abenteuer bauen?

Que vas-tu construire pour les aventures de M. Œil-Fou ?

Cosa costruirai per le avventure del Sig. Grandiocchi?

¿Qué construirás para las aventuras de Mr. Stareyes?

O que vais construir para as aventuras do Sr. Stareyes?

Mit építész Csillagnézó úr kalandjaihoz?

您会为星眼先生的大冒险拼搭些什么呢？





10698



10696



10700



10714



10713



10701



CITY



60170



60171



60172



60173



60174



60176





CREATOR

3ⁱⁿ1

3 in 1
3 en 1
3 em 1
3 az egyben
3 合 1



31075

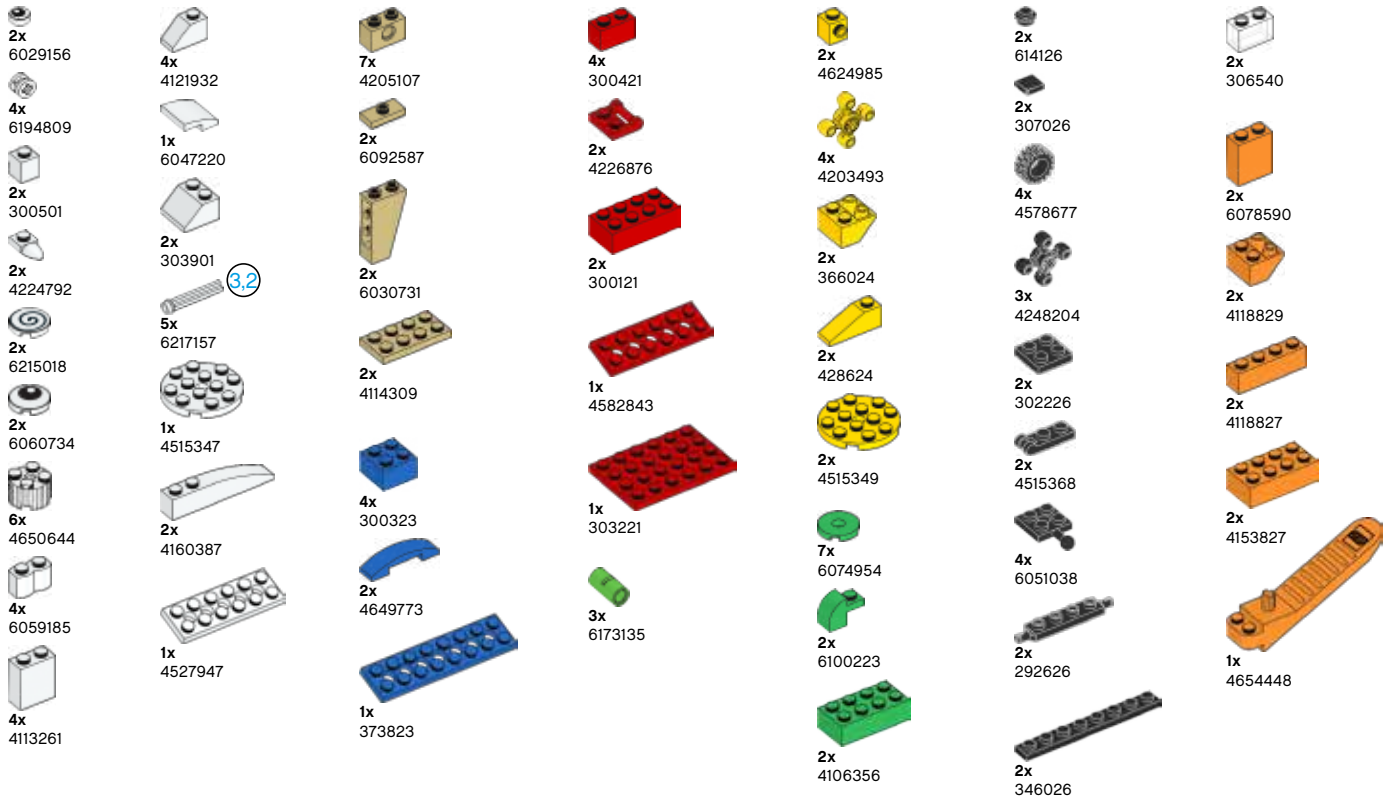

4x
4530678

2x
4626904

2x
6052777

1x
6152321

4x
4212454

2x
4164022

2x
4234716

2x
4525858

2x
6188477

2x
6212897

2x
6022650

2x
6093459

4x
6132408

1x
6057616

2x
6015344

2x
4211564

2x
4211614

4x
4667578

4x
4530469

1x
4211436

2x
6178919

4x
4210797

4x
6013658

2x
6092572

1x
6117972

3x
4499858

4x
4517992

5x
4211159

6x
4211210

2x
6135494

4x
6146231

2x
4518890

2x
6133060

2x
6036232

1x
6102580

2x
4622176

1x
6216908

2x
4623775

2x
6004943

4x
6151657

4x
6036238

4x
6022005

3

8

Customer Service
Kundenservice
Service Consommateurs
Servicio Al Consumidor

LEGO.com/service or dial



: 00800 5346 5555

: 1-800-422-5346

WIN

GO TO WWW.LEGO.COM/PRODUCTFEEDBACK AND
GIVE US YOUR SHORT **FEEDBACK** ABOUT THIS
LEGO® SET FOR A CHANCE TO WIN
A COOL LEGO PRIZE.

Terms & Conditions apply

LEGO.com/productfeedback



GEWINNE

Erzähle uns auf
www.LEGO.com/productfeedback

etwas über die Erfahrungen, die du mit
diesem LEGO® Set gemacht hast, und
sichere dir die Chance auf einen coolen
LEGO Preis!

Es gelten die Teilnahmebedingungen

GAGNE

Rends-toi sur
www.LEGO.com/productfeedback

et donne-nous quelques commentaires sur
ce produit LEGO® pour avoir une chance
de gagner un prix LEGO !

Voir Conditions Générales

GANAN

Visita
www.LEGO.com/productfeedback

y envíanos tu opinión acerca de este set
LEGO®. ¡Participarás en el sorteo de un
premio LEGO!

Términos y Condiciones aplicables

获取奖品

登录
www.LEGO.com/productfeedback

给出关于此乐高®套装的简短反馈，
就有机会获得炫酷乐高奖品

《条款及条件》适用

LEGO and the LEGO logo are trademarks of the LEGO Group. ©2018 The LEGO Group.

6225658