

1



10218





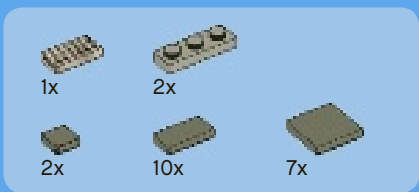

2

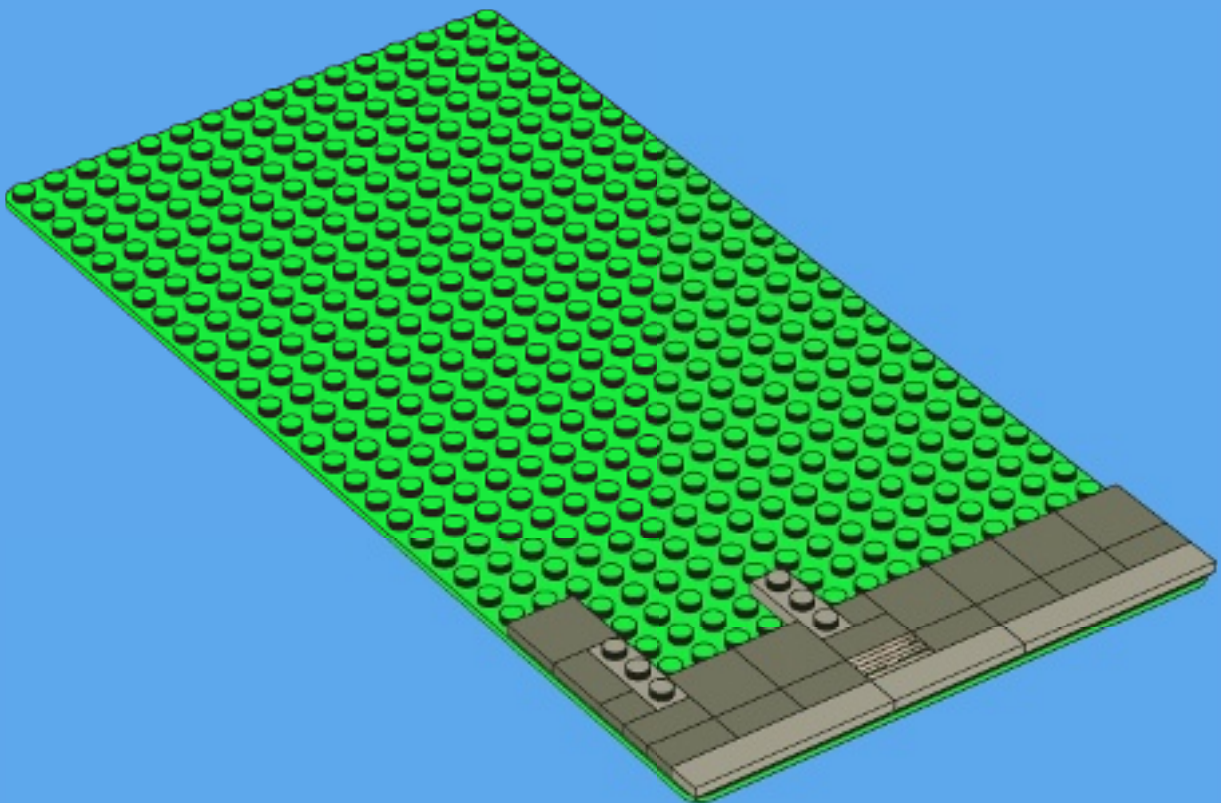

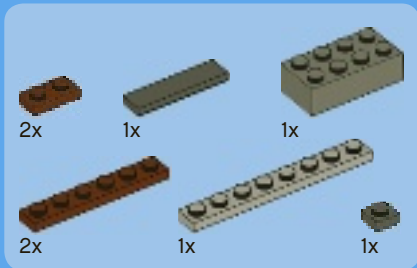

3

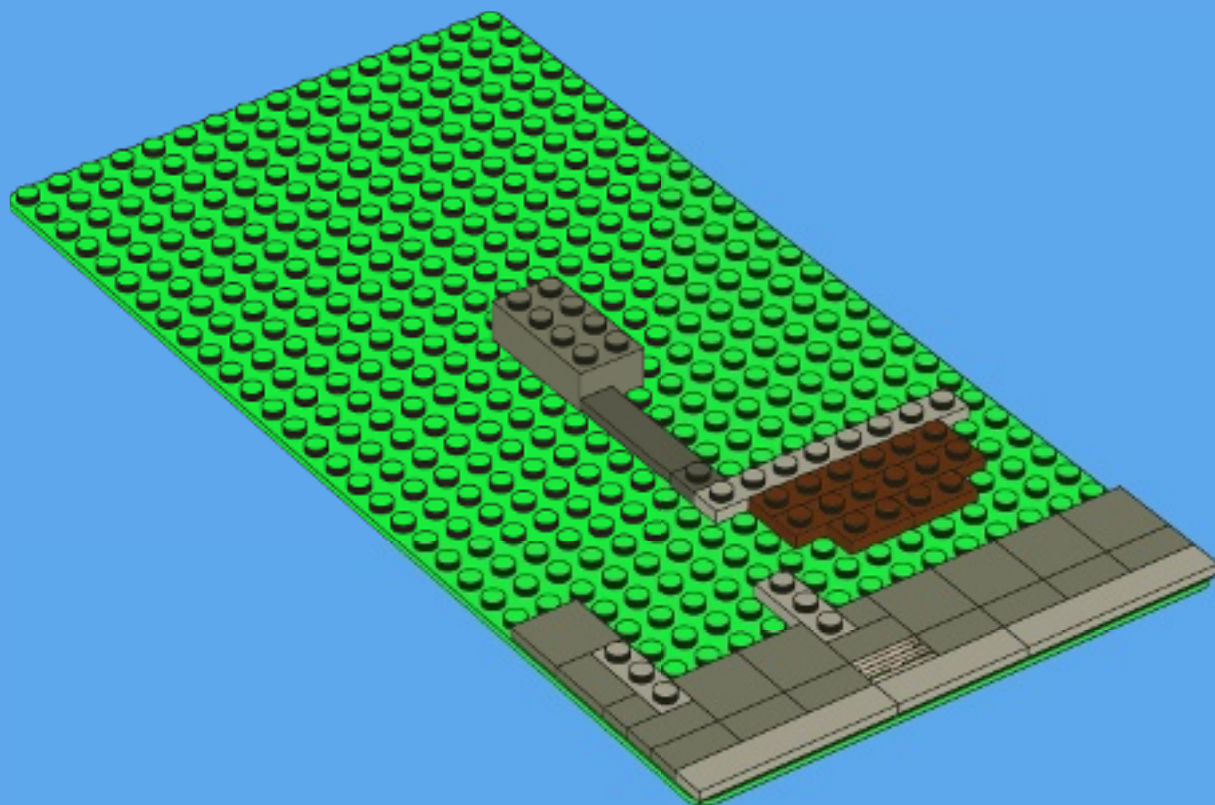

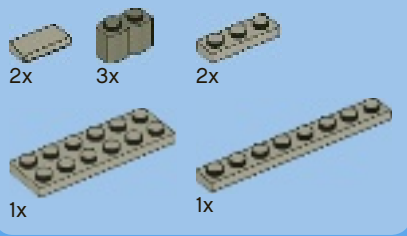

4

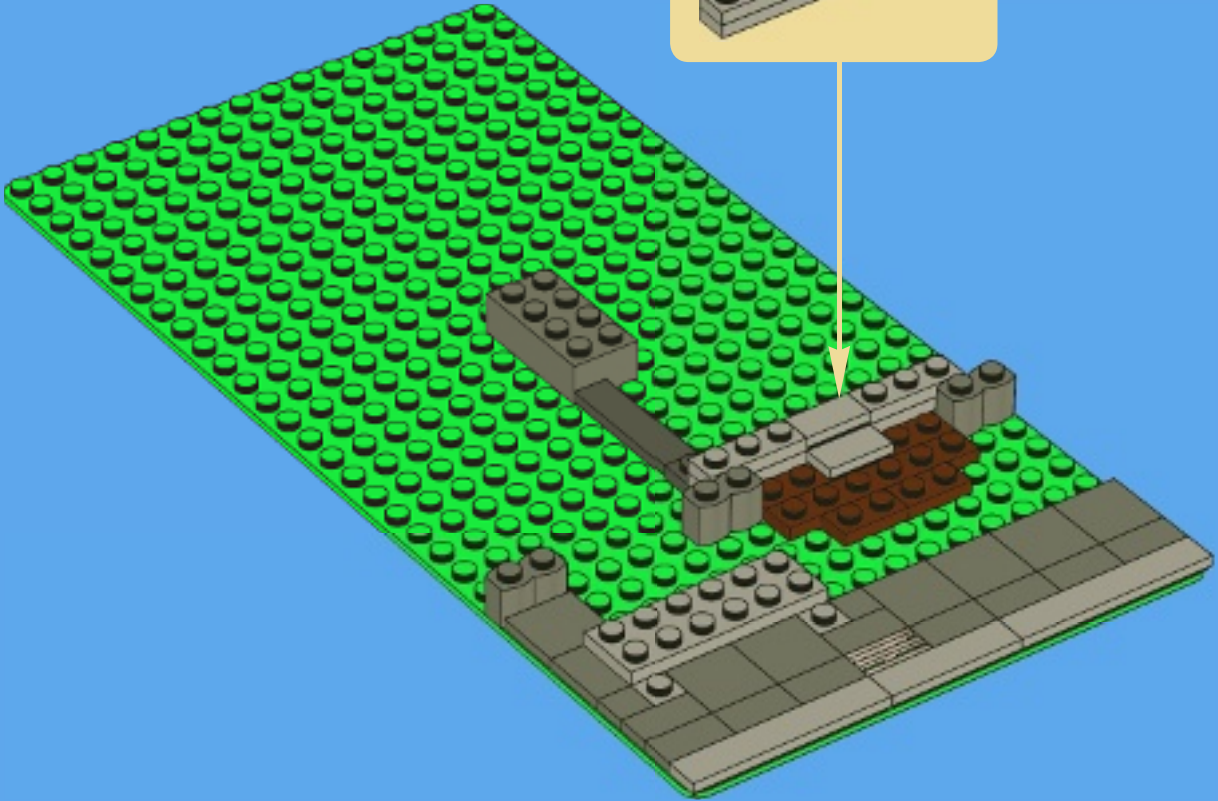
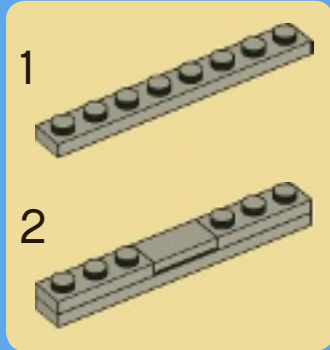

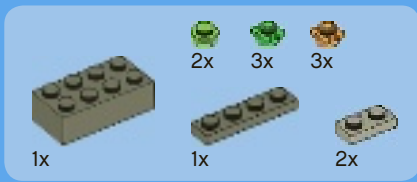

5

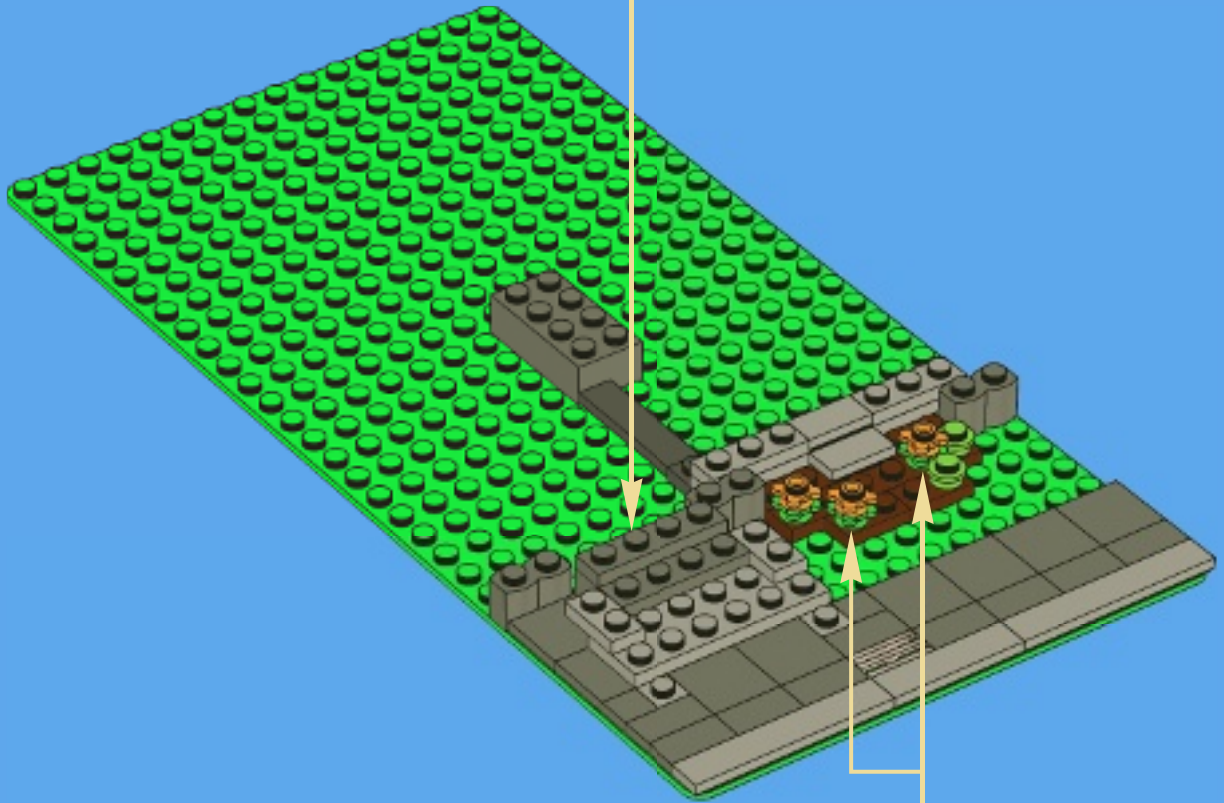
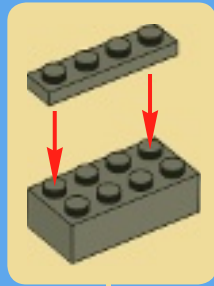

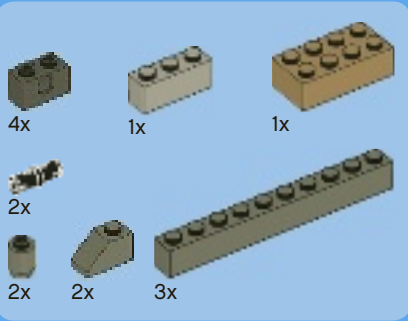

6

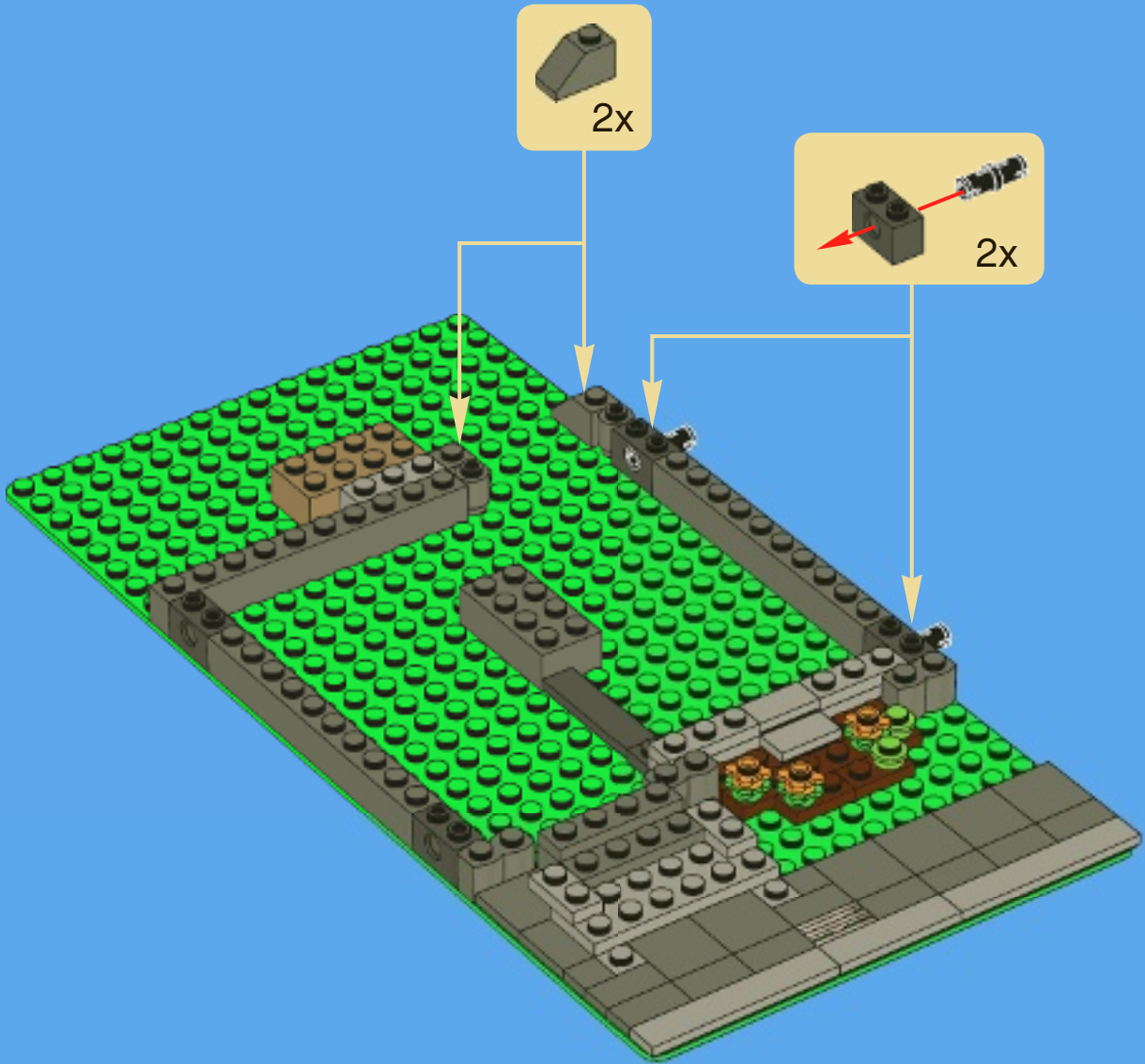

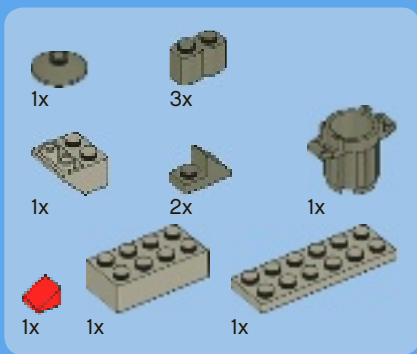

7

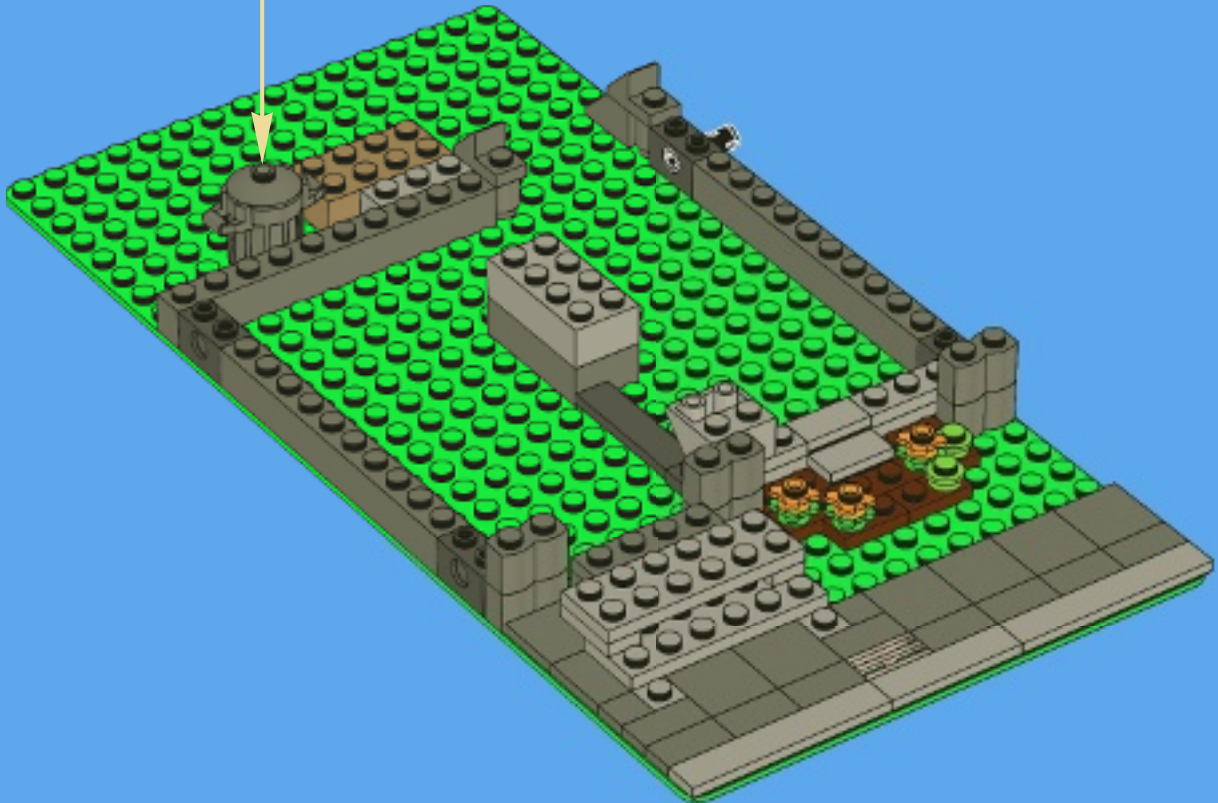
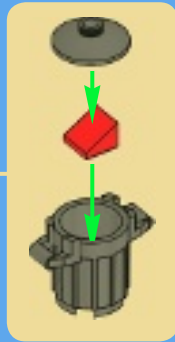

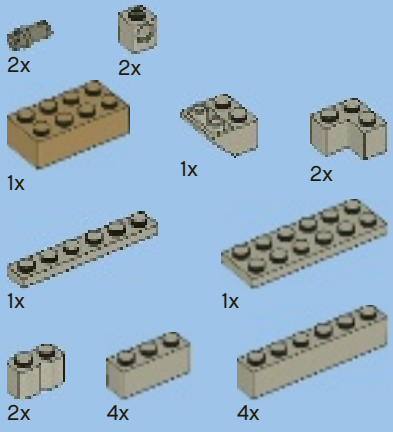

8

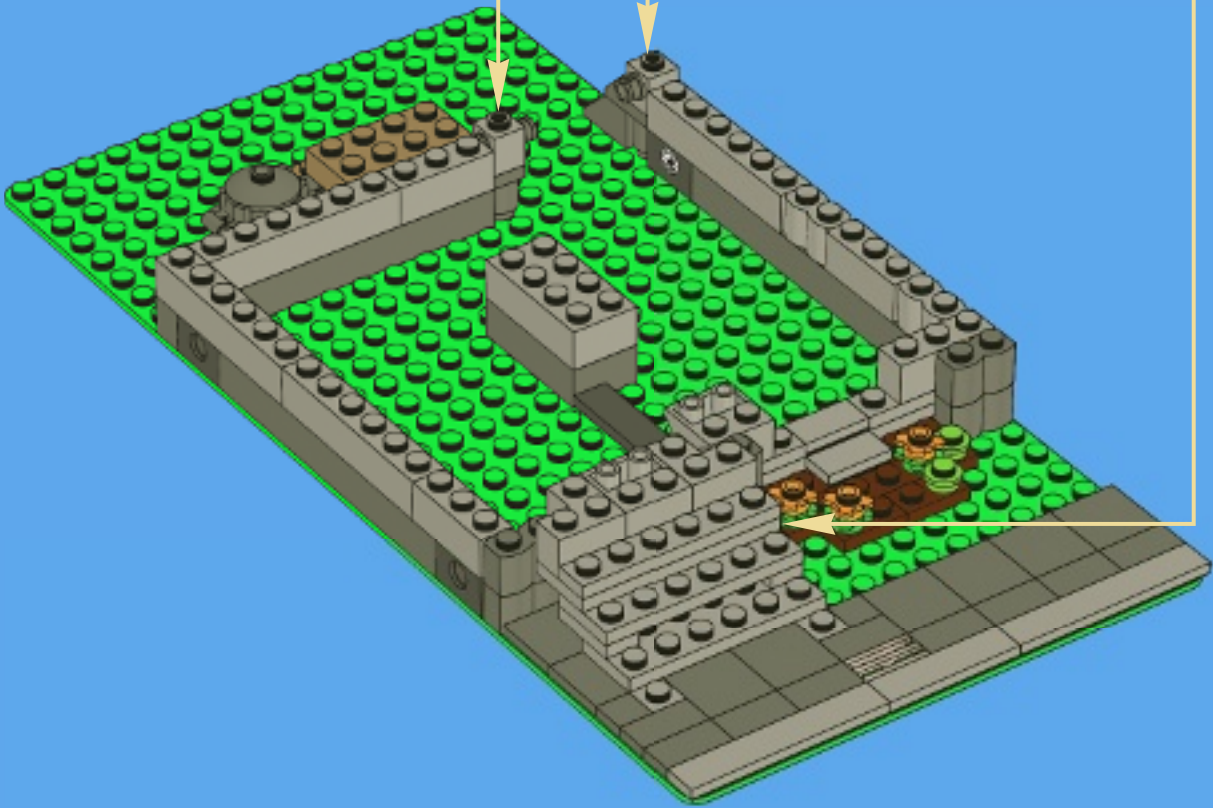
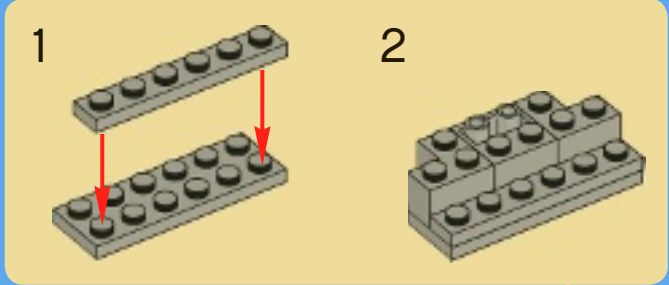
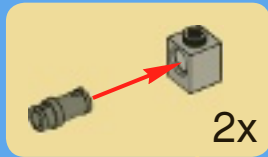

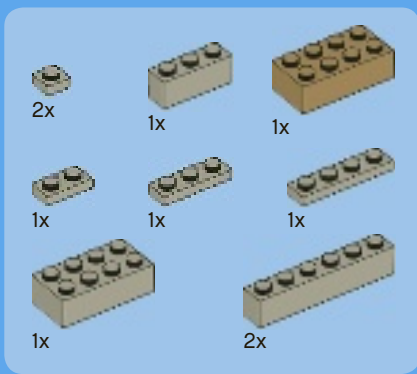

9

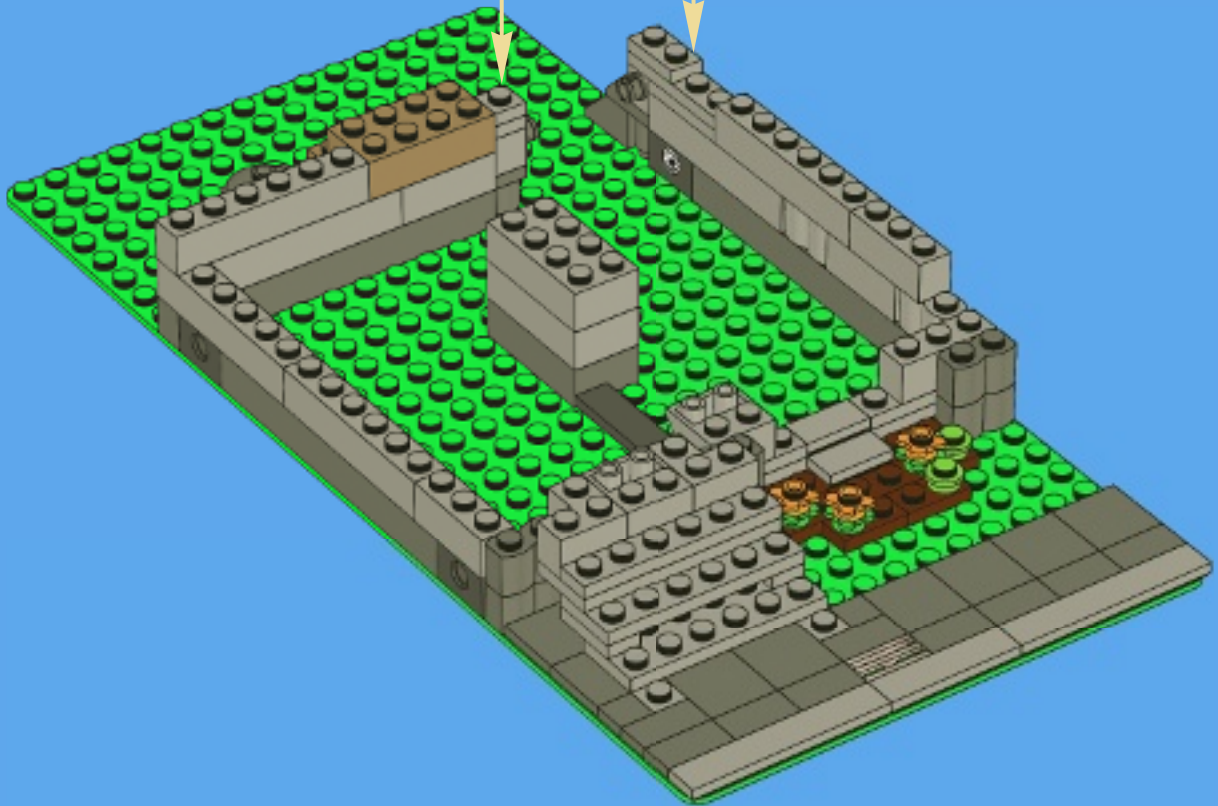
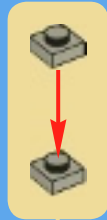
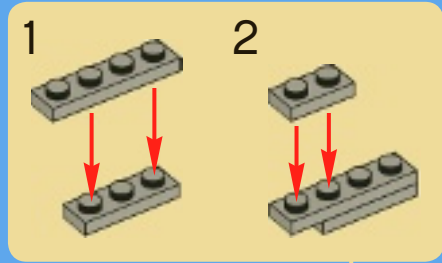

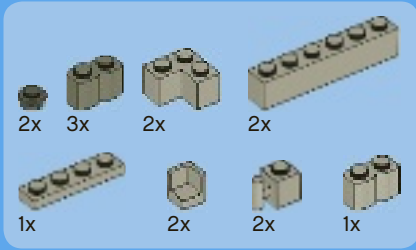

10

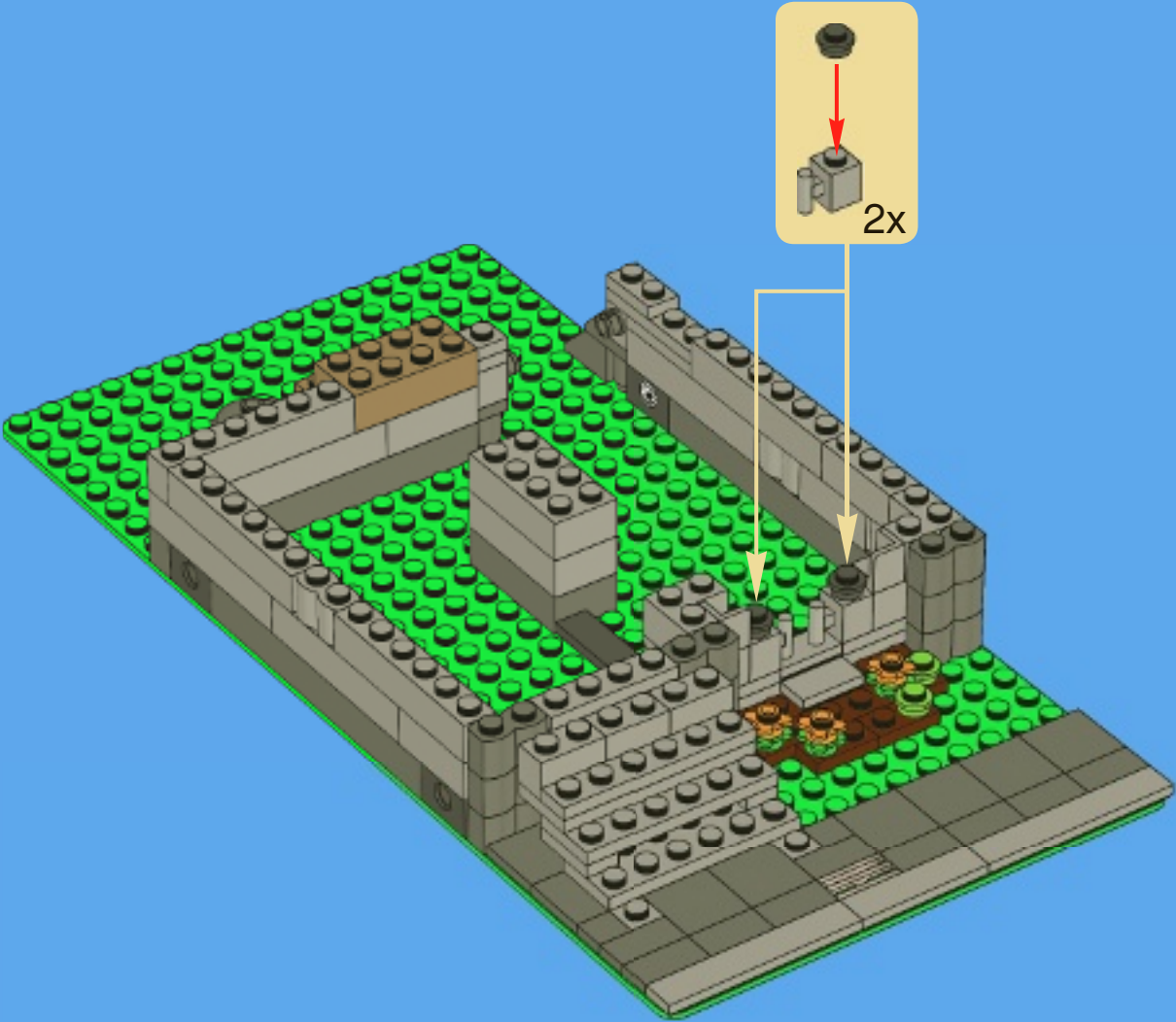

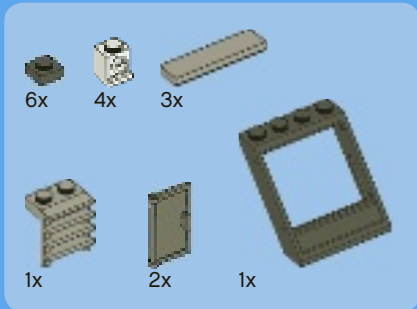

11

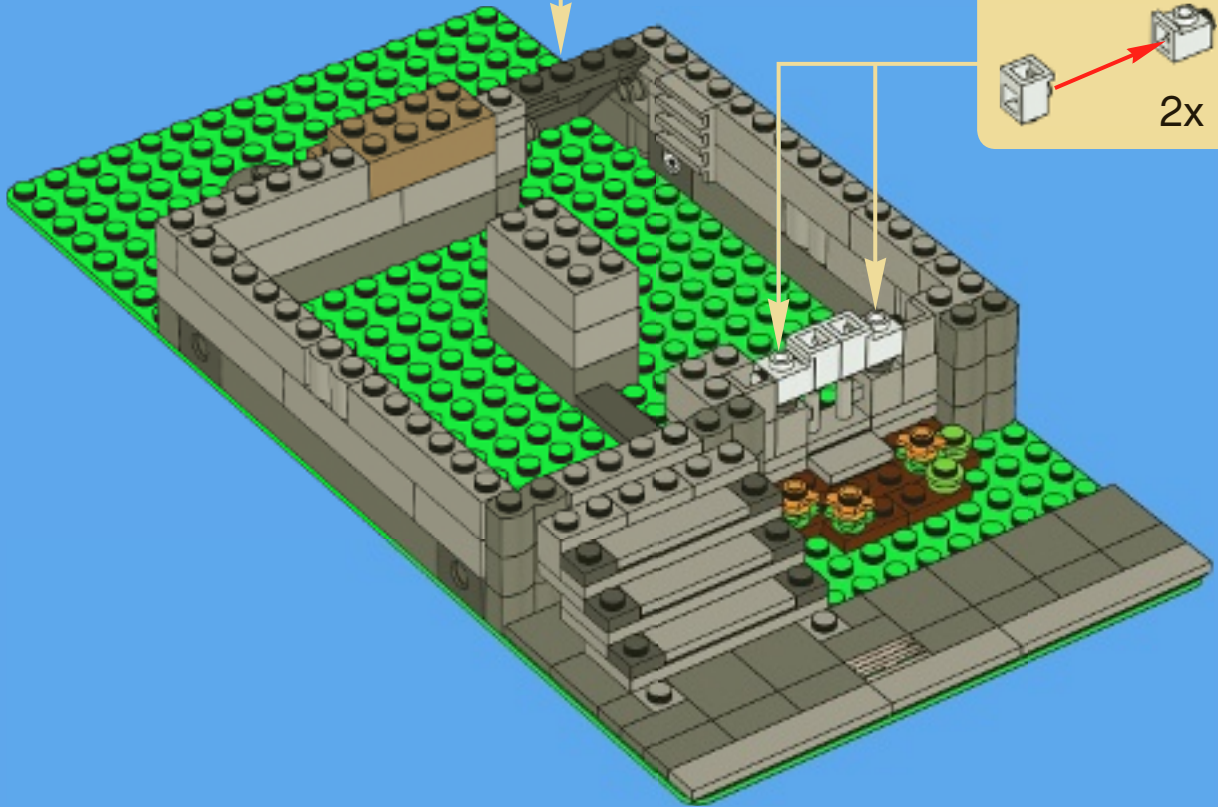
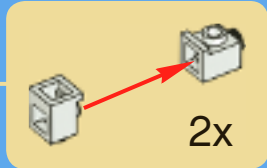
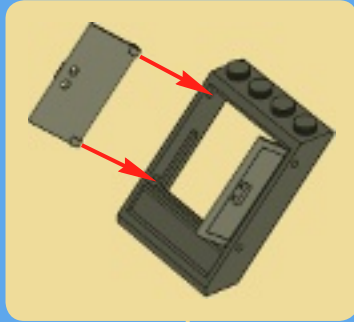

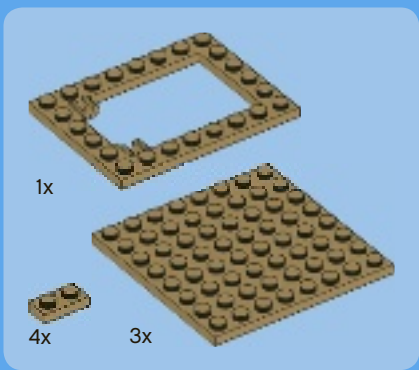

12

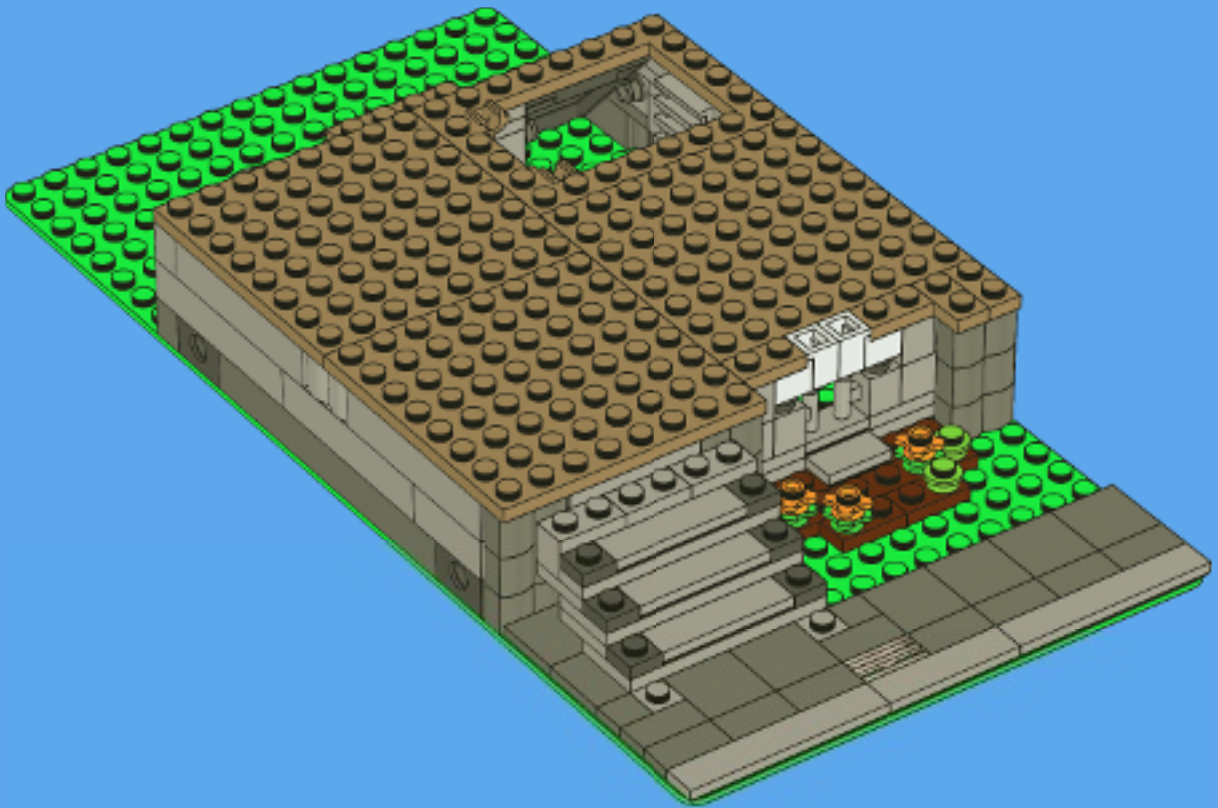

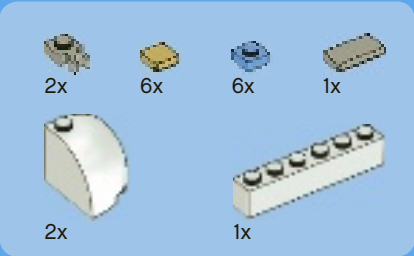

13

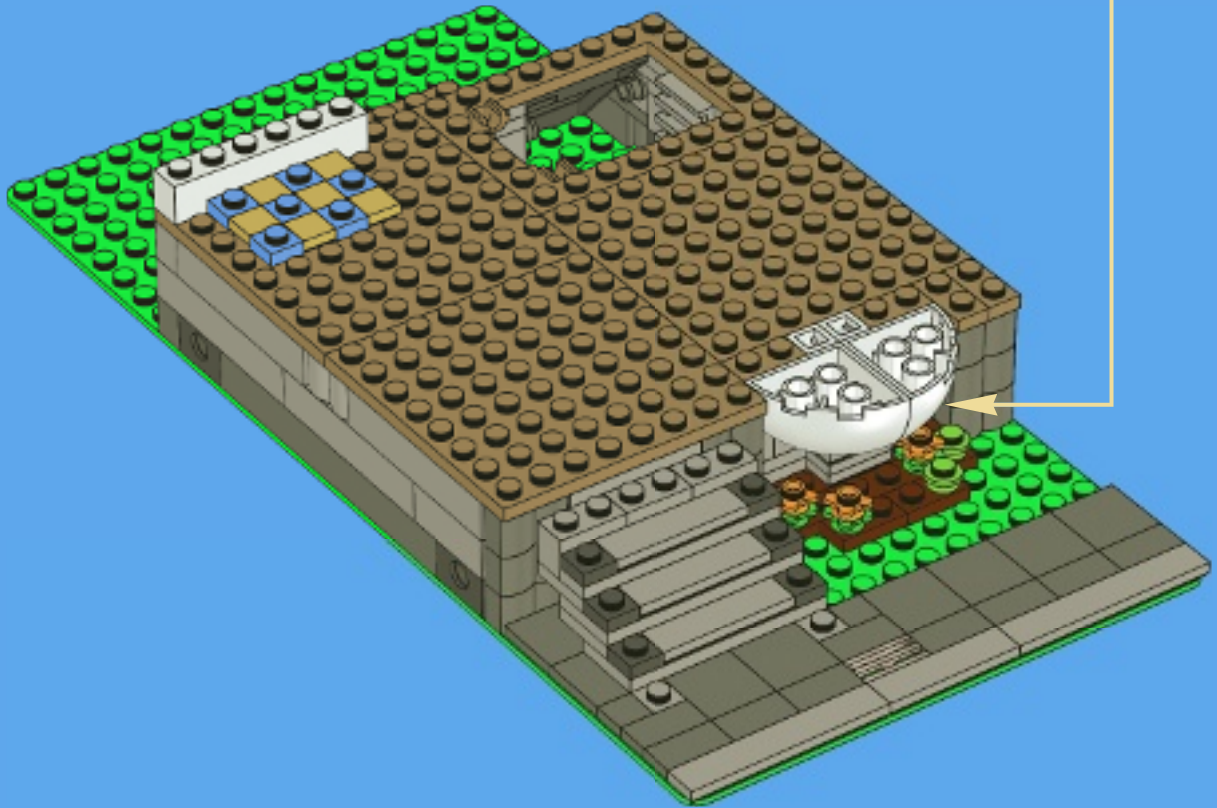
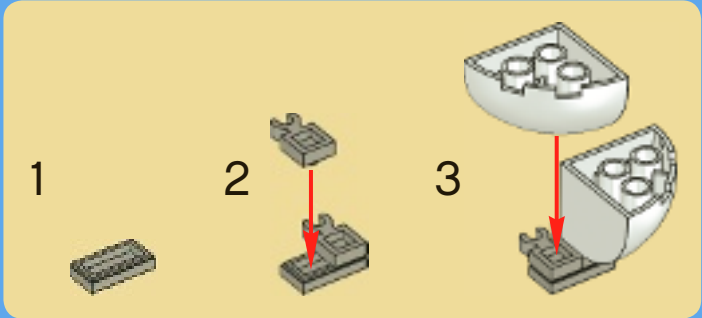

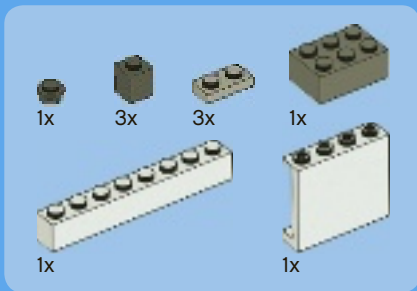

15

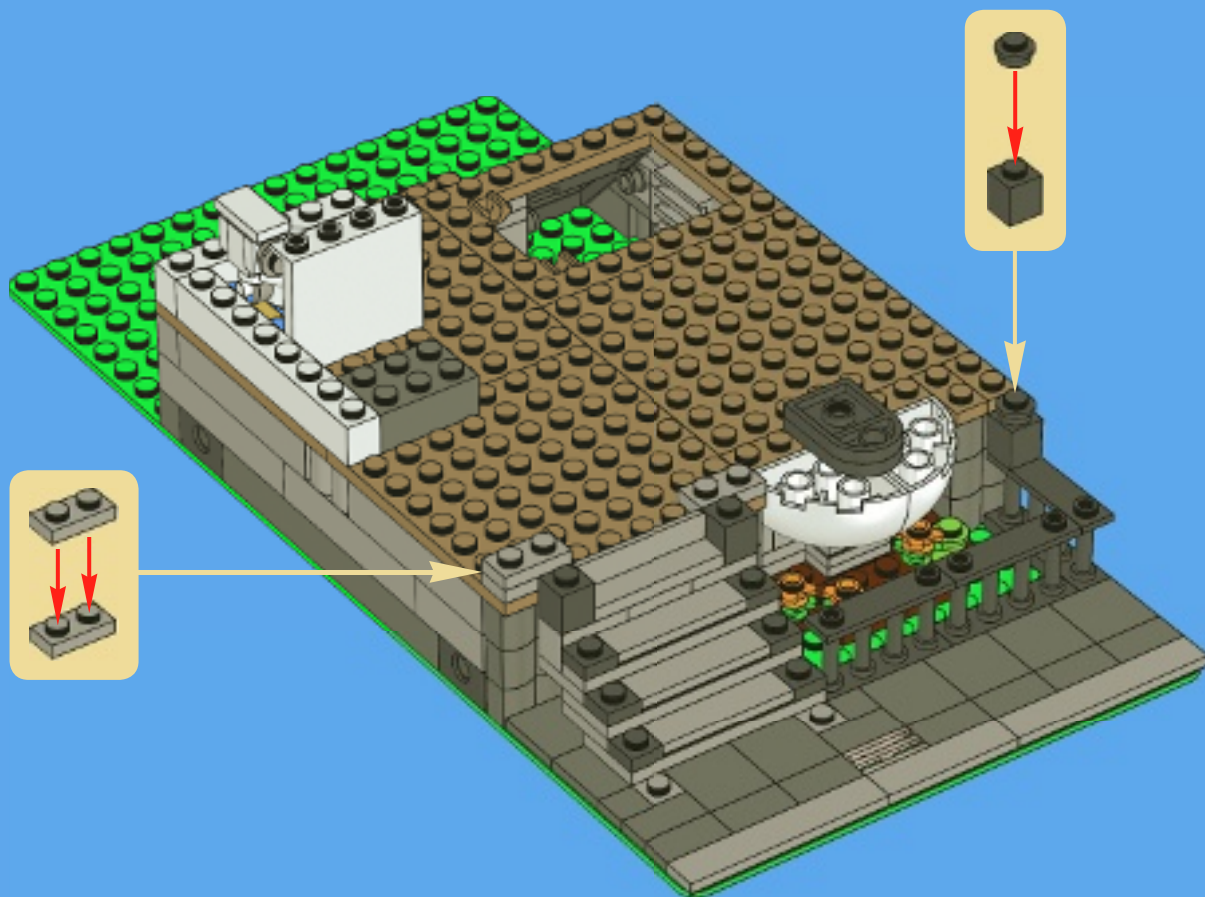

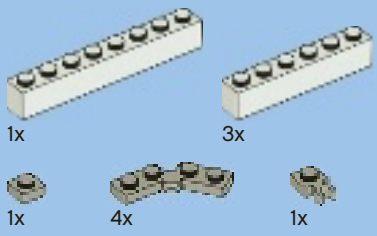

16

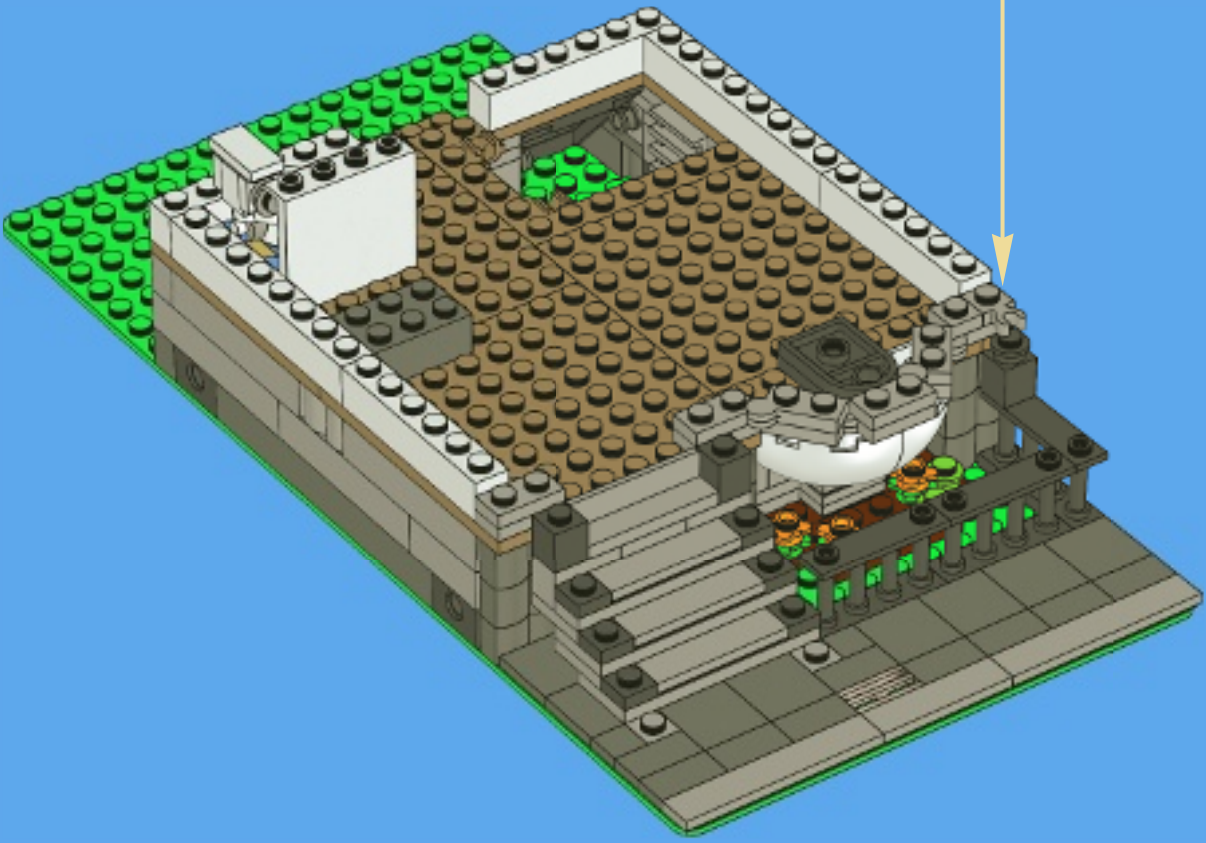
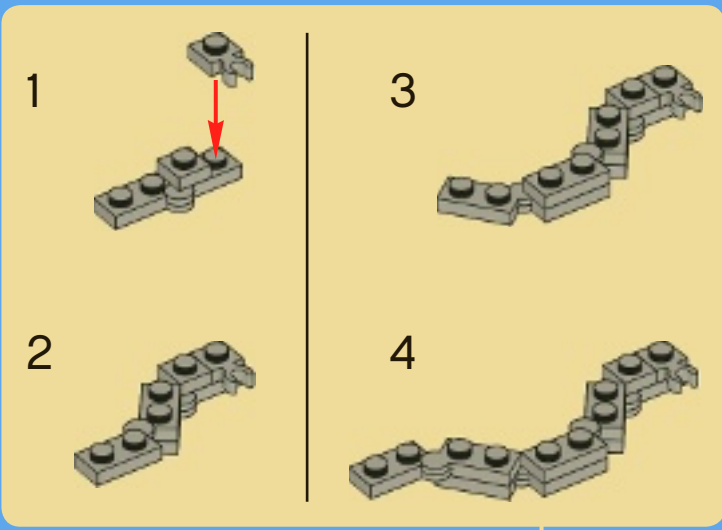



3x



1x



1x



6x



2x



4x

17

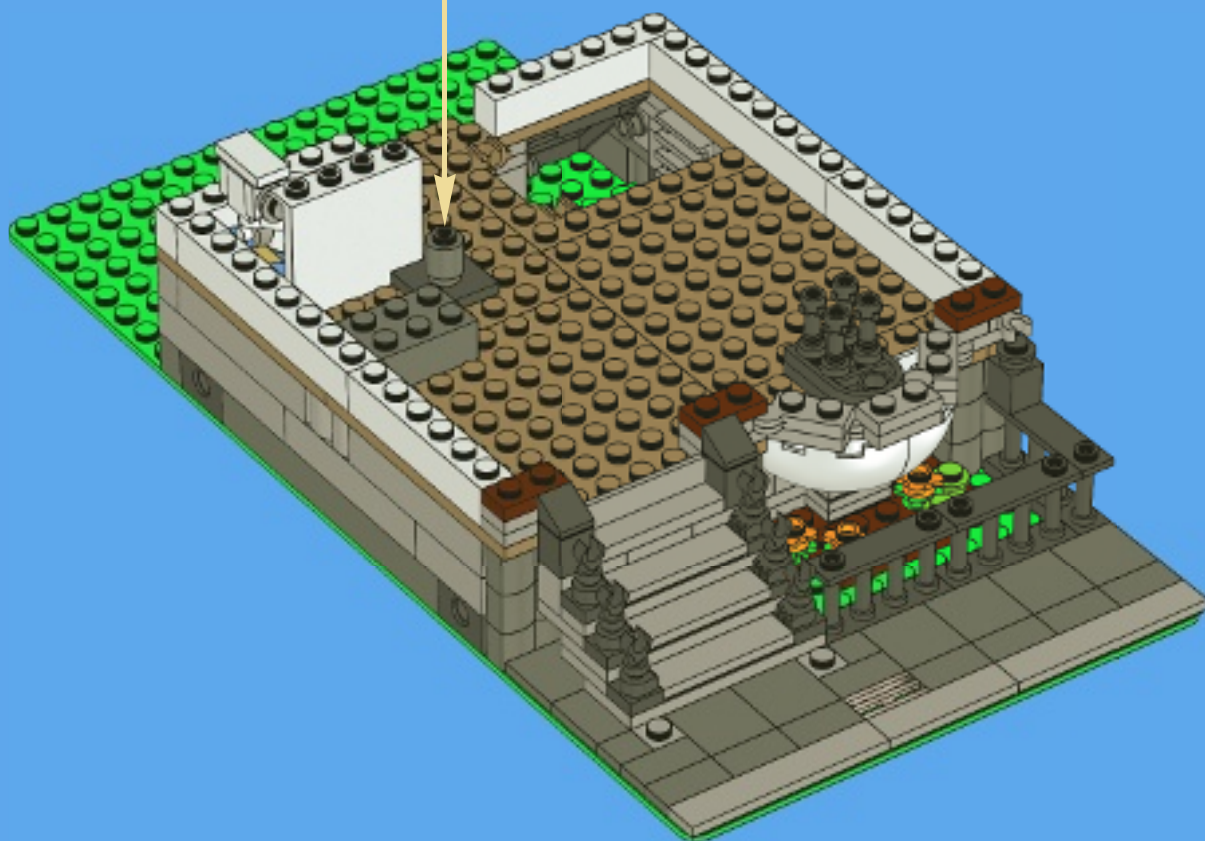
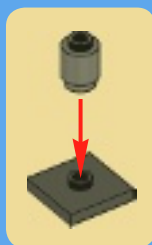

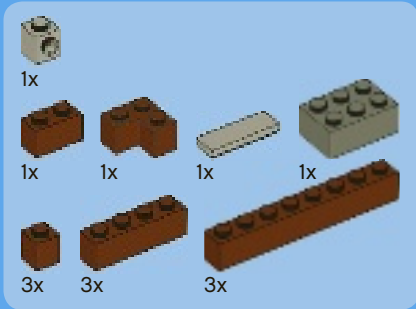

18



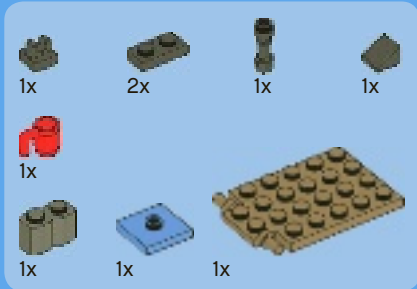

19

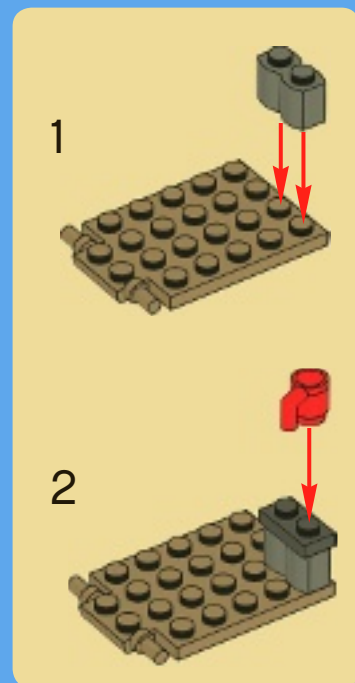
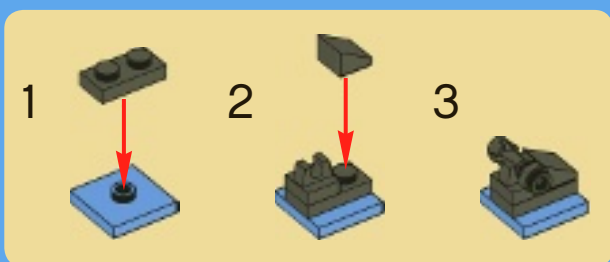

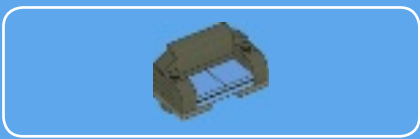

1

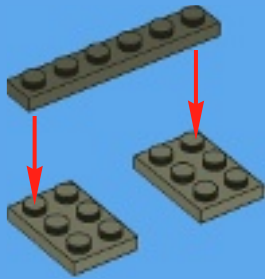

2

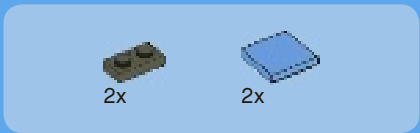
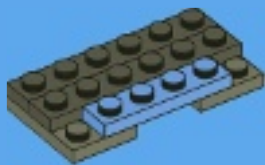

3

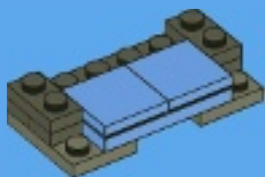

4

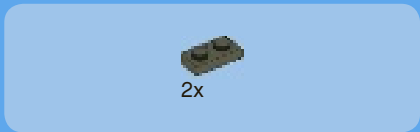
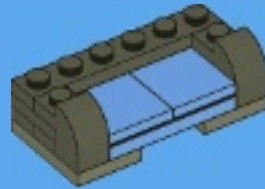

5

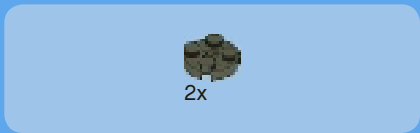
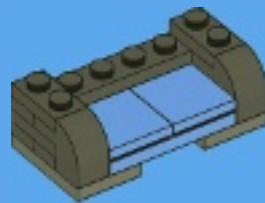

6





1x



2x

7

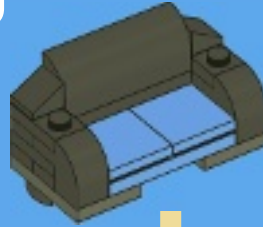

20



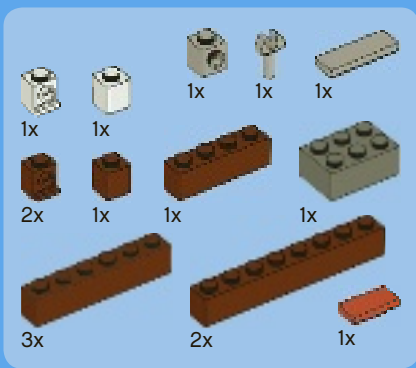

21

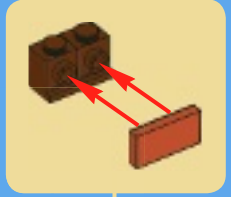
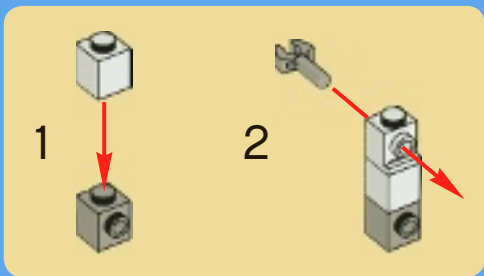

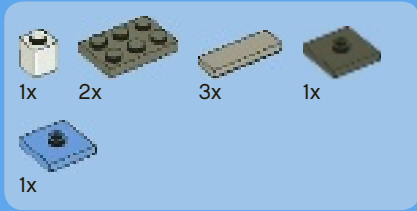

22

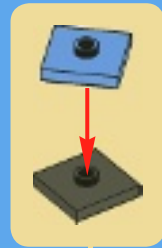
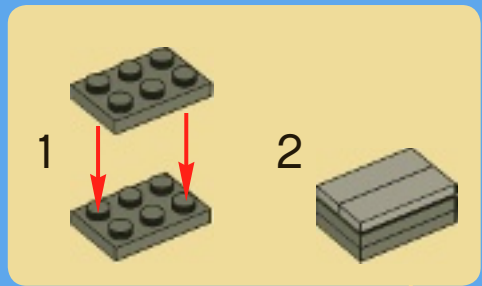

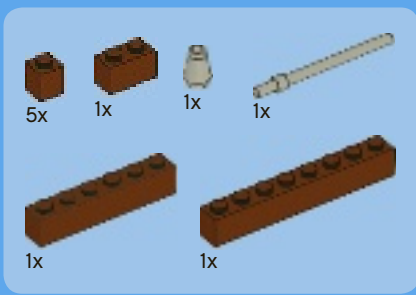

23

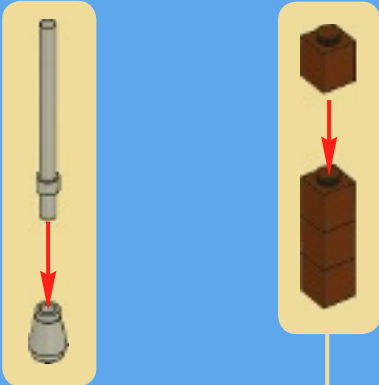

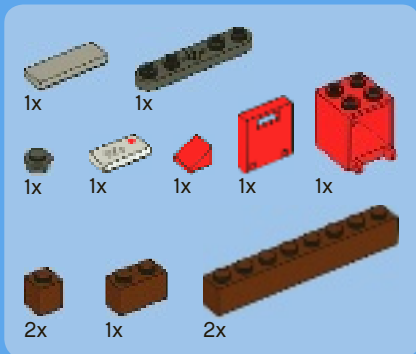

24

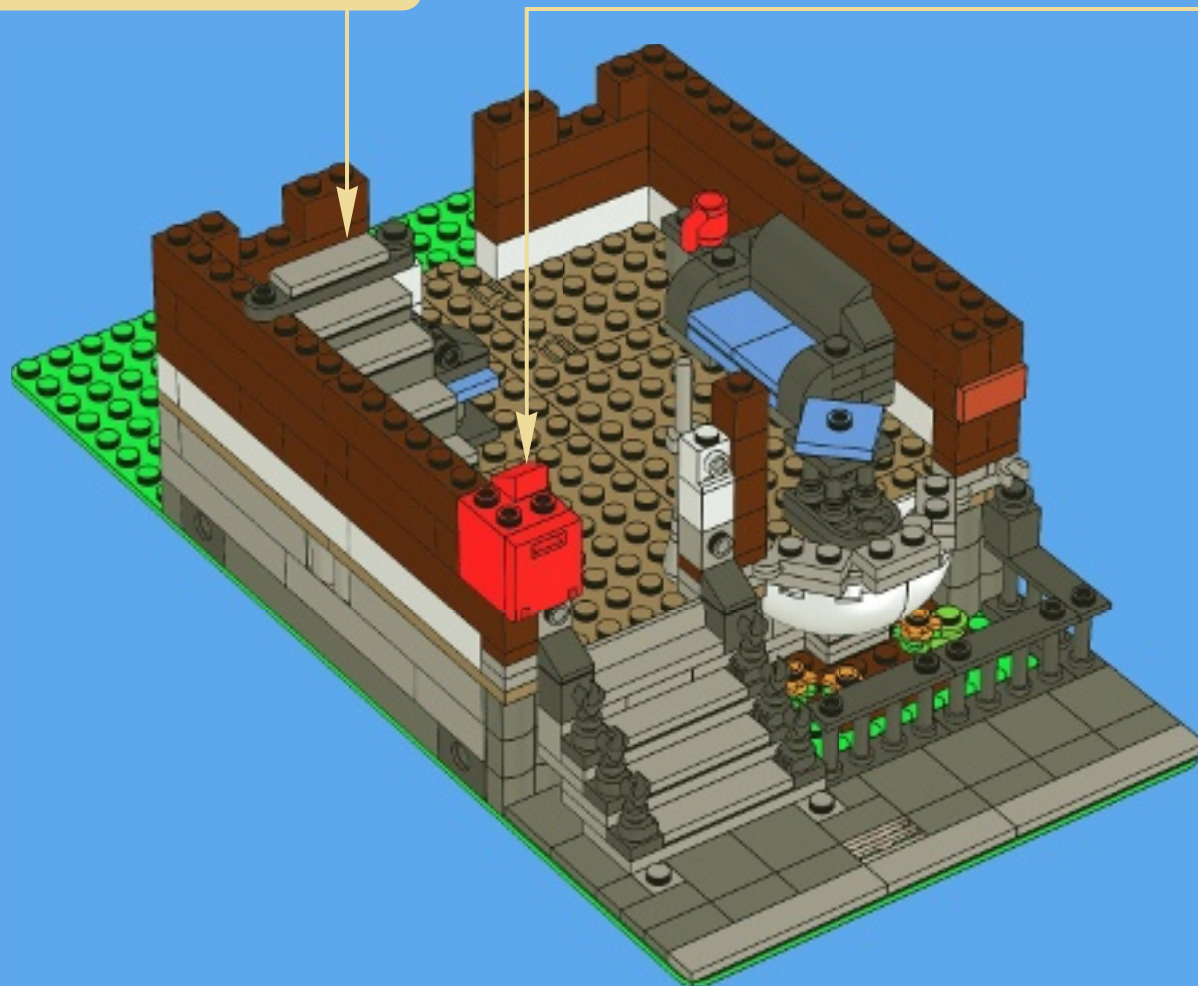
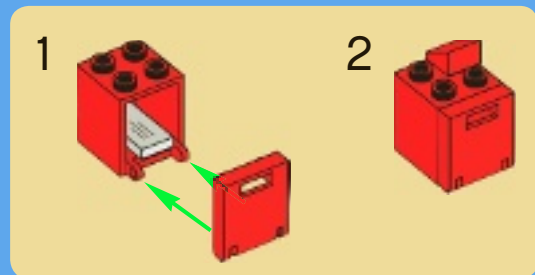
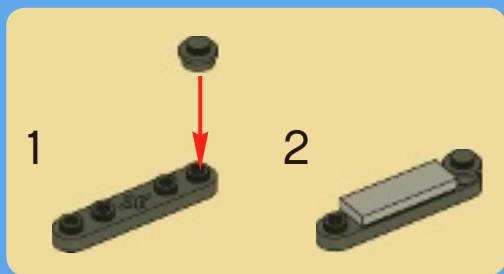

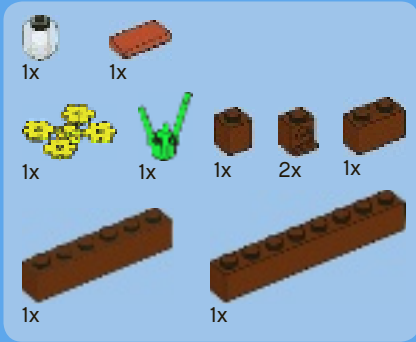

25

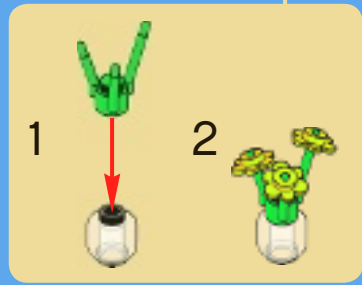
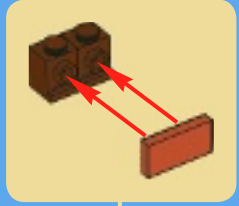
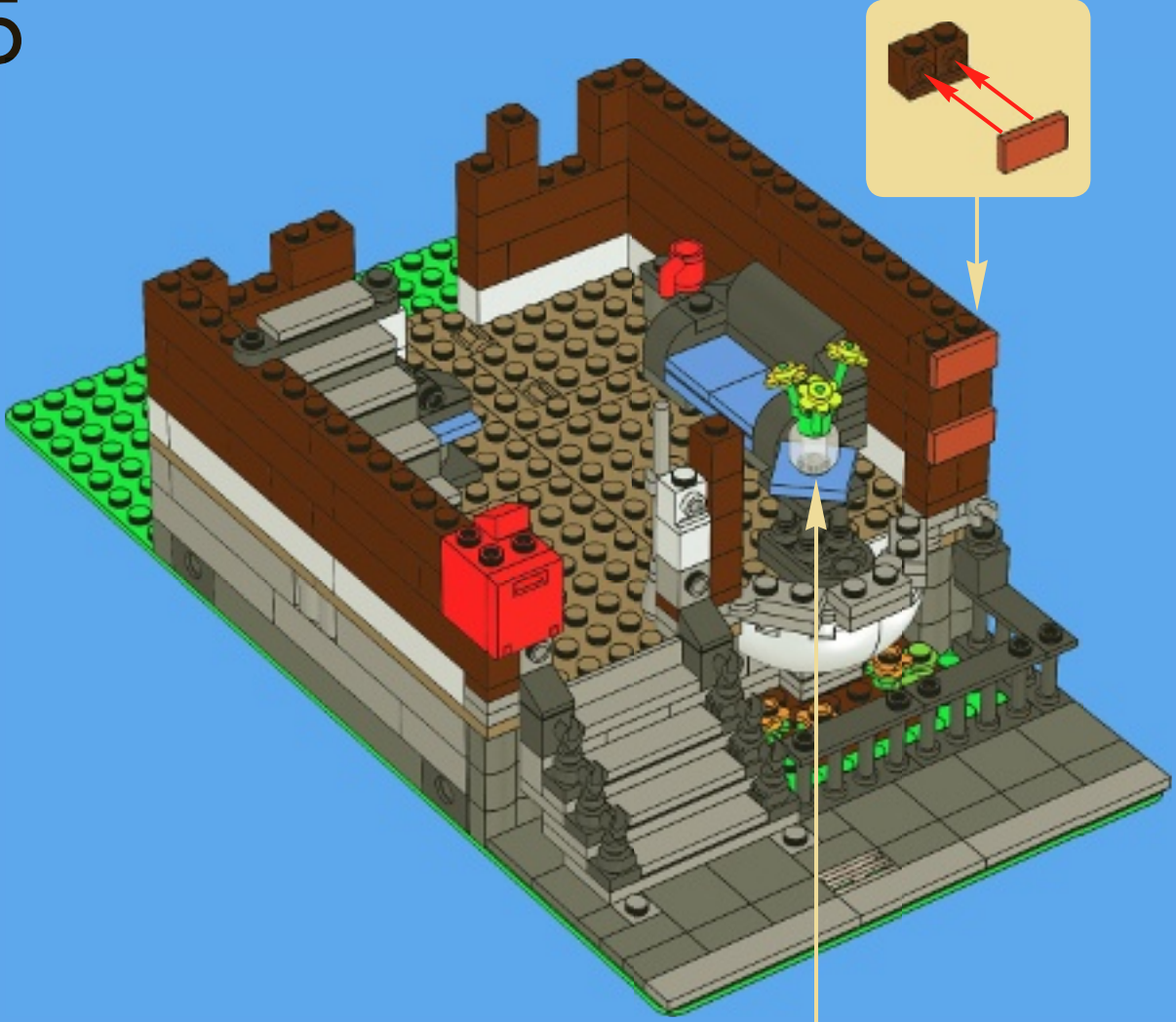



26

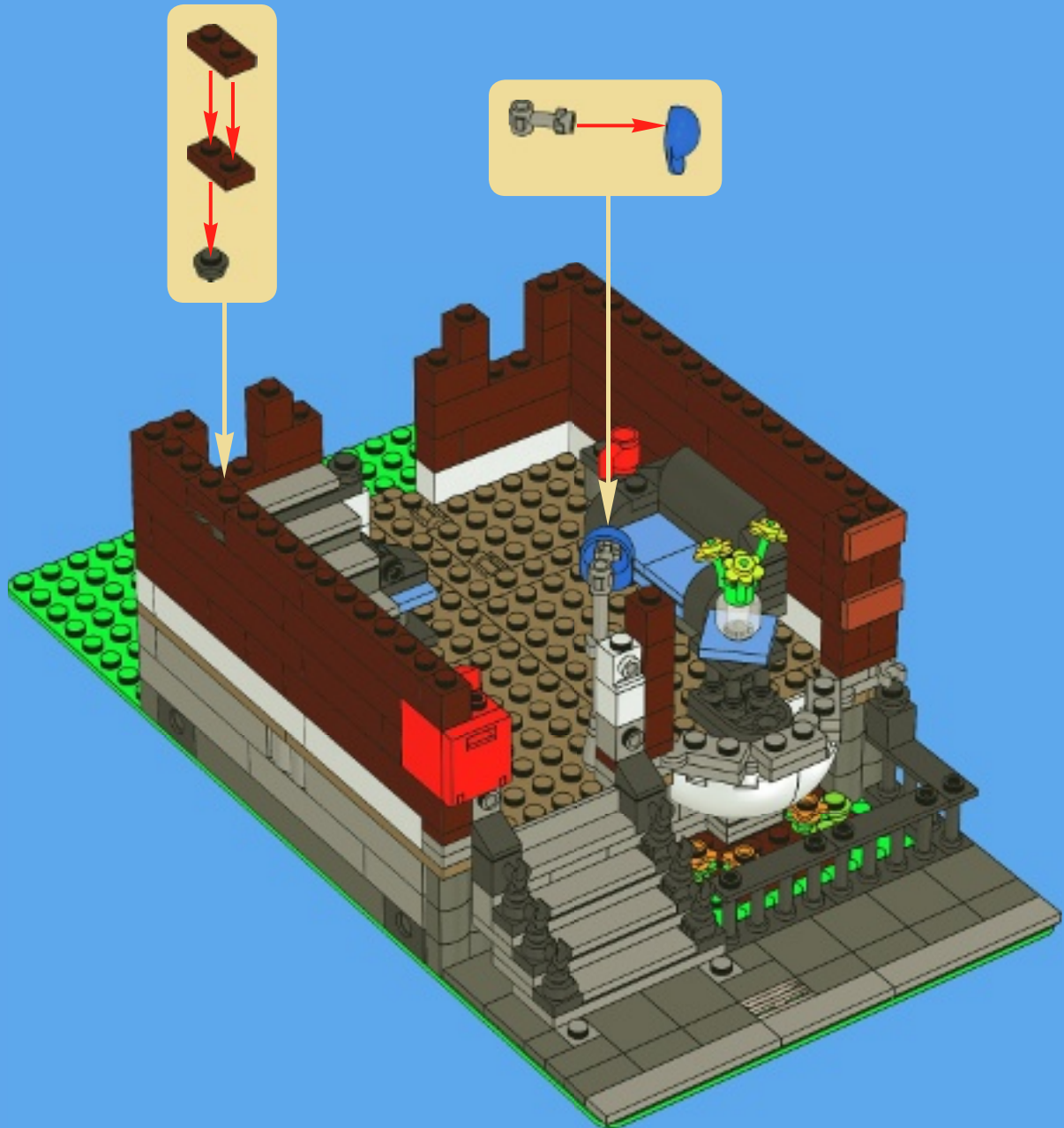



2x



2x



4x

27

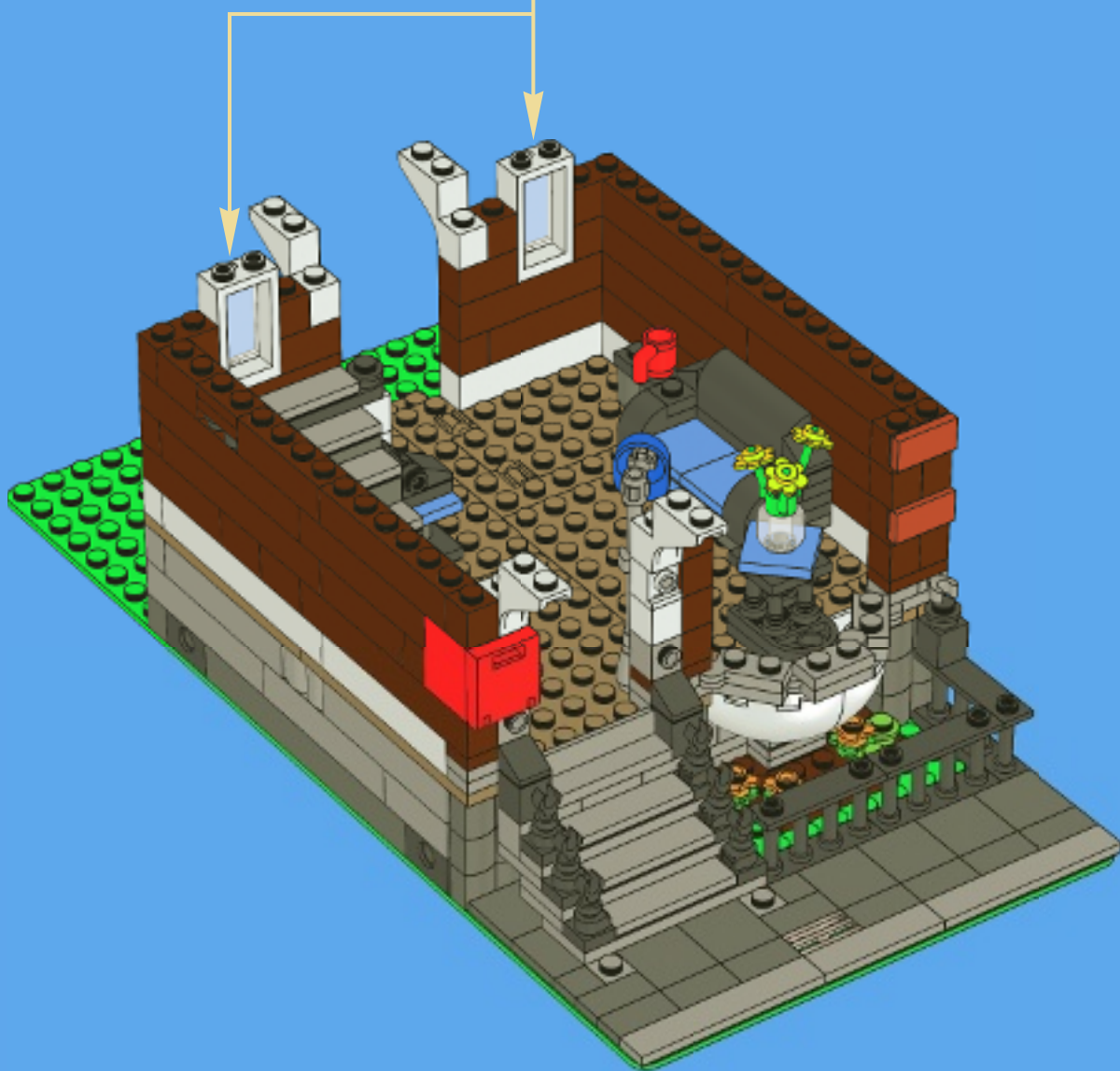
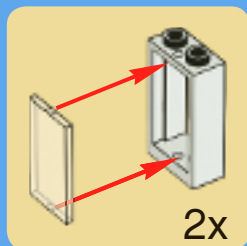

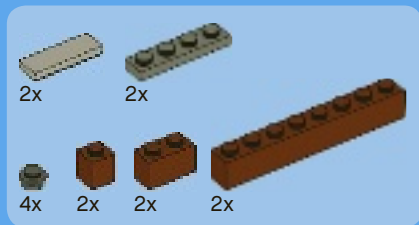

28

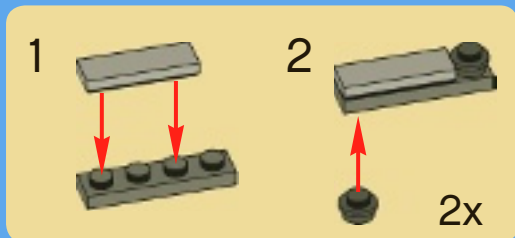

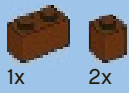

1x 2x

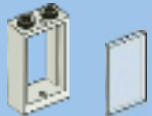

6x 6x



2x

29

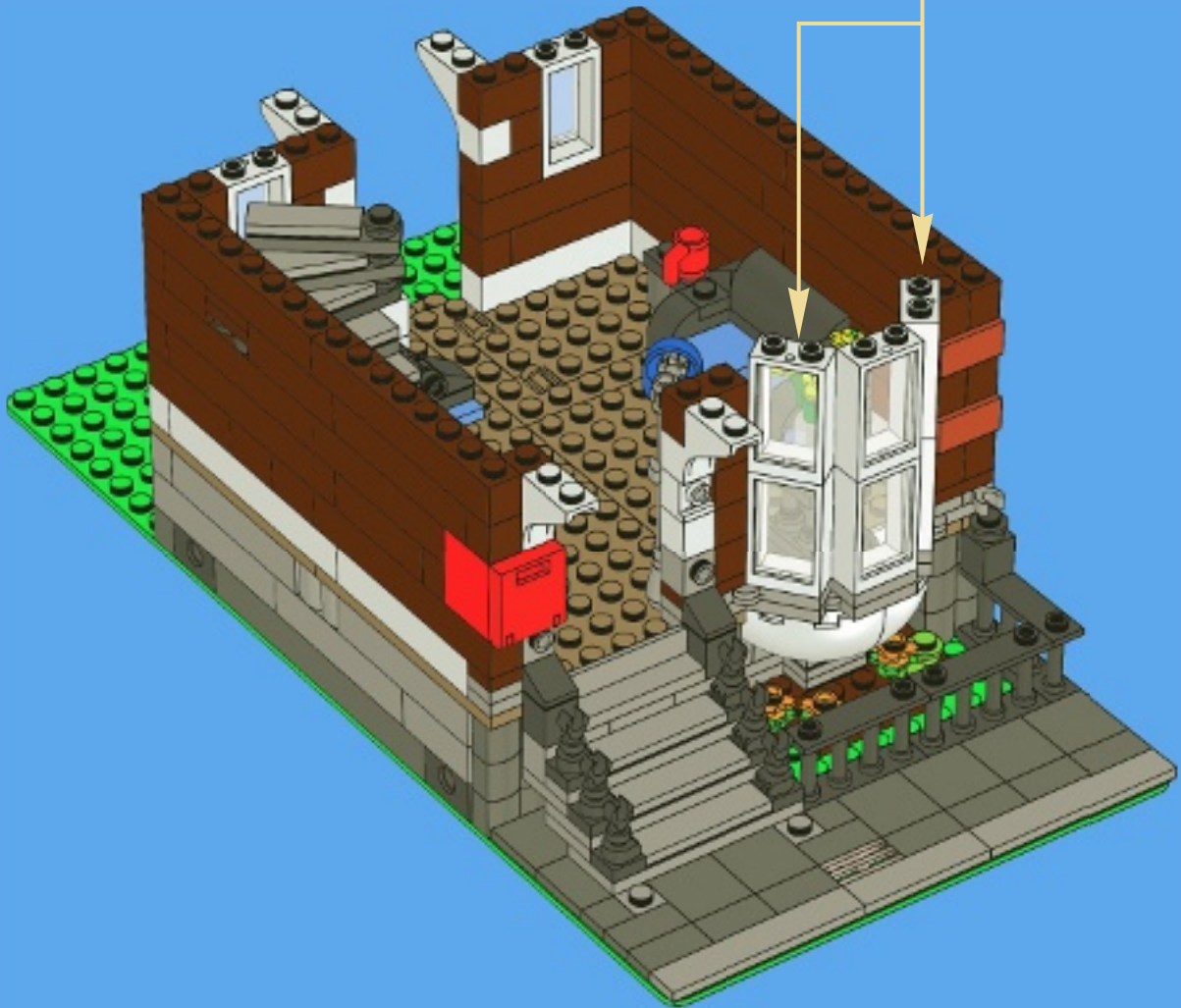
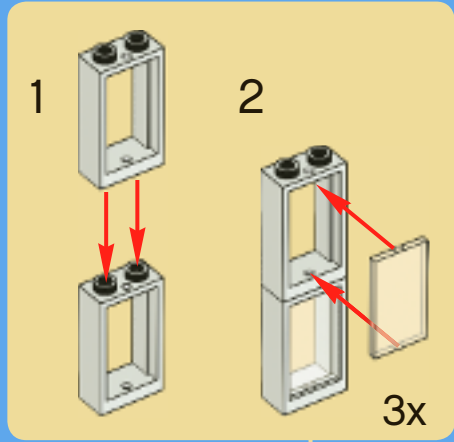

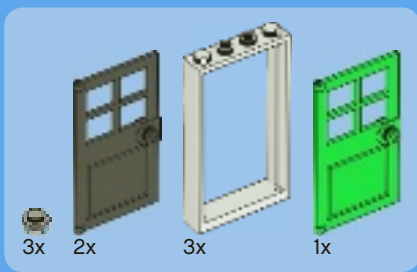

30

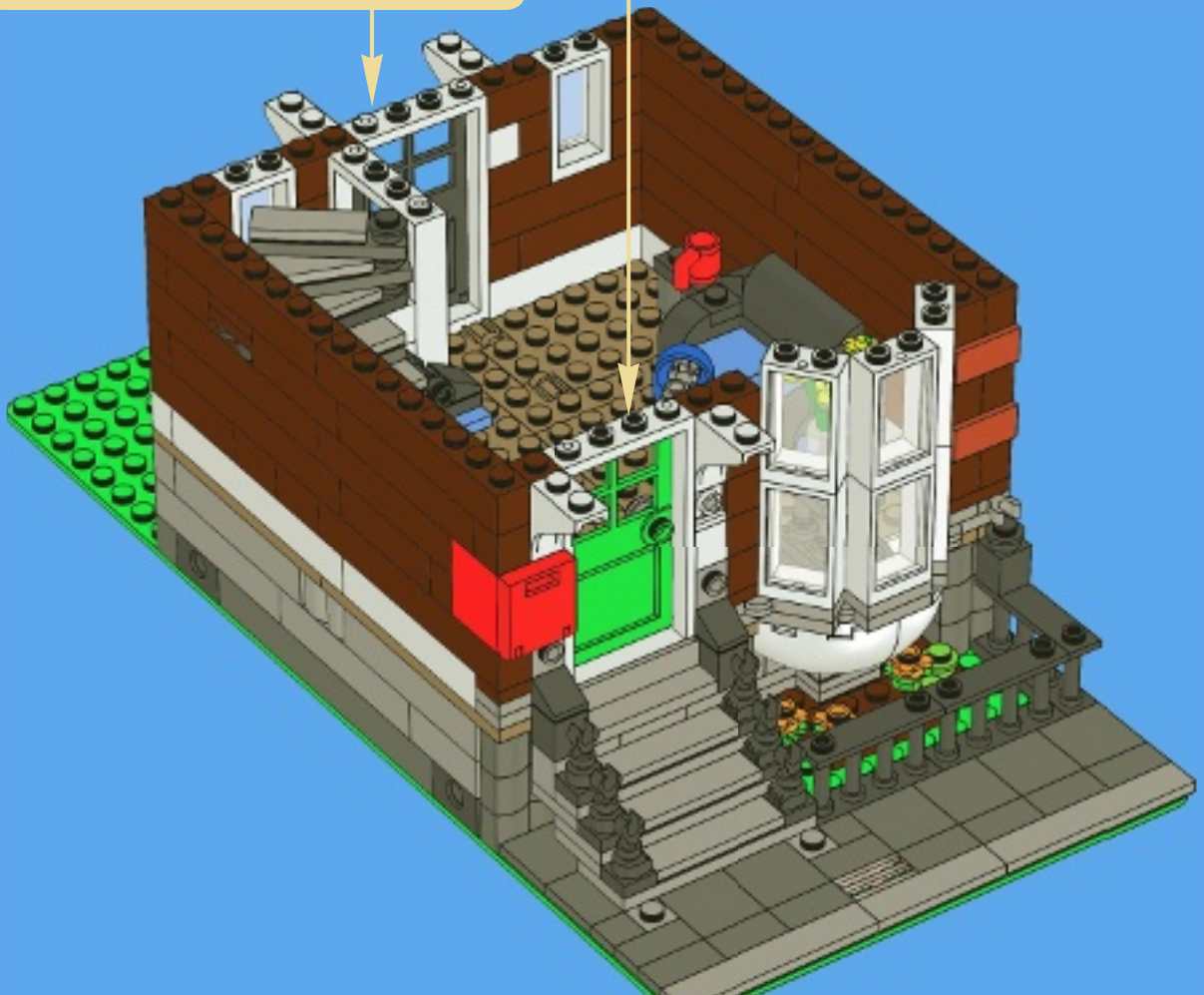
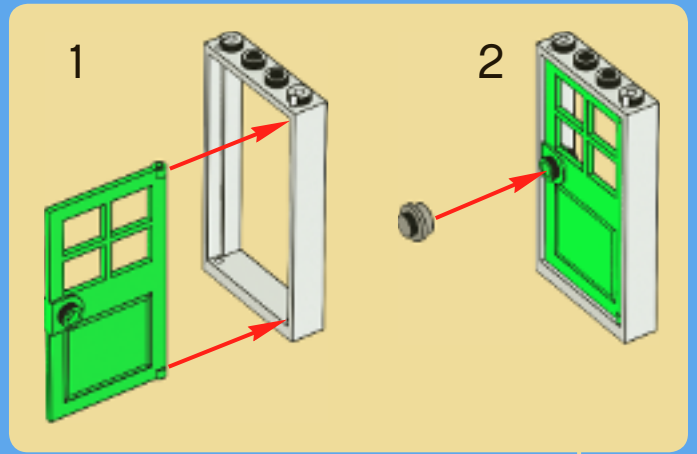
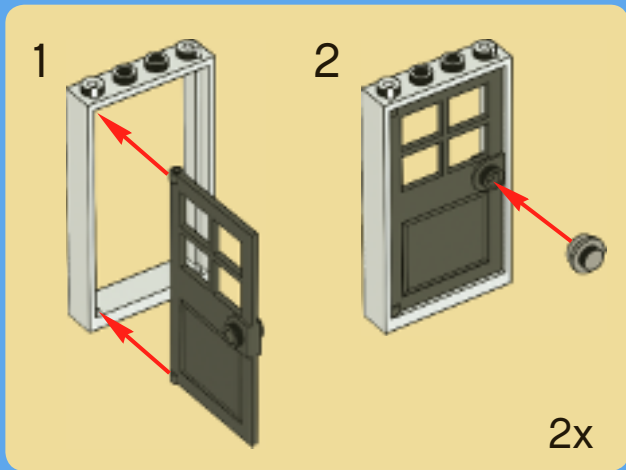

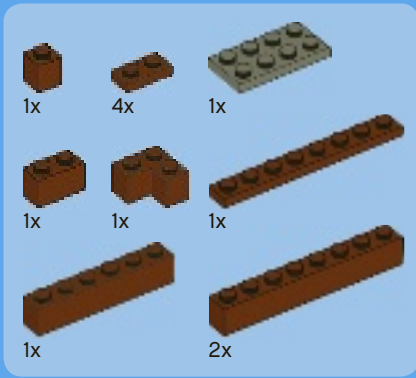

31

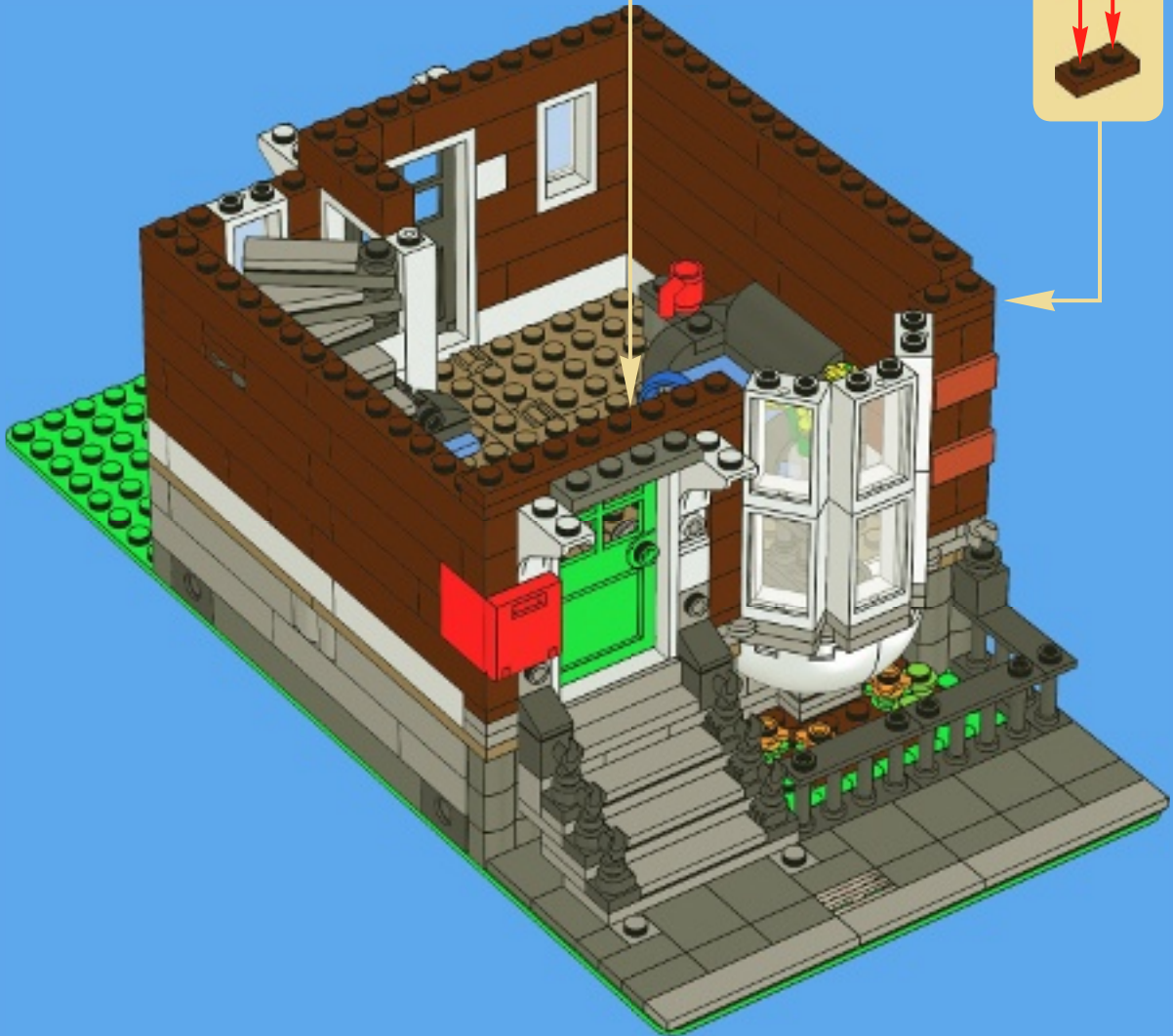
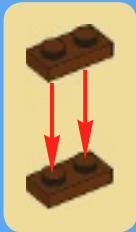
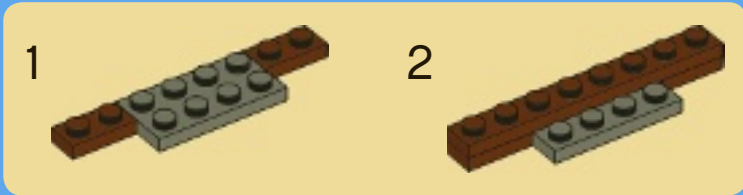

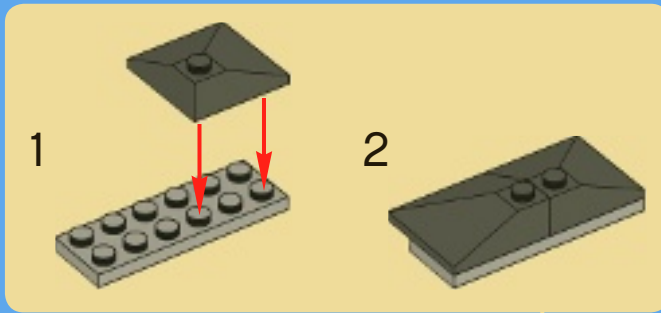
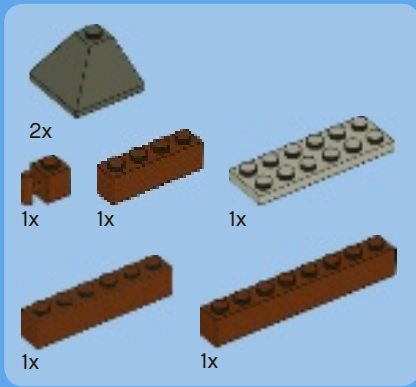

32

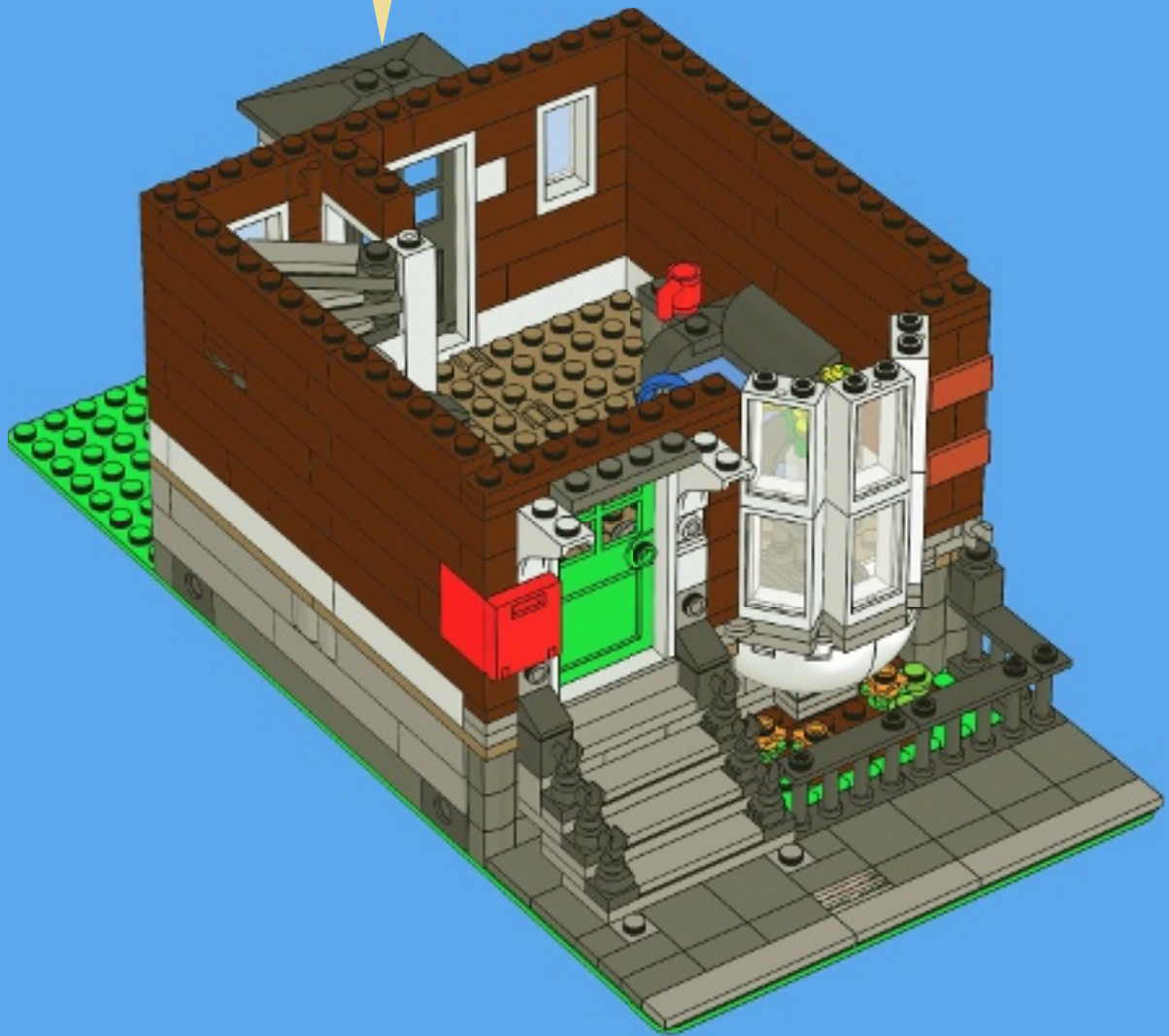

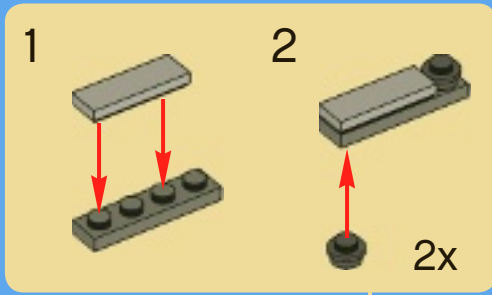
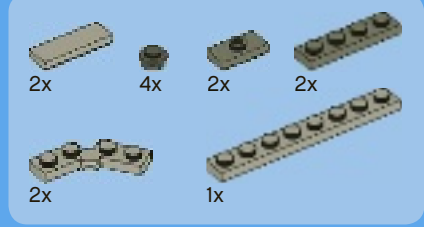

33

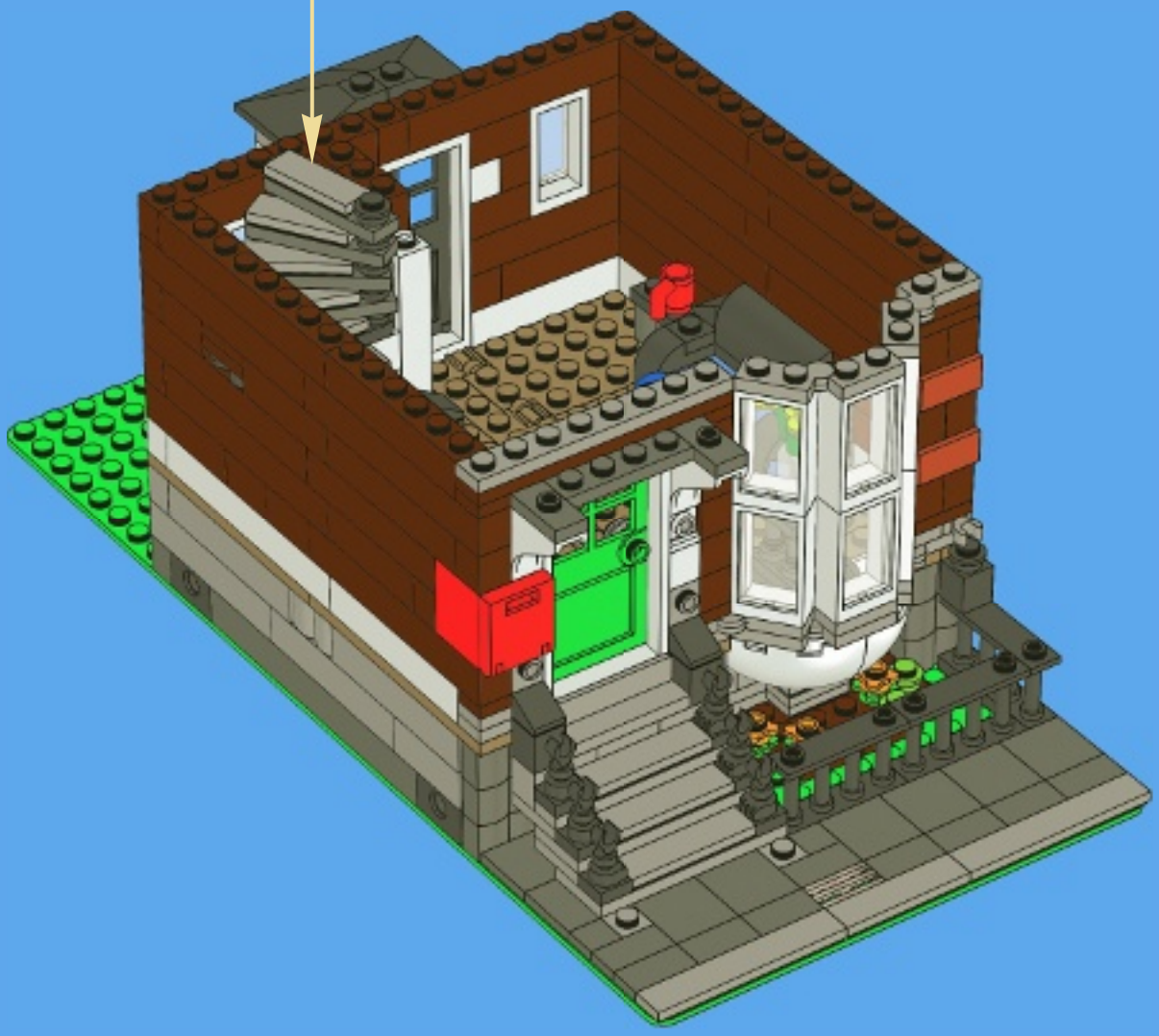



34

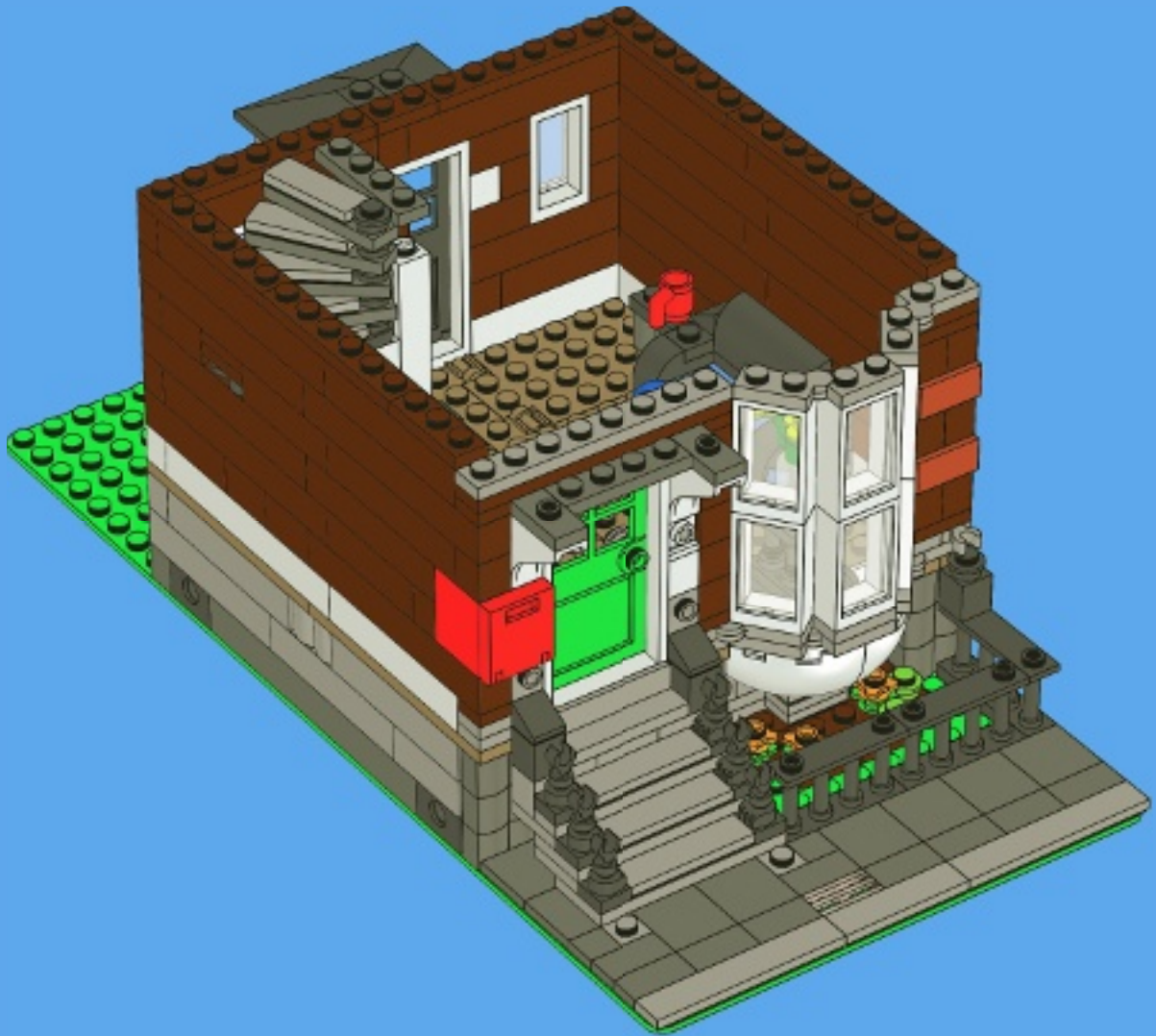

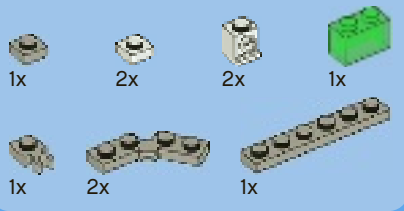

35

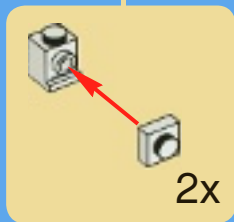
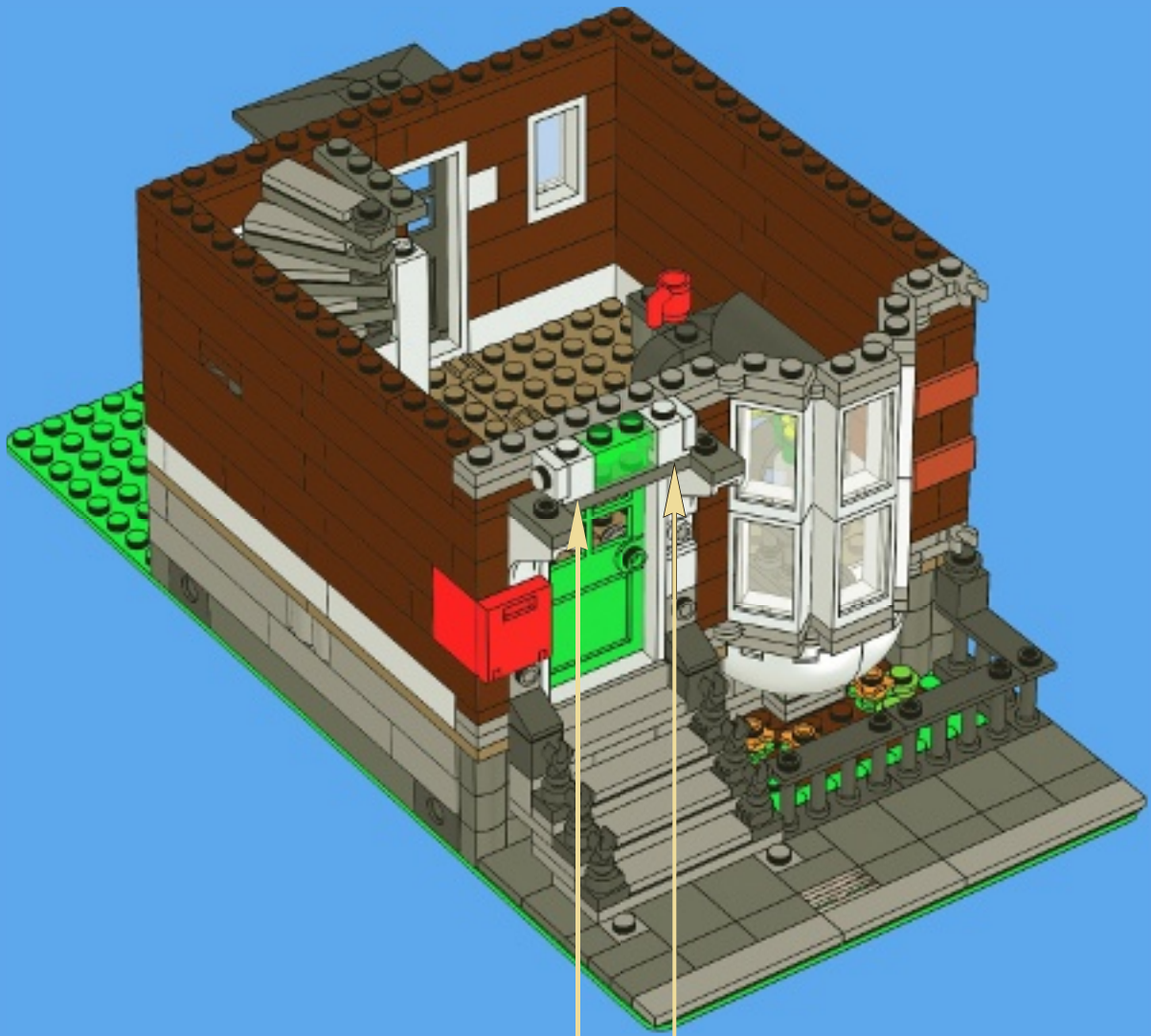

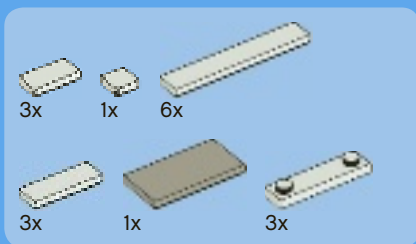

36

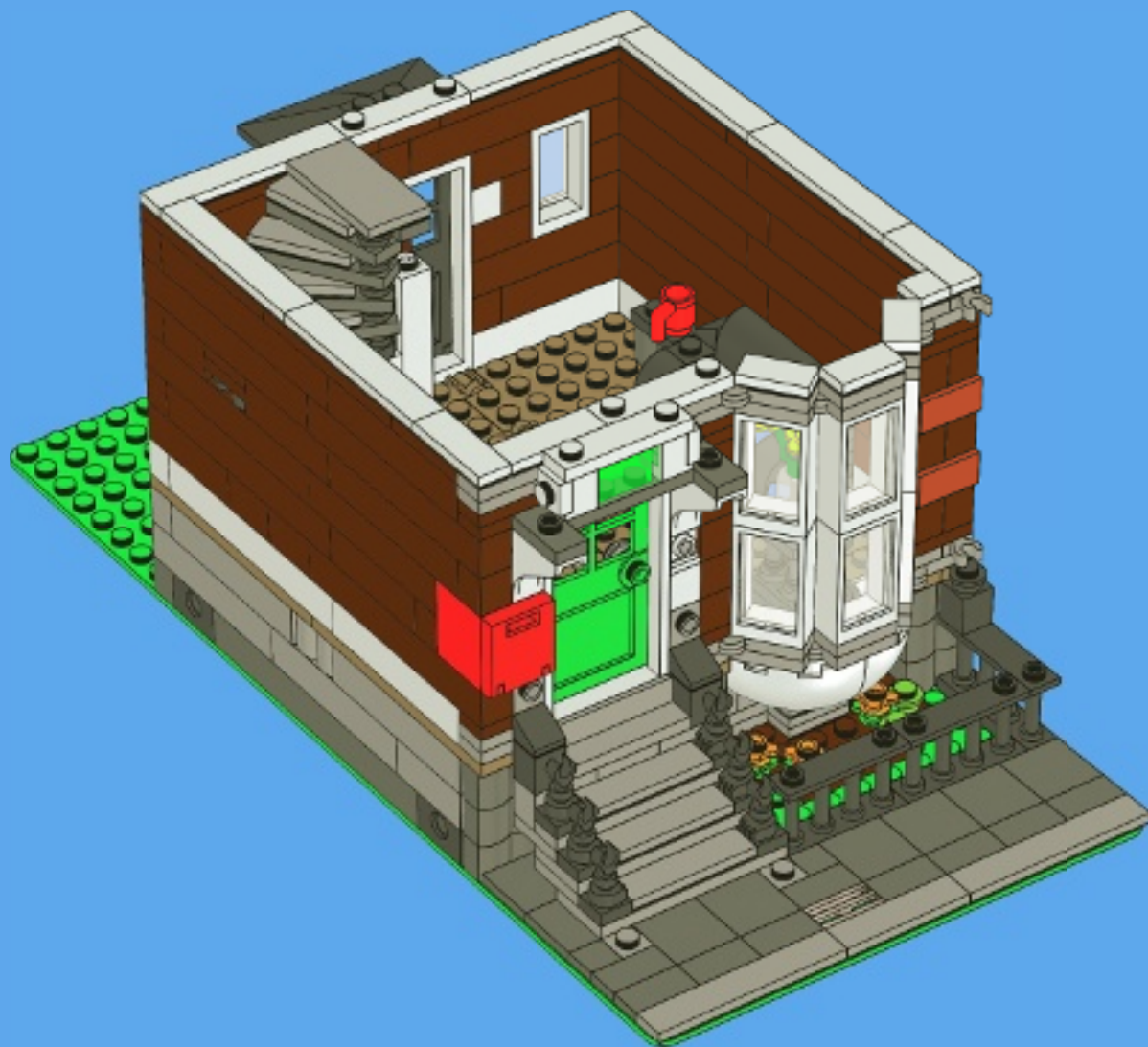

2x

4x

2x

37

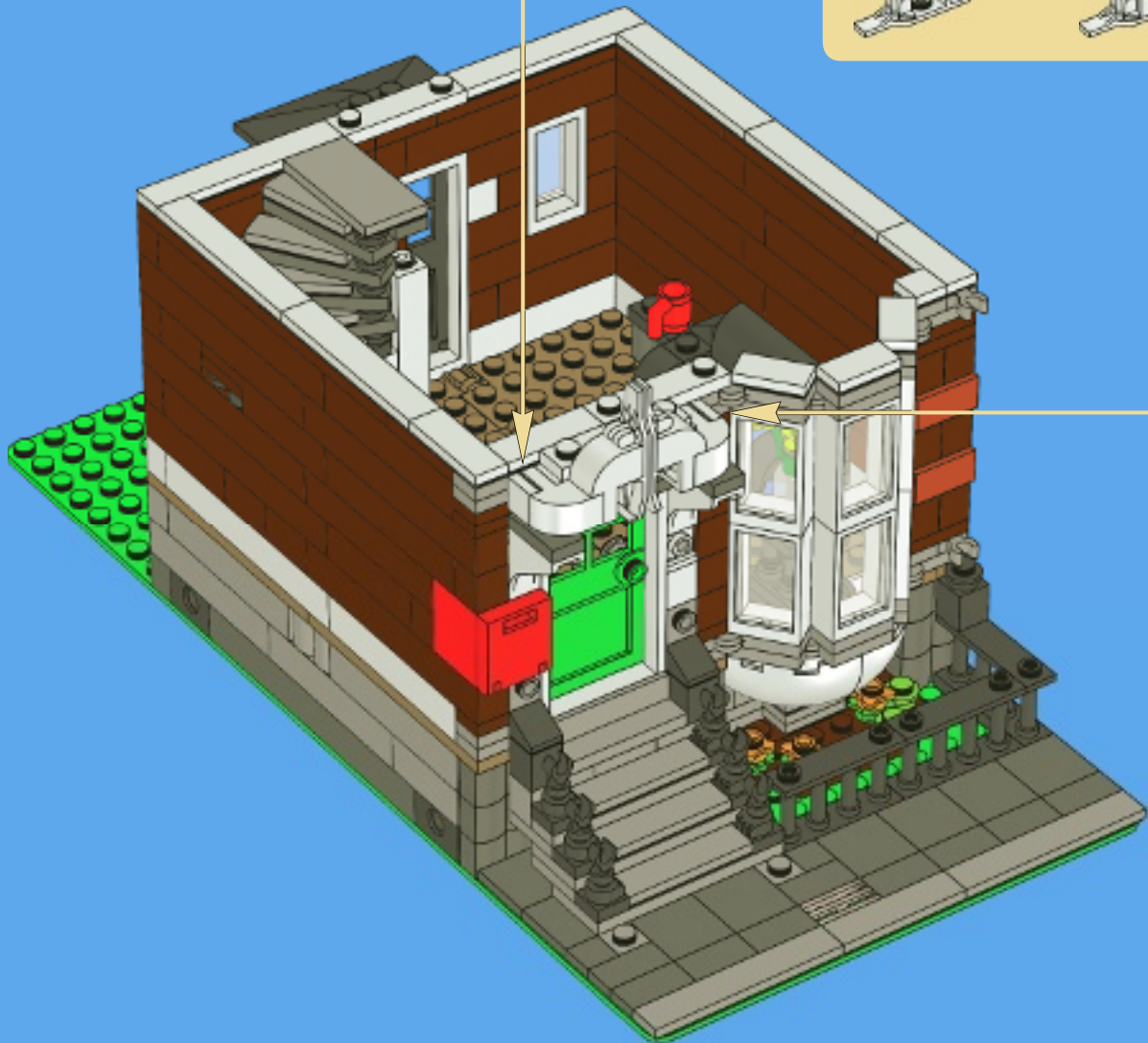
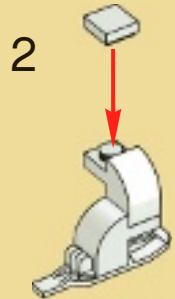
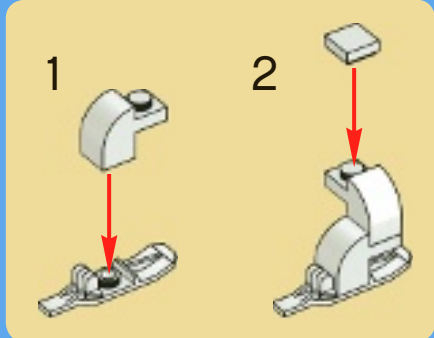
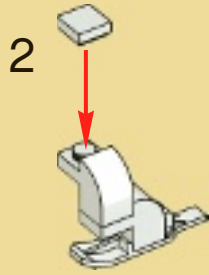
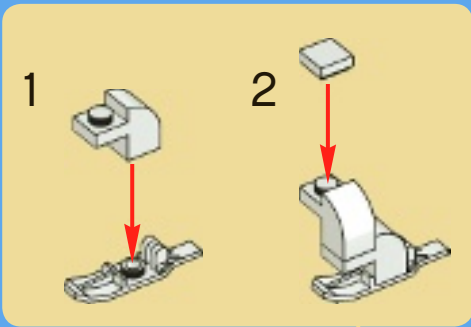

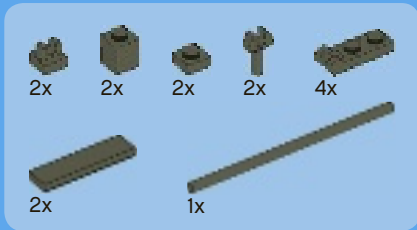

38

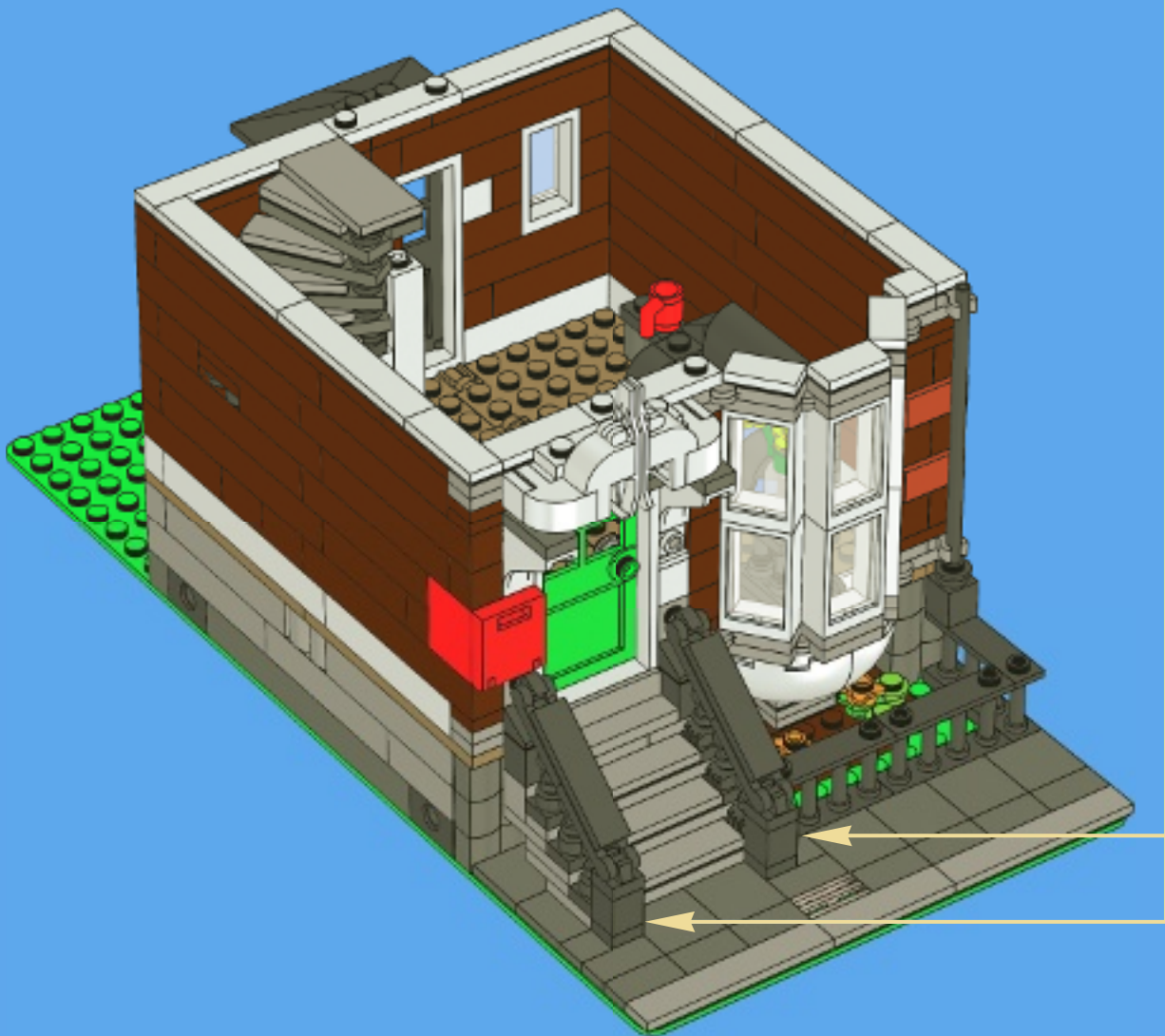
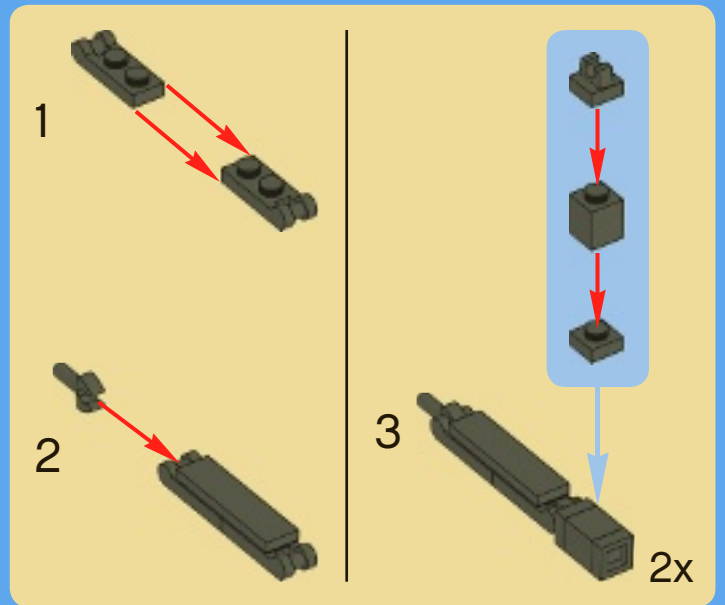

39

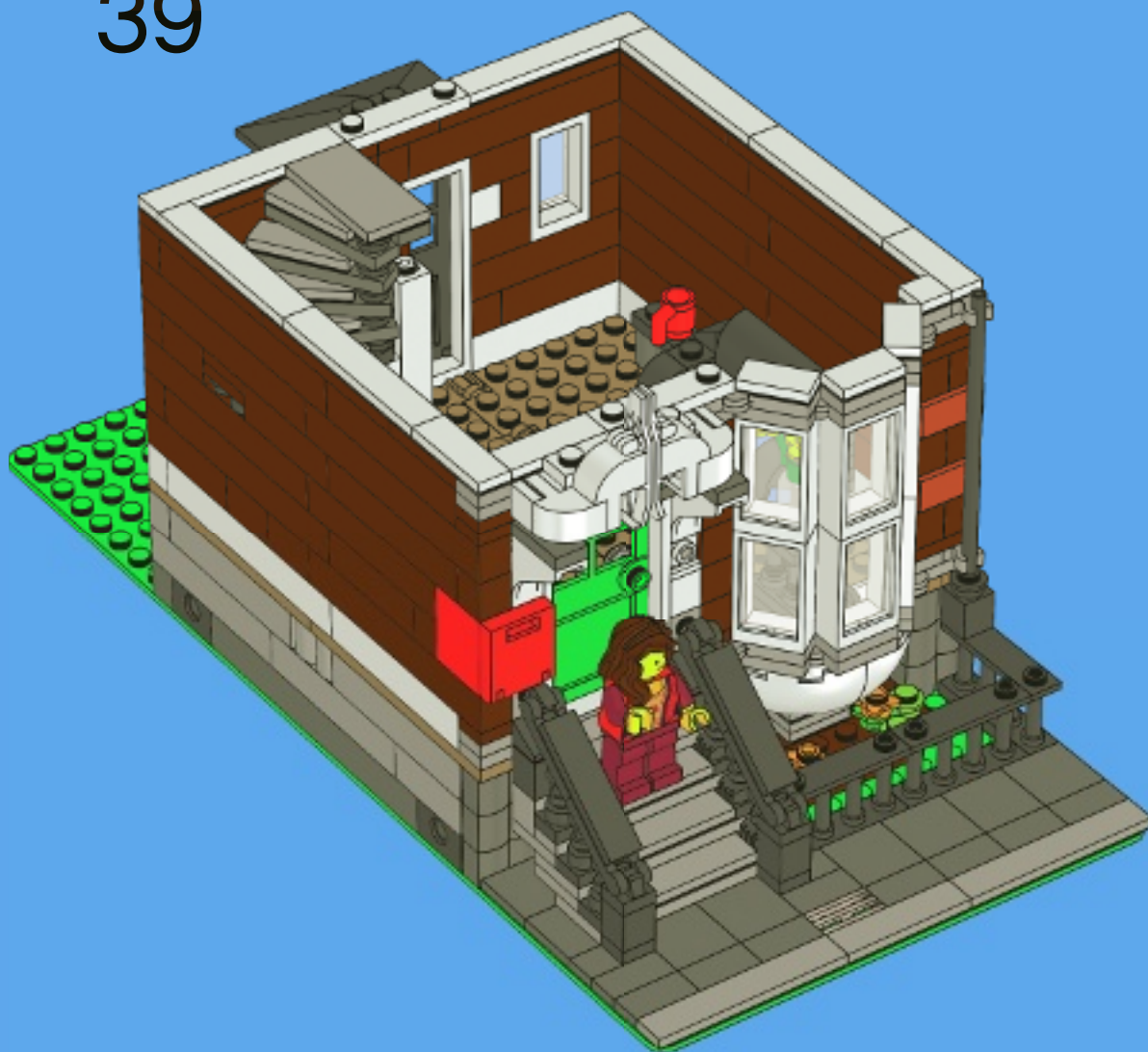

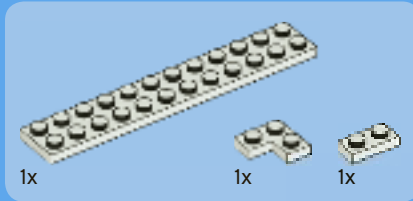
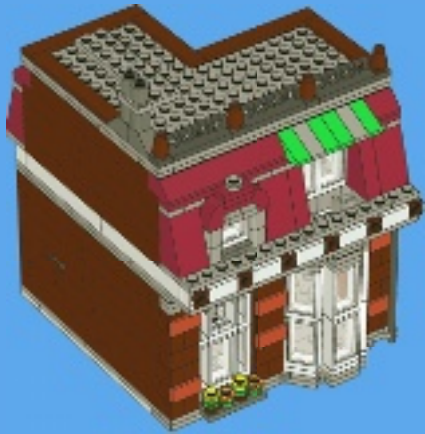

1

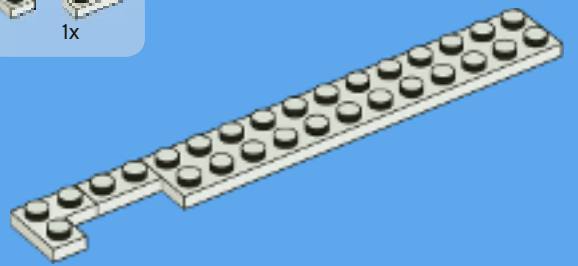

2

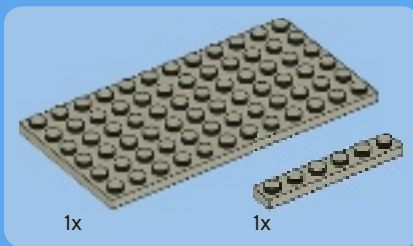
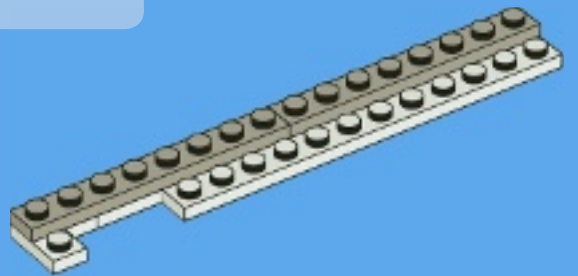

3

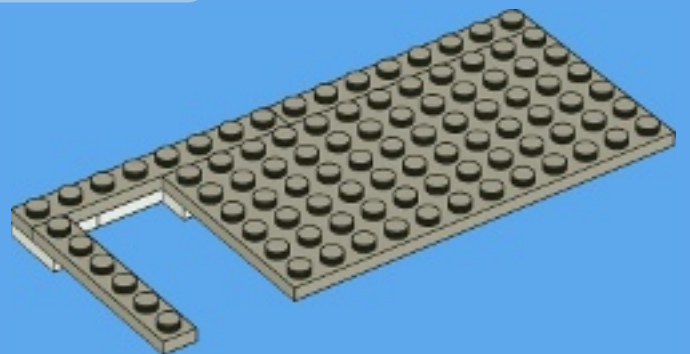

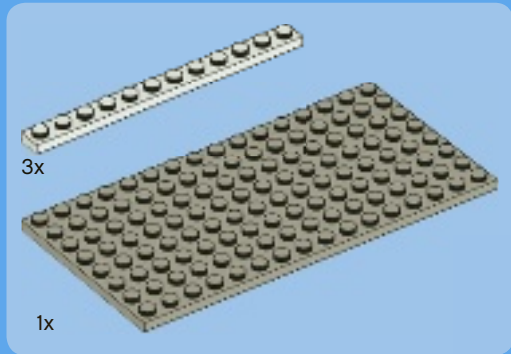

4

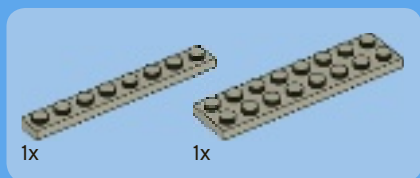
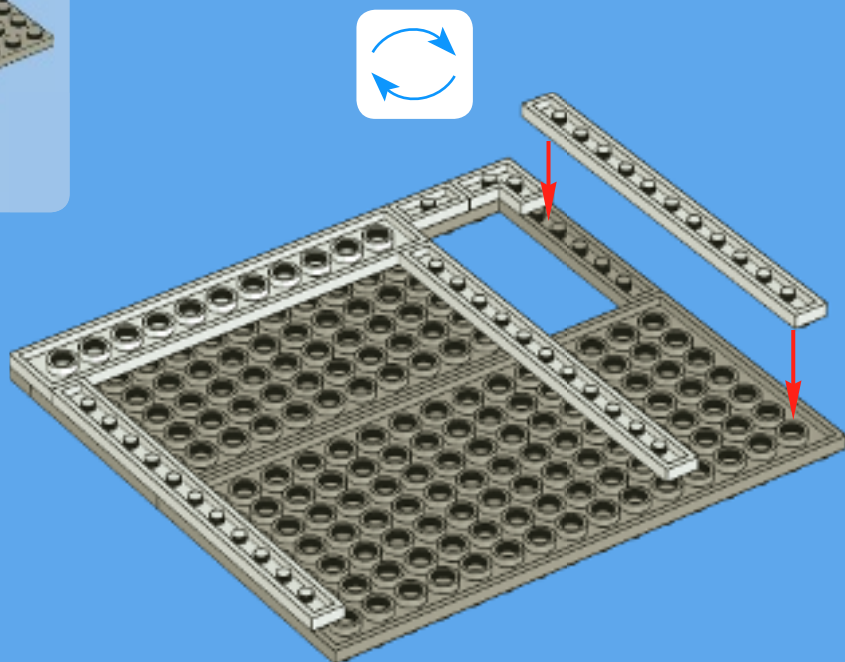

5

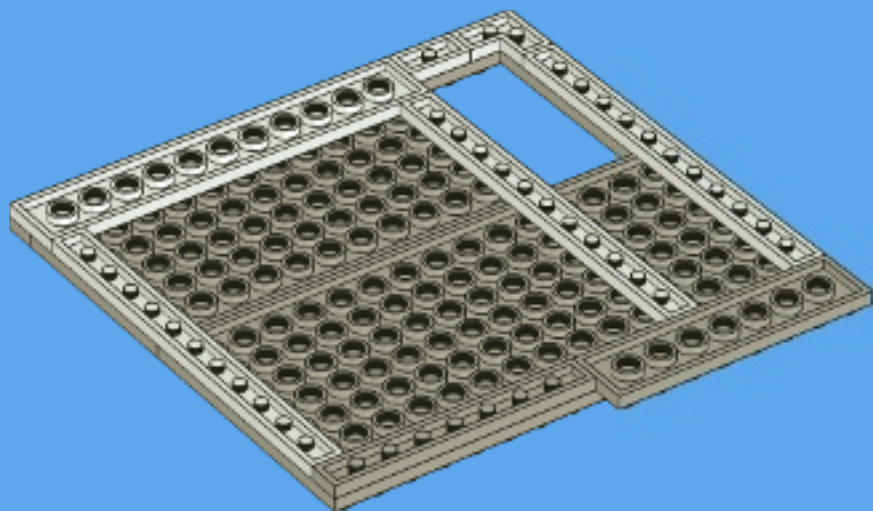

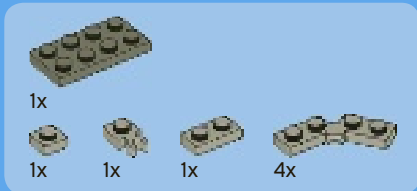

6

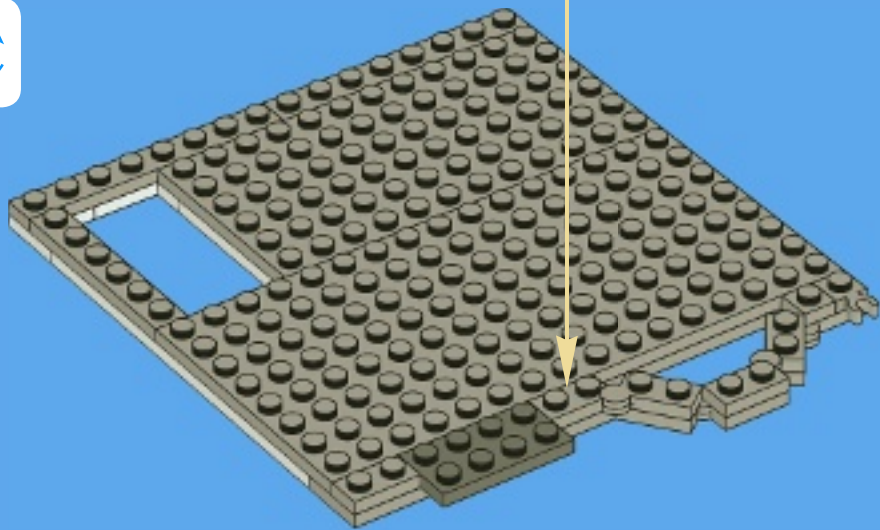
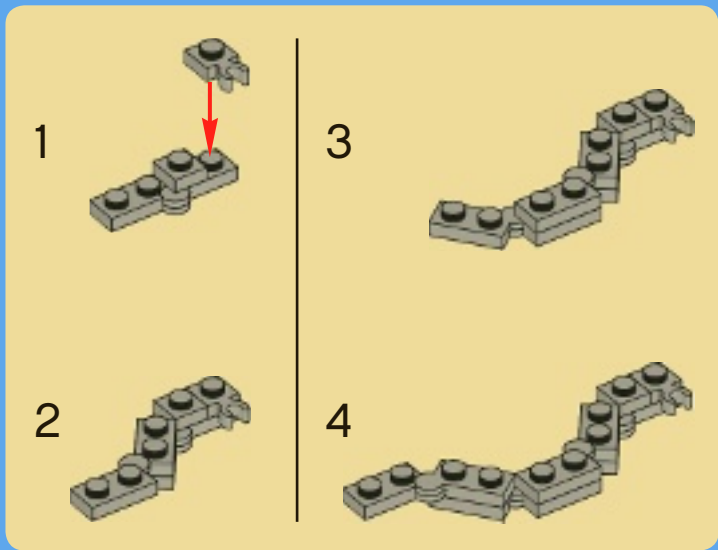

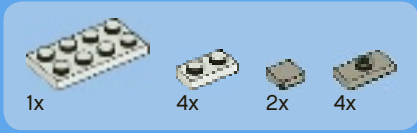

7



8

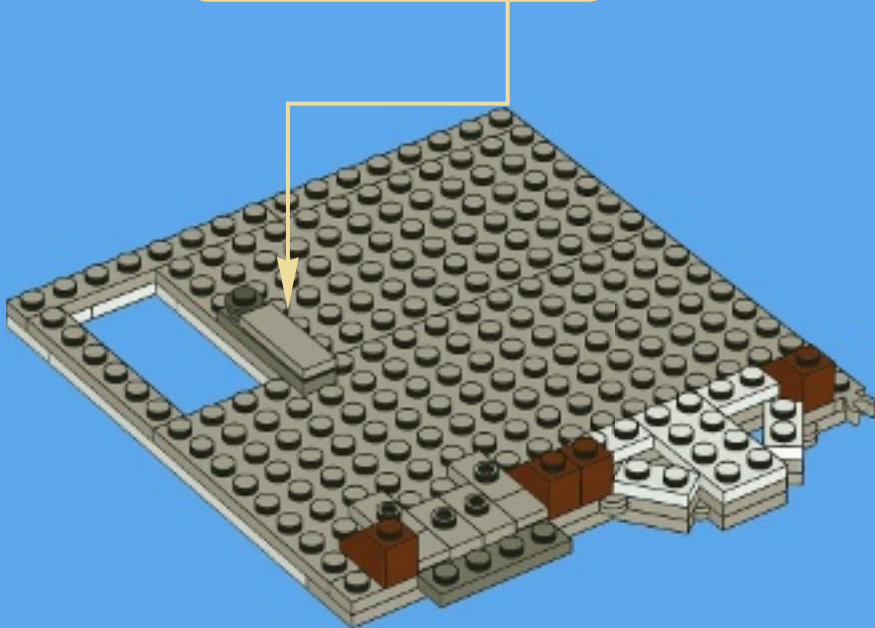
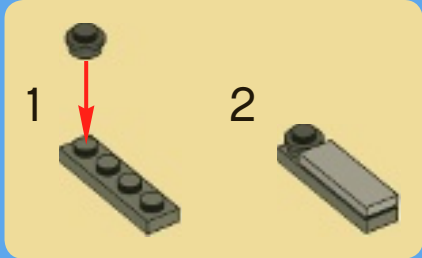

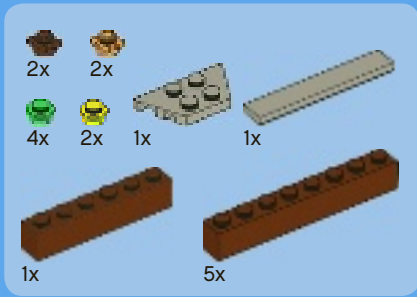

9

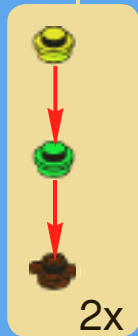

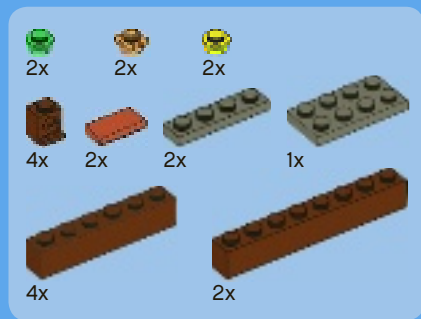

10

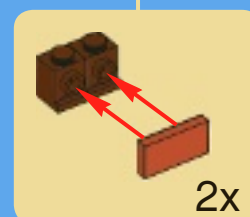
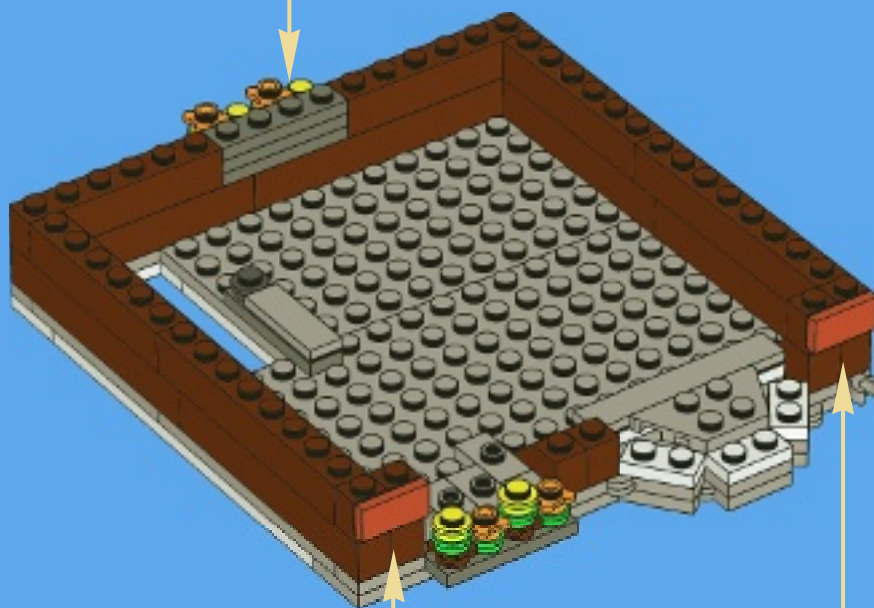

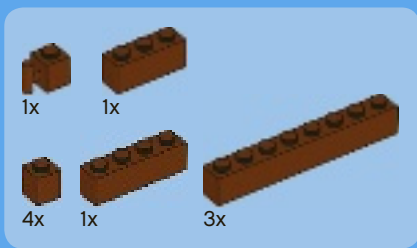

11



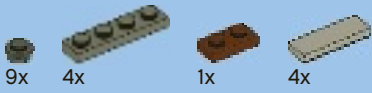

12

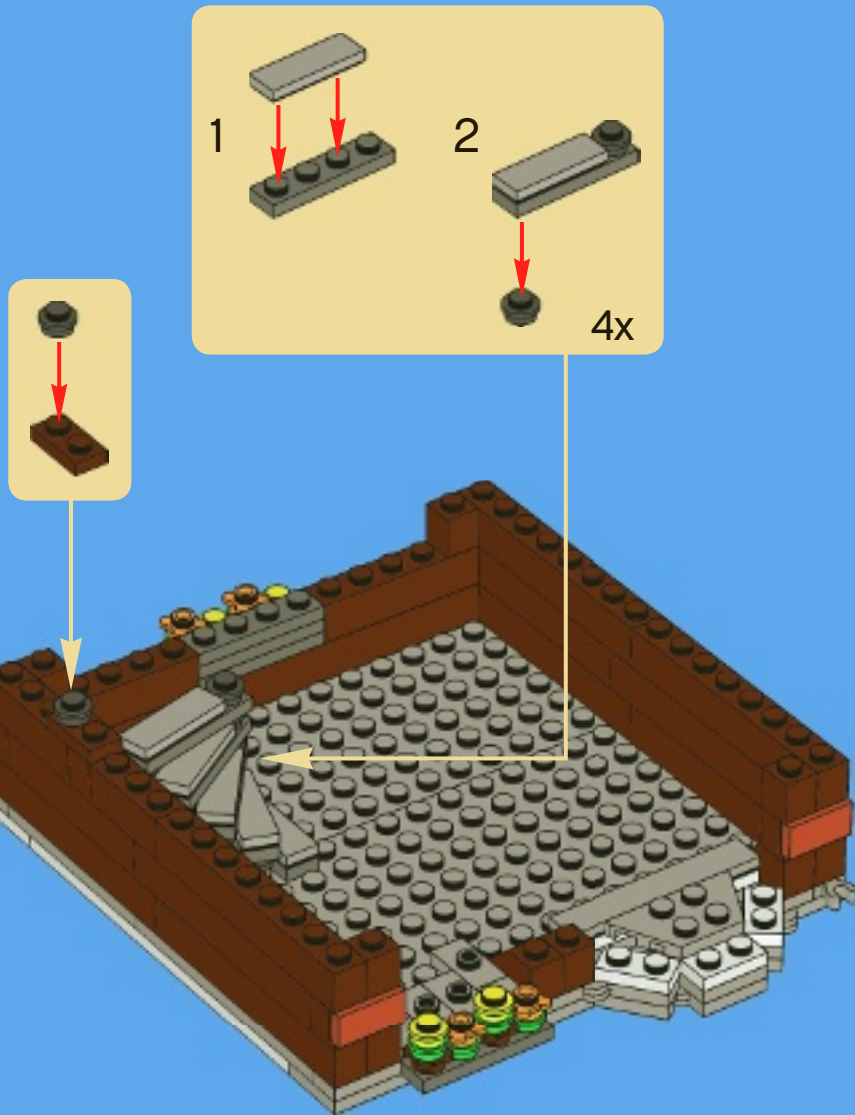

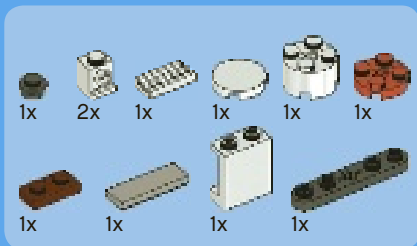

13

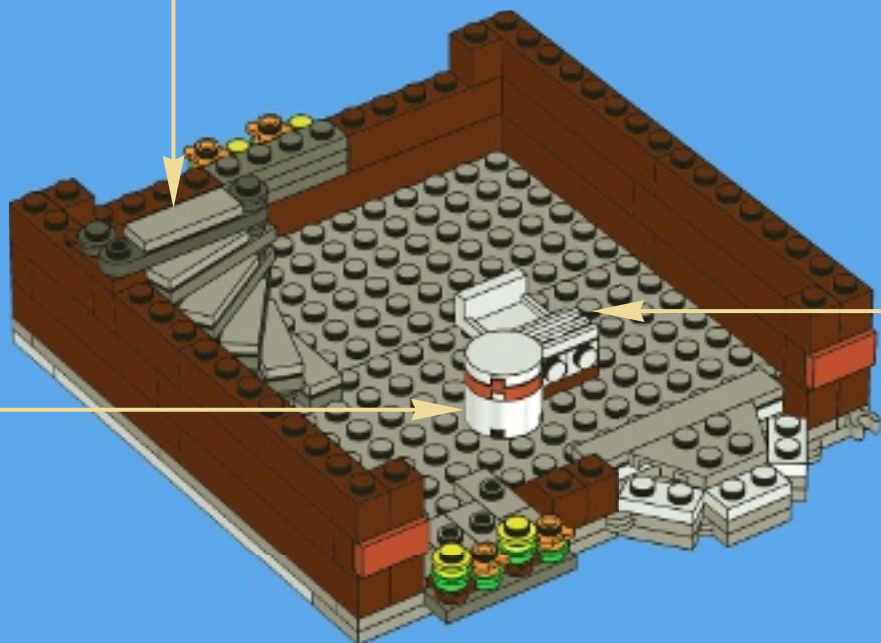
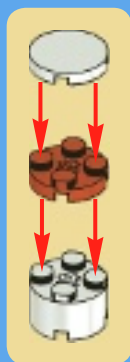
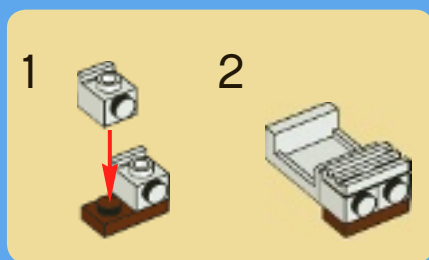
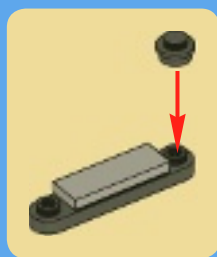

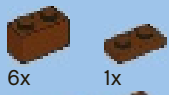

6x

1x



1x



2x

14



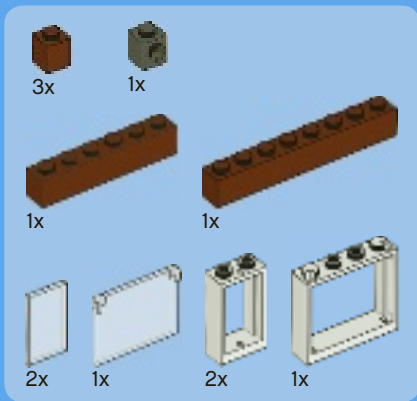

15

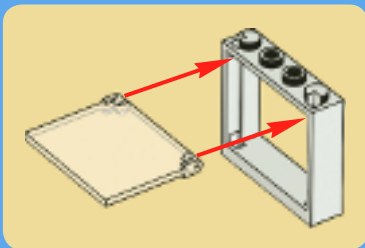
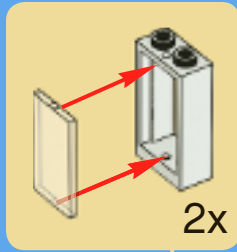

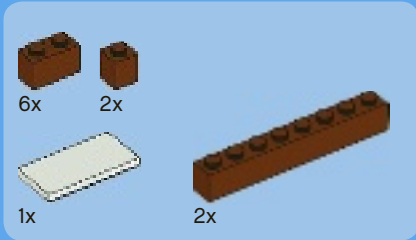

16

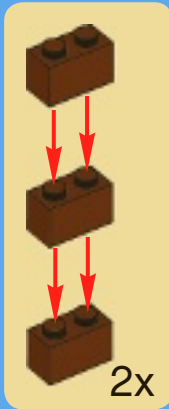

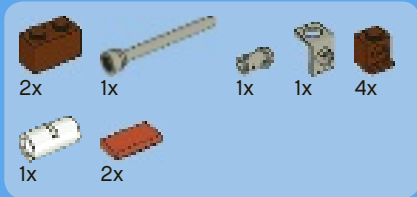

17

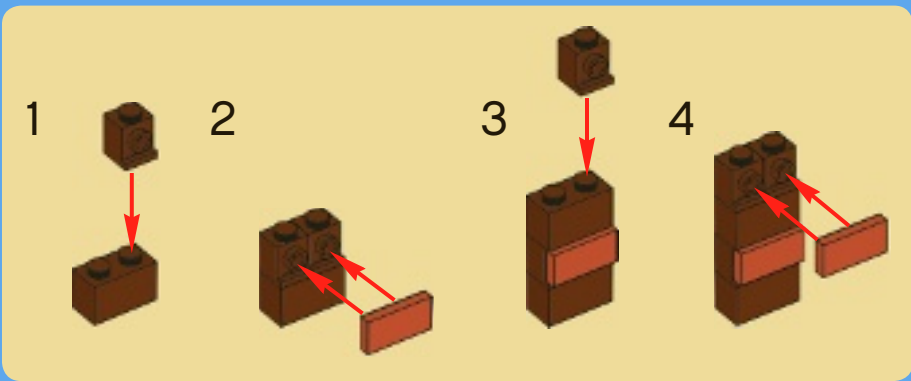
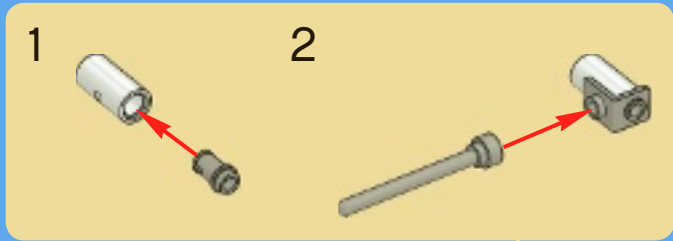

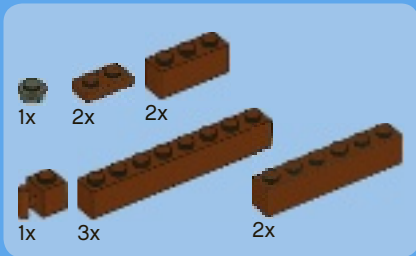

18

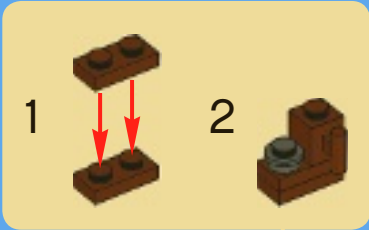



19

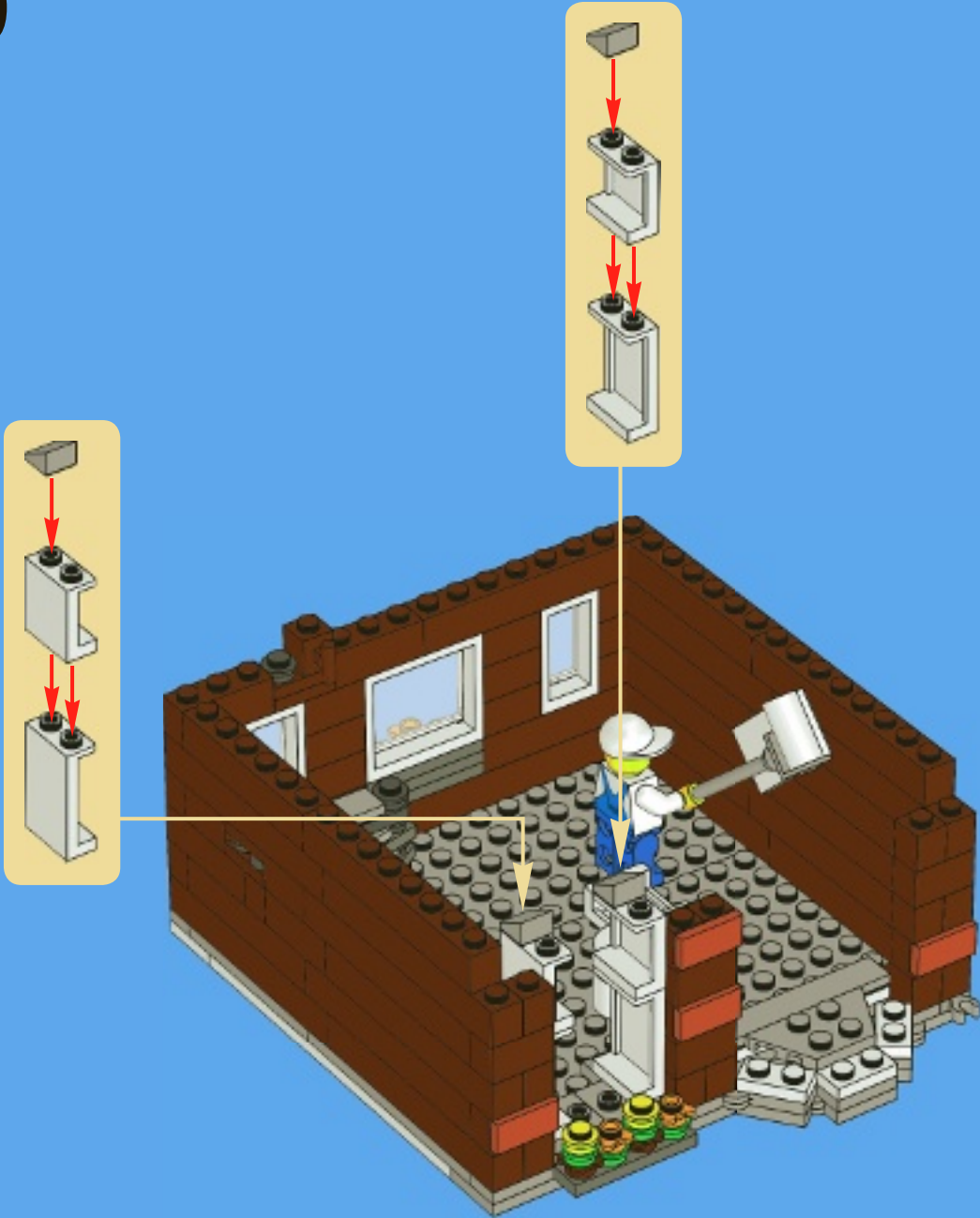



1x



7x



7x

20

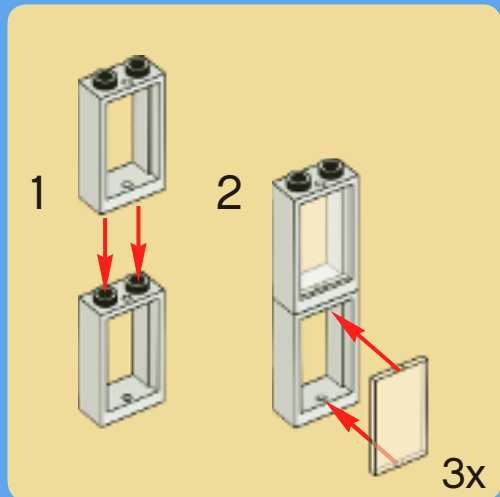
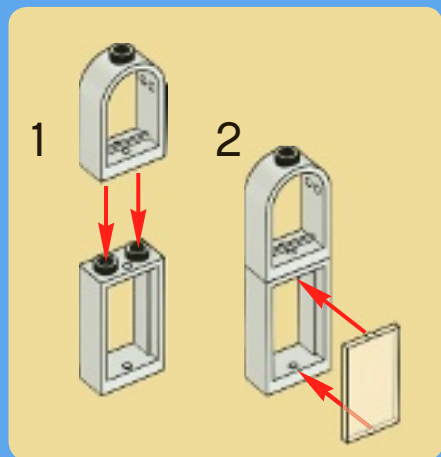

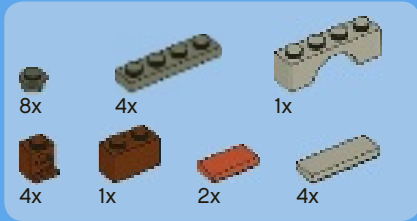

21

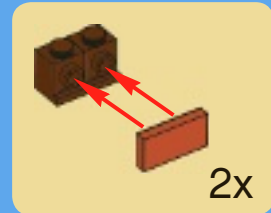
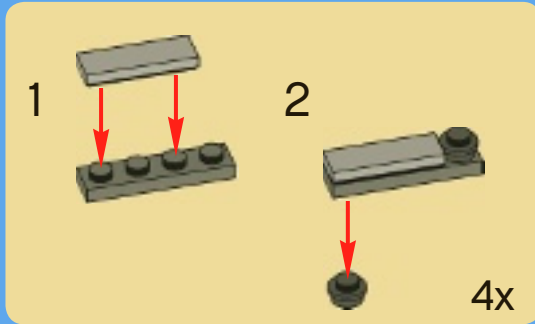

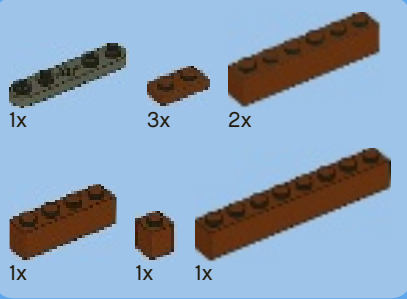

22



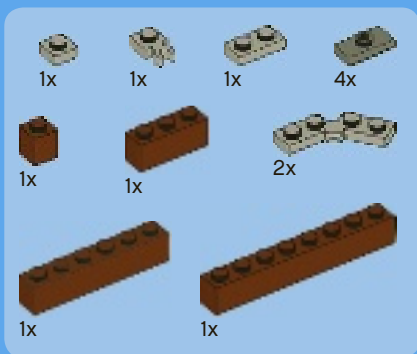

23





1x



2x

24



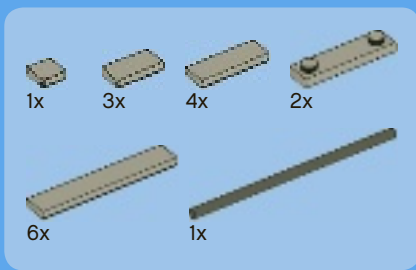

25



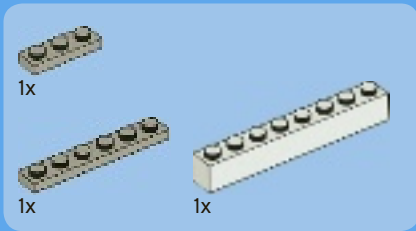

1

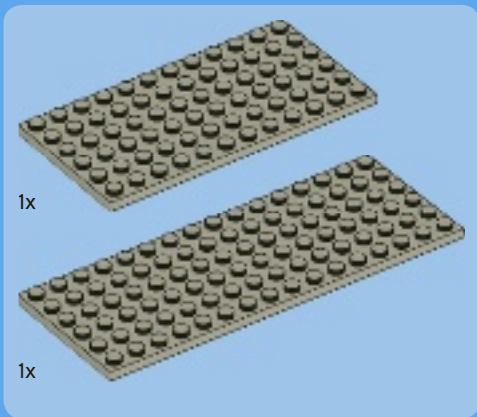
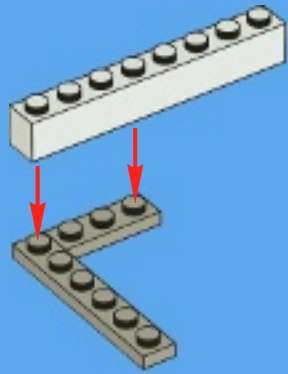

2

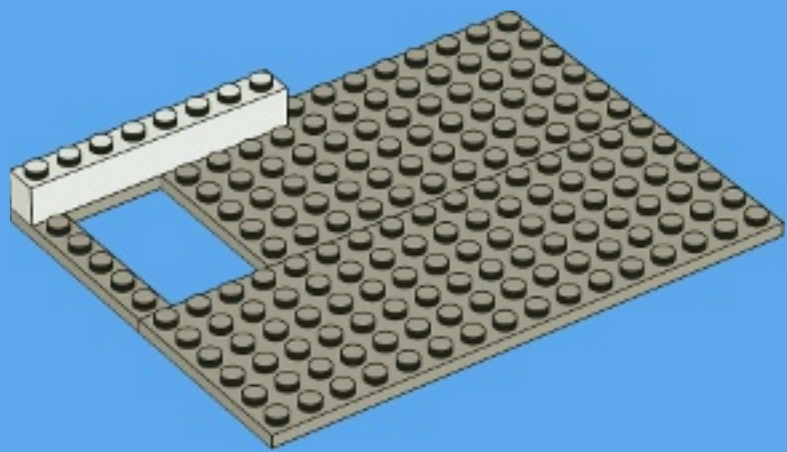

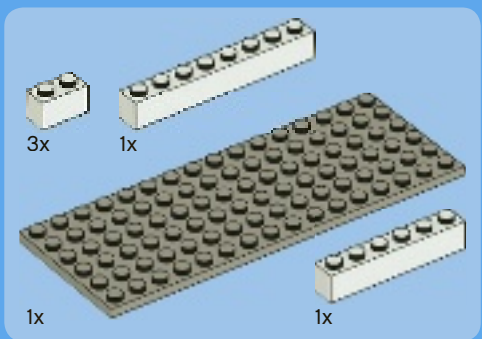

3

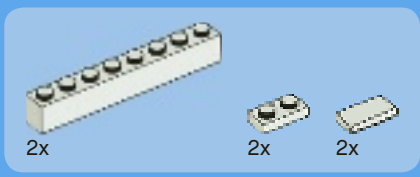
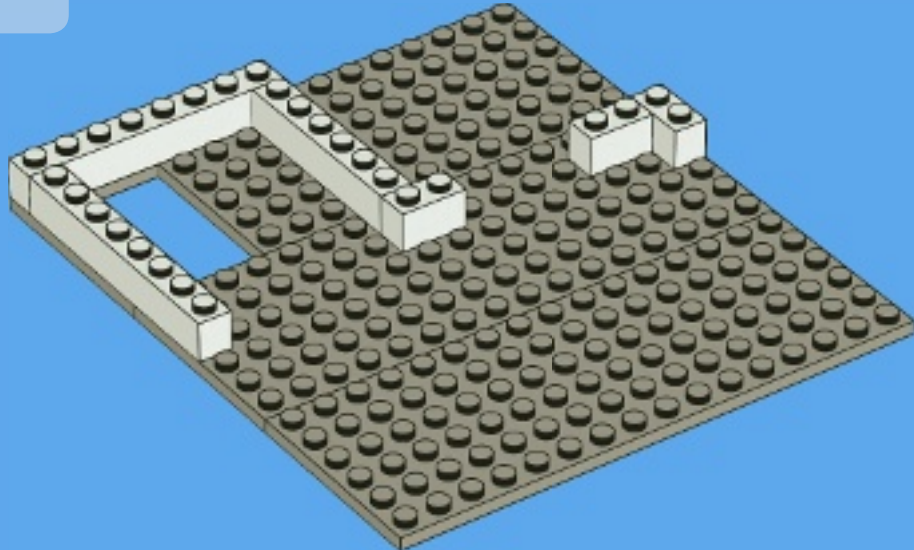

4

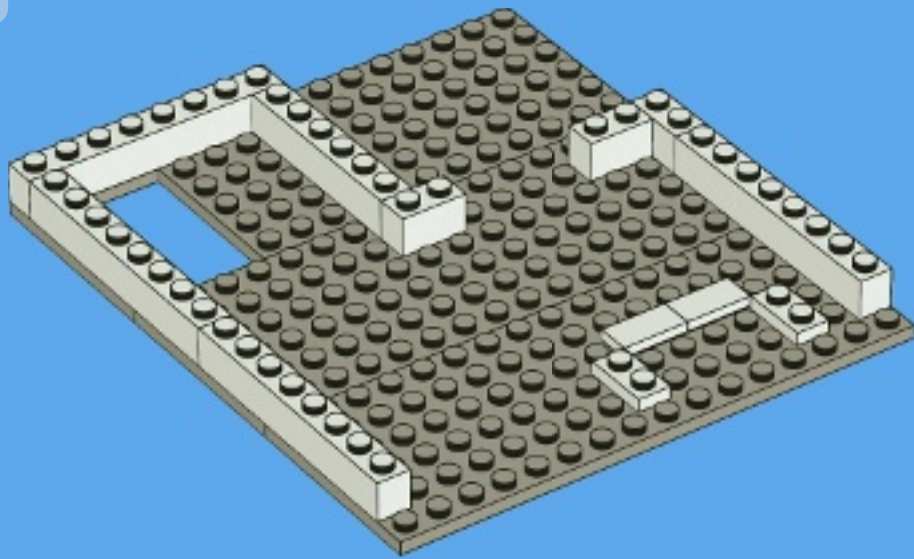

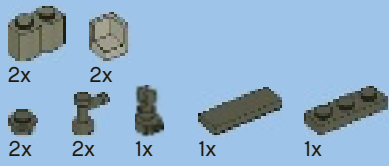

5

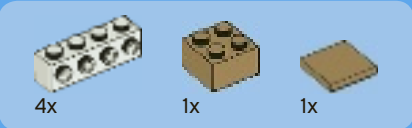

6

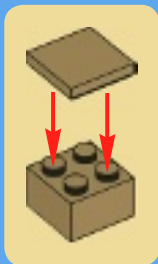

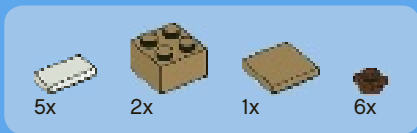



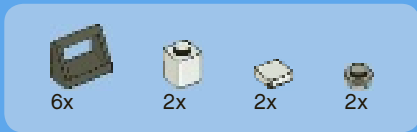
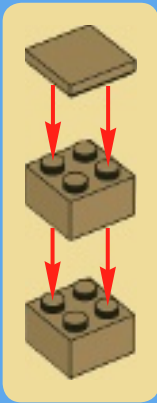

7

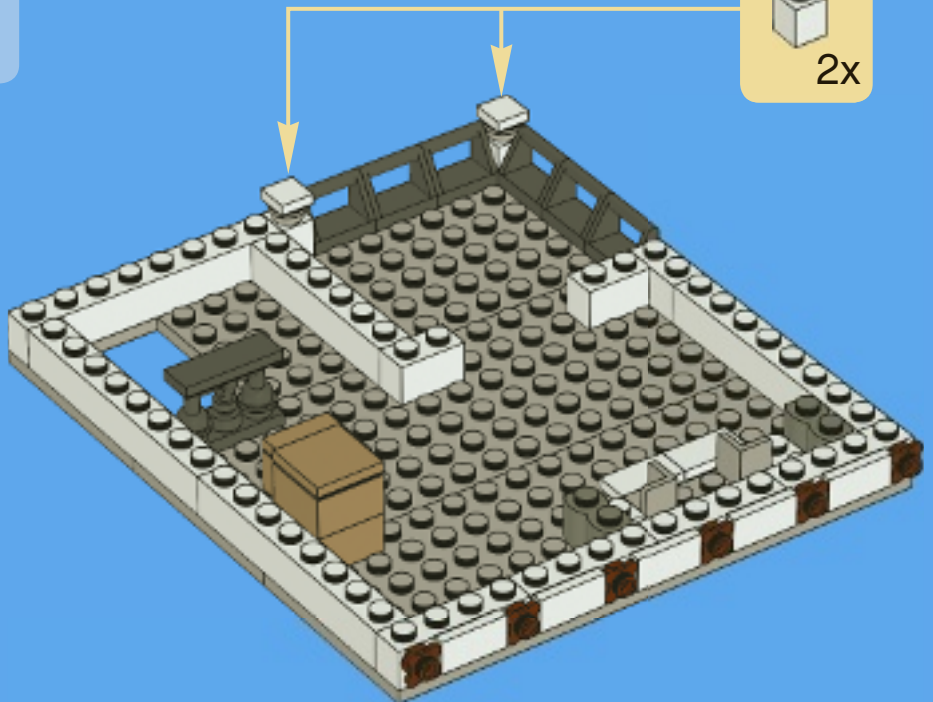
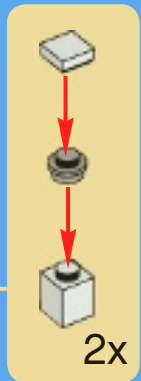

8



- 2x 
- 2x 
- 2x 
- 2x 
- 2x 

- 1x 
- 1x 
- 2x 
- 6x 

9

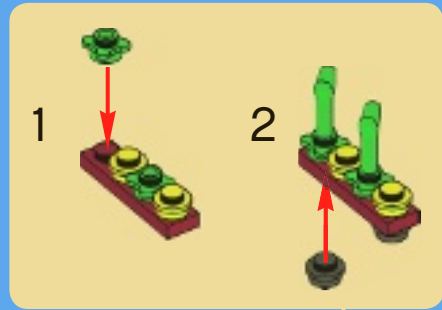

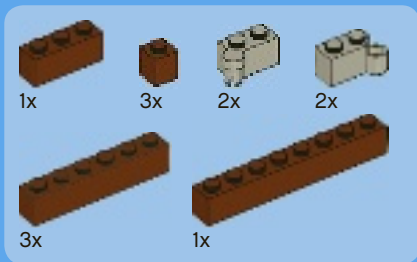

10

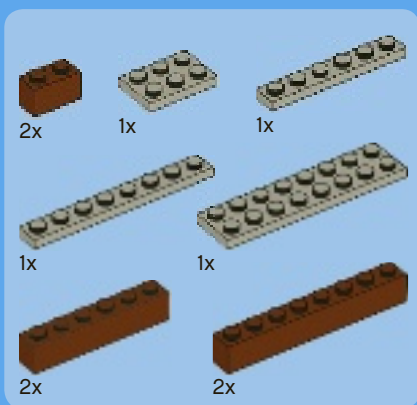
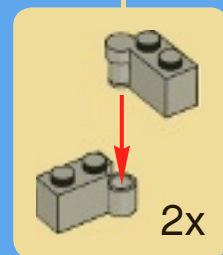

11



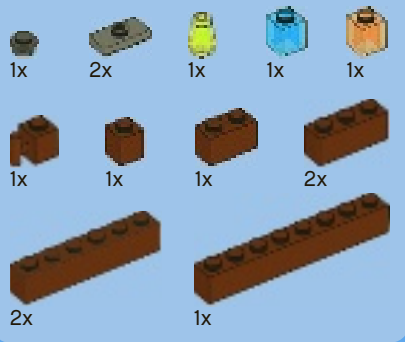

12



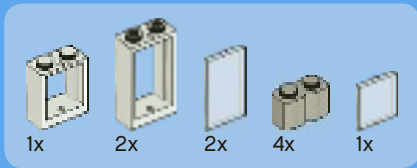

13

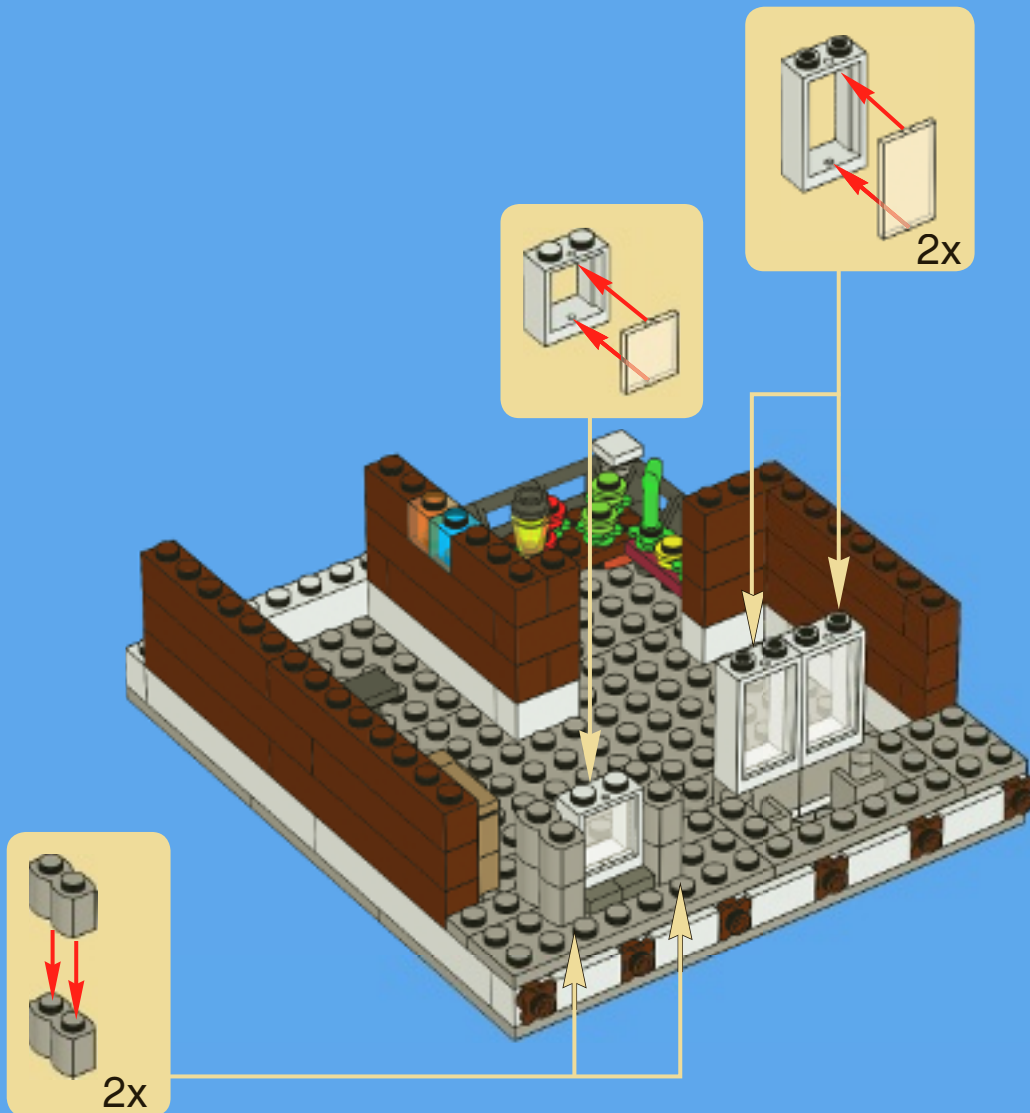

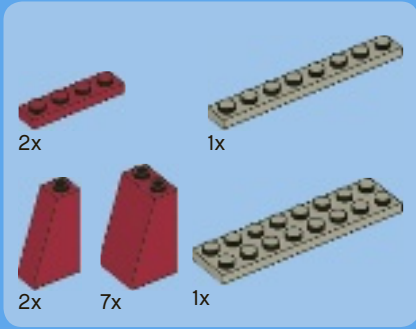

14

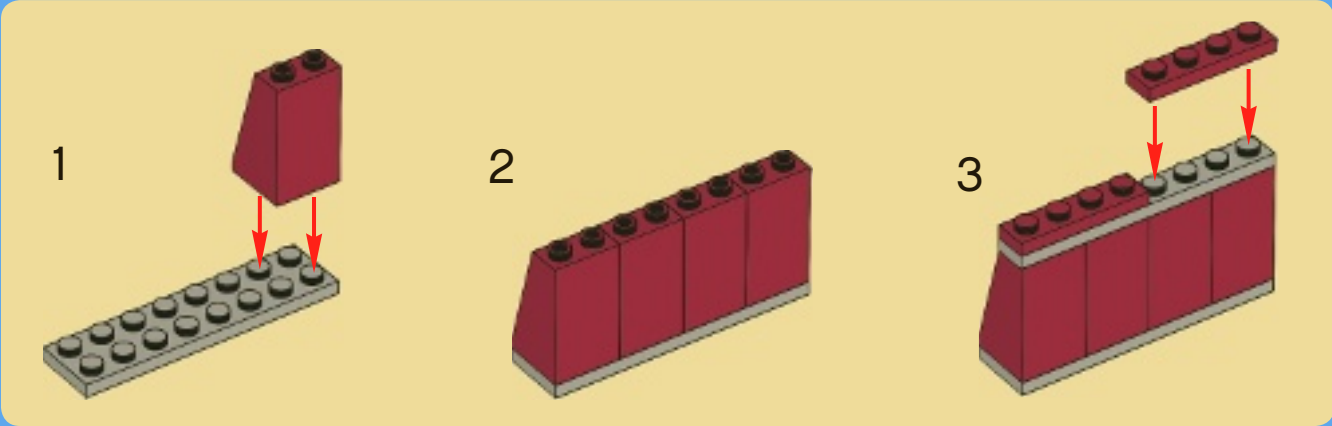



15



16





17

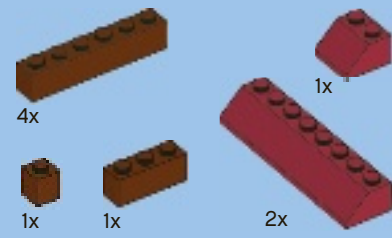
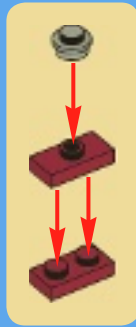

18



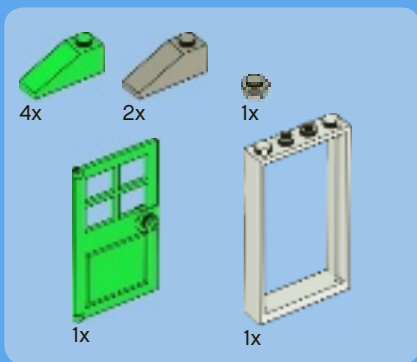

19

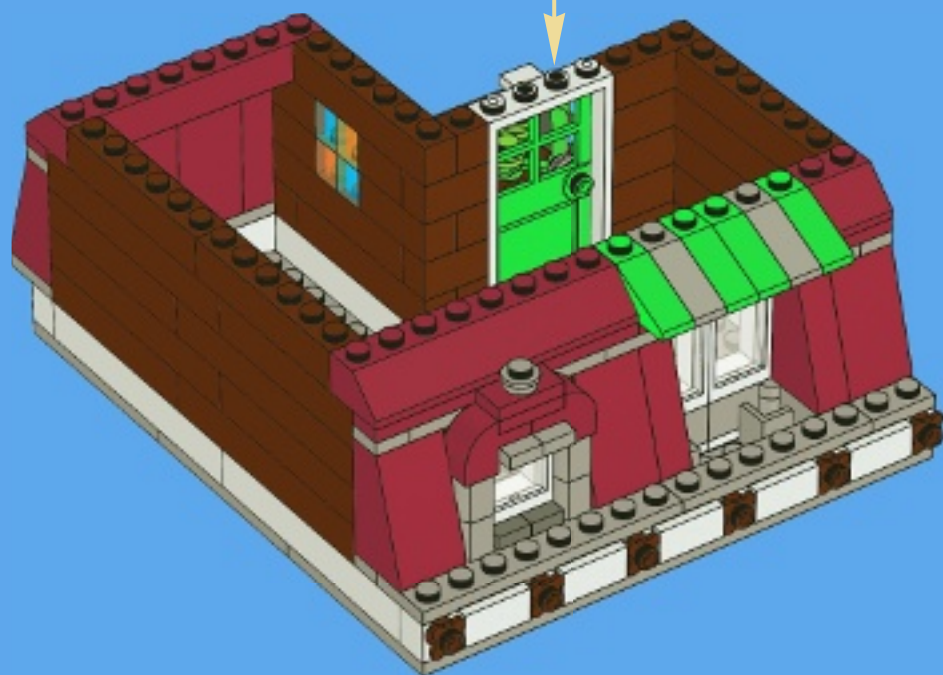
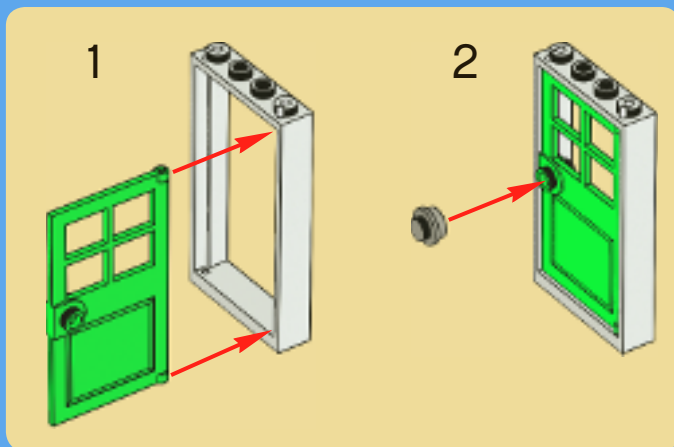



6x



2x



2x



5x

20

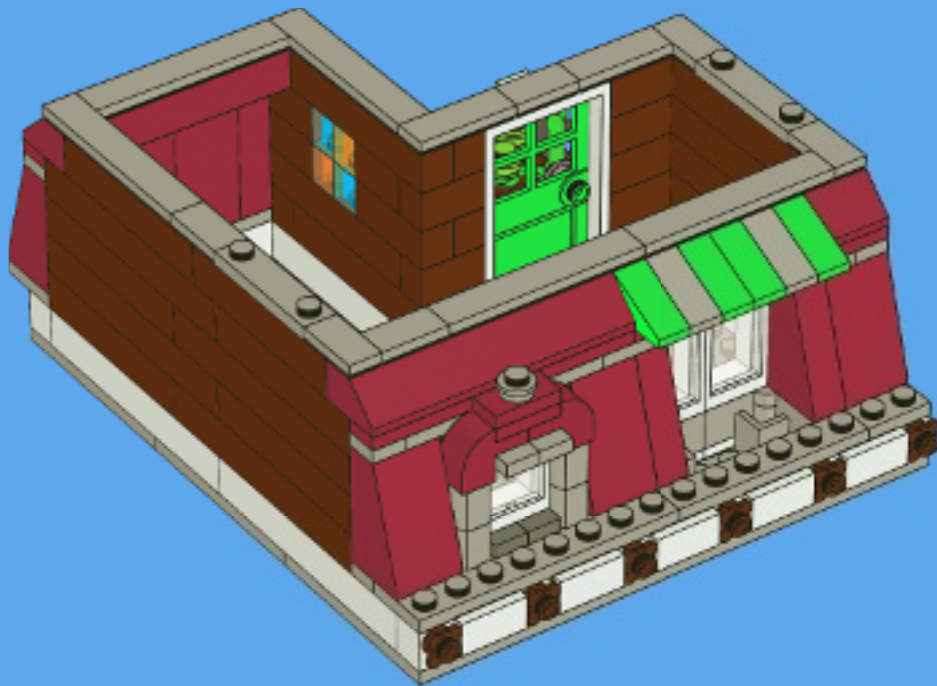

21



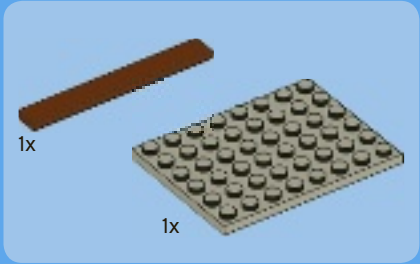
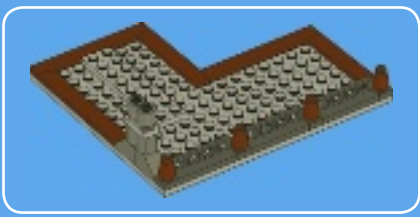

1

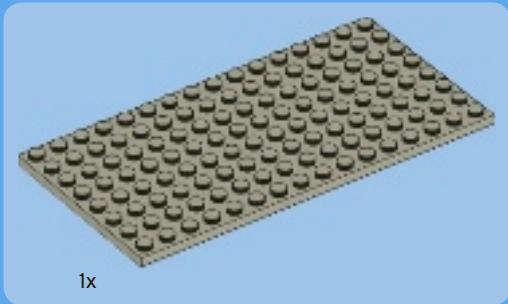
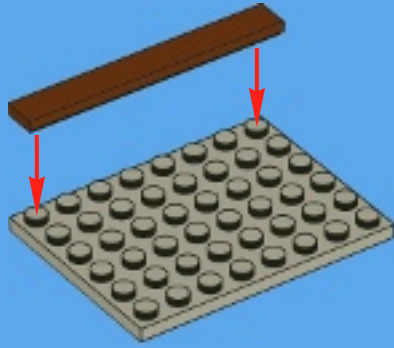

2

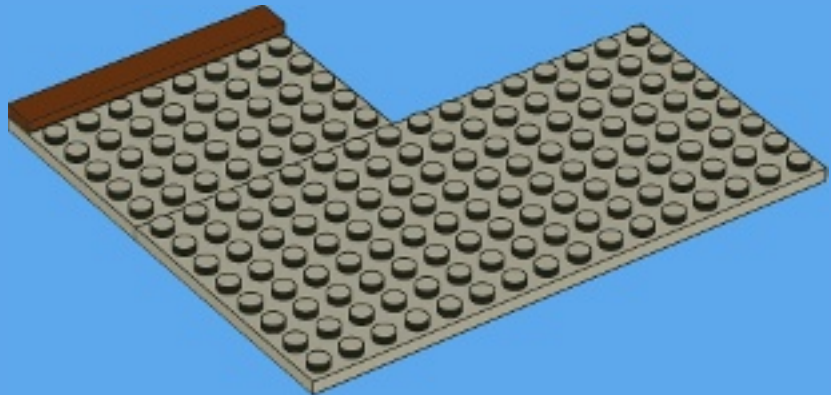

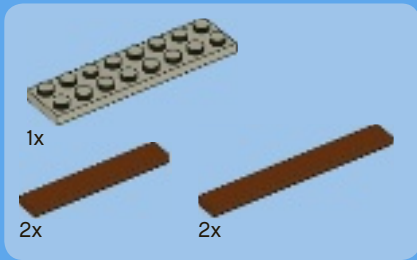

3

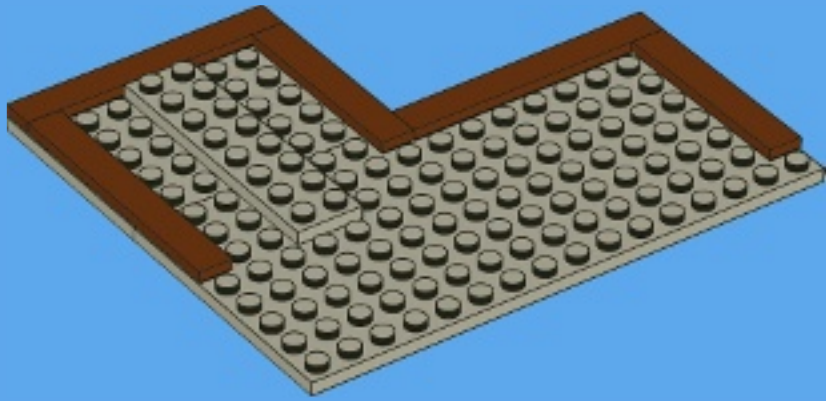

4

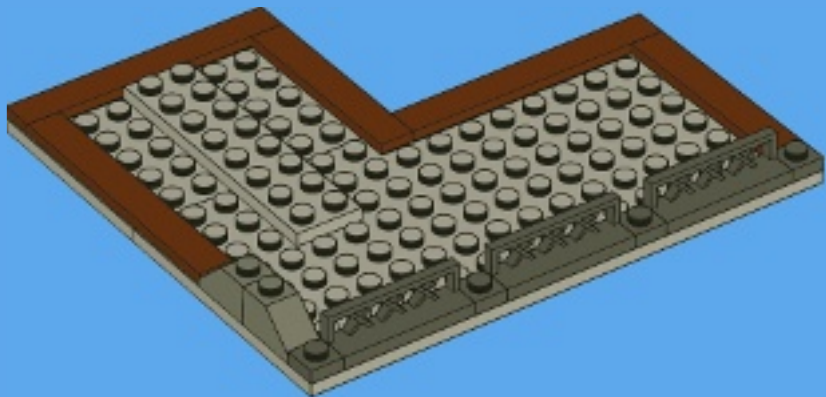



2x



1x



1x



4x

5

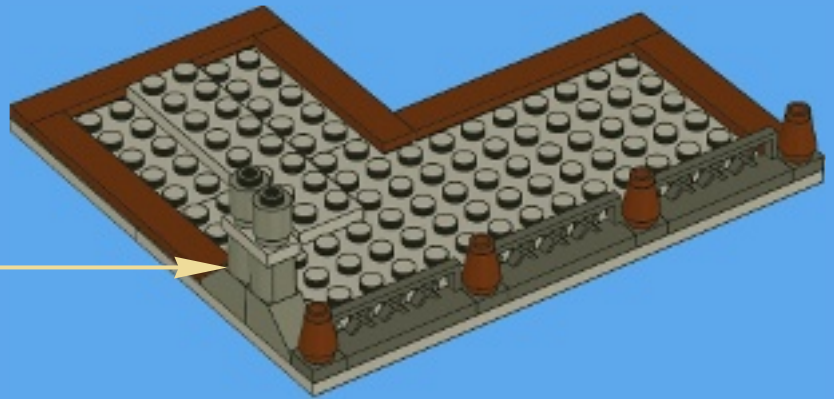
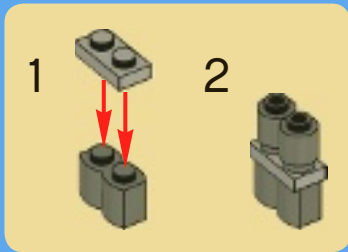

22

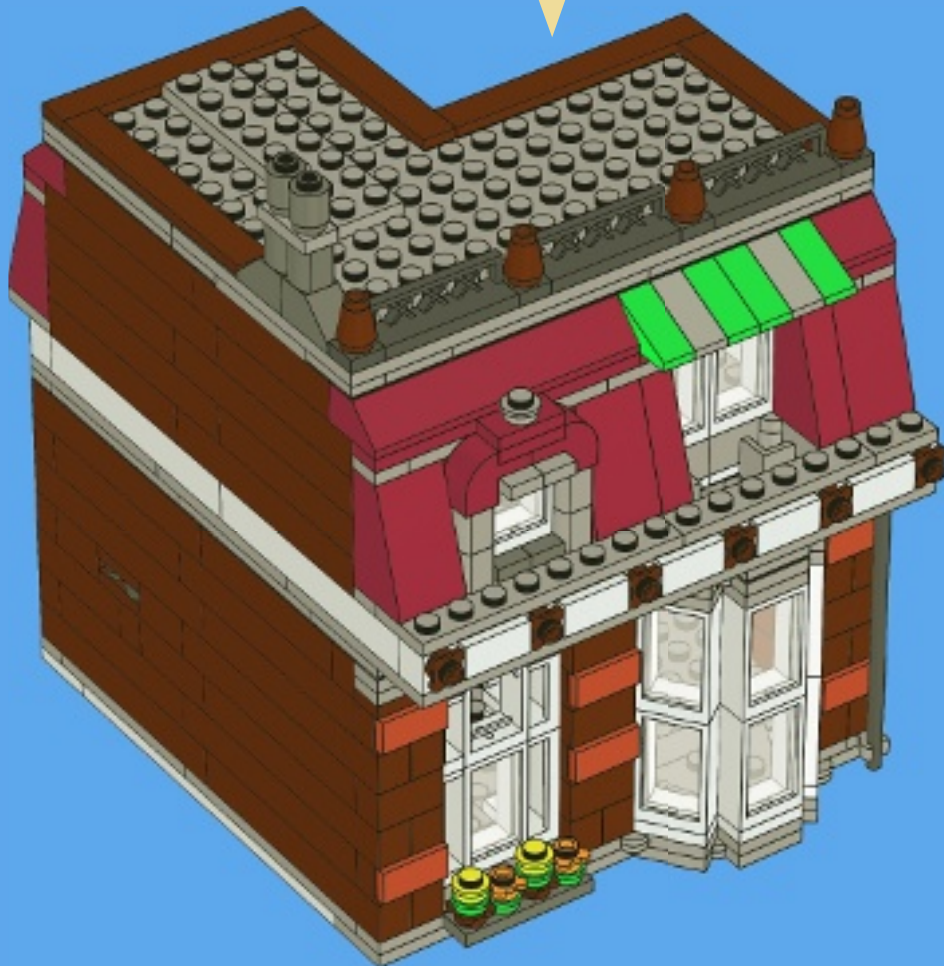

23



10197

10218

10211



10214



10219

