



User Manual

AC1200 Wi-Fi Range Extender

Preface

D-Link reserves the right to revise this publication and to make changes in the content hereof without obligation to notify any person or organization of such revisions or changes.

Manual Revisions

Revision	Date	Description
1.00	September 8, 2015	• Initial release

Trademarks

D-Link and the D-Link logo are trademarks or registered trademarks of D-Link Corporation or its subsidiaries in the United States or other countries. All other company or product names mentioned herein are trademarks or registered trademarks of their respective companies.

Apple®, Apple logo®, Safari®, iPhone®, iPad®, iPod touch® and Macintosh® are trademarks of Apple Inc., registered in the U.S. and other countries. App StoreSM is a service mark of Apple Inc.

Chrome™ browser, Google Play™ and Android™ are trademarks of Google Inc.

Internet Explorer®, Windows® and the Windows logo are trademarks of the Microsoft group of companies.

Copyright © 2015 by D-Link Corporation. All rights reserved. This publication may not be reproduced, in whole or in part, without prior expressed written permission from D-Link Corporation.

Power Usage

This device is an Energy Related Product (ErP) with High Network Availability (HiNA), and automatically switches to a power-saving Network Standby mode within 1 minute of no packets being transmitted. If it is not needed during certain periods of time, it can be unplugged to save energy.

Network Standby: 3.54 watts

Table of Contents

Preface	i	Save Your Configuration.....	29
Product Overview	1	Configuration	30
Package Contents.....	1	Home	30
System Requirements	2	Settings	32
Introduction	3	Extender Settings	32
Features.....	3	Network Settings	34
What is a Wireless Extender?	4	Autoconfiguration (SLAAC/DHCPv6).....	35
Hardware Overview	5	Static IPv6	36
Front	5	Link-local Only	37
Bottom.....	7	Management.....	38
Back.....	8	Admin	38
Installation	9	System	39
Wireless Installation Considerations.....	9	Upgrade	40
Hardware Setup	11	Statistics.....	41
Getting Started	12	Connecting Wireless Clients to the Extended Network	42
WPS-PBC Configuration	13	WPS Button.....	42
QRS Mobile App Setup	14	Windows® 8.....	43
Web-based Setup	19	WPA/WPA2	43
Setup Wizard	20	Windows® 7.....	45
Connecting Your Device via WPS.....	21	WPA/WPA2	45
WPS Successful	22	Windows Vista®	48
WPS Unsuccessful.....	22	WPA/WPA2	49
Extend an Existing Network.....	23	Troubleshooting	51
Add Wireless to Your Wired Network.....	26	Wireless Basics	53
Configure Administrator Password	28		

Tips.....54

Technical Specifications55

GPL Code Statement.....56

Safety Statements71

Package Contents

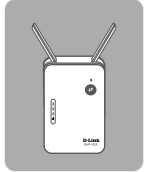

DAP-1620 AC1200 Wi-Fi Range Extender



Wi-Fi Configuration Card



Quick Installation Guide

If any of the above items are missing, please contact your reseller.

System Requirements

Network Requirements	<ul style="list-style-type: none">• A wireless router with an active Internet connection.• IEEE 802.11ac, 802.11n, 802.11g, 802.11b, or 802.11a wireless clients/devices
Web-based Configuration Utility Requirements	<p>A Computer or Mobile Device with the following:</p> <ul style="list-style-type: none">• Windows®, Apple® Mac OS®, or Linux-based operating system• Wireless adapter or Wi-Fi functionality• An Apple® iPhone®, iPod touch®, iPad®, or Android™ mobile device <p>Browser Requirements:</p> <ul style="list-style-type: none">• Internet Explorer® 9 or later• Firefox® 20.0 or later• Safari® 5.1 or later• Google Chrome™ 25.0 or later

Introduction

Features

Easily Extend Your Existing Network

The DAP-1620 AC1200 Wi-Fi Range Extender lets you easily extend a secure wireless network with a press of a button. Connect the DAP-1620 to a router via Wi-Fi or Ethernet and share your high-speed Internet access in more places throughout your home or small office.

High-speed Wireless Performance With Wireless 802.11ac Technology

Thanks to the latest Wireless AC technology, the DAP-1620 provides a wireless connection at up to 1200 Mbps* with other 802.11ac wireless devices. This feature lets you participate in real-time activities online, such as video streaming, online gaming, and real-time audio with smooth performance.

Simple Setup

All it takes is a press of a button to connect compatible WPS devices to the DAP-1620. Its easy-to-use web interface lets you quickly and easily connect the DAP-1620 to an uplink router, configure the extended wireless network, and manage the administrative settings. The setup wizard will even guide you through the setup process, getting your extended wireless network up and running in no time. Alternatively, connect an Ethernet cable to your existing network infrastructure to quickly and easily create a wireless network.

Compatibility

The DAP-1620 is fully compatible with not only the latest 802.11ac standard, but is also backwards compatible with IEEE 802.11n/g/b/a wireless devices, so you can use your existing devices without sacrificing performance.

Latest Wireless Network Security and Encryption

The DAP-1620 supports wireless security features to prevent unauthorized access from the wireless network. Support for WPA/WPA2 standards ensure that you'll be able to use the best possible encryption methods with your compatible wireless devices.

* Maximum wireless signal rate derived from standard IEEE specifications. Actual data throughput will vary. Network conditions and environmental factors, including volume of network traffic, building materials and construction, and network overhead may lower actual data throughput rate. Environmental conditions will adversely affect wireless signal range.

What is a Wireless Extender?

The DAP-1620 acts as a repeater to extend the range of an existing wireless network to provide a better signal for parts of your home or office that may have poor or no reception. Your existing wireless signal will be re-broadcast by the DAP-1620, allowing you to reach the farthest corners of your home or office. The extended network can simply use the same network credentials as the existing network, or you can specify a different network name and password, giving you the flexibility to control network access. You may also use the DAP-1620 as a wireless access point by connecting an Ethernet cable.

Extend Your Wireless Network using Wi-Fi

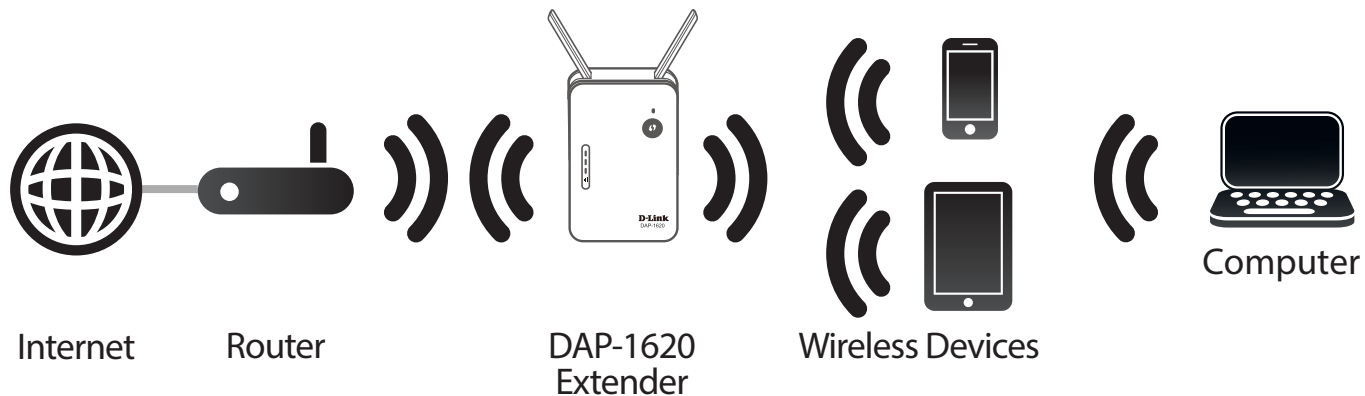

Create a Wireless Network using Ethernet

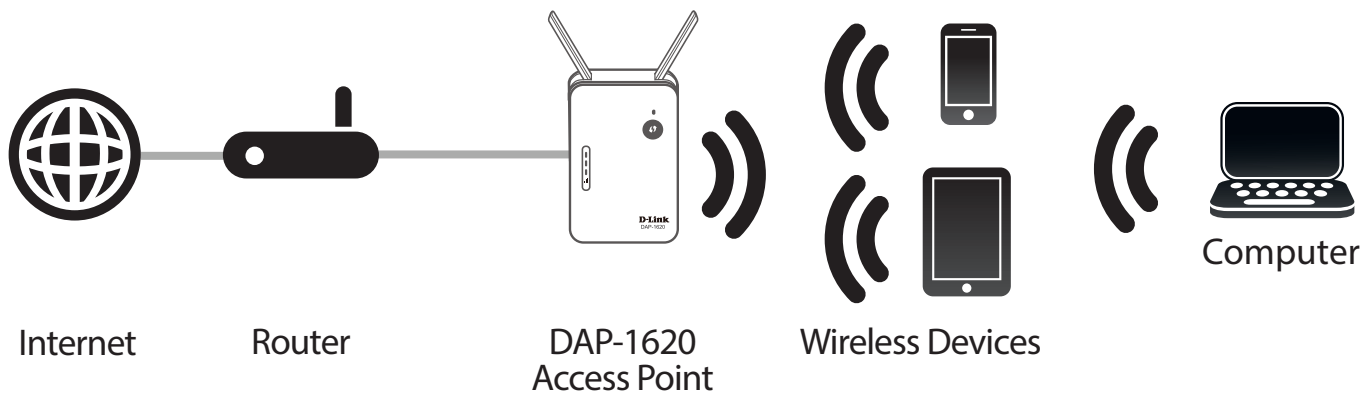

Hardware Overview

Front

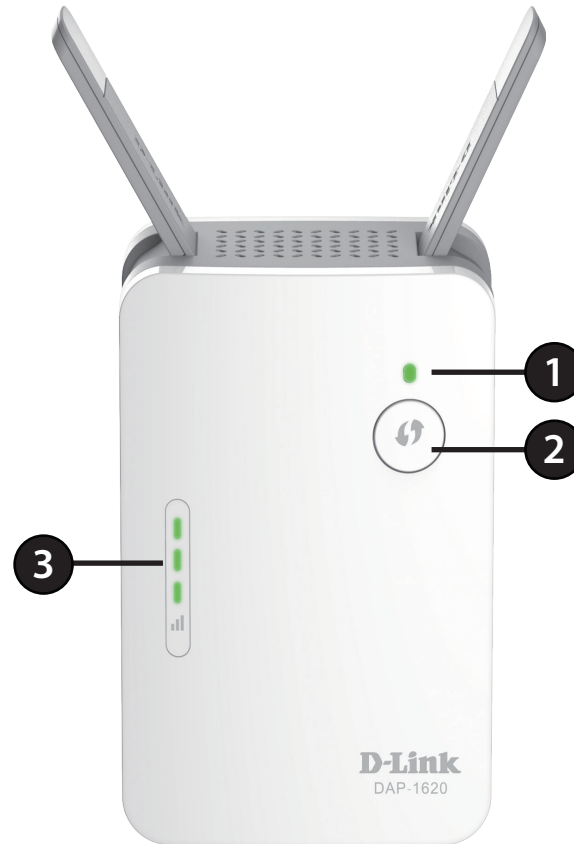

1	Status/WPS LED	This LED indicates the current status of the DAP-1620, as detailed on the next page.
2	WPS Button	Press to establish a connection with another WPS compatible device. See page “WPS Button” on page 42 for more information.
3	Signal Indicator LED	The more lit green bars on the Signal Indicator LED, the better the wireless signal to the host network. A single solid amber LED indicates a weak Wi-Fi signal.

Status/WPS LED Indicator

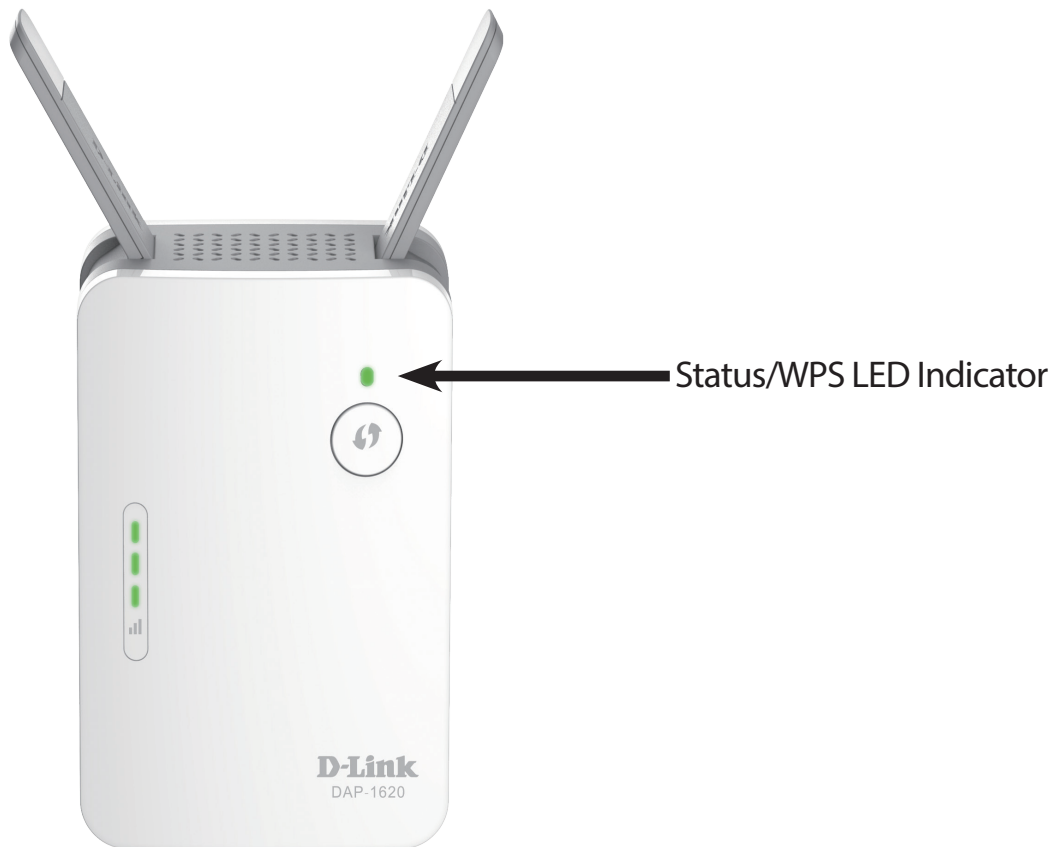

LED Indicator	Color	Status	Description
Power/Status	Green	Solid	The DAP-1620 is receiving power and connected to a host network.
		Blinking	WPS mode is active.
	Red	Solid	The DAP-1620 is booting or an error has occurred.
	Amber	Blinking	The DAP-1620 is not connected to a host network.
	None	Off	Device is not receiving power. Check the power outlet.

Hardware Overview

Bottom



1	LAN	Connect an Ethernet cable if you are adding wireless to wired network.
2	Reset Button	Use an unfolded paperclip to press and hold the reset button on the bottom of DAP-1620 for 10 seconds to restore the factory default settings.

Hardware Overview

Back

You may locate the Wi-Fi name (SSID) and password for your DAP-1620. This information is printed on the specification sticker on the back of the device. You will need this information to connect your computer or mobile device to the default network (SSID) of your DAP-1620. This information is also provided on the Wi-Fi configuration card.



Installation

Wireless Installation Considerations

The DAP-1620 lets you extend your existing wireless network's coverage as long as it is within range of the uplink network. Keep in mind that the DAP-1620's extension network's range may be limited by the number, thickness and location of walls, ceilings, or other objects that the wireless signals must pass through. Typical ranges vary depending on the types of materials and background RF (radio frequency) noise in your home or business. The key to maximizing wireless range is to follow these basic guidelines:

1. Keep the number of walls and ceilings between the D-Link extender and other network devices to a minimum - each wall or ceiling can reduce your adapter's range from 3-90 feet (1-30 meters.) Position your devices so that the number of walls or ceilings is minimized.
2. Be aware of the direct line between network devices. A wall that is 1.5 feet thick (0.5 meters), at a 45-degree angle appears to be almost 3 feet (1 meter) thick. At a 2-degree angle it looks over 42 feet (14 meters) thick! Position devices so that the signal will travel straight through a wall or ceiling (instead of at an angle) for better reception.
3. Building materials make a difference. A solid metal door or aluminum studs may have a negative effect on range. Try to position extenders, access points, wireless routers, and computers so that the signal passes through drywall or open doorways. Materials and objects such as glass, steel, metal, walls with insulation, water (fish tanks), mirrors, file cabinets, brick, and concrete will degrade your wireless signal.
4. Keep your product away (at least 3-6 feet or 1-2 meters) from electrical devices or appliances that generate RF noise.
5. If you are using 2.4 GHz cordless phones or X-10 (wireless products such as ceiling fans, lights, and home security systems), your wireless connection may degrade dramatically or drop completely. Make sure your 2.4 GHz phone base is as far away from your wireless devices as possible. The base transmits a signal even if the phone is not in use.

Assessing Uplink Signal Strength

The Status/WPS LED will turn solid green when the DAP-1620 has connected successfully to a wireless network and is extending that network. If the Signal Indicator LED has a single amber bar after the connection process has finished, the DAP-1620 has established a poor quality connection. The more lit bars on the Signal Indicator LED, the better the wireless signal. To improve the connection quality, the DAP-1620 should be relocated closer to the source wireless router. Using the 5 GHz extension network is recommended in order to achieve the fastest wireless speeds.

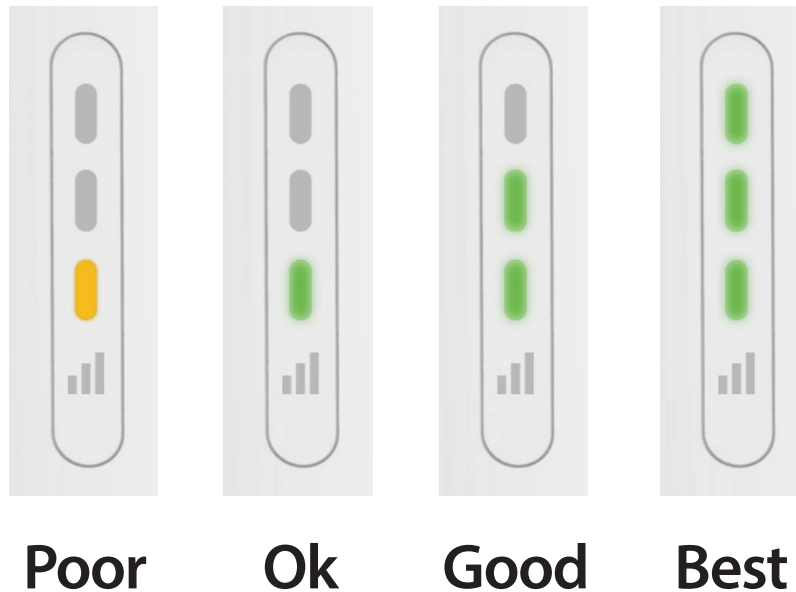

Hardware Setup

Plug in the DAP-1620 to a power outlet. Verify that the power LED is blinking amber before continuing with configuration.

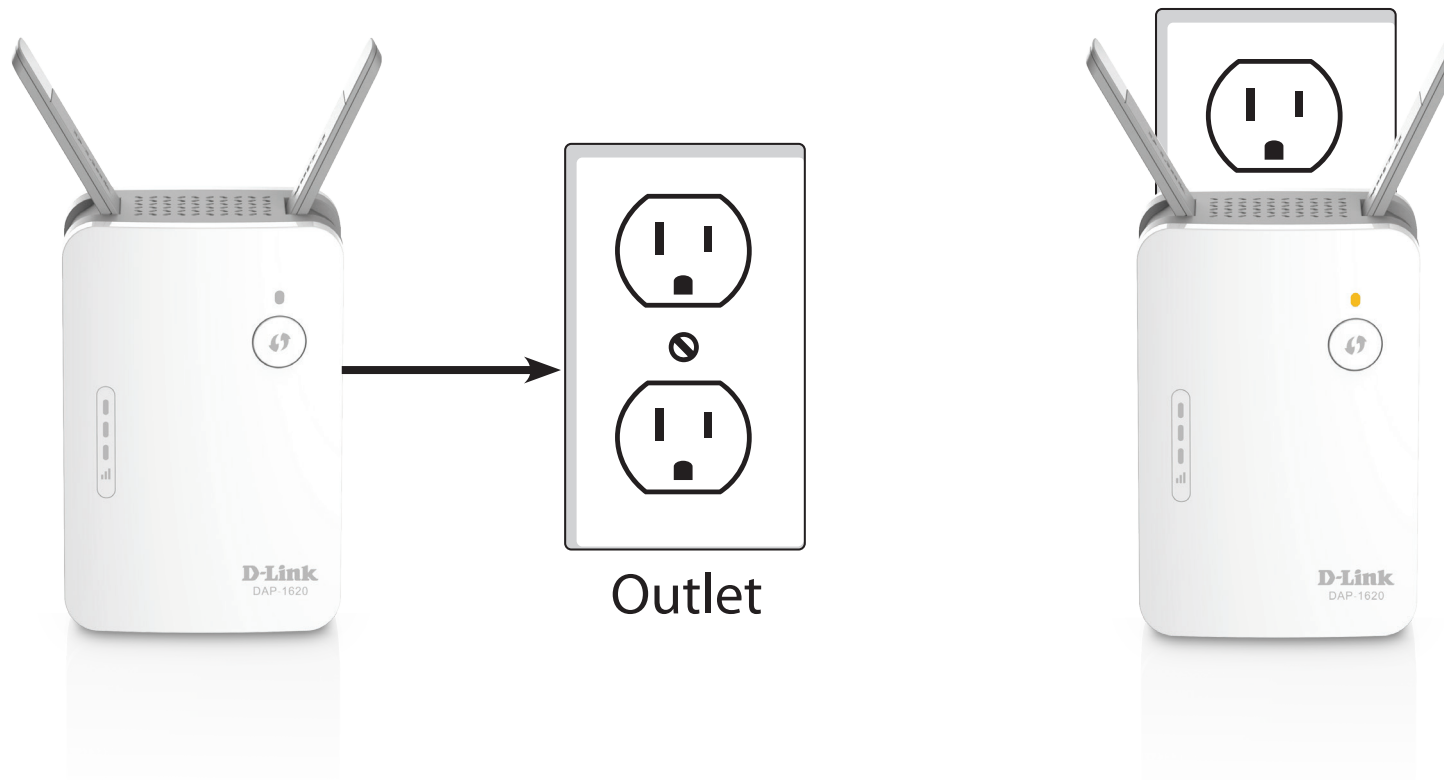

Getting Started

There are several configuration tools you can use to set up your DAP-1620.

- **WPS PBC** - To easily extend an existing wireless network refer to “WPS-PBC Configuration” on page 13 for setup instructions.
- **QRS Mobile App** - Use your Android device or iPhone, iPad, or iPod touch to configure your extender. Refer to “QRS Mobile App Setup” on page 14 for setup instructions.
- **D-Link Setup Wizard** - This wizard will launch when you log into the Extender’s web configuration utility for the first time. Refer to “Setup Wizard” on page 20 for setup instructions.
- **Manual Configuration** - Advanced users who wish to manually setup extender or adjust its settings may refer to “Configuration” on page 30 for more information.

WPS-PBC Configuration

To connect to a wireless router or access point and extend the Wi-Fi network in your home, first make sure the source router or Access Point features a WPS Button or has a virtual WPS Button.

Step 1 - Initiate WPS Mode

While the Status/WPS LED is blinking amber. Push the WPS button on the source wireless router or AP, and then push the WPS button on the DAP-1620. The Status/WPS LED will start to flash green. Please allow up to two minutes for the process to finish. The Status/WPS LED will turn solid green when the DAP-1620 has connected successfully to the source wireless router or access point.

Step 2 - Assess Result

If the Signal Indicator LED has a single amber bar after the connection process has finished, the DAP-1620 has established a poor quality connection. To improve the connection quality, the DAP-1620 should be relocated to a wall outlet closer to the source wireless router or access point. The more lit bars on the Signal Indicator LED, the better the wireless signal.

Step 3 - Connecting Devices to the DAP-1620

The DAP-1620 is now ready to share the extended Wi-Fi network with your PCs and mobile devices. You may use the WPS method to connect devices to the extension networks created by the DAP-1620 using the following network names (SSID). The password(s) will be the same as the wireless network you are extending.

- 2.4 GHz: **(Your router's SSID)-EXT**
- 5 GHz: **(Your router's SSID)-EXT5G**

Using the 5 GHz extension network is recommended in order to achieve the fastest wireless speeds.



Poor
Connection



Ok
Connection



Good
Connection



Best
Connection

QRS Mobile App Setup

The DAP-1620 can be set up from your iPhone, iPod touch, iPad, or Android smartphone or tablet device using the QRS Mobile app.

Note: The screenshots may be different depending on your mobile device's OS version.

Step 1

Search for the free **QRS Mobile** App on the Apple App Store or Google Play.

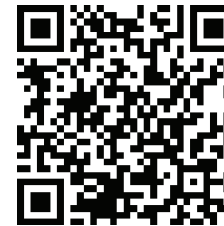

Step 2

Once your app is installed, you may now configure your extender. Connect to the router wirelessly by going to your wireless utility on your device. Scan for the Wi-Fi name (SSID) as listed on the supplied configuration card. Select and then enter your Wi-Fi password.

D-Link Wi-Fi Configuration Card	
Default Configuration	Wi-Fi Name (SSID) 2.4GHz:
Wi-Fi Name (SSID):	Wi-Fi Password:
dlink-a8fa	Wi-Fi Name (SSID) 5GHz *:
Wi-Fi Password:	Wi-Fi Password *:
akbdj19368	
Your configuration	
To configure your router, go to:	Username: "Admin"
http://dlinkrouter.local	Password:
Or http://192.168.0.1	
Username: "Admin"	*For applicable models
Password: " (leave the field blank)	

DQW9W010010

Step 3

Once wirelessly connected to the extender, launch the QRS Mobile app from the Home screen of your device.

Note: The following steps show the iOS interface of the QRS Mobile app. If you are using an Android device, the appearance may be different to that of the screenshots, but the process is the same.



Click **Start** to continue.

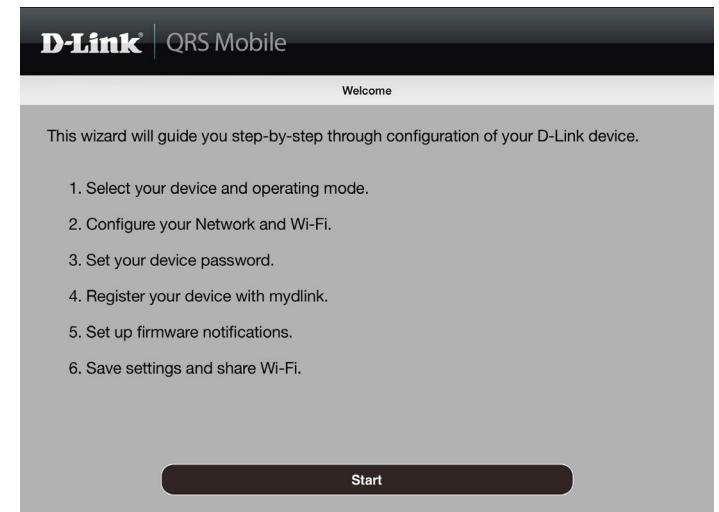

Click **Next** to continue.

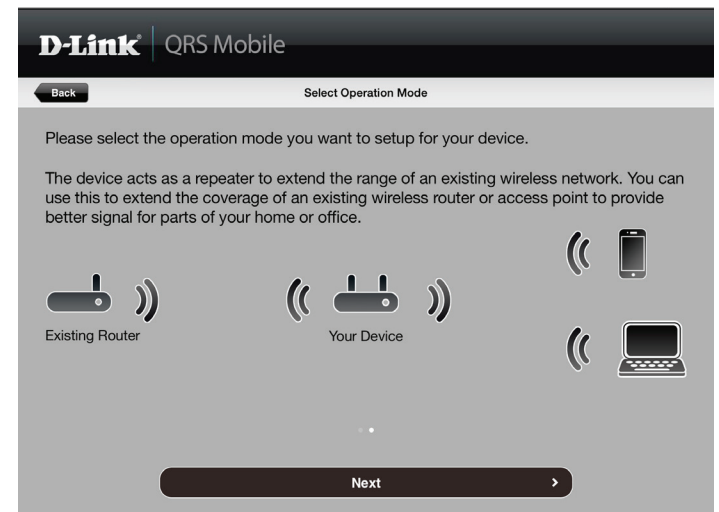

QRS Mobile will first detect your DAP-1620, then scan for available Wi-Fi networks. Select the network you wish to extend. Tap **Rescan** if your network doesn't show up the first time.

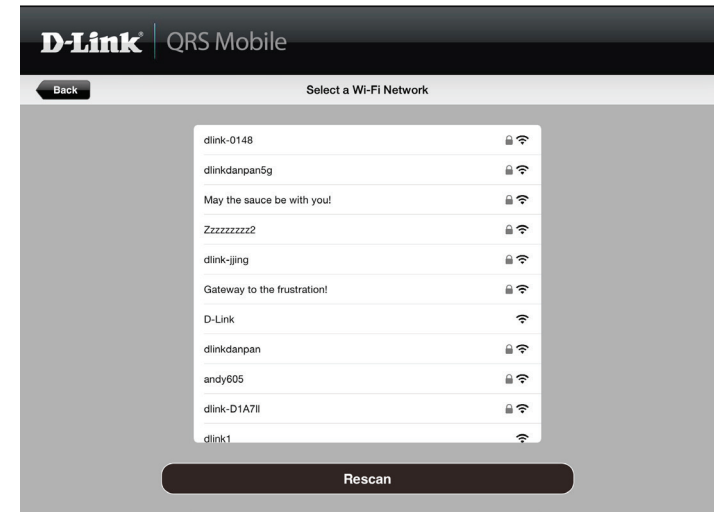

Enter a password for the existing Wi-Fi network. Click **Next** to continue.

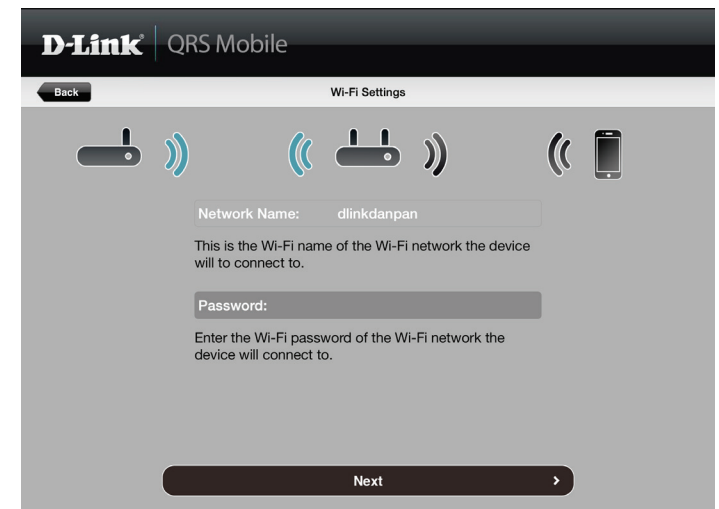

Enter a network name (SSID) and password for the extended Wi-Fi network. Click **Next** to continue.

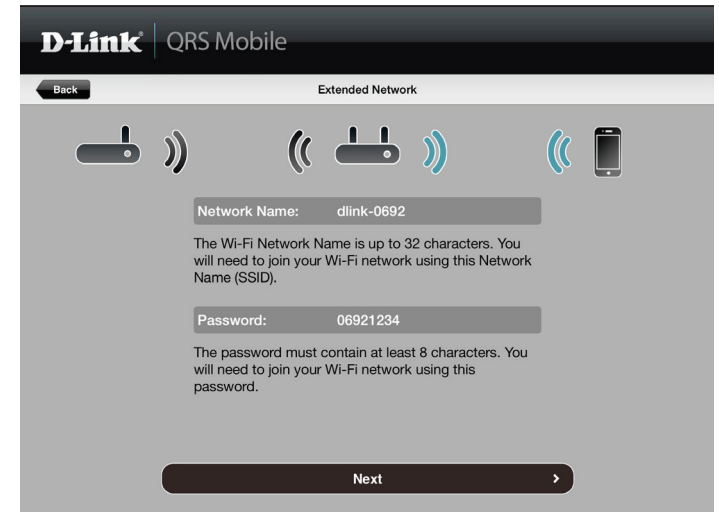

Create an admin password for the DAP-1620's web-based configuration utility. Click **Next** to continue.

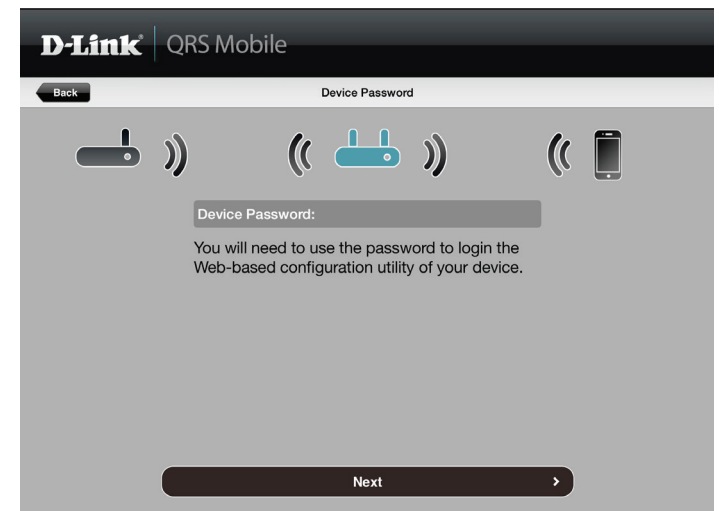

A summary of your settings will be displayed. Click **Save** to reboot the device and to complete the setup.

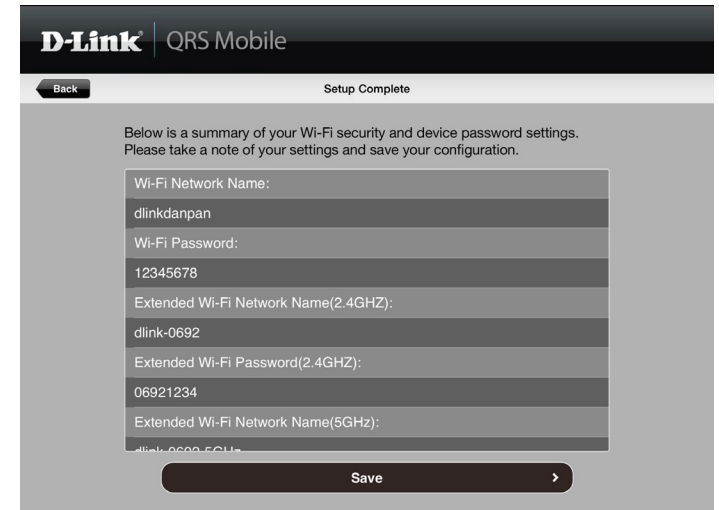

After the setup wizard is complete, the following screen will appear. To connect to the extended network, you can now change your mobile device and laptop Wi-Fi settings to the wireless network name and password you just created. You can also share your Wi-Fi information by clicking **Share by E-mail**.

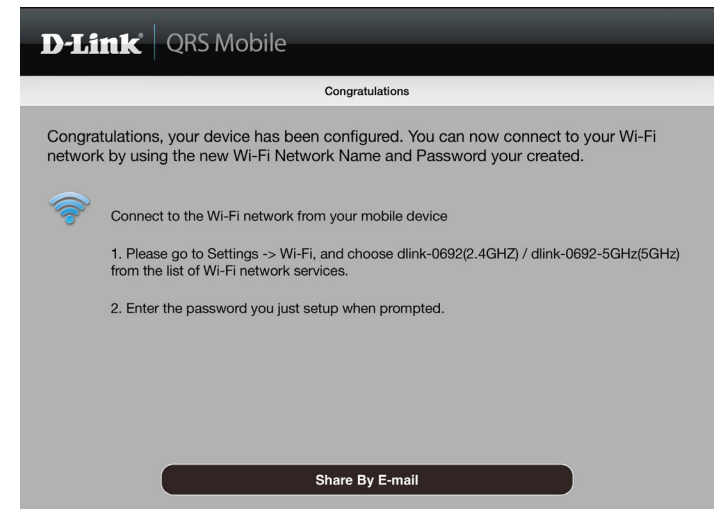

Web-based Setup

To access the setup utility for the DAP-1620 AC1200 Wi-Fi Range Extender on your PC, first connect to the DAP-1620 wirelessly using the Wi-Fi name (SSID) and password located on your Wi-Fi Configuration Card. Then open a web browser and enter **http://dlinkap.local./** in your browser's URL field. You may also enter the IP address* of the DAP-1620.

* The default IP address is 192.168.0.50. Once your DAP-1620 connects to the host network, it will be assigned a new IP address based on your network's DHCP settings. You will need to log in to your router to see what IP address is assigned to your DAP-1620. For multiple DAP-1620s, go to **http://dlinkapxxxx.local.** as shown on the included Wi-Fi Configuration Card, with "xxxx" being the last four digits of the DAP-1620's MAC address.

Enter your password. By default, Admin is the username and cannot be changed, and by default, the password is blank.

The configuration interface will open, and you can configure the various settings for the DAP-1620. If you have not yet configured an uplink network, the home screen will show that there is no connection between the DAP-1620 and the uplink router.

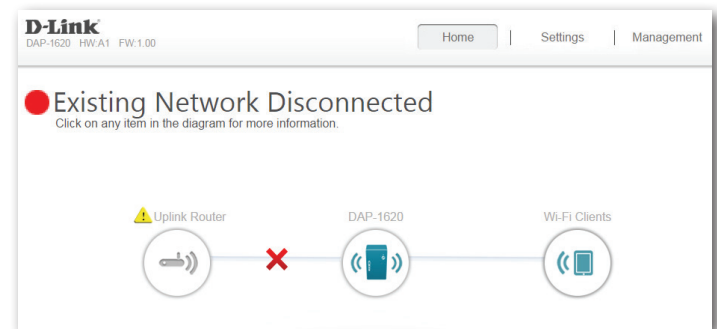
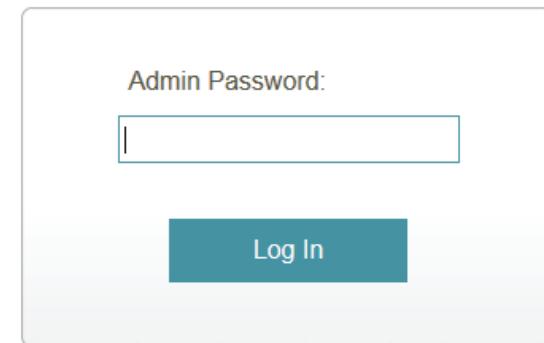
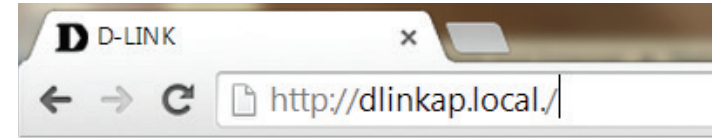

Setup Wizard

If this is your first time logging in to the extender and no connection has been established, the setup wizard will automatically appear.

In the future, if you wish to set up your extender using the setup wizard, click the **Uplink Router** icon.

The setup wizard is designed to guide you through a step-by-step process to configure your new DAP-1620 AC1200 Wi-Fi Range Extender to extend your wireless network and connect to the Internet.

The steps are:

Step 1: Connecting Your Device

Step 2: Configuring Your Settings

Step 3: Setting a Password for Your Device

Click **Next** to begin.

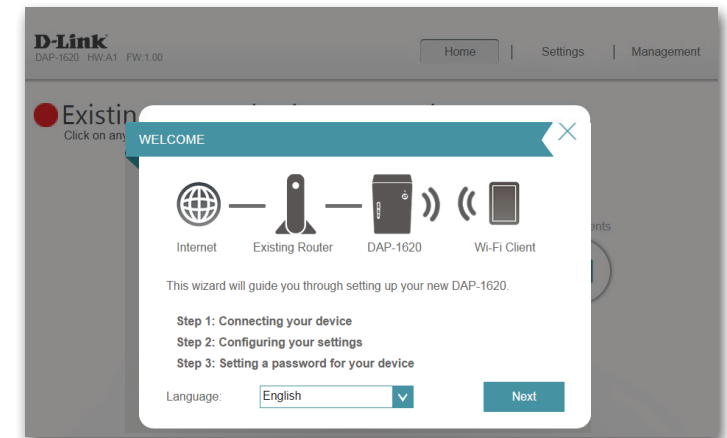
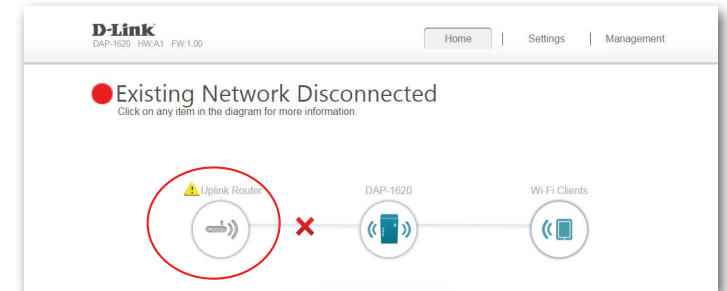

Connecting Your Device via WPS

After clicking the **Next** button from the previous step, the DAP-1620 will automatically initiate a WPS-PBC (Wireless Protected Setup - Push Button Control) search to find an uplink network to extend. If your existing wireless networking device has a physical or virtual WPS button, press or enable it within the 120 seconds allotted by the countdown timer.

If you do not wish to use WPS or your existing networking device does not have a WPS feature, select one of the alternative configuration options:

Extend an existing network, see page 23 for more information or

Add wireless to your wired network, see page 26 for further setup information.

Once the 120 second timer has elapsed, proceed to the next page.

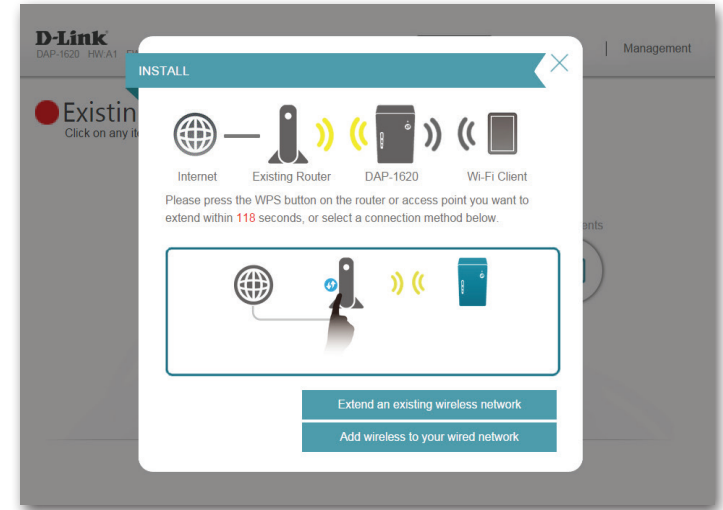

WPS Successful

If a WPS connection is successfully established you will be prompted to configure your extension network settings. The current network names and passwords will be displayed.

You may now rename the 2.4 GHz and 5 GHz networks. If you wish to input different passwords for each network, deselect **use the same password for both networks** and create new passwords.

Please be sure to note any changes you make as these credentials will be required for wireless clients wishing to join your network.

Click **Next** to proceed to **Configure Administrator Password**, refer to page 28 for more information, or click **Back** to return to the previous step.

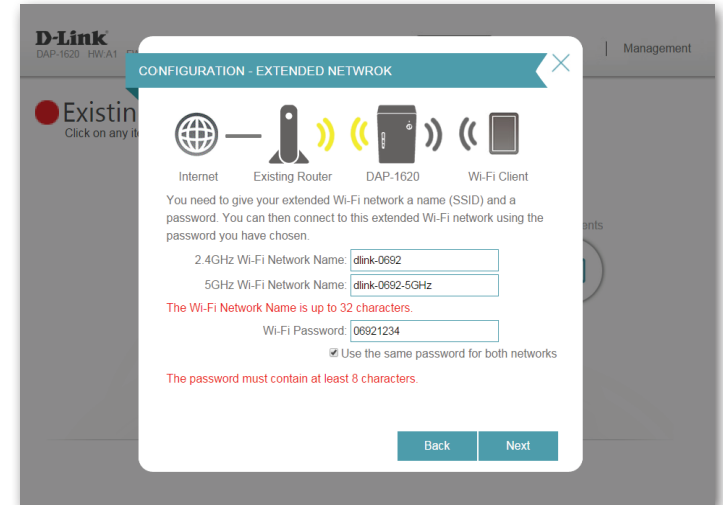

*Wireless network names and passwords are shown for example only.

WPS Unsuccessful

If the WPS countdown timer expires, and no connection to an uplink wireless network could be established, you may press the **retry** button to attempt the process again or if you do not wish to use WPS, or are having difficulty using the WPS feature, you can try using one of the alternative configuration options:

Extend an existing network, see page 23 for more information or

Add wireless to your wired network, see page 26 for further setup information.

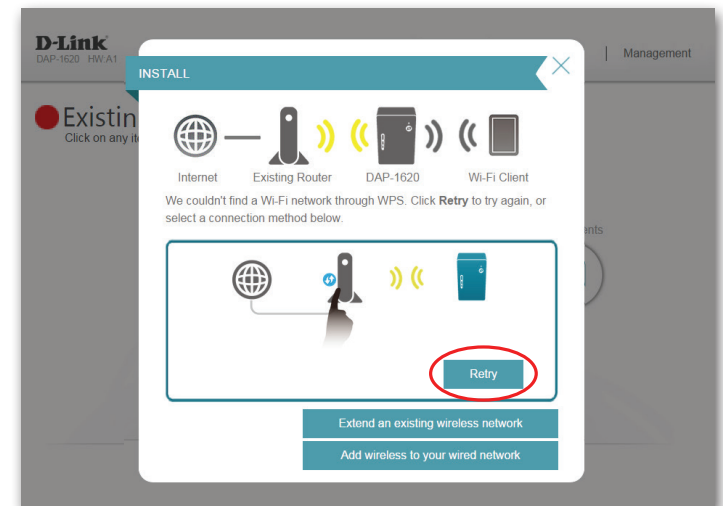

Extend an Existing Network

To set up your network manually, select **Extend an Existing Network** from the setup wizard menu. Click **Next** to continue.

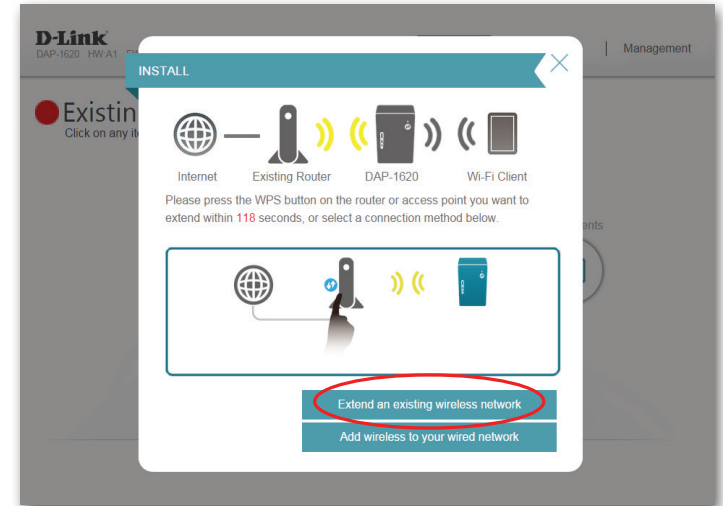

The DAP-1620 will scan for available wireless networks and display a list of results. You may choose one of the following options to proceed:

- If the wireless network you wish to extend was detected by the scan, click on the network to select it. The extender will automatically forward you to the next step.
- If the network you would like to extend was not detected by the scan, click the **Manual** button.

Note: If the wireless network you would like to extend to was not detected by the scan, your DAP-1620 might be out of range and you may need to reposition the extender closer to the host network device.

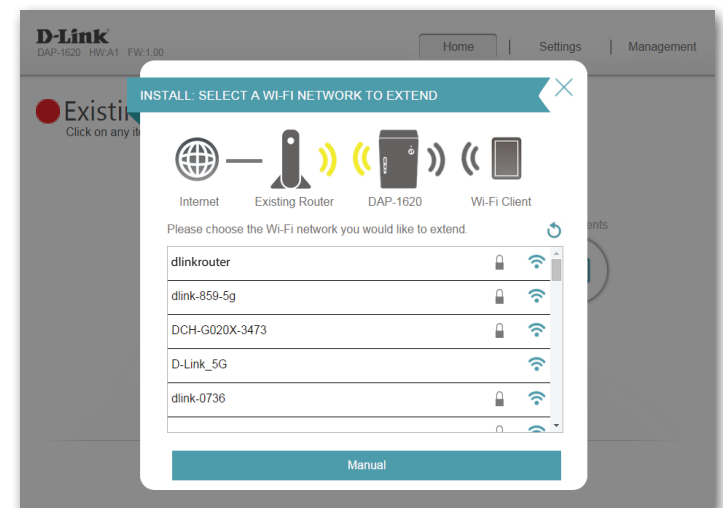

If the wireless network you wish to extend was detected by the scan, enter the password now.

Click **Next** to continue on to configure your extension network settings, or click **Back** to return to the previous step.

If you chose **Manual**, enter the Wireless Network Name, type of Security, and Password of the existing Wi-Fi network you wish to connect to.

Click **Next** to continue on to configure your extension network settings, or click **Back** to return to the previous step.

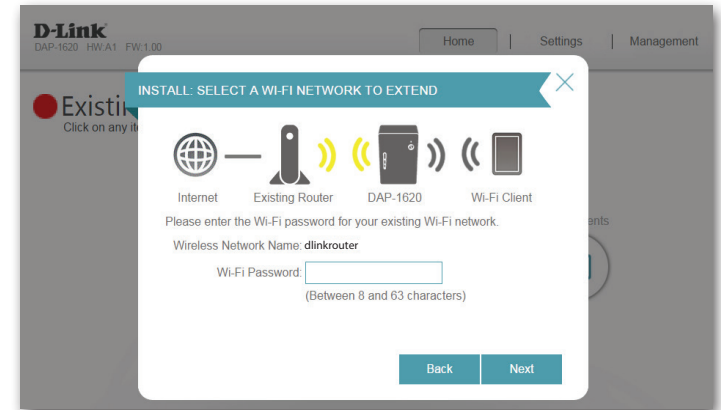

If a connection is successfully established you will be prompted to configure your extension network settings. The current network names and passwords will be displayed.

You may now rename the 2.4 GHz and 5 GHz networks. If you wish to input different passwords for each network, deselect **use the same password for both networks** and create new passwords.

Please be sure to note any changes you make as these credentials will be required for wireless clients wishing to join your network.

Click **Next** to proceed to **Configure Administrator Password**, refer to page 28 for more information, or click **Back** to return to the previous step.

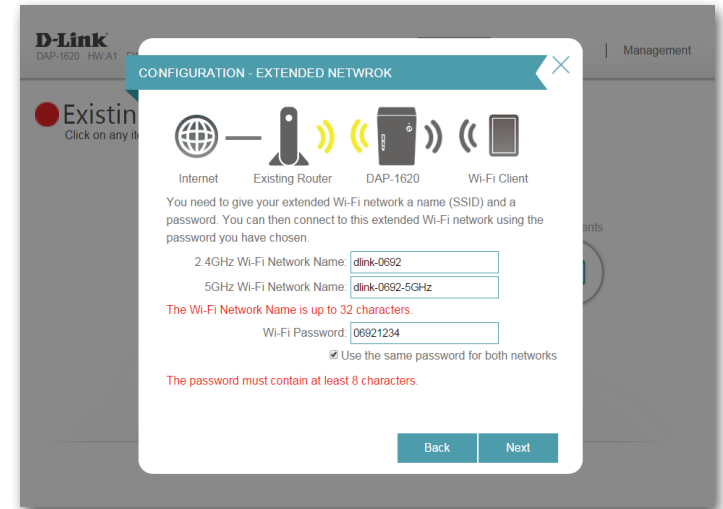

*Wireless network names and passwords are shown for example only.

Add Wireless to Your Wired Network

This portion of the setup wizard will guide you through adding a wireless network to an existing wired network. Click **Add wireless to your wired network** to proceed.

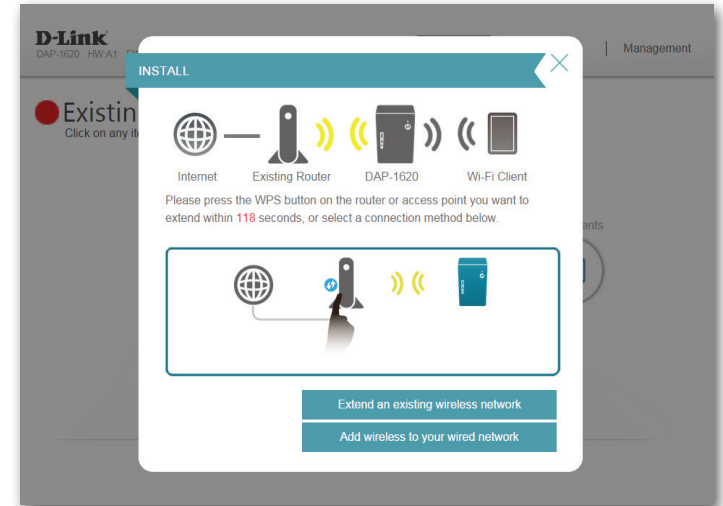

Connect an Ethernet cable to your DAP-1620 if you have not already done so. After making the connection, you will automatically be forwarded to the next step. If you haven't connected an Ethernet cable yet, but will do so later, click **skip**.

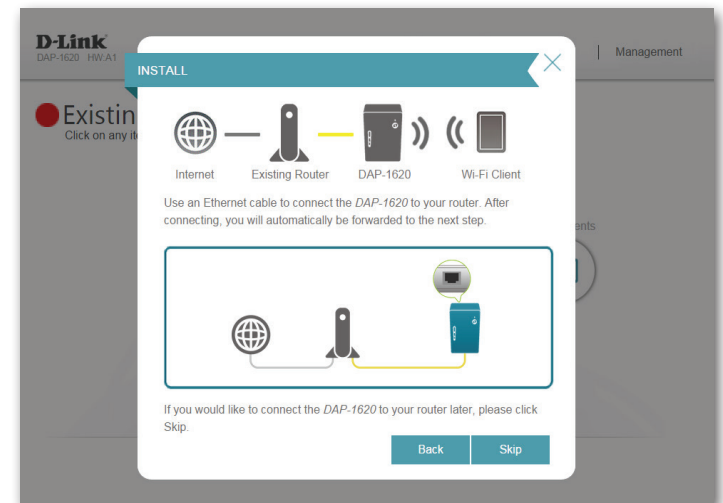

If a connection is successfully established you will be prompted to configure your wireless network settings. The current network names and passwords will be displayed.

You may now rename the 2.4 GHz and 5 GHz networks. If you wish to input different passwords for each network, deselect **use the same password for both networks** and create new passwords.

Please be sure to note any changes you make as these credentials will be required for wireless clients wishing to join your network.

Click **Next** to proceed to **Configure Administrator Password**, refer to page 28 for more information, or click **Back** to return to the previous step.

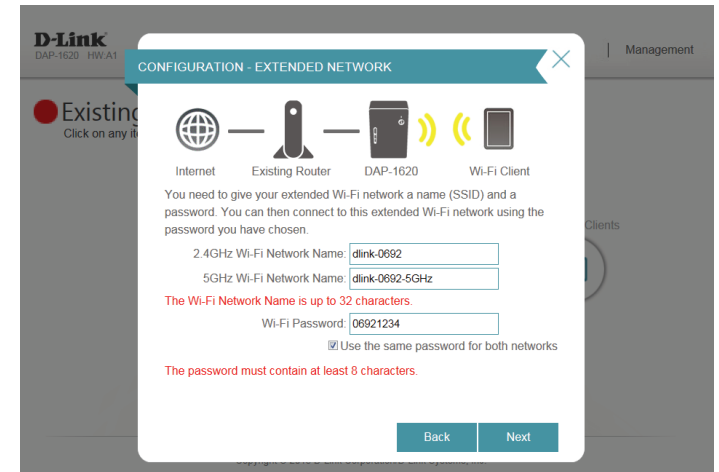

*Wireless network names and passwords are shown for example only.

Configure Administrator Password

In order to secure the extender's web configuration utility, please enter a new password. You will be prompted for this password each time you want to use the extender's web configuration utility. Click **Next** to continue onward to **Save Your Configuration**.

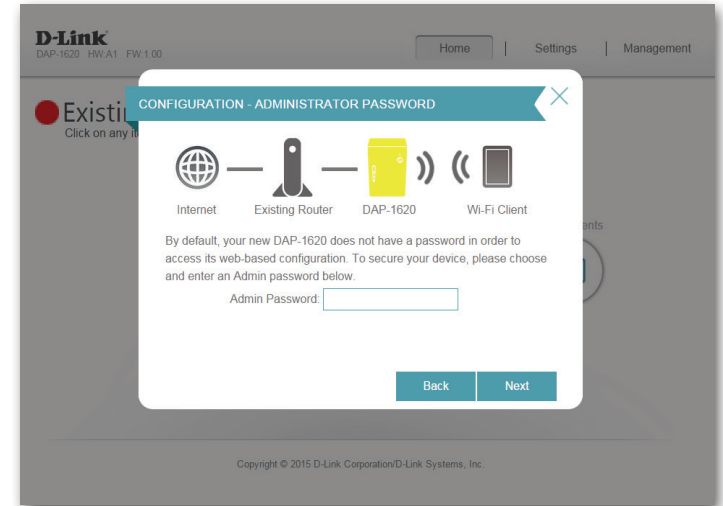

Save Your Configuration

At the end of the wizard, you will be presented with a final summary of your settings. It is recommended that you record this information for future reference. Click **Finish** to close the wizard.

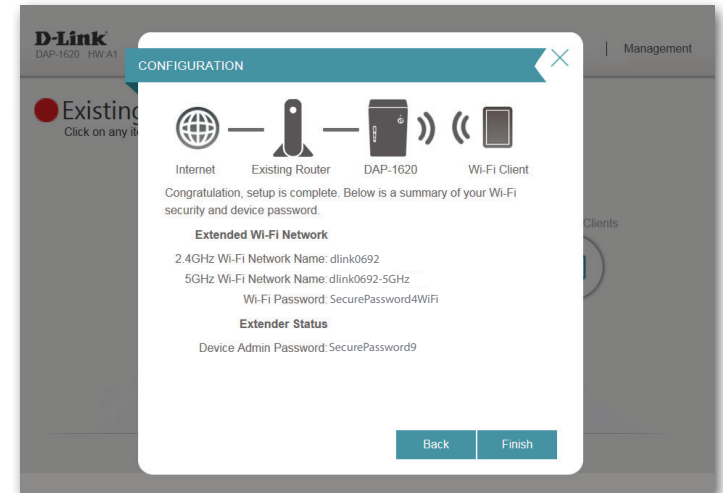

*Wireless network names and passwords are shown for example only.

You will be asked if you wish to create a bookmark to the web configuration utility.

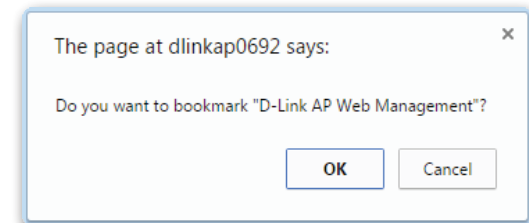

Your changes will be saved and the extender will reboot.

Devices may be connected to the new wireless extension network(s) once the extender successfully reboots.

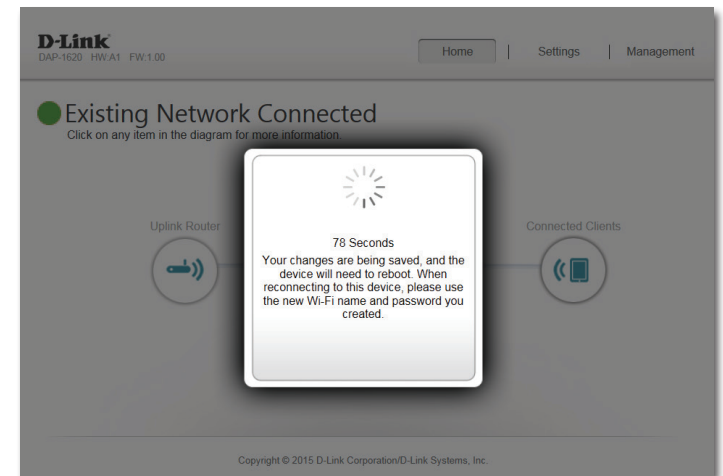

Configuration Home

The home screen gives a summary of the current status of devices connected to the DAP-1620. A green check between the device and the uplink router indicates that there is an active connection. A red cross indicates that there is no connection present, or there is a connection error. If there's no active uplink connection, click on the Uplink Router icon to start the setup wizard.

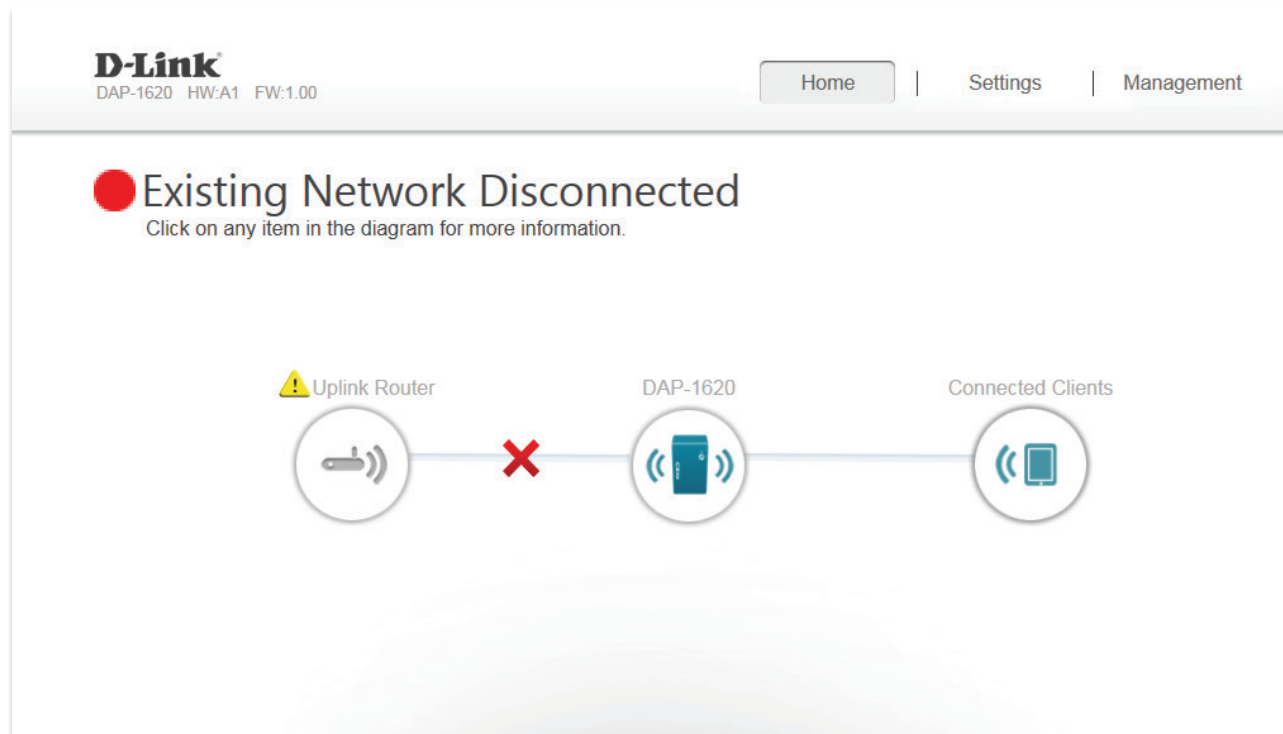

Uplink Router: This icon shows the status of the Internet connection to the uplink router. It is grey if the DAP-1620 is not connected to an uplink router. Once connected, click on it to see its connection details.

DAP-1620: Click on this icon to see details of the uplink network the DAP-1620 is connected to or connect to another uplink router..

Connected Clients: Click on the Wi-Fi Clients icon to see client details.

Once your Internet connection is set up, you can view the details of both the uplink network and the extended Wi-Fi network by clicking on the DAP-1620 icon.

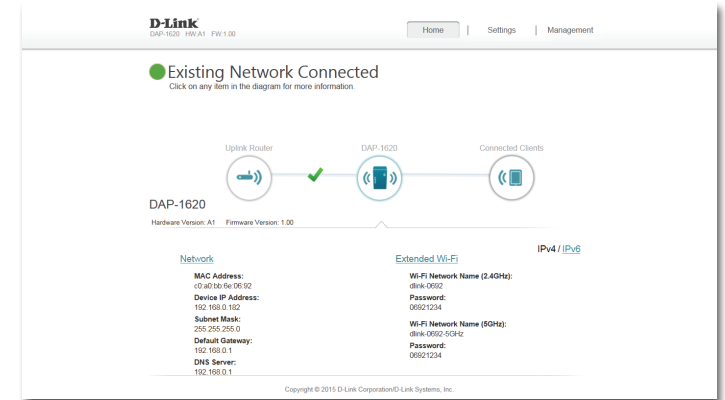

Upon clicking the Uplink Router icon, you will see the connection type, network status, connection up time, network name (SSID), and password.

If you wish to connect to a different uplink router, press the **Connect to a different uplink router** button.

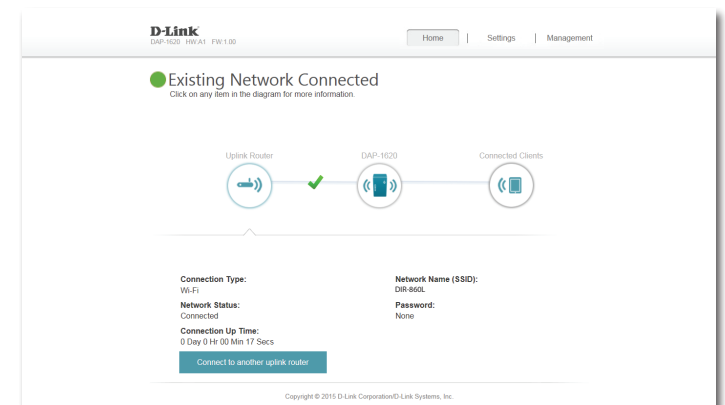

After clicking **Connect to a different uplink router** a survey of available wireless networks will be performed. After clicking **Select** you will be prompted for the uplink router password. Enter it and click **Connect**.

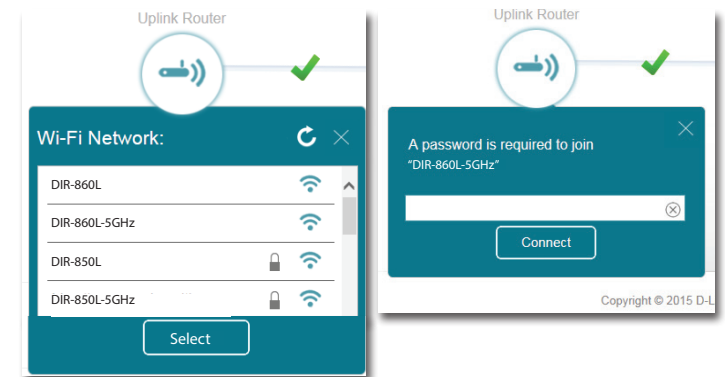

Settings

Extender Settings

This page lets you configure the settings for the DAP-1620's extended wireless network. To access this page, click the **Settings** drop-down menu at the top of the page, and select Extender. Click **Save** to apply the settings and return to the home page.

Existing Network

Existing Network: Select the type of existing network, either **Ethernet** or **Wi-Fi** you want the DAP-1620 to connect to.

2.4 GHz Extended Wi-Fi

Status: Enable or disable this network by toggling this slider.

Wi-Fi Name (SSID): This is the name of the DAP-1620's extended network. If using **Wi-Fi**, the DAP-1620 will rebroadcast the uplink router's Internet connection under this SSID. You may also manually set the SSID of the extended network.

Security: Select the type of wireless security you wish to use for the extended network. Choose **None** or **WPA/WPA2 Personal**.

Password: Enter the password or network key that you wish to use for the extended network.

Wi-Fi Channel: Select **Auto** or any channel from 1 to 11 for use with this network.

Channel Width: Select **Auto 20/40** or **20 MHz** for the bandwidth you wish this network to use.

HT20/40 Coexistence: Enable or disable HT20/40 coexistence by toggling the slider.

The screenshot displays the D-Link Extender Settings interface. At the top, the D-Link logo and model information (DAP-1620 HW:A1 FW:1.00) are visible, along with navigation links for Home, Settings, and Management. The main heading is "Extender", with a sub-instruction: "Use this section to configure the wireless settings for your DAP-1620. Please ensure you press Save after any changes made in this section for it to take effect." Below this, there is a "Settings >> Wireless" breadcrumb and a "Save" button. The "Existing Network" section has a dropdown menu set to "Ethernet". The "2.4GHz Extended Wi-Fi" section includes a "Status" slider set to "Enabled", a "Wi-Fi Name(SSID)" field with "dlink-0692", a "Security" dropdown set to "WPA/WPA2-Personal", a "Password" field with masked characters, a "Wi-Fi Channel" dropdown set to "Auto", a "Channel Width" dropdown set to "Auto 20/40 MHz", and an "HT20/40 coexistence" slider set to "Enabled". The "5GHz Extended Wi-Fi" section has a "Status" slider set to "Enabled", a "Wi-Fi Name(SSID)" field with "dlink-0692-5GHz", a "Security" dropdown set to "WPA/WPA2-Personal", a "Password" field with masked characters, a "Wi-Fi Channel" dropdown set to "Auto", and a "Channel Width" dropdown set to "Auto 20/40/80 MHz". A copyright notice "Copyright © 2015 D-Link Corporation/D-Link Systems, Inc." is at the bottom.

5 GHz Extended Wi-Fi

Status: Enable or disable this 5 GHz network by toggling this slider.

Wi-Fi Name (SSID): This is the name of the DAP-1620's extended network. If using **Wi-Fi**, the DAP-1620 will rebroadcast the uplink router's Internet connection under this SSID. You may also manually set the SSID of the extended network.

Security: Select the type of wireless security you wish to use for the extended network. Choose **None** or **WPA/WPA2 Personal**.

Password: Enter the password or network key that you wish to use for the extended 5 GHz network.

Wi-Fi Channel: Select **Auto** or any channel for use with this network.

Channel Width: Select **Auto 20/40/80, 20 MHz, or 20/40 MHz** for the bandwidth you wish this network to use.

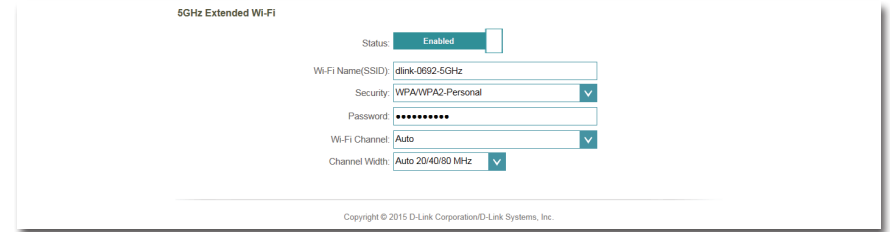

Network Settings

This page lets you configure the network settings for the DAP-1620. To access this page, click the **Settings** drop-down menu at the top of the page, then select **Network**. Click **Save** at any time to save the changes you have made on this page.

Management Link: You can change the URL name of the device by editing the text in the text box. If you change the name of the device, you will need to enter "http://xxxx.local." (where "xxxx" corresponds to the name of the device) in the address bar of your web browser in order to access the configuration utility.

Settings >> Network Save

Network Settings

Device Name: http:// .local [Advanced Settings...](#)

Advanced Settings

The Advanced Settings section of the Network Settings page allows you to configure both IPv4 and IPv6 settings that will be used by the DAP-1620's extended network.

IPv4 Device Management Interface

My LAN Connection is: Here you can select whether you want the IP to have a **Dynamic IP** or **Static IP** address. If you select Dynamic IP, the options below will not be available.

IP Address: Enter the Static IP address that you want to assign to the extended network AP. This address should be outside of the uplink router's DHCP address pool.

Subnet Mask: Enter the subnet mask.

Gateway Address: Enter the gateway address. This is usually the IP address of the uplink router.

Primary DNS Server: Enter the address of the primary DNS server.

Secondary DNS Server: Enter the address of the secondary DNS server. This is optional but will provide backup if the primary server fails.

IPv4 Device Management Interface

Choose a IPv4 provisioning mechanism to be used by the AP.

My LAN Connection is: ▼

IP Address:

Subnet Mask:

Gateway Address:

Primary DNS Server:

Secondary DNS Server:

Autoconfiguration (SLAAC/DHCPv6)

IPv6 Device Management Interface

My IPv6 Connection is: Select **Autoconfiguration (SLAAC/DHCPv6)** to have the DAP-1620 automatically receive an IPv6 address from the uplink router.

Obtain IPv6 DNS Servers Automatically: You can select to obtain IPv6 DNS server information automatically, or you can select to configure DNS servers manually by clicking on the radio dial next to the option.

Primary DNS Server: For manual settings, enter the primary IPv6 DNS server address.

Secondary DNS Server: For manual settings, enter the secondary IPv6 DNS server address. This is optional but will provide backup if the primary server fails.

The screenshot shows the 'IPv6 Device Management Interface' configuration page. At the top, it says 'Choose a IPv6 provisioning mechanism to be used by the AP.' Below this, there is a dropdown menu labeled 'My IPv6 Connection is:' with 'Autoconfiguration (SLAAC/DHCPv6)' selected. Underneath, it says 'Obtain a DNS server address automatically or enter a specific DNS server address.' There are two radio button options: 'Obtain IPv6 DNS Servers automatically' (which is unselected) and 'Use the following IPv6 DNS Servers' (which is selected). At the bottom, there are two input fields: 'Primary DNS Server:' and 'Secondary DNS Server:'. The 'Secondary DNS Server' field is currently empty.

Static IPv6

IPv6 Device Management Interface

My IPv6 Connection is: Select **Static IPv6** to manually assign an IP address to the DAP-1620.

IPv6 Address: Enter the IPv6 address that you want to assign to the extended network AP. This address should be outside of the uplink router's DHCP address pool.

Subnet Prefix Length: Enter the length of the IPv6 subnet prefix.

Default Gateway: Enter the default gateway.

Primary DNS Server: Enter the primary IPv6 DNS server address.

Secondary DNS Server: Enter the secondary IPv6 DNS server address. This is optional but will provide backup if the primary server fails.

The screenshot shows the 'IPv6 Device Management Interface' configuration page. At the top, it says 'Choose a IPv6 provisioning mechanism to be used by the AP.' Below this, there is a dropdown menu labeled 'My IPv6 Connection is:' with 'Static IPv6' selected. Underneath, it says 'Enter the IPv6 address information that you would like to use to access the Web-based management interface.' There are five input fields: 'IPv6 Address:', 'Subnet Prefix Length:', 'Default Gateway:', 'Primary DNS Server:', and 'Secondary DNS Server:'.

Link-local Only

IPv6 Device Management Interface

My IPv6 Connection is: Select **Link-local only** to only set an IPv6 address for the local network.

LAN IPv6 Link-Local Address: The link-local address of the DAP-1620.

IPv6 Device Management Interface
Choose a IPv6 provisioning mechanism to be used by the AP.

My IPv6 Connection is: 

The LAN IPv6 Link-Local Address is the IPv6 Address that you use to access the Web-based management interface.

LAN IPv6 Link-Local Address: FE80::CABE:19FF:FEE5:1411/64

Management Admin

This page will allow you to set a new password for the administrator account used to configure the DAP-1620. You can also enable graphical authentication (CAPTCHA) on this page. To access this page, click the **Management** drop down menu at the top of the page, and select **Admin**. Click **Save** at any time to save the changes you have made on this page.

Admin Password: Enter the Admin password.

Enable Graphical Authentication: Click on the slider to enable graphical authentication, or CAPTCHA. This provides an extra layer of security by requiring you to enter a code that is displayed on-screen. This can help prevent unauthorized users from gaining access to your wireless network using automated methods.

Note: The device will reboot after saving the changes in order for the password to take effect.

System

This page allows you to save or restore your system configuration, reset, or reboot the DAP-1620. To access this page, click the **Management** drop down menu at the top of the page, and select **System**. Click **Save** at any time to save the changes you have made on this page.

Save Settings To Local Hard Drive: Save the system settings onto a file to the local hard drive. You will then see a file dialog where you can select a location and enter a file name for the configuration file.

Load Settings From Local Hard Drive: Load the system settings from a previously saved file on the local hard drive.

Restore to Factory Default Settings: Restore the system settings to factory default settings. This will erase all currently stored settings.

Reboot the Device: Click **Reboot** to reboot the DAP-1620.

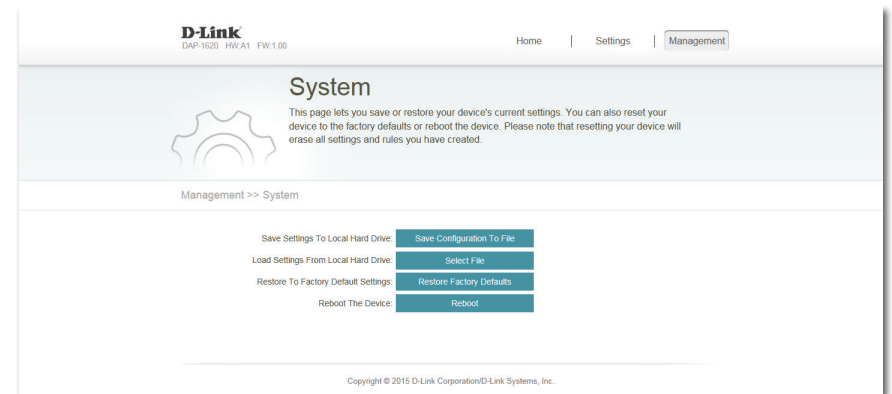

Upgrade

Firmware and language upgrades may be provided for the DAP-1620 in the future. You can check and upgrade your firmware and language pack on this page. To access this page, click the **Management** drop down menu at the top of the page, and select **Upgrade**. Click **Save** at any time to save the changes you have made on this page.

Firmware Information

Firmware Information: This section displays the currently installed firmware version, as well as the date on which the current firmware version was released.

Click **Check For New Firmware** to find out if there is new or updated firmware. If there is, you can download it to your computer.

Upgrade Manually

Upgrade Firmware: Click **Select File** to locate the firmware file on your computer and perform a manual firmware upgrade.

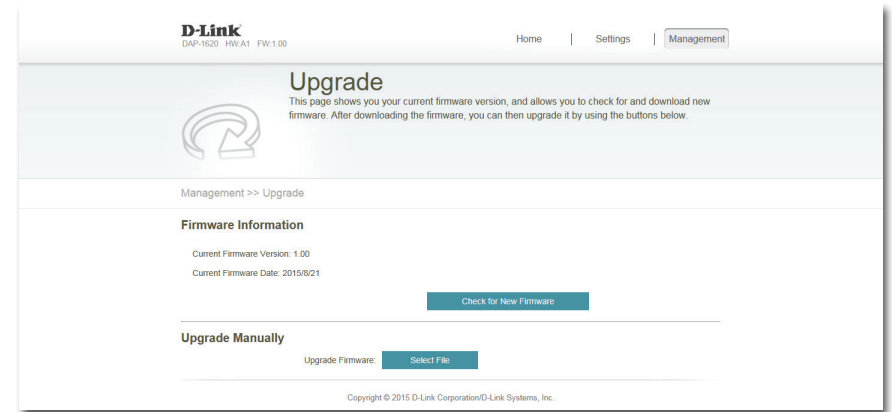

Statistics

This page displays details about your wireless and network connections. To access this page, click the **Management** drop-down menu at the top of the page, and select **Statistics**. Click **Clear** to reset the statistics.

Wi-Fi

Click on the **Wi-Fi** tab to display the statistics for the connection between the DAP-1620 and the uplink router.

The Blue line indicates the upload speeds and the red line indicates the download speeds.

The table displays the following in real-time:

- Total Packets
- Total Byte(s)
- Total Kbit(s)
- Kbits/sec

Extended Wi-Fi

Click on the **Extended Wi-Fi** tab to display the statistics for the connection between the DAP-1620 and any connected clients.

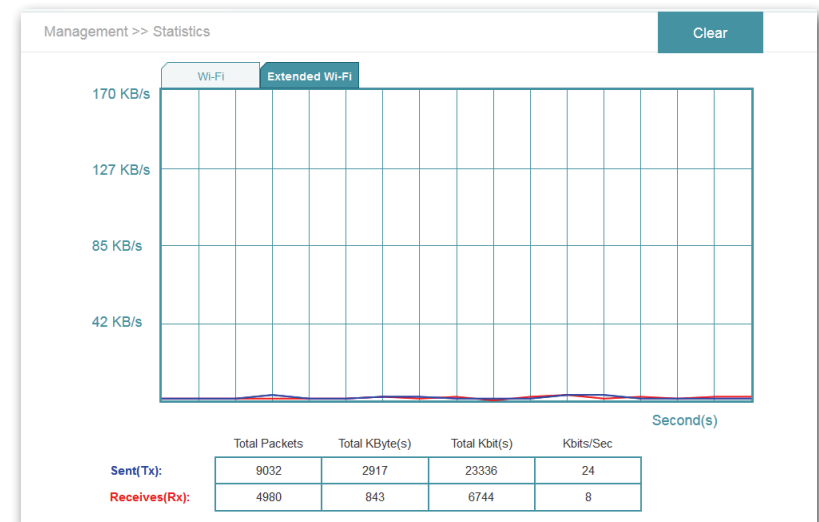

Connecting Wireless Clients to the Extended Network

WPS Button

Once an uplink network has been established, you may use the DAP-1620's WPS function to add additional wireless clients to your extended network. Many wireless devices such as wireless routers, media players, printers, and cameras will have a WPS button (or a software utility with WPS) that you can press to connect to the DAP-1620. Please refer to the user manual for the wireless device you want to connect to make sure you understand how to enable WPS. Once you know, follow the steps below:

- Step 1** - Press the WPS button on the DAP-1620 for about 1 second. The LED on the device will start to blink. You can also use the WPS option in the setup wizard section of the web interface.
- Step 2** - Within 120 seconds, press the WPS button on your wireless device.
- Step 3** - Allow up to 1 minute to configure. Once the LED light stops blinking and turns solid green, you will be connected and your wireless connection will be secured with WPA2.

Windows® 8

WPA/WPA2

It is recommended to enable wireless security (WPA/WPA2) on your wireless router or extender before configuring your wireless adapter. If you are joining an existing network, you will need to know the security key (Wi-Fi password) being used.

To join an existing network, locate the wireless network icon in the taskbar, next to the time display.



Clicking on this icon will display a list of wireless networks which are within connecting proximity of your computer. Select the desired network by clicking on the network name.

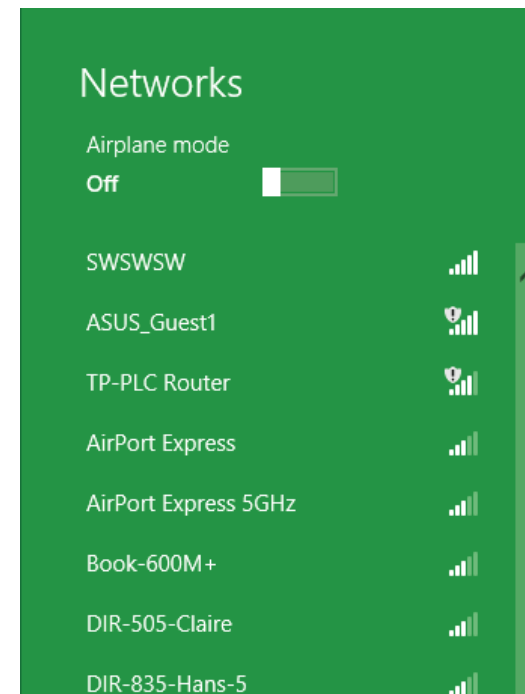

You will then be prompted to enter the network security key (Wi-Fi password) for the wireless network. Enter the password into the box and click **Next**.

If you wish to use Wi-Fi Protected Setup (WPS) to connect to the router, you can also press the WPS button on your router at this point to enable the WPS function.

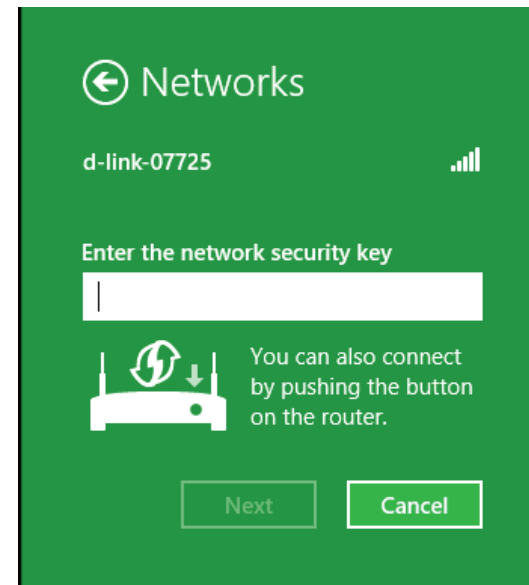

When you have established a successful connection with a wireless network, the word **Connected** will appear next to the name of the network to which you are connected.

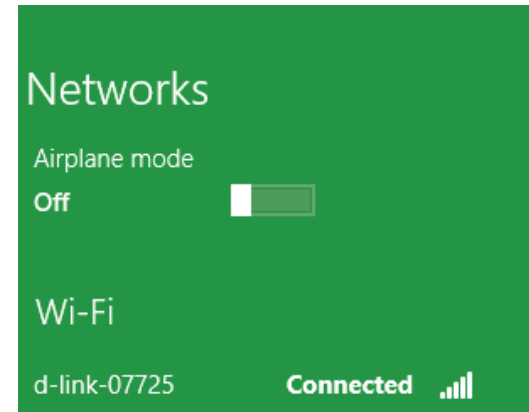

Windows® 7

WPA/WPA2

It is recommended to enable wireless security (WPA/WPA2) on your wireless router or extender before configuring your wireless adapter. If you are joining an existing network, you will need to know the security key or passphrase being used.

1. Click on the wireless icon in your system tray (lower-right corner).

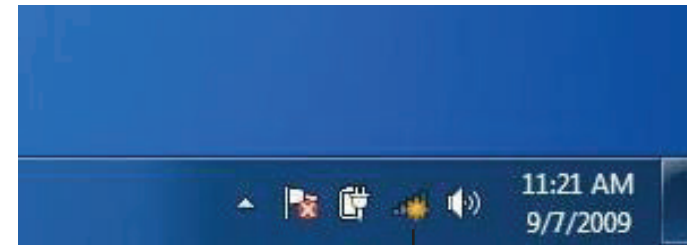

Wireless Icon

2. The utility will display any available wireless networks in your area.



3. Highlight the wireless network (SSID) you would like to connect to and click the **Connect** button.

If you get a good signal but cannot access the Internet, check your TCP/IP settings for your wireless adapter. Refer to the Wireless Basics section in this manual for more information.



4. The following window appears while your computer tries to connect to the router.

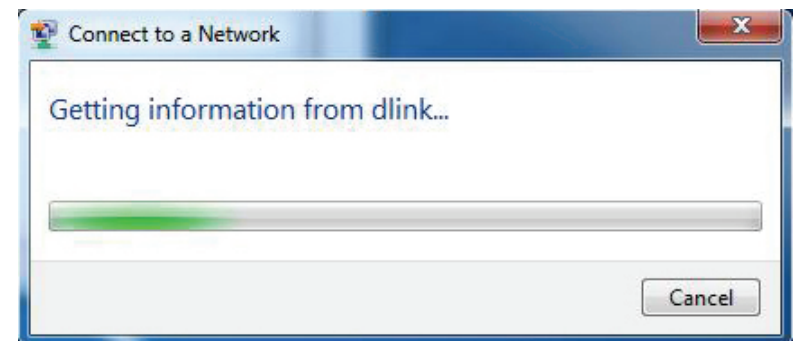

5. Enter the same security key or passphrase that is on your router and click **Connect**.

It may take 20-30 seconds to connect to the wireless network. If the connection fails, please verify that the security settings are correct. The key or passphrase must be exactly the same as on the wireless router.

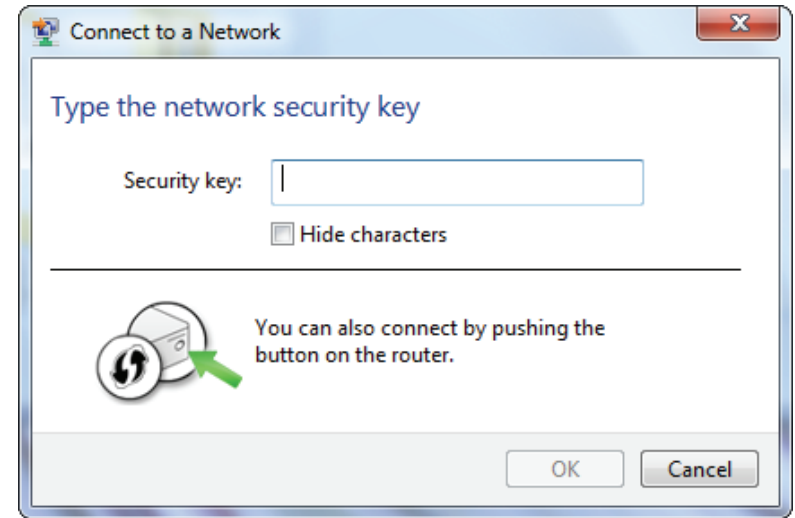

Windows Vista®

Windows Vista® users may use the built-in wireless utility. If you are using another company's utility or Windows® 2000, please refer to the user manual of your wireless adapter for help with connecting to a wireless network. Most utilities will have a "site survey" option similar to the Windows Vista® utility as seen below.

If you receive the "Wireless Networks Are Available" bubble, click on the center of the bubble to access the utility.

or

Right-click on the wireless computer icon in your system tray (lower-right corner next to the time). Select **Connect to a network**.

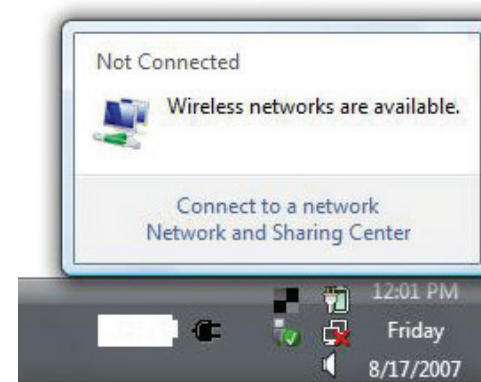

The utility will display any available wireless networks in your area. Click on a network (displayed using the SSID) and click **Connect**.

If you get a good signal but cannot access the Internet, check the TCP/IP settings for your wireless adapter. Refer to "Troubleshooting" on page 51 for more information.

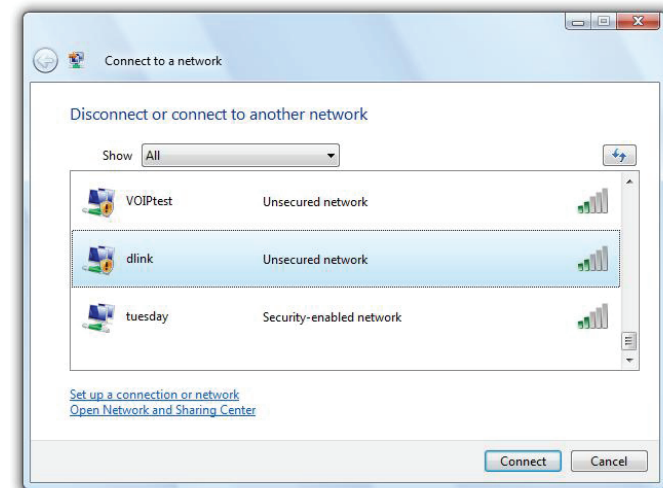

WPA/WPA2

It is recommended to enable wireless security (WPA/WPA2) on your wireless router or extender before configuring your wireless adapter. If you are joining an existing network, you will need to know the security key or passphrase being used.

1. Open the Windows Vista® Wireless Utility by right-clicking on the wireless computer icon in your system tray (lower right corner of screen). Select **Connect to a network**.

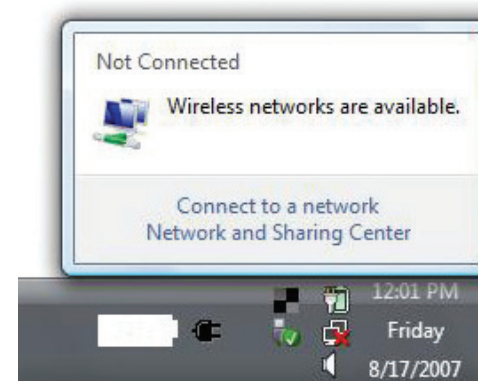

2. Highlight the wireless network (SSID) you would like to connect to and click **Connect**.

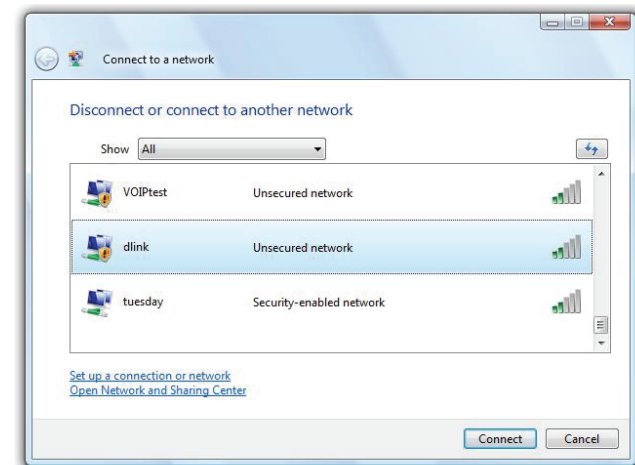

3. Enter the same security key or passphrase that is on your router and click **Connect**.

It may take 20-30 seconds to connect to the wireless network. If the connection fails, please verify that the security settings are correct. The key or passphrase must be exactly the same as on the wireless router.

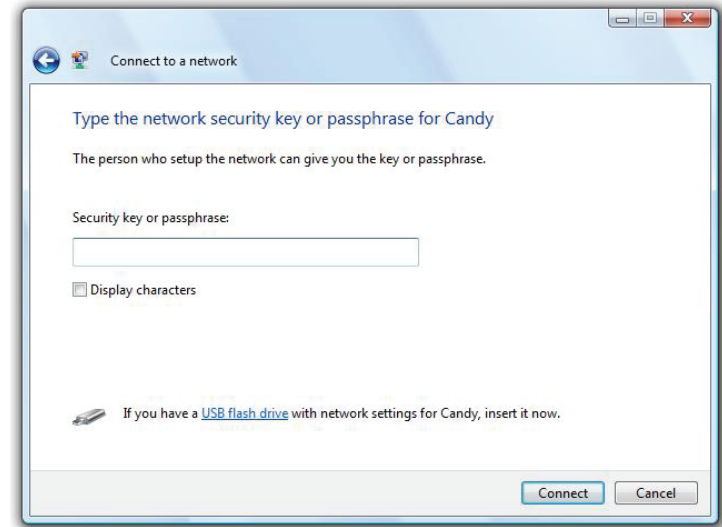

Troubleshooting

This chapter provides solutions to problems that can occur during the installation and operation of the DAP-1620. Read the following descriptions if you are having problems. The examples below are illustrated in Windows® XP. If you have a different operating system, the screenshots on your computer will look similar to the following examples.

1. Why can't I access the web-based configuration utility?

When entering the IP address of the AC1200 Wi-Fi Range Extender (dlinkap.local for example), you are not connecting to a website nor do you have to be connected to the Internet. The device has the utility built-in to a ROM chip in the device itself. Your computer must be on the same IP subnet to connect to the web-based utility.

- Make sure you have an updated Java-enabled web browser. We recommend the following:
 - Internet Explorer 9 or later
 - Firefox 20.0 or later
 - Safari 5.1 or later
 - Google Chrome 25.0 or later
- Make sure that you are connected to the same wireless network which is listed on the base of the DAP-1620. If you have an active wired LAN Ethernet connection, try temporarily unplugging the Ethernet cable from the computer you are using, as this may eliminate possible conflicts from having two simultaneous connections on the same computer.
- Disable any Internet security software running on the computer. Software firewalls such as ZoneAlarm, BlackICE, Sygate, Norton Personal Firewall, and Windows® XP firewall may block access to the configuration pages. Check the help files included with your firewall software for more information on disabling or configuring it.

- Configure your Internet settings:
 - Go to **Start > Settings > Control Panel**. Double-click the **Internet Options** icon. From the **Security** tab, click the button to restore the settings to their defaults.
 - Click the **Connection** tab and set the dial-up option to Never Dial a Connection. Click the LAN Settings button. Make sure nothing is checked. Click **OK**.
 - Go to the **Advanced** tab and click the button to restore these settings to their defaults. Click **OK** three times.
 - Close your web browser (if open) and open it.
- Access the web management interface. Open your web browser and enter the address of your extender (**http://dlinkap.local**) in the address bar. This should open the login page for your web management. If the DAP-1620 is not connected to an uplink router, you can try accessing the web interface using the default IP address **http://192.168.0.50**.
- If you still cannot access the configuration, unplug the extender from the power outlet for at least 10 seconds and plug it back in. Wait about 30 seconds and try accessing the configuration. If you have multiple computers, try connecting using a different computer.

2. What can I do if I forgot my password?

If you forgot your password, you must reset your extender. Unfortunately this process will change all your settings back to the factory defaults.

To reset the extender, locate the reset button (hole) on the underside panel of the unit. With the extender powered on, use a paperclip to hold the button down for 10 seconds. Release the button and the extender will go through its reboot process (indicated by the LED turning red). Wait about 30 seconds to access the extender. The default IP address is **http://dlinkap.local**. When logging in, the username is **admin** and leave the password box empty.

Wireless Basics

D-Link wireless products are based on industry standards to provide easy-to-use and compatible high-speed wireless connectivity within your home, business or public access wireless networks. Strictly adhering to the IEEE standard, the D-Link wireless family of products will allow you to securely and conveniently access your network. You will be able to enjoy the freedom that wireless networking delivers.

A wireless local area network (WLAN) is a cellular computer network that transmits and receives data with radio signals instead of wires. Wireless LANs are used increasingly in both home and office environments, and public areas such as airports, coffee shops and universities. Innovative ways to utilize WLAN technology are helping people to work and communicate more efficiently. Increased mobility and the absence of cabling and other fixed infrastructure have proven to be beneficial for many users.

Wireless users can use the same applications they use on a wired network. Wireless adapters used on laptop and desktop systems support the same protocols as Ethernet adapter cards.

Under many circumstances, it may be desirable for mobile network devices to link to a conventional Ethernet LAN in order to use servers, printers or an Internet connection supplied through the wired LAN. A wireless router is a device used to provide this link.

Tips

Here are a few things to keep in mind when you are installing your AC1200 Wi-Fi Range Extender.

Centralize the extender's location

For best performance, make sure you place the extender in a centralized location within your desired usage area. Try to place the extender so that there are minimal obstructions between it and the uplink router. If possible, use an elevated power outlet, so the signal can be dispersed more easily. If you have a large home or usage area, you may need several extenders in order to achieve optimal coverage.

Eliminate Interference

Place home appliances such as cordless telephones, microwaves, and televisions as far away as possible from the extender. This can significantly reduce any interference that the appliances might cause since they operate on same frequency.

Security

Don't let your neighbors or intruders connect to your wireless network. Secure your wireless network by utilizing the WPA or WEP security feature on the extender and uplink router. Refer to the relevant sections of this manual for further details.

Technical Specifications

Standards

- IEEE 802.11ac
- IEEE 802.11a
- IEEE 802.11n
- IEEE 802.11g
- IEEE 802.11b

Wireless Frequency Range ¹

- 2.4 GHz to 2.4835 GHz
- 5.18 MHz to 5.85 MHz

Device Interfaces

- 802.11ac/n/g/b/a Wireless LAN
- 10/100/1000 Gigabit Ethernet Port
- Reset Button
- WPS Button

Antenna

- External Antenna

Security

- Wi-Fi Protected Access (WPA/WPA2)
- Wi-Fi Protected Setup (WPS)
- Wired Equivalent Privacy (WEP) 64/128-bit

Advanced Features

- QRS Mobile setup app for iOS and Android devices

Device Management

- Web UI

Diagnostic LEDs

- Status/WPS

- 3 Segment Wi-Fi Signal Strength Indicator

Operating Temperature

- 0 to 40 °C (32 to 104 °F)

Storage Temperature

- Storage: -20 to 65 °C (-4 to 149 °F)

Operating Humidity

- 0% to 90% non-condensing

Storage Humidity

- 5% to 95% non-condensing

Power Input

- AC 110-240 V

Maximum Power Consumption

- 4.3 W

Certifications

- FCC
- CE
- IC
- C-Tick
- UL
- Wi-Fi Certified

Dimensions

- 63 x 95 x 41 mm (2.48 x 3.74 x 1.65 inches)

Weight

- 139 grams (4.9 ounces)

¹ Frequency range varies depending on local regulations

GPL Code Statement

This D-Link product includes software code developed by third parties, including software code subject to the GNU General Public License ("GPL") or GNU Lesser General Public License ("LGPL"). As applicable, the terms of the GPL and LGPL, and information on obtaining access to the GPL code and LGPL code used in this product, are available to you at:

<http://tsd.dlink.com.tw/GPL.asp>

The GPL code and LGPL code used in this product is distributed WITHOUT ANY WARRANTY and is subject to the copyrights of one or more authors. For details, see the GPL code and the LGPL code for this product and the terms of the GPL and LGPL.

WRITTEN OFFER FOR GPL AND LGPL SOURCE CODE

Where such specific license terms entitle you to the source code of such software, D-Link will provide upon written request via email and/or traditional paper mail the applicable GPL and LGPL source code files via CD-ROM for a nominal cost to cover shipping and media charges as allowed under the GPL and LGPL.

Please direct all inquiries to:
Email: GPLCODE@DLink.com
Snail Mail:
Attn: GPLSOURCE REQUEST
D-Link Systems, Inc.
17595 Mt. Herrmann Street
Fountain Valley, CA 92708

GNU GENERAL PUBLIC LICENSE Version 3, 29 June 2007

Copyright (C) 2007 Free Software Foundation, Inc. <http://fsf.org/> Everyone is permitted to copy and distribute verbatim copies of this license document, but changing it is not allowed.

Preamble

The GNU General Public License is a free, copyleft license for software and other kinds of works.

The licenses for most software and other practical works are designed to take away your freedom to share and change the works. By contrast, the GNU General Public License is intended to guarantee your freedom to share and change all versions of a program--to make sure it remains free software for all its users. We, the Free Software Foundation, use the GNU General Public License for most of our software; it applies also to any other work released this way by its authors. You can apply it to your programs, too.

When we speak of free software, we are referring to freedom, not price. Our General Public Licenses are designed to make sure that you have the freedom to distribute copies of free software (and charge for them if you wish), that you receive source code or can get it if you want it, that you can change the software or use pieces of it in new free programs, and that you know you can do these things.

To protect your rights, we need to prevent others from denying you these rights or asking you to surrender the rights. Therefore, you have certain responsibilities if you distribute copies of the software, or if you modify it: responsibilities to respect the freedom of others.

For example, if you distribute copies of such a program, whether gratis or for a fee, you must pass on to the recipients the same freedoms that you received. You must make sure that they, too, receive or can get the source code. And you must show them these terms so they know their rights.

Developers that use the GNU GPL protect your rights with two steps:

(1) assert copyright on the software, and (2) offer you this License giving you legal permission to copy, distribute and/or modify it.

For the developers' and authors' protection, the GPL clearly explains that there is no warranty for this free software. For both users' and authors' sake, the GPL requires that modified versions be marked as changed, so that their problems will not be attributed erroneously to authors of previous versions.

Some devices are designed to deny users access to install or run modified versions of the software inside them, although the manufacturer can do so. This is fundamentally incompatible with the aim of protecting users' freedom to change the software. The systematic pattern of such abuse occurs in the area of products for individuals to use, which is precisely where it is most unacceptable. Therefore, we have designed this version of the GPL to prohibit the practice for those products. If such problems arise substantially in other domains, we stand ready to extend this provision to those domains in future versions of the GPL, as needed to protect the freedom of users.

Finally, every program is threatened constantly by software patents. States should not allow patents to restrict development and use of software on general-purpose computers, but in those that do, we wish to avoid the special danger that patents applied to a free program could make it effectively proprietary. To prevent this, the GPL assures that patents cannot be used to render the program non-free.

The precise terms and conditions for copying, distribution and modification follow.

TERMS AND CONDITIONS

0. Definitions.

“This License” refers to version 3 of the GNU General Public License.

“Copyright” also means copyright-like laws that apply to other kinds of works, such as semiconductor masks.

“The Program” refers to any copyrightable work licensed under this License. Each licensee is addressed as “you”. “Licensees” and “recipients” may be individuals or organizations.

To “modify” a work means to copy from or adapt all or part of the work in a fashion requiring copyright permission, other than the making of an exact copy. The resulting work is called a “modified version” of the earlier work or a work “based on” the earlier work.

A “covered work” means either the unmodified Program or a work based on the Program.

To “propagate” a work means to do anything with it that, without permission, would make you directly or secondarily liable for infringement under applicable copyright law, except executing it on a computer or modifying a private copy. Propagation includes copying, distribution (with or without modification), making available to the public, and in some countries other activities as well.

To “convey” a work means any kind of propagation that enables other parties to make or receive copies. Mere interaction with a user through a computer network, with no transfer of a copy, is not conveying.

An interactive user interface displays “Appropriate Legal Notices” to the extent that it includes a convenient and prominently visible feature that (1) displays an appropriate copyright notice, and (2) tells the user that there is no warranty for the work (except to the extent that warranties are provided), that licensees may convey the work under this License, and how to view a copy of this License. If the interface presents a list of user commands or options, such as a menu, a prominent item in the list meets this criterion.

1. Source Code.

The “source code” for a work means the preferred form of the work for making modifications to it. “Object code” means any non-source form of a work.

A “Standard Interface” means an interface that either is an official standard defined by a recognized standards body, or, in the case of interfaces specified for a particular programming language, one that is widely used among developers working in that language.

The “System Libraries” of an executable work include anything, other than the work as a whole, that (a) is included in the normal form of packaging a Major Component, but which is not part of that Major Component, and (b) serves only to enable use of the work with that Major Component, or to implement a Standard Interface for which an implementation is available to the public in source code form. A “Major Component”, in this context, means a major essential component (kernel, window system, and so on) of the specific operating system (if any) on which the executable work runs, or a compiler used to produce the work, or an object code interpreter used to run it.

The “Corresponding Source” for a work in object code form means all the source code needed to generate, install, and (for an executable work) run the object code and to modify the work, including scripts to control those activities. However, it does not include the work’s System Libraries, or general-purpose tools or generally available free programs which are used unmodified in performing those activities but which are not part of the work. For example, Corresponding Source includes interface definition files associated with source files for the work, and the source code for shared libraries and dynamically linked subprograms that the work is specifically designed to require, such as by intimate data communication or control flow between those subprograms and other parts of the work.

The Corresponding Source need not include anything that users can regenerate automatically from other parts of the Corresponding Source.

The Corresponding Source for a work in source code form is that same work.

2. Basic Permissions.

All rights granted under this License are granted for the term of copyright on the Program, and are irrevocable provided the stated conditions are met. This License explicitly affirms your unlimited permission to run the unmodified Program. The output from running a covered work is covered by this License only if the output, given its content, constitutes a covered work. This License acknowledges your rights of fair use or other equivalent, as provided by copyright law.

You may make, run and propagate covered works that you do not convey, without conditions so long as your license otherwise remains in force. You may convey covered works to others for the sole purpose of having them make modifications exclusively for you, or provide you with facilities for running those works, provided that you comply with the terms of this License in conveying all material for which you do not control copyright. Those thus making or running the covered works for you must do so exclusively on your behalf, under your direction and control, on terms that prohibit them from making any copies of your copyrighted material outside their relationship with you.

Conveying under any other circumstances is permitted solely under the conditions stated below. Sublicensing is not allowed; section 10 makes it unnecessary.

3. Protecting Users' Legal Rights From Anti-Circumvention Law.

No covered work shall be deemed part of an effective technological measure under any applicable law fulfilling obligations under article 11 of the WIPO copyright treaty adopted on 20 December 1996, or similar laws prohibiting or restricting circumvention of such measures.

When you convey a covered work, you waive any legal power to forbid circumvention of technological measures to the extent such circumvention is effected by exercising rights under this License with respect to the covered work, and you disclaim any intention to limit operation or modification of the work as a means of enforcing, against the work's users, your or third parties' legal rights to forbid circumvention of technological measures.

4. Conveying Verbatim Copies.

You may convey verbatim copies of the Program's source code as you receive it, in any medium, provided that you conspicuously and appropriately publish on each copy an appropriate copyright notice; keep intact all notices stating that this License and any non-permissive terms added in accord with section 7 apply to the code; keep intact all notices of the absence of any warranty; and give all recipients a copy of this License along with the Program.

You may charge any price or no price for each copy that you convey, and you may offer support or warranty protection for a fee.

5. Conveying Modified Source Versions.

You may convey a work based on the Program, or the modifications to produce it from the Program, in the form of source code under the terms of section 4, provided that you also meet all of these conditions:

- a) The work must carry prominent notices stating that you modified it, and giving a relevant date.
- b) The work must carry prominent notices stating that it is released under this License and any conditions added under section 7. This requirement modifies the requirement in section 4 to "keep intact all notices".
- c) You must license the entire work, as a whole, under this License to anyone who comes into possession of a copy. This License will therefore apply, along with any applicable section 7 additional terms, to the whole of the work, and all its parts, regardless of how they are packaged. This License gives no permission to license the work in any other way, but it does not invalidate such permission if you have separately received it.
- d) If the work has interactive user interfaces, each must display Appropriate Legal Notices; however, if the Program has interactive interfaces that do not display Appropriate Legal Notices, your work need not make them do so.

A compilation of a covered work with other separate and independent works, which are not by their nature extensions of the covered work, and which are not combined with it such as to form a larger program, in or on a volume of a storage or distribution medium, is called an "aggregate" if the compilation and its resulting copyright are not used to limit the access or legal rights of the compilation's users beyond what the individual works permit. Inclusion of a covered work in an aggregate does not cause this License to apply to the other parts of the aggregate.

6. Conveying Non-Source Forms.

You may convey a covered work in object code form under the terms of sections 4 and 5, provided that you also convey the machine-readable Corresponding Source under the terms of this License, in one of these ways:

- a) Convey the object code in, or embodied in, a physical product (including a physical distribution medium), accompanied by the Corresponding Source fixed on a durable physical medium customarily used for software interchange.
- b) Convey the object code in, or embodied in, a physical product (including a physical distribution medium), accompanied by a written offer, valid for at least three years and valid for as long as you offer spare parts or customer support for that product model, to give anyone who possesses the object code either (1) a copy of the Corresponding Source for all the software in the product that is covered by this License, on a durable physical medium customarily used for software interchange, for a price no more than your reasonable cost of physically performing this conveying of source, or (2) access to copy the Corresponding Source from a network server at no charge.
- c) Convey individual copies of the object code with a copy of the written offer to provide the Corresponding Source. This alternative is allowed only occasionally and noncommercially, and only if you received the object code with such an offer, in accord with subsection 6 b.
- d) Convey the object code by offering access from a designated place (gratis or for a charge), and offer equivalent access to the Corresponding Source in the same way through the same place at no further charge. You need not require recipients to copy the Corresponding Source along with the object code. If the place to copy the object code is a network server, the Corresponding Source may be on a different server (operated by you or a third party) that supports equivalent copying facilities, provided you maintain clear directions next to the object code saying where to find the Corresponding Source. Regardless of what server hosts the Corresponding Source, you remain obligated to ensure that it is available for as long as needed to satisfy these requirements.
- e) Convey the object code using peer-to-peer transmission, provided you inform other peers where the object code and Corresponding Source of the work are being offered to the general public at no charge under subsection 6d.

A separable portion of the object code, whose source code is excluded from the Corresponding Source as a System Library, need not be included in conveying the object code work.

A “User Product” is either (1) a “consumer product”, which means any tangible personal property which is normally used for personal, family, or household purposes, or (2) anything designed or sold for incorporation into a dwelling. In determining whether a product is a consumer product, doubtful cases shall be resolved in favor of coverage. For a particular product received by a particular user, “normally used” refers to a typical or common use of that class of product, regardless of the status of the particular user or of the way in which the particular user actually uses, or expects or is expected to use, the product. A product is a consumer product regardless of whether the product has substantial commercial, industrial or non-consumer uses, unless such uses represent the only significant mode of use of the product.

“Installation Information” for a User Product means any methods, procedures, authorization keys, or other information required to install and execute modified versions of a covered work in that User Product from a modified version of its Corresponding Source. The information must suffice to ensure that the continued functioning of the modified object code is in no case prevented or interfered with solely because modification has been made.

If you convey an object code work under this section in, or with, or specifically for use in, a User Product, and the conveying occurs as part of a transaction in which the right of possession and use of the User Product is transferred to the recipient in perpetuity or for a fixed term (regardless of how the transaction is characterized), the Corresponding Source conveyed under this section must be accompanied by the Installation Information. But this requirement does not apply if neither you nor any third party retains the ability to install modified object code on the User Product (for example, the work has been installed in ROM).

The requirement to provide Installation Information does not include a requirement to continue to provide support service, warranty, or updates for a work that has been modified or installed by the recipient, or for the User Product in which it has been modified or installed. Access to a network may be denied when the modification itself materially and adversely affects the operation of the network or violates the rules and protocols for communication across the network.

Corresponding Source conveyed, and Installation Information provided, in accord with this section must be in a format that is publicly documented (and with an implementation available to the public in source code form), and must require no special password or key for unpacking, reading or copying.

7. Additional Terms.

“Additional permissions” are terms that supplement the terms of this License by making exceptions from one or more of its conditions. Additional permissions that are applicable to the entire Program shall be treated as though they were included in this License, to the extent that they are valid under applicable law. If additional permissions apply only to part of the Program, that part may be used separately under those permissions, but the entire Program remains governed by this License without regard to the additional permissions.

When you convey a copy of a covered work, you may at your option remove any additional permissions from that copy, or from any part of it. (Additional permissions may be written to require their own removal in certain cases when you modify the work). You may place additional permissions on material, added by you to a covered work, for which you have or can give appropriate copyright permission.

Notwithstanding any other provision of this License, for material you add to a covered work, you may (if authorized by the copyright holders of that material) supplement the terms of this License with terms:

- a) Disclaiming warranty or limiting liability differently from the terms of sections 15 and 16 of this License; or
- b) Requiring preservation of specified reasonable legal notices or author attributions in that material or in the Appropriate Legal Notices displayed by works containing it; or
- c) Prohibiting misrepresentation of the origin of that material, or requiring that modified versions of such material be marked in reasonable ways as different from the original version; or
- d) Limiting the use for publicity purposes of names of licensors or authors of the material; or
- e) Declining to grant rights under trademark law for use of some trade names, trademarks, or service marks; or
- f) Requiring indemnification of licensors and authors of that material by anyone who conveys the material (or modified versions of it) with contractual assumptions of liability to the recipient, for any liability that these contractual assumptions directly impose on those licensors and authors.

All other non-permissive additional terms are considered “further restrictions” within the meaning of section 10. If the Program as you received it, or any part of it, contains a notice stating that it is governed by this License along with a term that is a further restriction, you may remove that term. If a license document contains a further restriction but permits relicensing or conveying under this License, you may add to a covered work material governed by the terms of that license document, provided that the further restriction does not survive such relicensing or conveying.

If you add terms to a covered work in accord with this section, you must place, in the relevant source files, a statement of the additional terms that apply to those files, or a notice indicating where to find the applicable terms.

Additional terms, permissive or non-permissive, may be stated in the form of a separately written license, or stated as exceptions; the above requirements apply either way.

8. Termination.

You may not propagate or modify a covered work except as expressly provided under this License. Any attempt otherwise to propagate or modify it is void, and will automatically terminate your rights under this License (including any patent licenses granted under the third paragraph of section 11).

However, if you cease all violation of this License, then your license from a particular copyright holder is reinstated (a) provisionally, unless and until the copyright holder explicitly and finally terminates your license, and (b) permanently, if the copyright holder fails to notify you of the violation by some reasonable means prior to 60 days after the cessation.

Moreover, your license from a particular copyright holder is reinstated permanently if the copyright holder notifies you of the violation by some reasonable means, this is the first time you have received notice of violation of this License (for any work) from that copyright holder, and you cure the violation prior to 30 days after your receipt of the notice.

Termination of your rights under this section does not terminate the licenses of parties who have received copies or rights

from you under this License. If your rights have been terminated and not permanently reinstated, you do not qualify to receive new licenses for the same material under section 10.

9. Acceptance Not Required for Having Copies.

You are not required to accept this License in order to receive or run a copy of the Program. Ancillary propagation of a covered work occurring solely as a consequence of using peer-to-peer transmission to receive a copy likewise does not require acceptance. However, nothing other than this License grants you permission to propagate or modify any covered work. These actions infringe copyright if you do not accept this License. Therefore, by modifying or propagating a covered work, you indicate your acceptance of this License to do so.

10. Automatic Licensing of Downstream Recipients.

Each time you convey a covered work, the recipient automatically receives a license from the original licensors, to run, modify and propagate that work, subject to this License. You are not responsible for enforcing compliance by third parties with this License.

An “entity transaction” is a transaction transferring control of an organization, or substantially all assets of one, or subdividing an organization, or merging organizations. If propagation of a covered work results from an entity transaction, each party to that transaction who receives a copy of the work also receives whatever licenses to the work the party’s predecessor in interest had or could give under the previous paragraph, plus a right to possession of the Corresponding Source of the work from the predecessor in interest, if the predecessor has it or can get it with reasonable efforts.

You may not impose any further restrictions on the exercise of the rights granted or affirmed under this License. For example, you may not impose a license fee, royalty, or other charge for exercise of rights granted under this License, and you may not initiate litigation (including a cross-claim or counterclaim in a lawsuit) alleging that any patent claim is infringed by making, using, selling, offering for sale, or importing the Program or any portion of it.

11. Patents.

A “contributor” is a copyright holder who authorizes use under this License of the Program or a work on which the Program is based. The work thus licensed is called the contributor’s “contributor version”.

A contributor’s “essential patent claims” are all patent claims owned or controlled by the contributor, whether already acquired or hereafter acquired, that would be infringed by some manner, permitted by this License, of making, using, or selling its contributor version, but do not include claims that would be infringed only as a consequence of further modification of the contributor version. For purposes of this definition, “control” includes the right to grant patent sublicenses in a manner consistent with the requirements of this License.

Each contributor grants you a non-exclusive, worldwide, royalty-free patent license under the contributor’s essential patent claims, to make, use, sell, offer for sale, import and otherwise run, modify and propagate the contents of its contributor version.

In the following three paragraphs, a “patent license” is any express agreement or commitment, however denominated, not to enforce a patent (such as an express permission to practice a patent or covenant not to sue for patent infringement). To “grant” such a patent license to a party means to make such an agreement or commitment not to enforce a patent against the party.

If you convey a covered work, knowingly relying on a patent license, and the Corresponding Source of the work is not available for anyone to copy, free of charge and under the terms of this License, through a publicly available network server or other readily accessible means, then you must either (1) cause the Corresponding Source to be so available, or (2) arrange to deprive yourself of the benefit of the patent license for this particular work, or (3) arrange, in a manner consistent with the requirements of this License, to extend the patent license to downstream recipients. “Knowingly relying” means you have actual knowledge that, but for the patent license, your conveying the covered work in a country, or your recipient’s use of the covered work in a country, would infringe one or more identifiable patents in that country that you have reason to believe are valid.

If, pursuant to or in connection with a single transaction or arrangement, you convey, or propagate by procuring conveyance of, a covered work, and grant a patent license to some of the parties receiving the covered work authorizing them to use, propagate, modify or convey a specific copy of the covered work, then the patent license you grant is automatically extended to all recipients of the covered work and works based on it.

A patent license is “discriminatory” if it does not include within the scope of its coverage, prohibits the exercise of, or is conditioned on the non-exercise of one or more of the rights that are specifically granted under this License. You may not convey a covered work if you are a party to an arrangement with a third party that is in the business of distributing software, under which you make payment to the third party based on the extent of your activity of conveying the work, and under which the third party grants, to any of the parties who would receive the covered work from you, a discriminatory patent license (a) in connection with copies of the covered work conveyed by you (or copies made from those copies), or (b) primarily for and in connection with specific products or compilations that contain the covered work, unless you entered into that arrangement, or that patent license was granted, prior to 28 March 2007.

Nothing in this License shall be construed as excluding or limiting any implied license or other defenses to infringement that may otherwise be available to you under applicable patent law.

12. No Surrender of Others’ Freedom.

If conditions are imposed on you (whether by court order, agreement or otherwise) that contradict the conditions of this License, they do not excuse you from the conditions of this License. If you cannot convey a covered work so as to satisfy simultaneously your obligations under this License and any other pertinent obligations, then as a consequence you may not convey it at all. For example, if you agree to terms that obligate you to collect a royalty for further conveying from those to whom you convey the Program, the only way you could satisfy both those terms and this License would be to refrain entirely from conveying the Program.

13. Use with the GNU Affero General Public License.

Notwithstanding any other provision of this License, you have permission to link or combine any covered work with a work licensed under version 3 of the GNU Affero General Public License into a single combined work, and to convey the resulting work. The terms of this License will continue to apply to the part which is the covered work, but the special requirements of the GNU Affero General Public License, section 13, concerning interaction through a network will apply to the combination as such.

14. Revised Versions of this License.

The Free Software Foundation may publish revised and/or new versions of the GNU General Public License from time to time. Such new versions will be similar in spirit to the present version, but may differ in detail to address new problems or concerns.

Each version is given a distinguishing version number. If the Program specifies that a certain numbered version of the GNU General Public License “or any later version” applies to it, you have the option of following the terms and conditions either of that numbered version or of any later version published by the Free Software Foundation. If the Program does not specify a version number of the GNU General Public License, you may choose any version ever published by the Free Software Foundation. If the Program specifies that a proxy can decide which future versions of the GNU General Public License can be used, that proxy’s public statement of acceptance of a version permanently authorizes you to choose that version for the Program.

Later license versions may give you additional or different permissions. However, no additional obligations are imposed on any author or copyright holder as a result of your choosing to follow a later version.

15. Disclaimer of Warranty.

THERE IS NO WARRANTY FOR THE PROGRAM, TO THE EXTENT PERMITTED BY APPLICABLE LAW. EXCEPT WHEN OTHERWISE STATED IN WRITING THE COPYRIGHT HOLDERS AND/OR OTHER PARTIES PROVIDE THE PROGRAM “AS IS” WITHOUT WARRANTY OF ANY KIND, EITHER EXPRESSED OR IMPLIED, INCLUDING, BUT NOT LIMITED TO, THE IMPLIED WARRANTIES OF MERCHANTABILITY AND FITNESS FOR A PARTICULAR PURPOSE. THE ENTIRE RISK AS TO THE QUALITY AND PERFORMANCE OF THE PROGRAM IS WITH YOU. SHOULD THE PROGRAM PROVE DEFECTIVE, YOU ASSUME THE COST OF ALL NECESSARY SERVICING, REPAIR OR CORRECTION.

16. Limitation of Liability.

IN NO EVENT UNLESS REQUIRED BY APPLICABLE LAW OR AGREED TO IN WRITING WILL ANY COPYRIGHT HOLDER, OR ANY OTHER PARTY WHO MODIFIES AND/OR CONVEYS THE PROGRAM AS PERMITTED ABOVE, BE LIABLE TO YOU FOR DAMAGES, INCLUDING ANY GENERAL, SPECIAL, INCIDENTAL OR CONSEQUENTIAL DAMAGES ARISING OUT OF THE USE OR INABILITY TO USE THE PROGRAM (INCLUDING BUT NOT LIMITED TO LOSS OF DATA OR DATA BEING RENDERED INACCURATE OR LOSSES SUSTAINED BY YOU OR THIRD PARTIES OR A FAILURE OF THE PROGRAM TO OPERATE WITH ANY OTHER PROGRAMS), EVEN IF SUCH HOLDER OR OTHER PARTY HAS BEEN ADVISED OF THE POSSIBILITY OF SUCH DAMAGES.

17. Interpretation of Sections 15 and 16.

If the disclaimer of warranty and limitation of liability provided above cannot be given local legal effect according to their terms, reviewing courts shall apply local law that most closely approximates an absolute waiver of all civil liability in connection with the Program, unless a warranty or assumption of liability accompanies a copy of the Program in return for a fee.

Safety Statements

Federal Communication Commission Interference Statement

This equipment has been tested and found to comply with the limits for a Class B digital device, pursuant to Part 15 of the FCC Rules. These limits are designed to provide reasonable protection against harmful interference in a residential installation. This equipment generates, uses and can radiate radio frequency energy and, if not installed and used in accordance with the instructions, may cause harmful interference to radio communications. However, there is no guarantee that interference will not occur in a particular installation. If this equipment does cause harmful interference to radio or television reception, which can be determined by turning the equipment off and on, the user is encouraged to try to correct the interference by one of the following measures:

- Reorient or relocate the receiving antenna.
- Increase the separation between the equipment and receiver.
- Connect the equipment into an outlet on a circuit different from that to which the receiver is connected.
- Consult the dealer or an experienced radio/TV technician for help.

FCC Caution: Any changes or modifications not expressly approved by the party responsible for compliance could void the user's authority to operate this equipment.

This device complies with Part 15 of the FCC Rules. Operation is subject to the following two conditions: (1) This device may not cause harmful interference, and (2) this device must accept any interference received, including interference that may cause undesired operation.

Operation of this device is restricted to indoor use only.

IMPORTANT NOTICE:

Radiation Exposure Statement:

This equipment complies with FCC radiation exposure limits set forth for an uncontrolled environment. This equipment should be installed and operated with minimum distance 20cm between the radiator & your body.

This transmitter must not be co-located or operating in conjunction with any other antenna or transmitter.

Country Code selection feature to be disabled for products marketed to the US/CANADA Industry Canada statement:

Industry Canada statement:

This device complies with Industry Canada's licence-exempt RSSs. Operation is subject to the following two conditions:

(1) This device may not cause interference; and (2) This device must accept any interference, including interference that may cause undesired operation of the device.

Cet appareil est conforme aux CNR exemptes de licence d'Industrie Canada. Son fonctionnement est soumis aux deux conditions suivantes:

(1) Ce dispositif ne peut causer d'interférences; et(2) Ce dispositif doit accepter toute interférence, y compris les interférences qui peuvent causer un mauvais fonctionnement de l'appareil.

Caution:

(i) the device for operation in the band 5150-5250 MHz is only for indoor use to reduce the potential for harmful interference to co-channel mobile satellite systems;

Avertissement:

(i) les dispositifs fonctionnant dans la bande 5150-5250 MHz sont réservés uniquement pour une utilisation à l'intérieur afin de réduire les risques de brouillage préjudiciable aux systèmes de satellites mobiles utilisant les mêmes canaux;

Radiation Exposure Statement:

This equipment complies with IC radiation exposure limits set forth for an uncontrolled environment. This equipment should be installed and operated with minimum distance 20cm between the radiator & your body.

Déclaration d'exposition aux radiations:

Cet équipement est conforme aux limites d'exposition aux rayonnements IC établies pour un environnement non contrôlé. Cet équipement doit être installé et utilisé avec un minimum de 20 cm de distance entre la source de rayonnement et votre corps.

NCC 警語：

電磁波曝露量 MPE 標準值 (MPE) $1\text{mW}/\text{cm}^2$ ，送測產品實值為 $0.085\text{mW}/\text{cm}^2$

經型式認證合格之低功率射頻電機，非經許可，公司，商號或使用者均不得擅自變更頻率、加大功率或變更原設計之特性及功能。
低功率射頻電機之使用不得影響飛航安全及干擾合法通信；經發現有干擾現象時，應立即停用，並改善至無干擾時方得繼續使用。
前項合法通信，指依電信法規定作業之無線電通信。低功率射頻電機須忍受合法通信或工業、科學及醫療用電波輻射性電機設備之干擾。

在 5.25-5.35 兆赫頻帶內操作之無線資訊傳輸設備，限於室內使用。