

D-Link[®]
Building Networks for People

DAP-2610

Version 1.00

**Wireless AC1300 Wave 2
Dual-Band PoE Access Point**

User Manual

Business Class Networking

Table of Contents

Product Overview	4	Performance	24
Introduction	4	Wireless Resource Control.....	26
Features.....	5	Multi-SSID.....	28
Package Contents.....	6	VLAN.....	30
System Requirements	6	VLAN List.....	30
Hardware Overview	7	Port List.....	31
LEDs.....	7	Add/Edit VLAN	32
Connections	7	PVID Settings.....	33
Basic Installation	8	Intrusion.....	34
Hardware Setup	8	Schedule	35
Method 1 - PoE with PoE Switch or Router.....	8	Internal RADIUS Server.....	36
Method 2 - PoE without PoE Switch or Router.....	9	ARP Spoofing Prevention	37
Web User Interface	10	Bandwidth Optimization	38
Wireless	11	AP Array.....	40
Access Point Mode	11	AP Array Scan	40
WDS with AP Mode.....	13	Configuration Settings.....	41
WDS Mode	15	Auto-RF.....	45
Wireless Client Mode.....	17	Load Balance	46
Wireless Security	18	Captive Portal.....	47
Wired Equivalent Privacy (WEP)	18	Authentication Settings-Web Redirection Only	47
Wi-Fi Protected Access (WPA / WPA2).....	19	Authentication Settings- Username/Password..	49
LAN	21	Authentication Settings- Passcode	51
IPv6	22	Authentication Settings- Remote RADIUS.....	53
Advanced Settings	23	Authentication Settings- LDAP.....	55
		Authentication Settings- POP3.....	57
		Login Page Upload.....	59

IP Filter Settings.....	60	System Name Settings.....	81
MAC Bypass.....	61	Login Settings	81
DHCP Server	62	Console Settings	81
Dynamic Pool Settings.....	62	SNMP Settings	82
Static Pool Setting	63	Administration.....	83
Current IP Mapping List.....	64	Central WiFiManager Settings.....	83
Filters.....	65	Firmware and SSL Upload.....	84
Wireless MAC ACL.....	65	Configuration File Upload	85
WLAN Partition	66	Time and Date Settings	86
Traffic Control.....	67	Configuration and System.....	87
Uplink/Downlink Setting	67	System Settings.....	88
QoS.....	68	Help	89
Traffic Manager.....	69	Knowledge Base	90
Status	70	Wireless Basics	90
Device Information	71	Wireless Installation Considerations.....	91
Client Information	72	Troubleshooting	92
WDS Information Page	73	Why can't I access the web-based configuration utility?	92
Channel Analyze	74	What can I do if I forgot my password?.....	92
Stats Page.....	75	How to check your IP address?	93
Ethernet Traffic Statistics.....	75	How to statically assign an IP address?.....	94
WLAN Traffic Statistics.....	76	Technical Specifications	95
Log	77	Antenna Pattern	96
View Log.....	77	Central WiFiManager.....	97
Log Settings.....	78		
Maintenance Section	79		
Administration.....	80		
Limit Administrator	80		

Product Overview

Introduction

D-Link, an industry pioneer in wireless networking, introduces a solution for businesses seeking to deploy next generation 802.11ac LANs. D-Link unveils its new DAP-2610, designed specifically for environments with high traffic areas such as airports, coffee shops, shopping centers, sporting venues, and school campuses to provide secure and manageable dual band wireless network options for network administrators.

Versatile Access Point

The DAP-2610 Access Point allows network administrators to deploy a highly manageable and extremely robust dual band wireless network. For advanced installations, this new high-speed Access Point has integrated 802.3af Power over Ethernet (PoE) support, allowing installation of this device in areas where power outlets are not readily available. In addition to bridging 802.11ac and 802.11b/g/n wireless networks, the DAP-2610 can bridge to wired networks with its integrated Gigabit (10/100/1000Mbps) Ethernet port.

Enhanced Performance

The DAP-2610 delivers reliable wireless performance with maximum wireless signal rates of up to 1200Mbps. This, coupled with support for Wi-Fi Multimedia™ (WMM) Quality of Service features, makes it an ideal access point for audio, video, and voice applications.

Security

To help maintain a secure wireless network, the DAP-2610 provides the latest in wireless security technologies by supporting both Personal and Enterprise versions of WPA and WPA2 (802.11i) with support for RADIUS server back end. To further protect your wireless network, MAC Address Filtering, Wireless LAN segmentation, Disable SSID Broadcast, Rogue AP Detection, and Wireless Broadcast Scheduling are also included.

Power Usage

This device is an Energy Related Product (ErP) with High Network Availability (HiNA), and automatically switches to a power-saving Network Standby mode within 1 minute of no packets being transmitted. It can also be turned off through a power switch to save energy when it is not needed.

Network Standby: 2.62 watts

Switched Off: 0.19 watts

* In Hong Kong, for operation within 5.15 ~ 5.35GHz frequency range, it is restricted to indoor environment.

* Maximum wireless signal rate derived from IEEE Standard 802.11ac, 802.11g, 802.11a, and 802.11n specifications. Actual data throughput will vary. Network conditions and environmental factors, including volume of network traffic, building materials and construction, and network overhead, lower actual data throughput rate. Environmental conditions will adversely affect wireless signal range.

Features

- Provide Ethernet to Wireless LAN bridge fully IEEE 802.3/u/ab compatible on the Ethernet side and fully interoperable with IEEE 802.11ac and b/g/n compliant equipment
- Compatible with IEEE 802.11b high rate standard to provide wireless 11Mbps data rate*
- Compatible with IEEE 802.11g higher speed standard to provide wireless 54Mbps data rate*
- Compatible with IEEE 802.11a higher speed standard to provide wireless 54Mbps data rate*
- Compatible with IEEE 802.11n higher speed standard to provide wireless 300Mbps data rate*
- Compatible with IEEE 802.11ac higher speed standard to provide wireless 900Mbps data rate*
- Operation at 2.4~2.5GHz and 5.15~5.85GHz** frequency band to meet worldwide regulations
- Supports IEEE 802.11ac and b/g/n wireless data encryption with 64/128-bit WEP for security
- Supports enhanced security – WPA-PSK and WPA2-PSK, RADIUS client, and Cipher negotiation
- Allows auto fallback data rate for reliability, optimized throughput and transmission range
- Web-based configuration and management
- Supports 802.3af PoE
- Supports 802.3az
- Supports one Gigabit Ethernet port
- AP Mode, WDS Mode, WDS with AP, and Wireless Client Mode
- Supports SNMP v1,v2,v3
- Support Trap server (SNMP v1, v2c)
- Support Central WiFiManager
- Support AP Array and AP Array Setup Tool

* Maximum wireless signal rate derived from IEEE Standard 802.11ac, 802.11g, 802.11a, and 802.11n specifications. Actual data throughput will vary. Network conditions and environmental factors, including volume of network traffic, building materials and construction, and network overhead, lower actual data throughput rate. Environmental conditions will adversely affect wireless signal range.

**Please note that operating frequency ranges vary depending on the regulations of individual countries and jurisdictions. The DAP-2610 isn't supported in the 5.25~5.35GHz and 5.47 ~ 5.725GHz frequency ranges in some regions.

Package Contents

- DAP-2610 802.11ac Power over Ethernet (PoE) Access Point
- Mounting Plate and Hardware
- Ethernet Cable
- CD (with software and user manual)

NOTE no PSU supplied. To power the units use an D-Link PoE switch or the D-Link DPE-101GI PoE injector.

Note: *Using a power supply with a different voltage rating than the one included with the DAP-2610 will cause damage and void the warranty for this product.*

System Requirements

- Computers with Windows®, Macintosh®, or Linux-based operating systems with an installed Ethernet Adapter
- Internet Explorer 11, Safari 7, Firefox 28, or Google Chrome 33 and above (for web-based configuration)

Hardware Overview

LEDs



1	Power/Status	Solid Red	Indicates the access point has malfunctioned.
		Blinking Red	This LED will blink during boot-up.
		Solid Green	Indicates that the DAP-2610 is working properly.

Connections



2	Power Receptor	Connect the supplied power adapter. Power Receptor (*Note no longer used, replaced by PoE)
3	LAN (PoE) Port	Connect to a Power over Ethernet (PoE) switch or router via an Ethernet cable.
4	Reset Button	Press and hold for five seconds to reset the access point to the factory default settings. Press and hold for one second to reboot the access point.

Basic Installation

Hardware Setup

To power the access point, you can use one of the following 2 methods:

Method 1 - Use if you have a PoE switch or router.

Method 2 - Use if you do not have a PoE switch or router and do not have a power outlet near the location of the access point.

Method 1 - PoE with PoE Switch or Router

1. Connect one end of your Ethernet cable to the LAN (PoE) port on the access point.
2. Connect the other end into one port on a PoE switch or router.



Method 2 - PoE without PoE Switch or Router

1. Connect one end of an Ethernet cable into the **Data In** port on the PoE base unit and the other end into one port on your switch, router, or computer.
2. Connect one end of an Ethernet cable into the **P+Data Out** port on the PoE base unit and the other end into the LAN (PoE) port on the Access Point.
3. Use the supplied power adapter. Connect the power adapter to the **Power In** receptor on the PoE adapter.
4. Connect the power cable to the power adapter and then connect the other end into a power outlet.
5. Purchase separately a DPE-101GI PoE injector if you need to connect the Access Point without a PoE Switch.

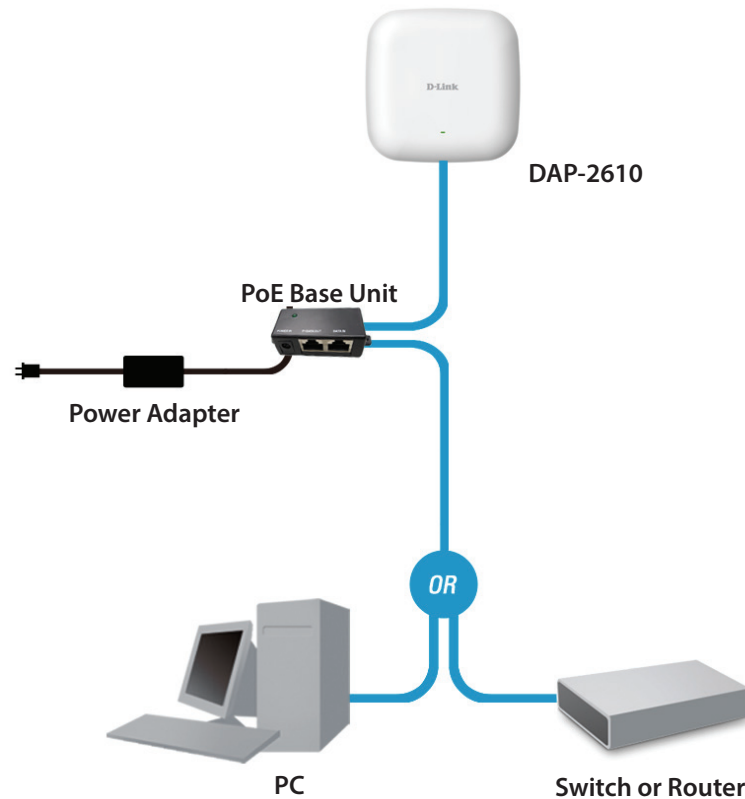

Web User Interface

The DAP-2610 supports an elaborate web user interface where the user can configure and monitor the device. Launch a web browser, type the IP address of the access point (Default setting is <http://192.168.0.50> or <https://192.168.0.50>) and then press Enter to login. Most of the configurable settings are located in the left menu of the web GUI which contains section called **Basic Settings**, **Advanced Settings** and **Status**.

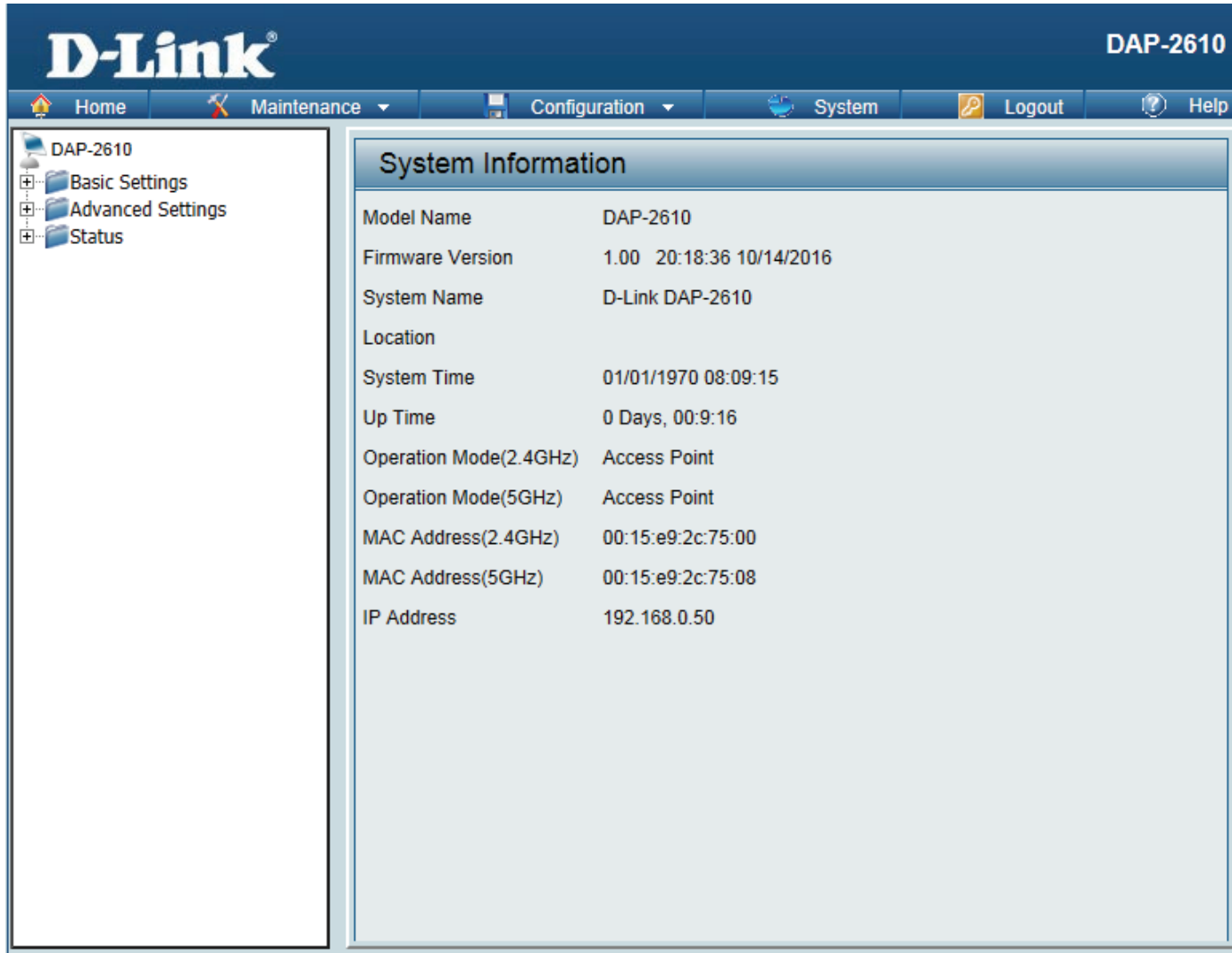

The screenshot displays the D-Link DAP-2610 web user interface. The top navigation bar includes the D-Link logo, the device model name "DAP-2610", and a menu with options: Home, Maintenance, Configuration, System, Logout, and Help. A left sidebar menu shows "DAP-2610" with sub-items: Basic Settings, Advanced Settings, and Status. The main content area is titled "System Information" and contains the following data:

Model Name	DAP-2610
Firmware Version	1.00 20:18:36 10/14/2016
System Name	D-Link DAP-2610
Location	
System Time	01/01/1970 08:09:15
Up Time	0 Days, 00:9:16
Operation Mode(2.4GHz)	Access Point
Operation Mode(5GHz)	Access Point
MAC Address(2.4GHz)	00:15:e9:2c:75:00
MAC Address(5GHz)	00:15:e9:2c:75:08
IP Address	192.168.0.50

Wireless

On the wireless settings page, you can setup the basic wireless configuration for the access point. The user can choose from 4 different wireless modes:

Access Point - Used to create a wireless LAN

WDS with AP - Used to connect multiple wireless networks while still functioning as a wireless access point

WDS - Used to connect multiple wireless networks

Wireless Client - Used when the access point needs to act as a wireless network adapter for an Ethernet enabled device

Access Point Mode

Wireless Band: Select either **2.4 GHz** or **5 GHz** from the drop-down menu.

Mode: Select **Access Point** from the drop-down menu.

Network Name (SSID): Service Set Identifier (SSID) is the name designated for a specific wireless local area network (WLAN). The SSID's factory default setting is **dlink**. The SSID can be easily changed to connect to an existing wireless network or to establish a new wireless network. The SSID can be up to 32 characters and is case-sensitive.

SSID Visibility: Select **Enable** to broadcast the SSID across the network, thus making it visible to all network users. Select **Disable** to hide the SSID from the network.

Auto Channel Selection: This feature when enabled automatically selects the channel that provides the best wireless performance. The channel selection process only occurs when the AP is booting up. To manually select a channel, set this option to Disable and select a channel from the drop-down menu.

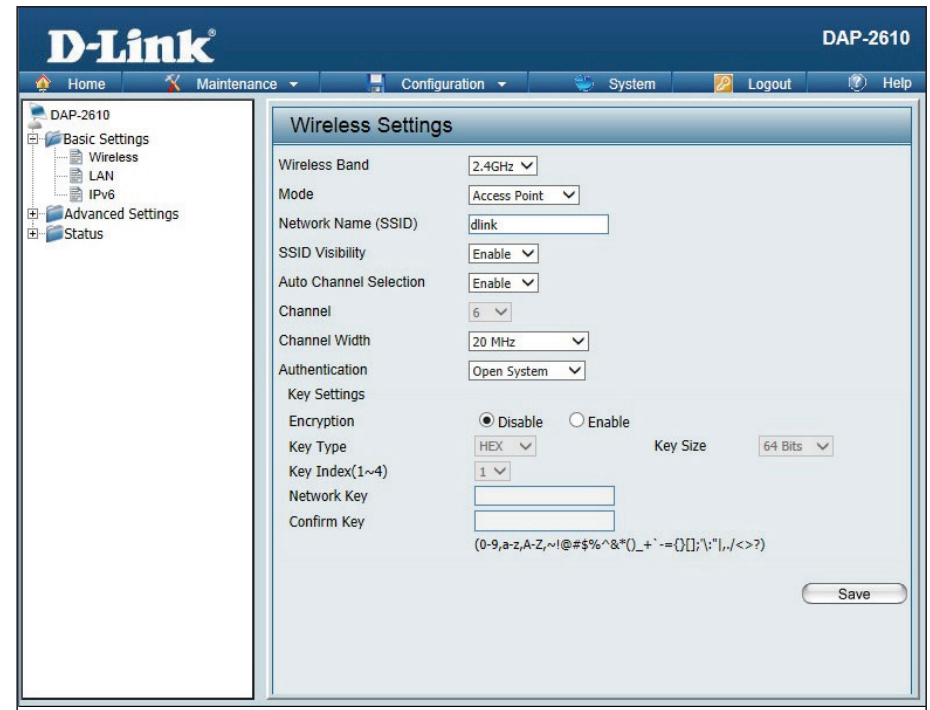

Channel: To change the channel, first toggle the *Auto Channel Selection* setting to **Disable**, and then use the drop-down menu to make the desired selection.

Note: *The wireless adapters will automatically scan and match the wireless settings.*

Channel Width: Allows you to select the channel width you would like to operate in. Select 20 MHz if you are not using any 802.11n wireless clients. Auto 20/40 MHz allows you to connect to both 802.11n and 802.11b/g or 802.11a wireless devices on your network.

Authentication: Use the drop-down menu to choose **Open System**, **Shared Key**, **WPA-Personal**, **WPA-Enterprise**, or **802.1x**.

- Select **Open System** to communicate the key across the network (WEP).
- Select **Shared Key** to limit communication to only those devices that share the same WEP settings. If multi-SSID is enabled, this option is not available.
- Select **WPA-Personal** to secure your network using a password and dynamic key changes. No RADIUS server is required.
- Select **WPA-Enterprise** to secure your network with the inclusion of a RADIUS server.
- Select **802.1X** if your network is using port-based Network Access Control.

WDS with AP Mode

Wireless Band: Select either 2.4GHz or 5GHz from the drop-down menu.

Mode: WDS with AP mode is selected from the drop-down menu.

Network Name (SSID): Service Set Identifier (SSID) is the name designated for a specific wireless local area network (WLAN). The SSID's factory default setting is dlink. The SSID can be easily changed to connect to an existing wireless network or to establish a new wireless network.

SSID Visibility: Enable or Disable SSID visibility. Enabling this feature broadcasts the SSID across the network, thus making it visible to all network users.

Auto Channel Selection: Enabling this feature automatically selects the channel that will provide the best wireless performance. This feature is not supported in WDS with AP mode. The channel selection process only occurs when the AP is booting up.

Channel: All devices on the network must share the same channel. To change the channel, use the drop-down menu to make the desired selection. (Note: The wireless adapters will automatically scan and match the wireless settings.)

Channel Width: Allows you to select the channel width you would like to operate in. Select 20 MHz if you are not using any 802.11n wireless clients. Auto 20/40 MHz allows you to connect to both 802.11n and 802.11b/g or 802.11a wireless devices on your network.

The screenshot shows the D-Link DAP-2610 configuration interface. The main content area is titled "Wireless Settings". The settings are as follows:

- Wireless Band: 2.4GHz
- Mode: WDS with AP
- Network Name (SSID): dlink
- SSID Visibility: Enable
- Auto Channel Selection: Disable
- Channel: 6
- Channel Width: 20 MHz
- WDS Remote AP MAC Address: 8 input fields (1-8)
- Site Survey: Scan button
- Table with columns: CH, RSSI, BSSID, Security, SSID
- Authentication: Open System
- Key Settings:
 - Encryption: Disable, Enable
 - Key Type: HEX
 - Key Index(1~4): 1
 - Network Key: [input field]
 - Confirm Key: [input field]
- Save button

Remote AP MAC Address: Enter the MAC addresses of the APs on your network that will serve as bridges to wirelessly connect multiple networks.

Site Survey: Click on the **Scan** button to search for available wireless networks, then click on the available network that you want to connect with.

Authentication: Use the drop-down menu to choose **Open System, Shared Key, or WPA-Personal.**

- Select Open System to communicate the key across the network.
- Select Shared Key to limit communication to only those devices that share the same WEP settings. If multi-SSID is enabled, this option is not available.
- Select WPA-Personal to secure your network using a password and dynamic key changes. No RADIUS server is required.

WDS Mode

Wireless Band: Select either 2.4GHz or 5GHz from the drop-down menu.

Mode: WDS is selected from the drop-down menu.

Network Name (SSID): Service Set Identifier (SSID) is the name designated for a specific wireless local area network (WLAN). The SSID's factory default setting is **dlink**. The SSID can be easily changed to connect to an existing wireless network or to establish a new wireless network.

SSID Visibility: Enable or Disable SSID visibility. Enabling this feature broadcasts the SSID across the network, thus making it visible to all network users.

Auto Channel Selection: Enabling this feature automatically selects the channel that will provide the best wireless performance. This feature is not supported in WDS mode.

Channel: All devices on the network must share the same channel. To change the channel, use the drop-down menu to make the desired selection.

Channel Width: Use the drop-down menu to choose 20 MHz or Auto 20/40 MHz.

Remote AP MAC Address: Enter the MAC addresses of the APs on your network that will serve as bridges to wirelessly connect multiple networks.

The screenshot shows the D-Link DAP-2610 configuration interface. The 'Wireless Settings' section is active, displaying the following configuration:

- Wireless Band: 2.4GHz
- Mode: WDS
- Network Name (SSID): dlink
- SSID Visibility: Enable
- Auto Channel Selection: Disable
- Channel: 6
- Channel Width: 20 MHz
- WDS Remote AP MAC Address: 1. [], 2. [], 3. [], 4. [], 5. [], 6. [], 7. [], 8. []
- Site Survey: [Scan]
- Authentication: Open System
- Key Settings:
 - Encryption: Disable, Enable
 - Key Type: HEX
 - Key Size: 64 Bits
 - Key Index(1~4): 1
 - Network Key: []
 - Confirm Key: []

Below the Site Survey button is a table with the following columns: CH, RSSI, BSSID, Security, and SSID. The table is currently empty.

At the bottom right of the configuration area is a 'Save' button.

Site Survey: Click on the **Scan** button to search for available wireless networks, then click on the available network that you want to connect with.

Authentication: Use the drop-down menu to choose **Open System, Shared Key, or WPA-Personal.**

- Select Open System to communicate the key across the network.
- Select Shared Key to limit communication to only those devices that share the same WEP settings.
- Select WPA-Personal to secure your network using a password and dynamic key changes. No RADIUS server is required.

Wireless Client Mode

Wireless Band: Select either 2.4 GHz or 5 GHz from the drop-down menu.

Mode: Wireless Client is selected from the drop-down menu.

Network Name (SSID): Service Set Identifier (SSID) is the name designated for a specific wireless local area network (WLAN). The SSID's factory default setting is dlink. The SSID can be easily changed to connect to an existing wireless network.

SSID Visibility: This option is unavailable in Wireless Client mode.

Auto Channel Selection: Enabling this feature automatically selects the channel that will provide the best wireless performance. This feature is not supported in Wireless Client mode.

Channel: The channel used will be displayed, and matches the AP that the DAP-2610 is connected to when set to Wireless Client mode.

Channel Width: Use the drop-down menu to choose 20 MHz or Auto 20/40 MHz.

Site Survey: Click on the **Scan** button to search for available wireless networks, then click on the available network that you want to connect with.

Authentication: Will be explained in the next topic.

The screenshot displays the D-Link DAP-2610 configuration interface. The top navigation bar includes Home, Maintenance, Configuration, System, Logout, and Help. The left sidebar shows a tree view with DAP-2610, Basic Settings (Wireless, LAN, IPv6), Advanced Settings, and Status. The main content area is titled "Wireless Settings" and contains the following configuration options:

- Wireless Band: 2.4GHz
- Mode: Wireless Client
- Network Name (SSID): dlink
- SSID Visibility: Enable
- Auto Channel Selection: Enable
- Channel: 6
- Channel Width: Auto 20/40 MHz
- Site Survey: Scan button

Below these settings is a table for scanning wireless networks:

CH	RSSI	BSSID	Security	SSID

Below the table are the following settings:

- Authentication: Open System
- Key Settings:
 - Encryption: Disable Enable
 - Key Type: HEX
 - Key Size: 64 Bits
 - Key Index(1~4): 1
 - Network Key: []
 - Confirm Key: []
- Wireless MAC Clone:
 - Enable:
 - MAC Source: Auto
 - MAC Address: [] : [] : [] : [] : [] : []
 - Scan button

At the bottom right, there is a "Save" button.

Wireless Security

Wireless security is a key concern for any wireless network installed. Unlike any other networking method wireless networks will broadcast its presence for anyone to connect to it. Today, wireless security has advanced to a level where it is virtually impenetrable.

There are mainly two forms of wireless encryption and they are called Wired Equivalent Privacy (WEP) and Wi-Fi Protected Access (WPA). WEP was the first security method developed. It is a low level encryption but better than now encryption. WPA is the newest encryption standard and with the advanced WPA2 standard wireless networks have finally reach a point where the security is strong enough to give users the peace of mind when installing wireless networks.

Wired Equivalent Privacy (WEP)

WEP provides two variations called **Open System** and **Shared Key**.

Open System will send a request to the access point and if the key used matches the one configured on the access point, the access point will return a success message back to the wireless client. If the key does not match the one configured on the access point, the access point will deny the connection request from the wireless client.

Shared Key will send a request to the access point and if the key used matches the one configured on the access point, the access point will send a challenge to the client. The client will then again send a confirmation of the same key back to the access point where the access point will either return a successful or a denial packet back to the wireless client.

Encryption: Use the radio button to disable or enable encryption.

Key Type*: Select HEX or ASCII.

Key Size: Select 64 Bits or 128 Bits.

Key Index (1-4): Select the 1st through the 4th key to be the active key.

Key: Input up to four keys for encryption. You will select one of these keys in the Key Index drop-down menu.

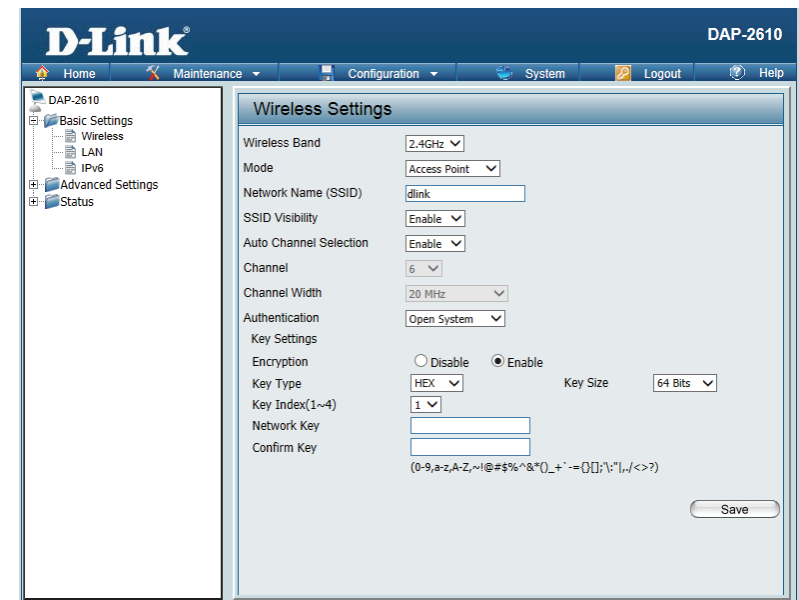

**Hexadecimal (HEX) digits consist of the numbers 0-9 and the letters A-F.

*ASCII (American Standard Code for Information Interchange) is a code that represents English letters using numbers ranging from 0-127.

Wi-Fi Protected Access (WPA / WPA2)

WPA was created by the Wi-Fi Alliance to address the limitations and weaknesses found in WEP. This protocol is mainly based on the 802.11i standard. There are also two variations found in WPA called WPA-Personal (PSK) and WPA-Enterprise (EAP).

WPA-EAP requires the user to install a Radius Server on the network for authentication.

WPA-Personal does not require the user to install a Radius Server on the network.

Comparing WPA-PSK with WPA-EAP, WPA-PSK is seen as a weaker authentication but comparing WPA-PSK to WEP, WPA-PSK is far more secure than WEP. WPA-EAP is the highest level of wireless security a user can use for wireless today.

WPA2 is an upgrade of WPA. WPA2 yet again solves some possible security issues found in WPA. WPA2 has two variations called WPA2-Personal (PSK) and WPA2-Enterprise (EAP) which is the same as found with WPA.

WPA Mode: When WPA-Personal is selected for Authentication type, you must also select a WPA mode from the drop-down menu: AUTO (WPA or WPA2), WPA2 Only, or WPA Only. WPA and WPA2 use different algorithms. AUTO (WPA or WPA2) allows you to use both WPA and WPA2.

Cipher Type: When you select WPA-Personal, you must also select AUTO, AES, or TKIP from the pull down menu.

Group Key Update: Select the interval during which the group key will be valid. The default value of 1800 is recommended.

Pass Phrase: When you select WPA-Personal, please enter a Pass Phrase in the corresponding field.

Wireless Settings

Wireless Band: 2.4GHz

Mode: Access Point

Network Name (SSID): dlink

SSID Visibility: Enable

Auto Channel Selection: Enable

Channel: 1

Channel Width: 20 MHz

Authentication: WPA-Personal

PassPhrase Settings

WPA Mode: AUTO (WPA or WPA2)

Cipher Type: Auto Group Key Update Interval: 3600 (Seconds)

Manual Periodical Key Change

Activated From: Sun : 00 : 00

Time Interval: 1 (1~168)hour(s)

PassPhrase:

Confirm PassPhrase:

notice: 8~63 in ASCII or 64 in Hex.
(0-9,a-z,A-Z,~!@#%&^&*()_+ '-= {} | \ ; * , . / < > ?)

Save

LAN

LAN is short for Local Area Network. This is considered your internal network. These are the IP settings of the LAN interface for the DAP-2610. These settings may be referred to as private settings. You may change the LAN IP address if needed. The LAN IP address is private to your internal network and cannot be seen on the Internet.

Get IP From: **Static IP (Manual)** is chosen here. Choose this option if you do not have a DHCP server in your network, or if you wish to assign a static IP address to the DAP-2610. When **Dynamic IP (DHCP)** is selected, the other fields here will be grayed out. Please allow about 2 minutes for the DHCP client to be functional once this selection is made.

IP Address: The default IP address is 192.168.0.50. Assign a static IP address that is within the IP address range of your network.

Subnet Mask: Enter the subnet mask. All devices in the network must share the same subnet mask.

Default Gateway: Enter the IP address of the gateway/router in your network.

DNS: Enter a DNS server IP address. This is usually the local IP address of your gateway/router.

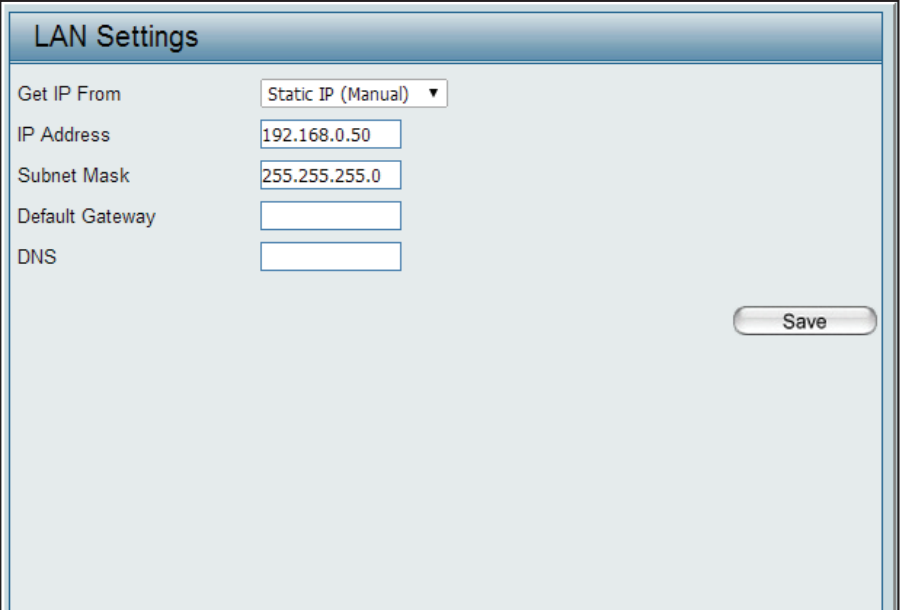

The screenshot displays the 'LAN Settings' configuration window. It features a title bar with the text 'LAN Settings'. Below the title bar, there are five rows of configuration options, each with a label on the left and a corresponding input field on the right. The 'Get IP From' field is a dropdown menu currently set to 'Static IP (Manual)'. The 'IP Address' field contains the text '192.168.0.50'. The 'Subnet Mask' field contains '255.255.255.0'. The 'Default Gateway' and 'DNS' fields are currently empty. A 'Save' button is located in the bottom right corner of the window.

Field	Value
Get IP From	Static IP (Manual)
IP Address	192.168.0.50
Subnet Mask	255.255.255.0
Default Gateway	
DNS	

IPv6

Enable IPv6: Check to enable the IPv6

Get IP From: Auto is chosen here. Choose this option the DAP-2610 can get IPv6 address automatically or use Static to set IPv6 address manually. When Auto is selected, the other fields here will be grayed out.

IP Address: Enter the LAN IPv6 address used here.

Prefix: Enter the LAN subnet prefix length value used here.

Default Gateway: Enter the LAN default gateway IPv6 address used here.

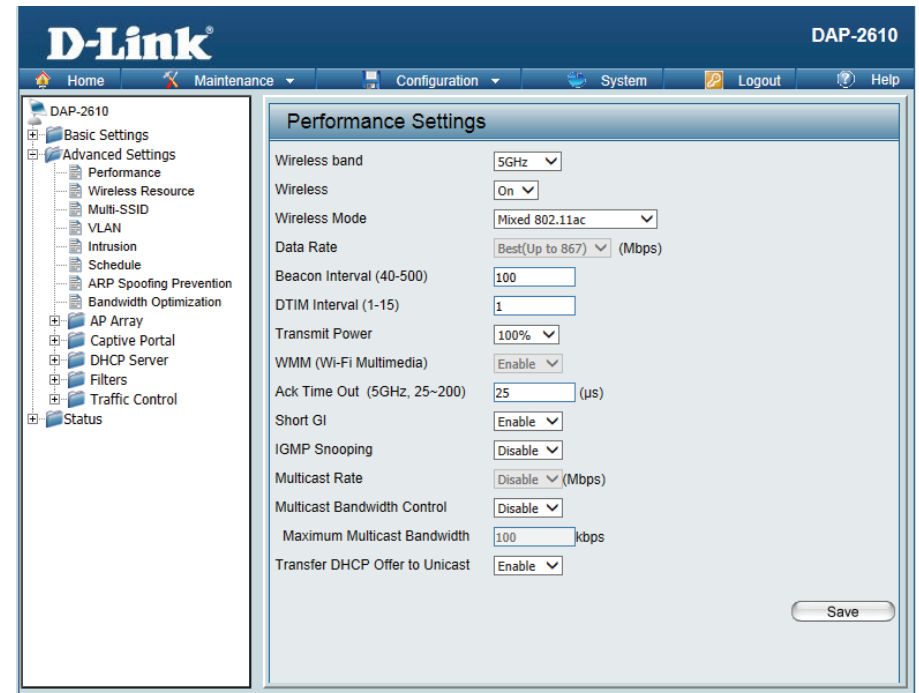

Advanced Settings

In the Advanced Settings Section the user can configure advanced settings concerning Performance, Multiple SSID, VLAN, Security, Quality of Service, AP Array, Web Redirection, DHCP Server, Filters and Scheduling. The following pages will explain settings found in the Advanced Settings section in more detail.

The screenshot displays the D-Link DAP-2660 web management interface. The top navigation bar includes 'Home', 'Maintenance', 'Configuration', 'System', 'Logout', and 'Help'. The left sidebar shows a tree view with 'DAP-2660' expanded, containing 'Basic Settings' and 'Advanced Settings'. Under 'Advanced Settings', 'Performance' is selected. The main content area is titled 'Performance Settings' and contains the following configuration options:

Setting	Value
Wireless band	5GHz
Wireless	Off
Wireless Mode	Mixed 802.11ac
Data Rate	Best(Up to 867) (Mbps)
Beacon Interval (40-500)	100
DTIM Interval (1-15)	1
Transmit Power	100%
WMM (Wi-Fi Multimedia)	Enable
Ack Time Out (5GHz, 25~200)	25 (μs)
Short GI	Enable
IGMP Snooping	Disable
Multicast Rate	Disable (Mbps)
Multicast Bandwidth Control	Disable
Maximum Multicast Bandwidth	100 kbps
HT20/40 Coexistence	Disable
Transfer DHCP Offer to Unicast	Disable

A 'Save' button is located at the bottom right of the configuration area.

Performance

On the Performance Settings page the users can configure more advanced settings concerning the wireless signal and hosting.

Wireless Band: Select either 2.4GHz or 5GHz.

Wireless: Use the drop-down menu to turn the wireless function On or Off.

Wireless Mode: The different combination of clients that can be supported include Mixed 802.11n, 802.11g and 802.11b, Mixed 802.11g and 802.11b and 802.11n Only in the 2.4 GHz band and Mixed 802.11n, 802.11a, 802.11a only, and 802.11n Only in the 5 GHz band. Please note that when backwards compatibility is enabled for legacy (802.11a/g/b) clients, degradation of 802.11n (draft) wireless performance is expected.

Data Rate*: Indicate the base transfer rate of wireless adapters on the wireless LAN. The AP will adjust the base transfer rate depending on the base rate of the connected device. If there are obstacles or interference, the AP will step down the rate. This option is enabled in Mixed 802.11g and 802.11b mode (for 2.4 GHz) and 802.11a only mode (for 5 GHz). The choices available are Best (Up to 54), 54, 48, 36, 24, 18, 12, 9, 6 for 5 GHz and Best (Up to 54), 54, 48, 36, 24, 18, 12, 9, 6, 11, 5.5, 2 or 1 for 2.4 GHz.

Beacon Interval (25-500): Beacons are packets sent by an access point to synchronize a wireless network. Specify a value in milliseconds. The default (100) is recommended. Setting a higher beacon interval can help to save the power of wireless clients, while setting a lower one can help a wireless client connect to an access point faster.

DTM Interval (1-15): Select a Delivery Traffic Indication Message setting between 1 and 15. 1 is the default setting. DTIM is a countdown informing clients of the next window for listening to broadcast and multicast messages.

The screenshot shows the 'Performance Settings' interface with the following configurations:

- Wireless band: 5GHz
- Wireless: Off
- Wireless Mode: Mixed 802.11ac
- Data Rate: Best(Up to 867) (Mbps)
- Beacon Interval (40-500): 100
- DTIM Interval (1-15): 1
- Transmit Power: 100%
- WMM (Wi-Fi Multimedia): Enable
- Ack Time Out (5GHz, 25~200): 25 (μs)
- Short GI: Enable
- IGMP Snooping: Disable
- Multicast Rate: Disable (Mbps)
- Multicast Bandwidth Control: Disable
- Maximum Multicast Bandwidth: 100 kbps
- HT20/40 Coexistence: Disable
- Transfer DHCP Offer to Unicast: Disable

A 'Save' button is located at the bottom right of the settings panel.

Transmit Power: This setting determines the power level of the wireless transmission. Transmitting power can be adjusted to eliminate overlapping of wireless area coverage between two access points where interference is a major concern. For example, if wireless coverage is intended for half of the area, then select 50% as the option. Use the drop-down menu to select 100%, 50%, 25%, or 12.5%.

WMM (Wi-Fi Multimedia): WMM stands for Wi-Fi Multimedia. Enabling this feature will improve the user experience for audio and video applications over a Wi-Fi network.

Ack Time Out (2.4 GHZ, 64~200): To effectively optimize throughput over long distance links enter a value for Acknowledgement Time Out between 25 and 200 microseconds for 5 GHz or from 64 to 200 microseconds in the 2.4 GHz in the field provided.

Short GI: Select Enable or Disable. Enabling a short guard interval can increase throughput. However, be aware that it can also increase the error rate in some installations due to increased sensitivity to radio-frequency installations.

IGMP Snooping: Select Enable or Disable. Internet Group Management Protocol allows the AP to recognize IGMP queries and reports sent between routers and an IGMP host (wireless STA). When IGMP snooping is enabled, the AP will forward multicast packets to an IGMP host based on IGMP messages passing through the AP.

Multicast Rate: Adjust the multicast packet data rate here. The multicast rate is supported in **AP mode**, (2.4 GHz and 5 GHz) and **WDS with AP mode**, including Multi-SSIDs.

Multicast Bandwidth Control : Adjust the multicast packet data rate here. The multicast rate is supported in AP mode, and WDS with AP mode, including Multi-SSIDs

Maximum Multicast Bandwidth : Set the multicast packets maximum bandwidth pass through rate from the Ethernet interface to the Access Point.

HT20/40 Coexistence : Enable this option to reduce interference from other wireless networks in your area. If the channel width is operating at 40MHz and there is another wireless network's channel over-lapping and causing interference, the Access Point will automatically change to 20MHz.

Transfer DHCP Offer to Unicast : Enable to transfer the DHCP Offer to Unicast from LAN to WLAN, suggest to enable this function if stations number is larger than 30.

Wireless Resource Control

The Wireless Resource Control window is used to configure the wireless connection settings so that the device can detect the better wireless connection in your environment.

Wireless band: Select **2.4GHz** or **5GHz**.

Band Steering: Use the drop-down menu to **Enable** the 5G Preferred function. When the wireless clients support both 2.4GHz and 5GHz and the 2.4GHz signal is not strong enough, the device will use 5G as higher priority.

Band Steering Age: Enter the time in seconds to specify the interval of updating information.

Band Steering Difference: The 5G preferred difference value is equal to the number of 5GHz wireless client connections minus the number of 2.4GHz wireless client connections. If the number of 5GHz wireless client connections minus the number of 2.4GHz wireless client connections exceed this value, the extra 5GHz wireless client connections will be forced to connect to the 2.4GHz band and not the 5GHz band.

Band Steering Refuse Number: Enter the maximum 5G connection attempts allowed before the 5G preferred function will be disabled for the wireless station connection.

Connection Limit: Select **Enable** or **Disable**. This is an option for load balancing. This determines whether to limit the number of users accessing this device. The exact number is entered in the User Limit field below. This feature allows the user to share the wireless network traffic and the client using multiple APs. If this function is enabled and when the number of users exceeds this value, or the network utilization of this AP exceeds the percentage that has been specified, the DAP-2610 will not allow clients to associate with the AP.

User Limit: Set the maximum amount of users that are allowed access (zero to 64 users) to the device using the specified wireless band. The default setting is 20.

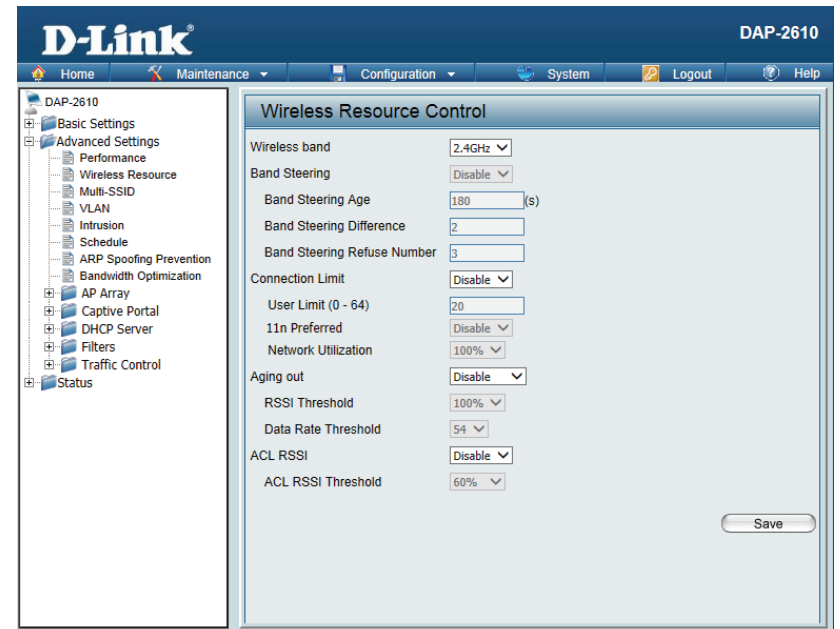

11n Preferred: Use the drop-down menu to **Enable** the 11n Preferred function. The wireless clients with 802.11n protocol will have higher priority to connect to the device.

Network Utilization: Set the maximum utilization of this access point for service. The DAP-2610 will not allow any new clients to associate with the AP if the utilization exceeds the value the user specifies. Select a utilization percentage between 100%, 80%, 60%, 40%, 20%, or 0%. When this network utilization threshold is reached, the device will pause one minute to allow network congestion to dissipate.

Aging out: Use the drop-down menu to select the criteria of disconnecting the wireless clients. Available options are **RSSI** and **Data Rate**.

RSSI Threshold: When **RSSI** is selected in the **Aging out** drop-down menu, select the percentage of RSSI here. When the RSSI of wireless clients is lower than the specified percentage, the device disconnects the wireless clients.

Data Rate Threshold: When **Data Rate** is selected in the **Aging out** drop-down menu, select the threshold of data rate here. When the data rate of wireless clients is lower than the specified number, the device disconnects the wireless clients.

ACL RSSI: Use the drop-down menu to **Enable** the function. When enabled, the device denies the connection request from the wireless clients with the RSSI lower than the specified threshold below.

ACL RSSI Threshold: Set the ACL RSSI Threshold.

Multi-SSID

The device supports up to four multiple Service Set Identifiers. You can set the Primary SSID in the Basic > Wireless section. The SSID's factory default setting is dlink. The SSID can be easily changed to connect to an existing wireless network or to establish a new wireless network.

Enable Multi-SSID: Check to enable support for multiple SSIDs.

Band: Select **2.4GHz** or **5GHz**.

Index: You can select up to seven multi-SSIDs. With the Primary SSID, you have a total of eight multi-SSIDs.

SSID: Service Set Identifier (SSID) is the name designated for a specific wireless local area network (WLAN). The SSID's factory default setting is **dlink**. The SSID can be easily changed to connect to an existing wireless network or to establish a new wireless network.

SSID Visibility: Enable or Disable SSID visibility. Enabling this feature broadcasts the SSID across the network, thus making it visible to all network users.

Security: The Multi-SSID security can be Open System, WPA-Personal, or WPA-Enterprise. For a detailed description of the Open System parameters please go to page 23. For a detailed description of the WPA-Personal parameters please go to page 24. For a detailed description of the WPA-Enterprise parameters please go to page 25.

Priority: Select the priority level of the SSID selected.

WMM (Wi-Fi Multimedia): WMM stands for Wi-Fi Multimedia. Enabling this feature will improve the user experience for audio and video applications over a Wi-Fi network.

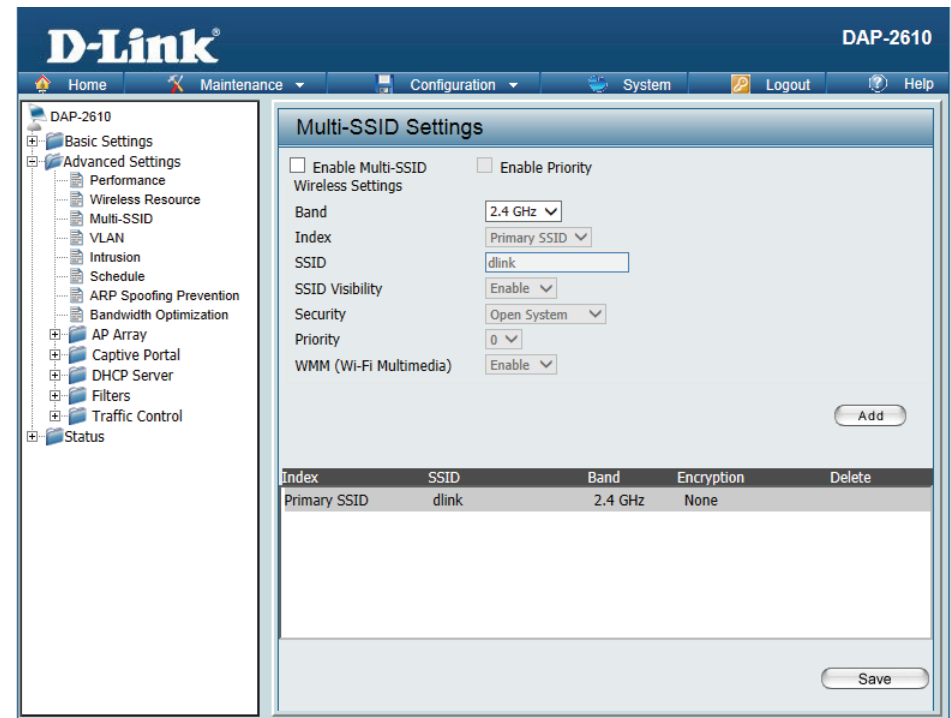

Encryption: When you select Open System, toggle between Enable and Disable. If Enable is selected, the Key Type, Key Size, Key Index (1~4), Key, and Confirm Keys must also be configured.

Key Type: Select HEX or ASCII.

Key Size: Select 64-bit or 128-bit.

Key Index (1-4): Select from the 1st to 4th key to be set as the active key.

Key: Input up to four keys for encryption. You will select one of these keys in the Key Index drop-down menu.

WPA Mode: When you select either WPA-Personal or WPA-Enterprise, you must also choose a WPA mode from the drop-down menu: AUTO (WPA or WPA2), WPA2 Only, or WPA Only. WPA and WPA2 use different algorithms. AUTO (WPA or WPA2) allows you to use both WPA and WPA2. In addition, you must configure Cipher Type, and Group Key Update Interval.

Cipher Type: Select Auto, AES, or TKIP from the drop-down menu.

Group Key Update Interval: Select the interval during which the group key will be valid. The default value of 1800 seconds is recommended.

Pass Phrase: When you select WPA-Personal, please enter a Pass Phrase in the corresponding field.

Confirm Pass Phrase: When you select WPA-Personal, please re-enter the Pass Phrase entered in the previous item in the corresponding field.

RADIUS Server: When you select WPA-Enterprise, enter the IP address of the RADIUS server. In addition, you must configure RADIUS Port and RADIUS Secret.

RADIUS Port: Enter the RADIUS port.

RADIUS Secret: Enter the RADIUS secret.

VLAN

VLAN List

The DAP-2610 supports VLANs. VLANs can be created with a Name and VID. Mgmt (TCP stack), LAN, Primary/Multiple SSID, and WDS connection can be assigned to VLANs as they are physical ports. Any packet which enters the DAP-2610 without a VLAN tag will have a VLAN tag inserted with a PVID. The VLAN List tab displays the current VLANs.

VLAN Status: Use the radio button to toggle to Enable. Next, go to the Add/Edit VLAN tab to add or modify an item on the VLAN List tab.

VLAN Mode: The current VLAN mode is displayed.

VLAN Settings

VLAN Status : Disable Enable Save

VLAN Mode : Static(2.4G), Static(5G)

VLAN List					
VID	VLAN Name	Untag VLAN Ports	Tag VLAN Ports	Edit	Delete
1	default	Mgmt, LAN, Primary(2.4G), S-1(2.4G), S-2(2.4G), S-3(2.4G), S-4(2.4G), S-5(2.4G), S-6(2.4G), S-7(2.4G), W-1(2.4G), W-2(2.4G), W-3(2.4G), W-4(2.4G), W-5(2.4G), W-6(2.4G), W-7(2.4G), W-8(2.4G), Primary(5G), S-1(5G), S-2(5G), S-3(5G), S-4(5G), S-5(5G), S-6(5G), S-7(5G), W-1(5G), W-2(5G), W-3(5G), W-4(5G), W-5(5G), W-6(5G), W-7(5G), W-8(5G)			

Port List

The Port List tab displays the current ports. If you want to configure the guest and internal networks on a Virtual LAN (VLAN), the switch and DHCP server you are using must also support VLANs. As a prerequisite step, configure a port on the switch for handling VLAN tagged packets as described in the IEEE 802.1Q standard.

VLAN Status: Use the radio button to toggle to Enable. Next, go to the Add/Edit VLAN tab to add or modify an item on the VLAN List tab.

Port Name: The name of the port is displayed in this column.

Tag VID: The Tagged VID is displayed in this column.

Untag VID: The Untagged VID is displayed in this column.

PVID: The Port VLAN Identifier is displayed in this column.

VLAN Settings			
VLAN Status : <input type="radio"/> Disable <input checked="" type="radio"/> Enable <input type="button" value="Save"/>			
VLAN Mode : Static(2.4G), Static(5G)			
VLAN List	Port List	Add/Edit VLAN	PVID Setting
Port Name	Tag VID	Untag VID	PVID
Mgmt		1	1
LAN		1	1
Primary(2.4G)		1	1
Primary(5G)		1	1
S-1(2.4G)		1	1
S-2(2.4G)		1	1
S-3(2.4G)		1	1
S-4(2.4G)		1	1
S-5(2.4G)		1	1
S-6(2.4G)		1	1
S-7(2.4G)		1	1
W-1(2.4G)		1	1
W-2(2.4G)		1	1
W-3(2.4G)		1	1
W-4(2.4G)		1	1
W-5(2.4G)		1	1
W-6(2.4G)		1	1
W-7(2.4G)		1	1
W-8(2.4G)		1	1
S-1(5G)		1	1
S-2(5G)		1	1
S-3(5G)		1	1
S-4(5G)		1	1
S-5(5G)		1	1
S-6(5G)		1	1
S-7(5G)		1	1
W-1(5G)		1	1
W-2(5G)		1	1
W-3(5G)		1	1
W-4(5G)		1	1
W-5(5G)		1	1
W-6(5G)		1	1
W-7(5G)		1	1
W-8(5G)		1	1

Add/Edit VLAN

The Add/Edit VLAN tab is used to configure VLANs. Once you have made the desired changes, click the Save button to let your changes take effect.

VLAN Status: Use the radio button to toggle to Enable.

VLAN ID: Provide a number between 1 and 4094 for the Internal VLAN.

VLAN Name: Enter the VLAN to add or modify.

VLAN Settings

VLAN Status : Disable Enable Save

VLAN Mode : Static(2.4G), Static(5G)

VLAN List | Port List | **Add/Edit VLAN** | PVID Setting

VLAN ID (VID) VLAN Name

Port	Select All	Mgmt	LAN
Untag	All	<input type="radio"/>	<input type="radio"/>
Tag	All	<input type="radio"/>	<input type="radio"/>
Not Member	All	<input type="radio"/>	<input type="radio"/>

2.4GHz

MSSID Port	Select All	Primary	S-1	S-2	S-3	S-4	S-5	S-6	S-7
Untag	All	<input type="radio"/>	<input type="radio"/>	<input type="radio"/>	<input type="radio"/>	<input type="radio"/>	<input type="radio"/>	<input type="radio"/>	<input type="radio"/>
Tag	All	<input type="radio"/>	<input type="radio"/>	<input type="radio"/>	<input type="radio"/>	<input type="radio"/>	<input type="radio"/>	<input type="radio"/>	<input type="radio"/>
Not Member	All	<input type="radio"/>	<input type="radio"/>	<input type="radio"/>	<input type="radio"/>	<input type="radio"/>	<input type="radio"/>	<input type="radio"/>	<input type="radio"/>

WDS Port	Select All	W-1	W-2	W-3	W-4	W-5	W-6	W-7	W-8
Untag	All	<input type="radio"/>	<input type="radio"/>	<input type="radio"/>	<input type="radio"/>	<input type="radio"/>	<input type="radio"/>	<input type="radio"/>	<input type="radio"/>
Tag	All	<input type="radio"/>	<input type="radio"/>	<input type="radio"/>	<input type="radio"/>	<input type="radio"/>	<input type="radio"/>	<input type="radio"/>	<input type="radio"/>
Not Member	All	<input type="radio"/>	<input type="radio"/>	<input type="radio"/>	<input type="radio"/>	<input type="radio"/>	<input type="radio"/>	<input type="radio"/>	<input type="radio"/>

5GHz

MSSID Port	Select All	Primary	S-1	S-2	S-3	S-4	S-5	S-6	S-7
Untag	All	<input type="radio"/>	<input type="radio"/>	<input type="radio"/>	<input type="radio"/>	<input type="radio"/>	<input type="radio"/>	<input type="radio"/>	<input type="radio"/>
Tag	All	<input type="radio"/>	<input type="radio"/>	<input type="radio"/>	<input type="radio"/>	<input type="radio"/>	<input type="radio"/>	<input type="radio"/>	<input type="radio"/>
Not Member	All	<input type="radio"/>	<input type="radio"/>	<input type="radio"/>	<input type="radio"/>	<input type="radio"/>	<input type="radio"/>	<input type="radio"/>	<input type="radio"/>

WDS Port	Select All	W-1	W-2	W-3	W-4	W-5	W-6	W-7	W-8
Untag	All	<input type="radio"/>	<input type="radio"/>	<input type="radio"/>	<input type="radio"/>	<input type="radio"/>	<input type="radio"/>	<input type="radio"/>	<input type="radio"/>
Tag	All	<input type="radio"/>	<input type="radio"/>	<input type="radio"/>	<input type="radio"/>	<input type="radio"/>	<input type="radio"/>	<input type="radio"/>	<input type="radio"/>
Not Member	All	<input type="radio"/>	<input type="radio"/>	<input type="radio"/>	<input type="radio"/>	<input type="radio"/>	<input type="radio"/>	<input type="radio"/>	<input type="radio"/>

Save

PVID Settings

The PVID Setting tab is used to enable/disable the Port VLAN Identifier Auto Assign Status as well as to configure various types of PVID settings. Click the Save button to let your changes take effect.

VLAN Status: Use the radio button to toggle between Enable and Disable.

PVID Auto Assign Status: Use the radio button to toggle PVID auto assign status to Enable.

VLAN Settings

VLAN Status : Disable Enable Save

VLAN Mode : Static(2.4G), Static(5G)

VLAN List | Port List | Add/Edit VLAN | **PVID Setting**

PVID Auto Assign Status Disable Enable

Port	Mgmt	LAN
PVID	1	1

2.4GHz

MSSID Port	Primary	S-1	S-2	S-3	S-4	S-5	S-6	S-7
PVID	1	1	1	1	1	1	1	1
WDS Port	W-1	W-2	W-3	W-4	W-5	W-6	W-7	W-8
PVID	1	1	1	1	1	1	1	1

5GHz

MSSID Port	Primary	S-1	S-2	S-3	S-4	S-5	S-6	S-7
PVID	1	1	1	1	1	1	1	1
WDS Port	W-1	W-2	W-3	W-4	W-5	W-6	W-7	W-8
PVID	1	1	1	1	1	1	1	1

Save

Intrusion

The Wireless Intrusion Protection window is used to set APs as All, Valid, Neighborhood, Rogue, and New. Click the Save button to let your changes take effect.

Wireless Band: Select 2.4GHz or 5GHz.

AP List: The choices include All, Valid, Neighbor, Rogue, and New.

Detect: Click this button to initiate a scan of the network.

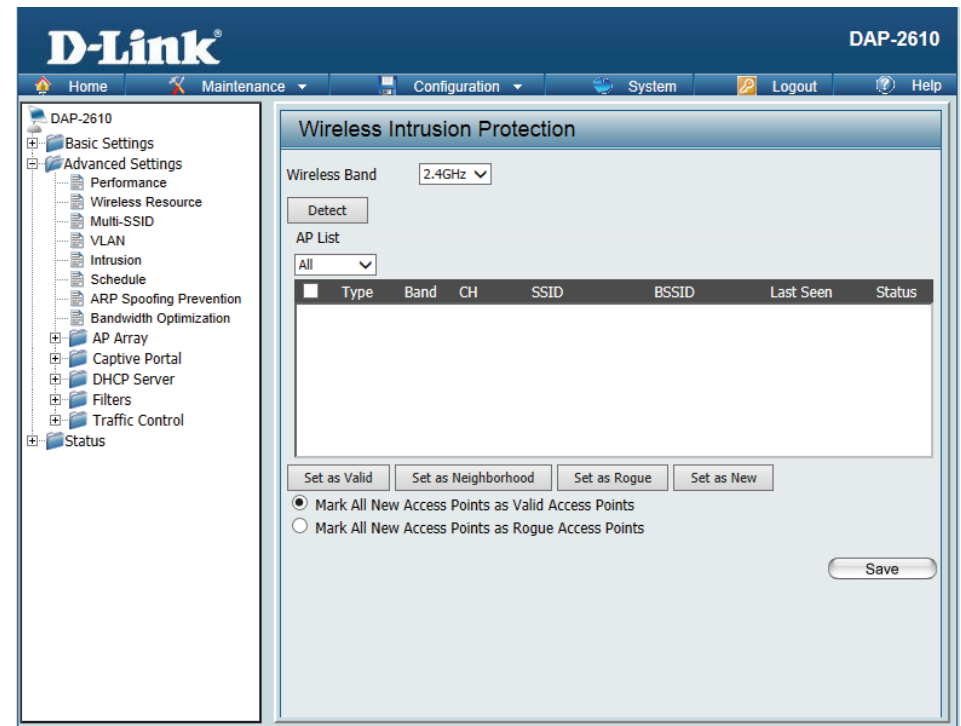

Schedule

The Wireless Schedule Settings window is used to add and modify scheduling rules on the device. Click the Save button to let your changes take effect.

Wireless Schedule: Use the drop-down menu to enable the device's scheduling feature.

Name: Enter a name for the new scheduling rule in the field provided.

Index: Use the drop-down menu to select the desired SSID.

SSID: This read-only field indicates the current SSID in use. To create a new SSID, go to the Wireless Settings window (Basic Settings > Wireless).

Day(s): Toggle the radio button between All Week and Select Day(s). If the second option is selected, check the specific days you want the rule to be effective on.

All Day(s): Check this box to have your settings apply 24 hours a day.

Start Time: Enter the beginning hour and minute, using a 24-hour clock.

End Time: Enter the ending hour and minute, using a 24-hour clock.

Wireless Schedule Settings

Wireless Schedule:

Add Schedule Rule

Name:

Index:

SSID:

Day(s): All Week Select Day(s)

Sun Mon Tue Wed Thu Fri Sat

All Day(s):

Start Time: : (hour:minute, 24 hour time)

End Time: : (hour:minute, 24 hour time) Overnight

Schedule Rule List

Name	SSID Index	SSID	Day(s)	Time Frame	Wireless	Edit	DEL
+: To the end time of the next day overnight.							

Internal RADIUS Server

The DAP-2610 features a built-in RADIUS server. Once you have finished adding a RADIUS account, click the Save button to let your changes take effect. The newly-created account will appear in this RADIUS Account List. The radio buttons allow the user to enable or disable the RADIUS account. Click the icon in the delete column to remove the RADIUS account. We suggest you limit the number of accounts below 30.

User Name: Enter a name to authenticate user access to the internal RADIUS server.

Password: Enter a password to authenticate user access to the internal RADIUS server. The length of your password should be 8~64.

Status: Toggle the drop-down menu between Enable and Disable.

RADIUS Account List: Displays the list of users.

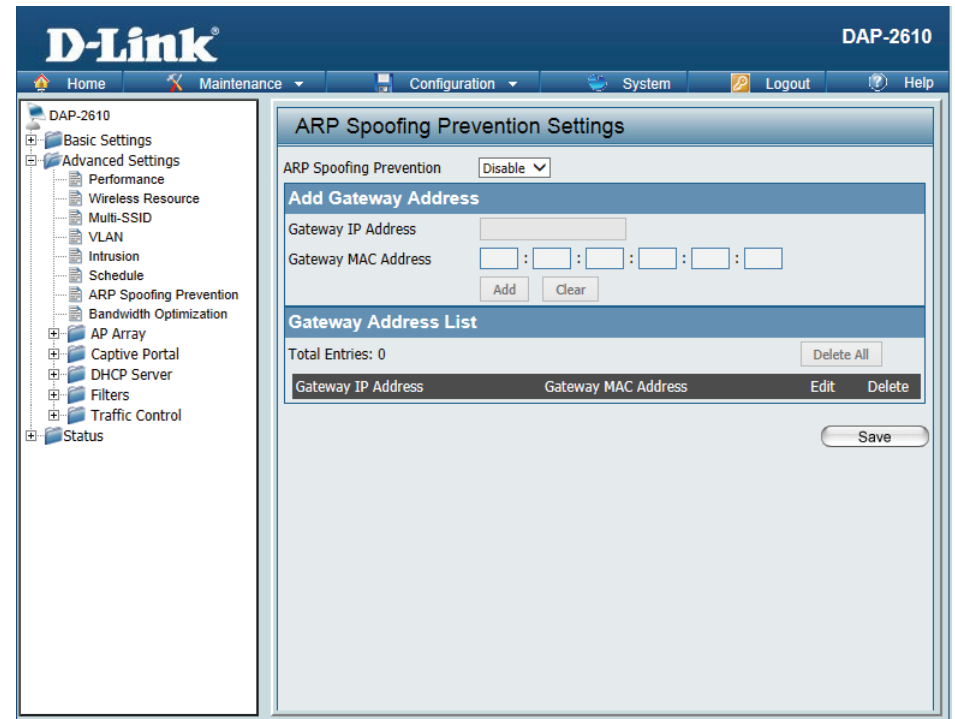

ARP Spoofing Prevention

The ARP Spoofing Prevention feature allows users to add IP/MAC address mapping to prevent arp spoofing attack.

ARP Spoofing Prevention: This check box allows you to enable the arp spoofing prevention function.

Gateway IP Address: Enter a gateway IP address.

Gateway MAC Address: Enter a gateway MAC address.

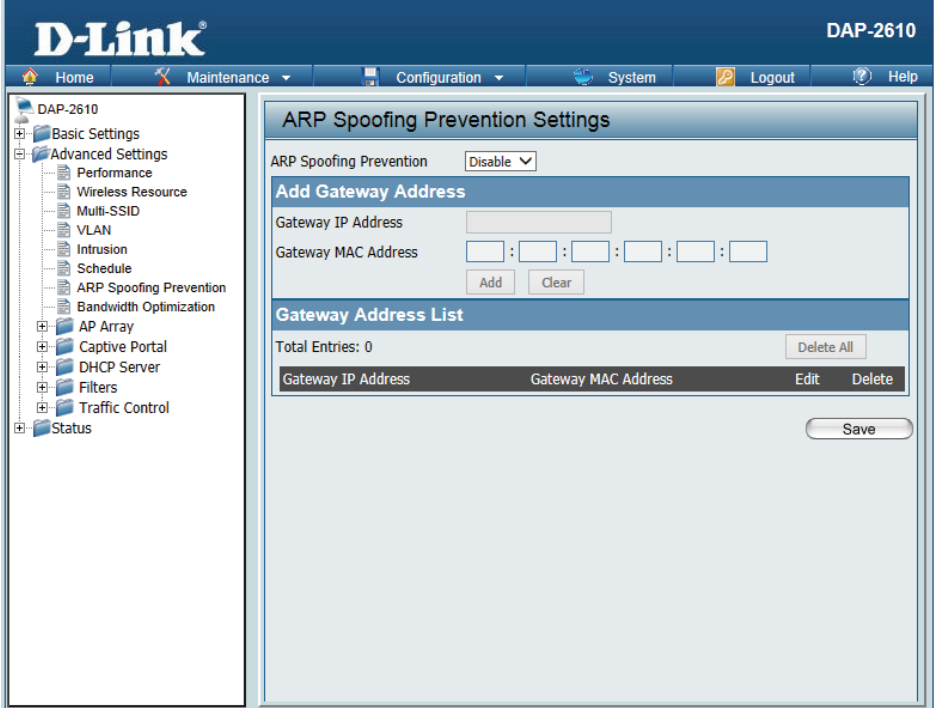

The screenshot displays the D-Link DAP-2610 web interface. The top navigation bar includes Home, Maintenance, Configuration, System, Logout, and Help. The left sidebar shows a tree view of settings, with 'ARP Spoofing Prevention' selected under 'Advanced Settings'. The main content area is titled 'ARP Spoofing Prevention Settings'. It features a 'Disable' dropdown menu for the 'ARP Spoofing Prevention' checkbox. Below this is an 'Add Gateway Address' section with input fields for 'Gateway IP Address' and 'Gateway MAC Address' (formatted as four pairs of boxes separated by colons), and 'Add' and 'Clear' buttons. A 'Gateway Address List' section shows 'Total Entries: 0' and a 'Delete All' button. Below the list is a table header with columns for 'Gateway IP Address', 'Gateway MAC Address', 'Edit', and 'Delete'. A 'Save' button is located at the bottom right of the settings area.

Bandwidth Optimization

The Bandwidth Optimization window allows the user to manage the bandwidth of the device and arrange the bandwidth for various wireless clients. When the Bandwidth Optimization rule is finished, click the **Add** button. To discard the Add Bandwidth Optimization Rule settings, click the **Clear** button. Click the **Save** button to let your changes take effect.

Enable Bandwidth Optimization: Use the drop-down menu to Enable the Bandwidth Optimization function.

Downlink Bandwidth: Enter the downlink bandwidth of the device in Mbits per second.

Uplink Bandwidth: Enter the uplink bandwidth of the device in Mbits per second.

Allocate average BW for each station: AP will distribute average bandwidth for each client.

Allocate maximum BW for each station: Specify the maximum bandwidth for each connected client. Reserve certain bandwidth for future clients.

Allocate different BW for a/b/g/n stations: The weight of 11b/g/n and 11a/n client are 10%/20%/70% ; 20%/80%. AP will distribute different bandwidth for 11a/b/g/n clients.

Allocate specific BW for SSID: All clients share the total bandwidth.

Rule Type: Use the drop-down menu to select the type that is applied to the rule. Available options are: **Allocate average BW for each station**, **Allocate maximum BW for each station**, **Allocate different BW for 1a/b/g/n stations**, and **Allocate specific BW for SSID**.

D-Link DAP-2610

Home Maintenance Configuration System Logout Help

DAP-2610

- Basic Settings
- Advanced Settings
 - Performance
 - Wireless Resource
 - Multi-SSID
 - VLAN
 - Intrusion
 - Schedule
 - ARP Spoofing Prevention
 - Bandwidth Optimization
- AP Array
- Captive Portal
- DHCP Server
- Filters
- Traffic Control
- Status

Bandwidth Optimization

Enable Bandwidth Optimization:

Downlink Bandwidth: Mbits/sec

Uplink Bandwidth: Mbits/sec

Add Bandwidth Optimization Rule

Rule Type:

Band:

SSID Index:

Downlink Speed: Kbits/sec

Uplink Speed: Kbits/sec

Bandwidth Optimization Rules

Band	Type	SSID Index	Downlink Speed	Uplink Speed	Edit	Del

Band: Use the drop-down menu to toggle the wireless band between 2.4GHz and 5GHz.

SSID Index: Use the drop-down menu to select the SSID for the specified wireless band.

Downlink Speed: Enter the limitation of the downloading speed in either Kbits/sec or Mbits/sec for the rule.

Uplink Speed: Enter the limitation of the uploading speed in either Kbits/sec or Mbits/sec for the rule.

AP Array

AP Array Scan

The AP Array window is used to create up to 32 APs on a local network to be organized into a single group in order to increase ease of management. Click the **Save** button to let your changes take effect. Central WiFiManager and AP Array are mutually exclusive functions.

Enable AP Array: Select the check box to enable the AP array function. The three modes that are available are **Master**, **Backup Master**, and **Slave**. APs in the same array will use the same configuration. The configuration will sync the Master AP to the Slave AP and the Backup Master AP when a Slave AP and a Backup Master AP join the AP array.

AP Array Name: Enter an AP array name for the group here.

AP Array Password: Enter an AP array password for the group here. This password must be the same on all the APs in the group.

Scan AP Array List: Click this button to initiate a scan of all the available APs currently on the network.

Connection Status: Display the AP array connection status.

AP Array List: This table displays the current AP array status for the following parameters: Array Name, Master IP, MAC, Master, Backup Master, Slave, and Total.

Current Members: This table displays all the current array members. The DAP-2610 AP array feature supports up to eight AP array members.

The screenshot shows the D-Link DAP-2610 web interface. The main configuration area for 'AP Array Scan' includes the following elements:

- Enable AP Array (Version: 2.01)
- Mode selection: Master, Backup Master, Slave
- AP Array Name:
- AP Array Password:
- Scan AP Array List:
- Connection Status: Disconnect

Below the configuration area are two tables:

AP Array List

Array Name	Master IP	MAC	Master	Backup Master	Slave	Total

Current Members

Index	Role	IP Address	MAC Address	Location

A button is located at the bottom right of the configuration area.

Configuration Settings

In the AP array configuration settings windows, users can specify which settings all the APs in the group will inherit from the master AP. Make the required selection in this window and click the **Save** button to accept the changes made.

- Enable AP Array Configuration:** Select to **Enable** or **Disable** the AP array configuration feature here.
- Wireless Basic Settings:** Select this option to specify the basic wireless settings that the APs in the group will inherit.
- Wireless Advanced Settings:** Select this option to specify the advanced wireless settings that the APs in the group will inherit.
- Multiple SSID & VLAN:** Select this option to specify the multiple SSIDs and VLAN settings that the APs in the group will inherit.
- Advanced Functions:** Select this option to specify the other advanced settings that the APs in the group will inherit.
- Administration Settings:** Select this option to specify the administrative settings that the APs in the group will inherit.

The screenshot shows the 'AP Array Configuration' window. At the top, there is a section for 'Enable AP Array Configuration' with a dropdown menu set to 'Enable' and a 'Clear all' button. Below this are five expandable sections, each with a checkbox: 'Wireless Basic Settings', 'Wireless Advanced Settings', 'Multiple SSID & VLAN', 'Advanced Functions', and 'Administration Settings'. A 'Save' button is located at the bottom right of the window.

Wireless Basic Settings

Network Name (SSID): Select this option to use the same SSID.

SSID Visibility: Select this option to enable SSID visibility.

Auto Channel Selection: Select this option to use auto channel selection.

Channel Width: Select this option to use the same channel width.

Security: Select this option to use the same wireless security.

Captive Profile: Select this option to use the same captive profile settings.

Band: Select this option to use the same wireless band.

Wireless Basic Settings <input checked="" type="checkbox"/>			
Network Name (SSID)	<input checked="" type="checkbox"/>	SSID Visibility	<input checked="" type="checkbox"/>
Auto Channel Selection	<input checked="" type="checkbox"/>	Channel Width	<input checked="" type="checkbox"/>
Security	<input checked="" type="checkbox"/>	Captive Profile	<input checked="" type="checkbox"/>
Band	<input checked="" type="checkbox"/>		

Wireless Advanced Settings

Wireless: Select this option to use the same wireless settings.

Wireless Mode: Select this option to use the same wireless mode.

Data Rate: Select this option to use the same data rate.

Beacon Interval: Select this option to use the same beacon interval.

DTIM Interval: Select this option to use the same DTIM interval.

Transmit Power: Select this option to use the same transmit power.

WMM (Wi-Fi Multimedia): Select this option to use the same WMM settings.

Ack Time Out: Select this option to use the same ACK timeout value.

Wireless ACL: Select this option to use the same wireless ACL settings.

Wireless Advanced Settings <input checked="" type="checkbox"/>			
Wireless	<input checked="" type="checkbox"/>	Wireless Mode	<input checked="" type="checkbox"/>
Data Rate	<input checked="" type="checkbox"/>	Beacon Interval	<input checked="" type="checkbox"/>
DTIM Interval	<input checked="" type="checkbox"/>	Transmit Power	<input checked="" type="checkbox"/>
WMM (Wi-Fi Multimedia)	<input checked="" type="checkbox"/>	Ack Time Out	<input checked="" type="checkbox"/>
Wireless ACL	<input checked="" type="checkbox"/>	Short GI	<input checked="" type="checkbox"/>
Link Integrity	<input checked="" type="checkbox"/>	Connection Limit	<input checked="" type="checkbox"/>
IGMP Snooping	<input checked="" type="checkbox"/>		

Short GI: Select this option to use the same short GI settings.

Link Integrity: Select this option to use the same link integrity settings.

Connection Limit: Select this option to use the same connection limit value.

IGMP Snooping: Select this option to use the same IGMP snooping settings.

Multiple SSID & VLAN

SSID: Select this option to use the same multi-SSIDs.

SSID Visibility: Select this option to use the same SSID visible.

Security: Select this option to use the same wireless security settings.

WMM: Select this option to use the same WMM settings.

Captive Profile: Select this option to use the same captive profile settings.

VLAN: Select this option to use the same VLAN settings.

Multiple SSID & VLAN <input checked="" type="checkbox"/>			
SSID	<input checked="" type="checkbox"/>	SSID Visibility	<input checked="" type="checkbox"/>
Security	<input checked="" type="checkbox"/>	WMM	<input checked="" type="checkbox"/>
Captive Profile	<input checked="" type="checkbox"/>	VLAN	<input checked="" type="checkbox"/>

Advanced Functions

Schedule Settings: Select this option to use the same schedule settings.

QoS Settings: Select this option to use the same Quality of Service settings.

Log Settings: Select this option to use the same log settings.

Time and Date Settings: Select this option to use the same time and date settings.

Advanced Functions <input checked="" type="checkbox"/>			
Schedule Settings	<input checked="" type="checkbox"/>	QoS Settings	<input checked="" type="checkbox"/>
Log Settings	<input checked="" type="checkbox"/>	Time and Date Settings	<input checked="" type="checkbox"/>
ARP Spoofing Prevention	<input checked="" type="checkbox"/>	Bandwidth Optimization	<input checked="" type="checkbox"/>
Captive Portal	<input checked="" type="checkbox"/>	Auto RF	<input checked="" type="checkbox"/>
Load Balance	<input checked="" type="checkbox"/>	DHCP server Settings	<input checked="" type="checkbox"/>

ARP Spoofing Prevention: Select this option to use the same ARP spoofing prevention settings.

Bandwidth Optimization: Select this option to use the same bandwidth optimization settings.

Captive Portal: Select this option to use the same captive portal settings.

Auto RF: Select this option to use the same auto-RF settings.

Load Balance: Select this option to use the same load balancing settings.

DHCP Server Settings: Select this option to use the same DHCP server settings.

Administration Settings

System Name Settings: Select this option to use the same system name.

SNMP Settings: Select this option to use the same SNMP settings.

Login Settings: Select this option to use the same login settings.

Console Settings: Select this option to use the same console settings.

Limit Administrator: Select this option to use the same limit administrator settings.

Ping Control Setting: Select this option to use the same ping control settings.

Administration Settings <input checked="" type="checkbox"/>			
System Name Settings	<input checked="" type="checkbox"/>	SNMP Settings	<input checked="" type="checkbox"/>
Login Settings	<input checked="" type="checkbox"/>	Console Settings	<input checked="" type="checkbox"/>
Limit Administrator	<input checked="" type="checkbox"/>	Ping Control Setting	<input checked="" type="checkbox"/>

Auto-RF

In this windows, users can view and configure the automatic radio frequency settings as well as configure the the auto-initiate period and threshold values. Click the **Save** button to accept the changes made.

Enable: Auto-RF: Select to **Enable** or **Disable** the auto-RF feature here.

Initiate Auto-RF: Click the **Auto-RF Optimize** button to initiate the auto-RF optimization feature.

Auto-Initiate: Select the **Enable** or **Disable** the auto-initiate feature here.

Auto-Initiate Period: After enabling the auto-initiate option, the auto-initiate period value can be entered here. This value must be between 1 and 24 hours.

RSSI Threshold: Select the RSSI threshold value here. This value is listed in the drop-down menu in increments of 10% from **10%** to **100%**.

RF Report Frequency: Enter the RF report frequency value here.

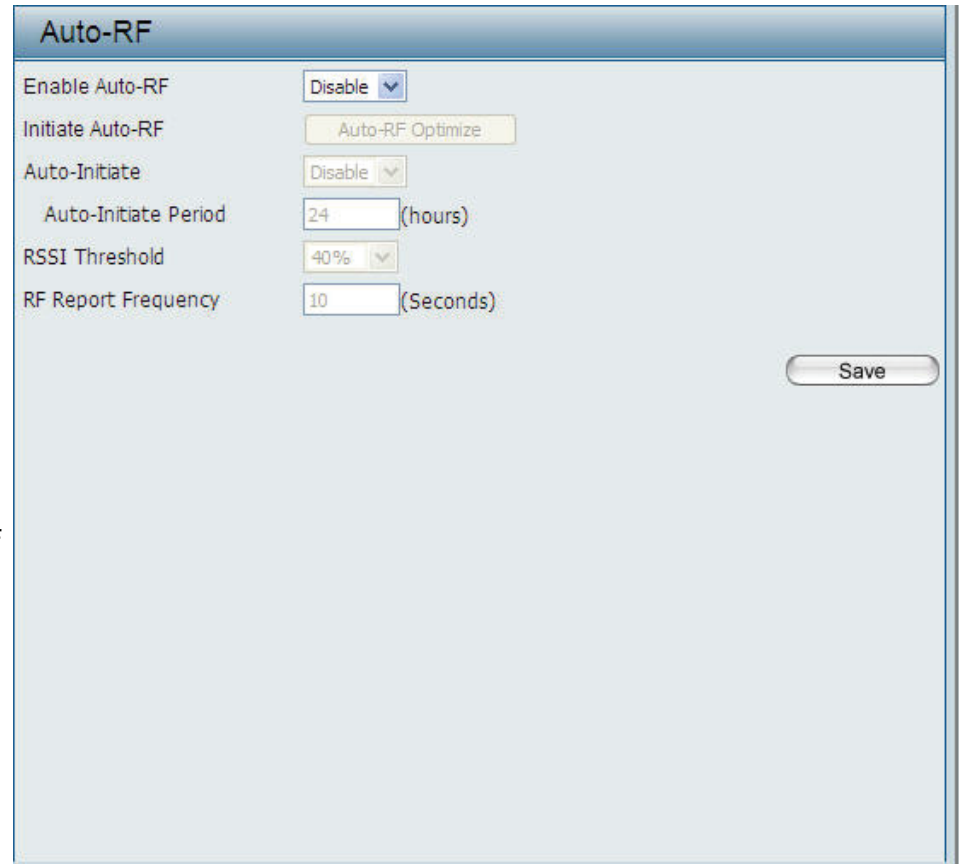

The screenshot shows the 'Auto-RF' configuration window with the following settings:

Setting	Value
Enable Auto-RF	Disable
Initiate Auto-RF	Auto-RF Optimize
Auto-Initiate	Disable
Auto-Initiate Period	24 (hours)
RSSI Threshold	40%
RF Report Frequency	10 (Seconds)

A 'Save' button is located at the bottom right of the window.

Load Balance

In this window, users can view and configure the AP array's load balancing settings. Click the Save button to accept the changes made.

Enable Load Balance: Select to **Enable** or **Disable** the load balance feature here.

Active Threshold: Enter the active threshold value here.

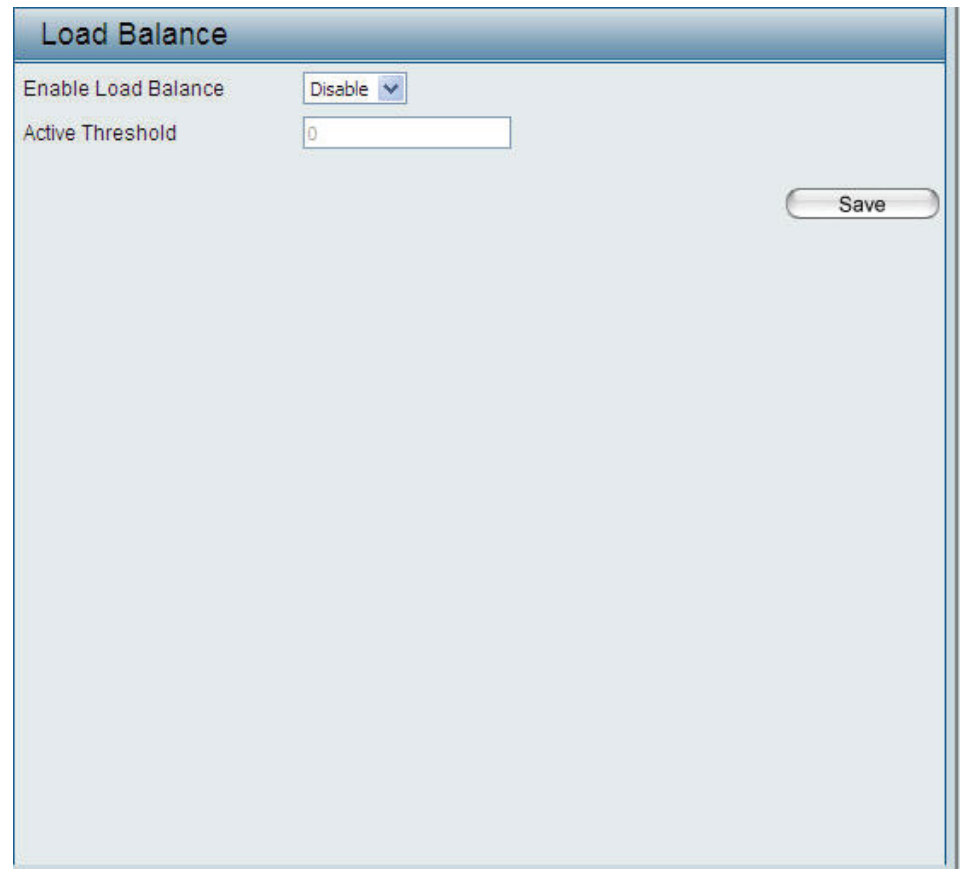

The screenshot shows a configuration window titled "Load Balance". It contains two main settings: "Enable Load Balance" with a dropdown menu currently set to "Disable", and "Active Threshold" with a text input field containing the value "0". A "Save" button is located in the bottom right corner of the window.

Captive Portal

Authentication Settings-Web Redirection Only

The Captive Portal is a built-in web authentication server. When a station connects to an AP, the web browser will be redirected to a web authentication page. In this window, user can view and configure the Captive Portal settings. After selecting Web Redirection Only as the Authentication Type, we can configure the redirection website URL that will be applied to each wireless client in this network.

Session timeout(1-1440) : Enter the session timeout value here. This value can be from 1 to 1440 minutes. By default, this value is 60 minutes.

Band : Select 2.4GHz or 5GHz.

SSID Index : Select the SSID for this Authentication.

Authentication Type : Select the captive portal encryption type here. Options to choose from are Web Redirection, Username/Password, Passcode, Remote RADIUS, LDAP and POP3. In this section we'll discuss the Web Redirection option.

Web Redirection State : Default setting is Enable when select Web Redirection Only.

URL Path : Select whether to use either HTTP or HTTPS here. After selecting either http:// or https://, enter the URL of the website that will be used in the space provided.

IPIF Status : Select to Enable or Disable the Captive Portal with its IP interface feature here.

VLAN Group : Enter the VLAN Group ID here

Get IP From : Static IP (Manual) is chosen here. Choose this option if you do not have a DHCP server in your network, or if you wish to assign a static IP address to the DAP-2610. When Dynamic IP (DHCP) is selected, the other fields here will be grayed out. Please allow about 2 minutes for the DHCP client to be functional once this selection is made.

The screenshot displays the 'Captive Portal Authentication' configuration page for a D-Link DAP-2610 device. The interface includes a navigation menu on the left and a main configuration area on the right. The configuration area is divided into sections: 'Basic Settings', 'Web Redirection Interface Settings', and 'IP Interface Settings'. The 'Web Redirection Interface Settings' section is currently active, showing fields for Session Timeout (60 minutes), Band (2.4GHz), SSID Index (Primary SSID), Authentication Type (Web Redirection Only), Web Redirection State (Enable), and URL Path (http://). The 'IP Interface Settings' section is also visible, with IPIF Status set to Disable and Get IP From set to Static IP(Manual). A 'Save' button is located at the bottom right of the configuration area. Below the settings is a table with columns: Band, SSID Index, Captive Profile, Edit, and Delete.

Band	SSID Index	Captive Profile	Edit	Delete

IP Address : Assign a static IP address that is within the IP address range of your network.

Subnet Mask : Enter the subnet mask. All devices in the network must share the same subnet mask.

Gateway : Enter the IP address of the gateway/router in your network.

DNS : Enter a DNS server IP address. This is usually the local IP address of your gateway/router.

Authentication Settings- Username/Password

The Captive Portal is a built-in web authentication server. When a station connects to an AP, the web browser will be redirected to a web authentication page. In this window, user can view and configure the Captive Portal settings. After selecting Username/Password as the Authentication Type, we can configure the Username/Password authentication that will be applied to each wireless client in this network.

Session timeout(1-1440) : Enter the session timeout value here. This value can be from 1 to 1440 minutes. By default, this value is 60 minutes.

Band : Select 2.4GHz or 5GHz.

SSID Index : Select the SSID for this Authentication.

Authentication Type : Select the captive portal encryption type here. Options to choose from are Web Redirection, Username/Password, Passcode, Remote RADIUS, LDAP and POP3. In this section we'll discuss the Username/Password option.

Web Redirection State : Default is Disable or select Enable to enable the website redirection feature.

URL Path : Select whether to use either HTTP or HTTPS here. After selecting either http:// or https://, enter the URL of the website that will be used in the space provided.

IPIF Status : Select to Enable or Disable the Captive Portal with its IP interface feature here.

VLAN Group : Enter the VLAN Group ID here

Get IP From : Static IP (Manual) is chosen here. Choose this option if you do not have a DHCP server in your network, or if you wish to assign a static IP address to the DAP-2610. When Dynamic

The screenshot shows the D-Link DAP-2610 web interface. The main content area is titled "Captive Portal Authentication".

Session Timeout (1-1440): 60 Minute(s)

Band: 2.4GHz

SSID Index: Primary SSID

Authentication Type: Username/Password

Web Redirection Interface Settings:

- Web Redirection State: Disable
- URL Path: http://

IP Interface Settings:

- IPIF Status: Disable
- VLAN Group:
- Get IP From: Static IP(Manual)
- IP Address:
- Subnet Mask:
- Gateway:
- DNS:

Username/Password Settings:

- Username:
- Password:

Buttons: Add, Clear

Username	Edit	Delete

Save

Band	SSID Index	Captive Profile	Edit	Delete

IP (DHCP) is selected, the other fields here will be grayed out. Please allow about 2 minutes for the DHCP client to be functional once this selection is made.

IP Address: Assign a static IP address that is within the IP address range of your network.

Subnet Mask: Enter the subnet mask. All devices in the network must share the same subnet mask.

Gateway: Enter the IP address of the gateway/router in your network.

DNS: Enter a DNS server IP address. This is usually the local IP address of your gateway/router.

Username: Enter the username for the new account here.

Password: Enter the password for the new account here.

Authentication Settings- Passcode

The Captive Portal is a built-in web authentication server. When a station connects to an AP, the web browser will be redirected to a web authentication page. In this window, user can view and configure the Captive Portal settings. After selecting Passcode as the Authentication Type, we can configure the Passcode authentication that will be applied to each wireless client in this network.

Session timeout(1-1440) : Enter the session timeout value here. This value can be from 1 to 1440 minutes. By default, this value is 60 minutes.

Band : Select 2.4GHz or 5GHz.

SSID Index : Select the SSID for this Authentication.

Authentication Type : Select the captive portal encryption type here. Options to choose from are Web Redirection, Username/Password, Passcode, Remote RADIUS, LDAP and POP3. In this section we'll discuss the Passcode option.

Web Redirection State : Default is Disable or select Enable to enable the website redirection feature.

URL Path : Select whether to use either HTTP or HTTPS here. After selecting either http:// or https://, enter the URL of the website that will be used in the space provided.

IPIF Status : Select to Enable or Disable the Captive Portal with its IP interface feature here.

VLAN Group : Enter the VLAN Group ID here

Get IP From : Static IP (Manual) is chosen here. Choose this option if you do not have a DHCP server in your network, or if you wish to assign a static IP address to the DAP-2610. When Dynamic IP (DHCP) is selected, the other fields here will be

grayed out. Please allow about 2 minutes for the DHCP client to be functional once this selection is made.

IP Address: Assign a static IP address that is within the IP address range of your network.

Subnet Mask: Enter the subnet mask. All devices in the network must share the same subnet mask.

Gateway: Enter the IP address of the gateway/router in your network.

DNS: Enter a DNS server IP address. This is usually the local IP address of your gateway/router.

Passcode Quantity: Enter the number of ticket that will be used here.

Duration: Enter the duration value, in hours, for this passcode.

Last Active Day: Select the last active date for this passcode here. Year, Month and Day selections can be made.

User Limit: Enter the maximum amount of users that can use this passcode at the same time

Authentication Settings- Remote RADIUS

The Captive Portal is a built-in web authentication server. When a station connects to an AP, the web browser will be redirected to a web authentication page. In this window, user can view and configure the Captive Portal settings. After selecting Remote RADIUS as the Authentication Type, we can configure the Remote RADIUS authentication that will be applied to each wireless client in this network.

Session timeout(1-1440) : Enter the session timeout value here. This value can be from 1 to 1440 minutes. By default, this value is 60 minutes.

Band : Select 2.4GHz or 5GHz.

SSID Index : Select the SSID for this Authentication.

Authentication Type : Select the captive portal encryption type here. Options to choose from are Web Redirection, Username/Password, Passcode, Remote RADIUS, LDAP and POP3. In this section we'll discuss the Remote RADIUS option.

Web Redirection State : Default is Disable or select Enable to enable the website redirection feature.

URL Path : Select whether to use either HTTP or HTTPS here. After selecting either http:// or https://, enter the URL of the website that will be used in the space provided.

IPIF Status : Select to Enable or Disable the Captive Portal with its IP interface feature here.

VLAN Group : Enter the VLAN Group ID here

Get IP From : Static IP (Manual) is chosen here. Choose this option if you do not have a DHCP server in your network, or if you wish to assign a static IP address to the DAP-2610. When Dynamic IP (DHCP) is selected, the other fields here will be grayed out. Please allow about 2 minutes for the DHCP client to be functional once this selection is made.

D-Link DAP-2610

Captive Portal Authentication

Session Timeout (1-1440): 60 Minute(s)

Band: 2.4GHz

SSID Index: Primary SSID

Authentication Type: Remote RADIUS

Web Redirection Interface Settings

Web Redirection State: Disable

URL Path: http://

IP Interface Settings

IPIF Status: Disable

VLAN Group:

Get IP From: Static IP(Manual)

IP Address:

Subnet Mask:

Gateway:

DNS:

Remote RADIUS Settings

Radius Server Settings

Radius Server: Radius Port: 1812

Radius Secret:

Remote RADIUS Type: SPAP

Secondary radius Server Settings

Radius Server: Radius Port: 1812

Radius Secret:

Remote RADIUS Type: SPAP

Third radius Server Settings

Radius Server: Radius Port: 1812

Radius Secret:

Remote RADIUS Type: SPAP

Save

Band	SSID Index	Captive Profile	Edit	Delete

IP Address : Assign a static IP address that is within the IP address range of your network.

Subnet Mask : Enter the subnet mask. All devices in the network must share the same subnet mask.

Gateway : Enter the IP address of the gateway/router in your network.

DNS : Enter a DNS server IP address. This is usually the local IP address of your gateway/router.

Radius Server: Enter the RADIUS server's IP address here

Radius Port: Enter the RADIUS server's port number here

Radius Port: Enter the RADIUS server's shared secret here

Remote Radius Type: Select the remote RADIUS server type here. Currently, only SPAP will be used.

Authentication Settings- LDAP

The Captive Portal is a built-in web authentication server. When a station connects to an AP, the web browser will be redirected to a web authentication page. In this window, user can view and configure the Captive Portal settings. After selecting LDAP as the Authentication Type, we can configure the LDAP authentication that will be applied to each wireless client in this network.

Session timeout(1-1440) : Enter the session timeout value here. This value can be from 1 to 1440 minutes. By default, this value is 60 minutes.

Band : Select 2.4GHz or 5GHz.

SSID Index : Select the SSID for this Authentication.

Authentication Type : Select the captive portal encryption type here. Options to choose from are Web Redirection, Username/Password, Passcode, Remote RADIUS, LDAP and POP3. In this section we'll discuss the LDAP option.

Web Redirection State : Default is Disable or select Enable to enable the website redirection feature.

URL Path : Select whether to use either HTTP or HTTPS here. After selecting either http:// or https://, enter the URL of the website that will be used in the space provided.

IPIF Status : Select to Enable or Disable the Captive Portal with its IP interface feature here.

VLAN Group : Enter the VLAN Group ID here

Get IP From : Static IP (Manual) is chosen here. Choose this option if you do not have a DHCP server in your network, or if you wish to assign a static IP address to the DAP-2610. When Dynamic IP (DHCP) is selected, the other fields here will be grayed out. Please allow about 2 minutes for the DHCP client to be functional once this selection is made.

IP Address : Assign a static IP address that is within the IP address range of your network.

The screenshot shows the D-Link DAP-2610 web interface. The left sidebar contains a navigation tree with categories like Basic Settings, Advanced Settings, and Captive Portal. The main content area is titled 'Captive Portal Authentication' and contains the following settings:

- Session Timeout (1-1440): 60 Minute(s)
- Band: 2.4GHz
- SSID Index: Primary SSID
- Authentication Type: LDAP
- Web Redirection Interface Settings:
 - Web Redirection State: Disable
 - URL Path: http://
- IP Interface Settings:
 - IPIF Status: Disable
 - VLAN Group: (empty)
 - Get IP From: Static IP(Manual)
 - IP Address: (empty)
 - Subnet Mask: (empty)
 - Gateway: (empty)
 - DNS: (empty)
- LDAP Settings:
 - Server: (empty)
 - Port: 389
 - Authenticate Mode: Simple
 - Username: (empty)
 - Password: (empty)
 - Base DN: (empty) (ou=,dc=)
 - Account Attribute: (empty) (ex.cn)
 - Identity: (empty) Auto Copy

At the bottom right, there is a 'Save' button. Below the settings is a table with columns: Band, SSID Index, Captive Profile, Edit, and Delete. The table is currently empty.

Subnet Mask : Enter the subnet mask. All devices in the network must share the same subnet mask.

Gateway : Enter the IP address of the gateway/router in your network.

DNS : Enter a DNS server IP address. This is usually the local IP address of your gateway/router.

Server: Enter the LDAP server's IP address or domain name here.

Port: Enter the LDAP server's port number here.

Authenticate Mode: Select the authentication mode here. Options to choose from are Simple and TLS.

Username: Enter the LDAP server account's username here.

Password: Enter the LDAP server account's password here.

Base DN: Enter the administrator's domain name here

Account Attribute: Enter the LDAP account attribute string here.
This string will be used to search for clients.

Identity: Enter the identity's full path string here. Alternatively, select the Auto Copy checkbox to automatically add the generic full path of the web page in the identity field.

Authentication Settings- POP3

The Captive Portal is a built-in web authentication server. When a station connects to an AP, the web browser will be redirected to a web authentication page. In this window, user can view and configure the Captive Portal settings. After selecting POP3 as the Authentication Type, we can configure the POP3 authentication that will be applied to each wireless client in this network.

Session timeout(1-1440) : Enter the session timeout value here. This value can be from 1 to 1440 minutes. By default, this value is 60 minutes.

Band : Select 2.4GHz or 5GHz.

SSID Index : Select the SSID for this Authentication.

Authentication Type : Select the captive portal encryption type here. Options to choose from are Web Redirection, Username/Password, Passcode, Remote RADIUS, LDAP and POP3. In this section we'll discuss the POP3 option.

Web Redirection State : Default is Disable or select Enable to enable the website redirection feature.

URL Path : Select whether to use either HTTP or HTTPS here. After selecting either http:// or https://, enter the URL of the website that will be used in the space provided.

IPIF Status : Select to Enable or Disable the Captive Portal with its IP interface feature here.

VLAN Group : Enter the VLAN Group ID here

Get IP From : Static IP (Manual) is chosen here. Choose this option if you do not have a DHCP server in your network, or if you wish to assign a static IP address to the DAP-2610. When Dynamic IP

Captive Portal Authentication

Session Timeout (1-1440) Minute(s)

Band

SSID Index

Authentication Type

Web Redirection Interface Settings

Web Redirection State

URL Path

IP Interface Settings

IPIF Status

VLAN Group

Get IP From

IP Address

Subnet Mask

Gateway

DNS

POP3 Settings

Server

Port

Connection Type

Band	SSID Index	Captive Profile	Edit	Delete

(DHCP) is selected, the other fields here will be grayed out. Please allow about 2 minutes for the DHCP client to be functional once this selection is made.

IP Address: Assign a static IP address that is within the IP address range of your network.

Subnet Mask: Enter the subnet mask. All devices in the network must share the same subnet mask.

Gateway: Enter the IP address of the gateway/router in your network.

DNS: Enter a DNS server IP address. This is usually the local IP address of your gateway/router.

Server: Enter the POP3 server's IP address or domain name here.

Port: Enter the POP server's port number here.

Connection Type: Select the connection type here. Options to choose from are None and SSL/TLS.

Login Page Upload

In this window, users can upload a custom login web page that will be used by the captive portal feature. Click the **Browse** button to navigate to the login style, located on the managing computer and then click the **Upload** button to initiate the upload.

Upload Login Style From Local Hard Drive: In this field the path to the login style file, that will be uploaded, will be displayed. Alternatively, the path can be manually entered here.

Login Page Style List : Select the wireless band and login style that will be used in each SSID here. Click Download button to download the template file for login page and Click Del button to delete the template file.

The screenshot shows the D-Link DAP-2610 web interface. The main content area is titled "Login Page Upload". It features a section for "Upload Login Style From Local Hard Drive" with a text input field for the file path, a "浏览..." (Browse) button, and an "Upload" button. Below this, it shows "The Left space" as 457216 Byte(s). There is also a "Login Page Style List" section with a "Wireless Band" dropdown menu set to "2.4GHz".

ID	Style Name	Pri	S-1	S-2	S-3	S-4	S-5	S-6	S-7	Download	Del
1	pages_default.tar	<input checked="" type="radio"/>	<input type="radio"/>	<input type="radio"/>	<input type="radio"/>	<input type="radio"/>	<input type="radio"/>	<input type="radio"/>	<input type="radio"/>		
2	pages_headerpic.tar	<input type="radio"/>	<input type="radio"/>	<input type="radio"/>	<input type="radio"/>	<input type="radio"/>	<input type="radio"/>	<input type="radio"/>	<input type="radio"/>		
3	pages_license.tar	<input type="radio"/>	<input type="radio"/>	<input type="radio"/>	<input type="radio"/>	<input type="radio"/>	<input type="radio"/>	<input type="radio"/>	<input type="radio"/>		

A "Save" button is located at the bottom right of the configuration area.

IP Filter Settings

Enter the IP address or network address that will be used in the IP filter rule. For example, an IP address like 192.168.70.66 or a network address like 192.168.70.0. This IP address or network will be inaccessible to wireless clients in this network.

Wireless Band : Wireless Band : Select 2.4GHz or 5GHz.

IP Address: IP Address: Enter the IP address or network address

Subnet Mask: Subnet Mask: Enter the subnet mask of the IP address or networks address

Upload IP Filter File: Upload IP Filter File: To upload a IP filter list file, click Browse and navigate to the IP filter list file saved on the computer, and then click Upload.

Download IP Filter File: Download IP Filter File: To download IP Filter list file, click Download and to save the IP Filter list.

The screenshot shows the D-Link DAP-2610 web interface. The top navigation bar includes Home, Maintenance, Configuration, System, Logout, and Help. The left sidebar shows a tree view of configuration options, with IP Filter Settings selected. The main content area is titled 'IP Filter Settings' and contains the following elements:

- Wireless Band:** A dropdown menu set to '2.4GHz'.
- SSID Index:** A dropdown menu set to 'Primary SSID'.
- IP Address:** An empty text input field.
- Subnet Mask:** An empty text input field.
- Add:** A button to add a new filter rule.
- Table:** A table with the following structure:

ID	IP Address	Subnet Mask	Delete
- Upload IP Filter File:** A section with an 'Upload File' label, a file selection input, a '浏览...' (Browse) button, and an 'Upload' button.
- Download IP Filter File:** A section with a 'Download IP Filter File' label, a 'Load IP Filter File to Local Hard Driver' label, and a 'Download' button.
- Save:** A button at the bottom right of the page.

MAC Bypass

The DAP-2610 features a wireless MAC Bypass. Once a user is finished with these settings, click the Save button to let the changes take effect.

Wireless Band: Select the wireless band for MAC Bypass.

SSID Index: Select the SSID for MAC Bypass.

MAC Address: Enter each MAC address that you wish to include in your bypass list, and click Add.

MAC Address List: When a MAC address is entered, it appears in this list.
Highlight a MAC address and click the Delete icon to remove it from this list.

Upload File: To upload a MAC bypass list file, click Browse and navigate to the MAC bypass list file saved on the computer, and then click Upload.

Load MAC File to Local Hard Driver: To download MAC bypass list file, click Download and to save the MAC bypass list.

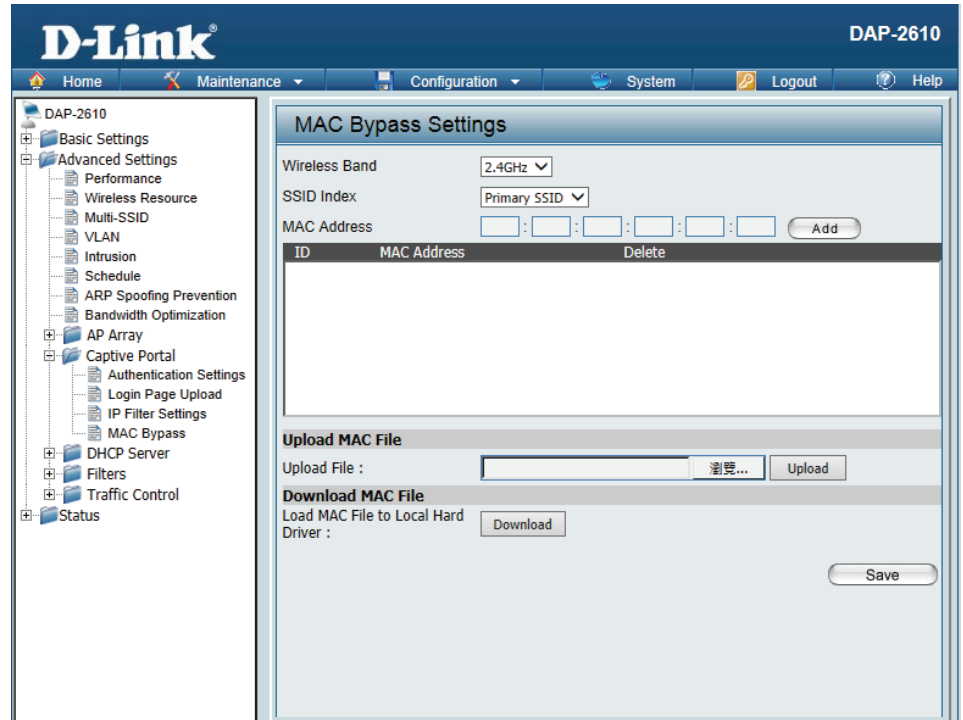

DHCP Server

Dynamic Pool Settings

The DHCP address pool defines the range of the IP address that can be assigned to stations in the network. A Dynamic Pool allows wireless stations to receive an available IP with lease time control. If needed or required in the network, the DAP-2610 is capable of acting as a DHCP server.

Function Enable/Disable: Dynamic Host Configuration Protocol (DHCP) assigns dynamic IP addresses to devices on the network. This protocol simplifies network management and allows new wireless devices to receive IP addresses automatically without the need to manually assign new IP addresses. Select Enable to allow the DAP-2610 to function as a DHCP server.

IP Assigned From: Input the first IP address available for assignment on your network.

The Range of Pool (1-254): Enter the number of IP addresses available for assignment. IP addresses are increments of the IP address specified in the "IP Assigned From" field.

Subnet Mask: All devices in the network must have the same subnet mask to communicate. Enter the subnet mask for the network here.

Gateway: Enter the IP address of the gateway on the network.

WINS: Specify the Windows Internet Naming Service (WINS) server address for the wireless network. WINS is a system that determines the IP address of a network computer that has a dynamically assigned IP address.

DNS: Enter the IP address of the Domain Name System (DNS) server. The DNS server translates domain names such as www.dlink.com into IP addresses.

Domain Name: Enter the domain name of the network, if applicable. (An example of a domain name is: www.dlink.com.)

Lease Time: The lease time is the period of time before the DHCP server will assign new IP addresses.

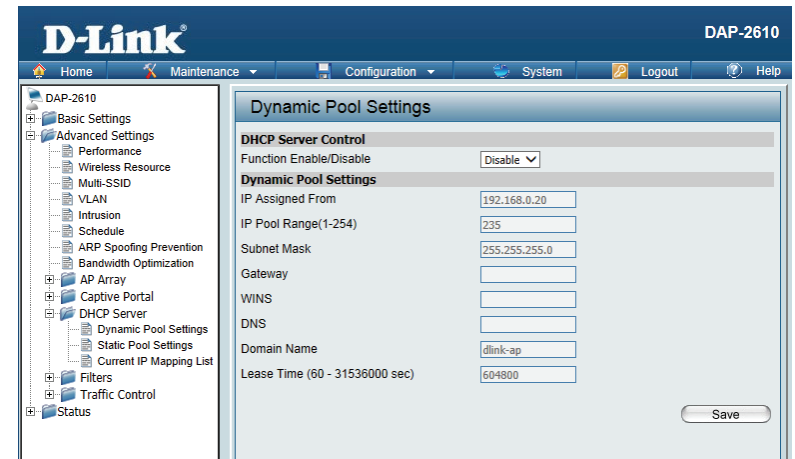

Static Pool Setting

The DHCP address pool defines the range of IP addresses that can be assigned to stations on the network. A static pool allows specific wireless stations to receive a fixed IP without time control.

Function Enable/Disable: Dynamic Host Configuration Protocol (DHCP) assigns IP addresses to wireless devices on the network. This protocol simplifies network management and allows new wireless devices to receive IP addresses automatically without the need to manually assign IP addresses. Select Enable to allow the DAP-2610 to function as a DHCP server.

Assigned IP: Use the Static Pool Settings to assign the same IP address to a device every time you start up. The IP addresses assigned in the Static Pool list must NOT be in the same IP range as the Dynamic Pool. After you have assigned a static IP address to a device via its MAC address, click Apply; the device will appear in the Assigned Static Pool at the bottom of the screen. You can edit or delete the device in this list.

Assigned MAC Address: Enter the MAC address of the device requesting association here.

Subnet Mask: Define the subnet mask of the IP address specified in the "IP Assigned From" field.

Gateway: Specify the Gateway address for the wireless network.

WINS: Specify the Windows Internet Naming Service (WINS) server address for the wireless network. WINS is a system that determines the IP address of a network computer with a dynamically assigned IP address, if applicable.

DNS: Enter the DNS server address for your wireless network.

Domain Name: Specify the domain name for the network.

DHCP Server Control				
Function Enable/Disable	Enable			
Static Pool Setting				
Host Name	<input type="text"/>			
Assigned IP	<input type="text"/>			
Assigned MAC Address	<input type="text"/> : <input type="text"/> : <input type="text"/> : <input type="text"/> : <input type="text"/> : <input type="text"/>			
Subnet Mask	255.255.255.0			
Gateway	<input type="text"/>			
WINS	<input type="text"/>			
DNS	<input type="text"/>			
Domain Name	dlink-ap			
<input type="button" value="Save"/>				
Host Name	MAC Address	IP Address	Edit	Delete

Current IP Mapping List

This window displays information about the current assigned DHCP dynamic and static IP address pools. This information is available when you enable DHCP server on the AP and assign dynamic and static IP address pools.

Current DHCP Dynamic Profile: These are IP address pools the DHCP server has assigned using the dynamic pool setting.

Binding MAC Address: The MAC address of a device on the network that is assigned an IP address from the DHCP dynamic pool.

Assigned IP Address: The current corresponding DHCP-assigned IP address of the device.

Lease Time: The length of time that the dynamic IP address will be valid.

Current DHCP Static Pools: These are the IP address pools of the DHCP server assigned through the static pool settings.

Binding MAC Address: The MAC address of a device on the network that is within the DHCP static IP address pool.

Assigned IP Address: The current corresponding DHCP-assigned static IP address of the device.

Binding MAC Address: The MAC address of a device on the network that is assigned an IP address from the DHCP dynamic pool.

Assigned IP Address: The current corresponding DHCP-assigned static IP address of the device.

Current IP Mapping List			
Current DHCP Dynamic Pools			
Host Name	Binding MAC Address	Assigned IP Address	Lease Time
Current DHCP Static Pools			
Host Name	Binding MAC Address	Assigned IP Address	

Filters

Wireless MAC ACL

This page allows the user to configure Wireless MAC ACL settings for access control.

Wireless Band: Displays the current wireless band rate.

Access Control List: Select **Disable** to disable the filters function.

Select **Accept** to accept only those devices with MAC addresses in the Access Control List. All other devices not on the list will be rejected.

Select **Reject** to reject the devices with MAC addresses on the Access Control List. All other devices not on the list will be accepted.

MAC Address: Enter each MAC address that you wish to include in your filter list, and click Apply.

MAC Address List: When you enter a MAC address, it appears in this list. Highlight a MAC address and click Delete to remove it from this list.

Current Client Information: This table displays information about all the current connected stations.

The screenshot displays the D-Link DAP-2610 configuration interface for Wireless MAC ACL Settings. The page includes a navigation menu on the left with categories like Basic Settings, Advanced Settings, Performance, Wireless Resource, Multi-SSID, VLAN, Intrusion, Schedule, ARP Spoofing Prevention, Bandwidth Optimization, AP Array, Captive Portal, DHCP Server, Filters, Wireless MAC ACL, WLAN Partition, Traffic Control, and Status. The main content area is titled 'Wireless MAC ACL Settings' and contains the following elements:

- Wireless Band:** A dropdown menu set to '2.4GHz'.
- Access Control List:** A dropdown menu set to 'Disable'.
- MAC Address:** A text input field with a placeholder ' : : : : : ' and an 'Add' button.
- MAC Address List:** A table with columns 'ID', 'MAC Address', and 'Delete'. The table is currently empty.
- Current Client Information:** A table with columns 'MAC Address', 'SSID', 'Band', 'Authentication', 'Signal', and 'Add'. The table is currently empty.
- Upload ACL File:** A section with an 'Upload File' label, a text input field, a '浏览...' (Browse) button, and an 'Upload' button.
- Download ACL File:** A section with a 'Download ACL File' label, a 'Load ACL File to Local Hard Driver' label, and a 'Download' button.
- Save:** A 'Save' button at the bottom right of the page.

WLAN Partition

This page allows the user to configure a WLAN Partition.

Wireless Band: Displays the current wireless band.

Link Integrity: Select **Enable** or **Disable**. If the Ethernet connection between the LAN and the AP is disconnected, enabling this feature will cause the wireless segment associated with the AP to be disassociated from the AP.

Ethernet WLAN Access: The default is Enable. When disabled, all data from the Ethernet to associated wireless devices will be blocked. Wireless devices can still send data to the Ethernet.

Internal Station Connection: The default value is Enable, which allows stations to intercommunicate by connecting to a target AP. When disabled, wireless stations cannot exchange data on the same Multi-SSID. In Guest mode, wireless stations cannot exchange data with any station on your network.

WLAN Partition		
Wireless Band	2.4GHz ▼	
Link Integrity	Disable ▼	
Ethernet to WLAN Access	Enable ▼	
Internal Station Connection		
Primary SSID	<input checked="" type="radio"/> Enable	<input type="radio"/> Disable <input type="radio"/> Guest mode
Multi-SSID 1	<input checked="" type="radio"/> Enable	<input type="radio"/> Disable <input type="radio"/> Guest mode
Multi-SSID 2	<input checked="" type="radio"/> Enable	<input type="radio"/> Disable <input type="radio"/> Guest mode
Multi-SSID 3	<input checked="" type="radio"/> Enable	<input type="radio"/> Disable <input type="radio"/> Guest mode
Multi-SSID 4	<input checked="" type="radio"/> Enable	<input type="radio"/> Disable <input type="radio"/> Guest mode
Multi-SSID 5	<input checked="" type="radio"/> Enable	<input type="radio"/> Disable <input type="radio"/> Guest mode
Multi-SSID 6	<input checked="" type="radio"/> Enable	<input type="radio"/> Disable <input type="radio"/> Guest mode
Multi-SSID 7	<input checked="" type="radio"/> Enable	<input type="radio"/> Disable <input type="radio"/> Guest mode
Save		

Traffic Control

Uplink/Downlink Setting

The uplink/downlink setting allows users to customize the downlink and uplink interfaces including specifying downlink/uplink bandwidth rates in Mbits per second. These values are also used in the QoS and Traffic Manager windows. Once the desired uplink and downlink settings are finished, click the **Save** button to let your changes take effect.

Downlink Bandwidth: The downlink bandwidth in Mbits per second.

Uplink Bandwidth: Uplink Bandwidth: The uplink bandwidth in Mbits per second.

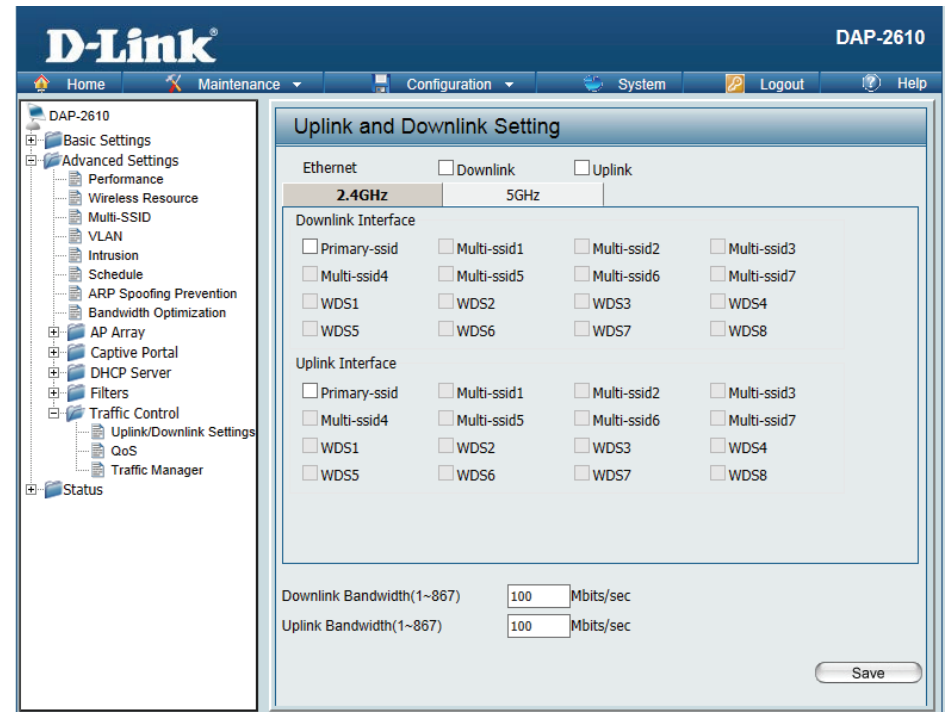

QoS

Quality of Service (QoS) enhances the experience of using a network by prioritizing the traffic of different applications. The DAP-2610 supports four priority levels. Once the desired QoS settings are finished, click the **Save** button to let your changes take effect.

Enable QoS: Check this box to allow QoS to prioritize traffic. Use the drop-down menus to select the four levels of priority. Click the Save button when you are finished.

Downlink Bandwidth: Downlink Bandwidth: The downlink bandwidth in Mbits per second. This value is entered in the Uplink/Downlink Setting window.

Uplink Bandwidth: Uplink Bandwidth: The uplink bandwidth in Mbits per second. This value is entered in the Uplink/Downlink Setting window.

QoS

Enable QoS

Advanced QoS

Downlink Bandwidth	100	Mbits/sec
Uplink Bandwidth	100	Mbits/sec
ACK/DHCP/ICMP/DNS Priority	Highest Priority	Limit: 100 % Port: 53,67,68,546,547
Web Traffic Priority	Third Priority	Limit: 100 % Port: 80,443,3128,8080
Mail Traffic Priority	Second Priority	Limit: 100 % Port: 25,110,465,995
Ftp Traffic Priority	Low Priority	Limit: 100 % Port: 20,21
User Defined-1 Priority	Highest Priority	Limit: 100 % Port: 0 - 0
User Defined-2 Priority	Second Priority	Limit: 100 % Port: 0 - 0
User Defined-3 Priority	Third Priority	Limit: 100 % Port: 0 - 0
User Defined-4 Priority	Low Priority	Limit: 100 % Port: 0 - 0
Other Traffic Priority	Low Priority	Limit: 100 %

Save

Traffic Manager

The traffic manager feature allows users to create traffic management rules that specify how to deal with listed client traffic and specify downlink/ uplink speed for new traffic manager rules. Click the **Save** button to let your changes take effect.

Traffic Manager: Use the drop-down menu to **Enable** the traffic manager feature.

Unlisted Client Traffic: Select **Deny** or **Forward** to determine how to deal with unlisted client traffic.

Downlink Bandwidth: The downlink bandwidth in Mbits per second. This value is entered in the Uplink/Downlink Setting window.

Uplink Bandwidth: Uplink Bandwidth: The uplink bandwidth in Mbits per second. This value is entered in the Uplink/Downlink Setting window.

Traffic Manager

Traffic Manager Disable ▾

Unlisted Clients Traffic Deny Forward

Downlink Bandwidth Mbits/sec

Uplink Bandwidth Mbits/sec

Add Traffic Manager Rule

Name

Client IP(optional)

Client MAC(optional)

Downlink Speed Mbits/sec

Uplink Speed Mbits/sec

Traffic Manager Rules

Name	Client IP	Client MAC	Downlink Speed	Uplink Speed	Edit	Del

Status

In the Status Section the user can monitor and view configuration settings of the access point. Here the user can also view statistics about client information, WDS information and more. The following pages will explain settings found in the Status section in more detail.

The screenshot shows the D-Link DAP-2610 web interface. The top navigation bar includes Home, Maintenance, Configuration, System, Logout, and Help. The left sidebar shows the navigation menu with the following items: DAP-2610, Basic Settings, Advanced Settings, Status, Device Information, Client Information, WDS Information, Channel Analyze, Statistics, and Log. The main content area displays the following information:

Device Information	
Firmware Version:1.00	
Ethernet MAC Address:	00:15:e9:2c:75:00
Wireless MAC Address(2.4GHz):	Primary: 00:15:e9:2c:75:00 SSID 1~7: 00:15:e9:2c:75:01 ~ 00:15:e9:2c:75:07
Wireless MAC Address(5GHz):	Primary: 00:15:e9:2c:75:08 SSID 1~7: 00:15:e9:2c:75:09 ~ 00:15:e9:2c:75:0f
Ethernet	
IP Address	192.168.0.50
Subnet Mask	255.255.255.0
Gateway	N/A
DNS	
Wireless (2.4GHz)	
Network Name (SSID)	dlink
Channel	11
Data Rate	Auto
Security	None
Wireless (5GHz)	
Network Name (SSID)	dlink
Channel	153
Data Rate	Auto
Security	None
AP Array	
AP Array	d-link
Role	Slave
Location	
Device Status	
CPU Utilization	0%
Memory Utilization	38%

Device Information

This page displays the current information like firmware version, Ethernet and wireless parameters, as well as the information regarding CPU and memory utilization.

Device Information: This read-only window displays the configuration settings of the DAP-2610, including the firmware version and the device's MAC address.

The screenshot shows the D-Link DAP-2610 web interface. The top navigation bar includes Home, Maintenance, Configuration, System, Logout, and Help. The left sidebar menu shows the following options: DAP-2610, Basic Settings, Advanced Settings, Status, Device Information (selected), Client Information, WDS Information, Channel Analyze, Statistics, and Log.

The main content area displays the following information:

Device Information	
Firmware Version:1.00	
Ethernet MAC Address:	00:15:e9:2c:75:00
Wireless MAC Address(2.4GHz):	Primary: 00:15:e9:2c:75:00 SSID 1~7: 00:15:e9:2c:75:01 ~ 00:15:e9:2c:75:07
Wireless MAC Address(5GHz):	Primary: 00:15:e9:2c:75:08 SSID 1~7: 00:15:e9:2c:75:09 ~ 00:15:e9:2c:75:0f
Ethernet	
IP Address	192.168.0.50
Subnet Mask	255.255.255.0
Gateway	N/A
DNS	
Wireless (2.4GHz)	
Network Name (SSID)	dlink
Channel	11
Data Rate	Auto
Security	None
Wireless (5GHz)	
Network Name (SSID)	dlink
Channel	153
Data Rate	Auto
Security	None
AP Array	
AP Array	d-link
Role	Slave
Location	
Device Status	
CPU Utilization	0%
Memory Utilization	38%
Central WiFiManager	
Connection Status	Disconnect
Server IP	
Service Port	
Live Port	
Group ID	

Client Information

This page displays the associated clients SSID, MAC, band, authentication method, signal strength, and power saving mode for the DAP-2610 network.

Client Information: This window displays the wireless client information for clients currently connected to the DAP-2610.

SSID: Displays the SSID of the client.

MAC: Displays the MAC address of the client.

Band: Displays the wireless band that the client is connected to.

Authentication: Displays the type of authentication being used.

RSSI: Displays the client's signal strength.

Power Saving Mode: Displays the status of the power saving feature.

Client Information						
Client Information		Station association (2.4GHz) : 2				
SSID	MAC	Band	Authentication	RSSI	Power Saving Mode	
Primary SSID	F8:A4:5F:72:C7:5C	N	OPEN	11%	On	
Primary SSID	04:FE:31:D5:08:06	N	OPEN	67%	Off	
Client Information		Station association(5GHz) : 0				
SSID	MAC	Band	Authentication	RSSI	Power Saving Mode	

WDS Information Page

This page displays the access points SSID, MAC, band, authentication method, signal strength, and status for the DAP-2610's Wireless Distribution System network.

WDS Information: This window displays the Wireless Distribution System information for clients currently connected to the DAP-2610.

Name: Displays the SSID of the client.

MAC: Displays the MAC address of the client.

Authentication: Displays the type of authentication being used.

Signal: Displays the client's signal strength.

Status: Displays the status of the power saving feature.



The screenshot shows a window titled "WDS Information" containing two tables. The first table is for Channel 1 (2.412 GHz) and the second is for Channel 36 (5.18 GHz). Both tables have columns for Name, MAC, Authentication, Signal, and Status.

WDS Information				
Channel : 1 (2.412 GHz)				
Name	MAC	Authentication	Signal	Status

WDS Information				
Channel : 36 (5.18 GHz)				
Name	MAC	Authentication	Signal	Status

Channel Analyze

Wireless Band: Select either 2.4Ghz or 5GHz.

Detect: Click the Detect button to scan.

AP List: This will list the transmitting channels and quality.

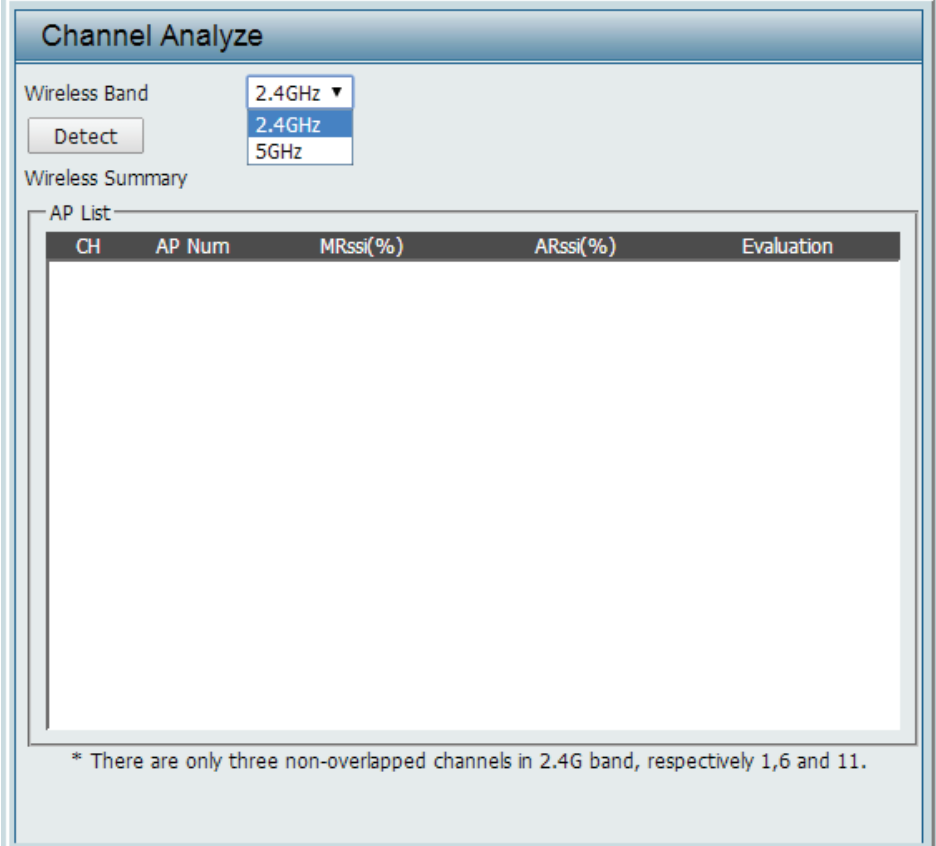

Channel Analyze

Wireless Band: 2.4GHz ▾
2.4GHz
5GHz

Detect

Wireless Summary

AP List

CH	AP Num	MRssi(%)	ARssi(%)	Evaluation
----	--------	----------	----------	------------

* There are only three non-overlapped channels in 2.4G band, respectively 1,6 and 11.

Stats Page

Ethernet Traffic Statistics

Displays wired interface network traffic information.

Ethernet Traffic Statistics: This page displays transmitted and received count statistics for packets and bytes.

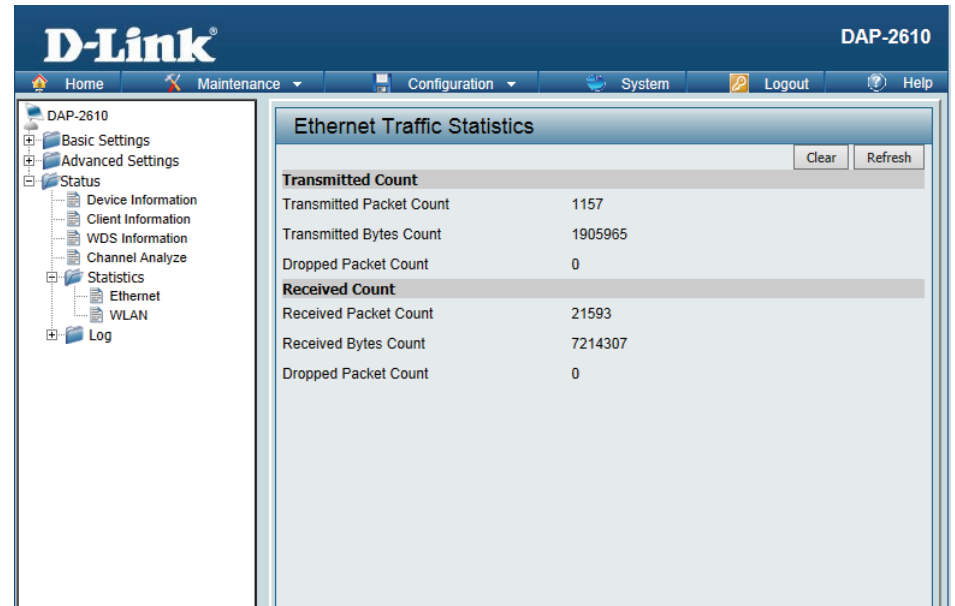

WLAN Traffic Statistics

Displays throughput, transmitted frame, received frame, and WEP frame error information for the AP network.

WLAN Traffic Statistics: This page displays wireless network statistics for data throughput, transmitted and received frames, and frame errors.

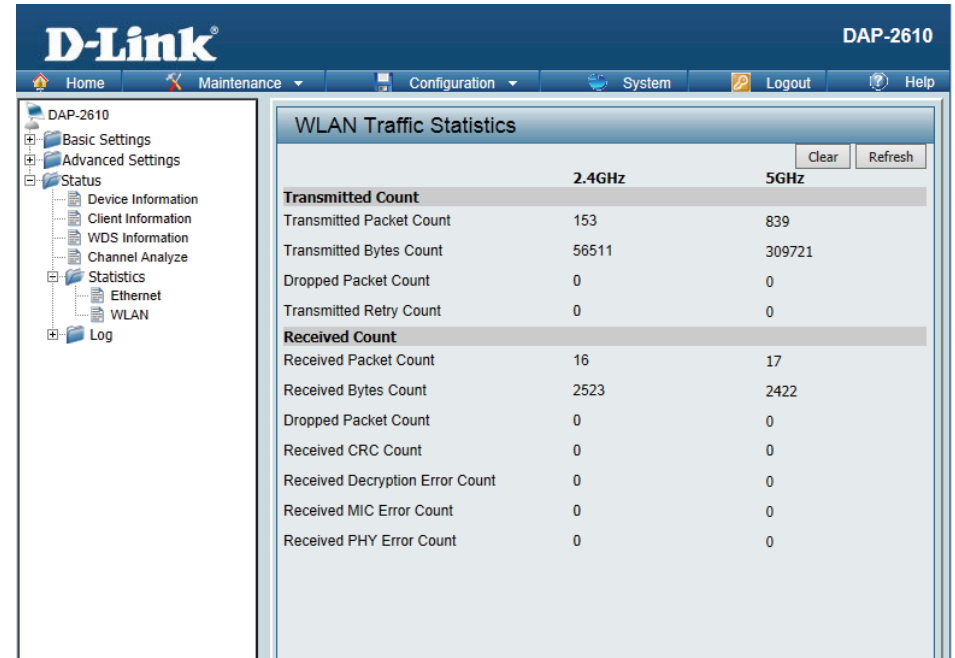

The screenshot shows the D-Link DAP-2610 web interface. The top navigation bar includes Home, Maintenance, Configuration, System, Logout, and Help. The left sidebar menu shows the following structure:

- DAP-2610
 - Basic Settings
 - Advanced Settings
 - Status
 - Device Information
 - Client Information
 - WDS Information
 - Channel Analyze
 - Statistics
 - Ethernet
 - WLAN
 - Log

The main content area displays the **WLAN Traffic Statistics** page. It features a table with columns for 2.4GHz and 5GHz, and buttons for Clear and Refresh. The table is divided into Transmitted Count and Received Count sections.

	2.4GHz	5GHz
Transmitted Count		
Transmitted Packet Count	153	839
Transmitted Bytes Count	56511	309721
Dropped Packet Count	0	0
Transmitted Retry Count	0	0
Received Count		
Received Packet Count	16	17
Received Bytes Count	2523	2422
Dropped Packet Count	0	0
Received CRC Count	0	0
Received Decryption Error Count	0	0
Received MIC Error Count	0	0
Received PHY Error Count	0	0

Log

View Log

The AP's embedded memory holds logs here. The log information includes but is not limited to the following items: cold start AP, upgrading firmware, client associate and disassociate with AP, and web login. The web page holds up to 500 logs.

View Log: The AP's embedded memory displays system and network messages including a time stamp and message type. The log information includes but is not limited to the following items: cold start AP, upgrading firmware, client associate and disassociate with AP, and web login. The web page holds up to 500 logs.

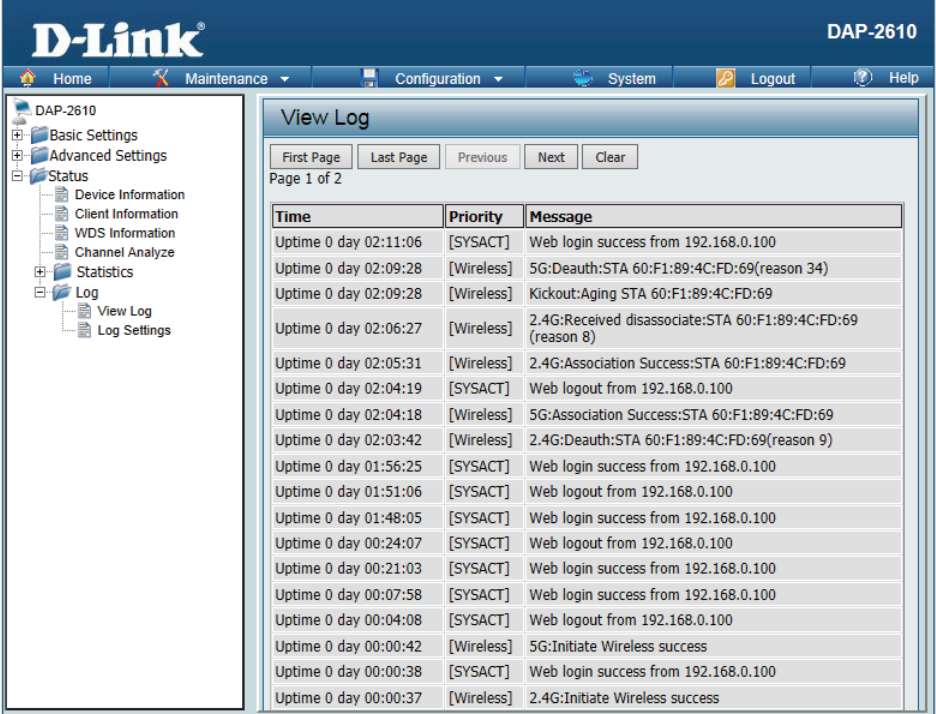

The screenshot shows the D-Link DAP-2610 web interface. The top navigation bar includes Home, Maintenance, Configuration, System, Logout, and Help. The left sidebar menu shows the following structure:

- DAP-2610
 - Basic Settings
 - Advanced Settings
 - Status
 - Device Information
 - Client Information
 - WDS Information
 - Channel Analyze
 - Statistics
 - Log
 - View Log
 - Log Settings

The main content area is titled "View Log" and shows a table of log entries. The table has three columns: Time, Priority, and Message. The entries are as follows:

Time	Priority	Message
Uptime 0 day 02:11:06	[SYSACT]	Web login success from 192.168.0.100
Uptime 0 day 02:09:28	[Wireless]	5G:Deauth:STA 60:F1:89:4C:FD:69(reason 34)
Uptime 0 day 02:09:28	[Wireless]	Kickout:Aging STA 60:F1:89:4C:FD:69
Uptime 0 day 02:06:27	[Wireless]	2.4G:Received disassociate:STA 60:F1:89:4C:FD:69 (reason 8)
Uptime 0 day 02:05:31	[Wireless]	2.4G:Association Success:STA 60:F1:89:4C:FD:69
Uptime 0 day 02:04:19	[SYSACT]	Web logout from 192.168.0.100
Uptime 0 day 02:04:18	[Wireless]	5G:Association Success:STA 60:F1:89:4C:FD:69
Uptime 0 day 02:03:42	[Wireless]	2.4G:Deauth:STA 60:F1:89:4C:FD:69(reason 9)
Uptime 0 day 01:56:25	[SYSACT]	Web login success from 192.168.0.100
Uptime 0 day 01:51:06	[SYSACT]	Web logout from 192.168.0.100
Uptime 0 day 01:48:05	[SYSACT]	Web login success from 192.168.0.100
Uptime 0 day 00:24:07	[SYSACT]	Web logout from 192.168.0.100
Uptime 0 day 00:21:03	[SYSACT]	Web login success from 192.168.0.100
Uptime 0 day 00:07:58	[SYSACT]	Web login success from 192.168.0.100
Uptime 0 day 00:04:08	[SYSACT]	Web logout from 192.168.0.100
Uptime 0 day 00:00:42	[Wireless]	5G:Initiate Wireless success
Uptime 0 day 00:00:38	[SYSACT]	Web login success from 192.168.0.100
Uptime 0 day 00:00:37	[Wireless]	2.4G:Initiate Wireless success

Log Settings

Enter the log server's IP address to send the log to that server. Check or uncheck System Activity, Wireless Activity, or Notice to specify what kind of log type you want it to log.

Log Server/IP Address: Enter the IP address of the server you would like to send the DAP-2610 log to.

Log Type: Check the box for the type of activity you want to log. There are three types: System Activity, Wireless Activity, and Notice.

E-mail Notification: Support Simple Mail Transfer Protocol for log schedule and periodical change key. It can not support Gmail SMTP port 465. Please set to Gmail SMTP port 25 or 587.

E-mail Log Schedule: Use the drop-down menu to set the e-mail log schedule.

The screenshot shows the D-Link DAP-2610 web interface. The top navigation bar includes Home, Maintenance, Configuration, System, Logout, and Help. The left sidebar shows a tree view with categories like Basic Settings, Advanced Settings, Status, Device Information, Client Information, WDS Information, Channel Analyze, Statistics, Log, View Log, and Log Settings. The main content area is titled 'Log Settings' and contains the following sections:

- Log Settings**
 - Log Server Settings
 - Log Server / IP Address: [Text Input]
 - Log Type
 - System Activity
 - Wireless Activity
 - Notice
 - EU directive Syslog Server Settings
 - Log Server / IP Address: [Text Input]
- Email Notification**
 - Email Notification: Enable
 - Outgoing mail server (SMTP): [Internal] (Dropdown)
 - Authentication: Enable
 - SSL/TLS: Enable
 - From Email Address: [Text Input]
 - To Email Address: [Text Input]
 - Email Server Address: [Text Input]
 - SMTP Port: [Text Input]
 - User Name: [Text Input]
 - Password: [Text Input]
 - Confirm Password: [Text Input]
- Email Log Schedule**
 - Schedule: [0] (Dropdown) hours or when Log is full

A 'Save' button is located at the bottom right of the configuration area.

Maintenance Section

In the Status Section the user can monitor and view configuration settings of the access point. Here the user can also view statistics about client information, WDS information and more. The following pages will explain settings found in the maintenance section in more detail.

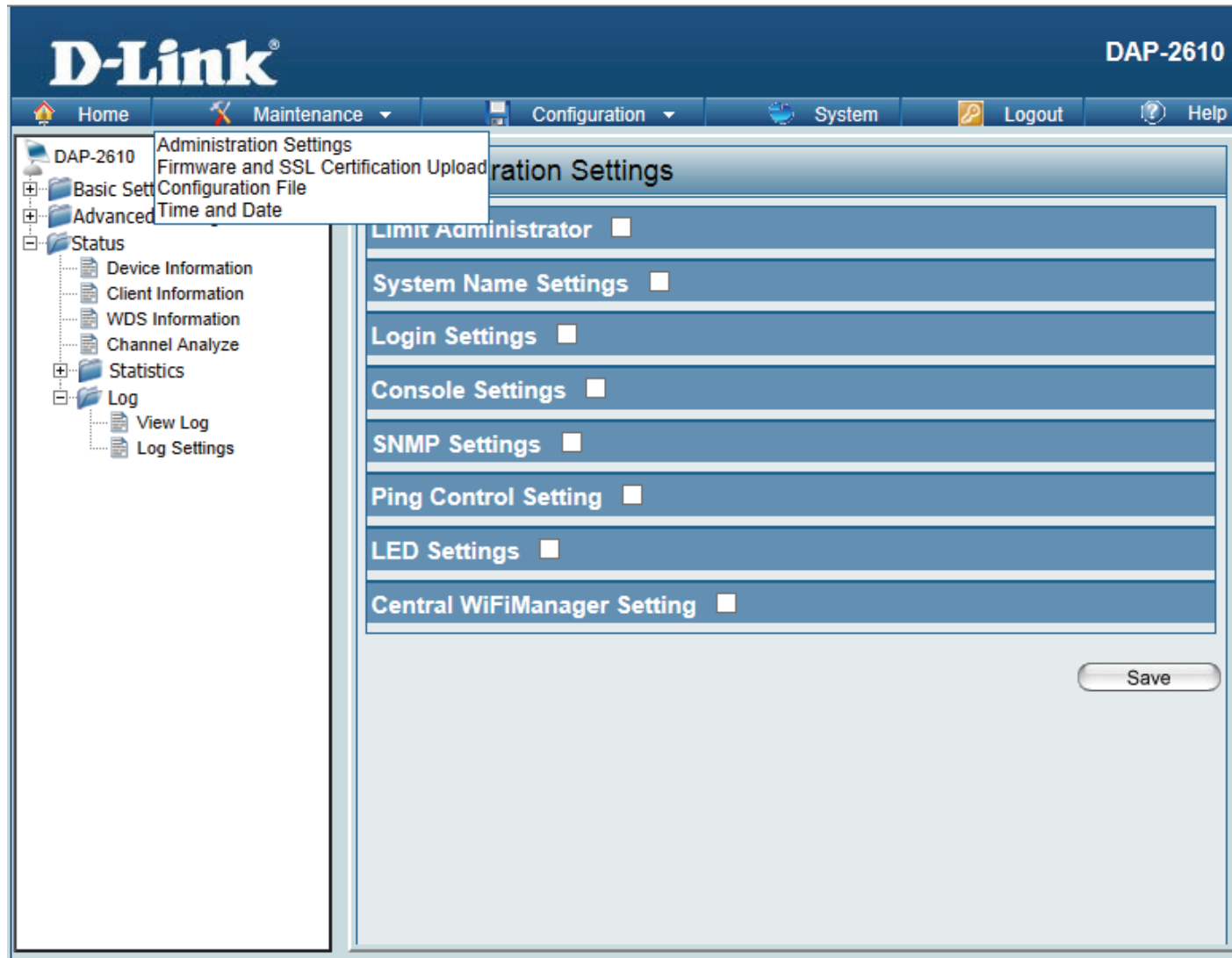

Administration

Limit Administrator

Check one or more of the five main categories to display the various hidden administrator parameters and settings displayed on the next five pages. Each of the five main categories display various hidden administrator parameters and settings.

Limit Administrator VLAN ID: Check the box provided and the ID: enter the specific VLAN ID that the administrator will be allowed to log in from.

Limit Administrator IP: Check to enable the Limit Administrator IP address.

IP Range: Enter the IP address range that the administrator will be allowed to log in from and then click the Add button.

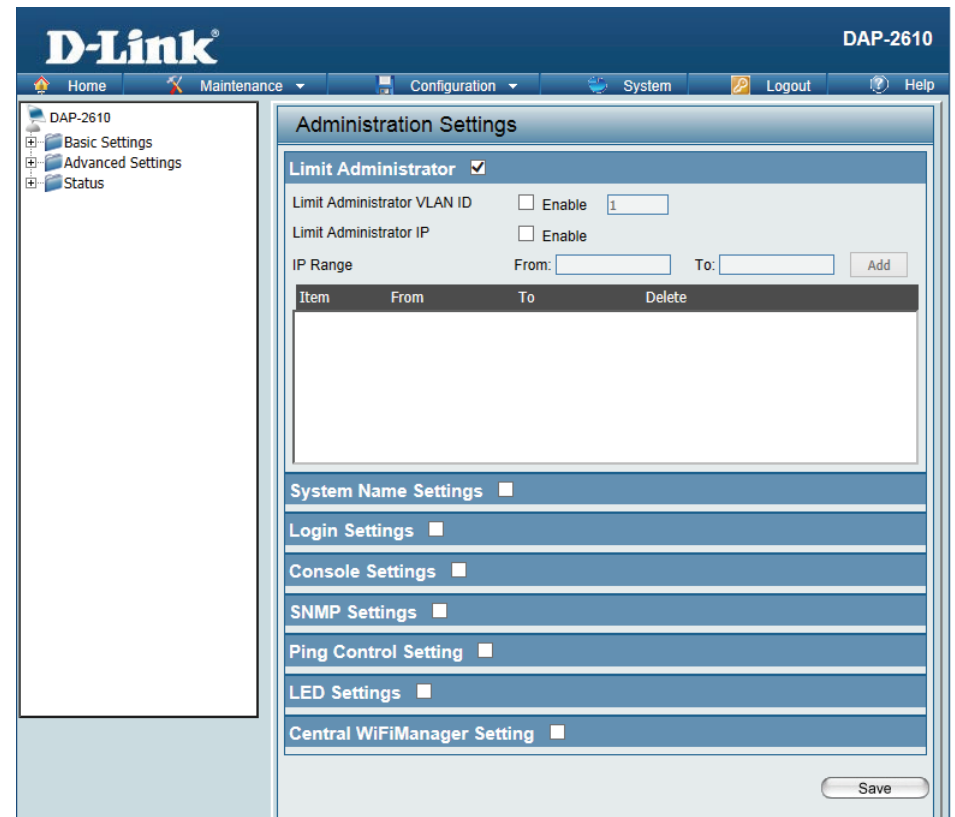

The screenshot shows the D-Link DAP-2610 Administration Settings page. The page is titled "Administration Settings" and includes a navigation menu with options: Home, Maintenance, Configuration, System, Logout, and Help. The main content area is divided into several sections:

- Limit Administrator:** This section is checked. It includes:
 - Limit Administrator VLAN ID:** A checkbox labeled "Enable" and an input field.
 - Limit Administrator IP:** A checkbox labeled "Enable" and an input field.
 - IP Range:** A section with "From:" and "To:" input fields and an "Add" button.
 - Table:** A table with columns "Item", "From", "To", and "Delete". The table is currently empty.
- System Name Settings:** A section with a "Save" button.
- Login Settings:** A section with a "Save" button.
- Console Settings:** A section with a "Save" button.
- SNMP Settings:** A section with a "Save" button.
- Ping Control Setting:** A section with a "Save" button.
- LED Settings:** A section with a "Save" button.
- Central WiFiManager Setting:** A section with a "Save" button.

A "Save" button is located at the bottom right of the page.

System Name Settings

Each of the five main categories display various hidden administrator parameters and settings.

System Name: The name of the device. The default name is D-Link DAP-2610.

Location: The physical location of the device, e.g. 72nd Floor, D-Link HQ.



The screenshot shows the 'System Name Settings' configuration page. At the top, there is a header 'System Name Settings' with a checked checkbox. Below the header, there are two input fields: 'System Name' with the value 'D-Link DAP-2553' and 'Location' which is currently empty.

Login Settings

Each of the five main categories display various hidden administrator parameters and settings.

User Name: Enter a user name. The default is admin.

Old Password: When changing your password, enter the old password here.

New Password: When changing your password, enter the new password here. The password is case-sensitive. "A" is a different character than "a." The length should be between 0 and 12 characters.

Confirm Password: Enter the new password a second time for confirmation purposes.



The screenshot shows the 'Login Settings' configuration page. At the top, there is a header 'Login Settings' with a checked checkbox. Below the header, there are four input fields: 'Login Name' with the value 'admin', 'Old Password', 'New Password', and 'Confirm Password', all of which are currently empty.

Console Settings

Each of the five main categories display various hidden administrator parameters and settings.

Status: Status is enabled by default. Uncheck the box to disable the console.

Console Protocol: Select the type of protocol you would like to use, Telnet or SSH.

Time-out: Set to 1 Min, 3 Mins, 5 Mins, 10 Mins, 15 Mins or Never.

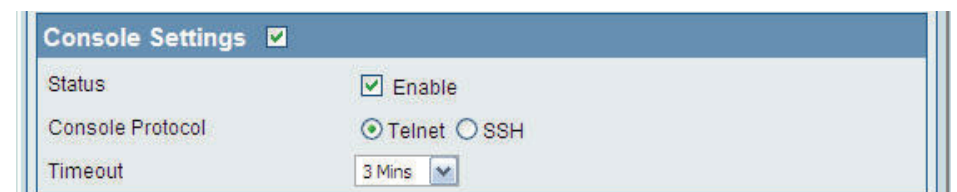

The screenshot shows the 'Console Settings' configuration page. At the top, there is a header 'Console Settings' with a checked checkbox. Below the header, there are three settings: 'Status' with a checked checkbox and the label 'Enable', 'Console Protocol' with radio buttons for 'Telnet' (selected) and 'SSH', and 'Timeout' with a dropdown menu set to '3 Mins'.

SNMP Settings

Each of the five main categories display various hidden administrator parameters and settings.

Status: Check the box to enable the SNMP functions. This is enabled by default.

Public Community String: Enter the public SNMP community string.

Private Community String: Enter the private SNMP community string.

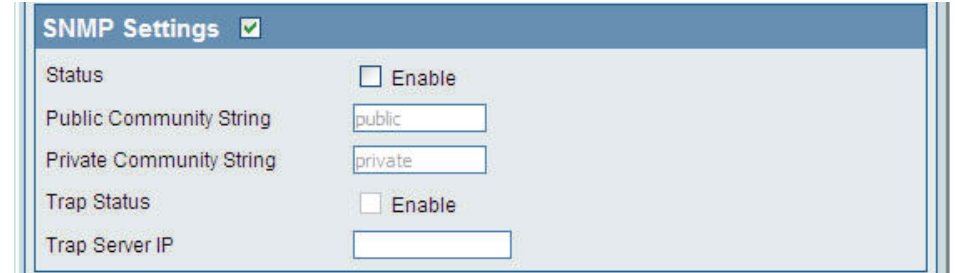

SNMP Settings <input checked="" type="checkbox"/>	
Status	<input type="checkbox"/> Enable
Public Community String	<input type="text" value="public"/>
Private Community String	<input type="text" value="private"/>
Trap Status	<input type="checkbox"/> Enable
Trap Server IP	<input type="text"/>

Administration

Central WiFiManager Settings

The Central WiFiManager section is used to create a set of APs on the Internet to be organized into a single group in order to increase ease of management. Central WiFiManager and AP Array are mutually exclusive functions.

Enable Central WiFiManager: Select to enable or disable the Central WiFiManager.

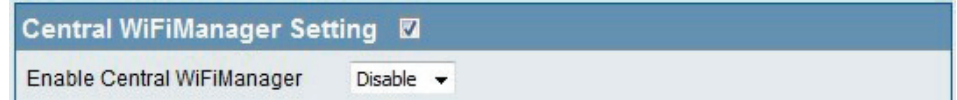

Firmware and SSL Upload

This page allows the user to perform a firmware upgrade. A Firmware upgrade is a function that upgrade the running software used by the access point. This is a useful feature that prevents future bugs and allows for new features to be added to this product. Please go to your local D-Link website to see if there is a newer version firmware available.

Firmware and SSL Certification Upload: You can upload files to the access point.

Upload Firmware from Local Hard Drive: The current firmware version is displayed above the file location field. After the latest firmware is downloaded, click on the “Choose File” button to locate the new firmware. Once the file is selected, click on the “Open” and “Upload” button to begin updating the firmware. Please don’t turn the power off while upgrading.

Upload SSL Certification from Local Hard Drive: After you have downloaded a SSL certification to your local drive, click “Choose File.” Select the certification and click “Open” and “Upload” to complete the upgrade.

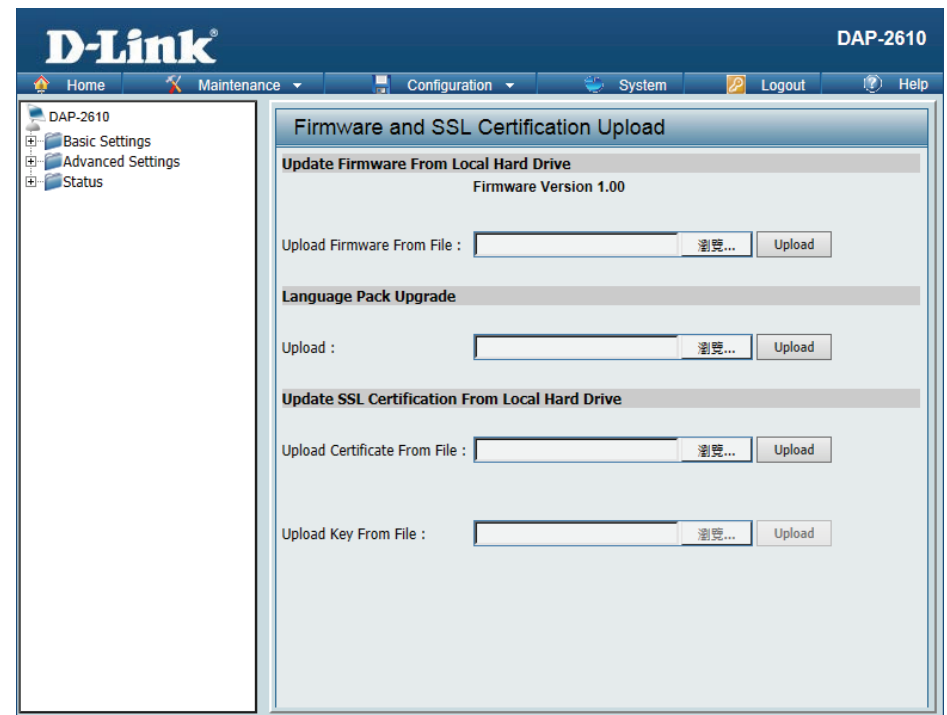

Configuration File Upload

This page allows the user to backup and recover the current configuration of the access point in case of a unit failure.

Configuration File Upload and Download: You can upload and download configuration files of the access point.

Upload Configuration File: Browse to the saved configuration file you have in local drive and click "Open" and "Upload" to update the configuration.

Download Configuration File: Click "Download" to save the current configuration file to your local disk. Note that if you save one configuration file with the administrator's password now, after resetting your DAP-2610 and then updating to this saved configuration file, the password will be gone.

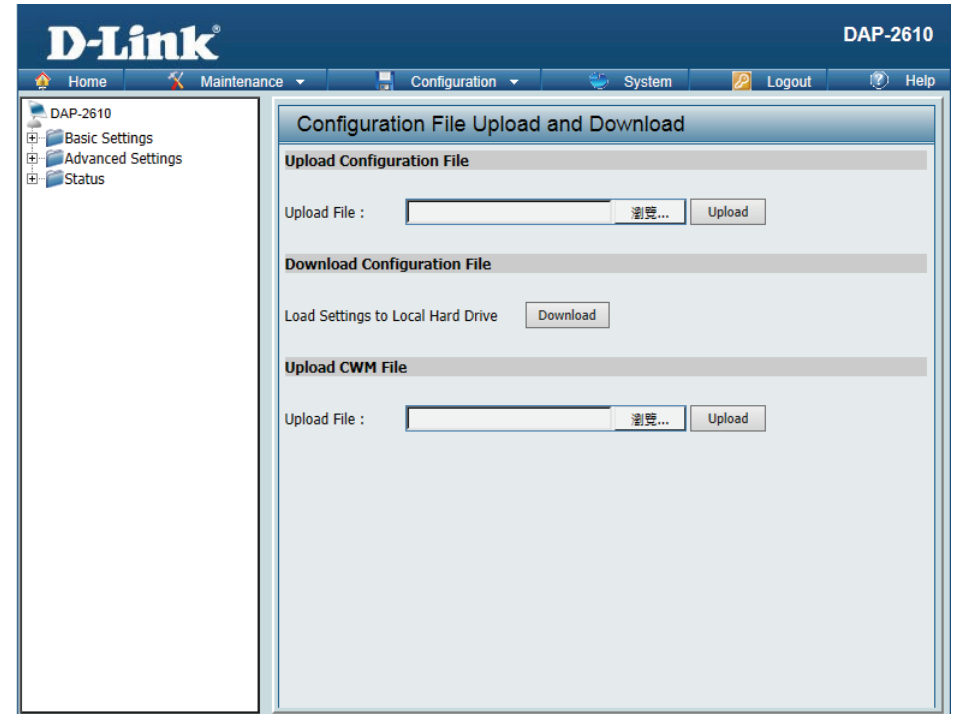

Time and Date Settings

Enter the NTP server IP, choose the time zone, and enable or disable daylight saving time.

Current Time: Displays the current time and date settings.

Enable NTP Server: Check to enable the AP to get system time from an NTP server from the Internet.

NTP Server: Enter the NTP server IP address.

Time Zone: Use the drop-down menu to select your correct Time Zone.

Enable Daylight Saving: Check the box to enable Daylight Saving Time.

Daylight Saving Dates: Use the drop-down menu to select the correct Daylight Saving offset.

Set the Date and Time Manually: A user can either manually set the time for the AP here, or click the Copy Your Computer's Time Settings button to copy the time from the computer in use (Make sure that the computer's time is set correctly).

The screenshot shows the D-Link DAP-2610 web interface. The top navigation bar includes Home, Maintenance, Configuration, System, Logout, and Help. The left sidebar shows the navigation menu with DAP-2610, Basic Settings, Advanced Settings, and Status. The main content area is titled "Time and Date Settings" and contains the following sections:

- Time Configuration:** Shows the current time as 01/01/1970 10:24:40.
- Automatic Time Configuration:**
 - Enable NTP Server:
 - NTP Server:
 - Time Zone: (GMT+08:00) Kuala Lumpur, Singapore (dropdown menu)
 - Enable Daylight Saving:
- Set the Date and Time Manually:**
 - Date And Time:
 - Year: 2016
 - Month: Dec
 - Day: 19
 - Hour: 17
 - Minute: 9
 - Second: 50
 - Copy Your Computer's Time Settings (button)

A Save button is located at the bottom right of the form.

Configuration and System

These options are the remaining option to choose from in the top menu. Configuration allows the user to save and activate or discard the configurations done. System allows the user to restart the unit, perform a factory reset or clear the language pack settings. Logout allows the user to safely log out from the access point's web configuration. Help allows the user to read more about the given options to configure without the need to consult the manual. The following pages will explain settings found in the configuration and system section in more detail.

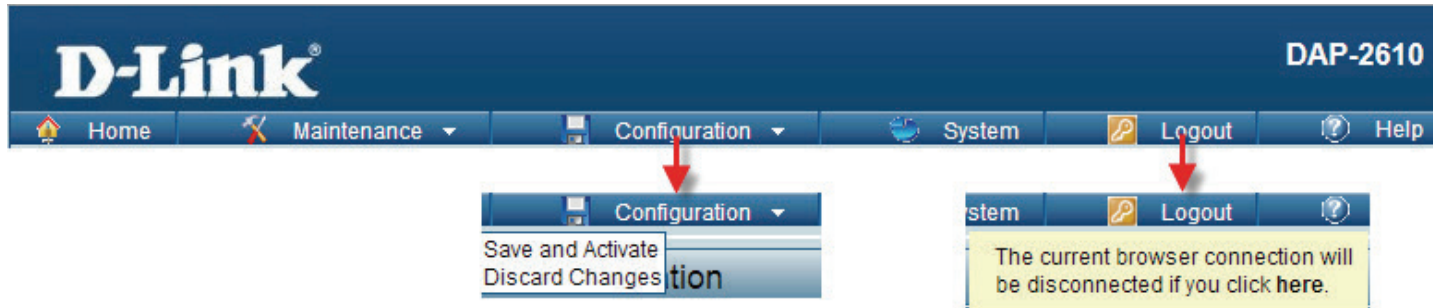

System Settings

On this page the user can restart the unit, perform a factory reset of the access point or clear the added language pack.

Restart the Device: Click Restart to restart the DAP-2610.

Restore to Factory Default Settings: Click Restore to restore the DAP-2610 back to factory default settings.

Clear Language Pack: Click to clear the current Language pack running.

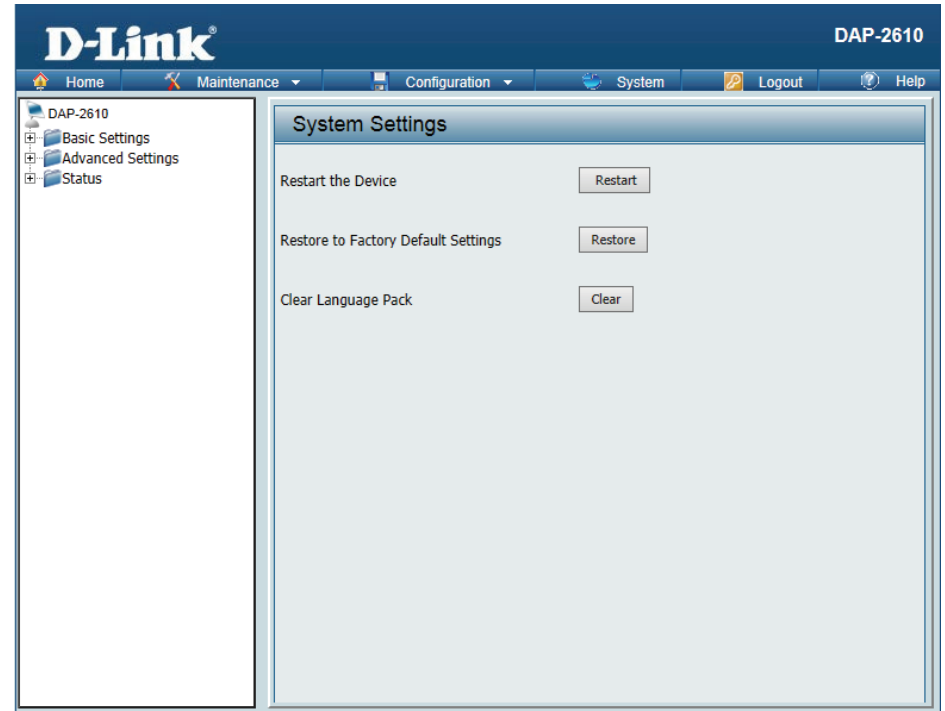

Help

The help page is useful to view a brief description of a function available on the access point in case the manual is not present.

Help: Scroll down the Help page for topics and explanations.

Basic Settings

Wireless Settings

Allow you to change the wireless settings to fit an existing wireless network or to customize your wireless network.

Wireless Band
Operating frequency band. Choose 2.4GHz for visibility to legacy devices and for longer range. Choose 5GHz for least interference; interference can hurt performance. This AP will operate one band at a time.

Application
This option allows the user to choose for indoor or outdoor mode at the 5G Band.

Mode
Select a function mode to configure your wireless network. Function modes include AP, WDS (Wireless Distribution System) with AP, WDS and Wireless Client. Function modes are designed to support various wireless network topology and applications.

Network Name (SSID)
Also known as the Service Set Identifier, this is the name designated for a specific wireless local area network (WLAN). The factory default setting is "dlink". The SSID can be easily changed to connect to an existing wireless network or to establish a new wireless network.

SSID Visibility
Indicate whether or not the SSID of your wireless network will be broadcasted. The default value of SSID Visibility is set to "Enable," which allow wireless clients to detect the wireless network. By changing this setting to "Disable," wireless clients can no longer detect the wireless network and can only connect if they have the correct SSID entered.

Auto Channel Selection
If you check Auto Channel Scan, everytime when AP is booting up, the AP will automatically find the best channel to use. This is enabled by default.

Channel
Indicate the channel setting for the DAP-2553. By default, the AP is set to Auto Channel Scan. The Channel can be changed to fit the channel setting for an existing wireless network or to customize the wireless network.

Channel Width
Allows you to select the channel width you would like to operate in. Select 20MHz if you are not using any 802.11n wireless clients. Auto 20/40MHz allows you to use both 802.11n and non-802.11n wireless devices in your network.

Authentication

Knowledge Base

Wireless Basics

D-Link wireless products are based on industry standards to provide high-speed wireless connectivity that is easy to use within your home, business or public access wireless networks. D-Link wireless products provides you with access to the data you want, whenever and wherever you want it. Enjoy the freedom that wireless networking can bring to you.

WLAN use is not only increasing in both home and office environments, but in public areas as well, such as airports, coffee shops and universities. Innovative ways to utilize WLAN technology are allowing people to work and communicate more efficiently. Increased mobility and the absence of cabling and other types of fixed infrastructure have proven to be beneficial to many users.

Wireless adapter cards used on laptop and desktop systems support the same protocols as Ethernet adapter cards, allowing wireless users to use the same applications as those used on a wired network.

People use WLAN technology for many different purposes:

- **Mobility** - productivity increases when people can have access to data in any location within the operating range of their WLAN. Management decisions based on real-time information can significantly improve the efficiency of a worker.
- **Low implementation costs** - WLANs are easy to set up, manage, change and relocate. Networks that frequently change can benefit from WLAN's ease of implementation. WLANs can operate in locations where installation of wiring may be impractical.
- **Installation and network expansion** - by avoiding the complications of troublesome cables, a WLAN system can be fast and easy during installation, especially since it can eliminate the need to pull cable through walls and ceilings. Wireless technology provides more versatility by extending the network beyond the home or office.
- **Inexpensive solution** - wireless network devices are as competitively priced as conventional Ethernet network devices. The DAP-2610 saves money by providing users with multi-functionality configurable in four different modes.
- **Scalability** - Configurations can be easily changed and range from Peer-to-Peer networks, suitable for a small number of users to larger Infrastructure networks to accommodate hundreds or thousands of users, depending on the number of wireless devices deployed.

Wireless Installation Considerations

The D-Link Access Point lets you access your network using a wireless connection from virtually anywhere within the operating range of your wireless network. Keep in mind, however, that the number, thickness and location of walls, ceilings, or other objects that the wireless signals must pass through, may limit the range. Typical ranges vary depending on the types of materials and background RF (radio frequency) noise in your home or business. The key to maximizing wireless range is to follow these basic guidelines:

1. Keep the number of walls and ceilings between the access point and other network devices to a minimum. Each wall or ceiling can reduce your adapter's range from 3-90 feet (1-30 meters.) Position your devices so that the number of walls or ceilings is minimized.
2. Be aware of the direct line between network devices. A wall that is 1.5 feet thick (.5 meters), at a
3. 45-degree angle appears to be almost 3 feet (1 meter) thick. At a 2-degree angle it looks over 42 feet (14 meters) thick! Position devices so that the signal will travel straight through a wall or ceiling (instead of at an angle) for better reception.
4. Building Materials make a difference. A solid metal door or aluminum studs may have a negative effect on the range. Try to position access points, wireless routers, and computers so that the signal passes through drywall or open doorways. Materials and objects such as glass, steel, metal, walls with insulation, water (fish tanks), mirrors, file cabinets, brick, and concrete will degrade your wireless signal.
5. Keep your product away (at least 3-6 feet or 1-2 meters) from electrical devices or appliances that generate RF noise.
6. If you are using 2.4GHz cordless phones or X-10 (wireless products such as ceiling fans, lights, and home security systems), your wireless connection may degrade dramatically or drop completely. Make sure your 2.4GHz phone base is as far away from your wireless devices as possible. The base transmits a signal even if the phone is not in use.

Troubleshooting

This chapter provides solutions to problems that can occur during the installation and operation of the DAP-2610. Read the following descriptions if you are having problems. (The examples below are illustrated in Windows® XP. If you have a different operating system, the screenshots on your computer will look similar to the following examples.)

Why can't I access the web-based configuration utility?

When entering the IP address of the D-Link access point (192.168.0.50 for example), you are not connecting to a website on the Internet or have to be connected to the Internet. The device has the utility built-in to a ROM chip in the device itself. Your computer must be on the same IP subnet to connect to the web-based utility.

- Make sure you have an updated Java-enabled web browser. We recommend the following:
 - Internet Explorer 7.0 or higher, Chrome, Firefox, or Safari 4 or higher
- Verify physical connectivity by checking for solid link lights on the device. If you do not get a solid link light, try using a different cable or connect to a different port on the device if possible. If the computer is turned off, the link light may not be on.
- Disable any internet security software running on the computer. Software firewalls such as Zone Alarm, Black Ice, Sygate, Norton Personal Firewall, and Windows® firewall may block access to the configuration pages. Check the help files included with your firewall software for more information on disabling or configuring it.
- Configure your Internet settings:
 - Go to Start > Settings > Control Panel. Double-click the Internet Options Icon. From the Security tab, click the button to restore the settings to their defaults.
 - Click the Connection tab and set the dial-up option to Never Dial a Connection. Click the LAN Settings button. Make sure nothing is checked. Click OK.
 - Go to the Advanced tab and click the button to restore these settings to their defaults. Click OK three times.
 - Close your web browser (if open) and open it.
- Access the web management. Open your web browser and enter the IP address of your D-Link access point in the address bar. This should open the login page for your the web management.
- If you still cannot access the configuration, unplug the power to the access point for 10 seconds and plug back in. Wait about 30 seconds and try accessing the configuration. If you have multiple computers, try connecting using a different computer.

What can I do if I forgot my password?

If you forgot your password, you must reset your access point. Unfortunately, this process will change all your settings back to the factory defaults.

To reset the access point, locate the reset button (hole) on the rear panel of the unit. With the access point powered on, use a paperclip to hold the button down for 10 seconds. Release the button and the access point will go through its reboot process. Wait about 30 seconds to access the access point. The default IP address is 192.168.0.50. When logging in, the username is admin and leave the password box empty.

How to check your IP address?

After you install your network adapter, by default, the TCP/IP settings should be set to obtain an IP address from a DHCP server (i.e. wireless router) automatically. To verify your IP address, please follow the steps below.

Click on Start > Run. In the run box type cmd and click OK.

At the prompt, type ipconfig and press Enter.

This will display the IP address, subnet mask, and the default gateway of your adapter.

If the address is 0.0.0.0, check your adapter installation, security settings, and the settings on your router. Some firewall software programs may block a DHCP request on newly installed adapters.

If you are connecting to a wireless network at a hotspot (e.g. hotel, coffee shop, airport), please contact an employee or administrator to verify their wireless network settings.

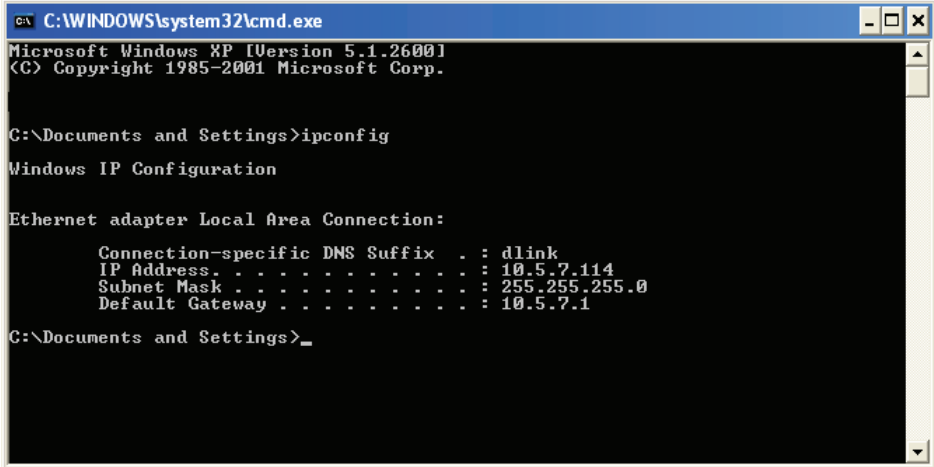

```
C:\WINDOWS\system32\cmd.exe
Microsoft Windows XP [Version 5.1.2600]
(C) Copyright 1985-2001 Microsoft Corp.

C:\Documents and Settings>ipconfig

Windows IP Configuration

Ethernet adapter Local Area Connection:

    Connection-specific DNS Suffix  . : dlink
    IP Address . . . . . : 10.5.7.114
    Subnet Mask . . . . . : 255.255.255.0
    Default Gateway . . . . . : 10.5.7.1

C:\Documents and Settings>_
```

How to statically assign an IP address?

If you are not using a DHCP capable gateway/router, or you need to assign a static IP address, please follow the steps below:

Step 1:

Windows® 2000: Click on Start > Settings > Control Panel > Network Connections

Windows XP: Click on Start > Control Panel > Network Connections

Windows Vista®: Click on Start > Control Panel > Network and Internet > Network and Sharing Center > Manage network connections

Step 2:

Right-click on the Local Area Connection which represents your network adapter and select Properties.

Step 3:

Highlight Internet Protocol (TCP/IP) and click Properties.

Step 4:

Click Use the following IP address and enter an IP address that is on the same subnet as your network or the LAN IP address on your router.

Example: If the router's LAN IP address is 192.168.0.1, make your IP address 192.168.0.X where X is a number between 2 and 99. Make sure that the number you choose is not in use on the network. Set Default Gateway the same as the LAN IP address of your router (192.168.0.1).

Set Primary DNS the same as the LAN IP address of your router (192.168.0.1). The Secondary DNS is not needed or you may enter a DNS server from your ISP.

Step 5:

Click OK twice to save your settings.

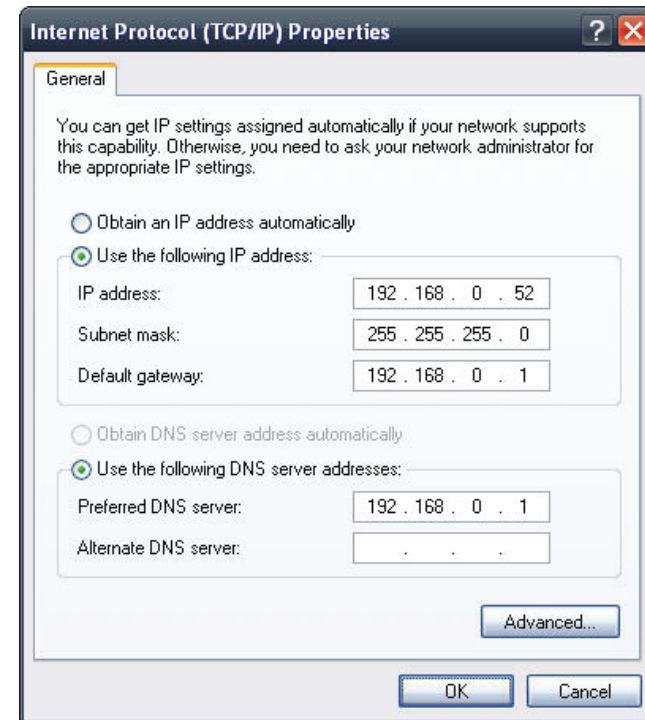

Technical Specifications

Standards

- IEEE 802.11ac
- IEEE 802.11n
- IEEE 802.11g
- IEEE 802.11a
- IEEE 802.3
- IEEE 802.3u
- IEEE 802.3ab
- IEEE 802.3af
- IEEE 802.3x

Network Management

- Web Browser interface (HTTP, Secure HTTP (HTTPS))
- Central WiFiManager
- SNMP Support (Private MIB)
- Command Line Interface (Telnet, Secure SSH Telnet)

Security

- WPA™ Personal/Enterprise
- WPA2™ Personal/Enterprise
- WEP™ 64-/128-bit

Wireless Frequency Range

- 2.4 to 2.4835 GHz and 5.15 to 5.85 GHz**

Operating Voltage

- 802.3af PoE or 12V/1A

Antenna Type

- 2x Detachable Dual Band 3 dBi Omni antennas @2.4GHz & @5GHz

LEDs

- Power/Status

Temperature

- Operating: 0°C to 40°C
- Storing: -20°C to 65°C

Humidity

- Operating: 10%~90% (non-condensing)
- Storing: 5%~95% (non-condensing)

Certifications

- FCC Class B
- CE
- UL
- IC
- C-Tick
- Wi-Fi

Dimensions

- L = 170 mm
- W = 170 mm
- H = 28 mm

Antenna Pattern

Antenna Pattern		
Orientation	H-Plane	E-Plane
<p>2.4 GHz Ceiling Mounted</p>		
<p>2.4 GHz Wall Mounted</p>		
<p>5 GHz Ceiling Mounted</p>		
<p>5 GHz Wall Mounted</p>		

FREE Central WiFiManager Software



With the easy-to-use web-based interface you can...

- Configure once and apply to multiple Access Points
- Install on Windows PC
- Access on any device using a web-browser, e.g. smartphone or notebook
- Utilise user authentication and access control
- Monitor your entire wireless network in real time¹
- Access detailed reports
- Optimise your bandwidth

FREE Central WiFiManager User Interface

Supports multiple languages

The interface displays a dashboard with navigation tabs: Home, Configuration, System, and Monitor. The 'Home-Dashboard' view includes a 'Station' table with columns for Band, Sun, and 50Hz, and an 'Access Point' table with columns for Model, Status, Sun, and Off Line #. Below these are three pie charts representing station details. The 'Monitor' view shows a line graph titled 'Selected Profile: test status: Running' and a table of station details.

No.	MAC Address	AP IP Address	Host	Brand	Authentication	RSSI	SSID	Power Save Mode
1	BC3BAF08E18C	192.168.123.236	iPhone 5	N	WPA2-Personal	100	Primary SSID	OFF
2	B47A886C4818	192.168.123.232	HTC	AC	WPA2-Personal	98	Primary SSID	OFF
3	A088B4E4D508	192.168.123.236	Notebook	N	WPA2-Personal	100	Primary SSID	OFF
4	E0F5C802DB60	192.168.123.232	iPad Mini	N	WPA2-Personal	100	Primary SSID	ON

1. see overleaf for selected product information.



FREE Central WiFiManager

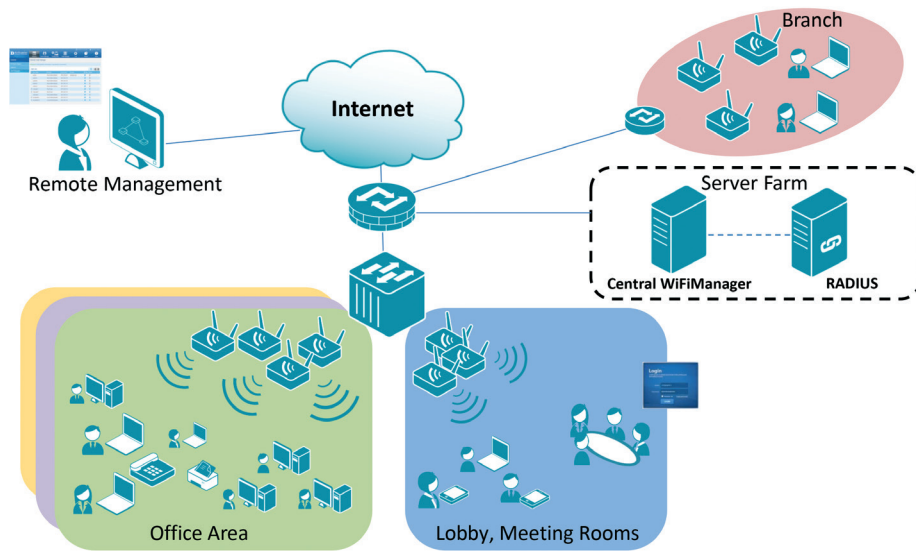

Available on the following products²:

DAP-2695

Wireless AC1750 Indoor Access Point
Designed to support small to medium business or enterprise environments. Secure, manageable dual-band wireless LAN options.



DAP-2660

Wireless AC1200 Indoor Ceiling Access Point
Providing enhanced speeds of Wireless AC as well as dual-band connectivity to reduce interference, for a faster and more efficient network.



DAP-2310

Wireless N Indoor Access Point
Ideal for creating or expanding capacity of a wireless network; mainly used in high-traffic areas such as airports, coffee shops, sports venues, and university campus deployments.



DAP-2360

Wireless N PoE Access Point
For advanced indoor installations, this high-speed Access Point has integrated PoE support, allowing installation in areas where power outlets are not readily available.



DAP-2690

Wireless N Simultaneous Dual-Band PoE Access Point
Designed for indoor installation where power outlets are not readily available. Enables deployment of a highly manageable, robust and secure wireless network.



DAP-2330

Wireless N PoE Access Point
Ideal for wireless networks in high-traffic areas such as airports, coffee shops, shopping centres, sporting venues, hotels and campus deployments. PoE offers installation where power outlets are not available.



2. Visit dlink.com for selected Hardware & Software versions.