

**DAIKIN**

## Installation manual

**Daikin room air conditioner**

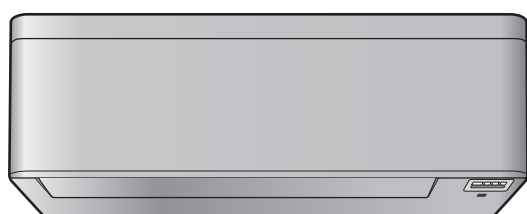

CTXA15A2V1BW  
FTXA20A2V1BW  
FTXA25A2V1BW  
FTXA35A2V1BW  
FTXA42A2V1BW  
FTXA50A2V1BW

CTXA15A2V1BS  
FTXA20A2V1BS  
FTXA25A2V1BS  
FTXA35A2V1BS  
FTXA42A2V1BS  
FTXA50A2V1BS

CTXA15A2V1BT  
FTXA20A2V1BT  
FTXA25A2V1BT  
FTXA35A2V1BT  
FTXA42A2V1BT  
FTXA50A2V1BT

Installation manual  
Daikin room air conditioner

English

# Table of Contents

<b>1</b>	<b>About the documentation</b>	<b>2</b>
1.1	About this document.....	2
<b>2</b>	<b>About the box</b>	<b>2</b>
2.1	Indoor unit .....	2
2.1.1	To remove the accessories from the indoor unit.....	2
<b>3</b>	<b>About the unit</b>	<b>3</b>
3.1	System layout.....	3
3.2	Operation range .....	3
3.3	About the wireless adapter.....	3
3.3.1	Precautions when using the wireless adapter.....	3
3.3.2	Basic parameters.....	3
<b>4</b>	<b>Preparation</b>	<b>3</b>
4.1	Preparing the installation site .....	3
4.1.1	Installation site requirements of the indoor unit .....	3
<b>5</b>	<b>Installation</b>	<b>4</b>
5.1	Opening the indoor unit.....	4
5.1.1	To open the front panel.....	4
5.1.2	To close the front panel .....	4
5.1.3	To remove the front panel.....	4
5.1.4	To open the service cover.....	5
5.1.5	To remove the front grille.....	5
5.1.6	To re-install the front grille .....	5
5.1.7	To remove the electrical wiring box cover.....	5
5.2	Installing the indoor unit .....	6
5.2.1	To install the mounting plate .....	6
5.2.2	To drill a wall hole .....	6
5.2.3	To remove the pipe port cover .....	7
5.2.4	To provide drainage .....	7
5.3	Connecting the refrigerant piping .....	8
5.3.1	To connect the refrigerant piping to the indoor unit ....	8
5.4	Connecting the electrical wiring.....	8
5.4.1	To connect the electrical wiring on the indoor unit.....	8
5.4.2	To connect optional accessories (wired user interface, central user interface, etc.).....	9
5.5	Finishing the indoor unit installation .....	9
5.5.1	To insulate the drain piping, refrigerant piping and interconnection cable .....	9
5.5.2	To pass the pipes through the wall hole .....	9
5.5.3	To fix the unit on the mounting plate.....	9
<b>6</b>	<b>Commissioning</b>	<b>9</b>
6.1	Checklist before commissioning.....	9
6.2	To perform a test run.....	10
6.2.1	To perform a test run using the user interface.....	10
<b>7</b>	<b>Technical data</b>	<b>11</b>
7.1	Wiring diagram .....	11

## 1 About the documentation

### 1.1 About this document



#### INFORMATION

Make sure that the user has the printed documentation and ask him/her to keep it for future reference.

#### Target audience

Authorised installers



#### INFORMATION

This appliance is intended to be used by expert or trained users in shops, in light industry, and on farms, or for commercial and household use by lay persons.

#### Documentation set

This document is part of a documentation set. The complete set consists of:

- **General safety precautions:**
  - Safety instructions that you **MUST** read before installing
  - Format: Paper (in the box of the indoor unit)
- **Indoor unit installation manual:**
  - Installation instructions
  - Format: Paper (in the box of the indoor unit)
- **Installer reference guide:**
  - Preparation of the installation, good practices, reference data,...
  - Format: Digital files on <http://www.daikineurope.com/support-and-manuals/product-information/>

Latest revisions of the supplied documentation may be available on the regional Daikin website or via your dealer.

The original documentation is written in English. All other languages are translations.

#### Technical engineering data

- A **subset** of the latest technical data is available on the regional Daikin website (publicly accessible).
- The **full set** of latest technical data is available on the Daikin extranet (authentication required).

## 2 About the box

### 2.1 Indoor unit

#### 2.1.1 To remove the accessories from the indoor unit

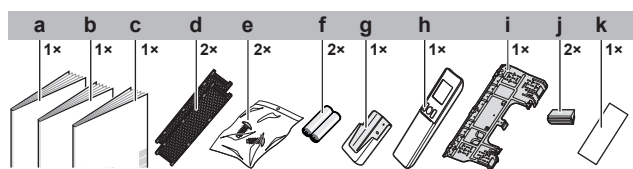

- a Installation manual
- b Operation manual
- c General safety precautions
- d Titanium apatite deodorizing filter and silver particle filter (Ag-ion filter)
- e Indoor unit fixing screw (M4×12L). Refer to "5.5.3 To fix the unit on the mounting plate" on page 9.
- f Dry battery AAA.LR03 (alkaline) for user interface
- g User interface holder
- h User interface
- i Mounting plate
- j Screw cover
- k Spare SSID sticker with release paper (attached to the unit)

- **Spare SSID sticker.** Do NOT throw away the spare sticker. Keep it in a safe place in case it is needed in future (e.g. in case the front grille was replaced attach it to the new front grille).

### 3 About the unit



#### WARNING: FLAMMABLE MATERIAL

The refrigerant inside this unit is mildly flammable.

#### 3.1 System layout

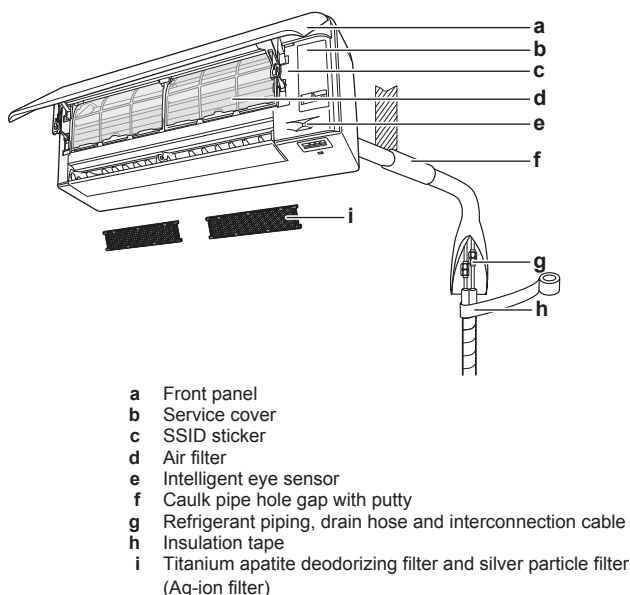

- a Front panel
- b Service cover
- c SSID sticker
- d Air filter
- e Intelligent eye sensor
- f Caulk pipe hole gap with putty
- g Refrigerant piping, drain hose and interconnection cable
- h Insulation tape
- i Titanium apatite deodorizing filter and silver particle filter (Ag-ion filter)

#### 3.2 Operation range

Use the system in the following temperature and humidity ranges for safe and effective operation.

Operation mode	Operation range
Cooling <sup>(a)(b)</sup>	<ul style="list-style-type: none"> <li>▪ Outdoor temperature: -10~46°C</li> <li>▪ Indoor temperature: 18~32°C</li> <li>▪ Indoor humidity: ≤80%</li> </ul>
Heating <sup>(a)</sup>	<ul style="list-style-type: none"> <li>▪ Outdoor temperature: -15~24°C</li> <li>▪ Indoor temperature: 10~30°C</li> </ul>
Drying <sup>(a)</sup>	<ul style="list-style-type: none"> <li>▪ Outdoor temperature: -10~46°C</li> <li>▪ Indoor temperature: 18~32°C</li> <li>▪ Indoor humidity: ≤80%</li> </ul>

If operated outside the operation range:

- (a) A safety device might stop the operation of the system.
- (b) Condensation might occur on the indoor unit and drip.

#### 3.3 About the wireless adapter

For detailed specifications, installation instructions, setting methods, FAQ, declaration of conformity and the latest version of this manual, visit <http://www.onlinecontroller.daikineurope.com>.



#### INFORMATION

- Daikin Industries Czech Republic s.r.o. declares that the radio equipment type inside of this unit is in compliance with Directive 2014/53/EU.
- This unit is considered as combined equipment according to the definition of Directive 2014/53/EU.

#### 3.3.1 Precautions when using the wireless adapter

Do NOT use near:

- **Medical equipment.** E.g. persons using cardiac pacemakers or defibrillators. This product may cause electromagnetic interference.
- **Auto-control equipment.** E.g. automatic doors or fire alarm equipment. This product may cause faulty behaviour of the equipment.
- **Microwave oven.** It may affect wireless LAN communications.

#### 3.3.2 Basic parameters

What	Value
Frequency range	2400 MHz~2483.5 MHz
Radio protocol	IEEE 802.11b/g/n
Radio frequency channel	1~11
Output power	0 dBm~18 dBm
Effective radiated power	17 dBm (11b) / 13 dBm (11g) / 12 dBm (11n)
Power supply	DC 3.3 V / 500 mA

## 4 Preparation

### 4.1 Preparing the installation site



#### WARNING

The appliance shall be stored in a room without continuously operating ignition sources (example: open flames, an operating gas appliance or an operating electric heater).

#### 4.1.1 Installation site requirements of the indoor unit



#### INFORMATION

The sound pressure level is less than 70 dBA.

- **Air flow.** Make sure nothing blocks the air flow.
  - **Drainage.** Make sure condensation water can be evacuated properly.
  - **Wall insulation.** When conditions in the wall exceed 30°C and a relative humidity of 80%, or when fresh air is inducted into the wall, then additional insulation is required (minimum 10 mm thickness, polyethylene foam).
  - **Wall strength.** Check whether the wall or the floor is strong enough to support the weight of the unit. If there is a risk, reinforce the wall or the floor before installing the unit.
- Install power cables at least 1 metre away from televisions or radios to prevent interference. Depending on the radio waves, a distance of 3 metres may NOT be sufficient.
- Choose a location where the hot/cold air discharged from the unit or the operation noise, will NOT disturb anyone.
  - **Fluorescent lights.** When installing a wireless user interface in a room with fluorescent lights, mind the following to avoid interference:
    - Install the wireless user interface as close as possible to the indoor unit.
    - Install the indoor unit as far as possible from the fluorescent lights.

## 5 Installation

It is NOT recommended to install the unit in the following places because it may shorten the life of the unit:

- Where the voltage fluctuates a lot
- In vehicles or vessels
- Where acidic or alkaline vapour is present
- In places where a mineral oil mist, spray or vapour may be present in the atmosphere. Plastic parts may deteriorate and fall off or cause water leakage.
- In places where the unit would be in the path of direct sunlight.
- In bathrooms.
- Sound sensitive areas (e.g. near a bedroom), so that the operation noise will cause no trouble.



### WARNING

Do NOT place objects below the indoor and/or outdoor unit that may get wet. Otherwise condensation on the unit or refrigerant pipes, air filter dirt or drain blockage may cause dripping, and objects under the unit may get dirty or damaged.

- **Spacing.** Install the unit at least 1.8 m from the floor and keep the following requirements in mind for distances from the walls and the ceiling:

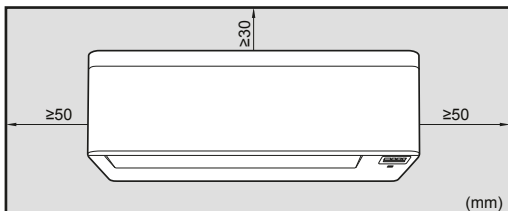

**Note:** Make sure that there are no obstacles within 500 mm under the signal receiver. They may influence reception performance of the user interface.

## 5 Installation

### 5.1 Opening the indoor unit

#### 5.1.1 To open the front panel

- 1 Hold the front panel on both sides and open it.

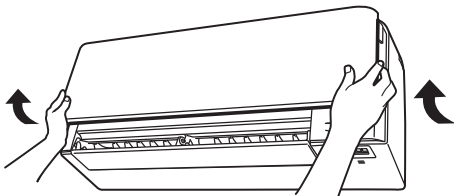

- 2 Pull down both locks on the back of the front panel.
- 3 Open the front panel until the support fits into the fixing tab.

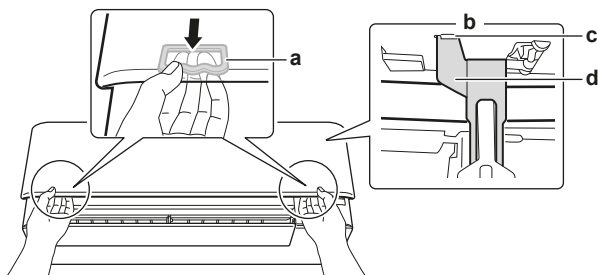

- a Lock (1 on each side)
- b Backside of the front panel
- c Fixing tab
- d Support

#### 5.1.2 To close the front panel

- 1 Lift the front panel slightly and remove the support from the fixing tab.

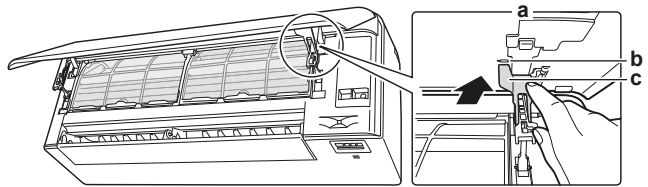

- a Backside of the front panel
- b Fixing tab
- c Support

- 2 Close the front panel.

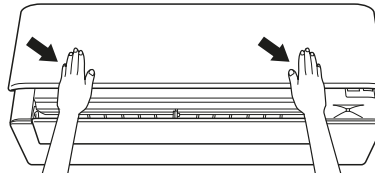

- 3 Gently press the front panel down until it clicks.

#### 5.1.3 To remove the front panel



### INFORMATION

Remove the front panel only in case it MUST be replaced.

- 1 Open the front panel. See "5.1.1 To open the front panel" on page 4.
- 2 Open the panel locks located on the back side of the panel (1 on each side).

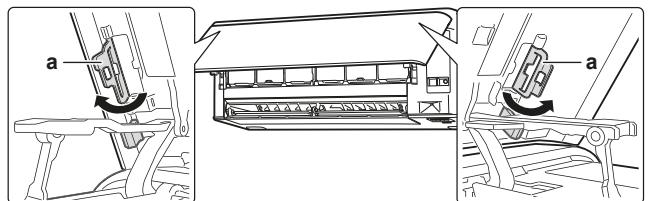

- a Panel lock

- 3 Push the right arm lightly to the right to disconnect the shaft from the shaft slot on the right side.

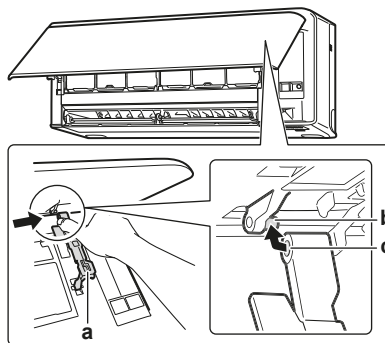

- a Arm
- b Shaft
- c Shaft slot

- 4 Disconnect the front panel shaft from the shaft slot on the left side.

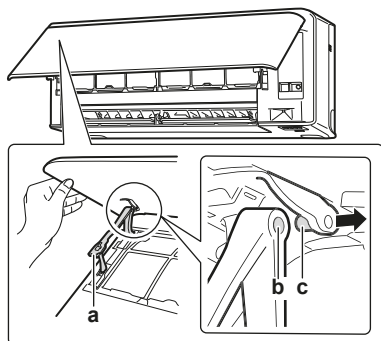

- a Arm
- b Shaft slot
- c Shaft

- 5 Remove the front panel.
- 6 To re-install the front panel perform the steps in the opposite order.

### 5.1.4 To open the service cover

- 1 Remove 1 screw from the service cover.
- 2 Pull out the service cover horizontally away from the unit.

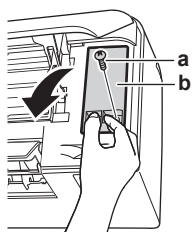

- a Service cover screw
- b Service cover

### 5.1.5 To remove the front grille



#### CAUTION

Wear protective gloves.

- 1 Open the front panel. Refer to "5.1.1 To open the front panel" on page 4.
- 2 Remove the service cover. Refer to "5.1.4 To open the service cover" on page 5.
- 3 Remove the wire harness from the wire clamp and the connector.
- 4 Remove the flap by pushing it to the left side and towards you.
- 5 Remove the 2 screw covers using a long flat plate such as a ruler wrapped in a cloth and remove 2 screws.

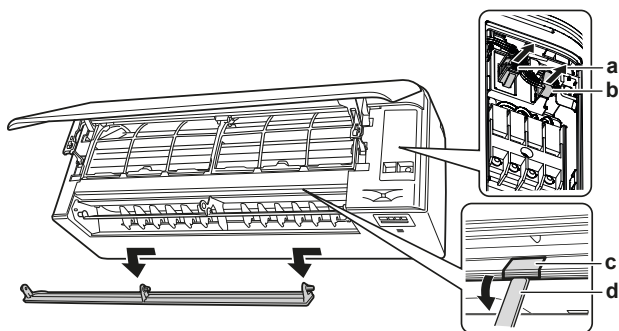

- a Connector
- b Wire clamp
- c Screw cover
- d Long flat plate wrapped in a cloth

- 6 Push the front grille up and then towards the mounting plate to remove the front grille from the 3 hooks.

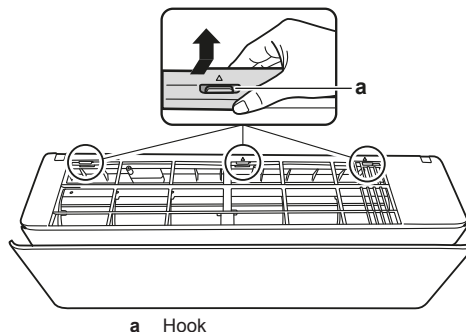

- a Hook

**Prerequisite: If working space is limited.**

- 7 Insert a flat screwdriver next to the hooks.
- 8 Pull the front grille up using the flat screwdriver and push towards the mounting plate.

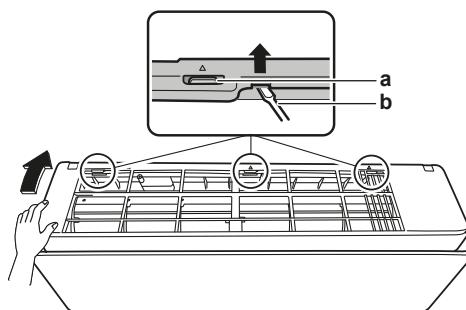

- a Hook
- b Flat screwdriver

### 5.1.6 To re-install the front grille

- 1 Install the front grille and firmly engage the 3 upper hooks.
- 2 Tighten the 2 screws and put the 2 screw covers back.
- 3 Re-install the flap.
- 4 Insert the wire harness back into the connector and secure it with the wire clamp.
- 5 Close the front panel. Refer to "5.1.2 To close the front panel" on page 4.

### 5.1.7 To remove the electrical wiring box cover

- 1 Remove the front grille.
- 2 Remove 1 screw from the electrical wiring box.
- 3 Open the electrical wiring box cover by pulling it to the front.
- 4 Remove the electrical wiring box cover from the 2 rear hooks.

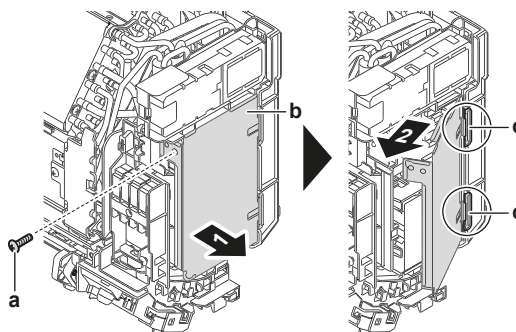

- a Screw
- b Electrical wiring box
- c Rear hook

- 5 To re-install the cover, first attach the electrical wiring box to the hooks, close the electrical wiring box, and re-install the screw.

## 5 Installation

### 5.2 Installing the indoor unit

#### 5.2.1 To install the mounting plate

- 1 Install the mounting plate temporarily.
- 2 Level the mounting plate.
- 3 Mark the centres of the drilling points on the wall using a tape measure. Position the end of tape measure at symbol "▷".
- 4 Finish the installation by securing the mounting plate on the wall using screws M4×25L (field supply).

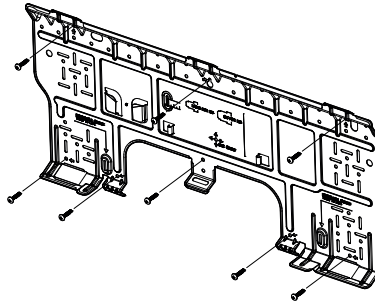

#### INFORMATION

The removed pipe port cover can be kept in the mounting plate pocket.

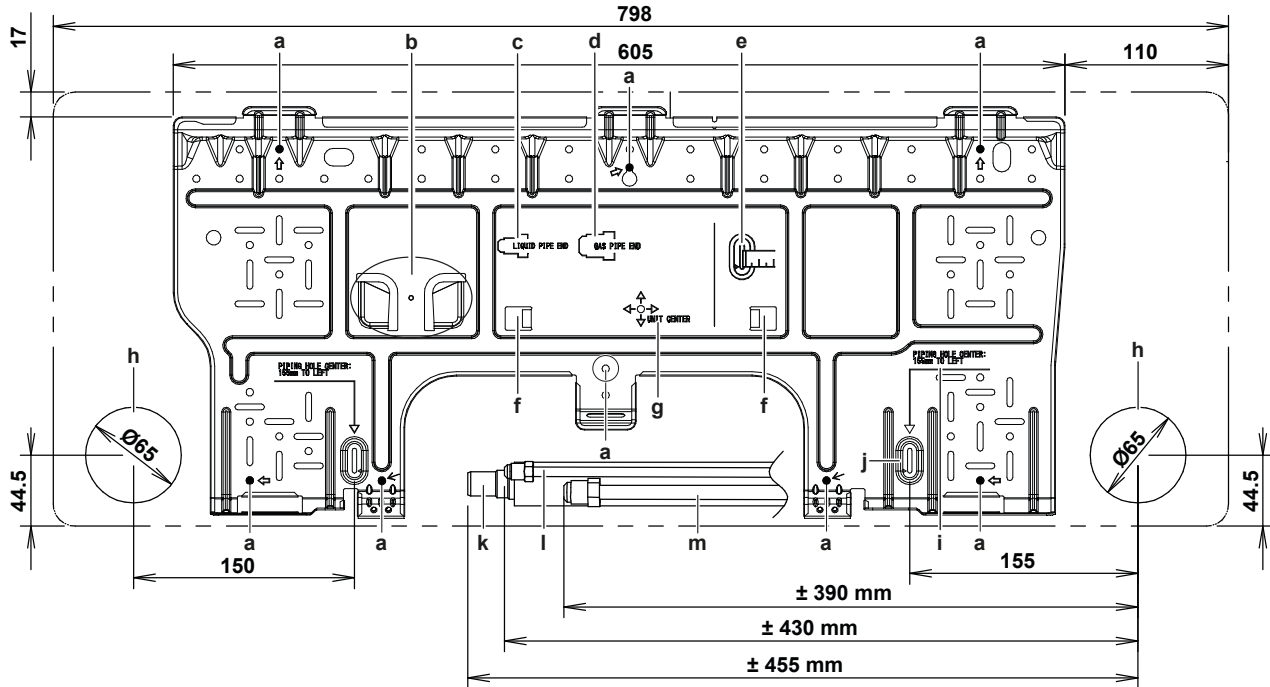

- a Recommended mounting plate fixing spots
- b Pocket for the pipe port cover
- c Liquid pipe end
- d Gas pipe end
- e Use tape measure as shown
- f Tabs for placing a spirit level
- g Unit center
- h Hole for embedded piping Ø65 mm
- i Value for tape measure
- j Position the end of tape measure at symbol "▷"
- k Drain hose
- l Liquid pipe
- m Gas pipe

#### 5.2.2 To drill a wall hole



#### CAUTION

For walls containing a metal frame or a metal board, use a wall embedded pipe and wall cover in the feed-through hole to prevent possible heat, electrical shock, or fire.



#### NOTICE

Be sure to seal the gaps around the pipes with sealing material (field supply), in order to prevent water leakage.

- 1 Bore a 65 mm large feed-through hole in the wall with a downward slope towards the outside.
- 2 Insert a wall embedded pipe into the hole.
- 3 Insert a wall cover into the wall pipe.

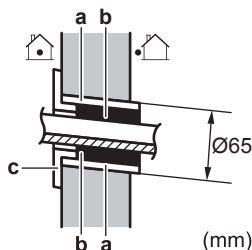

- a Wall embedded pipe
- b Putty
- c Wall hole cover

**Note:** After completing wiring, refrigerant piping and drain piping, do NOT forget to seal the gap with putty.

## 5.2.3 To remove the pipe port cover

To connect the piping on right-side, right-bottom, left-side or left-bottom, the pipe port cover MUST be removed.

- 1 Cut off the pipe port cover from inside the front grille using a coping saw.

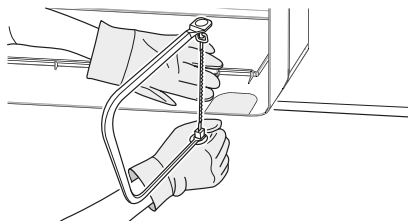

- 2 Remove any burrs along the cut section using a half round needle file.

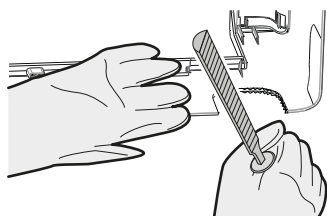

### NOTICE

Do NOT use nippers to remove the pipe port cover, as this would damage the front grille.

## 5.2.4 To provide drainage

Make sure condensation water can be evacuated properly. This involves:

- General guidelines
- Connecting the drain piping to the indoor unit
- Checking for water leaks

### To connect the piping on right side, right-back, or right-bottom



### INFORMATION

The factory default is right-side piping. For left-side piping, remove the piping from the right side and install it on the left side.

- 1 Attach the drain hose with adhesive vinyl tape to the bottom of the refrigerant pipes.
- 2 Wrap the drain hose and the refrigerant pipes together using insulation tape.

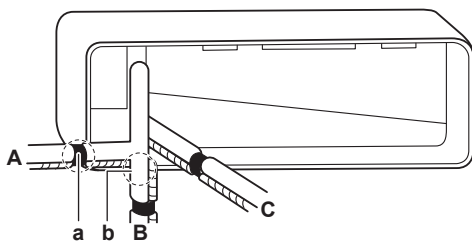

- A Right-side piping
- B Right-bottom piping
- C Right-back piping
- a Remove the pipe port cover here for right-side piping.
- b Remove the pipe port cover here for right-bottom piping.

### To connect the piping on left side, left-back, or left-bottom



### INFORMATION

The factory default is right-side piping. For left-side piping, remove the piping from the right side and install it on the left side.

- 1 Remove the insulation fixing screw on the right side and remove the drain hose.
- 2 Remove the drain plug on the left side and attach it to the right side.



### NOTICE

Do NOT apply lubricating oil (refrigerant oil) to the drain plug when inserting it. The drain plug may deteriorate and cause drain leakage from the plug.

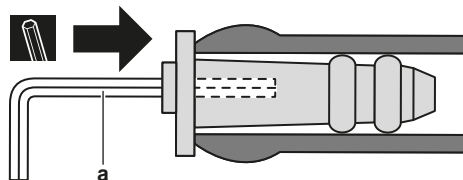

a 4 mm hexagonal wrench

- 3 Insert the drain hose on the left side and do not forget to tighten it with the fixing screw; otherwise water leakage may occur.

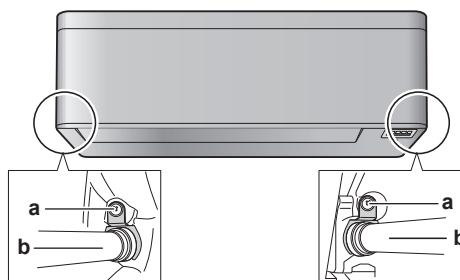

a Insulation fixing screw  
b Drain hose

- 4 Attach the drain hose to the refrigerant pipes bottom side using adhesive vinyl tape.

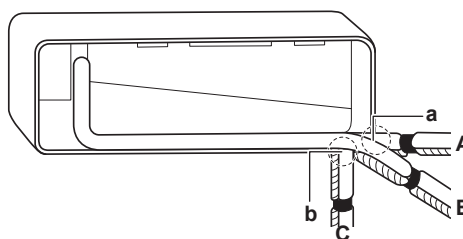

- A Left-side piping
- B Left-back piping
- C Left-bottom piping
- a Remove the pipe port cover here for left-side piping.
- b Remove the pipe port cover here for left-bottom piping.

### To check for water leaks

- 1 Remove the air filters.
- 2 Gradually pour approximately 1 l of water in the drain pan, and check for water leaks.

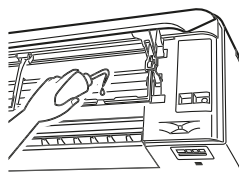

## 5 Installation

### 5.3 Connecting the refrigerant piping



**DANGER: RISK OF BURNING**

#### 5.3.1 To connect the refrigerant piping to the indoor unit

- **Pipe length.** Keep refrigerant piping as short as possible.
- **Flare connections.** Connect refrigerant piping to the unit using flare connections.
- **Insulation.** Insulate the refrigerant piping, interconnection cable and drain hose on the indoor unit as follows:

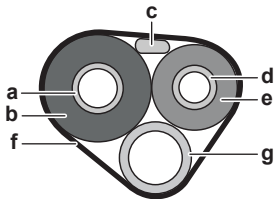

- a Gas pipe
- b Gas pipe insulation
- c Interconnection cable
- d Liquid pipe
- e Liquid pipe insulation
- f Finishing tape
- g Drain hose



#### NOTICE

Make sure to insulate all refrigerant piping. Any exposed piping might cause condensation.

### 5.4 Connecting the electrical wiring



**DANGER: RISK OF ELECTROCUTION**



#### WARNING

ALWAYS use multicore cable for power supply cables.



#### WARNING

If the supply cord is damaged, it MUST be replaced by the manufacturer, its service agent or similarly qualified persons in order to avoid a hazard.



#### WARNING

Do NOT connect the power supply to the indoor unit. This could result in electrical shock or fire.



#### WARNING

- Do NOT use locally purchased electrical parts inside the product.
- Do NOT branch the power supply for the drain pump, etc. from the terminal block. This could result in electrical shock or fire.



#### WARNING

Keep the interconnection wiring away from copper pipes without thermal insulation as such pipes will be very hot.

#### 5.4.1 To connect the electrical wiring on the indoor unit

Electrical work should be carried out in accordance with the installation manual and the national electrical wiring rules or code of practice.

- 1 Set the indoor unit on the mounting plate hooks. Use the "△" marks as a guide.

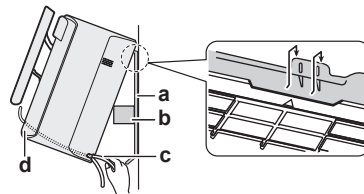

- a Mounting plate (accessory)
- b Piece of packing material
- c Interconnection cable
- d Wire guide



#### INFORMATION

Support the unit using a piece of packing material.

- 2 Open the front panel, and then the service cover. Refer to "5.1 Opening the indoor unit" on page 4.

- 3 Pass the interconnection cable from the outdoor unit through the feed-through wall hole, through the back of the indoor unit and through the front side.

**Note:** In case the interconnection cable was stripped in advance, cover the ends with insulating tape.

- 4 Bend the end of the cable up.



#### NOTICE

- Be sure to keep the power line and transmission line apart from each other. Transmission wiring and power supply wiring may cross, but may NOT run parallel.
- In order to avoid any electrical interference the distance between both wirings should ALWAYS be at least 50 mm.



#### WARNING

Provide adequate measures to prevent that the unit can be used as a shelter by small animals. Small animals that make contact with electrical parts can cause malfunctions, smoke or fire.

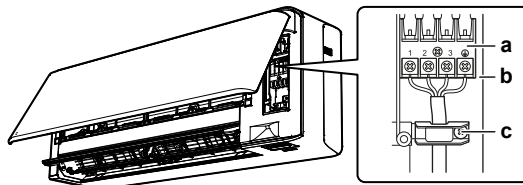

- a Terminal block
- b Electrical component block
- c Wire retainer

- 5 Strip the wire ends approximately 15 mm.
- 6 Match wire colours with terminal numbers on the indoor unit terminal blocks and firmly screw the wires to the corresponding terminals.
- 7 Connect the earth wire to the corresponding terminal.
- 8 Firmly fix the wires with the terminal screws.
- 9 Pull the wires to make sure that they are securely attached, then retain the wires with the wire retainer.
- 10 Shape the wires so that the service cover fits securely, then close the service cover.

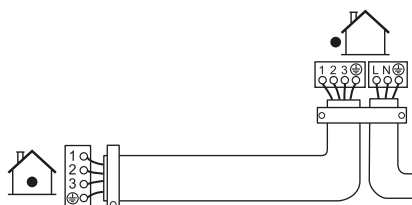

## 5.4.2 To connect optional accessories (wired user interface, central user interface, etc.)

- 1 Remove the electrical wiring box cover (refer to "5.1.7 To remove the electrical wiring box cover" on page 5).
- 2 Attach the connection cable to the S21 connector and pull the wire harness as shown in the following figure.

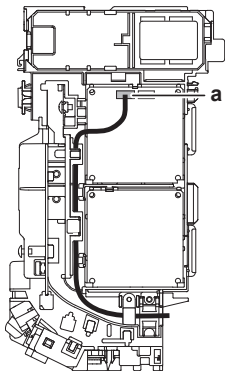

a S21 connector

- 3 Put the electrical wiring box cover back and pull the wire harness around it as shown in the figure above.

## 5.5 Finishing the indoor unit installation

### 5.5.1 To insulate the drain piping, refrigerant piping and interconnection cable

- 1 After the drain piping, refrigerant piping and the electrical wiring are finished. Wrap refrigerant pipes, interconnection cable and drain hose together using insulation tape. Overlap at least half the width of the tape with each turn.

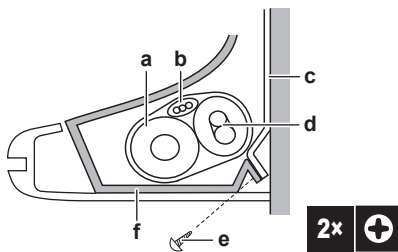

- a Drain hose
- b Interconnection cable
- c Mounting plate (accessory)
- d Refrigerant pipes
- e Indoor unit fixing screw M4x12L (accessory)
- f Bottom frame

### 5.5.2 To pass the pipes through the wall hole

- 1 Shape the refrigerant pipes along the pipe path marking on the mounting plate.

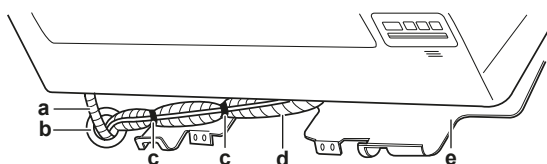

- a Drain hose
- b Caulk this hole with putty or caulking material.
- c Adhesive vinyl tape
- d Insulation tape
- e Mounting plate (accessory)

### NOTICE

- Do NOT bend refrigerant pipes.
- Do NOT push the refrigerant pipes onto the bottom frame or the front grille.

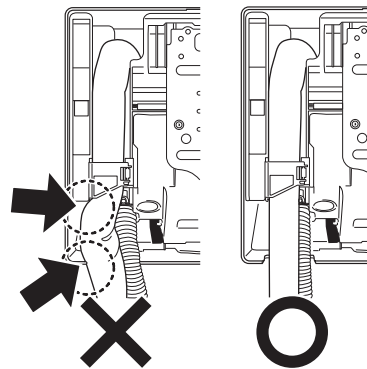

- 2 Pass the drain hose and refrigerant pipes through the wall hole.

### 5.5.3 To fix the unit on the mounting plate

- 1 Set the indoor unit on the mounting plate hooks. Use the "Δ" marks as a guide.

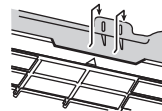

- 2 Press the bottom frame of the unit with both hands to set it on the bottom hooks of the mounting plate. Make sure that the wires do NOT get squeezed anywhere.

**Note:** Take care that the interconnection cable does NOT get caught in the indoor unit.

- 3 Press the bottom edge of the indoor unit with both hands until it is firmly caught by the mounting plate hooks.
- 4 Secure the indoor unit to the mounting plate using 2 indoor unit fixing screws M4x12L (accessory).

## 6 Commissioning

### NOTICE

NEVER operate the unit without thermistors and/or pressure sensors/switches. Burning of the compressor might result.

### 6.1 Checklist before commissioning

Do NOT operate the system before the following checks are OK:

<input type="checkbox"/>	You read the complete installation instructions, as described in the <b>installer reference guide</b> .
<input type="checkbox"/>	The <b>indoor units</b> are properly mounted.
<input type="checkbox"/>	The <b>outdoor unit</b> is properly mounted.
<input type="checkbox"/>	<b>Air inlet/outlet</b> Check that the air inlet and outlet of the unit is NOT obstructed by paper sheets, cardboard, or any other material.
<input type="checkbox"/>	There are <b>NO missing phases</b> or <b>reversed phases</b> .
<input type="checkbox"/>	The <b>refrigerant pipes</b> (gas and liquid) are thermally insulated.

## 6 Commissioning

<input type="checkbox"/>	<b>Drainage</b> Make sure drainage flows smoothly. <b>Possible consequence:</b> Condensate water might drip.
<input type="checkbox"/>	The system is properly <b>earthed</b> and the earth terminals are tightened.
<input type="checkbox"/>	The <b>fuses</b> or locally installed protection devices are installed according to this document, and have NOT been bypassed.
<input type="checkbox"/>	The <b>power supply voltage</b> matches the voltage on the identification label of the unit.
<input type="checkbox"/>	The specified wires are used for the <b>interconnection cable</b> .
<input type="checkbox"/>	The indoor unit receives the signals of the <b>user interface</b> .
<input type="checkbox"/>	There are NO <b>loose connections</b> or damaged electrical components in the switch box.
<input type="checkbox"/>	The <b>insulation resistance</b> of the compressor is OK.
<input type="checkbox"/>	There are NO <b>damaged components</b> or <b>squeezed pipes</b> on the inside of the indoor and outdoor units.
<input type="checkbox"/>	There are NO <b>refrigerant leaks</b> .
<input type="checkbox"/>	The correct pipe size is installed and the <b>pipes</b> are properly insulated.
<input type="checkbox"/>	The <b>stop valves</b> (gas and liquid) on the outdoor unit are fully open.

### 6.2 To perform a test run







**Prerequisite:** Power supply MUST be in the specified range.

**Prerequisite:** Test run may be performed in cooling or heating mode.

**Prerequisite:** Test run should be performed in accordance with the operation manual of the indoor unit to make sure that all functions and parts are working properly.

- 1 In cooling mode, select the lowest programmable temperature.  
In heating mode, select the highest programmable temperature.  
Test run can be disabled if necessary.
- 2 When the test run is finished, set the temperature to a normal level. In cooling mode: 26~28°C, in heating mode: 20~24°C.
- 3 The system stops operating 3 minutes after the unit is turned OFF.

#### 6.2.1 To perform a test run using the user interface

- 1 Press  to switch the system on.
- 2 Press ,  and  simultaneously.
- 3 Press , select **7** and press .















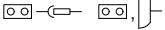

**Result:** Test run operation will stop automatically after about 30 minutes.

- 4 To stop operation sooner, press .

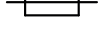
## 7 Technical data

A **subset** of the latest technical data is available on the regional Daikin website (publicly accessible). The **full set** of latest technical data is available on the Daikin extranet (authentication required).

### 7.1 Wiring diagram

Unified Wiring Diagram Legend			
For applied parts and numbering, refer to the wiring diagram on the unit. Part numbering is by Arabic numbers in ascending order for each part and is represented in the overview below by symbol "*" in the part code.			
	: CIRCUIT BREAKER		: PROTECTIVE EARTH
	: CONNECTION		: PROTECTIVE EARTH (SCREW)
	: CONNECTOR		: RECTIFIER
	: EARTH		: RELAY CONNECTOR
	: FIELD WIRING		: SHORT-CIRCUIT CONNECTOR
	: FUSE		: TERMINAL
	: INDOOR UNIT		: TERMINAL STRIP
	: OUTDOOR UNIT		: WIRE CLAMP
BLK : BLACK	GRN : GREEN	PNK : PINK	WHT : WHITE
BLU : BLUE	GRY : GREY	PRP, PPL : PURPLE	YLW : YELLOW
BRN : BROWN	ORG : ORANGE	RED : RED	
A*P	: PRINTED CIRCUIT BOARD	PS	: SWITCHING POWER SUPPLY
BS*	: PUSHBUTTON ON/OFF, OPERATION SWITCH	PTC*	: THERMISTOR PTC
BZ, H*O	: BUZZER	Q*	: INSULATED GATE BIPOLAR TRANSISTOR (IGBT)
C*	: CAPACITOR	Q*DI	: EARTH LEAK CIRCUIT BREAKER
AC*, CN*, E*, HA*, HE*, HL*, HN*, HR*, MR*_A, MR*_B, S*, U, V, W, X*A, K*R_*	: CONNECTION, CONNECTOR	Q*L	: OVERLOAD PROTECTOR
D*, V*D	: DIODE	Q*M	: THERMO SWITCH
DB*	: DIODE BRIDGE	R*	: RESISTOR
DS*	: DIP SWITCH	R*T	: THERMISTOR
E*H	: HEATER	RC	: RECEIVER
F*U, FU* (FOR CHARACTERISTICS, REFER TO PCB INSIDE YOUR UNIT)	: FUSE	S*C	: LIMIT SWITCH
FG*	: CONNECTOR (FRAME GROUND)	S*L	: FLOAT SWITCH
H*	: HARNESS	S*NPH	: PRESSURE SENSOR (HIGH)
H*P, LED*, V*L	: PILOT LAMP, LIGHT EMITTING DIODE	S*NPL	: PRESSURE SENSOR (LOW)
HAP	: LIGHT EMITTING DIODE (SERVICE MONITOR GREEN)	S*PH, HPS*	: PRESSURE SWITCH (HIGH)
HIGH VOLTAGE	: HIGH VOLTAGE	S*PL	: PRESSURE SWITCH (LOW)
IES	: INTELLIGENT EYE SENSOR	S*T	: THERMOSTAT
IPM*	: INTELLIGENT POWER MODULE	S*RH	: HUMIDITY SENSOR
K*R, KCR, KFR, KHuR, K*M	: MAGNETIC RELAY	S*W, SW*	: OPERATION SWITCH
L	: LIVE	SA*, F1S	: SURGE ARRESTOR
L*	: COIL	SR*, WLU	: SIGNAL RECEIVER
L*R	: REACTOR	SS*	: SELECTOR SWITCH
M*	: STEPPER MOTOR	SHEET METAL	: TERMINAL STRIP FIXED PLATE
M*C	: COMPRESSOR MOTOR	T*R	: TRANSFORMER
M*F	: FAN MOTOR	TC, TRC	: TRANSMITTER
M*P	: DRAIN PUMP MOTOR	V*, R*V	: VARISTOR
M*S	: SWING MOTOR	V*R	: DIODE BRIDGE
MR*, MRCW*, MRM*, MRN*	: MAGNETIC RELAY	WRC	: WIRELESS REMOTE CONTROLLER
N	: NEUTRAL	X*	: TERMINAL
n=*, N=*	: NUMBER OF PASSES THROUGH FERRITE CORE	X*M	: TERMINAL STRIP (BLOCK)
PAM	: PULSE-AMPLITUDE MODULATION	Y*E	: ELECTRONIC EXPANSION VALVE COIL
PCB*	: PRINTED CIRCUIT BOARD	Y*R, Y*S	: REVERSING SOLENOID VALVE COIL
PM*	: POWER MODULE	Z*C	: FERRITE CORE
		ZF, Z*F	: NOISE FILTER



Copyright 2017 Daikin

**DAIKIN INDUSTRIES CZECH REPUBLIC s.r.o.**

U Nové Hospody 1/1155, 301 00 Plzeň Skvrňany, Czech Republic

**DAIKIN EUROPE N.V.**

Zandvoordestraat 300, B-8400 Oostende, Belgium

3P482320-7J 2018.06