



---

FH2101

IDEAL FRY



---

**De'Longhi**

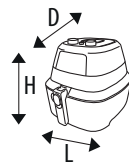
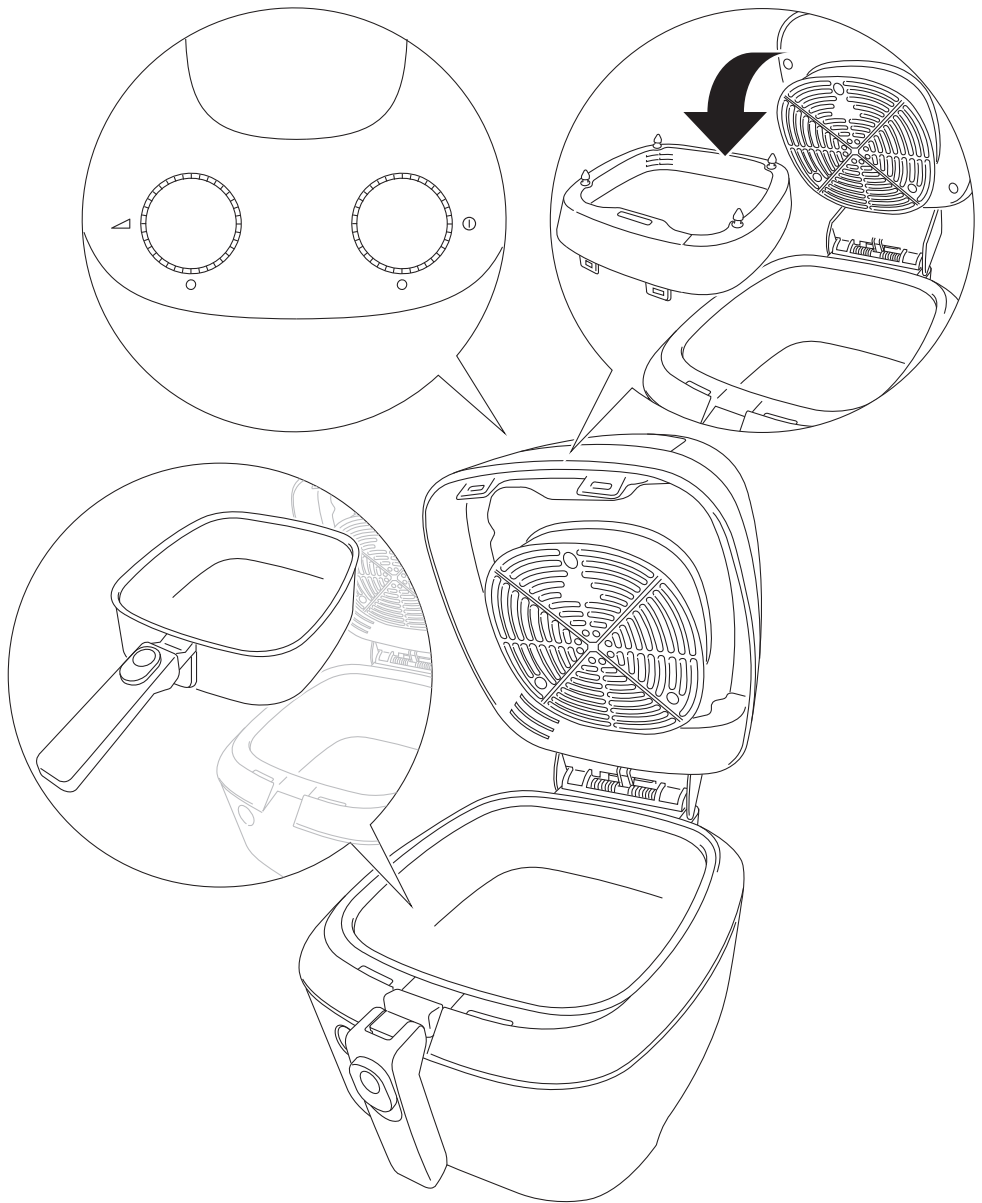

(LxHxD): 290x290x390 mm



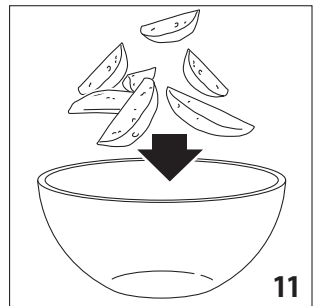
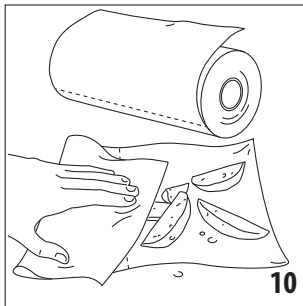
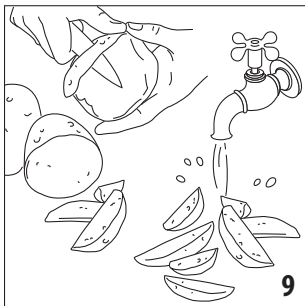
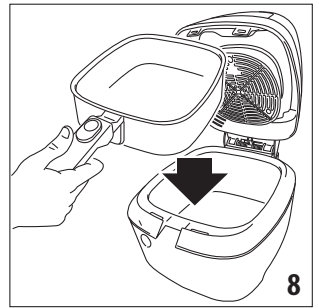
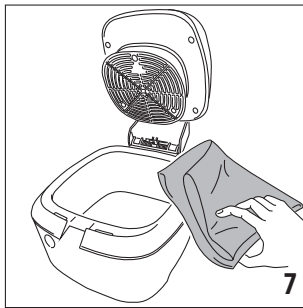
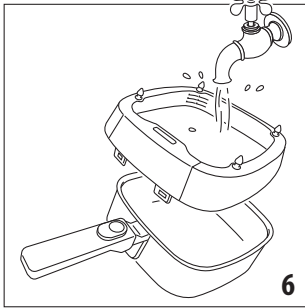
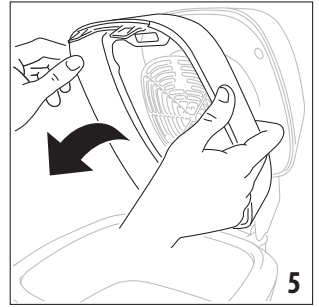
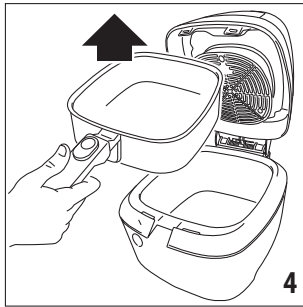
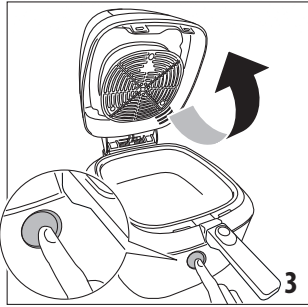
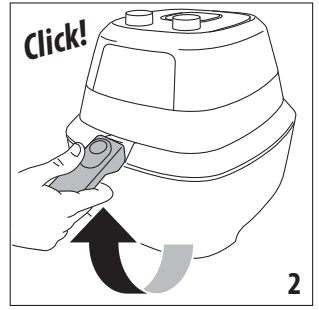
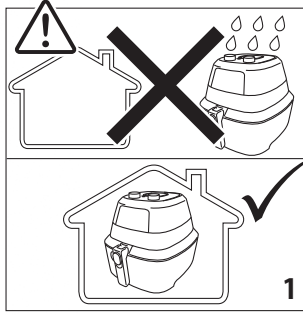

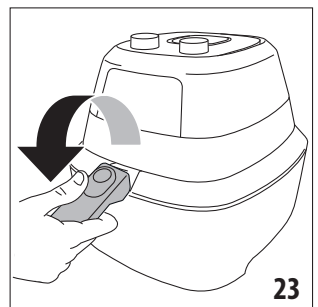
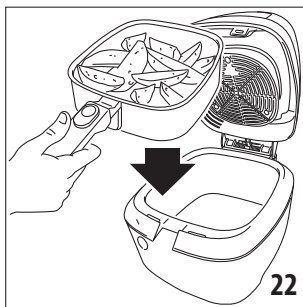
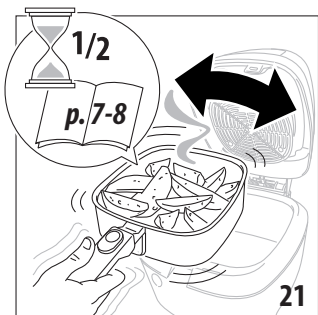
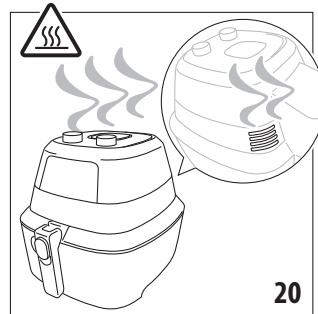
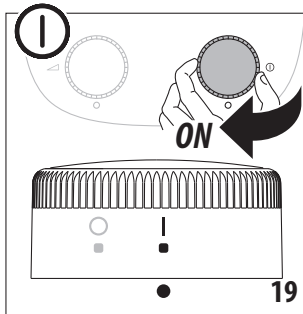
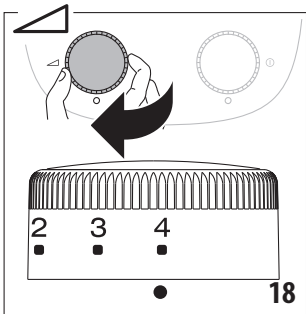
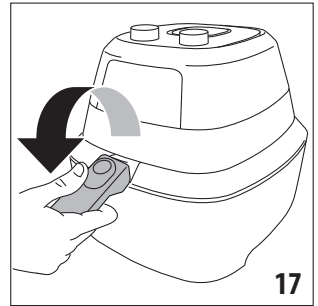
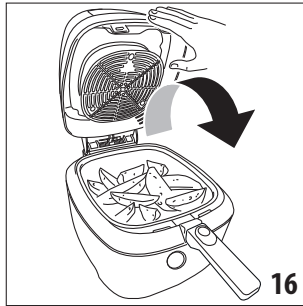
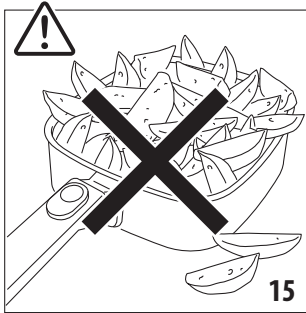
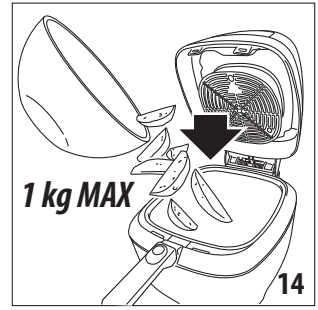
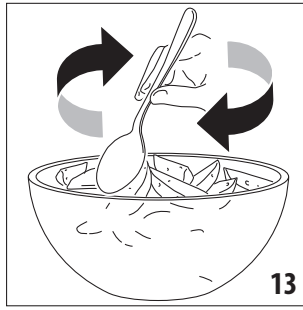
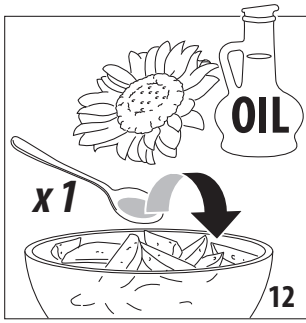

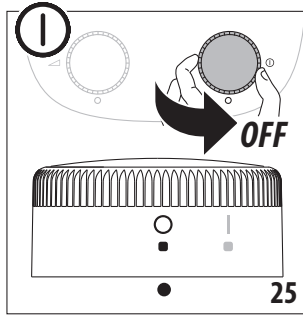
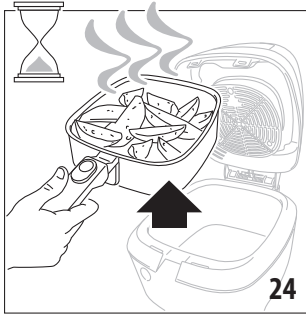

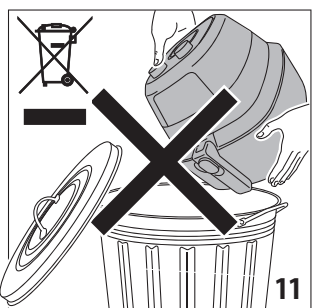
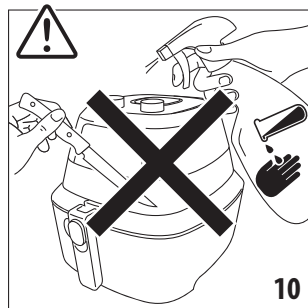
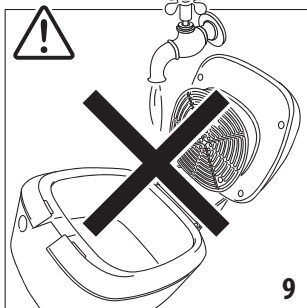
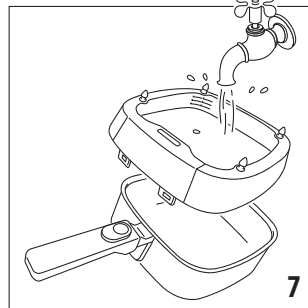
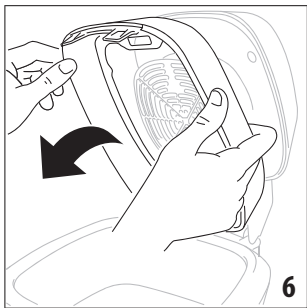
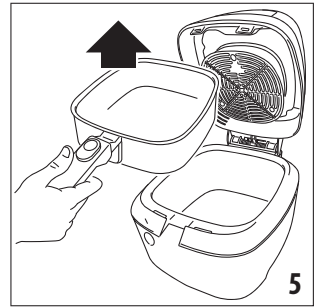
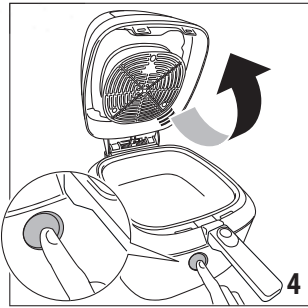
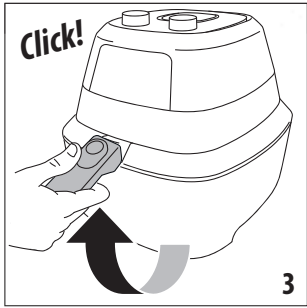
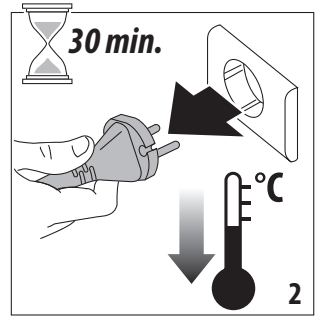
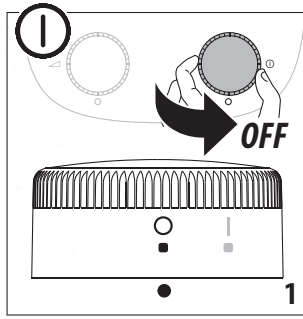

 5 kg

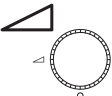
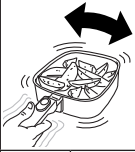



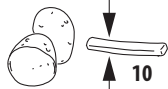
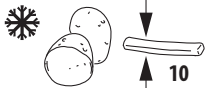
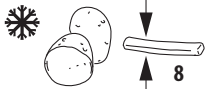











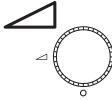

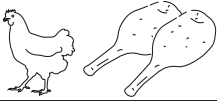







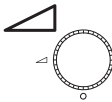

		 min.				
				 		
	1.25 (*)	36-38	4	√	√	1
	1 (*)	30-32	4	√	√	1
	0.75 (*)	26	4	√	√	1/2
	0.5 (*)	19	4	√	√	1/2
	1	33-35	4	√	-	-
	0.75	26-28	4	√	-	-
	0.5	20	4	√	-	-
	0.25	14	4	√	-	-
	1	31-33	4	√	-	-
	0.75	24-26	4	√	-	-
	0.5	18	4	√	-	-
	0.25	12	4	√	-	-
	1.25 (*)	35-40	4	√	-	1
	0.75	30-35	4	√	-	-
	0.6	23-28	4	√	-	-

(\*) da pelare - un-peeled potato weight - à éplucher - ungeschält - te schillen - para pelar - a serem descascadas - για καθάρσιμα - следует очистить - hámozandó - k loupání - je potrebné ich očistiť - do obrania - mą skrelles - skalad - skal skrællés - kuorittuina - neoguljen - olupiti - за белене - pražiti - kabukları soyulmuş - يجب تقشيرها - سيب زميني معمولی -

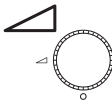

		 min.			
	0.8	45-50	4	√	-
	0.45	18-20	4	√	-
	0.4	13-15	4	√	1
	1.2	55-60	4	√	-

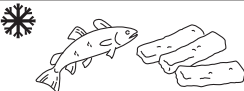
		 min.			
	0.6	20-25	3	√	-
	0.45	15-18	3	√	1

		 min.			
	0.3	17-19	3	√	-
	0.25	14-16	3	√	-
	0.15	12-14	3	√	-