

Proudly distributed by
De'Longhi Australia Pty Limited
P.O. BOX 4540
CASULA MALL NSW 2170
Customer Service Ph: 1800 126 659
Fax: 1800 706932
www.delonghi.com.au
e-mail: info.au@delonghigroup.com

De'Longhi New Zealand Limited
99 Khyber Pass Road
Grafton 1023
Auckland, New Zealand
P.O. Box 58-056 Botany
MANUKAU 2163
Customer Service Ph: 0508 200 300
Fax: 0508 200 301
www.delonghi.co.nz
e-mail: info.nz@delonghigroup.com

Register Now 
www.delonghi.com/register

HX Series

CONVECTOR Instructions for use



The DeLonghi logo is displayed in a white oval with a black border, containing the brand name 'DeLonghi' in a bold, black, sans-serif font.

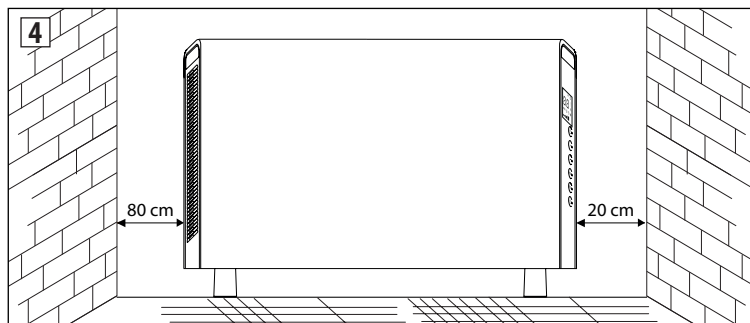
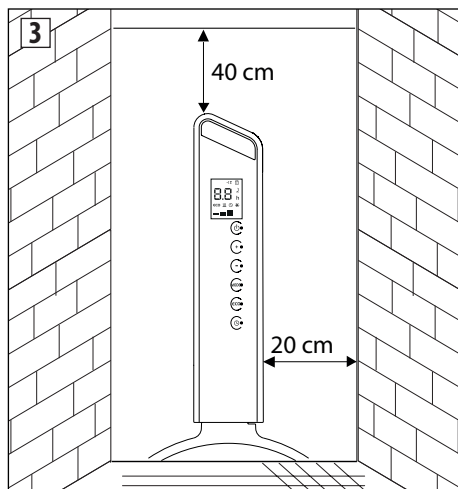
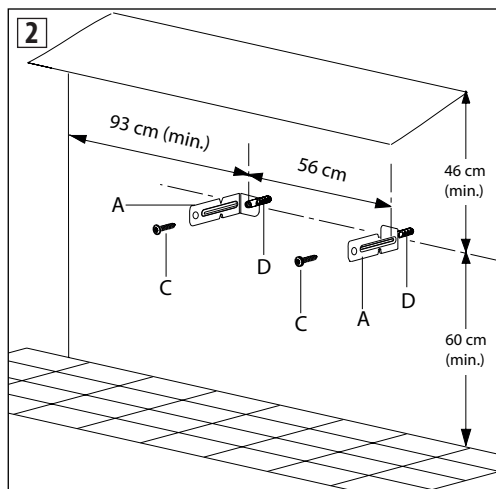
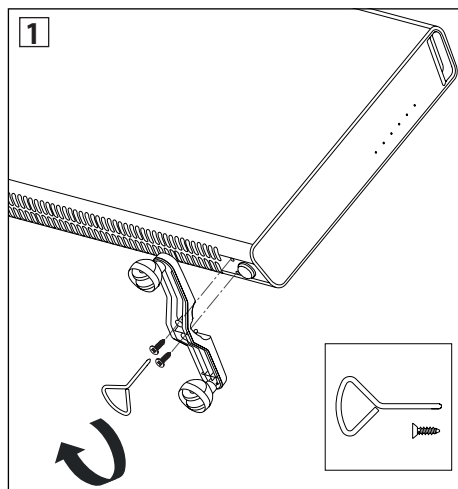
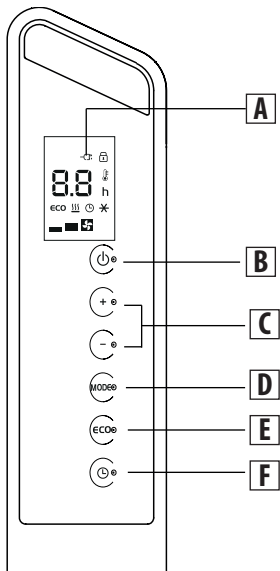

IMPORTANT WARNINGS

Safety warnings



Danger!

Failure to observe the warning may result in life threatening injury by electric shock.

- When the heater is used with feet do not use in the vicinity of bathtubs, wash basins, showers, sinks and swimming pools.
- If you intend to fix your appliance to the wall, make sure that the switch or other control devices are not within reach of persons in the bath or shower.
- If the power cable has been damaged, it must be replaced by the manufacturer or the technical service centre or by a qualified person so as to avoid all risks.



Important!

Failure to observe the warning could result in injury or damage to the appliance.

- This appliance can be used by children aged from 8 years and above and persons with reduced physical, sensory or mental capabilities or lack of experience and knowledge if they have been given supervision or instruction concerning use of the appliance in a safe way and understand the hazards involved. Children shall not play with the appliance. Cleaning and user maintenance shall not be made by children without supervision.
- Children of less than 3 years should be kept away unless continuously supervised.
- Children aged from 3 years and less than 8 years shall only switch on/off the appliance provided that it has been placed or installed in its intended normal operating position and they have been given supervision or instruction

concerning use of the appliance in a safe way and understand the hazards involved. Children aged from 3 years and less than 8 years shall not plug in, regulate and clean the appliance or perform user maintenance.

- The appliance must not be located immediately below a fixed socket-outlet.
- **ATTENTION:** in order to avoid any danger caused by an accidental resetting of the safety system, this appliance must not be powered through an external timer.
- Do not use the appliance in small rooms when they are occupied by persons that are not capable of leaving the room, unless constant supervision is provided.
- The appliance shall, under no circumstances, be covered with insulating material or similar material.
- Never place the power cable on top of the heater while it is hot.



Danger of burns!!

Failure to observe the warning could result in burns or scalds.

- **CAUTION** Some parts of this product can become very hot and cause burns. Particular attention has to be given where children and vulnerable people are present.
- **WARNING:** In order to avoid overheating, never under  any circumstances cover the appliances during operation, as this would lead to dangerous overheating.
- The use of an extension lead is not recommended, as overheating of the extension lead may occur during the operation of the heater.



Please note:

This symbol indicates recommendations and important information for the user.

- Never use the heater to dry laundry.
- We recommend that you not place the heater in a draught,

because strong draughts of air may adversely affect the equipment's operational efficiency.

- Only use the heater in an upright position.
- Use the appliance only on a stable and flat floor.
- The heater must be positioned at least 80cm from furniture or other objects (see fig. 3-4).
- The first time you use the appliance, operate it of at least 15 minutes with the thermostat at maximum to eliminate the "new" smell. A little smoke due to the protective substances applied to the heating element before transport may be given off, for this reason we suggest you ventilate the room during this operation.
- Do not position the appliance on long hair carpets, in order to avoid obstruction to the air intake grille located under it.
- Do not obstruct the hot air outlet grilles or the air intake grille on the bottom of the appliance.
- Position the appliance so that the plug and the outlet can be easily reached even after installation.
- Do not use the appliance in rooms less than 4m² in area.
- A tip over safety device turns the appliance off if it falls over or is positioned inappropriately in such a way as to jeopardise safety. The appliance emits a beep and a dot flashes on the display. The appliance resumes operation a few seconds after being placed in an upright position again. See troubleshooting session.
- The appliance is fitted with a safety device which will switch the appliance off in case of accidental overheating. To reset, disconnect the plug from the power socket for a few minutes, remove the cause of overheating then plug the appliance in again. If this abnormal situation happens several times, please contact the customer service.
- For appliances provided with fans, means for ventilation or ducting are provided in accordance with the installation instructions.

DESCRIPTION

- A** Power indicator light
- B** ON/STAND-BY button
- C** +/- adjustment buttons
- D** MODE button (selects the operating mode)
- E** "ECO plus" button
- F** Timer button

Fundamental recommendations regarding safety

Dear Customer – The plug on this appliance will get 'warm' during use, this is perfectly normal.

This product is A HIGH POWER HEATING APPLIANCE designed to our usual high standards but please make sure your wall

sockets are in good condition and the plug is inserted correctly to avoid any accidental overheating. We suggest that you check the plug AND THE SOCKET regularly if the heater is in prolonged use, if you are in any doubt please consult an electrician.

General instructions

Remove the heater from the packaging. Check that neither the heater nor the power cable has been damaged during transport. Do not operate the heater if damaged. Remove all publicity material present on the appliance. The appliance is suitable for free-standing or wall-mounted usage. Do not assemble the feet if wall-mounted.

Electrical connection

- Before connecting the appliance to the current outlet, check that the voltage indicated on the appliance rating plate is the same as your electric plant and that it can stand the power consumption (Watt) indicated by the labelling.
- If more than one appliance is used at once, it is important to ensure that the electric plant is able to support the power required.

Mounting the feet

Turn the appliance upside down on a rug or soft surface in order to prevent damaging the paint finish.
Fix the feet to the appliance with the nr. 4 screws supplied  (see fig. 1), 2 screws for each foot.

Wall-Mounting Installation

The wall mounting kit contains:
4 metal brackets (**Fig. 2 A**)
2 screws 4,8x13 PH (**Fig. 2 B**)
4 screws 4,5x25 PH (**Fig. 2 C**)
4 plastic anchors 6x30 (**Fig. 2 D**)



Required tools for assembly and estimated assembly time

Screwdriver PH 2 x 100 (Phillips type supplied) 
Estimated assembly time: 30 minutes

Before installing the unit, make sure of the following:

- The appliance must not be located directly beneath a current outlet.**
- The plug and outlet must be easy to reach after installation.**
- No electric cables or other pipes could be damaged during the installation.**
- Keep away from curtains or flammable materials.**



To wall-mount, proceed as follows:

Turn the appliance upside down on a flat stable surface. Using a screwdriver, fix the 2 brackets **A** with the 2 screws **B** as shown in Fig. 2. For brick walls use a 6 mm concrete drill bit. For plaster board or false (hollow) walls, it is recommended to use appropriate screws and anchors (not supplied).

1. Before drilling the wall, mark the exact points, respecting the minimum distances as shown in fig. 2.
2. Drill the wall where previously marked, and insert the plastic anchors **D**.
3. Fix the 2 metal brackets **A** using the two screws **C** provided.
4. Hang the appliance on the bracket.
5. Mark out the 2 lower fixing points. Remove the appliance, drill the lower holes and insert the wall anchors **D**.
6. Now, you can hang back the heater on the bracket and fix the lower part of the appliance with the 2 remaining screws **C**.

USE

Operation and use

- Plug into the mains socket.
- The appliance emits a beep. The indicator light comes on and remains lit while the appliance is powered.
- The appliance switches to stand-by.
- Press the ON/STAND-BY to turn the appliance on. It begins heating the room according to the current settings.
- Press the MODE button to select one of the following operating modes:
 - **Freeze prevention** ✱
 - **Heating 1** 
 - **Heating 2** 
 - **Heating 3 + Fan** 



Please note: after an interruption of power supply (power failure or appliance unplugged) the unit goes always to stand-by.



Please note: in order to avoid peaks of power absorption, with room temperature below -5°C the appliance will operate automatically at power level 2 even if power level 3 has been selected. Once the room temperature is higher than -5°C , the appliance will operate at the selected power level.



Freeze prevention ✱

In this mode, the appliance keeps the room at a temperature of 7°C to avoid freezing.

Heating 1, 2, and 3 + Fan

In this mode, the desired temperature can be selected by

pressing the adjustment buttons + and -. By pushing the + or - button once, the temperature (shown on the display) will increase or decrease by 1°C .

- **Heating 1** 
The appliance operates at low power.
- **Heating 2** 
The appliance operates at medium power.
- **Heating 3 + Fan** 
The appliance operates at the maximum power with the fan. The setting temperature range available is from 16°C to 32°C .

“ECO plus” function

The “ECO plus” function is available in Heating 1, 2 and 3 + fan modes only.

To activate the function, press the “ECO plus” button (E).

When this function is active the appliance automatically sets the most appropriate power level to guarantee optimum comfort while reducing energy consumption.

While the “ECO plus” function is active, the appliance may switch automatically to a lower heating power than the one displayed. The working indicator colour could change.

Working indicator

The symbol  indicates the heating status by means of its colors.

 **RED:** the unit is heating at the maximum power.

 **YELLOW:** the unit is heating at the medium power.

 **GREEN:** the unit is heating at the minimum power.

 **absent:** the unit is not heating.

Brightness of the display

The appliance allows two different brightness settings for the display. The highest is active when any key button is pressed.

After a few seconds of keyboard inactivity, the brightness will decrease to the operating brightness level.



Key lock

In order to avoid accidental operation, you can lock the keyboard using the keylock function.

To activate this function during on mode press buttons + and - together for at least 3 seconds. The display shows the symbol  and a double acoustic signal will be emitted. To deactivate the function proceed in the same way.

Timer function

This function can be activated in two different ways.

Delayed start: With the appliance on-standby, press the timer button . The  symbol is displayed flashing together with

the hours left before the appliance comes on. Change the hours using the + and - buttons, then wait a few seconds for the program to be stored. The display will return to off and the ⌚ symbol remains on. When the programmed time has elapsed, the appliance will come on with the previous settings.



Delayed stop: with the appliance on, press the timer button ⌚. The ⌚ symbol is displayed flashing together with the hours left before the appliance goes on-standby. Change the hours using the + and - buttons, then wait a few seconds for the program to be stored. The current settings and ⌚ symbol are displayed. At the end of the set time the appliance switches on-standby automatically. To go back to operating without the timer, press the timer button twice. The timer symbol ⌚ disappears from the display.

i Please note: the time is settable from 0.5 to 24 hours.

Changing of the temperature scale

The display can show the temperature in both °F (Fahrenheit) and °C (Celsius). To select the desired temperature scale, when the unit is in standby position, press and hold the "+" key for at least 10 seconds, then release.

The change of scale will be indicated by two short beeps.

MAINTENANCE

Before carrying out any maintenance, unplug the heater from the mains and wait for it to cool off completely.

This heater requires no particular maintenance. It is sufficient to remove the dust with a soft, dry cloth. Never use abrasive powders or solvents. If necessary remove concentrated areas of dirt with a vacuum cleaner. Please refer to the enclosed guarantee leaflet for service and assistance details.

TECHNICAL CHARACTERISTICS

Supply voltage	See rating label
Absorbed power	"

TROUBLESHOOTING

PROBLEM	CAUSE	SOLUTION
The appliance doesn't work	Be sure it is plugged in and that the electrical outlet is working The temperature may be set too low The Key lock may be activated The timer is not correctly programmed	Plug into the power outlet Set the temperature higher See the section "Key lock" Program the timer correctly
The display shows a blinking dot and you hear an intermitten "beep"	The appliance could have been tipped over or is positioned in an improper way	Make sure the appliance is standing upright on a flat surface. Position the appliance correctly
The display shows "P.F"	The temperature sensor is malfunctioning	Contact De'Longhi Customer Experience
The display shows "H.t" blinking (the appliance switch off)	The internal temperature is too high	Unplug from the mains. Let the appliance cool down Check the air intake or outlet grille are not obstructed and the appliance is correctly positioned respecting the minum distances from the wall, or other objects, as indicated in Fig. 2 After few minutes plug in the appliance again, the unit goes always to stand-by