



Questo manuale d'istruzione è fornito da trovaprezzi.it. Scopri tutte le offerte per [Dell Alienware AW2725QF](#) o cerca il tuo prodotto tra le [migliori offerte di Monitor](#)

# **Alienware AW2725QF Monitor**

## Simplified Service Manual

Version: 01

Date: 2024/07/24

## 1. Important Safety Notice

### Product Announcement:

This product is certificated to meet RoHS Directive and Lead-Free produced definition. Using approved critical components only is recommended when the situation to replace defective parts. Vender assumes no liability express or implied, arising out of any unauthorized modification of design or replacing non-RoHS parts. Service providers assume all liability.

### Qualified Repairability:

Proper service and repair is important to the safe, reliable operation of all series products. The service providers recommended by vender should be aware of notices listed in this service manual in order to minimize the risk of personal injury when perform service procedures. Furthermore, the possible existed improper repairing method may damage equipment or products. It is recommended that service engineers should have repairing knowledge, experience, as well as appropriate product training per new model before performing the service procedures.

### NOTICE:

! To avoid electrical shocks, the products should be connected to an authorized power cord, and turn off the master power switch each time before removing the AC power cord.

! To prevent the product away from water or expose in extremely high humidity environment.

! To ensure the continued reliability of this product, use only original manufacturer's specified parts.

! To ensure following safety repairing behavior, put

! To ensure using a proper screwdriver, follow the torque and force listed in assembly and disassembly procedures to unscrew screws.

! Using Lead-Free solder to well mounted the parts.

! The fusion point of Lead-Free solder requested in the degree of 220°C.

## 2. Exploded view diagram with list of items

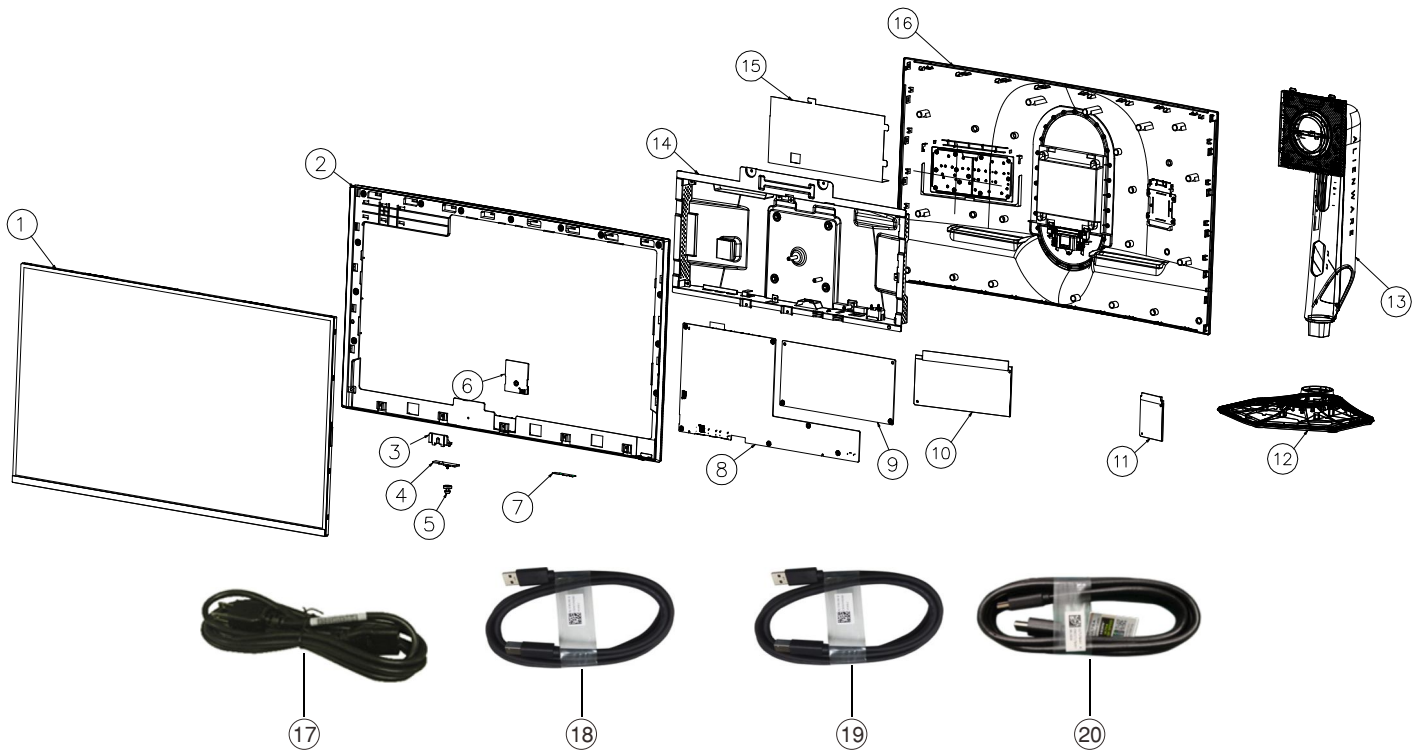

**Figure 1. Major components**

Item	Description	Q'ty	Remark
1	Panel	1	
2	Middle frame	1	
3	Joystick board holder	1	
4	Joystick board	1	
5	Joystick	1	
6	USB board	1	
7	Power key board	1	
8	Interface board Base	1	
9	Power board Stand	1	Only for EMEA regions
10	27 logo optic module	1	
11	Head logo optic module	1	
12	Base assy		
13	Riser assy	1	
14	Main chassis	1	
15	Safety Mylar	1	
16	Back cover		
17	Power cable	1	Refer the below note
18	USB 3.2 Gen1 (5 Gbps) A to B cable (1.80 m)	1	Refer the below note
19	DisplayPort 1.4 cable (1.80 m)	1	Refer the below note
20	HDMI 2.1 FRL cable (1.80 m)	1	Refer the below note

### NOTE:

For replacement of power cord, connectivity cable and external power supply (if applicable), contact Dell:

To contact Dell for sales, technical support, or customer service issues, see [www.dell.com/contactdell](http://www.dell.com/contactdell).

**NOTE:** Availability varies by country or region and product, and some services may not be available in your country/region.

**NOTE:** If you do not have an active Internet connection, you can find contact information about your purchase invoice, packing slip, bill, or Dell product catalog.

### 3. Wiring Connectivity Diagram

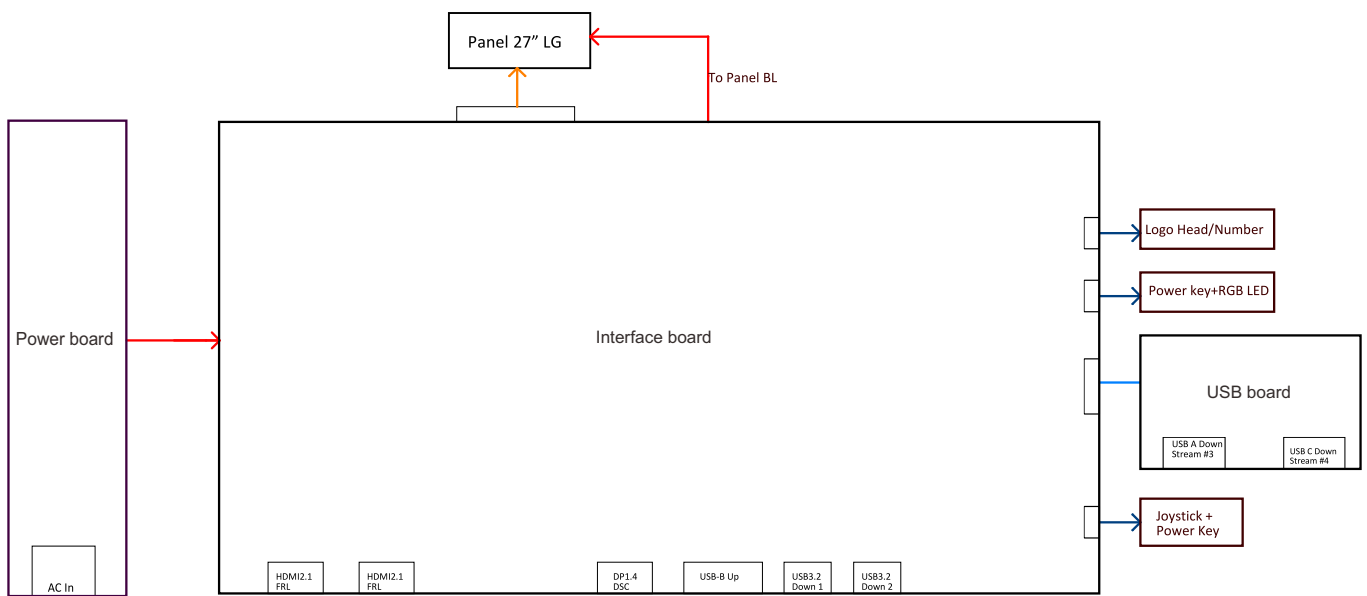

**Figure 2.** Wiring Connectivity Diagram

## 4. How to connect and disconnect power cable/ connectivity cable

**WARNING:** To change power cable/ connectivity cable, switch off power before unplugging the cable and replugging in required cable.



**Figure 3.** Turn off the monitor

### Connecting the DisplayPort cable

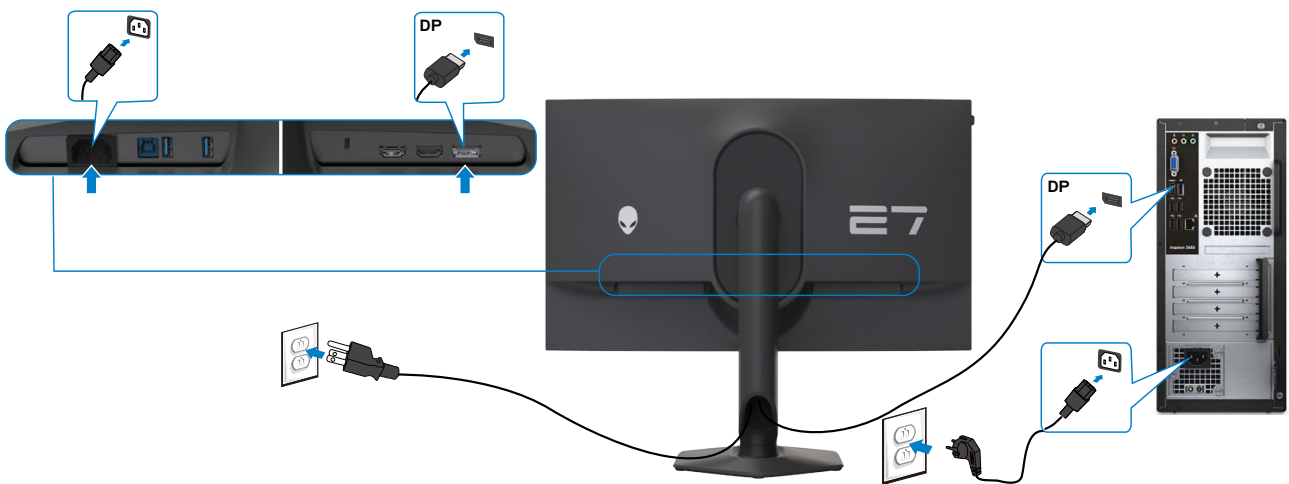

**Figure 4.** Connecting the DisplayPort cable

### Connecting the HDMI cable

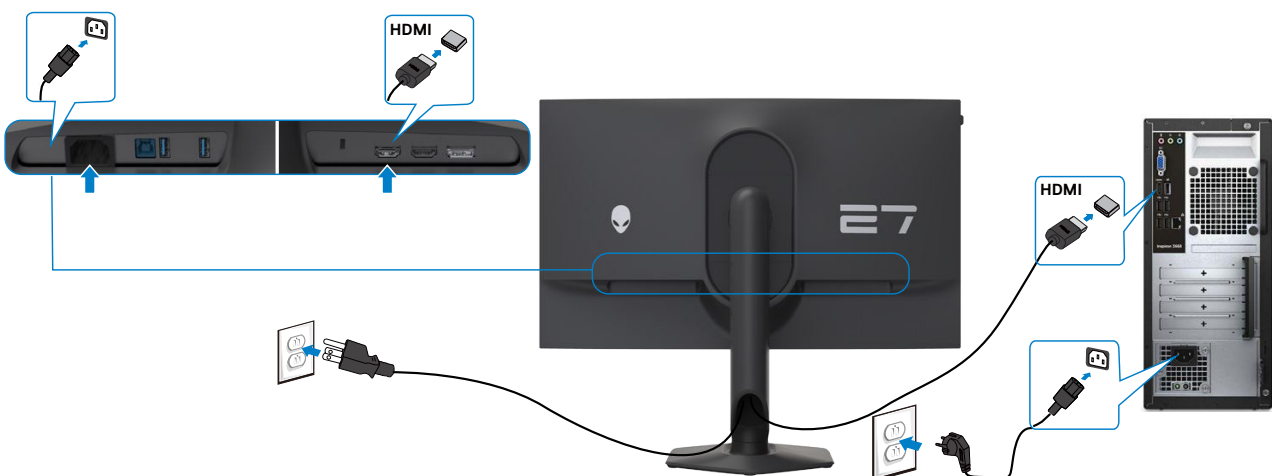

**Figure 5.** Connecting the HDMI cable

## 4. How to connect and disconnect power cable/ connectivity cable

### Connecting the USB cable

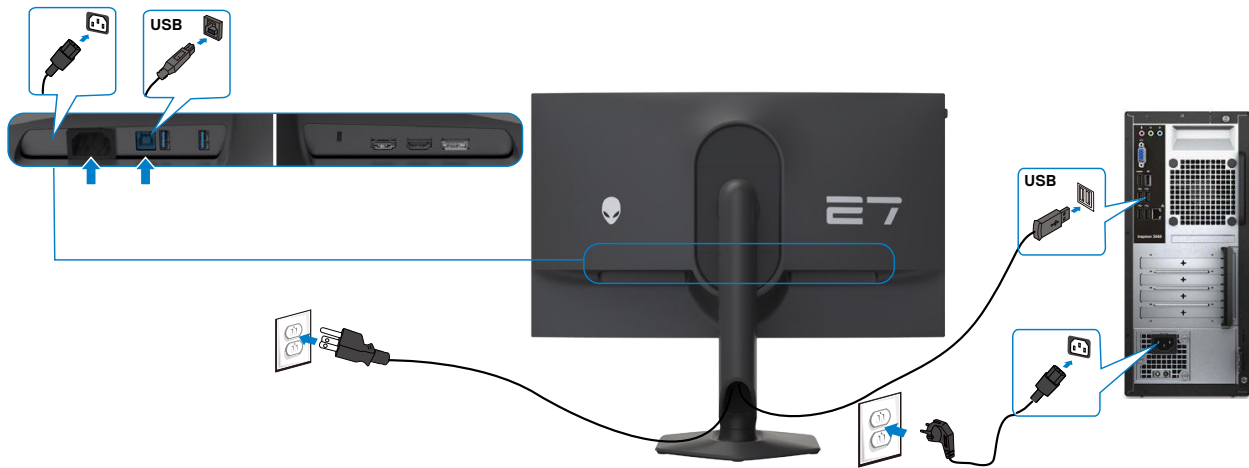

**Figure 6.** Connecting the USB cable

## 5. Disassembly and Assembly Procedures

### NOTE:

The removal and installation procedure are applicable only for the EMEA region. Dell deems the warranty void if any removal is done on the monitors.

### List of tools/equipment:

1. Philips-head screwdriver
2. Electric screwdriver

### Disassembly Procedures:

S1

Removing the monitor stand.

- a. Place the monitor on a soft cloth or cushion.
- b. Press and hold the stand-release button.
- c. Lift the stand up and away from the monitor.

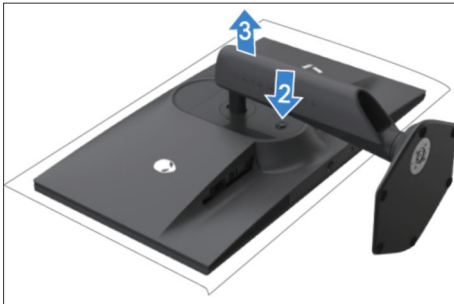

S2

Loose the display back cover.

- a. Remove the 4 screws (M4x11).
- b. Pull up the back cover by hand in the sequence of "1 -> 2 -> 3 -> 4" to loosen it from the panel.

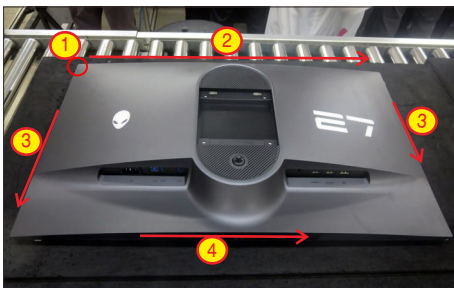
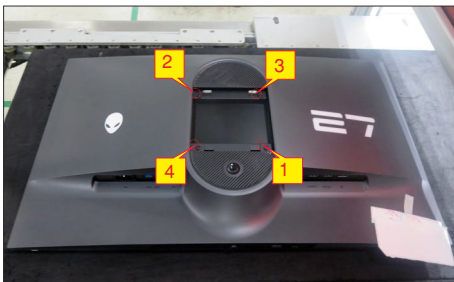

S3

Remove the display back cover.

- a. Lift up the display back cover and disconnect the light bar cable.
- b. Peel the tape and remove the rear cover.

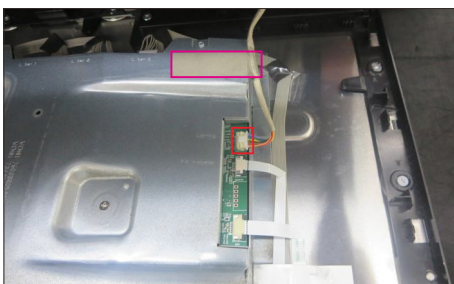

S4

Remove the light bar PCBA from the back cover.

- a. Place the back cover on a soft cloth or cushion.
- b. Peel all the tape and mylar.
- c. Release the two light bar from the hooks.
- d. Remove the 4 screws (M2x3.8)

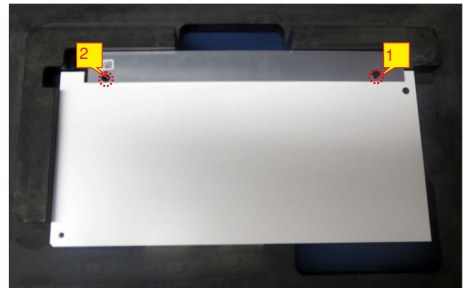
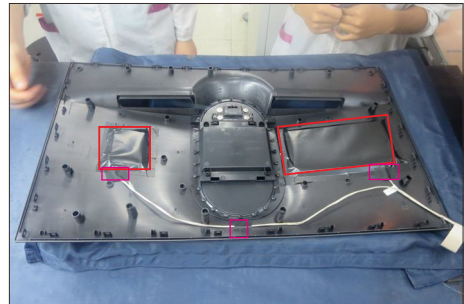

S5

Remove the USB PCBA.

- a. Peel the aluminum foil.
- b. Remove 1 screw (M3x6).
- c. Pull out FFC cable from the connectors.

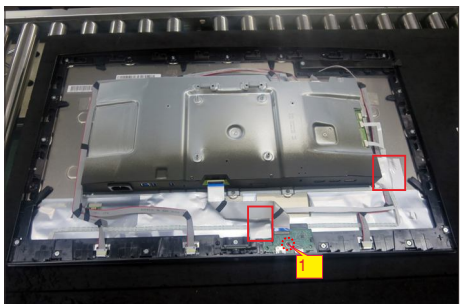

## 5. Disassembly and Assembly Procedures

S6

Remove the joystick board.

- Remove 1 screw (M3x6).
- Peel the tape.
- Pull out key cable from the connector.

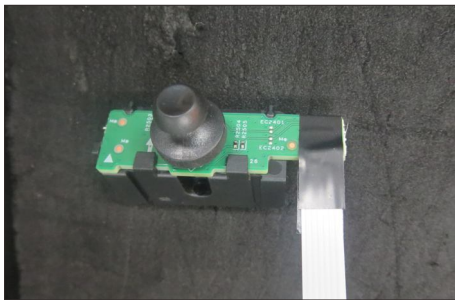
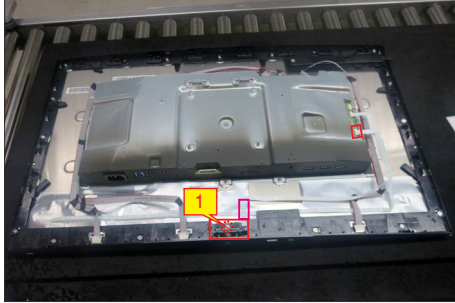

S9

Remove power key board.

- Peel the mylar tape.
- Remove 2 screws (M2x2.4).
- Remove the power keypad from the front cover.

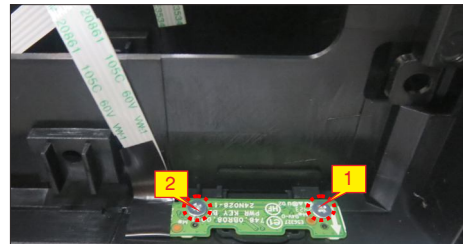

S7

Remove the lamp cable.

- Peel transparent tape and aluminum foil.
- Disconnect lamp cables from panel.

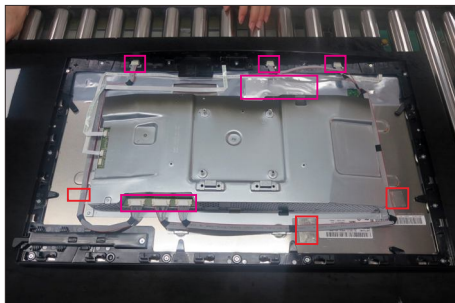

S10

Remove chassis screw and Disconnect eDP cables.

- Remove 4 screws (M3x4) that secure the main chassis.
- Open the latch.
- Disconnect the two eDP cables from panel.

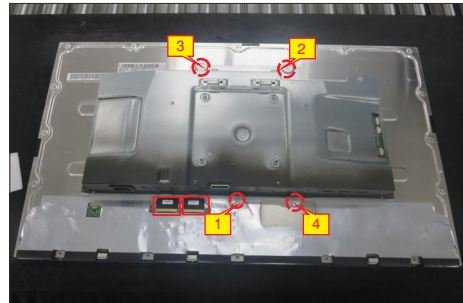

S8

Remove middle frame.

- Remove 16 screws (M3x5).
- Peel tape and disconnect the power key cable.

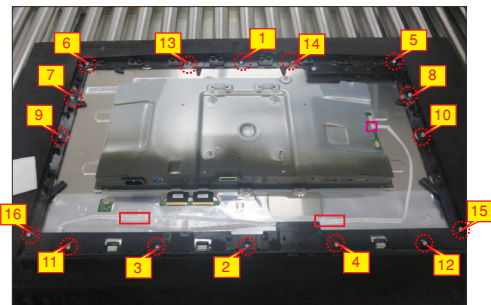

S11

Remove main chassis and display panel.

- Lift up the main chassis and put it on a cushion.
- Lift up the display panel and put it on a cushion.



## 5. Disassembly and Assembly Procedures



S12 Remove the Mylar sheet.

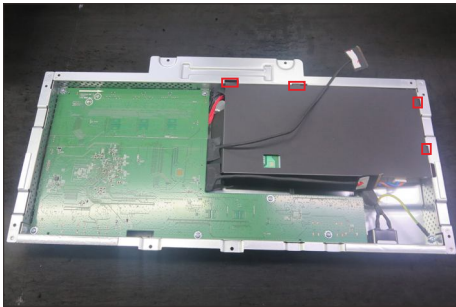

Remove PCBA (interface board and power board).

- S13
- Remove 1 ground screw (M4x8).
  - Remove 9 screws (M3x6).
  - Disconnect all the cables.

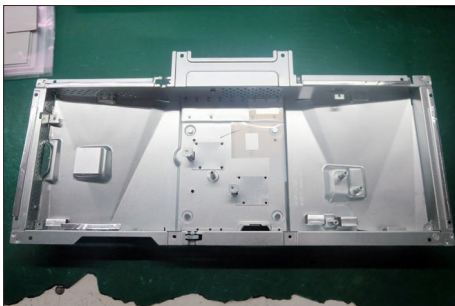
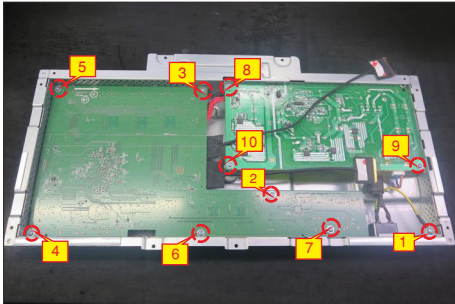

## 5. Disassembly and Assembly Procedures

### 5.2 Assembly Procedures:

**S1** Paste 1 silicon sheet on the main chassis.

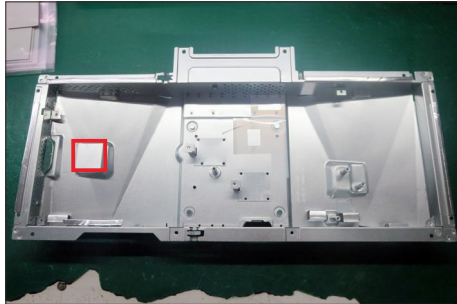

Assemble AC outlet power board to the main chassis.

- S2**
- Assemble AC outlet to the main chassis.
  - Lock 1 ground screw (M4x8).
  - Lock 3 screws (M3x6).
  - Connect the cable of AC outlet to the power

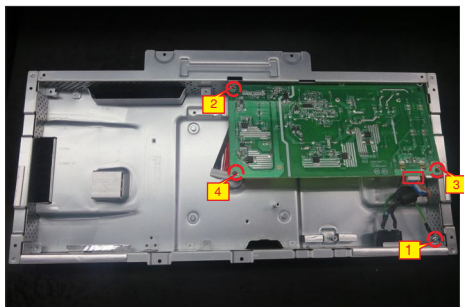

Assemble interface board to the chassis.

- Connect all cables to the interface board.
- Lock 6 screws (M3x6).

**S3**

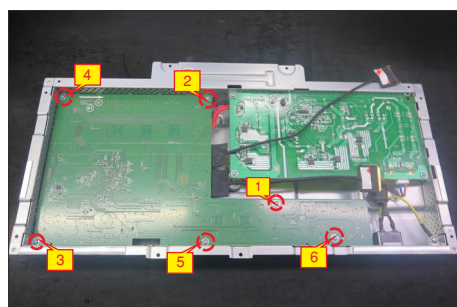
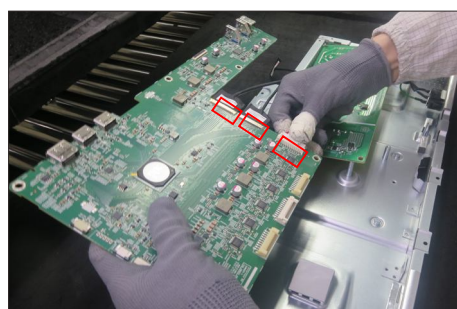

**S4** Insert mylar sheet to the chassis.

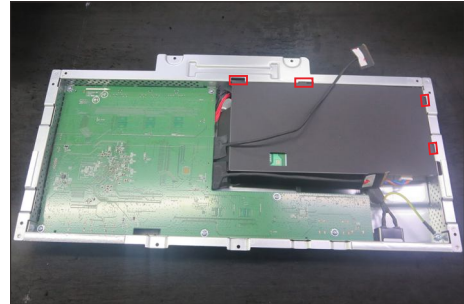

Connect eDP cable to display panel.

- S5**
- Place display panel faced down on a cushion.
  - Put the main chassis on the back of the panel.
  - Plug the eDP cable to display panel.



Assemble main chassis to display panel.

- S6**
- Turn over and adjust the main chassis.
  - Lock 4 screws (M3x5).

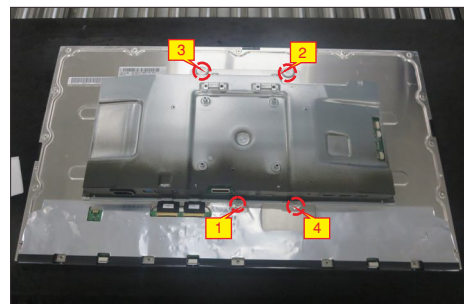

## 5. Disassembly and Assembly Procedures

S7

- Lock power keypad PCBA to middle frame.  
 a. Lock 2 screws (M2x2.4).  
 b. Paste mylar tape on the keypad PCBA.

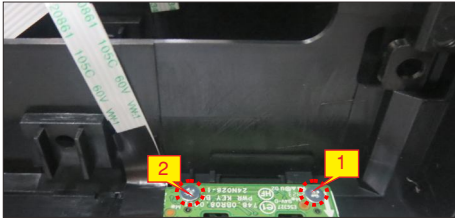

S8

- Connect the power keypad cable to the PCBA.  
 a. Assemble middle frame with display panel.  
 b. Plug the power keypad cable to the connector.  
 c. Fix the cable on the back of panel by tape.



S9

- Plug the lamp cables to connect PCBA with panel.

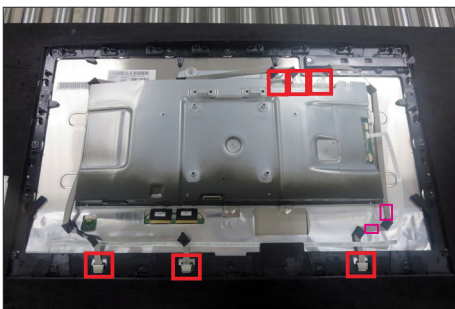

S10

- Lock the middle frame with display panel.  
 a. Lock 16 screws (M3x5).  
 b. Fix the lamp cables on the back of panel by tapes.

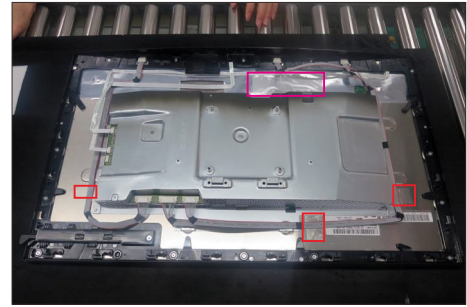
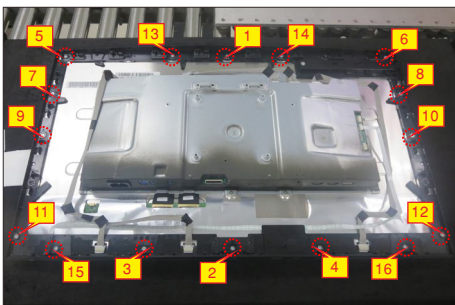

S11

- Lock joystick board and holder to middle frame.  
 a. Assemble the joystick board with the holder.  
 b. Lock 1 screws (M3x6).  
 c. Connect the key cable to PCBA.

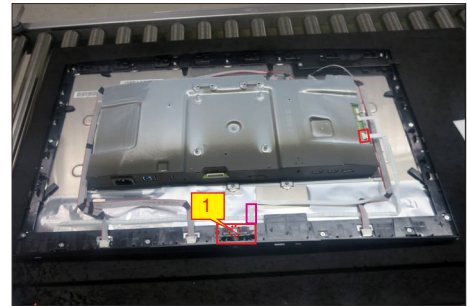
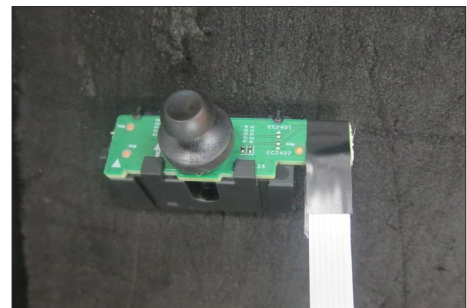

S12

- Lock USB board to the middle frame.  
 a. Lock 1 screws (M3x6).  
 b. Connect the FFC cable to PCBA.  
 c. Paste 2 AL tape to fix the cable.

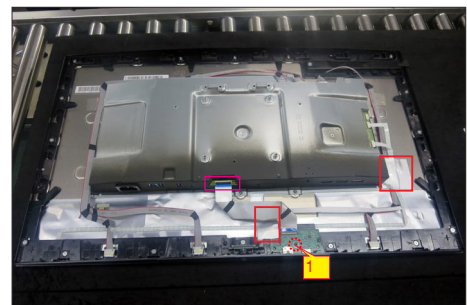
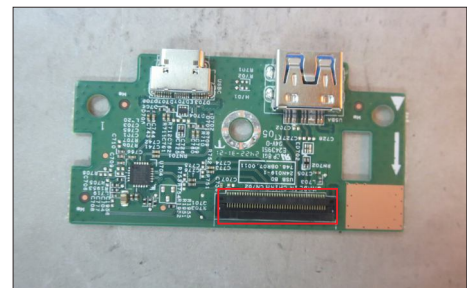

## 5. Disassembly and Assembly Procedures

Assemble 2 light bar PCBA to a display back cover.

S13

- Peel the paper of the light bar.
- Paste the LGP to light bar.
- Lock 4 (M2x3.8) screws.
- Plug the cable to the connectors of the light bar.
- Cover the light bar unit with mylar tape.
- Fix the cables with acetate tape.

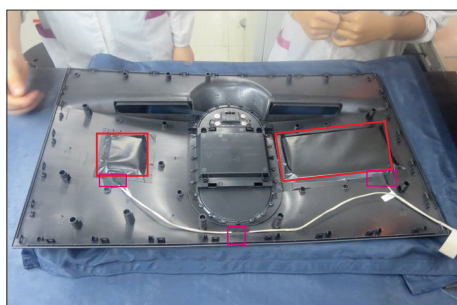
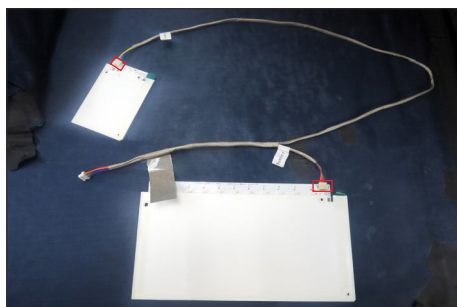
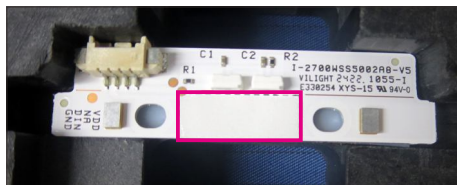
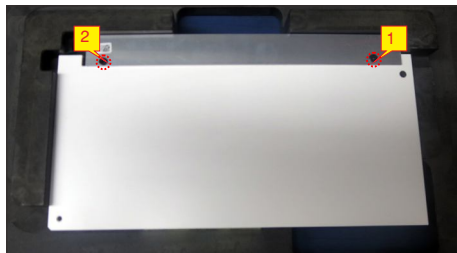
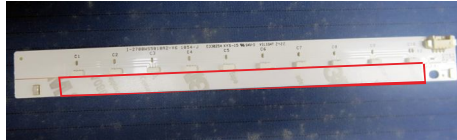

Connect light bar cable to PCBA.

S14

- Lower the backcover and connect the light bar to the connector.
- Paste the cable tape on the main chassis.

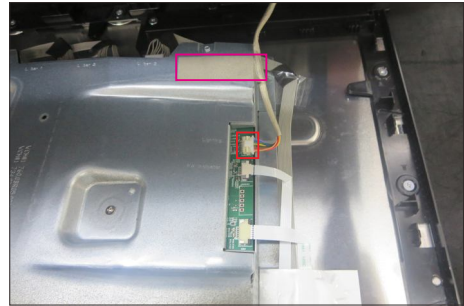

Lock the display back cover.

S15

- Push the back cover to assemble with the panel.
- Lock 4 screws (M4x11).

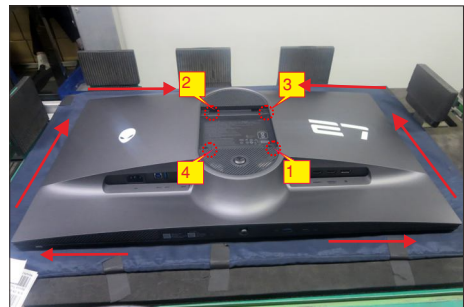

Assemble the stand riser to stand base..

S16

- Align and place the stand riser on the stand base.
- Open the screw handle at the bottom of the stand base and turn it clockwise to secure the stand assembly.
- Close the screw handle.

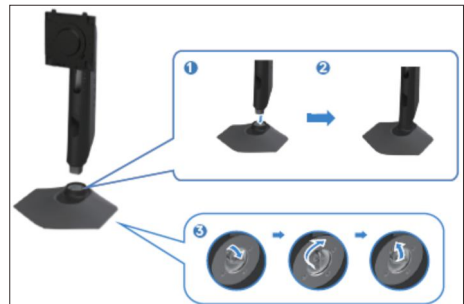

Assemble the stand base with the display monitor.

S17

- Align the stand base bracket to the monitor groove.
- Insert the bracket towards monitor until it locks in place.



## 6. Trouble Shooting Instructions

# Troubleshooting

⚠ **WARNING:** Before you begin any of the procedures in this section, follow the [Safety Instructions](#).

## Self-test

Your monitor provides a self-test feature that allows you to check whether your monitor is functioning properly. If your monitor and computer are properly connected but the monitor screen remains dark, run the monitor self-test by performing the following steps:

1. Turn off both your computer and the monitor.
2. Unplug the video cable from the back of the computer. To ensure proper self-test operation, remove all digital and the analog cables from the back of the computer.
3. Turn on the monitor.

The floating dialog box should appear on-screen (against a black background), if the monitor cannot sense a video signal and is working correctly. While in self-test mode, the power LED remains white. Also, depending upon the selected input, one of the dialogs that are shown below will continuously scroll through the screen.

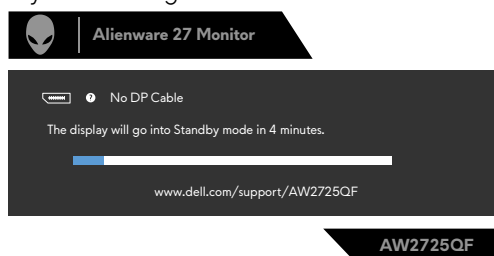

**Figure 7.** DP cable disconnected warning message

4. This box also appears during normal system operation if the video cable is disconnected or damaged.
5. Turn off your monitor and reconnect the video cable; then turn on both your computer and the monitor.

If your monitor screen remains blank after you use the previous procedure, check your video controller and computer, because your monitor is functioning properly.

## Built-in diagnostics

Your monitor has a built-in diagnostic tool that helps you determine if the screen abnormality you are experiencing is an inherent problem with your monitor, or with your computer and graphics card.

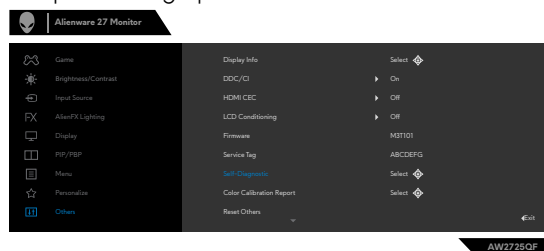

**Figure 8.** Built-in diagnostics

### To run the built-in diagnostics:

1. Ensure that the screen is clean (no dust particles on the surface of the screen).
2. Using the joystick, navigate on the OSD menu and select **Others > Self-Diagnostic**.
3. Press the joystick button to start the diagnostics. A gray screen is displayed.
4. Observe if the screen has any defects or abnormalities.
5. Toggle the joystick once again until a red screen is displayed.
6. Observe if the screen has any defects or abnormalities.
7. Repeat steps 5 and 6 until the screen displays green, blue, black, and white colors. Note any abnormalities or defects.

If you do not detect any screen abnormalities upon using the built-in diagnostic tool, the monitor is functioning properly. Check the graphics card and computer.

The test is completed when a text screen is displayed. To exit, toggle the joystick control again.

## 6. Trouble Shooting Instructions

### Common problems

The following table contains general information about common monitor problems that you might encounter and the possible solutions:

**Table 25.** Common problems description.

Common Symptoms	What You Experience	Possible Solutions
No Video/Power LED off	No picture	<ul style="list-style-type: none"> <li>Ensure that the video cable connecting the monitor and the computer is properly connected and secure.</li> <li>Verify that the power outlet is functioning properly using any other electrical equipment.</li> <li>Ensure that the power button is pressed.</li> </ul> Ensure that the correct input source is selected in the <a href="#">Input Source</a> menu.
No Video/Power LED on	No picture or no brightness	<ul style="list-style-type: none"> <li>Increase brightness and contrast controls via OSD</li> <li>Perform monitor self-test feature check.</li> <li>Check for bent or broken pins in the video cable connector.</li> <li>Run the built-in diagnostics.</li> </ul> Ensure that the correct input source is selected in the <a href="#">Input Source</a> menu.
Missing Pixels	LCD screen has spots	<ul style="list-style-type: none"> <li>Turn off the monitor and turn it on again.</li> <li>A pixel that is permanently off is a natural defect that can occur in LCD technology.</li> <li>For more information about Dell Monitor Quality and Pixel Policy, see Dell Support site at: <a href="https://www.dell.com/pixelguidelines">https://www.dell.com/pixelguidelines</a></li> </ul>
Stuck-on Pixels	LCD screen has bright spots	<ul style="list-style-type: none"> <li>Turn off the monitor and turn it on again.</li> <li>A pixel that is permanently off is a natural defect that can occur in LCD technology.</li> <li>For more information about Dell Monitor Quality and Pixel Policy, see Dell Support site at: <a href="https://www.dell.com/pixelguidelines">https://www.dell.com/pixelguidelines</a></li> </ul>
Brightness Problems	Picture too dim or too bright	<ul style="list-style-type: none"> <li>Reset the monitor to factory settings.</li> <li>Adjust brightness and contrast controls using the OSD</li> </ul>
Safety-Related Issues	Visible signs of smoke or sparks	<ul style="list-style-type: none"> <li>Do not perform any troubleshooting steps.</li> <li>Contact Dell immediately.</li> </ul>
Intermittent Problems	Monitor malfunctions on and off	<ul style="list-style-type: none"> <li>Ensure that the video cable connecting the monitor to the computer is connected properly and is secure.</li> <li>Reset the monitor to factory settings.</li> <li>Perform the monitor self-test feature (see <a href="#">Self-test</a>) check to determine if the intermittent problem is identified in the self-test mode.</li> </ul>
HDR Problems	Cannot set the GFX solution into HDR mode after switching into Desktop/Movie HDR/Game HDR Presets	<ul style="list-style-type: none"> <li>Ensure that your computer or graphics solution meets the minimum requirement for HDR playback and install the latest software drivers for the graphics card.</li> <li>Ensure that the HDMI 2.1 cable that comes with the package is used.</li> <li>If the above steps fail, choose the resolution 3840 x 2160 from the Display Properties to force the proper HDR signaling.</li> </ul>
Missing Color	Picture missing color	<ul style="list-style-type: none"> <li>Perform monitor self-test feature check.</li> <li>Ensure that the video cable connecting the monitor to the computer is connected properly and is secure.</li> <li>Check for bent or broken pins in the video cable connector.</li> </ul>

## 6. Trouble Shooting Instructions

Wrong Color	Picture color is not good	<ul style="list-style-type: none"> <li>Change the settings of the <b>Preset Modes</b> in the <b>Game</b> menu OSD depending on the application.</li> <li>Adjust the <b>Gain/Offset/Hue/Saturation</b> values under <b>Game1/ Game 2/Game 3</b> in the <b>Game</b> menu OSD.</li> <li>Change the <b>Input Color Format</b> to <b>RGB or YCbCr/YPbPr</b> in the <b>Display</b> menu OSD.</li> <li>Run the built-in diagnostics.</li> </ul>
Image retention from a static image left on the monitor for a long period	A faint shadow from the static image that is displayed appears on the screen	<ul style="list-style-type: none"> <li>Set the screen to turn off after a few minutes of screen idle time. These can be adjusted in the <b>Windows Power Options</b> or <b>Mac Energy Saver</b> setting.</li> <li>Alternatively, use a dynamically changing screensaver.</li> </ul>

### Product specific problems

**Table 26.** Product specific problems description.

Common Symptoms	What You Experience	Possible Solutions
The screen image is too small	The image is centered on the screen, but does not fill the entire viewing area	<ul style="list-style-type: none"> <li>Check the <b>Aspect Ratio</b> setting in the <b>Display</b> menu OSD.</li> <li>Reset the monitor to factory settings.</li> </ul>
Cannot adjust the monitor with the buttons on the front panel	OSD does not appear on the screen	<ul style="list-style-type: none"> <li>Turn off the monitor, unplug the power cable, plug it back, and then turn on the monitor.</li> </ul>
No Input Signal when user controls are pressed	No picture, the LED light is white	<ul style="list-style-type: none"> <li>Check the signal source. Ensure that the computer is not in the power saving mode by moving the mouse or pressing any key on the keyboard.</li> <li>Check whether the signal cable is plugged in properly. Connect the signal cable again, if necessary.</li> <li>Reset the computer or video player.</li> </ul>
The picture does not fill the entire screen	The picture cannot fill the height or width of the screen	<ul style="list-style-type: none"> <li>Due to different video formats (aspect ratio) of DVDs, the monitor may display in full screen.</li> <li>Run the built-in diagnostics.</li> </ul>
No image when using DP connection to the personal computer	Black screen	<ul style="list-style-type: none"> <li>Verify which DP standard (DP 1.1a or DP 1.4) your graphics card is certified to. Download and install the latest graphics card driver.</li> <li>Some DP 1.1a graphics card cannot support DP 1.4 monitors.</li> </ul>
After changing resolution from FHD to 4K or vice versa, the image does not fit the new resolution	The image looks 4 times or one quarter the size of the screen	<ul style="list-style-type: none"> <li>Refer to <a href="https://www.dell.com/support/AW2725QF/displayscaling">https://www.dell.com/support/AW2725QF/displayscaling</a> for the workaround steps.</li> </ul>
After changing resolution and display mode in the game settings, mouse pointer misalignment occurs.	The position of the mouse pointer is different from the location where the user interacts with the screen	<ul style="list-style-type: none"> <li>Locate the executable of the game</li> <li>Right-click the executable, select Properties</li> <li>Click on 'Compatibility' tab</li> <li>Click 'Change high DPI settings'</li> <li>Select 'Override high DPI scaling behavior'. Ensure 'Application' is selected.</li> </ul>
Dolby Vision logo Problem	Dolby Vision logo change to HDR+logo in the OSD menu	<ul style="list-style-type: none"> <li>Make sure your source is Dolby Vision Certificated;</li> <li>Update your source's Graphic card driver to latest;</li> <li>Reboot your source or disable then enable HDR from windows display setting</li> </ul>

## 6. Trouble Shooting Instructions

### Universal Serial Bus (USB) specific problems

**Table 27.** USB specific problems description.

Common Symptoms	What You Experience	Possible Solutions
USB interface is not working	USB peripherals are not working	<ul style="list-style-type: none"><li>▪ Check that your display is turned ON.</li><li>▪ Reconnect the upstream cable to your computer.</li><li>▪ Reconnect the USB peripherals (downstream connector).</li><li>▪ Turn off your monitor and turn it on again.</li><li>▪ Restart your computer.</li><li>▪ Certain USB devices such as portable hard drives require a higher power source; connect the drive to the computer directly.</li></ul>
Super speed USB 3.2 Gen1 interface is slow	Super speed USB 3.2 Gen1 peripherals working slowly or not working at all	<ul style="list-style-type: none"><li>▪ Check that your computer is USB 3.0-capable.</li><li>▪ Some computers have USB 3.0, USB 2.0, and USB 1.1 ports. Ensure that the correct USB port is used.</li><li>▪ Reconnect the upstream cable to your computer.</li><li>▪ Reconnect the USB peripherals (downstream connector).</li><li>▪ Restart your computer.</li></ul>
Wireless USB peripherals stop working when a USB 3.2 Gen1 device is plugged in	Wireless USB peripherals responding slowly or only working as the distance between itself and its receiver decreases	<ul style="list-style-type: none"><li>▪ Increase the distance between the USB 3.0 peripherals and the wireless USB receiver.</li><li>▪ Position your wireless USB receiver as close as possible to the wireless USB peripherals.</li><li>▪ Use a USB-extender cable to position the wireless USB receiver as far away as possible from the USB 3.0 port.</li></ul>