

Dell EMC PowerEdge T140

Installation and Service Manual

Notes, cautions, and warnings

 **NOTE:** A NOTE indicates important information that helps you make better use of your product.

 **CAUTION:** A CAUTION indicates either potential damage to hardware or loss of data and tells you how to avoid the problem.

 **WARNING:** A WARNING indicates a potential for property damage, personal injury, or death.

© 2018 2019 Dell Inc. or its subsidiaries. All rights reserved. Dell, EMC, and other trademarks are trademarks of Dell Inc. or its subsidiaries. Other trademarks may be trademarks of their respective owners.

1 About this document	7
2 Dell EMC PowerEdge T140 system overview	8
Front view of the system	9
Rear view of the system	10
Inside the system	11
Locating the information tag of your system	11
System Information Label	12
3 PowerEdge T140 initial system setup and configuration	15
Setting up your system	15
iDRAC configuration	15
Options to set up iDRAC IP address	15
Log in to iDRAC	15
Options to install the operating system	16
Methods to download firmware and drivers	16
Downloading drivers and firmware	16
4 PowerEdge T140 Pre-operating system management applications	18
Options to manage the pre-operating system applications	18
System Setup	18
Viewing System Setup	18
System Setup details	18
System BIOS	19
iDRAC Settings utility	35
Device Settings	35
Dell Lifecycle Controller	35
Embedded system management	35
Boot Manager	36
Viewing Boot Manager	36
Boot Manager main menu	36
One-shot UEFI boot menu	36
System Utilities	36
PXE boot	36
5 PowerEdge T140 installing and removing system components	37
Safety instructions	37
Before working inside your system	37
After working inside your system	37
Recommended tools	38
System cover	38
Removing the system cover	38
Installing the system cover	39
Front bezel	39

Removing the front bezel.....	39
Installing the front bezel.....	40
Drives.....	41
Removing a 3.5-inch drive carrier from the drive bay.....	41
Installing a 3.5-inch drive carrier into the drive bay.....	42
Removing a drive from the drive carrier.....	43
Installing a drive into the drive carrier.....	44
Optional optical drive.....	45
Removing the optical drive fillers.....	45
Installing the optical drive fillers.....	46
Removing the optical drive.....	47
Installing the optical drive.....	48
System memory.....	49
System memory guidelines.....	49
General memory module installation guidelines.....	50
Removing a memory module.....	51
Installing a memory module.....	52
Cooling fan.....	53
Removing the cooling fan.....	53
Installing a cooling fan.....	54
Optional internal USB memory key.....	55
Replacing the optional internal USB memory key.....	55
Expansion cards	55
Expansion card installation guidelines.....	56
Removing a PCIe expansion card.....	56
Installing a PCIe expansion card.....	58
Storage controller card.....	59
Removing the integrated storage controller card.....	59
Installing an integrated storage controller card.....	60
Cable routing.....	61
M.2 SSD module.....	62
Removing the M.2 SSD module.....	62
Installing the M.2 SSD module.....	63
Processor and heat sink.....	64
Removing the heat sink module.....	64
Removing the processor.....	65
Installing the processor.....	66
Installing the heat sink module.....	67
Power supply unit.....	68
Removing the power supply unit.....	68
Installing the power supply unit.....	69
System battery	71
Replacing the system battery.....	71
Intrusion switch.....	72
Removing the intrusion switch.....	72
Installing the intrusion switch.....	73
System board.....	74
Removing the system board.....	74
Installing the system board.....	76
Trusted Platform Module.....	78

Upgrading the Trusted Platform Module.....	78
Initializing TPM for BitLocker users.....	79
Initializing the TPM 1.2 for TXT users.....	79
Initializing the TPM 2.0 for TXT users.....	79
Control panel.....	80
Removing the control panel cage.....	80
Removing the control panel.....	81
Installing the control panel.....	81
Installing the control panel cage.....	82
6 Jumpers and connectors	84
System board jumpers and connectors.....	84
System board jumper settings.....	85
Disabling forgotten password.....	85
7 Technical specifications.....	87
Chassis dimensions.....	87
System weight.....	88
Processor specifications.....	88
Supported operating systems.....	88
PSU specifications.....	88
Cooling fan specifications.....	89
System battery specifications.....	89
Expansion card specifications.....	89
Memory specifications.....	89
Storage controller specifications.....	90
Drive specifications.....	90
Drives.....	90
Optical drives.....	90
Ports and connectors specifications.....	90
USB ports specifications.....	90
NIC ports specifications.....	90
Serial connector specifications.....	91
VGA ports specification.....	91
Video specifications.....	91
Environmental specifications.....	91
Standard operating temperature.....	92
Expanded operating temperature.....	92
Particulate and gaseous contamination specifications.....	93
8 System diagnostics and indicator codes	95
System health and system ID indicator codes.....	95
NIC indicator codes.....	95
Non-redundant cabled power supply unit indicator codes.....	96
PowerEdge T140 system diagnostics.....	96
Dell Embedded System Diagnostics.....	97
9 Getting help.....	98
Recycling or End-of-Life service information.....	98

Contacting Dell.....	98
Accessing system information by using QRL.....	98
Quick Resource Locator for Dell EMC PowerEdge T140 system.....	99
Receiving automated support with SupportAssist	99
10 Documentation resources.....	100

About this document

This document provides an overview about the system, information about installing and replacing components, technical specifications, diagnostic tools, and guidelines to be followed while installing certain components.

Dell EMC PowerEdge T140 system overview

The Dell EMC PowerEdge T140 system is a tower server that supports:

- One Intel Xeon, Core i3, Pentium, or Celeron processor
- Four DIMM slots
- Cabled AC power supply unit
- Up to four 3.5-inch cabled SAS or SATA drives.

For more information, see the [Technical specifications](#) section.

NOTE: All instances of SAS, SATA drives, and SSDs are referred to as drives in this document, unless specified otherwise.

Topics:

- [Front view of the system](#)
- [Rear view of the system](#)
- [Inside the system](#)
- [Locating the information tag of your system](#)
- [System Information Label](#)

Front view of the system



Figure 1. Front view of the system

1. Power button
2. System health and ID indicator
3. USB 3.0 port
4. iDRAC direct micro USB port
5. Optical drive (optional)

For more information about the ports, see the [Ports and connectors specifications](#) section.

Rear view of the system

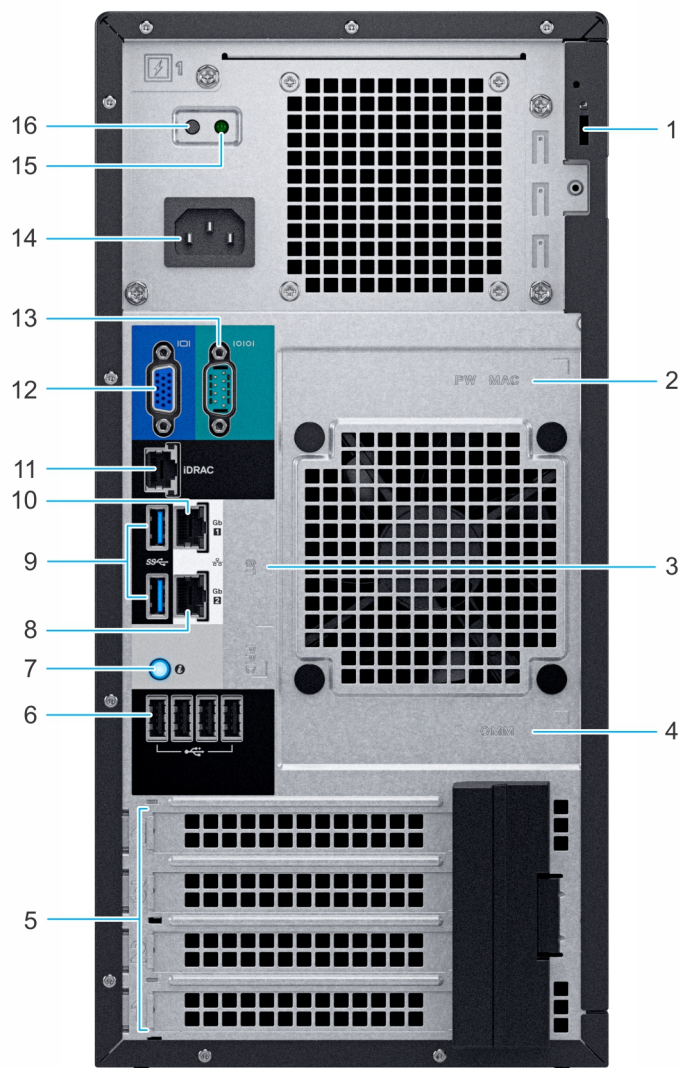

Figure 2. Rear view of the system

- | | |
|---|--|
| 1. Security Cable Lock | 2. iDRAC MAC address and iDRAC secure password label |
| 3. Service Tag, Express Service Code, QRL label | 4. OpenManage Mobile (OMM) label |
| 5. PCIe expansion card slots (4) | 6. USB 2.0 port (4) |
| 7. System identification button | 8. NIC port (Gb 2) |
| 9. USB 3.0 ports (2) | 10. NIC port (Gb 1) |
| 11. iDRAC dedicated NIC port | 12. VGA port |
| 13. Serial port | 14. Power supply unit |
| 15. PSU Built-in Self Test (BIST) LED | 16. PSU Built-in Self Test (BIST) Button |

NOTE: For more information about the ports and connectors, see the [Ports and connectors specifications](#) section.

Inside the system

CAUTION: Many repairs may only be done by a certified service technician. You should only perform troubleshooting and simple repairs as authorized in your product documentation, or as directed by the online or telephone service and support team. Damage due to servicing that is not authorized by Dell is not covered by your warranty. Read and follow the safety instructions that are shipped with your product.

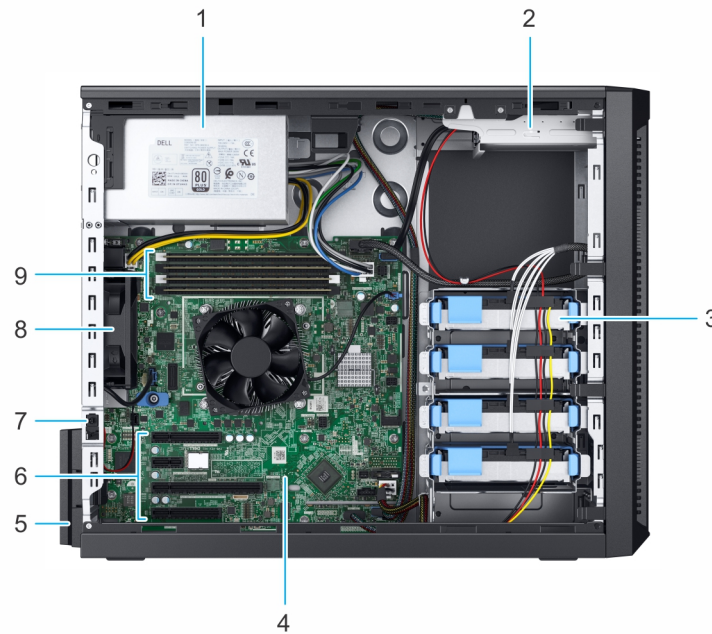

Figure 3. Inside the system

- | | |
|-----------------------------------|----------------------------------|
| 1. Cabled Power Supply Unit (PSU) | 2. Optical drive |
| 3. Cabled drives (4) | 4. System board |
| 5. Expansion card retention latch | 6. PCIe expansion card slots (4) |
| 7. Intrusion switch | 8. Fan |
| 9. Memory module sockets | |

Locating the information tag of your system

Your system is identified by a unique Express Service Code and Service Tag number. The Express Service Code and Service Tag are found on a sticker on the rear of the system. This information is used by Dell to route support calls to the appropriate personnel.

System Information Label

The Dell EMC PowerEdge T140 – system information label

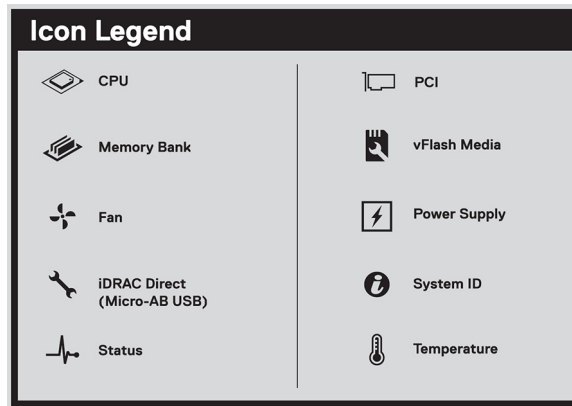

Figure 4. Icon legend

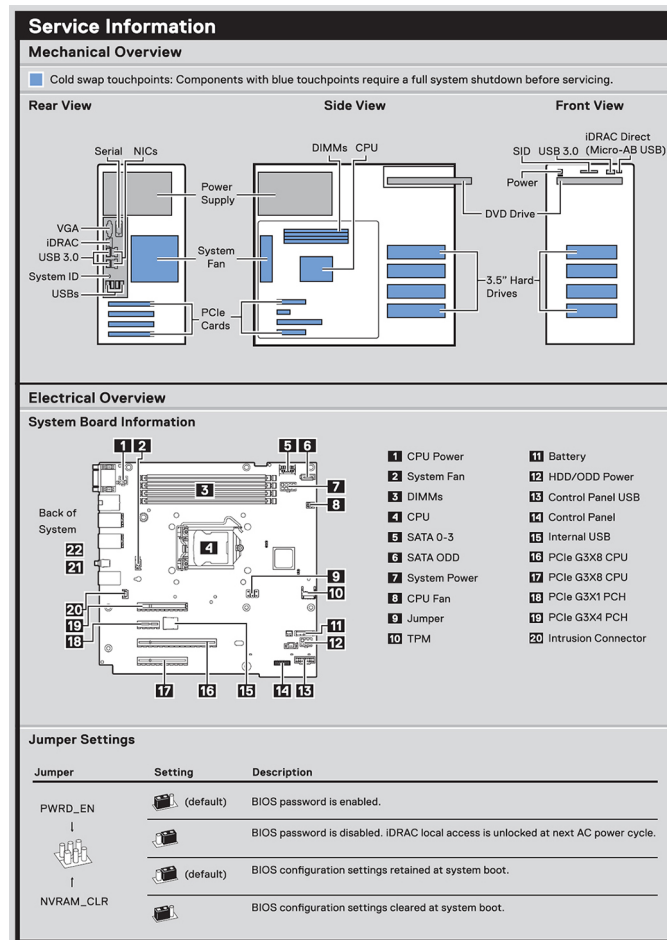

Figure 5. Service information

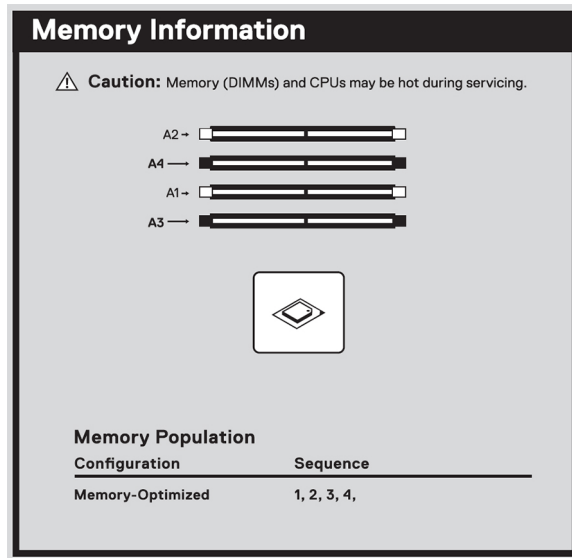

Figure 6. Memory information



Figure 7. Quick resource locator

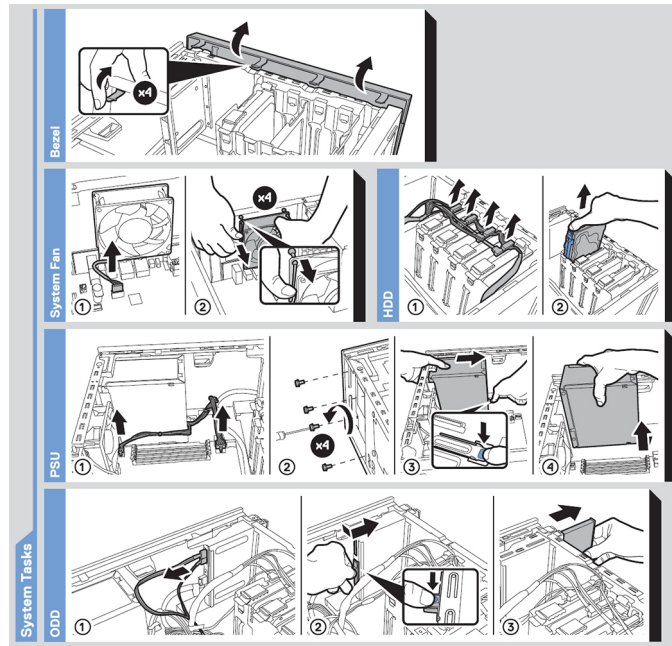

Figure 8. System task

PowerEdge T140 initial system setup and configuration

Setting up your system

Perform the following steps to set up your system:

Steps

1. Unpack the system.
2. Connect the peripherals to the system.
3. Connect the system to its electrical outlet.
4. Power on the system by pressing the power button or by using iDRAC.
5. Power on the attached peripherals.

For more information about setting up your system, see the *Getting Started Guide* that shipped with your system.

iDRAC configuration

The Integrated Dell Remote Access Controller (iDRAC) is designed to make system administrators more productive and improve the overall availability of Dell systems. iDRAC alerts administrators about system issues and enables them to perform remote system management. This reduces the need for physical access to the system.

Options to set up iDRAC IP address

To enable communication between your system and iDRAC, you must first configure the network settings based on your network infrastructure.

NOTE: For static IP configuration, you must request for it at the time of purchase.

This option is set to **DHCP** by Default. You can set up the IP address by using one of the following interfaces:

Interfaces	Document/Section
iDRAC Settings utility	<i>Dell Integrated Dell Remote Access Controller User's Guide</i> at www.dell.com/poweredgemanuals
Dell Deployment Toolkit	<i>Dell Deployment Toolkit User's Guide</i> at www.dell.com/openmanagemanuals > OpenManage Deployment Toolkit
Dell Lifecycle Controller	<i>Dell Lifecycle Controller User's Guide</i> at www.dell.com/poweredgemanuals

NOTE: To access iDRAC, ensure that you connect the ethernet cable to the iDRAC9 dedicated network port. You can also access iDRAC through the shared LOM mode, if you have opted for a system that has the shared LOM mode enabled.

Log in to iDRAC

You can log in to iDRAC as:

- iDRAC user
- Microsoft Active Directory user
- Lightweight Directory Access Protocol (LDAP) user

If you have opted for secure default access to iDRAC, you must use the iDRAC secure default password available on the system Information tag. If you have not opted for secure default access to iDRAC, then use the default user name and password `-root` and `calvin`. You can also log in by using your Single Sign-On or Smart Card.

NOTE: You must have the iDRAC credentials to log in to iDRAC.

NOTE: Ensure that you change the default user name and password after setting up the iDRAC IP address.

For more information about logging in to the iDRAC and iDRAC licenses, see the latest *Integrated Dell Remote Access Controller User's Guide* at www.dell.com/poweredgemanuals.

You can also access iDRAC by using RACADM. For more information, see the *RACADM Command Line Interface Reference Guide* at www.dell.com/poweredgemanuals.

Options to install the operating system

If the system is shipped without an operating system, install a supported operating system by using one of the following resources:

Table 1. Resources to install the operating system

Resources	Location
iDRAC	www.dell.com/idracmanuals
Lifecycle Controller	www.dell.com/idracmanuals > Lifecycle Controller
OpenManage Deployment Toolkit	www.dell.com/openmanagemanuals > OpenManage Deployment Toolkit
Dell certified VMware ESXi	www.dell.com/virtualizationsolutions
Installation and How-to videos for supported operating systems on PowerEdge systems	Supported Operating Systems for Dell EMC PowerEdge systems

Methods to download firmware and drivers

You can download the firmware and drivers by using any of the following methods:

Table 2. Firmware and drivers

Methods	Location
From the Dell EMC support site	www.dell.com/support/home
Using Dell Remote Access Controller Lifecycle Controller (iDRAC with LC)	www.dell.com/idracmanuals
Using Dell Repository Manager (DRM)	www.dell.com/openmanagemanuals > Repository Manager
Using Dell OpenManage Essentials	www.dell.com/openmanagemanuals > OpenManage Essentials
Using Dell OpenManage Enterprise	www.dell.com/openmanagemanuals > OpenManage Enterprise
Using Dell Server Update Utility (SUU)	www.dell.com/openmanagemanuals > Server Update Utility
Using Dell OpenManage Deployment Toolkit (DTK)	www.dell.com/openmanagemanuals > OpenManage Deployment Toolkit
Using iDRAC virtual media	www.dell.com/idracmanuals

Downloading drivers and firmware

Dell EMC recommends that you download and install the latest BIOS, drivers, and systems management firmware on your system.

Prerequisites

Ensure that you clear the web browser cache before downloading the drivers and firmware.

Steps

1. Go to www.dell.com/support/home.
2. In the **Drivers & Downloads** section, type the Service Tag of your system in the **Enter a Service Tag or product ID** box, and then click **Submit**.



NOTE: If you do not have the Service Tag, select Detect Product to allow the system to automatically detect the Service Tag, or click View products, and navigate to your product.

3. Click **Drivers & Downloads**.
The drivers that are applicable to your system are displayed.
4. Download the drivers to a USB drive, CD, or DVD.

PowerEdge T140 Pre-operating system management applications

You can manage basic settings and features of a system without booting to the operating system by using the system firmware.

Topics:

- [Options to manage the pre-operating system applications](#)
- [System Setup](#)
- [Dell Lifecycle Controller](#)
- [Boot Manager](#)
- [PXE boot](#)

Options to manage the pre-operating system applications

Your system has the following options to manage the pre-operating system applications:

- System Setup
- Dell Lifecycle Controller
- Boot Manager
- Preboot Execution Environment (PXE)

System Setup

By using the **System Setup** screen, you can configure the BIOS settings, iDRAC settings, and device settings of your system.

i **NOTE: Help text for the selected field is displayed in the graphical browser by default. To view the help text in the text browser, press F1.**

You can access system setup by one of the following:

- Standard graphical browser—The browser is enabled by default.
- Text browser—The browser is enabled by using Console Redirection.

Viewing System Setup

To view the **System Setup** screen, perform the following steps:

Steps

1. Power on, or restart your system.
2. Press F2 immediately after you see the following message:

```
F2 = System Setup
```

i **NOTE: If your operating system begins to load before you press F2, wait for the system to finish booting, and then restart your system and try again.**

System Setup details

The **System Setup Main Menu** screen details are explained as follows:

Option	Description
System BIOS	Enables you to configure BIOS settings.
iDRAC Settings	Enables you to configure the iDRAC settings. The iDRAC settings utility is an interface to set up and configure the iDRAC parameters by using UEFI (Unified Extensible Firmware Interface). You can enable or disable various iDRAC parameters by using the iDRAC settings utility. For more information about this utility, see <i>Integrated Dell Remote Access Controller User's Guide</i> at www.dell.com/poweredgemanuals .
Device Settings	Enables you to configure device settings.

System BIOS

You can use the **System BIOS** screen to edit specific functions such as boot order, system password, setup password, set the SATA mode, and enable or disable USB ports.

Viewing System BIOS

To view the **System BIOS** screen, perform the following steps:

Steps

1. Power on, or restart your system.
2. Press F2 immediately after you see the following message:

```
F2 = System Setup
```

NOTE: If the operating system begins to load before you press F2, wait for the system to finish booting, and then restart the system and try again.

3. On the **System Setup Main Menu** screen, click **System BIOS**.

System BIOS Settings details

About this task

The **System BIOS Settings** screen details are explained as follows:

Option	Description
System Information	Specifies information about the system such as the system model name, BIOS version, and Service Tag.
Memory Settings	Specifies information and options related to the installed memory.
Processor Settings	Specifies information and options related to the processor such as speed and cache size.
SATA Settings	Specifies options to enable or disable the integrated SATA controller and ports.
Boot Settings	Specifies options to specify the Boot mode (BIOS or UEFI). Enables you to modify UEFI and BIOS boot settings.
Network Settings	Specifies options to manage the UEFI network settings and boot protocols. Legacy network settings are managed from the Device Settings menu.
Integrated Devices	Specifies options to manage integrated device controllers and ports, specifies related features and options.
Serial Communication	Specifies options to manage the serial ports, its related features and options.
System Profile Settings	Specifies options to change the processor power management settings, memory frequency.
System Security	Specifies options to configure the system security settings, such as system password, setup password, Trusted Platform Module (TPM) security, and UEFI secure boot. It also manages the power button on the system.

Option	Description
Redundant OS Control	Sets the redundant OS info for redundant OS control.
Miscellaneous Settings	Specifies options to change the system date and time.

System Information

You can use the **System Information** screen to view system properties such as Service Tag, system model name, and BIOS version.

Viewing System Information

To view the **System Information** screen, perform the following steps:

Steps

1. Power on, or restart your system.
2. Press F2 immediately after you see the following message:

```
F2 = System Setup
```

NOTE: If your operating system begins to load before you press F2, wait for the system to finish booting, and then restart your system and try again.

3. On the **System Setup Main Menu** screen, click **System BIOS**.
4. On the **System BIOS** screen, click **System Information**.

System Information details

About this task

The **System Information** screen details are explained as follows:

Option	Description
System Model Name	Specifies the system model name.
System BIOS Version	Specifies the BIOS version installed on the system.
System Management Engine Version	Specifies the current version of the Management Engine firmware.
System Service Tag	Specifies the system Service Tag.
System Manufacturer	Specifies the name of the system manufacturer.
System Manufacturer Contact Information	Specifies the contact information of the system manufacturer.
System CPLD Version	Specifies the current version of the system complex programmable logic device (CPLD) firmware.
UEFI Compliance Version	Specifies the UEFI compliance level of the system firmware.

Memory Settings

You can use the **Memory Settings** screen to view all the memory settings and enable or disable specific memory functions, such as system memory testing and node interleaving.

Viewing Memory Settings

To view the **Memory Settings** screen, perform the following steps:

Steps

1. Power on, or restart your system.
2. Press F2 immediately after you see the following message:

```
F2 = System Setup
```

NOTE: If the operating system begins to load before you press F2, wait for the system to finish booting, and then restart the system and try again.

3. On the **System Setup Main Menu** screen, click **System BIOS**.
4. On the **System BIOS** screen, click **Memory Settings**.

Memory Settings details

About this task

The **Memory Settings** screen details are explained as follows:

Option	Description
System Memory Size	Specifies the memory size in the system.
System Memory Type	Specifies the type of memory installed in the system.
System Memory Speed	Specifies the system memory speed.
System Memory Voltage	Specifies the system memory voltage.
Video Memory	Specifies the amount of video memory.
System Memory Testing	Specifies whether the system memory tests are run during system boot. Options are Enabled and Disabled . This option is set to Disabled by default.
Memory Operating Mode	Specifies the memory operating mode. This option is set to Optimizer Mode by default. NOTE: The Memory Operating Mode option can have different default and available options based on the memory configuration of your system.
Current State of Memory Operating Mode	Specifies the current state of the memory operating mode.

Processor Settings

You can use the **Processor Settings** screen to view the processor settings, and perform specific functions such as enabling virtualization technology, hardware prefetcher, and logical processor idling.

Viewing Processor Settings

To view the **Processor Settings** screen, perform the following steps:

Steps

1. Power on, or restart your system.
2. Press F2 immediately after you see the following message:

```
F2 = System Setup
```

NOTE: If your operating system begins to load before you press F2, wait for the system to finish booting, and then restart your system and try again.

3. On the **System Setup Main Menu** screen, click **System BIOS**.
4. On the **System BIOS** screen, click **Processor Settings**.

Processor Settings details

About this task

The **Processor Settings** screen details are explained as follows:

Option	Description								
Logical Processor	Enables or disables the logical processors and displays the number of logical processors. If this option is set to Enabled , the BIOS displays all the logical processors. If this option is set to Disabled , the BIOS displays only one logical processor per core. This option is set to Enabled by default.								
Virtualization Technology	Enables or disables the virtualization technology for the processor. This option is set to Enabled by default.								
Adjacent Cache Line Prefetch	Optimizes the system for applications that need high utilization of sequential memory access. This option is set to Enabled by default. You can disable this option for applications that need high utilization of random memory access.								
Hardware Prefetcher	Enables or disables the hardware prefetcher. This option is set to Enabled by default.								
Logical Processor Idling	Enables you to improve the energy efficiency of a system. It uses the operating system core parking algorithm and parks some of the logical processors in the system which in turn allows the corresponding processor cores to transition into a lower power idle state. This option can only be enabled if the operating system supports it. It is set to Disabled by default.								
x2APIC Mode	Enables or disables the x2APIC mode. This option is set to Disabled by default.								
Number of Cores per Processor	Controls the number of enabled cores in each processor. This option is set to All by default.								
Processor Core Speed	Specifies the maximum core frequency of the processor.								
Processor 1	The following settings are displayed for each processor installed in the system: <table border="1"><thead><tr><th>Option</th><th>Description</th></tr></thead><tbody><tr><td>Family-Model-Stepping</td><td>Specifies the family, model, and stepping of the processor as defined by Intel.</td></tr><tr><td>Brand</td><td>Specifies the brand name.</td></tr><tr><td>Level 2 Cache</td><td>Specifies the total L2 cache.</td></tr></tbody></table>	Option	Description	Family-Model-Stepping	Specifies the family, model, and stepping of the processor as defined by Intel.	Brand	Specifies the brand name.	Level 2 Cache	Specifies the total L2 cache.
Option	Description								
Family-Model-Stepping	Specifies the family, model, and stepping of the processor as defined by Intel.								
Brand	Specifies the brand name.								
Level 2 Cache	Specifies the total L2 cache.								

Option	Description
Option	Description
Level 3 Cache	Specifies the total L3 cache.
Number of Cores	Specifies the number of cores per processor.
Microcode	Specifies the microcode.

SATA Settings

You can use the **SATA Settings** screen to view the SATA settings of SATA devices and enable SATA on your system.

Viewing SATA Settings

To view the **SATA Settings** screen, perform the following steps:

Steps

1. Power on, or restart your system.
2. Press F2 immediately after you see the following message:

```
F2 = System Setup
```

NOTE: If your operating system begins to load before you press F2, wait for the system to finish booting, and then restart your system and try again.

3. On the **System Setup Main Menu** screen, click **System BIOS**.
4. On the **System BIOS** screen, click **SATA Settings**.

SATA Settings details

About this task

The **SATA Settings** screen details are explained as follows:

Option	Description
Embedded SATA	Enables the embedded SATA option to be set to Off , AHCI , or RAID modes. This option is set to AHCI Mode by default.
Security Freeze Lock	Sends Security Freeze Lock command to the embedded SATA drives during POST. This option is applicable only for AHCI Mode. This option is set to Enabled by default.
Write Cache	Enables or disables the command for the embedded SATA drives during POST. This option is set to Disabled by default.
Port n	Sets the drive type of the selected device. For AHCI Mode or RAID Mode , BIOS support is always enabled.
Option	Description
Model	Specifies the drive model of the selected device.
Drive Type	Specifies the type of drive attached to the SATA port.
Capacity	Specifies the total capacity of the drive. This field is undefined for removable media devices such as optical drives.

Boot Settings

You can use the **Boot Settings** screen to set the boot mode to either **BIOS** or **UEFI**. It also enables you to specify the boot order.

- **UEFI:** The Unified Extensible Firmware Interface (UEFI) is a new interface between operating systems and platform firmware. The interface consists of data tables with platform related information, boot and runtime service calls that are available to the operating system and its loader. The following benefits are available when the **Boot Mode** is set to **UEFI**:
 - Support for drive partitions larger than 2 TB.
 - Enhanced security (e.g., UEFI Secure Boot).
 - Faster boot time.
- **BIOS:** The **BIOS Boot Mode** is the legacy boot mode. It is maintained for backward compatibility.

Viewing Boot Settings

To view the **Boot Settings** screen, perform the following steps:

Steps

1. Power on, or restart your system.
2. Press F2 immediately after you see the following message:

```
F2 = System Setup
```

NOTE: If your operating system begins to load before you press F2, wait for the system to finish booting, and then restart your system and try again.

3. On the **System Setup Main Menu** screen, click **System BIOS**.
4. On the **System BIOS** screen, click **Boot Settings**.

Boot Settings details

About this task

The **Boot Settings** screen details are explained as follows:

Option	Description
Boot Mode	Enables you to set the boot mode of the system. CAUTION: Switching the boot mode may prevent the system from booting if the operating system is not installed in the same boot mode. If the operating system supports UEFI , you can set this option to UEFI . Setting this field to BIOS allows compatibility with non-UEFI operating systems. This option is set to UEFI by default. NOTE: Setting this field to UEFI disables the BIOS Boot Settings menu.
Boot Sequence Retry	Enables or disables the Boot Sequence Retry feature. If this option is set to Enabled and the system fails to boot, the system re-attempts the boot sequence after 30 seconds. This option is set to Enabled by default.
Hard-Disk Failover	Specifies the drive that is booted in the event of a drive failure. The devices are selected in the Hard-Disk Drive Sequence on the Boot Option Setting menu. When this option is set to Disabled , only the first drive in the list is attempted to boot. When this option is set to Enabled , all drives are attempted to boot in the order selected in the Hard-Disk Drive Sequence . This option is not enabled for UEFI Boot Mode . This option is set to Disabled by default.
Generic USB boot	Enables or disables generic USB boot. This option is set to Disabled by default.
Hard-disk Drive Placeholder	Enables or disables Hard-disk Drive Placeholder.
UEFI Boot Settings	Enables or disables UEFI Boot options. The Boot options include IPv4 PXE and IPv6 PXE . This option is set to IPv4 by default. NOTE: This option is enabled only if the boot mode is UEFI .

Option	Description
UEFI Boot Sequence	Enables you to change the boot device order.
Boot Options Enable/Disable	Enables you to select the enabled or disabled boot devices.

Network Settings

You can use the **Network Settings** screen to modify UEFI PXE, iSCSI, and HTTP boot settings. The network settings option is available only in the UEFI mode.

NOTE: BIOS does not control network settings in the BIOS mode. For the BIOS boot mode, the optional Boot ROM of the network controllers handles the network settings.

Viewing Network Settings

To view the **Network Settings** screen, perform the following steps:

Steps

1. Power on, or restart your system.
2. Press F2 immediately after you see the following message:

```
F2 = System Setup
```

NOTE: If your operating system begins to load before you press F2, wait for the system to finish booting, and then restart your system and try again.

3. On the **System Setup Main Menu** screen, click **System BIOS**.
4. On the **System BIOS** screen, click **Network Settings**.

Network Settings screen details

The **Network Settings** screen details are explained as follows:

About this task

Option	Description
PXE Device n (n = 1 to 4)	Enables or disables the device. When enabled, a UEFI PXE boot option is created for the device.
PXE Device n Settings(n = 1 to 4)	Enables you to control the configuration of the PXE device.
HTTP Device n (n = 1 to 4)	Enables or disables the device. When enabled, a UEFI HTTP boot option is created for the device.
HTTP Device n Settings (n = 1 to 4)	Enables you to control the configuration of the HTTP device.
UEFI iSCSI Settings	Enables you to control the configuration of the iSCSI device.

Table 3. UEFI iSCSI Settings screen details

Option	Description
iSCSI Initiator Name	Specifies the name of the iSCSI initiator in IQN format.
iSCSI Device1	Enables or disables the iSCSI device. When enabled, a UEFI boot option is created for the iSCSI device automatically. This is set to Enabled by default.

Option	Description
iSCSI Device1 Settings	Enables you to control the configuration of the iSCSI device.

Integrated Devices

You can use the **Integrated Devices** screen to view and configure the settings of all integrated devices including the video controller, integrated RAID controller, and the USB ports.

Viewing Integrated Devices

To view the **Integrated Devices** screen, perform the following steps:

Steps

1. Power on, or restart your system.
2. Press F2 immediately after you see the following message:

```
F2 = System Setup
```

NOTE: If your operating system begins to load before you press F2, wait for the system to finish booting, and then restart your system and try again.

3. On the **System Setup Main Menu** screen, click **System BIOS**.
4. On the **System BIOS** screen, click **Integrated Devices**.

Integrated Devices details

About this task

The **Integrated Devices** screen details are explained as follows:

Option	Description
User Accessible USB Ports	Configures the user accessible USB ports. Selecting Only Back Ports On disables the front USB ports; selecting All Ports Off disables all front and back USB ports; The USB keyboard and mouse still function in certain USB ports during the boot process, depending on the selection. After the boot process is complete, the USB ports will be enabled or disabled as per the setting. NOTE: Selecting Only Back Ports On and All Ports Off disables the USB management port and also restricts access to the iDRAC features.
Internal USB Port	Enables or disables the internal USB port. This option is set to On or Off . This option is set to On by default.
iDRAC Direct USB Port	The iDRAC Direct USB port is managed by iDRAC exclusively with no host visibility. This option is set to ON or OFF . When set to OFF , iDRAC does not detect any USB devices installed in this managed port. This option is set to On by default.
Embedded NIC1 and NIC2	NOTE: The Embedded NIC1 and NIC2 options are only available on systems that do not have Integrated Network Card 1 . Enables or disables the Embedded NIC1 and NIC2 options. If set to Disabled , the NIC may still be available for shared network access by the embedded management controller. The embedded NIC1 and NIC2 options are only available on systems that do not have Network Daughter Cards (NDCs). The Embedded NIC1 and NIC2 option is mutually exclusive with the Integrated Network Card 1 option. Configure the Embedded NIC1 and NIC2 option by using the NIC management utilities of the system.
I/OAT DMA Engine	Enables or disables the I/O Acceleration Technology (I/OAT) option. I/OAT is a set of DMA features designed to accelerate network traffic and lower CPU utilization. Enable only if the hardware and software support the feature.

Option	Description
Embedded Video Controller	<p>Enables or disables the use of Embedded Video Controller as the primary display. When set to Enabled, the Embedded Video Controller will be the primary display even if add-in graphic cards are installed. When set to Disabled, an add-in graphics card will be used as the primary display. BIOS will output displays to both the primary add-in video and the embedded video during POST and pre-boot environment. The embedded video will then be disabled right before the operating system boots. This option is set to Enabled by default.</p> <p>NOTE: When there are multiple add-in graphic cards installed in the system, the first card discovered during PCI enumeration is selected as the primary video. You might have to re-arrange the cards in the slots in order to control which card is the primary video.</p>
Current State of Embedded Video Controller	<p>Displays the current state of the embedded video controller. The Current State of Embedded Video Controller option is a read-only field. If the Embedded Video Controller is the only display capability in the system (that is, no add-in graphics card is installed), then the Embedded Video Controller is automatically used as the primary display even if the Embedded Video Controller setting is set to Enabled.</p>
OS Watchdog Timer	<p>If your system stops responding, this watchdog timer aids in the recovery of your operating system. When this option is set to Enabled, the operating system initializes the timer. When this option is set to Disabled (the default), the timer does not have any effect on the system.</p>
Memory Mapped I/O above 4 GB	<p>Enables or disables the support for the PCIe devices that need large amounts of memory. Enable this option only for 64-bit operating systems. This option is set to Enabled by default.</p>
Slot Disablement	<p>Enables or disables the available PCIe slots on your system. The slot disablement feature controls the configuration of the PCIe cards installed in the specified slot. Slots must be disabled only when the installed peripheral card prevents booting into the operating system or causes delays in system startup. If the slot is disabled, both the Option ROM and UEFI drivers are disabled. Only slots that are present on the system will be available for control.</p>

Table 4. Slot Disablement

Option	Description
Slot 1	Enables or disables or only the boot driver is disabled for the PCIe slot 1. This option is set to Enabled by default.
Slot 2	Enables or disables or only the boot driver is disabled for the PCIe slot 2. This option is set to Enabled by default.
Slot 3	Enables or disables or only the boot driver is disabled for the PCIe slot 3. This option is set to Enabled by default.
Slot 4	Enables or disables or only the boot driver is disabled for the PCIe slot 4. This option is set to Enabled by default.

Serial Communication

You can use the **Serial Communication** screen to view the properties of the serial communication port.

Viewing Serial Communication

To view the **Serial Communication** screen, perform the following steps:

Steps

1. Power on, or restart your system.
2. Press F2 immediately after you see the following message:

F2 = System Setup

NOTE: If your operating system begins to load before you press F2, wait for the system to finish booting, and then restart your system and try again.

3. On the **System Setup Main Menu** screen, click **System BIOS**.
4. On the **System BIOS** screen, click **Serial Communication**.

Serial Communication details

About this task

The **Serial Communication** screen details are explained as follows:

Option	Description
Serial Communication	Selects serial communication devices (Serial Device 1 and Serial Device 2) in BIOS. BIOS console redirection can also be enabled, and the port address can be specified. This option is set to Auto by default.
Serial Port Address	Enables you to set the port address for serial devices. This field sets the serial port address to either COM1 or COM2 (COM1=0x3F8, COM2=0x2F8). This option is set to Serial Device1=COM2 or Serial Device 2=COM1 by default. NOTE: You can use only Serial Device 2 for the Serial Over LAN (SOL) feature. To use console redirection by SOL, configure the same port address for console redirection and the serial device. NOTE: Every time the system boots, the BIOS syncs the serial MUX setting saved in iDRAC. The serial MUX setting can independently be changed in iDRAC. Loading the BIOS default settings from within the BIOS setup utility may not always revert the serial MUX setting to the default setting of Serial Device 1.
External Serial Connector	Enables you to associate the External Serial Connector to Serial Device 1 , Serial Device 2 , or the Remote Access Device by using this option. This option is set to Serial Device 1 by default. NOTE: Only Serial Device 2 can be used for Serial Over LAN (SOL). To use console redirection by SOL, configure the same port address for console redirection and the serial device. NOTE: Every time the system boots, the BIOS syncs the serial MUX setting saved in iDRAC. The serial MUX setting can independently be changed in iDRAC. Loading the BIOS default settings from within the BIOS setup utility may not always revert this setting to the default setting of Serial Device 1.
Failsafe Baud Rate	Specifies the failsafe baud rate for console redirection. The BIOS attempts to determine the baud rate automatically. This failsafe baud rate is used only if the attempt fails, and the value must not be changed. This option is set to 115200 by default.
Remote Terminal Type	Sets the remote console terminal type. This option is set to ANSI VT100/VT220 by default.
Redirection After Boot	Enables or disables the BIOS console redirection when the operating system is loaded. This option is set to Enabled by default.

System Profile Settings

You can use the **System Profile Settings** screen to enable specific system performance settings such as power management.

Viewing System Profile Settings

To view the **System Profile Settings** screen, perform the following steps:

Steps

1. Power on, or restart your system.
2. Press F2 immediately after you see the following message:

```
F2 = System Setup
```

NOTE: If your operating system begins to load before you press F2, wait for the system to finish booting, and then restart your system and try again.

3. On the **System Setup Main Menu** screen, click **System BIOS**.
4. On the **System BIOS** screen, click **System Profile Settings**.

System Profile Settings details

About this task

The **System Profile Settings** screen details are explained as follows:

Option	Description
System Profile	Sets the system profile. If you set the System Profile option to a mode other than Custom , the BIOS automatically sets the rest of the options. You can only change the rest of the options if the mode is set to Custom . This option is set to Performance Per Watt (OS) by default. NOTE: All the parameters on the system profile setting screen are available only when the System Profile option is set to Custom.
CPU Power Management	Sets the CPU power management. This option is set to OS DBPM by default.
Memory Frequency	Sets the speed of the system memory. You can select Maximum Performance , Maximum Reliability , or a specific speed. This option is set to Maximum Performance by default.
Turbo Boost	Enables or disables the processor to operate in the turbo boost mode. This option is set to Enabled by default.
C1E	Enables or disables the processor to switch to a minimum performance state when it is idle. This option is set to Enabled by default.
C States	Enables or disables the processor to operate in all available power states. This option is set to Enabled by default.
Memory Refresh Rate	Sets the memory refresh rate to either 1x or 2x. This option is set to 1x by default.
Uncore Frequency	Enables you to select the Processor Uncore Frequency option. Dynamic mode enables the processor to optimize power resources across the cores and uncore during runtime. The optimization of the uncore frequency to either save power or optimize performance is influenced by the setting of the Energy Efficiency Policy option.
Number of Turbo Boost Enabled Cores for Processor 1	NOTE: If there are two processors installed in the system, you will see an entry for Number of Turbo Boost Enabled Cores for Processor 2 . Controls the number of turbo boost enabled cores for Processor 1. The maximum number of cores is enabled by default.
Monitor/Mwait	Enables the Monitor/Mwait instructions in the processor. This option is set to Enabled for all system profiles, except Custom by default. NOTE: This option can be disabled only if the C States option in the Custom mode is set to disabled. NOTE: When C States is set to Enabled in the Custom mode, changing the Monitor/Mwait setting does not impact the system power or performance.
PCI ASPM L1 Link Power Management	Enables or disables the PCI ASPM L1 Link Power Management. This option is set to Enabled by default.

System Security

You can use the **System Security** screen to perform specific functions such as setting the system password, setup password and disabling the power button.

Viewing System Security

To view the **System Security** screen, perform the following steps:

Steps

1. Power on, or restart your system.
2. Press F2 immediately after you see the following message:

```
F2 = System Setup
```

NOTE: If your operating system begins to load before you press F2, wait for the system to finish booting, and then restart your system and try again.



3. On the **System Setup Main Menu** screen, click **System BIOS**.
4. On the **System BIOS** screen, click **System Security**.

System Security Settings details

About this task

The **System Security Settings** screen details are explained as follows:

Option	Description
CPU AES-NI	Improves the speed of applications by performing encryption and decryption by using the Advanced Encryption Standard Instruction Set (AES-NI). This option is set to Enabled by default.
System Password	Sets the system password. This option is set to Enabled by default and is read-only if the password jumper is not installed in the system.
Setup Password	Sets the setup password. This option is read-only if the password jumper is not installed in the system.
Password Status	Locks the system password. This option is set to Unlocked by default.
TPM Security	<p>NOTE: The TPM menu is available only when the TPM module is installed.</p> <p>Enables you to control the reporting mode of the TPM. The TPM Security option is set to Off by default. You can only modify the TPM Status, and TPM Activation fields if the TPM Status field is set to either On with Pre-boot Measurements or On without Pre-boot Measurements.</p>
TPM Information	Changes the operational state of the TPM. This option is set to No Change by default.
TPM Status	Specifies the TPM status.
TPM Command	<p>Controls the Trusted Platform Module (TPM). When set to None, no command is sent to the TPM. When set to Activate, the TPM is enabled and activated. When set to Deactivate, the TPM is disabled and deactivated. When set to Clear, all the contents of the TPM are cleared. This option is set to None by default.</p> <p>CAUTION: Clearing the TPM results in the loss of all keys in the TPM. The loss of TPM keys may affect booting to the operating system.</p> <p>This field is read-only when TPM Security is set to Off. The action requires an additional reboot before it can take effect.</p>
Intel(R) TXT	<p>Enables or disables the Intel Trusted Execution Technology (TXT) option. To enable the Intel TXT option, virtualization technology and TPM Security must be enabled with Pre-boot measurements. This option is set to Off by default.</p> <p>When TPM 2.0 is installed, TPM 2 Algorithm option is available. It enables you to select a hash algorithm from those supported by the TPM (SHA1, SHA256). TPM 2 Algorithm option must be set to SHA256, to enable TXT.</p>
Intel(R) SGX	Enables or disables the Intel Software Guard Extension (SGX) option. This option is set to Software by default.

Option	Description								
	<p> NOTE: The SGX menu is available, only when E-2186G/E-2176G/E-2174G/E-2286G/E-2276G/E-2246G/E-2236/E-2226G/E-2274G/E-2244G/E-2234/E-2224 CPU is installed</p>								
SGX Launch Control Policy	Allows controlling the Launch Control Policy (LCP) of Software Guard Extensions (SGX) technology. This option is set to Unlocked by default.								
Power Button	Enables or disables the power button on the front of the system. This option is set to Enabled by default.								
AC Power Recovery	Sets how the system behaves after AC power is restored to the system. This option is set to Last by default.								
AC Power Recovery Delay	Sets the time delay for the system to power up after AC power is restored to the system. This option is set to Immediate by default.								
User Defined Delay (60 s to 240 s)	Sets the User Defined Delay option when the User Defined option for AC Power Recovery Delay is selected.								
UEFI Variable Access	Provides varying degrees of securing UEFI variables. When set to Standard (the default), UEFI variables are accessible in the operating system per the UEFI specification. When set to Controlled , selected UEFI variables are protected in the environment and new UEFI boot entries are forced to be at the end of the current boot order.								
In-Band Manageability Interface	When set to Disabled , this setting will hide the Management Engine's (ME), HECI devices, and the system's IPMI devices from the operating system. This prevents the operating system from changing the ME power capping settings, and blocks access to all in-band management tools. All management should be managed through out-of-band. This option is set to Enabled by default. <p> NOTE: BIOS update requires HECI devices to be operational and DUP updates require IPMI interface to be operational. This setting needs to be set to Enabled to avoid updating errors.</p>								
Secure Boot	Enables Secure Boot, where the BIOS authenticates each pre-boot image by using the certificates in the Secure Boot Policy. Secure Boot is set to Disabled by default.								
Secure Boot Policy	When Secure Boot policy is set to Standard , the BIOS uses the system manufacturer's key and certificates to authenticate pre-boot images. When Secure Boot policy is set to Custom , the BIOS uses the user-defined key and certificates. Secure Boot policy is set to Standard by default.								
Secure Boot Mode	Configures how the BIOS uses the Secure Boot Policy Objects (PK, KEK, db, dbx). <p>If the current mode is set to Deployed Mode, the available options are User Mode and Deployed Mode. If the current mode is set to User Mode, the available options are User Mode, Audit Mode, and Deployed Mode.</p> <table border="1"> <thead> <tr> <th>Options</th> <th>Description</th> </tr> </thead> <tbody> <tr> <td>User Mode</td> <td>In User Mode, PK must be installed, and BIOS performs signature verification on programmatic attempts to update policy objects. The BIOS allows unauthenticated programmatic transitions between modes.</td> </tr> <tr> <td>Audit Mode</td> <td>In Audit mode, PK is not present. The BIOS does not authenticate programmatic updates to the policy objects, and transitions between modes. Audit Mode is useful for programmatically determining a working set of policy objects. BIOS performs signature verification on pre-boot images and logs results in the image Execution Information Table, but executes the images whether they pass or fail verification.</td> </tr> <tr> <td>Deployed Mode</td> <td>Deployed Mode is the most secure mode. In Deployed Mode, PK must be installed and the BIOS performs signature verification on programmatic attempts to update policy objects. Deployed Mode restricts the programmatic mode transitions.</td> </tr> </tbody> </table>	Options	Description	User Mode	In User Mode , PK must be installed, and BIOS performs signature verification on programmatic attempts to update policy objects. The BIOS allows unauthenticated programmatic transitions between modes.	Audit Mode	In Audit mode , PK is not present. The BIOS does not authenticate programmatic updates to the policy objects, and transitions between modes. Audit Mode is useful for programmatically determining a working set of policy objects. BIOS performs signature verification on pre-boot images and logs results in the image Execution Information Table, but executes the images whether they pass or fail verification.	Deployed Mode	Deployed Mode is the most secure mode. In Deployed Mode , PK must be installed and the BIOS performs signature verification on programmatic attempts to update policy objects. Deployed Mode restricts the programmatic mode transitions.
Options	Description								
User Mode	In User Mode , PK must be installed, and BIOS performs signature verification on programmatic attempts to update policy objects. The BIOS allows unauthenticated programmatic transitions between modes.								
Audit Mode	In Audit mode , PK is not present. The BIOS does not authenticate programmatic updates to the policy objects, and transitions between modes. Audit Mode is useful for programmatically determining a working set of policy objects. BIOS performs signature verification on pre-boot images and logs results in the image Execution Information Table, but executes the images whether they pass or fail verification.								
Deployed Mode	Deployed Mode is the most secure mode. In Deployed Mode , PK must be installed and the BIOS performs signature verification on programmatic attempts to update policy objects. Deployed Mode restricts the programmatic mode transitions.								
Secure Boot Policy Summary	Specifies the list of certificates and hashes that secure boot uses to authenticate images.								

Option	Description
Secure Boot Custom Policy Settings	Configures the Secure Boot Custom Policy. To enable this option, set the Secure Boot Policy to Custom option.

Creating a system and setup password

Prerequisites

Ensure that the password jumper is enabled. The password jumper enables or disables the system password and setup password features. For more information, see the System board jumper settings section.

NOTE: If the password jumper setting is disabled, the existing system password and setup password are deleted and you need not provide the system password to boot the system.

Steps

1. To enter System Setup, press F2 immediately after turning on or rebooting your system.
2. On the **System Setup Main Menu** screen, click **System BIOS > System Security**.
3. On the **System Security** screen, verify that **Password Status** is set to **Unlocked**.
4. In the **System Password** field, type your system password, and press Enter or Tab.

Use the following guidelines to assign the system password:

- A password can have up to 32 characters.
- The password can contain the numbers 0 through 9.
- Only the following special characters are allowed: space, ("), (+), (,), (-), (.), (/), (:), ([), (\), (]), (').

A message prompts you to reenter the system password.

5. Reenter the system password, and click **OK**.
6. In the **Setup Password** field, type your setup password and press Enter or Tab. A message prompts you to reenter the setup password.
7. Reenter the setup password, and click **OK**.
8. Press Esc to return to the System BIOS screen. Press Esc again.

A message prompts you to save the changes.

NOTE: Password protection does not take effect until the system reboots.

Using your system password to secure the system

About this task

If you have assigned a setup password, the system accepts your setup password as an alternate system password.

Steps

1. Power on or reboot your system.
2. Type the system password and press Enter.

Next steps

When **Password Status** is set to **Locked**, type the system password and press Enter when prompted at reboot.

NOTE: If an incorrect system password is typed, the system displays a message and prompts you to reenter your password. You have three attempts to type the correct password. After the third unsuccessful attempt, the system displays an error message that the system has stopped functioning and must be turned off. Even after you turn off and restart the system, the error message is displayed until the correct password is entered.

Deleting or changing system and setup password

Prerequisites

NOTE: You cannot delete or change an existing system or setup password if the Password Status is set to Locked.

Steps

1. To enter System Setup, press F2 immediately after turning on or restarting your system.
2. On the **System Setup Main Menu** screen, click **System BIOS > System Security**.
3. On the **System Security** screen, ensure that **Password Status** is set to **Unlocked**.
4. In the **System Password** field, change or delete the existing system password, and then press Enter or Tab.
5. In the **Setup Password** field, alter or delete the existing setup password, and then press Enter or Tab.

NOTE: If you change the system password or setup password, a message prompts you to reenter the new password. If you delete the system password or setup password, a message prompts you to confirm the deletion.

6. Press Esc to return to the **System BIOS** screen. Press Esc again, and a message prompts you to save the changes.
7. Select **Setup Password**, change, or delete the existing setup password and press Enter or Tab.

NOTE: If you change the system password or setup password, a message prompts you to reenter the new password. If you delete the system password or setup password, a message prompts you to confirm the deletion.

Operating with setup password enabled

If **Setup Password** is set to **Enabled**, type the correct setup password before modifying the system setup options.

If you do not type the correct password in three attempts, the system displays the following message:

```
Invalid Password! Number of unsuccessful password attempts: <x> System Halted! Must power down.
```

```
Password Invalid. Number of unsuccessful password attempts: <x> Maximum number of password attempts exceeded. System halted.
```

Even after you turn off and restart the system, the error message is displayed until the correct password is typed. The following options are exceptions:

- If **System Password** is not set to **Enabled** and is not locked through the **Password Status** option, you can assign a system password. For more information, see the System Security Settings screen section.
- You cannot disable or change an existing system password.

NOTE: You can use the password status option with the setup password option to protect the system password from unauthorized changes.

Redundant OS Control

In the **Redundant OS Control** screen you can set the redundant OS information. This enables you to set up a physical recovery disk on the system.

Viewing Redundant OS Control

To view the **Redundant OS Control** screen, perform the following steps:

Steps

1. Power on, or restart your system.
2. Press F2 immediately after you see the following message:

```
F2 = System Setup
```

NOTE: If your operating system begins to load before you press F2, wait for the system to finish booting, and then restart your system and try again.

3. On the **System Setup Main Menu** screen, click **System BIOS**.
4. On the **System BIOS** screen, click **Redundant OS Control**.

Redundant OS Control screen details

The **Redundant OS Control** screen details are explained as follows:

About this task

Option	Description
Redundant OS Location	<p>Enables you to select a backup disk from the following devices:</p> <ul style="list-style-type: none"> • None • IDSDM • SATA Ports in AHCI mode • BOSS PCIe Cards (Internal M.2 Drives) • Internal USB <p>NOTE: RAID configurations and NVMe cards not are included as BIOS does not have the ability to distinguish between individual drives in those configurations.</p>
Redundant OS State	<p>NOTE: This option is disabled if Redundant OS Location is set to None.</p> <p>When set to Visible, the backup disk is visible to the boot list and OS. When set to Hidden, the backup disk is disabled and is not visible to the boot list and OS. This option is set to Visible by default.</p> <p>NOTE: BIOS will disable the device in hardware, so it cannot be accessed by the OS.</p>
Redundant OS Boot	<p>NOTE: This option is disabled if Redundant OS Location is set to None or if Redundant OS State is set to Hidden.</p> <p>When set to Enabled, BIOS boots to the device specified in Redundant OS Location. When set to Disabled, BIOS preserves the current boot list settings. This option is set to Disabled by default.</p>

Miscellaneous Settings

You can use the **Miscellaneous Settings** screen to perform specific functions such as updating the asset tag and changing the system date and time.

Viewing Miscellaneous Settings

To view the **Miscellaneous Settings** screen, perform the following steps:

Steps

1. Power on, or restart your system.
2. Press F2 immediately after you see the following message:

```
F2 = System Setup
```

NOTE: If your operating system begins to load before you press F2, wait for the system to finish booting, and then restart your system and try again.

3. On the **System Setup Main Menu** screen, click **System BIOS**.
4. On the **System BIOS** screen, click **Miscellaneous Settings**.

Miscellaneous Settings details

About this task

The **Miscellaneous Settings** screen details are explained as follows:

Option	Description
System Time	Enables you to set the time on the system.
System Date	Enables you to set the date on the system.
Asset Tag	Specifies the asset tag and enables you to modify it for security and tracking purposes.
Keyboard NumLock	Enables you to set whether the system boots with the NumLock enabled or disabled. This option is set to On by default.  NOTE: This option does not apply to 84-key keyboards.
F1/F2 Prompt on Error	Enables or disables the F1/F2 prompt on error. This option is set to Enabled by default. The F1/F2 prompt also includes keyboard errors.
Load Legacy Video Option ROM	Enables you to determine whether the system BIOS loads the legacy video (INT 10H) option ROM from the video controller. Selecting Enabled in the operating system does not support UEFI video output standards. This field is available only for UEFI boot mode. You cannot set the option to Enabled if UEFI Secure Boot mode is enabled. This option is set to Disabled by default.
Dell Wyse P25/P45 BIOS Access	Enables or disables the Dell Wyse P25/P45 BIOS Access. This option is set to Enabled by default.
Power Cycle Request	Enables or disables the Power Cycle Request. This option is set to None by default.

iDRAC Settings utility

The iDRAC settings utility is an interface to set up and configure the iDRAC parameters by using UEFI. You can enable or disable various iDRAC parameters by using the iDRAC settings utility.

 **NOTE: Accessing some of the features on the iDRAC settings utility needs the iDRAC Enterprise License upgrade.**

For more information about using iDRAC, see *Dell Integrated Dell Remote Access Controller User's Guide* at www.dell.com/poweredgemanuals.

Device Settings

Device Settings enables you to configure the below device parameters:

- Controller Configuration Utility
- Embedded NIC Port1-X Configuration
- NICs in slotX, Port1-X Configuration
- BOSS Card configuration

Dell Lifecycle Controller

Dell Lifecycle Controller (LC) provides advanced embedded systems management capabilities including system deployment, configuration, update, maintenance, and diagnosis. LC is delivered as part of the iDRAC out-of-band solution and Dell system embedded Unified Extensible Firmware Interface (UEFI) applications.

Embedded system management

The Dell Lifecycle Controller provides advanced embedded system management throughout the lifecycle of the system. The Dell Lifecycle Controller can be started during the boot sequence and can function independently of the operating system.

 **NOTE: Certain platform configurations may not support the full set of features provided by the Dell Lifecycle Controller.**

For more information about setting up the Dell Lifecycle Controller, configuring hardware and firmware, and deploying the operating system, see the Dell Lifecycle Controller documentation at www.dell.com/poweredgemanuals.

Boot Manager

The **Boot Manager** screen enables you to select boot options and diagnostic utilities.

Viewing Boot Manager

About this task

To enter Boot Manager:

Steps

1. Power on, or restart your system.
2. Press F11 when you see the following message:
`F11 = Boot Manager`
If your operating system begins to load before you press F11, allow the system to complete the booting, and then restart your system and try again.

Boot Manager main menu

Menu item	Description
Continue Normal Boot	The system attempts to boot to devices starting with the first item in the boot order. If the boot attempt fails, the system continues with the next item in the boot order until the boot is successful or no more boot options are found.
One-shot Boot Menu	Enables you to access boot menu, where you can select a one-time boot device to boot from.
Launch System Setup	Enables you to access System Setup.
Launch Lifecycle Controller	Exits the Boot Manager and invokes the Dell Lifecycle Controller program.
System Utilities	Enables you to launch System Utilities menu such as System Diagnostics and UEFI shell.

One-shot UEFI boot menu

One-shot UEFI boot menu enables you to select a boot device to boot from.

System Utilities

System Utilities contains the following utilities that can be launched:

- Launch Diagnostics
- BIOS Update File Explorer
- Reboot System







PXE boot

You can use the Preboot Execution Environment (PXE) option to boot and configure the networked systems, remotely.

To access the **PXE boot** option, boot the system and then press F12 during POST instead of using standard Boot Sequence from BIOS Setup. It does not pull any menu or allows managing of network devices.

PowerEdge T140 installing and removing system components

Safety instructions

-  **NOTE:** Whenever you need to lift the system, get others to assist you. To avoid injury, do not attempt to lift the system by yourself.
-  **WARNING:** Opening or removing the system cover while the system is powered on may expose you to a risk of electric shock.
-  **CAUTION:** Do not operate the system without the cover for a duration exceeding five minutes. Operating the system without the system cover can result in component damage.
-  **CAUTION:** Many repairs may only be done by a certified service technician. You should only perform troubleshooting and simple repairs as authorized in your product documentation, or as directed by the online or telephone service and support team. Damage due to servicing that is not authorized by Dell is not covered by your warranty. Read and follow the safety instructions that are shipped with your product.
-  **CAUTION:** To ensure proper operation and cooling, all bays in the system and system fans must be always populated with a component or a blank.
-  **NOTE:** It is recommended that you always use an antistatic mat and antistatic strap while working on components inside the system.

Before working inside your system

Prerequisites

Follow the safety guidelines listed in [Safety instructions](#).

Steps

1. Power off the system and all attached peripherals.
2. Disconnect the system from the electrical outlet, and disconnect the peripherals.
3. Remove the system cover.

After working inside your system

Prerequisites

Follow the safety guidelines listed in [Safety instructions](#).

Steps

1. [Install the system cover](#).
2. Place the system upright on a flat, stable surface.
3. Reconnect the peripherals and connect the system to the electrical outlet.
4. Power on the attached peripherals and then power on the system.

Recommended tools

You need the following tools to perform the removal and installation procedures:

- Phillips #1 screwdriver
- Phillips #2 screwdriver
- Torx #T15 screwdriver
- 5mm hex nut screwdriver
- Plastic scribe
- Wrist grounding strap connected to the ground
- ESD mat

System cover

Removing the system cover

Prerequisites

1. Follow the safety guidelines listed in [Safety instructions](#).
2. Power off the system and all attached peripherals.
3. Disconnect the system from the electrical outlet and peripherals.
4. Place the system on a flat, stable surface.

NOTE: Ensure that the lock on the side of the system cover is unlocked.

Steps

Lift the cover release latch and remove the system cover.



Figure 9. Removing the system cover

Next steps

1. [Replace the system cover](#).

Installing the system cover

Prerequisites

1. Follow the safety guidelines listed in [Safety instructions](#).
2. Ensure that all internal cables are routed, connected, and that no tools or extra parts are left inside the system.

Steps

1. Align the tabs on the system cover with the corresponding slots on the system.
2. Press the system cover until it clicks into place.



Figure 10. Installing the system cover

Next steps

1. Place the system upright on a flat, stable surface.
2. Reconnect the peripherals and connect the system to the electrical outlet.
3. Power on the system, including any attached peripherals.

Front bezel

Removing the front bezel

Prerequisites

1. Follow the safety guidelines listed in [Safety instructions](#).
2. Follow the procedure that is listed in [Before working inside your system](#).

Steps

1. Lift the retention clips at the edge of the bezel to release the bezel from the system.
2. Unhook the bezel tabs and pull the bezel away from the system.

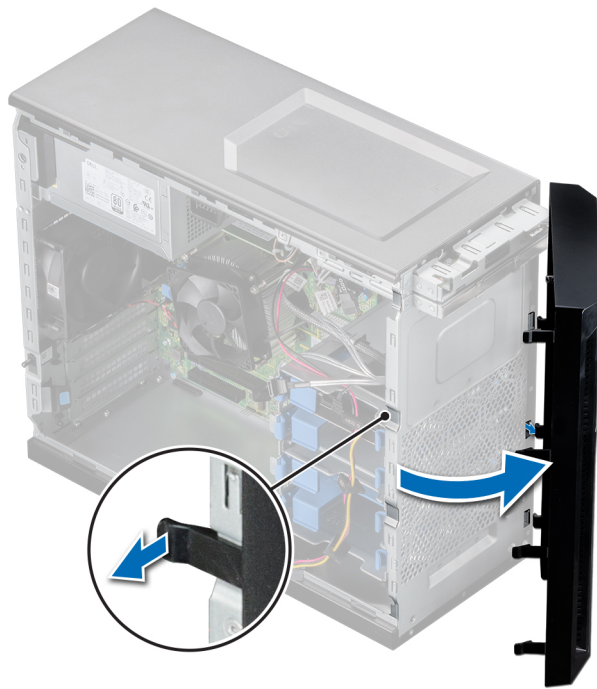

Figure 11. Removing the front bezel

Next steps

1. [Replace the front bezel.](#)

Installing the front bezel

Prerequisites

1. Follow the safety guidelines listed in [Safety instructions](#).
2. Follow the procedure that is listed in [Before working inside your system](#).

Steps

1. Place the bezel tabs into the bezel slots in the system.
2. Press the bezel into the system until the retention clips lock into place.

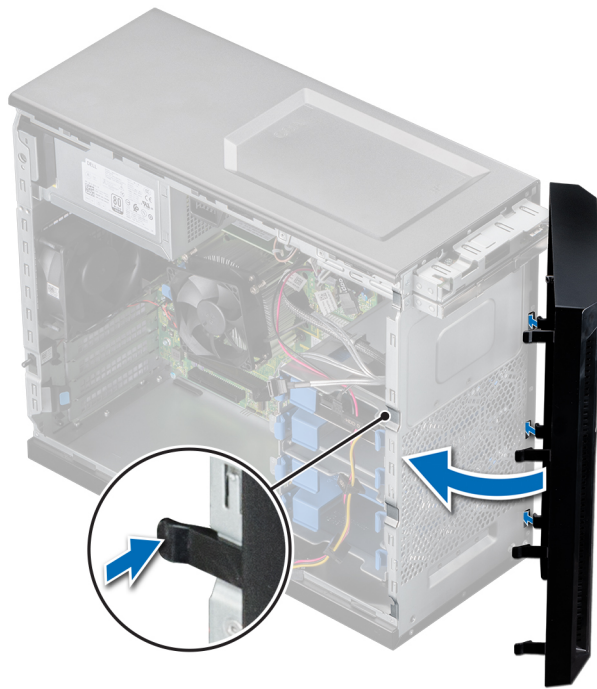

Figure 12. Installing the front bezel

Next steps

1. Follow the procedure that is listed in [After working inside your system](#).

Drives

Removing a 3.5-inch drive carrier from the drive bay

Prerequisites

1. Follow the safety guidelines listed in [Safety instructions](#).
2. Follow the procedure that is listed in [Before working inside your system](#).
3. Disconnect the power and data cables from the drive carrier in the drive bay.
4. Using the management software, prepare the drive for removal. Power off the system completely and unplug cables before remove the drive. For more information, see the www.dell.com/storagecontrollermanuals.

CAUTION: Before attempting to remove or install a drive while the system is running, see the documentation for the storage controller card to ensure that the host adapter is configured correctly to support drive removal and insertion.

CAUTION: Mixing drive carriers from previous generations of PowerEdge servers is not supported.

NOTE: To prevent data loss, ensure that your operating system supports drive installation. See the documentation supplied with your operating system.

Steps

Press the retention clips and lift the drive carrier out from the drive bay.

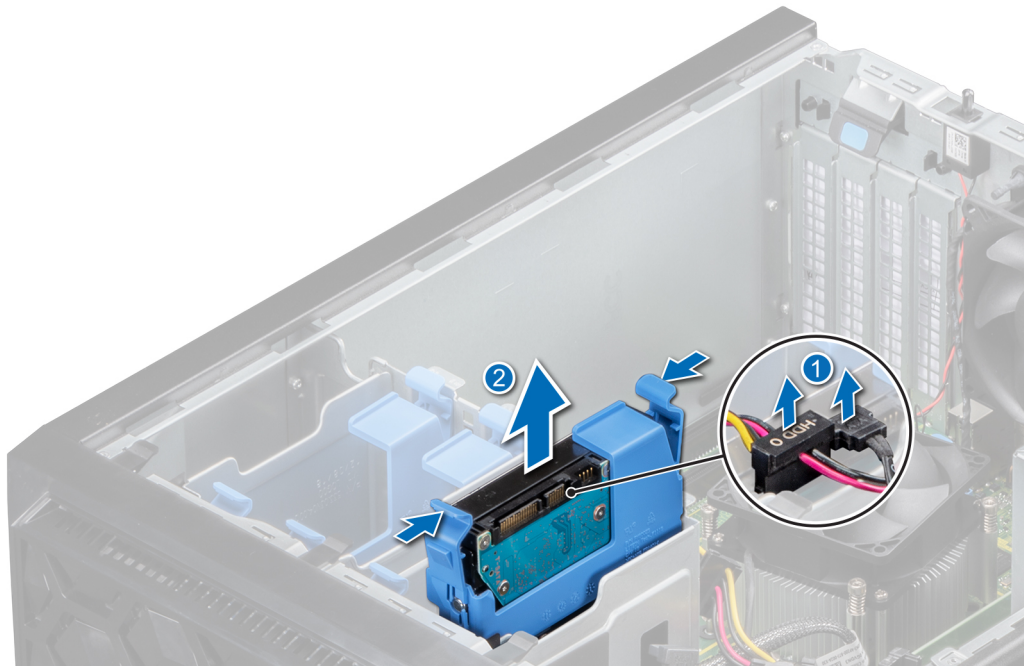

Figure 13. Removing the drive carrier from the drive bay

Next steps

1. [Replace the drive carrier into the drive bay.](#)

Installing a 3.5-inch drive carrier into the drive bay

Prerequisites

- ⚠ **CAUTION:** Before attempting to remove or install a drive while the system is running, see the documentation for the storage controller card to ensure that the host adapter is configured correctly to support drive removal and insertion.
- ⚠ **CAUTION:** Combining SAS and SATA drives in the same RAID volume is not supported.
- ⚠ **CAUTION:** When installing a drive, ensure that the adjacent drives are fully installed. Inserting a drive carrier and attempting to lock its handle next to a partially installed carrier can damage the partially installed carrier's shield spring and make it unusable.
- ⚠ **CAUTION:** To prevent data loss, ensure that your operating system supports hot-swap drive installation. See the documentation supplied with your operating system.
- ⚠ **CAUTION:** When a replacement hot swappable drive is installed and the system is powered on, the drive automatically begins to rebuild. Ensure that the replacement drive is blank or contains data that you want to overwrite. Any data on the replacement drive is immediately lost after the drive is installed.

1. Follow the safety guidelines listed in [Safety instructions](#).
2. Follow the procedure that is listed in [Before working inside your system](#).

Steps

Align and slide the drive carrier into the drive bay until it clicks into place.

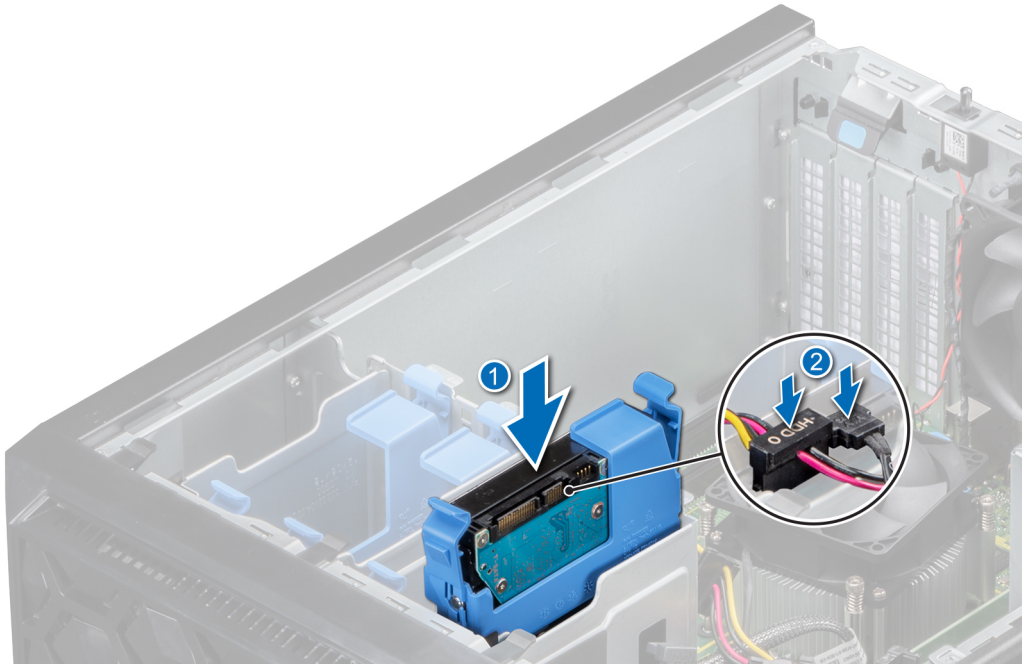

Figure 14. Installing the drive carrier into the drive bay

Next steps

1. Connect the power and data cables on the drive carrier.
2. Follow the procedure that is listed in [After working inside your system](#).

Removing a drive from the drive carrier

Prerequisites

1. Follow the safety guidelines listed in [Safety instructions](#).
2. Follow the procedure that is listed in [Before working inside your system](#).
3. [Remove a 3.5-inch drive carrier from the drive bay](#).

Steps

Flex the drive bracket and remove the drive from the carrier.

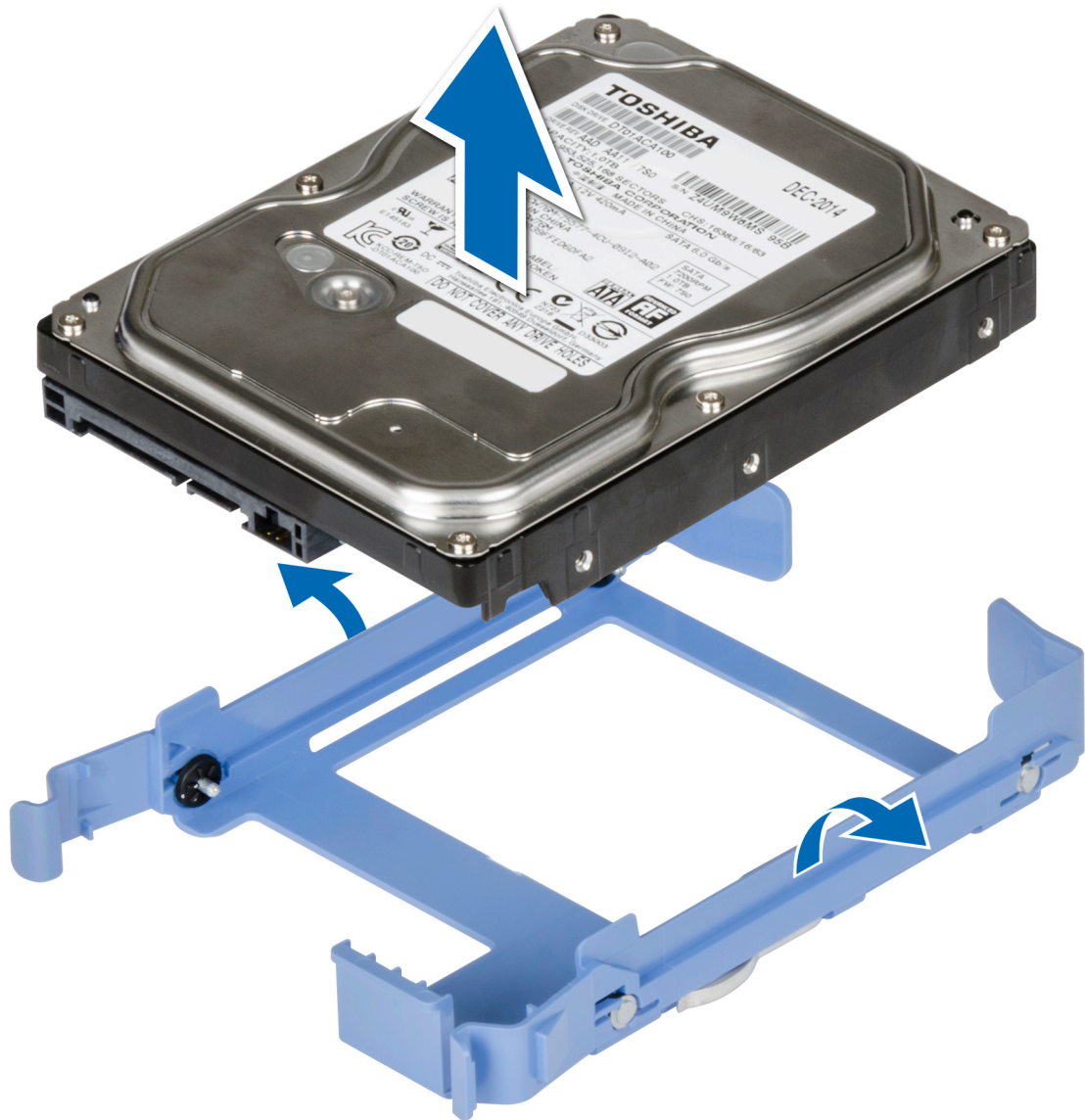

Figure 15. Removing the drive from the drive carrier

Next steps

1. Install the drive into the drive carrier.

Installing a drive into the drive carrier

Prerequisites

1. Follow the safety guidelines listed in [Safety instructions](#).
2. Follow the procedure that is listed in [Before working inside your system](#).
3. [Remove a 3.5-inch drive carrier from the drive bay](#).

Steps

1. Align the screw holes on one side of the drive with the pins on the drive carrier.
2. Flex the side of the drive carrier, and place the drive into the drive carrier.

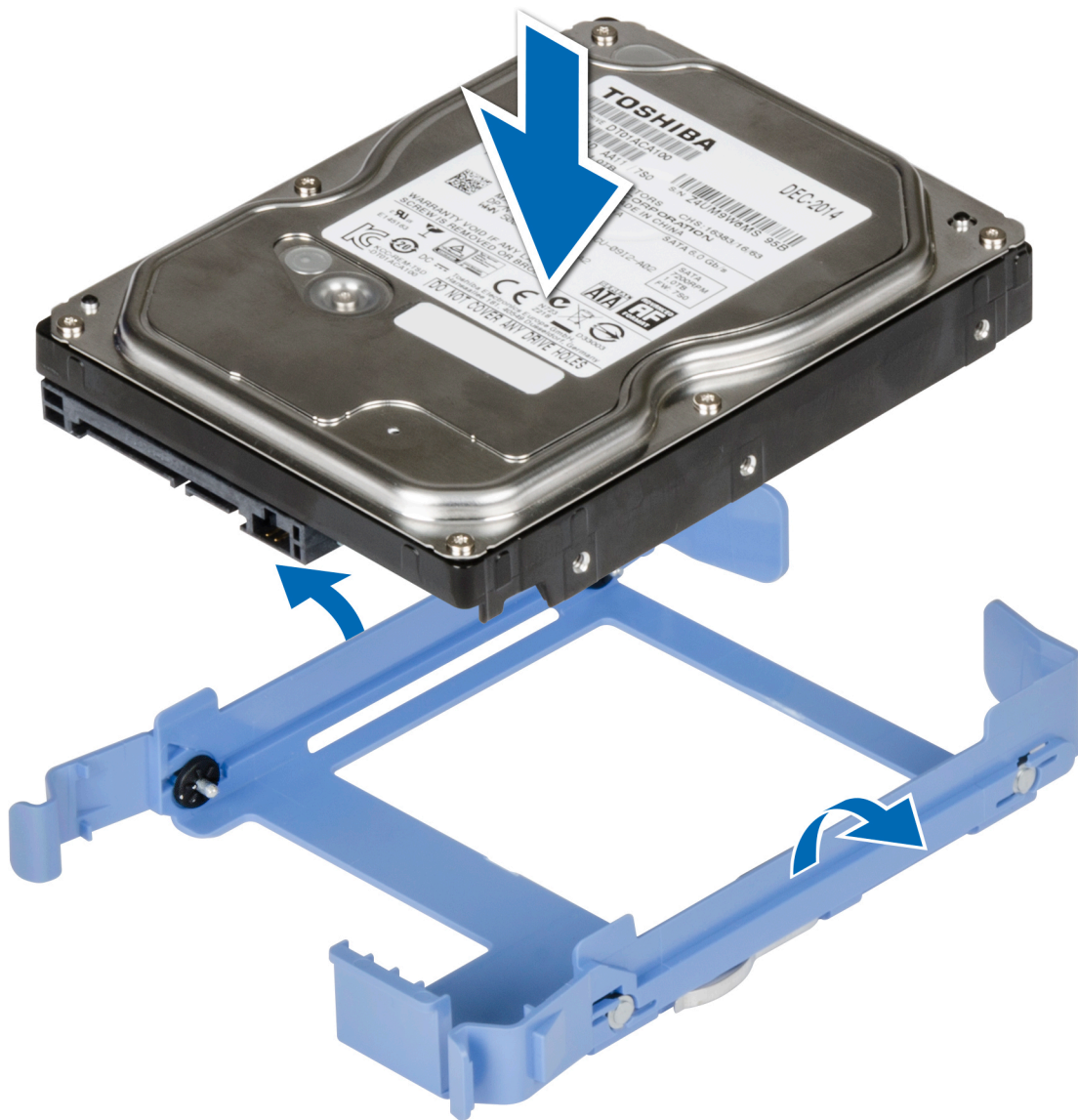

Figure 16. Installing a drive into the drive carrier

Next steps

1. Install a 3.5-drive carrier into the drive bay.
2. Follow the procedure that is listed in [After working inside your system](#).

Optional optical drive

Removing the optical drive fillers

Prerequisites

1. Follow the safety guidelines listed in [Safety instructions](#).
2. Follow the procedure that is listed in [Before working inside your system](#).
3. [Remove the front bezel](#).

NOTE: There are two optical drive fillers, plastic filler on the front bezel, and metal filler on the optical drive cage.

Steps

1. On the front bezel, press the retention clip of the optical drive filler and pull the filler out of the front bezel.

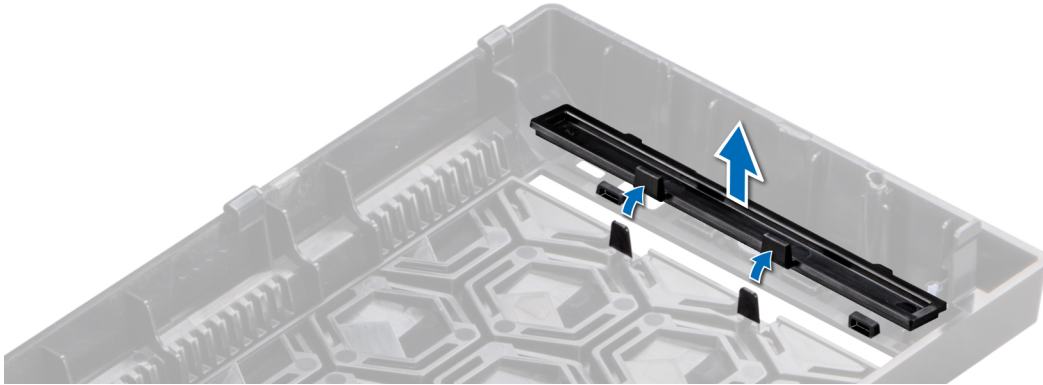

Figure 17. Removing the optical drive filler from the front bezel

2. On the optical drive cage, hold the tabs on the optical drive filler and remove the optical drive filler from the optical drive cage.



Figure 18. Removing the optical drive filler from the optical drive cage

Next steps

1. [Replace the optical drive filler](#) or [install the optical drive](#).

Installing the optical drive fillers

Prerequisites

1. Follow the safety guidelines listed in [Safety instructions](#).
2. Follow the procedure that is listed in [Before working inside your system](#).
3. [Remove the front bezel](#).

NOTE: There are two optical drive fillers, plastic filler on the front bezel, and metal filler on the optical drive cage.

Steps

1. On the front bezel, insert the tabs on optical drive blank into the slots and push the blank until it locks into place.

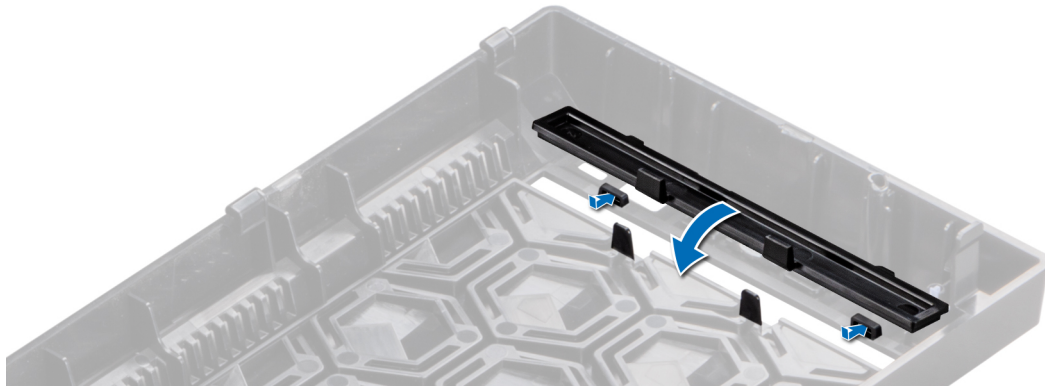

Figure 19. Installing the optical drive filler into the front bezel

2. On the optical drive cage, hold the tabs on the optical drive filler and push the optical drive filler into the optical drive cage.



Figure 20. Installing the optical drive filler into the optical drive cage

Next steps

1. [Install the front bezel.](#)
2. Follow the procedure that is listed in [After working inside your system.](#)

Removing the optical drive

Prerequisites

1. Follow the safety guidelines listed in [Safety instructions.](#)
2. Follow the procedure listed in [Before working inside your system.](#)
3. [Remove the front bezel.](#)
4. Disconnect the power and data cables from the back of the optical drive.

NOTE: Ensure that you note the routing of the power and data cable on the side of the system as you remove them from the system board and drive .

Steps

1. To release the optical drive, press and push the release tab toward the front of the system.
2. Slide the optical drive out of the system.
3. If you are not installing a new optical drive, [install the optical drive fillers.](#)

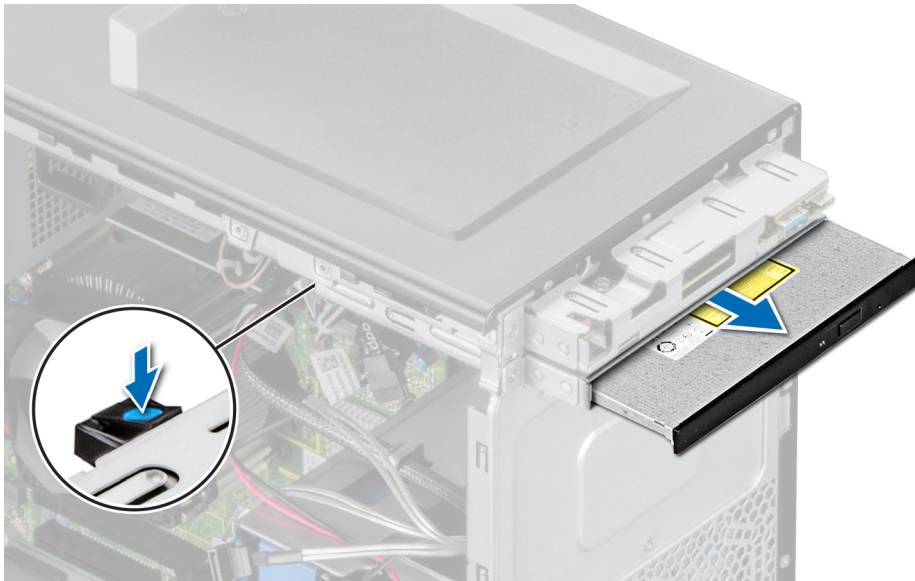

Figure 21. Removing the optical drive

Next steps

1. [Replace the optical drive.](#)

Installing the optical drive

Prerequisites

NOTE: Only slim 9.5-mm SATA DVD-ROM drive or DVD+/-RW drive can be installed in your system. External optical drives can be connected through USB ports.

1. Follow the safety guidelines listed in [Safety instructions](#).
2. Follow the procedure that is listed in [Before working inside your system](#).
3. [Remove the front bezel.](#)

Steps

1. Align the optical drive with the optical drive slot on the optical drive cage.
2. Slide the optical drive into the slot until the release tab snaps into place.



Figure 22. Installing the optical drive

Next steps

1. Connect the power cable and the data cable to the optical drive.
i **NOTE:** Route the cables properly to prevent them from being pinched or crimped.
2. [Install the front bezel.](#)
3. Follow the procedure that is listed in [After working inside your system.](#)

System memory

System memory guidelines

Your system contains four memory sockets that are organized into two channels. In each channel, the first socket is marked white and the second socket black.

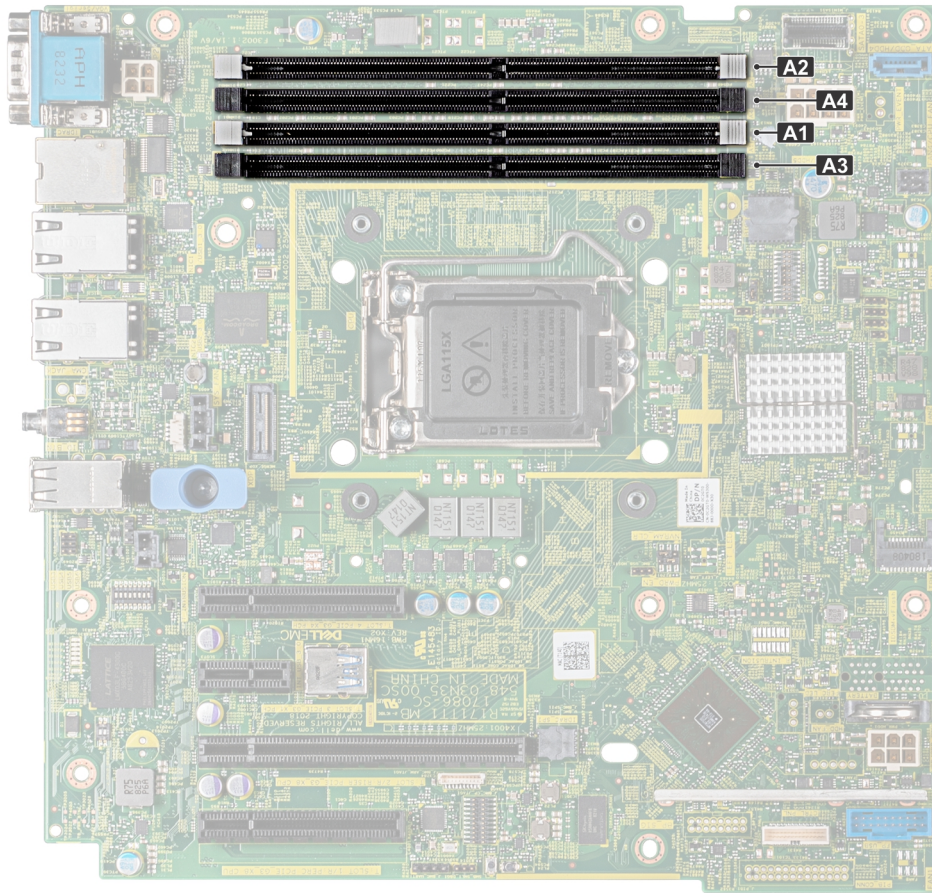

Figure 23. Memory socket locations on the system board

Memory channels are organized as follows:

Table 5. Memory channels

Channel 0	Channel 1
Slot A1 and A3	Slot A2 and A4

Table 6. Memory population

DIMM Type	DIMMs Ranking	Capacity	DIMM rated voltage, speed	13th Generation Memory (H3, 2DPC Platforms) *DPC means DIMMs per channel	
				1 DPS	2 DPS
UDIMM	1	8 GB, and 16 GB	DDR4 (1.2 V)	2666	2666
	2				

General memory module installation guidelines

To ensure optimal performance of your system, observe the following general guidelines when configuring your system memory. If your system's memory configurations fail to observe these guidelines, your system might not boot, stop responding during memory configuration, or operate with reduced memory.

The memory bus may operate at frequency can be 2666 MT/s, 2400 MT/s, or 2133 MT/s depending on the following factors:

- System profile selected (for example, Performance Optimized, or Custom [can be run at high speed or lower])
- Maximum supported DIMM speed of the processors.
- Maximum supported speed of the DIMMs

NOTE: MT/s indicates DIMM speed in MegaTransfers per second.

The system supports Flexible Memory Configuration, enabling the system to be configured and run in any valid chipset architectural configuration. The following are the recommended guidelines for installing memory modules:

- All DIMMs must be DDR4.
- A maximum of two different ranked DIMMs can be populated in a channel regardless of rank count.
- If memory modules with different speeds are installed, they will operate at the speed of the slowest installed memory module(s).
- Populate memory module sockets only if a processor is installed.
 - For single-processor systems, sockets A1 to A4 are available.
 - In **Optimizer Mode**, the DRAM controllers operate independently in the 64-bit mode and provide optimized memory performance.

Table 7. Memory population rules

Processor	Configuration	Memory population	Memory population information
Single processor	Optimizer (Independent channel) population order	1, 2, 3, 4	Odd amount of DIMMs per processor allowed.

- Populate all the sockets with white release tabs first, followed by the black release tabs.
- When mixing memory modules with different capacities, populate the sockets with memory modules with the highest capacity first.

For example, if you want to mix 8 GB and 16 GB memory modules, populate 16 GB memory modules in the sockets with white release tabs and 8 GB memory modules in the sockets with black release tabs.
- Memory modules of different capacities can be mixed provided other memory population rules are followed.

For example, 8 GB and 16 GB memory modules can be mixed.
- Mixing of more than two memory module capacities in a system is not supported.
- Unbalanced memory configurations will result in a performance loss so always populate memory channels identically with identical DIMMs for best performance.
- To ensure proper system cooling, memory module blanks must be installed in memory sockets that are not occupied.

Removing a memory module

Prerequisites

WARNING: Allow the memory modules to cool after you power off the system. Handle the memory modules by the card edges and avoid touching the components or metallic contacts on the memory module.

CAUTION: To ensure proper system cooling, memory module blanks must be installed in any memory socket that is not occupied. Remove memory module blanks only if you intend to install memory modules in those sockets.

1. Follow the safety guidelines listed in [Safety guidelines](#).
2. Follow the procedure listed in [Before working inside your system](#).

Steps

1. Locate the appropriate memory module socket.

CAUTION: Handle each memory module only by the card edges, ensuring not to touch the middle of the memory module or metallic contacts.

2. Push the ejectors outward on both ends of the memory module socket to release the memory module from the socket.
3. Lift and remove the memory module from the system.

NOTE: If you are removing the memory module permanently, install a memory module blank. The procedure to install a memory module blank is similar to that of the memory module.

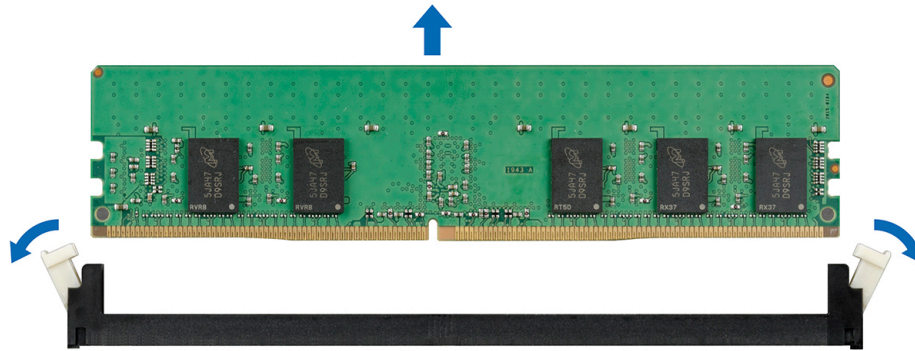

Figure 24. Removing a memory module

Next steps

1. [Replace a memory module.](#)

Installing a memory module

Prerequisites

1. Follow the safety guidelines listed in [Safety instructions](#).
2. Follow the procedure that is listed in [Before working inside your system](#).

Steps

1. Locate the appropriate memory module socket.

CAUTION: Handle each memory module only by the card edges, ensuring not to touch the middle of the memory module or metallic contacts.

CAUTION: To prevent damage to the memory module or the memory module socket during installation, do not bend or flex the memory module; insert both ends of the memory module simultaneously.

2. Open the ejectors on the memory module socket outward to allow the memory module to be inserted into the socket.
3. Align the edge connector of the memory module with the alignment key of the memory module socket, and insert the memory module in the socket.

CAUTION: Do not apply pressure at the center of the memory module; apply pressure at both ends of the memory module evenly.

NOTE: The memory module socket has an alignment key that enables you to install the memory module in the socket in only one orientation.

4. Press the memory module with your thumbs until the socket levers firmly click into place.

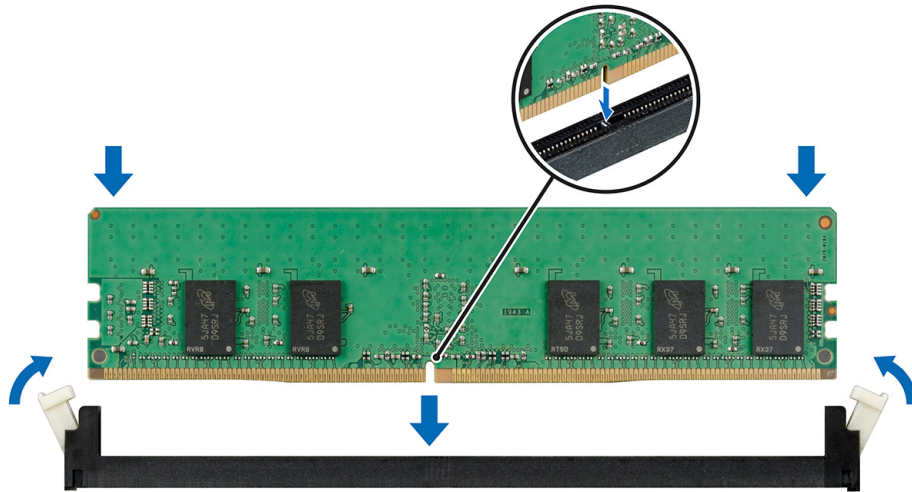

Figure 25. Installing a memory module

Next steps

1. Follow the procedure listed in [After working inside your system](#).
2. To verify if the memory module has been installed properly, press F2 and navigate to System Setup Main Menu > System BIOS > Memory Settings . In the Memory Settings screen, the System Memory Size must reflect the updated capacity of the installed memory. If the value is incorrect, one or more of the memory modules may not be installed properly. Ensure that the memory modules are firmly seated in the sockets. Run the system memory test in system diagnostics.

Cooling fan

Removing the cooling fan

Prerequisites

CAUTION: Do not remove or install the fan by holding the blades.

CAUTION: Never operate your system with the system fan removed. System can overheat and result in shutdown of the system and loss of data.

1. Follow the safety guidelines listed in [Safety instructions](#).
2. Follow the procedure that is listed in [Before working inside your system](#).

Steps

1. Disconnect the fan power cable from the system board connector.
2. To ease removal of the fan, stretch the grommets securing the fan to the system.
3. Hold the fan by the sides, and slide it out of the grommet.
4. Repeat steps 2 and 3 to release the fan from the remaining grommets.



Figure 26. Removing the cooling fan

Next steps

1. [Replace the cooling fan.](#)

Installing a cooling fan

Prerequisites

CAUTION: Do not remove or install the cooling fan by holding the blades.

1. Follow the safety guidelines listed in [Safety instructions](#).
2. Follow the procedure that is listed in [Before working inside your system](#).

Steps

1. Hold the cooling fan by the sides with the cable end facing the bottom of the system.
2. Align the four grommets on the system with the four holes on the sides of the cooling fan.

NOTE: It is recommended to first install the lower two grommets.

3. Pass the grommets through the corresponding holes on the cooling fan.
4. Stretch the grommets and push the cooling fan toward the system until it is secured in place.
5. Connect the cooling fan power cable to the connector on the system board.

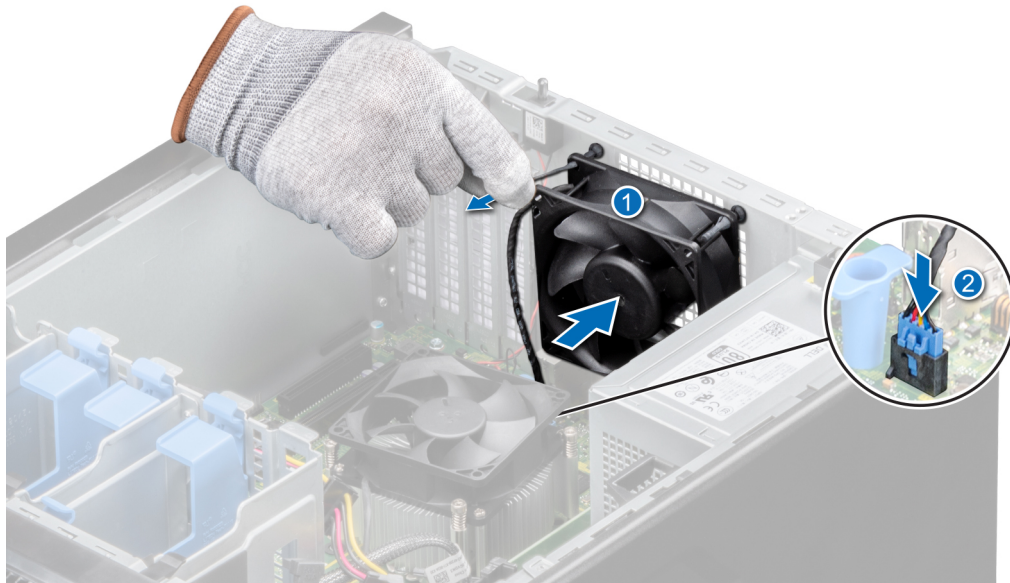

Figure 27. Installing a cooling fan

Next steps

1. Follow the procedure that is listed in [After working inside your system](#).

Optional internal USB memory key

NOTE: To locate the internal USB port on the system board, see the [System board jumpers and connectors](#) section.

Replacing the optional internal USB memory key

Prerequisites

CAUTION: To avoid interference with other components in the server, the maximum permissible dimensions of the USB memory key: 15.9 mm width x 57.15 mm length x 7.9 mm height.

1. Follow the safety guidelines listed in the [Safety instructions](#).
2. Follow the procedure listed in the [Before working inside your system](#).

Steps

1. Locate the USB port or USB memory key on the system board.
To locate the USB port, see the [System board jumper and connectors](#) section.
2. If installed, remove the USB memory key from the USB port.
3. Insert the replacement USB memory key into the USB port.

Next steps

1. Follow the procedure that is listed in [After working inside your system](#).
2. While booting, press F2 to enter System Setup and verify that the system detects the USB memory key.

Expansion cards

NOTE: A System Event Log (SEL) event is logged if an expansion card riser is not supported or missing. It does not prevent your system from turning on. However, if a F1/F2 pause occurs with an error message, see [Troubleshooting](#)

Expansion card installation guidelines

Table 8. PCI Express Generation 3 expansion cards supported

PCIe Slot	Height	Length	Link Width	Slot Width
1	Full Height	Half Length	PCIe x 8 Gen3	x8
2	Full Height	Half Length	PCIe x 8 Gen3	x16
3	Full Height	Half Length	PCIe x 1 Gen3	x1
4	Full Height	Half Length	PCIe x 4 Gen3	x8

NOTE: The expansion cards are not hot swappable.

NOTE: For a system with 4 TB (or more) drive capacity, PERC is required for thermal control.

The following table describes the installation order for installing expansion cards to ensure proper cooling and mechanical fit: The expansion cards with the highest priority must be installed first by using the slot priority indicated.

Table 9. Expansion card installation order

Card Priority	Category	Card Type	Form factor	Slot Priority	Maximum Allowed	Card width	Card length	Card height	Maximum PCIe width
1	NIC	1-Gb NICs Quad Port (Broadcom)	Full Height	1, 2, 4	3	Single width	Half length	Full height	x 4
2	NIC	1-Gb NICs Quad Port (Intel)	Full Height	1, 2, 4	3	Single width	Half length	Full height	x 4
3	NIC	1-Gb NICs Dual Port (Broadcom)	Full Height	1, 2, 3, 4	4	Single width	Half length	Full height	x 1
4	NIC	1-Gb NICs Dual Port (Intel)	Full Height	1, 2, 4	3	Single width	Half length	Full height	x 4
5	Internal Adapter	PowerEdge RAID Controller (PERC) H730P	Full Height	2	1	Single width	Half length	Full height	x 8
6	Internal Adapter	PowerEdge RAID Controller (PERC) H330	Full Height	2	1	Single width	Half length	Full height	x 8
7	Internal Adapter	HBA330	Full Height	2	1	Single width	Half length	Full height	x 8
8	External Adapter	12-GB SAS HBA	Full Height	2	1	Single width	Half length	Full height	x 8
9	Internal storage	BOSS	Full Height	1, 2, 4	1	Single width	Half length	Full height	x 2

Removing a PCIe expansion card

Prerequisites

1. Follow the safety guidelines listed in [Safety instructions](#).
2. Follow the procedure that is listed in [Before working inside your system](#).
3. Disconnect any cables that are connected to the expansion card.

Steps

1. Press the blue expansion card retention latch and push down the latch to open it.
2. Holding the card by its edge, pull the card to disengage it from the connector and lift the card out of the system.

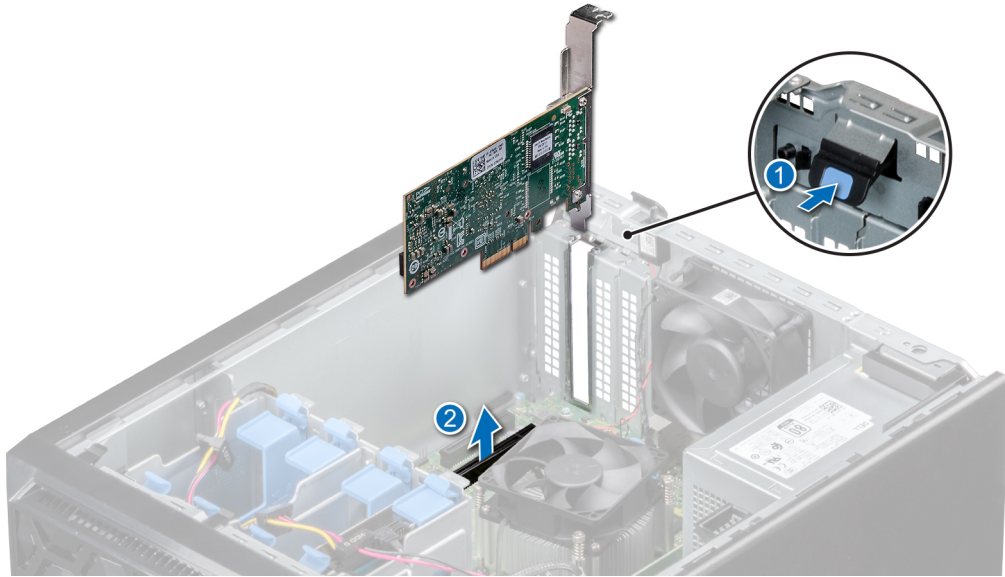

Figure 28. Removing a PCIe expansion card

3. If you are not replacing the expansion card, install a filler bracket by performing the following steps:
 - a) Align the slot on the filler bracket with the tab on the expansion card slot.
 - b) Align the filler bracket with the slot on the system.
 - c) Push the filler bracket downward until firmly seated.
 - d) Close the expansion card retention latch.

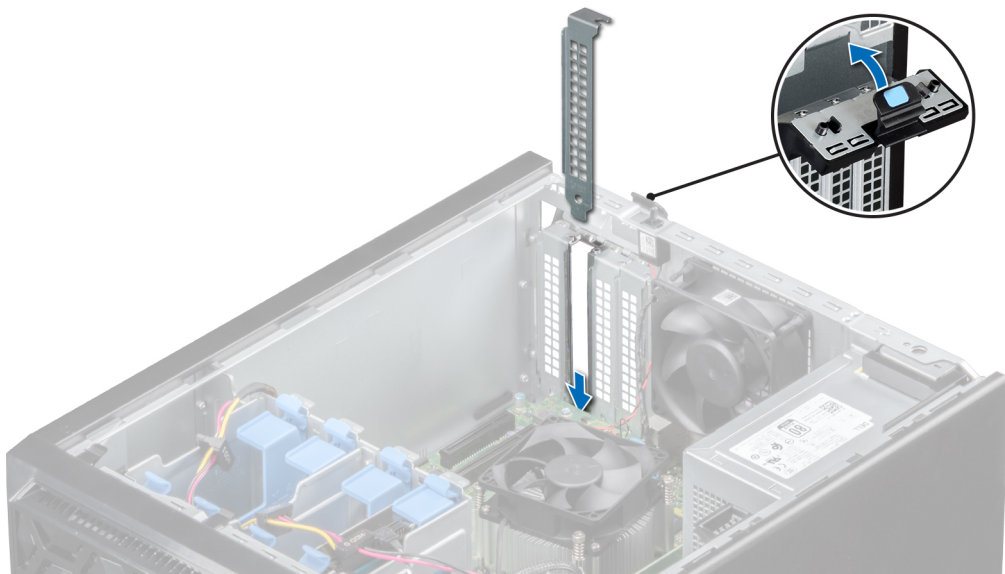

Figure 29. Installing the filler bracket

Next steps

1. [Replace the expansion card.](#)

Installing a PCIe expansion card

Prerequisites

1. Follow the safety guidelines listed in [Safety instructions](#).
2. Follow the procedure that is listed in [Before working inside your system](#).

Steps

1. Unpack the expansion card and prepare it for installation.

i **NOTE:** For instructions, see the documentation accompanying the card.

2. Press and push out the expansion card release latch to open it.
3. Remove the expansion card or filler bracket from the expansion card holder.

i **NOTE:** Store this bracket for future use. Filler brackets must be installed in empty expansion-card slots to maintain FCC certification of the system. The brackets also keep dust and dirt out of the system and aid in proper cooling and airflow inside the system.

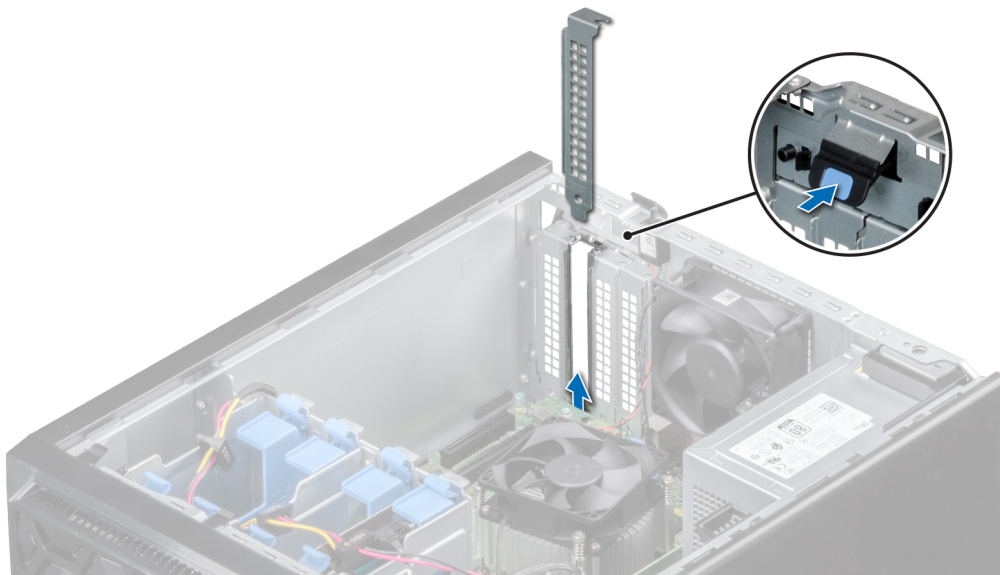

Figure 30. Removing the filler bracket

4. Holding the card by its edges, position the card so that the card aligns with the expansion card connector.
5. Insert the card firmly into the expansion card connector until the card is fully seated.
6. Close the expansion card latch by pushing the latch up until the latch snaps into place.

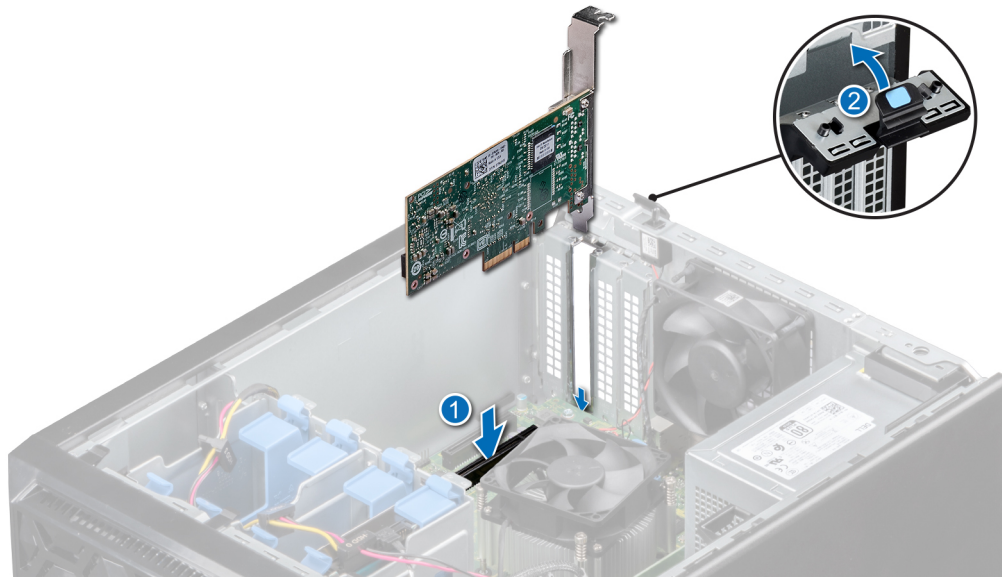

Figure 31. Installing a PCIe expansion card

Next steps

1. Connect the cables to the expansion card.
2. Install any device drivers required for the card as described in the documentation for the card.
3. Follow the procedure that is listed in [After working inside your system](#).

Storage controller card

Removing the integrated storage controller card

Prerequisites

1. Follow the safety guidelines listed in [Safety instructions](#).
2. Follow the procedure that is listed in [Before working inside your system](#).
3. Press the release tab on the SAS cable connector to disconnect the cable from the storage controller card.

Steps

1. Press the expansion card retention latch and push down the latch to open it.
2. Hold the expansion card by the edge, and pull the card to disconnect from the system board connector.

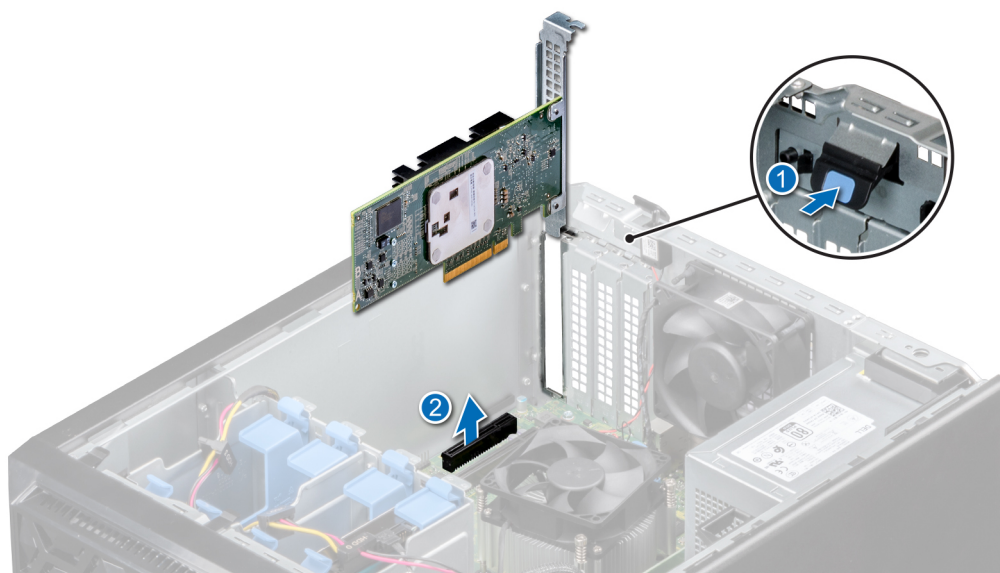

Figure 32. Removing the integrated storage controller card

3. If you are not replacing the integrated storage controller card, install a filler bracket.

NOTE: Installing the filler bracket for integrated storage controller card is similar to installing the filler bracket under, removing a PCIe expansion card section.

Next steps

1. [Replace the integrated storage controller card.](#)

Installing an integrated storage controller card

Prerequisites

1. Follow the safety guidelines listed in [Safety instructions](#).
2. Follow the procedure that is listed in [Before working inside your system](#).

Steps

1. If you are installing a new card, remove the filler bracket by performing the following steps:
 - a) Open the blue expansion card retention latch lock.
 - b) Slide the filler bracket out of the system.

NOTE: Removing the filler bracket for integrated storage controller card is similar to removing the filler bracket under, installing a PCIe expansion card section.

NOTE: Store this bracket for future use. Filler brackets must be installed in empty expansion-card slots to maintain FCC certification of the system. The brackets also keep dust and dirt out of the system and aid in proper cooling and airflow inside the system.

2. Hold the storage controller card by the edges, and align the connector on the card with the connector on the system board.
3. Lower the card into the system until the card is firmly seated.
4. Close the expansion card retention latch by pushing the latch up until the latch snaps into place.

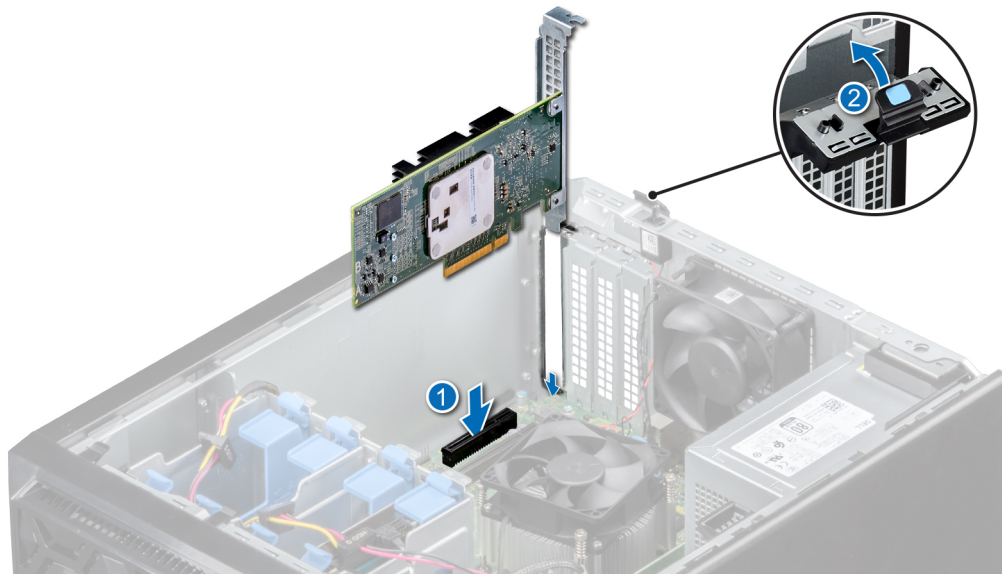

Figure 33. Installing an integrated storage controller card

Next steps

1. Connect the SAS cables to the integrated storage controller card.
2. Follow the procedure that is listed in [After working inside your system.](#)

Cable routing

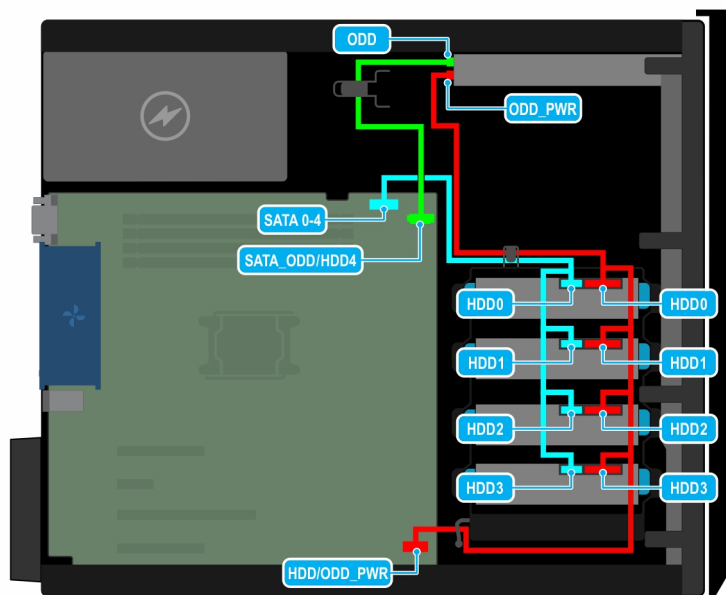

Figure 34. Cable routing - four 3.5-inch cabled SATA drive

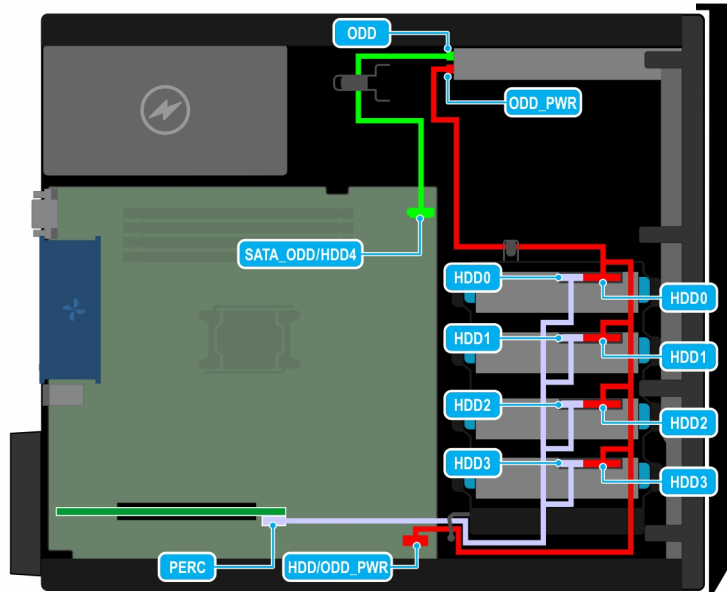

Figure 35. Cable routing - four 3.5-inch cabled SAS drive with storage controller card

M.2 SSD module

Removing the M.2 SSD module

Prerequisites

1. Follow the safety guidelines listed in [Safety instructions](#).
2. Follow the procedure listed in [Before working inside your system](#).
3. Remove the BOSS card.

NOTE: The procedure to remove the BOSS card is similar to removing an expansion card.

Steps

1. Using the Phillips #1 screwdriver, remove the screws securing the M.2 SSD module to the BOSS card.
2. Pull the M.2 SSD module to disconnect from the BOSS card connector.

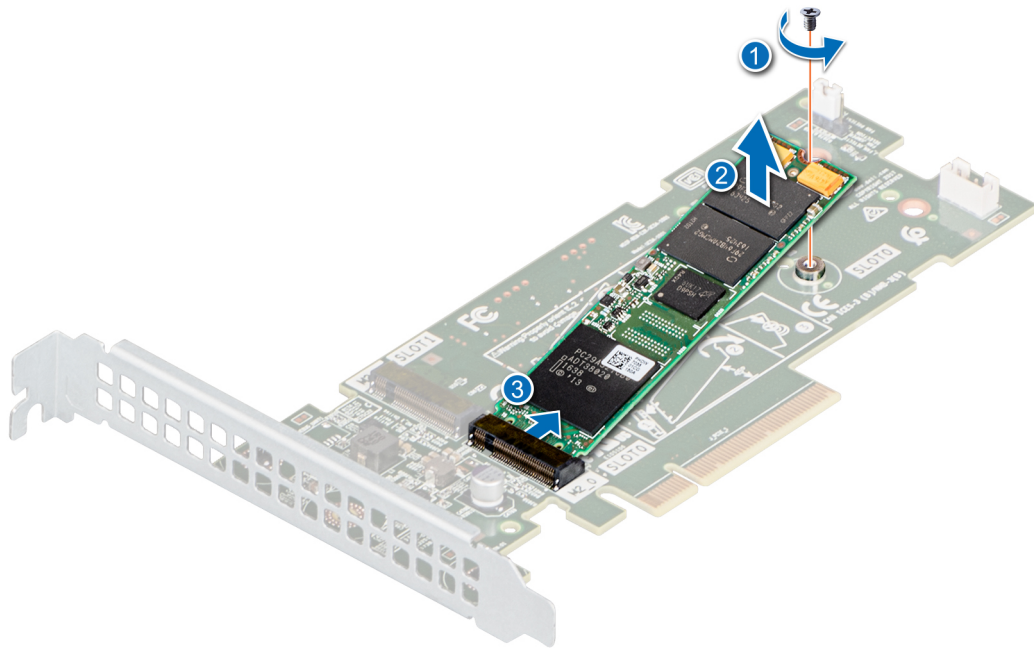

Figure 36. Removing the M.2 SSD module

Next steps

Replace the M.2 SSD module.

Installing the M.2 SSD module

Prerequisites

1. Follow the safety guidelines listed in [Safety instructions](#).
2. Follow the procedure listed in [Before working inside your system](#).
3. Remove the BOSS card.

NOTE: The procedure to remove the BOSS card is similar to the removing an expansion card.

Steps

1. Align the M.2 SSD module at an angle with the BOSS card connector.
2. Insert the M.2 SSD module until it is firmly seated in the BOSS card connector.
3. Using the Phillips #1 screwdriver, secure the M.2 SSD module on the BOSS card with the screw.

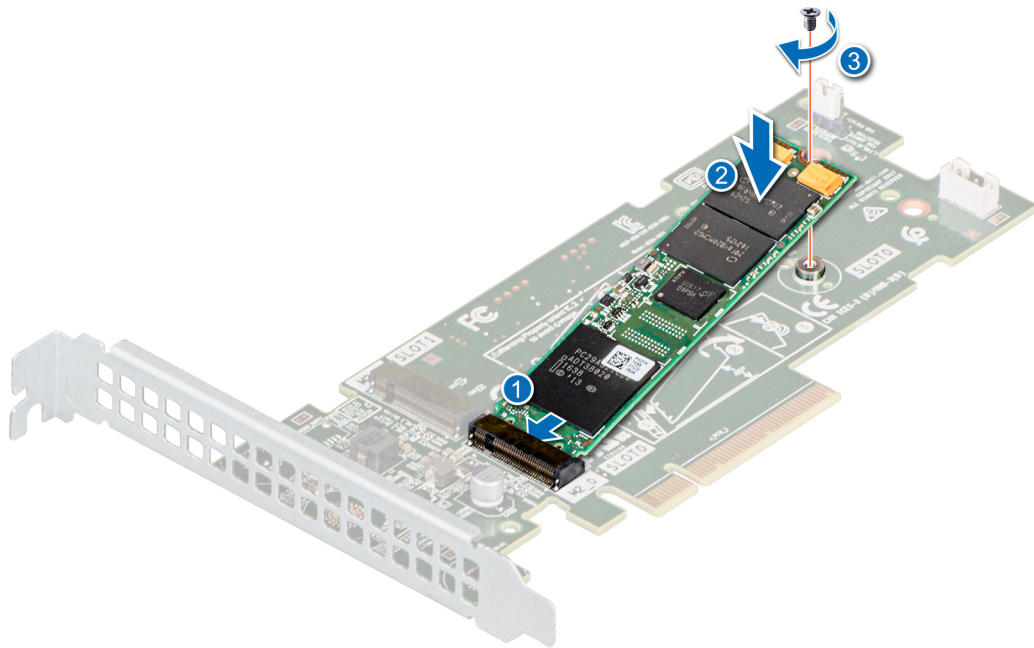

Figure 37. Installing the M.2 SSD module

Next steps

1. Install the BOSS card.

NOTE: The procedure to install the BOSS card is similar to removing an expansion card.

2. Follow the procedure listed in the [After working inside your system](#).

Processor and heat sink

Removing the heat sink module

Prerequisites

WARNING: The heat sink may be hot to touch for some time after the system has been powered off. Allow the heat sink to cool before removing it.

1. Follow the safety guidelines listed in [Safety instructions](#).
2. Follow the procedure that is listed in [Before working inside your system](#).

Steps

1. Disconnect the heat sink fan power cable connector from the connector on the system board.
2. Using a Phillips #2 screwdriver, loosen the screws on the heat sink in the order following:
 - a) Partially loosen the first screw (approximately 3 turns).
 - b) Loosen the diagonally opposite screw completely.
 - c) Return to the first screw and loosen it completely.
 - d) Repeat the procedure for the remaining two screws.
3. Lift the heat sink away from the system.

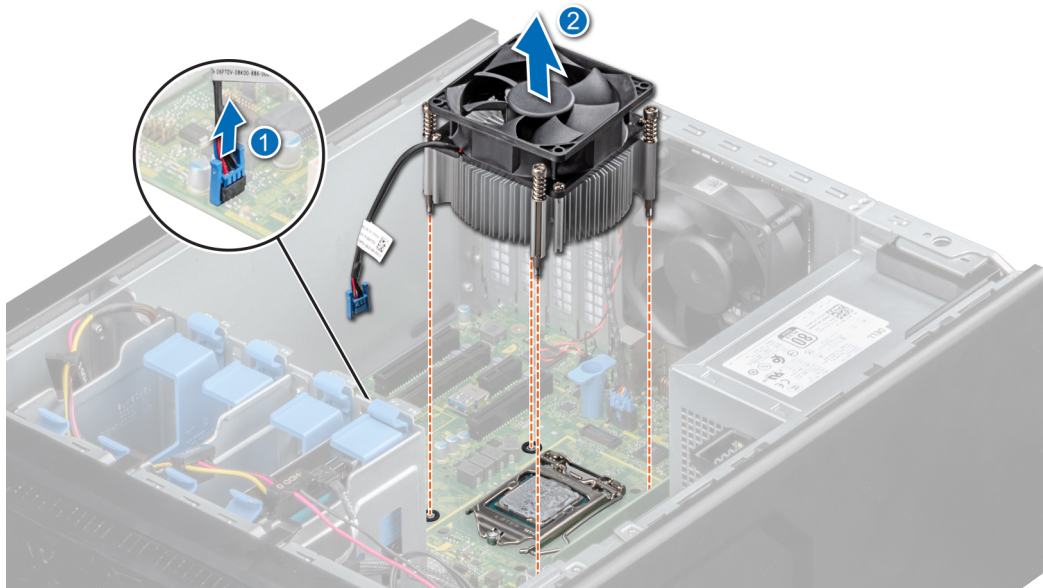

Figure 38. Removing the heat sink

Next steps

1. [Replace the heat sink module.](#)

Removing the processor

Prerequisites

- ⚠ WARNING:** The processor will be hot to touch for some time after the system has been powered down. Allow the processor to cool before removing it.
 - ⚠ CAUTION:** The processor is held in its socket under strong pressure. Be aware that the release lever can spring up suddenly if not firmly held.
 - ℹ NOTE:** Only remove the processor if you are replacing the processor or system board. This procedure is not required when replacing a heat sink module.
1. Follow the safety guidelines listed in [Safety instructions](#).
 2. Follow the procedure that is listed in [Before working inside your system](#).
 3. [Remove the heat sink module.](#)

Steps

1. Release the socket lever by pushing the lever down and out from under the tab on the processor shield.
2. Lift the lever upward until the processor shield lifts.
 - ⚠ CAUTION:** The processor socket pins are fragile and can be permanently damaged. Be careful not to bend the pins in the processor socket when removing the processor out of the socket.
3. Lift the processor out of the socket.
 - ℹ NOTE:** Ensure that the processor and the bracket are placed in the tray after you remove the heat sink.

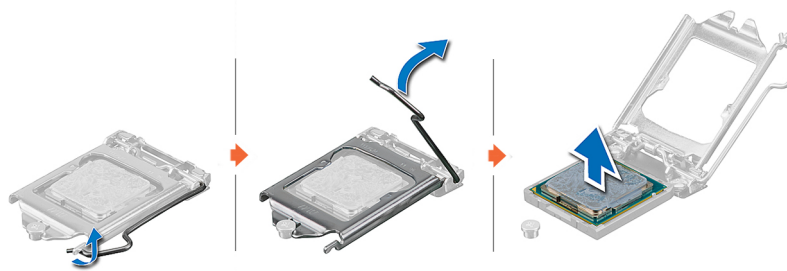

Figure 39. Removing the processor

Next steps

1. [Replace the processor.](#)

Installing the processor

Prerequisites

CAUTION: Never remove the heat sink from a processor unless you intend to replace the processor. The heat sink is necessary to maintain proper thermal conditions.

1. Ensure that you follow the [Safety instructions](#).
2. Follow the procedure that is listed in [Before working inside your system](#).
3. [Remove the processor.](#)

Steps

1. Align the pin 1 indicator of the processor with the triangle on the socket and place the processor on the socket.

CAUTION: Positioning the processor incorrectly can permanently damage the system board or the processor. Be careful not to bend the pins in the socket.

2. Lower the socket lever and push it under the tab to lock it.
3. If the processor has previously been used in a system, remove any remaining thermal grease from the processor by using a lint-free cloth.
4. Use the thermal grease syringe included with your processor kit to apply the grease in a quadrilateral design on the top of the processor.

CAUTION: Applying too much thermal grease can result in excess grease coming in contact with and contaminating the processor socket.

NOTE: The thermal grease syringe is intended for single use only. Dispose the syringe after you use it.

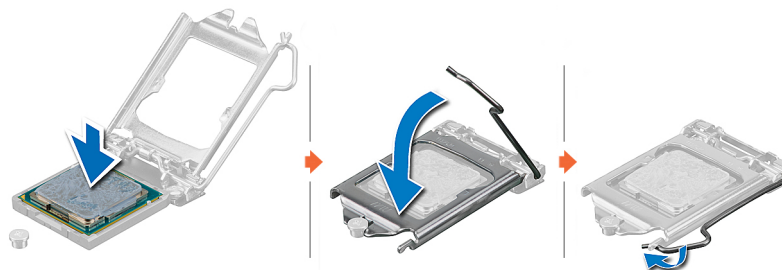

Figure 40. Installing the processor

Next steps

NOTE: Ensure that you install the heat sink after you install the processor. The heat sink is necessary to maintain proper thermal conditions.

1. Install the heat sink module.
2. Follow the procedure that is listed in [After working inside your system](#).

Installing the heat sink module

Prerequisites

CAUTION: Never remove the heat sink from a processor unless you intend to replace the processor. The heat sink is necessary to maintain proper thermal conditions.

1. Follow the safety guidelines listed in the [Safety instructions](#).
2. Follow the procedure that is listed in [Before working inside your system](#).
3. If removed, [install the processor](#).

Steps

1. If you are using an existing heat sink, remove the thermal grease from the heat sink by using a clean lint-free cloth.
2. Use the thermal grease syringe included with your processor kit to apply the grease in a quadrilateral design on the top of the processor.

CAUTION: Applying too much thermal grease can result in excess grease coming in contact with and contaminating the processor socket.

NOTE: The thermal grease syringe is intended for single use only. Dispose the syringe after you use it.

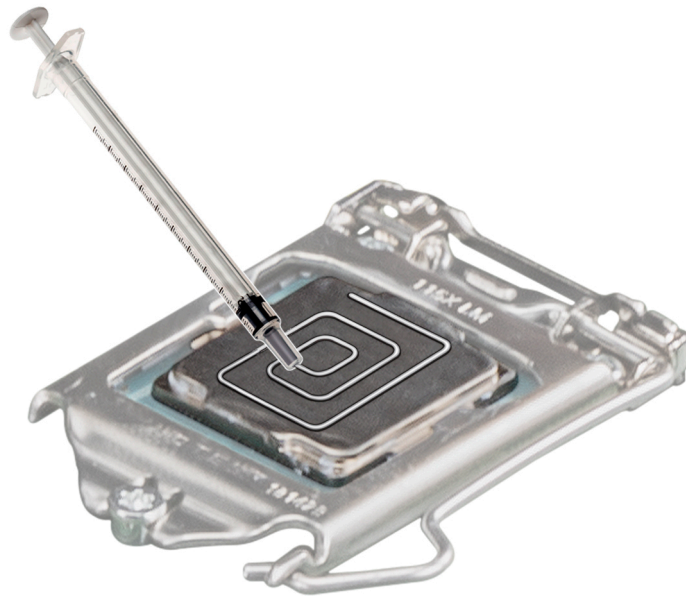

Figure 41. Applying thermal grease on top of the processor

3. Place the heat sink onto the processor with the cable end facing the drive carrier.
4. Using the Phillips #2 screwdriver, tighten the screws on the heat sink in the order following:
 - a) Partially tighten the first screw (approximately 3 turns).
 - b) Tighten the diagonally opposite screw completely.
 - c) Return to the first screw and tighten it completely.
 - d) Repeat the procedure for the remaining two screws.

NOTE: The processor and heat sink module retention screws should not be tightened to more than 0.13 kgf-m (1.35 N.m or 12 in-lbf).

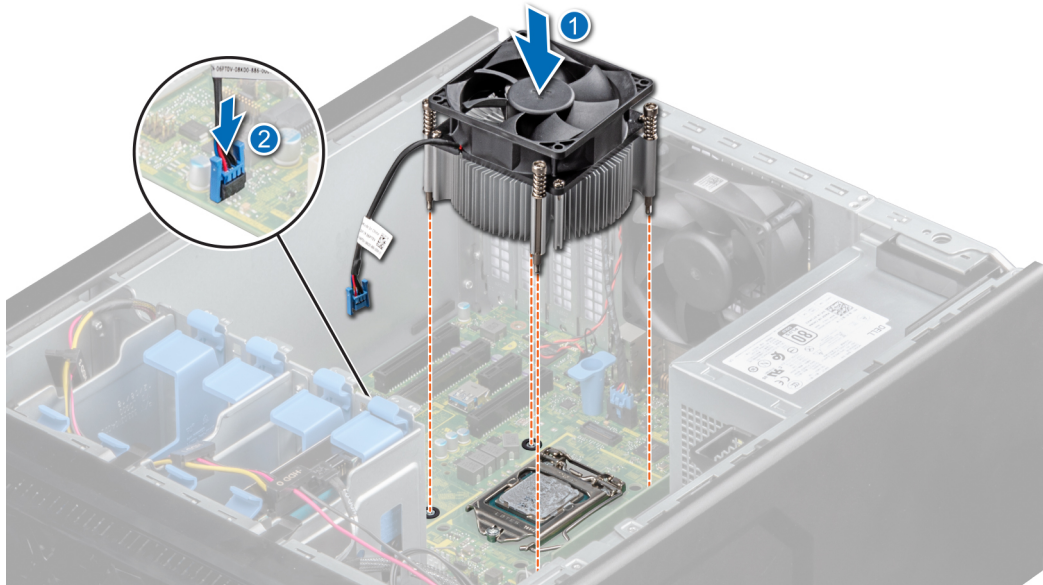

Figure 42. Installing the heat sink

Next steps

1. Follow the procedure listed in [After working inside your system](#).
2. While booting, press F2 to enter System Setup and check that the processor information matches the new system configuration.
3. Run the system diagnostics to verify that the new processor operates correctly.

Power supply unit

i **NOTE:** For more information, see the [Technical specifications](#) section.

Removing the power supply unit

Prerequisites

1. Follow the safety guidelines listed in [Safety instructions](#).
2. Follow the procedure that is listed in [Before working with system](#).
3. Disconnect the power cable from the power supply unit (PSU).
4. Disconnect all the power cables from the PSU to the system board.

Steps

1. Remove the screws securing the PSU to the system.
2. Press the release tab beside the PSU, and slide the PSU toward the front of the system.
3. Lift the PSU out of the system.

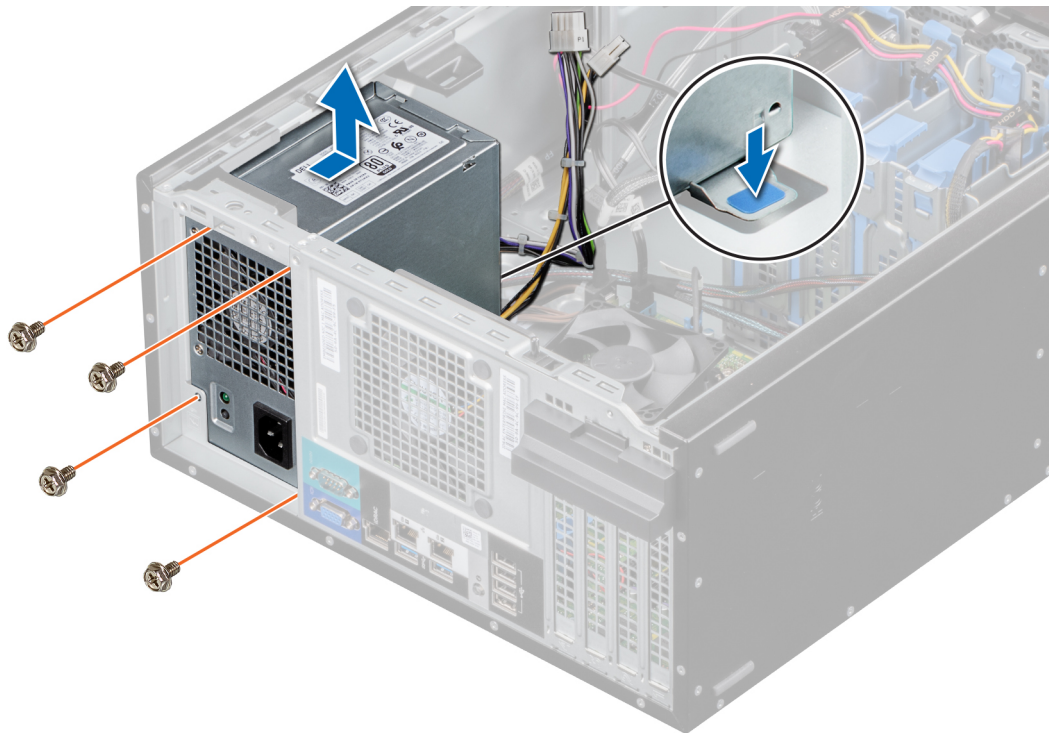

Figure 43. Removing the PSU

Next steps

1. [Replace the PSU.](#)

Installing the power supply unit

Prerequisites

1. Follow the safety guidelines listed in [Safety instructions](#) .
2. Follow the procedure listed in [Before working inside your system.](#)

Steps

1. While replacing a faulty PSU, you may require to bundle the P3 cable. The P3 cable in the PSU connects to the GPU. The PowerEdge T140 system does not support GPU and hence the P3 cable is required to be bundled to avoid system board damage. Follow the below steps to bundle the P3 cable:

CAUTION: Connecting the PSU P3 cable to any of the connectors on the system board may result in system board damage.

- a) Bundle the P3 cable providing equal interval spaces between the smaller cable ties.

NOTE: Ensure to align the connector head closer to the middle.

- b) Secure the P3 cable using the larger cable tie.
- c) Leaving 10 mm of the larger cable tie, snip the excess cable tie.

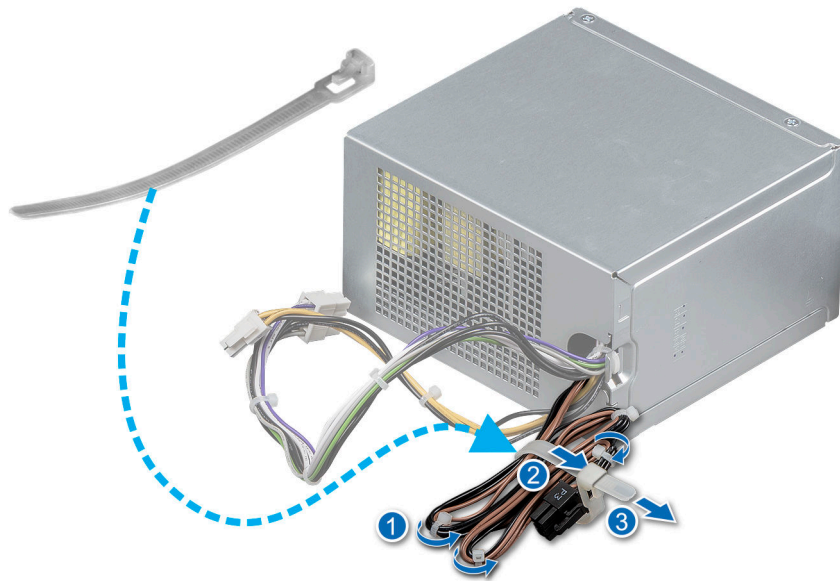

Figure 44. PSU P3 cable bundling

2. Place the PSU in the system and slide it toward the back of the system until it is fully seated.
3. Tighten the screws to secure the PSU to the system.



Figure 45. Installing the PSU

Next steps

1. Connect all the power cables from the PSU to the system board connectors.
2. Follow the procedure listed in [After working inside your system](#).

System battery

Replacing the system battery

Prerequisites

NOTE: There is a danger of a new battery exploding if it is incorrectly installed. Replace the battery only with the same or equivalent type recommended by the manufacturer. Discard used batteries according to the manufacturer's instructions. See the safety instructions that came with your system for more information.

1. Follow the safety guidelines listed in the [Safety instructions](#).
2. Follow the procedure listed in the [Before working inside your system](#).
3. Locate the battery socket. For more information, see the [System board jumpers and connectors](#) section.

Steps

1. To remove the battery:
 - a) Push the battery holder clip.

NOTE: Ensure that you do not push the battery holder clip more than 3.2 millimeters, It may damage the battery holder.
 - b) Lift the battery away from the system.

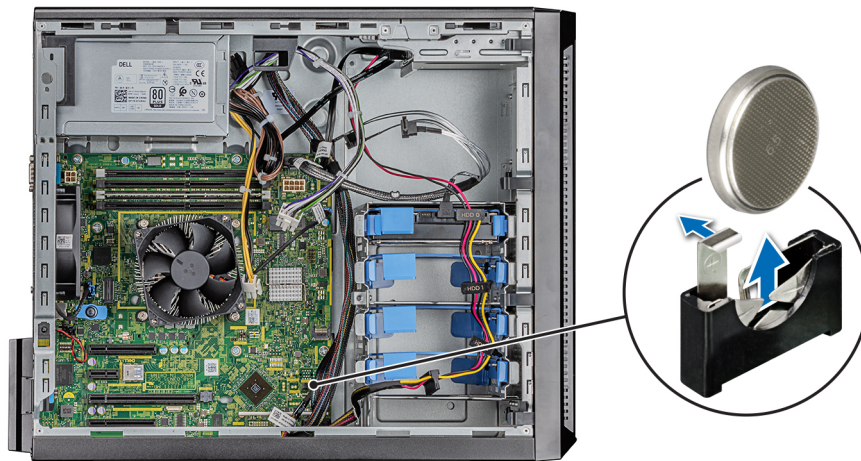

Figure 46. Removing system battery

2. To install a new system battery:
 - a) Push the battery lock slightly away.

NOTE: Ensure that you do not push the battery holder more that 3.2 millimeters or you might risk damaging the part.
 - b) Hold the battery with the + sign facing the positive side of the battery connector on the system board.
 - c) Insert the battery into the battery socket.

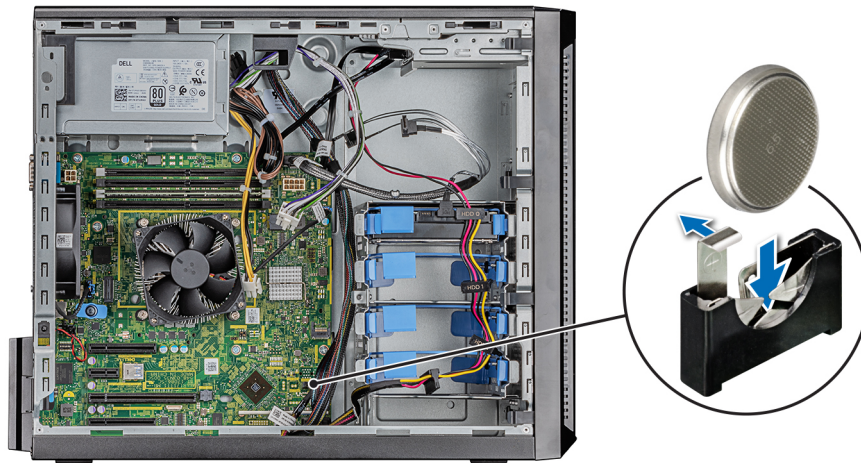

Figure 47. Installing system battery

Next steps

1. Follow the procedure listed in the [After working inside your system](#).
2. Confirm that the battery is operating properly, by performing the following steps:
 - a. Enter the System Setup, while booting, by pressing **F2**.
 - b. Enter the correct time and date in the System Setup **Time** and **Date** fields.
 - c. **Exit** the System Setup.
 - d. To test the newly installed battery, remove the system from the enclosure for at least an hour.
 - e. Reinstall the system into the enclosure after an hour.
 - f. Enter the System Setup and if the time and date are still incorrect, see [Getting help](#) section.

Intrusion switch

Removing the intrusion switch

Prerequisites

1. Follow the safety guidelines listed in [Safety instructions](#).
2. Follow the procedure that is listed in [Before working inside your system](#).

Steps

1. Disconnect the intrusion switch cable from the connector on the system board.
2. Slide and push the intrusion switch out of the intrusion switch slot on the system.

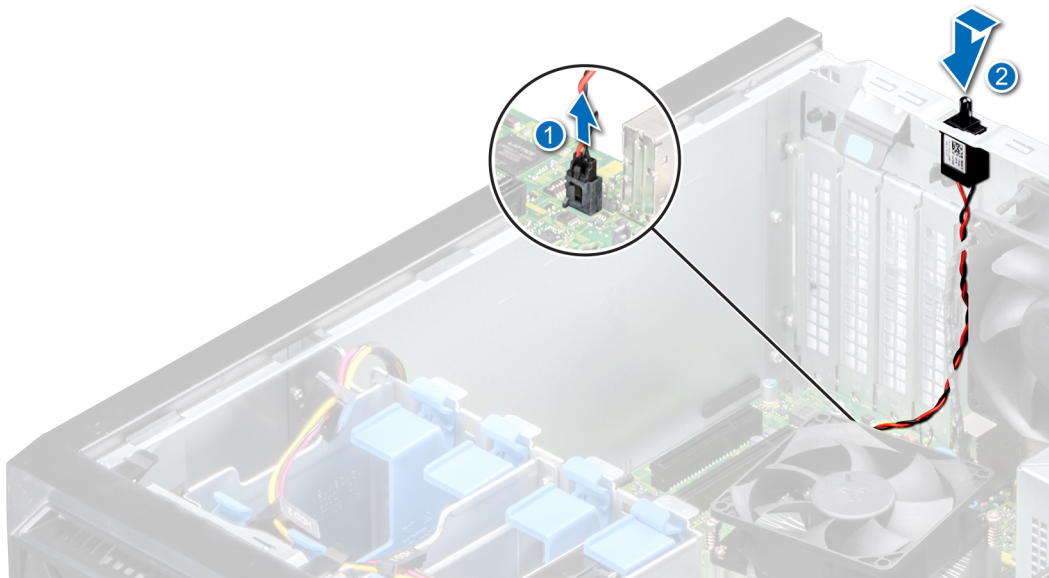

Figure 48. Removing the intrusion switch

Next steps

1. [Replace the intrusion switch.](#)

Installing the intrusion switch

Prerequisites

1. Follow the safety guidelines listed in [Safety instructions](#).
2. Follow the procedure that is listed in [Before working inside your system](#).

Steps

1. Place the intrusion switch into the intrusion switch slot and slide the intrusion switch to lock in place.

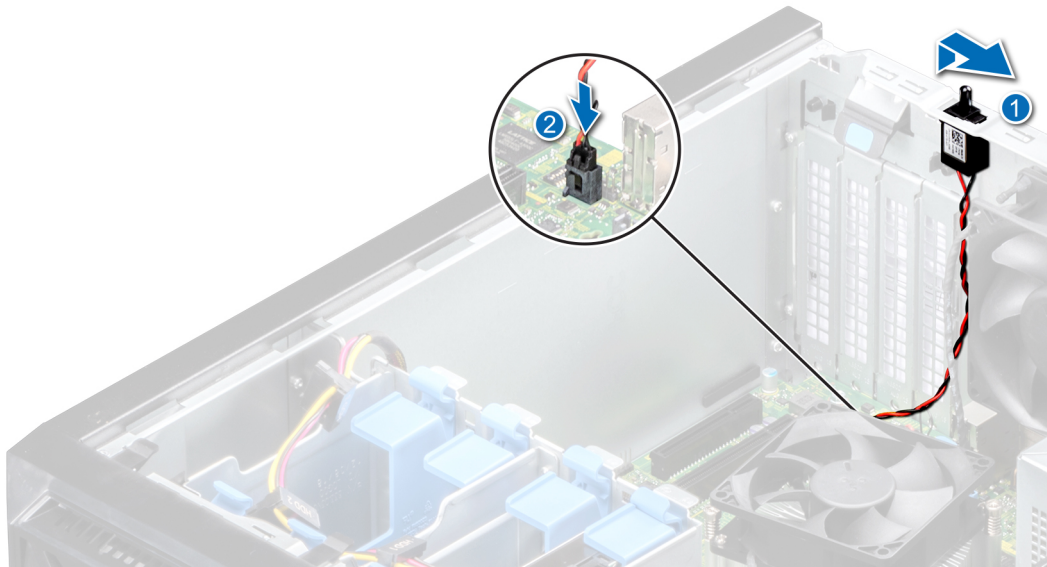

Figure 49. Installing the intrusion switch

2. Connect the intrusion switch cable to the connector on the system board.

Next steps

1. Follow the procedure that is listed in [After working inside your system](#).

System board

Removing the system board

Prerequisites

CAUTION: If you are using the Trusted Program Module (TPM) with an encryption key, you may be prompted to create a recovery key during program or System Setup. Be sure to create and safely store this recovery key. If you replace this system board, you must supply the recovery key when you restart your system or program before you can access the encrypted data on your hard drives.

CAUTION: Do not attempt to remove the TPM plug-in module from the system board. After the TPM plug-in module is installed, it is cryptographically bound to that specific system board. Any attempt to remove an installed TPM plug-in module breaks the cryptographic binding, and it cannot be reinstalled or installed on another system board.

1. Follow the safety guidelines listed in [Safety instructions](#).
2. Follow the procedure that is listed in [Before working inside your system](#).
3. Remove the following components:
 - a. [Expansion card](#), if installed
 - b. [Integrated storage controller card](#), if installed
 - c. [Internal USB key](#), if installed
 - d. [Heat sink module](#)
 - e. [Processor](#)
 - f. [Memory module](#)

Steps

1. Disconnect all cables from the system board.

CAUTION: Take care not to damage the system identification button while removing the system board from the chassis.

CAUTION: Do not lift the system board by holding a memory module, processor, or other components.

- Using the Phillips #2 screwdriver remove the screws that secure the system board to the chassis.

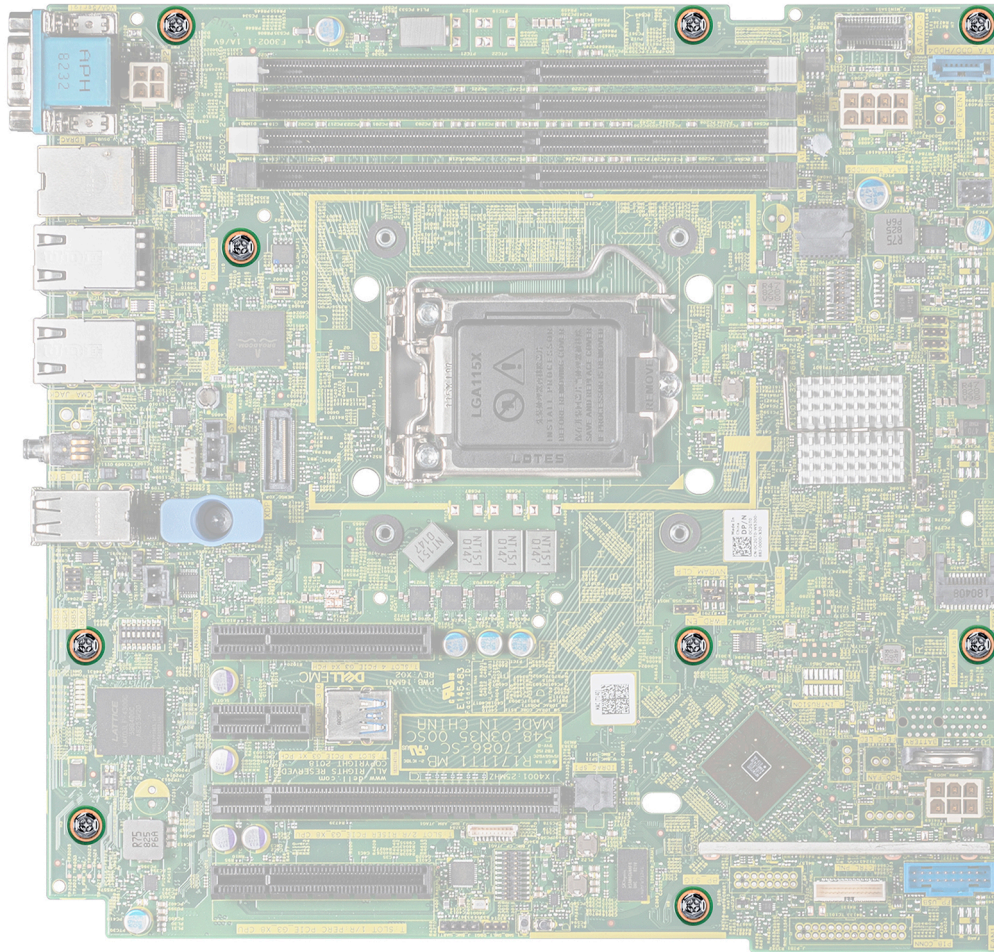

Figure 50. System board screw location

- Holding the blue holder, incline the system board at an angle, and lift the system board out of the chassis.

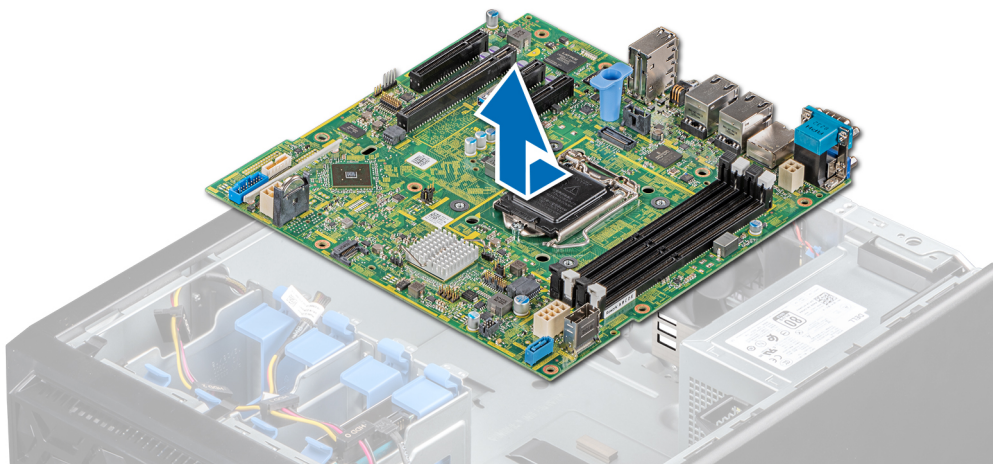

Figure 51. Removing the system board

Next steps

1. [Replace or install the system board.](#)

Installing the system board

Prerequisites

1. Follow the safety guidelines listed in [Safety instructions](#).
2. Follow the procedure that is listed in [Before working inside your system](#).

Steps

1. Unpack the new system board assembly.

i **NOTE:** Do not lift the system board by holding a memory module, processor, or other components.

⚠ **CAUTION:** Take care not to damage the system identification button while placing the system board into the chassis.

2. Holding the blue holder, incline the system board at an angle and align the connectors on the system board with the slots on the system, and lower the system board into the system.
3. Using the Phillips #2 screwdriver secure the system board to the chassis with screws.

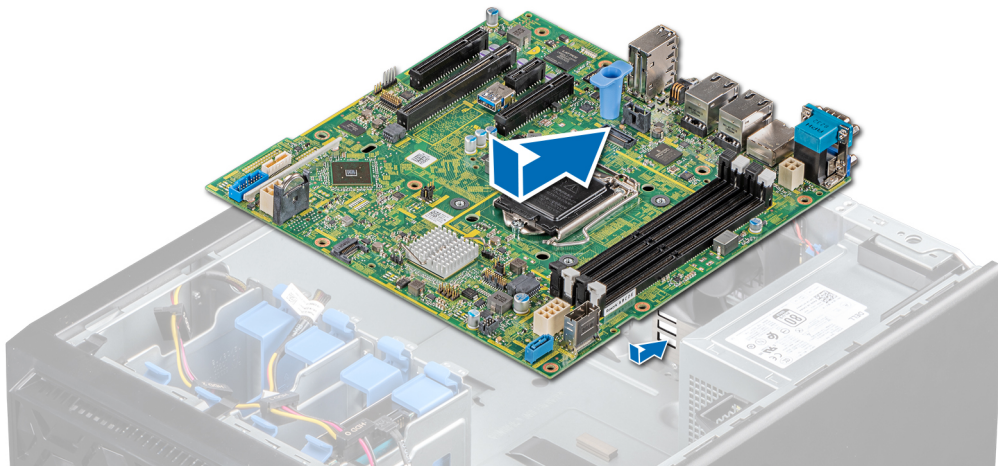

Figure 52. Installing the system board

Next steps

1. Replace the following:

- a. [Trusted Platform Module \(TPM\)](#)

i **NOTE:** The TPM must be replaced only while installing a new system board.

i **NOTE:** The TPM plug-in module is attached to the system board and cannot be removed. A replacement TPM plug-in module is provided for all system board replacements, where a TPM plug-in module was installed.

- b. [Memory modules](#)
- c. [Processors](#)
- d. [Heat sink modules](#)
- e. [Internal USB key, if installed](#)
- f. [Integrated storage controller card, if installed](#)
- g. [Expansion cards, if installed](#)

2. Replace the iDRAC MAC address label from the system with the new iDRAC MAC address label that came with the replacement system board.

3. Reconnect all cables to the system board.

i **NOTE:** Ensure that the cables inside the system are routed along the chassis wall and secured by using the cable securing bracket.



4. Boot the system.
5. Follow the procedure that is listed in the [After working inside your system section](#).
6. Ensure that you:
 - a. Use the Easy Restore feature to restore the Service Tag. For more information, see the [Restoring the system using Easy Restore](#).
 - b. If the Service Tag is not backed up in the backup flash device, enter the Service Tag manually. For more information, see [Manually update the Service Tag](#) section.
 - c. Update the BIOS and iDRAC versions.
 - d. Re-enable the Trusted Platform Module (TPM). For more information, see the [Upgrading the Trusted Platform Module \(TPM\)](#) section.
7. Import your new or existing iDRAC Enterprise license.
For more information, see iDRAC User's Guide, at www.dell.com/poweredge manuals.

Restoring the system using Easy Restore

The easy restore feature enables you to restore your service tag, license, UEFI configuration, and the system configuration data after replacing the system board. All data is backed up in a backup flash device automatically. If BIOS detects a new system board, and the service tag in the backup flash device, BIOS prompts the user to restore the backup information.

About this task

Below is a list of options available:

- Restore the service tag, license, and diagnostics information, press **Y**
- Navigate to the Lifecycle Controller based restore options, press **N**.
- Restore data from a previously created **Hardware Server Profile**, press **F10**
-  **NOTE: When the restore process is complete, BIOS prompts to restore the system configuration data.**
- To restore the system configuration data, press **Y**
- To use the default configuration settings, press **N**
-  **NOTE: After the restore process is complete, system reboots.**

Manually update the Service Tag

After replacing a system board, if Easy Restore fails, follow this process to manually enter the Service Tag, using **System Setup**.

About this task

If you know the system service tag, use the **System Setup** menu to enter the service tag.

Steps

1. Power on the system.
2. To enter the **System Setup**, press **F2**.
3. Click **Service Tag Settings**.
4. Enter the service tag.
 **NOTE: You can enter the service tag only when the Service Tag field is empty. Ensure that you enter the correct service tag. Once the service tag is entered, it cannot be updated or changed.**
5. Click **OK**.

Entering the system Service Tag by using System Setup

If Easy Restore fails to restore the Service Tag, use System Setup to enter the Service Tag.

Steps

1. Turn on the system.
2. Press F2 to enter System Setup.
3. Click **Service Tag Settings**.
4. Enter the Service Tag.

NOTE: You can enter the Service Tag only when the Service Tag field is empty. Ensure that you enter the correct Service Tag. After the Service Tag is entered, it cannot be updated or changed.

5. Click **OK**.
6. Import your new or existing iDRAC Enterprise license.

For more information, see the *Integrated Dell Remote Access Controller User's Guide* at www.dell.com/poweredgemanuals.

Trusted Platform Module

Upgrading the Trusted Platform Module

Prerequisites

NOTE:

- Ensure that your operating system supports the version of the TPM module being installed.
- Ensure that you download and install the latest BIOS firmware on your system.
- Ensure that the BIOS is configured to enable UEFI boot mode.

About this task

CAUTION: Once the TPM plug-in module is installed, it is cryptographically bound to that specific system board. Any attempt to remove an installed TPM plug-in module breaks the cryptographic binding, the removed TPM cannot be reinstalled or installed on another system board.

Removing the TPM

Steps

1. Locate the TPM connector on the system board.
2. Press to hold the module down and remove the screw using the security Torx 8-bit shipped with the TPM module.
3. Slide the TPM module out from its connector.
4. Push the plastic rivet away from the TPM connector and rotate it 90° counterclockwise to release it from the system board.
5. Pull the plastic rivet out of its slot on the system board.

Installing the TPM

Steps

1. To install the TPM, align the edge connectors on the TPM with the slot on the TPM connector.
2. Insert the TPM into the TPM connector such that the plastic rivet aligns with the slot on the system board.
3. Press the plastic rivet until the rivet snaps into place.
4. Replace the screw that secures the TPM to the system board.

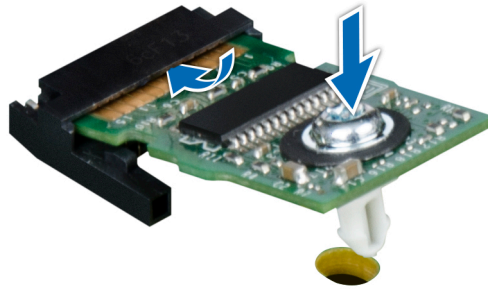

Figure 53. Installing the TPM

Next steps

1. [Replace the system board.](#)
2. Follow the procedure listed in [After working inside your system.](#)
3. To verify if the memory module has been installed properly, press F2 and navigate to **System Setup Main Menu > System BIOS > Memory Settings**. In the **Memory Settings** screen, the System Memory Size must reflect the updated capacity of the installed memory.
4. If the value is incorrect, one or more of the memory modules may not be installed properly. Ensure that the memory module is firmly seated in the memory module socket.
5. Run the system memory test in system diagnostics.

Initializing TPM for BitLocker users

Steps

1. Initialize the TPM.
For more information, see [initializing the TPM for Intel TXT users.](#)
2. The **TPM Status** changes to **Enabled, Activated**.

Initializing the TPM 1.2 for TXT users

Steps

1. While booting your system, press F2 to enter System Setup.
2. On the **System Setup Main Menu** screen, click **System BIOS > System Security Settings**.
3. From the **TPM Security** option, select **On with Preboot Measurements**.
4. From the **TPM Command** option, select **Activate**.
5. Save the settings.
6. Restart your system.
7. Enter **System Setup** again.
8. On the **System Setup Main Menu** screen, click **System BIOS > System Security Settings**.
9. From the **Intel TXT** option, select **On**.

Initializing the TPM 2.0 for TXT users

Steps

1. While booting your system, press F2 to enter System Setup.
2. On the **System Setup Main Menu** screen, click **System BIOS > System Security Settings**.
3. From the **TPM Security** option, select **On**.

4. Save the settings.
5. Restart your system.
6. Enter **System Setup** again.
7. On the **System Setup Main Menu** screen, click **System BIOS > System Security Settings**.
8. Select the **TPM Advanced Settings** option.
9. From the **TPM2 Algorithm Selection** option, select **SHA256**, then go back to **System Security Settings** screen.
10. On the **System Security Settings** screen, from the **Intel TXT** option, select **On**.
11. Save the settings.
12. Restart your system.

Control panel

Removing the control panel cage

Prerequisites

1. Follow the safety guidelines listed in [Safety instructions](#)
2. Follow the procedure that is listed in [Before working inside your system](#).
3. Disconnect all peripherals that are connected to the control panel.
4. Disconnect the control panel cable and control panel USB cable from the system board.

 **CAUTION: Do not use excessive force when removing the control panel cables as it can damage the connectors.**

5. [Remove the front bezel](#).

Steps

1. Using the Phillips #1 screwdriver, remove the screws that secure the control panel cage to the system.
2. Slide the control panel cage out of the system along with the cables.



Figure 54. Removing the control panel cage

Next steps

1. [Remove the control panel](#).

Removing the control panel

Prerequisites

1. Follow the safety guidelines listed in [Safety instructions](#)
2. Follow the procedure that is listed in [Before working inside your system](#).

Steps

1. Disconnect the control panel cable from the control panel.

CAUTION: Do not use excessive force when removing the control panel cables as it can damage the connectors.

2. Using the Phillips #2 screwdriver, remove the screws that secure the control panel to the control panel cage.
3. Slide the control panel out of the control panel cage.

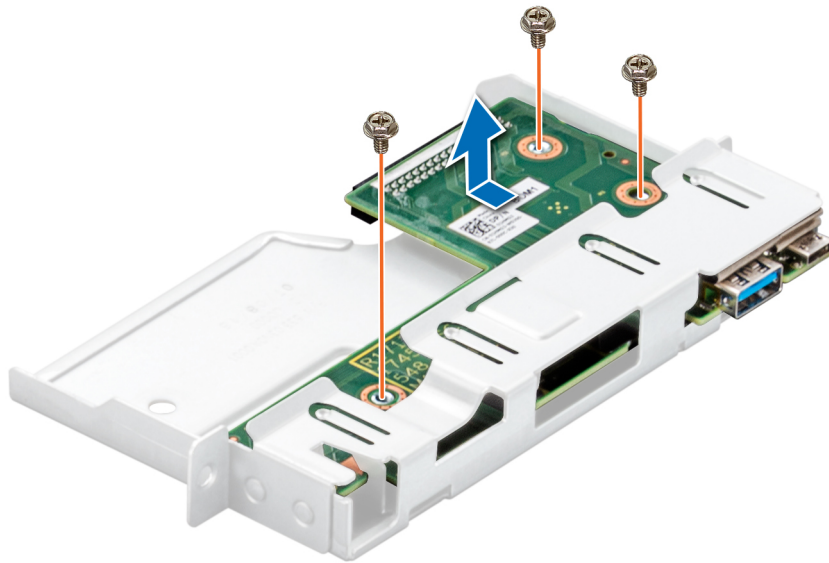

Figure 55. Removing the control panel

Next steps

1. [Replace the control panel](#).

Installing the control panel

Prerequisites

1. Follow the safety guidelines listed in [Safety instructions](#)
2. Follow the procedure that is listed in [Before working inside your system](#).

Steps

1. Align and insert the control panel into the control panel cage.
2. Using the Phillips #2 screwdriver, secure the control panel to the cage with screws.

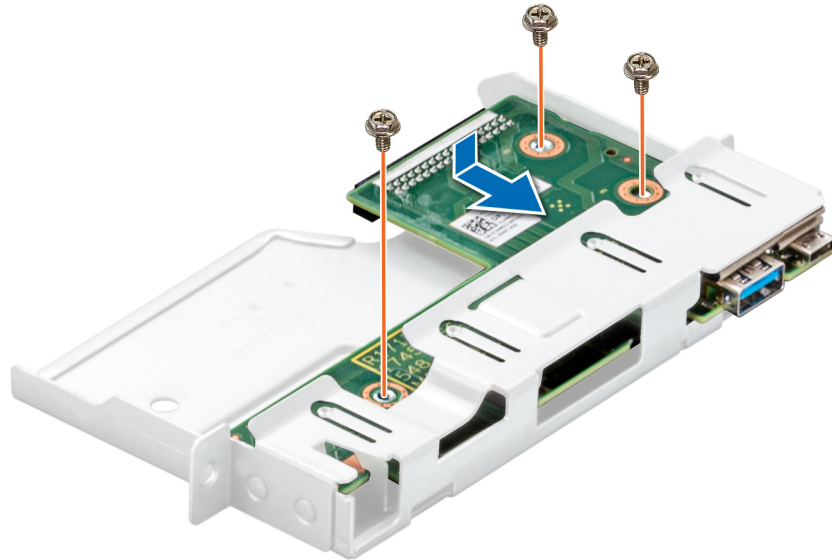

Figure 56. Installing the control panel

Next steps

1. Connect the control panel cable to the control panel.
2. [Install the control panel cage.](#)
3. Follow the procedure that is listed in [After working inside your system.](#)

Installing the control panel cage

Prerequisites

1. Follow the safety guidelines listed in [Safety instructions.](#)
2. Follow the procedure that is listed in [Before working inside your system.](#)

Steps

1. Align and insert the control panel cage into the control panel cage slot in the system.
2. Secure the control panel cage to the system with screws.
3. Route the control panel cable and control panel USB cable through the system clip.
4. Connect the control panel cable and control panel USB cable to the system board.

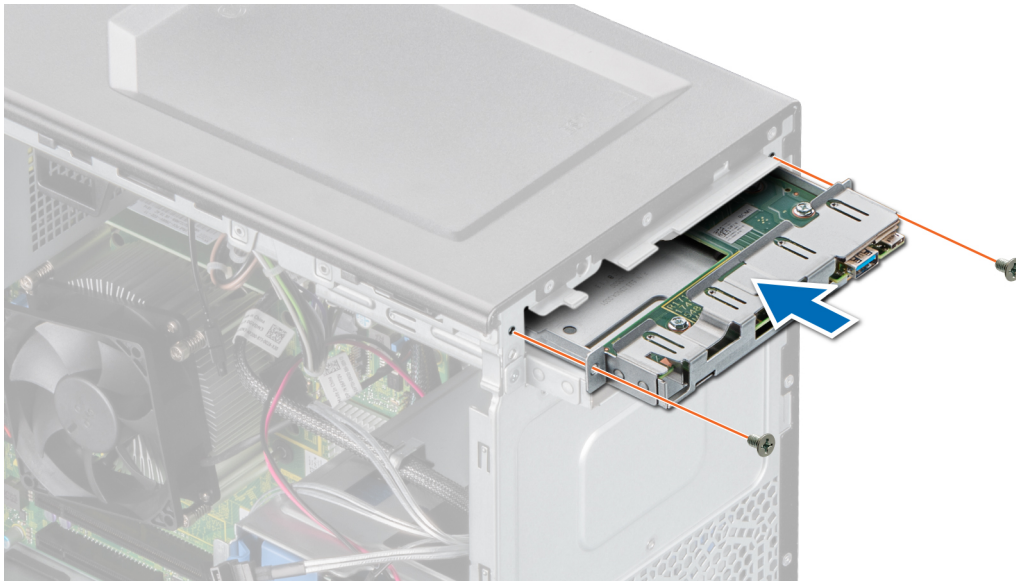

Figure 57. Installing the control panel cage

Next steps

1. [Install the front bezel.](#)
2. Reconnect the disconnected peripherals from the control panel assembly.
3. Follow the procedure that is listed in [After working inside your system.](#)

Jumpers and connectors

This topic provides specific information about the jumpers. It also provides some basic information about jumpers and switches and describes the connectors on the board in the system. Jumpers on the system board help to disable the system and setup passwords. You must know the connectors on the system board to install components and cables correctly.

Topics:

- System board jumpers and connectors
- System board jumper settings
- Disabling forgotten password

System board jumpers and connectors

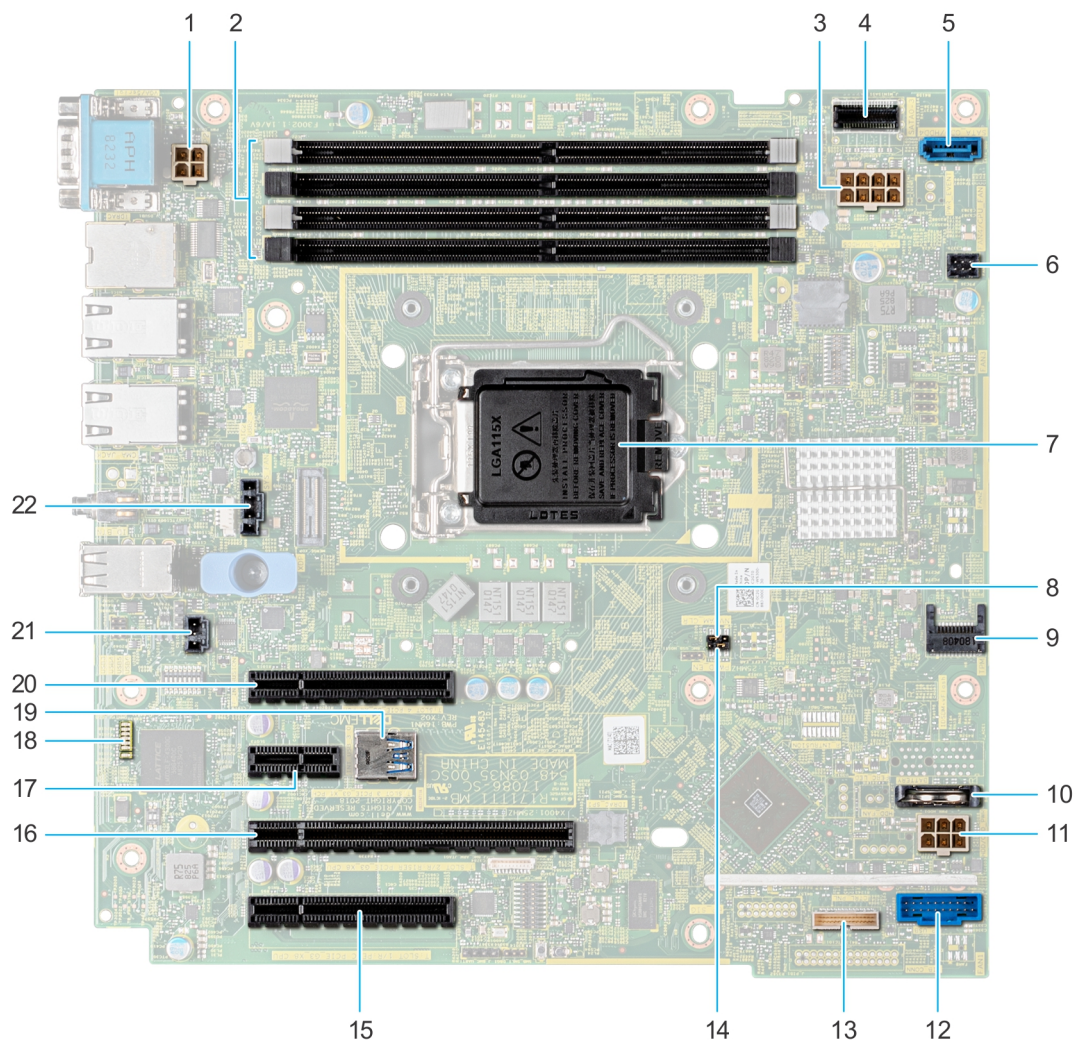

Figure 58. System board jumpers and connectors

Table 10. System board jumpers and connectors

Item	Connector	Description
1	PWR_CPU 1	CPU power connector P2
2	A3, A1, A4, A2	Memory module sockets
3	PWR_SYSTEM 1	System power connector P1
4	SATA 0-3	Mini SAS connector
5	SATA_ODD/HDD 4	Optical disk drive connector
6	FAN 4/ CPU_FAN	CPU fan connector
7	CPU	Processor socket
8	NVRAM_CLR	NVRAM password jumper
9	TPM	Trusted platform module connector
10	BATTERY	CMOS Battery connector
11	HDD/ODD_POWER	Hard drive power connector
12	FP_USB	Front panel USB connector
13	CTRL_PNL	Control panel
14	PWRD_EN	Reset BIOS password jumper
15	Slot 1: PCIE_G3_X8 CPU	PCIe card connector 1
16	Slot 2: PCIE_G3_X8 CPU	PCIe card connector 2
17	Slot 3: PCIE_G3_X1 PCH	PCIe card connector 3
18	LEDs	System board diagnostic LED indicators
19	INT_USB_3.0	Internal USB connector
20	Slot 4: PCIE_G3_X4 PCH	PCIe card connector 4
21	T_INTRUSION	Intrusion connector
22	SYSTEM FAN	System cooling fan connector

System board jumper settings

For information on resetting the password jumper to disable a password, see the [Disabling a forgotten password](#) section.

Disabling forgotten password

The software security features of the system include a system password and a setup password. The password jumper enables or disables password features and clears any password(s) currently in use.

Prerequisites

CAUTION: Many repairs may only be done by a certified service technician. You should only perform troubleshooting and simple repairs as authorized in your product documentation, or as directed by the online or telephone service and support team. Damage due to servicing that is not authorized by Dell is not covered by your warranty. Read and follow the safety instructions that are shipped with your product.

Steps

1. Power off the system, including any attached peripherals, and disconnect the system from the electrical outlet.
2. Remove the system cover.
3. Move the jumper on the system board jumper from pins 2 and 4 to pins 4 and 6.

4. Install the system cover.

The existing passwords are not disabled (erased) until the system boots with the jumper on pins 4 and 6. However, before you assign a new system and/or setup password, you must move the jumper back to pins 2 and 4.

 NOTE: If you assign a new system and/or setup password with the jumper on pins 4 and 6, the system disables the new password(s) the next time it boots.

5. Reconnect the system to its electrical outlet and power on the system, including any attached peripherals.
6. Power off the system, including any attached peripherals, and disconnect the system from the electrical outlet.
7. Remove the system cover.
8. Move the jumper on the system board jumper from pins 4 and 6 to pins 2 and 4.
9. Install the system cover.
10. Reconnect the system to its electrical outlet and power on the system, including any attached peripherals.
11. Assign a new system and/or setup password.

Technical specifications

The technical and environmental specifications of your system are outlined in this section.

Topics:

- Chassis dimensions
- System weight
- Processor specifications
- Supported operating systems
- PSU specifications
- Cooling fan specifications
- System battery specifications
- Expansion card specifications
- Memory specifications
- Storage controller specifications
- Drive specifications
- Ports and connectors specifications
- Video specifications
- Environmental specifications

Chassis dimensions

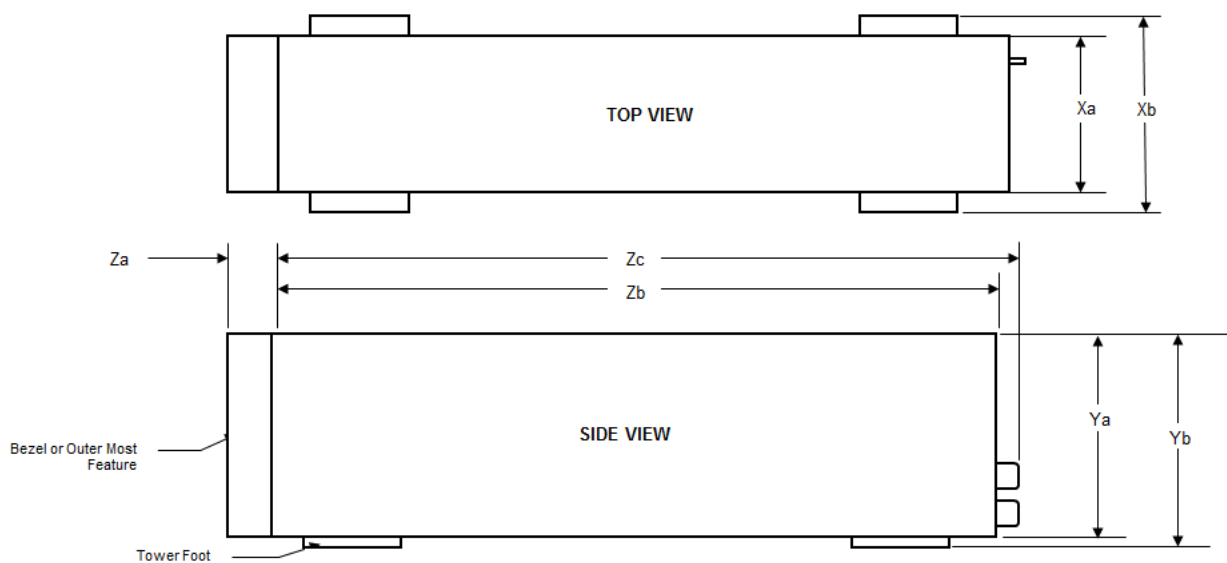

Figure 59. Chassis dimensions

Table 11. Dell EMC PowerEdge T140 system dimensions

Xa	Xb	Ya	Yb	Za	Zb	Zc
175 mm (6.89 inches)	NA	360 mm (14.17 inches)	362.9 mm (14.29 inches)	With bezel: 35.0 mm (1.38 inches) Without bezel: NA	400.0 mm (15.75 inches)	418.75 mm (16.49 inches)

System weight

Table 12. Dell EMC PowerEdge T140 system weight

System configuration	Maximum weight (with all drives)
4 x 3.5-inch drives	11.84 kg (26.10 lb)

Processor specifications

Table 13. Dell EMC PowerEdge T140 processor specifications

Supported processor	Number of processors supported
Intel Xeon processor E-2200 product family	One
Intel Core i3 9100 processor	
Intel Pentium G5420 processor	
Intel Celeron G4930 processor	
Intel Xeon processor E-2100 product family	
Intel Core i3 8100 processor	
Intel Pentium G5500 processor	
Intel Celeron G4900 processor	

Supported operating systems

The Dell EMC PowerEdge T140 supports the following operating systems:

- Canonical Ubuntu LTS
- Citrix XenServer
- Microsoft Windows Server
- Red Hat Enterprise Linux
- SUSE Linux Enterprise Server
- VMware ESXi

NOTE: For more information, go to www.dell.com/ossupport.

NOTE: For more information about the specific versions and additions, go to <https://www.dell.com/support/home/Drivers/SupportedOS/poweredge-t140>.

PSU specifications

The Dell EMC PowerEdge T140 system supports up to one AC cabled power supply unit (PSU).

Table 14. Dell EMC PowerEdge T140 PSU specifications

PSU	Class	Heat dissipation (maximum)	Frequency	Voltage	AC		DC	Current
					High line 100–240 V	Low line 100–140 V		
365 W AC	Gold	1908 BTU/hr	50/60 Hz	100–240 V AC, autoranging	365 W	N/A	N/A	5 A

NOTE: Heat dissipation is calculated using the PSU wattage rating.

NOTE: This system is also designed to connect to the IT power systems with a phase-to-phase voltage not exceeding 240 V.

Cooling fan specifications

The Dell EMC PowerEdge T140 system supports the following:

- One system cooling fan located at the back of the system.
- One processor cooling fan located on the heat sink.

NOTE: When selecting or upgrading the system configuration, to ensure optimum power utilization, verify the system power consumption with the Dell Energy Smart Solution Advisor available at Dell.com/ESSA.

System battery specifications

The Dell EMC PowerEdge T140 system supports CR 2032 3.0-V lithium coin cell system battery.

Expansion card specifications

The Dell EMC PowerEdge T140 system supports up to four PCI express (PCIe) Generation 3.

Table 15. Expansion card slots supported on the system board

PCIe slot	Processor Connection	PCIe slot height	PCIe slot length	Slot width
Slot 1 (Gen3)	Processor	Full Height	Half Length	x8 link in x8 slot
Slot 2 (Gen3)	Processor	Full Height	Half Length	x8 link in x16 slot
Slot 3 (Gen3)	Platform Controller Hub	Full Height	Half Length	x1
Slot 4 (Gen3)	Platform Controller Hub	Full Height	Half Length	x4 link in x8 slot

NOTE: The expansion cards are not hot swappable.

Memory specifications

The Dell EMC PowerEdge T140 system supports the following memory specifications for optimized operation:

Table 16. Memory specifications

DIMM type	DIMM rank	DIMM capacity	Minimum RAM	Maximum RAM
UDIMM	Single rank	8 GB	8 GB	32 GB
		16 GB	16 GB	64 GB
	Dual rank	8 GB	8 GB	32 GB
		16 GB	16 GB	64 GB

Storage controller specifications

The Dell EMC PowerEdge T140 system supports the following controller cards:

Table 17. Dell EMC PowerEdge T140 system controller cards

Internal controllers	External controllers
<ul style="list-style-type: none"> PERC H730P PERC H330 HBA330 	<ul style="list-style-type: none"> 12Gbps SAS Ext. HBA

Drive specifications

Drives

The Dell EMC PowerEdge T140 system supports:

- 4 x 3.5-inch SAS, SATA drives

NOTE: For a system with 4 TB (or more) drive capacity, PERC is required for thermal control.

Optical drives

The Dell EMC PowerEdge T140 system supports the following optical drives.

Table 18. Supported optical drive type

Supported drive type	Supported number of drives
Dedicated SATA DVD-ROM drive or DVD +/-RW drive	One

Ports and connectors specifications

USB ports specifications

Table 19. Dell EMC PowerEdge T140 system USB port specifications

Front panel	Back panel	Internal USB
<ul style="list-style-type: none"> One USB 3.0-compliant ports One micro USB 2.0-compliant port for iDRAC Direct <p>NOTE: The micro USB 2.0 compliant port can only be used as an iDRAC Direct or a management port.</p>	<ul style="list-style-type: none"> Two USB 3.0-compliant ports Four USB 2.0-compliant ports 	<ul style="list-style-type: none"> One internal USB 3.0-compliant port

NIC ports specifications

The Dell EMC PowerEdge T140 system supports up to two 10/100/1000 Mbps Network Interface Controller (NIC) ports that are located on the back panel.

Serial connector specifications

The Dell EMC PowerEdge T140 system supports one serial connector on the back panel, which is a 9-pin connector, Data Terminal Equipment (DTE), 16550-compliant.

VGA ports specification

The Dell EMC PowerEdge T140 system supports one 15-pin VGA port, on the back of the system.

NOTE: The front VGA port is available only with the rack configuration.

Video specifications

The Dell EMC PowerEdge T140 system supports Matrox G200eR2 graphics card with 16 MB capacity.

Table 20. Supported video resolution options

Resolution	Refresh rate	Color depth (bits)
640x480	60, 70	8, 16, 24
800x600	60, 75, 85	8, 16, 24
1024x768	60, 75, 85	8, 16, 24
1152x864	60, 75, 85	8, 16, 24
1280x1024	60, 75	8, 16, 24

Environmental specifications

NOTE: For additional information about environmental certifications, refer to the *Product Environmental Datasheet* located with the Manuals & Documents on www.dell.com/support/home.

Table 21. Temperature specifications

Temperature	Specifications
Storage	-40–65°C (-40–149°F)
Continuous operation (for altitude less than 950 m or 3117 ft)	10–35°C (50–95°F) with no direct sunlight on the equipment
Fresh air	For information about fresh air, see the Expanded operating temperature section.
Maximum temperature gradient (operating and storage)	20°C/h (68°F/h)

Table 22. Relative humidity specifications

Relative humidity	Specifications
Storage	5% to 95% RH with 33°C (91°F) maximum dew point. Atmosphere must be noncondensing at all times.
Operating	10% to 80% RH with 29°C (84.2°F) maximum dew point.

Table 23. Maximum vibration specifications

Maximum vibration	Specifications
Operating	0.26 G _{rms} at 5 Hz to 350 Hz (all operation orientations)
Storage	1.88 G _{rms} at 10 Hz to 500 Hz for 15 minutes (all six sides tested)

Table 24. Maximum shock pulse specifications

Maximum shock pulse	Specifications
Operating	Six consecutively executed shock pulses in the positive and negative x, y, and z axis of 6 G for up to 11 ms.
Storage	Six consecutively executed shock pulses in the positive and negative x, y, and z axis (one pulse on each side of the system) of 71 G for up to 2 ms.

Table 25. Maximum altitude specifications

Maximum altitude	Specifications
Operating	3048 m (10,000 ft)
Storage	12,000 m (39,370 ft)

Table 26. Operating temperature derating specifications

Operating temperature derating	Specifications
Up to 35°C (95°F)	Maximum temperature is reduced by 1°C/300 m (1°F/547 ft), above 950 m (3,117 ft).
35–40°C (95–104°F)	Maximum temperature is reduced by 1°C/175 m (1°F/319 ft), above 950 m (3,117 ft).
40–45°C (104–113°F)	Maximum temperature is reduced by 1°C/125 m (1°F/228 ft), above 950 m (3,117 ft).

Standard operating temperature

Table 27. Standard operating temperature specifications

Standard operating temperature	Specifications
Continuous operation (for altitude less than 950 m or 3117 ft)	10–35°C (50–95°F) with no direct sunlight on the equipment.

Expanded operating temperature

Table 28. Expanded operating temperature specifications

Expanded operating temperature	Specifications
Continuous operation	<p>5°C–40°C at 5% to 85% RH with 29°C dew point.</p> <p>i NOTE: Outside the standard operating temperature (10°C–35°C), the system can operate continuously in temperatures as low as 5°C and as high as 40°C.</p> <p>For temperatures 35°C– 40°C, derate maximum allowable temperature by 1°C per 175 m (1°F per 319 ft) above 950 m (3,117 ft).</p>
≤ 1% of annual operating hours	<p>-5°C–45°C at 5% to 90% RH with 29°C dew point.</p> <p>i NOTE: Outside the standard operating temperature (10°C–35°C), the system can operate down to -5°C or up to 45°C for a maximum of 1% of its annual operating hours.</p> <p>For temperatures 40°C– 45°C, derate maximum allowable temperature by 1°C per 125 m (1°F per 228 ft) above 950 m (3,117 ft).</p>

NOTE: When operating in the expanded temperature range, the performance of the system may be impacted.

NOTE: When operating in the expanded temperature range, ambient temperature warnings may be reported on the System Event Log.

Expanded operating temperature restrictions

- Do not perform a cold startup of the system below 5°C.
- The operating temperature specified is for a maximum altitude of 3048 m (10,000 ft).
- One non-redundant power supply unit is required.
- One system fan required.
- Non-Dell qualified peripheral cards and/or peripheral cards greater than 25 W are not supported.
- GPU is not supported.
- Tape backup unit is not supported.
- For a system with 4 TB (or more) drive capacity, PERC is required for thermal control.

Thermal restriction matrix

Table 29. Thermal restrictions matrix

Ambient	25°C	30°C	35°C
Processor	No restriction	No restriction	No restriction
DIMM	No restriction	No restriction	No restriction
Drive	No restriction	No restriction	No restriction
Card	No restriction	No restriction	No restriction

Particulate and gaseous contamination specifications

The following table defines the limitations that help avoid any damages to the IT equipment and/or, or both failure from particulate and gaseous contamination. If the levels of particulate or gaseous pollution exceed the specified limitations and results in equipment damage or failure, you must rectify the environmental conditions. Remediation of environmental conditions is the responsibility of the customer.

Table 30. Particulate contamination specifications

Particulate contamination	Specifications
Air filtration	<p>Data center air filtration as defined by ISO Class 8 per ISO 14644-1 with a 95% upper confidence limit.</p> <p>NOTE: This condition applies to data center environments only. Air filtration requirements do not apply to IT equipment designed to be used outside a data center, in environments such as an office or factory floor.</p> <p>NOTE: Air entering the data center must have MERV11 or MERV13 filtration.</p>
Conductive dust	<p>Air must be free of conductive dust, zinc whiskers, or other conductive particles.</p> <p>NOTE: This condition applies to data center and non-data center environments.</p>
Corrosive dust	<ul style="list-style-type: none"> • Air must be free of corrosive dust. • Residual dust present in the air must have a deliquescent point less than 60% relative humidity.

Particulate contamination	Specifications
	 NOTE: This condition applies to data center and non-data center environments.

Table 31. Gaseous contamination specifications

Gaseous contamination	Specifications
Copper Coupon Corrosion	<300 Å/month per Class G1 as defined by ANSI/ISA71.04-1985.
Silver Coupon Corrosion	<200 Å/month as defined by AHSRAE TC9.9.

 **NOTE:** Maximum corrosive contaminant levels measured at ≤50% relative humidity.

System diagnostics and indicator codes

The diagnostic indicators on the system front panel display system status during system startup.

Topics:

- [System health and system ID indicator codes](#)
- [NIC indicator codes](#)
- [Non-redundant cabled power supply unit indicator codes](#)
- [PowerEdge T140 system diagnostics](#)

System health and system ID indicator codes

The system health and system ID indicator is located on the front panel of your system.



Figure 60. System health and system ID indicator

Table 32. System health and system ID indicator codes

System health and system ID indicator code	Condition
Solid blue	Indicates that the system is turned on, system is healthy, and system ID mode is not active. Press the system health and system ID button to switch to system ID mode.
Blinking blue	Indicates that the system ID mode is active. Press the system health and system ID button to switch to system health mode.
Solid amber	Indicates that the system is in fail-safe mode. If the problem persists, see the Getting help section.
Blinking amber	Indicates that the system is experiencing a fault. Check the System Event Log for specific error messages. For information about the event and error messages generated by the system firmware and agents that monitor system components, see the Error Code Lookup page at qrl.dell.com

NIC indicator codes

Each NIC on the back of the system has indicators that provide information about the activity and link status. The activity LED indicator indicates if data is flowing through the NIC, and the link LED indicator indicates the speed of the connected network.

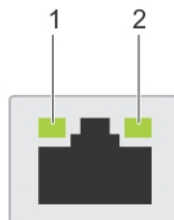

Figure 61. NIC indicator codes

1. Link LED indicator
2. Activity LED indicator

Table 33. NIC indicator codes

Status	Condition
Link and activity indicators are off.	The NIC is not connected to the network.
Link indicator is green, and activity indicator is blinking green.	The NIC is connected to a valid network at its maximum port speed, and data is being sent or received.
Link indicator is amber, and activity indicator is blinking green.	The NIC is connected to a valid network at less than its maximum port speed, and data is being sent or received.
Link indicator is green, and activity indicator is off.	The NIC is connected to a valid network at its maximum port speed, and data is not being sent or received.
Link indicator is amber, and activity indicator is off.	The NIC is connected to a valid network at less than its maximum port speed, and data is not being sent or received.
Link indicator is blinking green, and activity is off.	NIC identify is enabled through the NIC configuration utility.

Non-redundant cabled power supply unit indicator codes

Press the self-diagnostic button to perform a quick health check on the non-redundant cabled power supply unit (PSU) of the system.

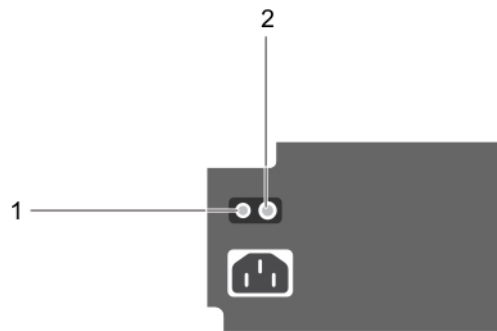

Figure 62. Non-redundant cabled AC PSU status indicator and self-diagnostic button

1. Self-diagnostic button
2. AC PSU status indicator

Table 34. Non-redundant AC PSU status indicator

Power Indicator Pattern	Condition
Not lit	Power is not connected or PSU is faulty.
Green	A valid power source is connected to the PSU and the PSU is operational.

PowerEdge T140 system diagnostics

If you experience a problem with your system, run the system diagnostics before contacting Dell for technical assistance. The purpose of running system diagnostics is to test your system hardware without using additional equipment or risking data loss. If you are unable to fix the problem yourself, service and support personnel can use the diagnostics results to help you solve the problem.

Dell Embedded System Diagnostics

NOTE: The Dell Embedded System Diagnostics is also known as Enhanced Pre-boot System Assessment (ePSA) diagnostics.

The Embedded System Diagnostics provides a set of options for particular device groups or devices allowing you to:

- Run tests automatically or in an interactive mode
- Repeat tests
- Display or save test results
- Run thorough tests to introduce additional test options to provide extra information about the failed device(s)
- View status messages that inform you if tests are completed successfully
- View error messages that inform you of problems encountered during testing

Running the Embedded System Diagnostics from Boot Manager

Run the Embedded System Diagnostics (ePSA) if your system does not boot.

Steps

1. When the system is booting, press F11.
2. Use the up arrow and down arrow keys to select **System Utilities > Launch Diagnostics**.
3. Alternatively, when the system is booting, press F10, select **Hardware Diagnostics > Run Hardware Diagnostics**.
The **ePSA Pre-boot System Assessment** window is displayed, listing all devices detected in the system. The diagnostics starts executing the tests on all the detected devices.

Results

Running the Embedded System Diagnostics from the Dell Lifecycle Controller

Steps

1. As the system boots, press F10.
2. Select **Hardware Diagnostics → Run Hardware Diagnostics**.
The **ePSA Pre-boot System Assessment** window is displayed, listing all devices detected in the system. The diagnostics starts executing the tests on all the detected devices.

System diagnostic controls

Menu	Description
Configuration	Displays the configuration and status information of all detected devices.
Results	Displays the results of all tests that are run.
System health	Provides the current overview of the system performance.
Event log	Displays a time-stamped log of the results of all tests run on the system. This is displayed if at least one event description is recorded.

Getting help

Topics:

- [Recycling or End-of-Life service information](#)
- [Contacting Dell](#)
- [Accessing system information by using QRL](#)
- [Receiving automated support with SupportAssist](#)

Recycling or End-of-Life service information

Take back and recycling services are offered for this product in certain countries. If you want to dispose of system components, visit www.dell.com/recyclingworldwide and select the relevant country.

Contacting Dell

Dell provides several online and telephone based support and service options. If you do not have an active internet connection, you can find contact information about your purchase invoice, packing slip, bill, or Dell product catalog. Availability varies by country and product, and some services may not be available in your area. To contact Dell for sales, technical assistance, or customer service issues:

Steps

1. Go to www.dell.com/support/home
2. Select your country from the drop-down menu on the lower right corner of the page.
3. For customized support:
 - a) Enter your system Service Tag in the **Enter your Service Tag** field.
 - b) Click **Submit**.
The support page that lists the various support categories is displayed.
4. For general support:
 - a) Select your product category.
 - b) Select your product segment.
 - c) Select your product.
The support page that lists the various support categories is displayed.
5. For contact details of Dell Global Technical Support:
 - a) Click [Global Technical Support](#)
 - b) The **Contact Technical Support** page is displayed with details to call, chat, or e-mail the Dell Global Technical Support team.

Accessing system information by using QRL

You can use the Quick Resource Locator (QRL) located on the information tag in the front of the T140, to access the information about the Dell EMC PowerEdge T140.

Prerequisites

Ensure that your smartphone or tablet has the QR code scanner installed.

The QRL includes the following information about your system:

- How-to videos
- Reference materials, including the Installation and Service Manual, and mechanical overview
- Your system service tag to quickly access your specific hardware configuration and warranty information
- A direct link to Dell to contact technical assistance and sales teams

Steps

1. Go to www.dell.com/qrl and navigate to your specific product or
2. Use your smartphone or tablet to scan the model-specific Quick Resource (QR) code on your system or in the Quick Resource Locator section.

Quick Resource Locator for Dell EMC PowerEdge T140 system



Figure 63. Quick Resource Locator for Dell EMC PowerEdge T140 system

Receiving automated support with SupportAssist

Dell EMC SupportAssist is an optional Dell EMC Services offering that automates technical support for your Dell EMC server, storage, and networking devices. By installing and setting up a SupportAssist application in your IT environment, you can receive the following benefits:

- **Automated issue detection** — SupportAssist monitors your Dell EMC devices and automatically detects hardware issues, both proactively and predictively.
- **Automated case creation** — When an issue is detected, SupportAssist automatically opens a support case with Dell EMC Technical Support.
- **Automated diagnostic collection** — SupportAssist automatically collects system state information from your devices and uploads it securely to Dell EMC. This information is used by Dell EMC Technical Support to troubleshoot the issue.
- **Proactive contact** — A Dell EMC Technical Support agent contacts you about the support case and helps you resolve the issue.

The available benefits vary depending on the Dell EMC Service entitlement purchased for your device. For more information about SupportAssist, go to www.dell.com/supportassist.

Documentation resources

This section provides information about the documentation resources for your system.

To view the document that is listed in the documentation resources table:

- From the Dell EMC support site:
 1. Click the documentation link that is provided in the Location column in the table.
 2. Click the required product or product version.
 3. On the Product Support page, click **Manuals & documents**.
- Using search engines:
 - Type the name and version of the document in the search box.

NOTE: To locate the product name and model, see the front of your system.

Table 35. Additional documentation resources for your system

Task	Document	Location
Setting up your system	For more information about installing and securing the system into a rack, see the Rail Installation Guide included with your rack solution. For information about setting up your system, see the <i>Getting Started Guide</i> document that is shipped with your system.	www.dell.com/poweredgemanuals
Configuring your system	For information about the iDRAC features, configuring and logging in to iDRAC, and managing your system remotely, see the Integrated Dell Remote Access Controller User's Guide. For information about understanding Remote Access Controller Admin (RACADM) subcommands and supported RACADM interfaces, see the RACADM CLI Guide for iDRAC. For information about Redfish and its protocol, supported schema, and Redfish Eventing are implemented in iDRAC, see the Redfish API Guide. For information about iDRAC property database group and object descriptions, see the Attribute Registry Guide.	www.dell.com/poweredgemanuals
	For information about earlier versions of the iDRAC documents, see the iDRAC documentation. To identify the version of iDRAC available on your system, on the iDRAC web interface, click ? > About .	www.dell.com/idracmanuals
	For information about installing the operating system, see the operating system documentation.	www.dell.com/operatingsystemmanuals
	For information about updating drivers and firmware, see the Methods to download firmware and drivers section in this document.	www.dell.com/support/drivers
Managing your system	For information about systems management software offered by Dell, see the Dell	www.dell.com/poweredgemanuals

Task	Document	Location
	OpenManage Systems Management Overview Guide.	
	For information about setting up, using, and troubleshooting OpenManage, see the Dell OpenManage Server Administrator User's Guide.	www.dell.com/openmanagemanuals > OpenManage Server Administrator
	For information about installing, using, and troubleshooting Dell OpenManage Essentials, see the Dell OpenManage Essentials User's Guide.	www.dell.com/openmanagemanuals > OpenManage Essentials
	For information about installing, using, and troubleshooting Dell OpenManage Enterprise, see the Dell OpenManage Enterprise User's Guide.	www.dell.com/openmanagemanuals > OpenManage Enterprise
	For information about installing and using Dell SupportAssist, see the Dell EMC SupportAssist Enterprise User's Guide.	www.dell.com/serviceabilitytools
	For information about partner programs enterprise systems management, see the OpenManage Connections Enterprise Systems Management documents.	www.dell.com/openmanagemanuals
Working with the Dell PowerEdge RAID controllers	For information about understanding the features of the Dell PowerEdge RAID controllers (PERC), Software RAID controllers, or BOSS card and deploying the cards, see the Storage controller documentation.	www.dell.com/storagecontrollermanuals
Understanding event and error messages	For information about the event and error messages that are generated by the system firmware and agents that monitor system components, see the Error Code Lookup.	www.dell.com/qrl
Troubleshooting your system	For information about identifying and troubleshooting the PowerEdge server issues, see the Server Troubleshooting Guide.	www.dell.com/poweredgemanuals