

XPS 13 7390

Service Manual

Notes, cautions, and warnings

 **NOTE:** A NOTE indicates important information that helps you make better use of your product.

 **CAUTION:** A CAUTION indicates either potential damage to hardware or loss of data and tells you how to avoid the problem.

 **WARNING:** A WARNING indicates a potential for property damage, personal injury, or death.

© 2018 - 2019 Dell Inc. or its subsidiaries. All rights reserved. Dell, EMC, and other trademarks are trademarks of Dell Inc. or its subsidiaries. Other trademarks may be trademarks of their respective owners.

Contents

1 Before working inside your computer	7
Before you begin	7
2 After working inside your computer	8
3 Safety instructions	9
Electrostatic discharge—ESD protection.....	9
ESD field service kit	10
Transporting sensitive components.....	11
4 Recommended tools	12
5 Screw list	13
6 Removing the base cover	15
Procedure.....	15
7 Replacing the base cover	17
Procedure.....	17
8 Removing the battery	19
Lithium-ion battery precautions.....	19
Prerequisites.....	19
Procedure.....	19
9 Replacing the battery	21
Lithium-ion battery precautions.....	21
Procedure.....	21
Post-requisites.....	22
10 Removing the solid-state drive	23
Prerequisites.....	23
Procedure to remove M.2 2280 solid-state drive.....	23
Procedure to remove M.2 2230 solid-state drive.....	24
11 Replacing the solid-state drive	25
Procedure to replace 2280 solid-state drive.....	25
Procedure to replace 2230 solid-state drive.....	25
Post-requisites.....	26
12 Removing the speakers	27
Prerequisites.....	27
Procedure.....	27

13 Replacing the speakers.....	28
Procedure.....	28
Post-requisites.....	28
14 Removing the coin-cell battery.....	29
Prerequisites.....	29
Procedure.....	29
15 Replacing the coin-cell battery.....	30
Procedure.....	30
Post-requisites.....	30
16 Removing the heat sink.....	31
Prerequisites.....	31
Procedure.....	31
17 Replacing the heat sink.....	32
Procedure.....	32
Post-requisites.....	32
18 Removing the heat-sink assembly.....	33
Prerequisites.....	33
Procedure.....	33
19 Replacing the heat-sink assembly.....	35
Procedure.....	35
Post-requisites.....	36
20 Removing the display assembly.....	37
Prerequisites.....	37
Procedure.....	37
21 Replacing the display assembly.....	39
Procedure.....	39
Post-requisites.....	40
22 Removing the headset port.....	41
Prerequisites.....	41
Procedure.....	41
23 Replacing the headset port.....	43
Procedure.....	43
Post-requisites.....	44
24 Removing the fans.....	45
Prerequisites.....	45
Procedure.....	45

25 Replacing the fans.....	47
Procedure.....	47
Post-requisites.....	48
26 Removing the system board.....	49
Prerequisites.....	49
Procedure.....	49
27 Replacing the system board.....	51
Procedure.....	51
Post-requisites.....	52
Entering the Service Tag in the BIOS setup program.....	52
28 Removing the power button with optional fingerprint reader.....	54
Prerequisites.....	54
Procedure.....	54
29 Replacing the power button with optional fingerprint reader.....	56
Procedure.....	56
Post-requisites.....	56
30 Removing the keyboard.....	58
Prerequisites.....	58
Procedure.....	58
31 Replacing the keyboard.....	59
Procedure.....	59
Post-requisites.....	59
32 Removing the palm-rest assembly.....	60
Prerequisites.....	60
Procedure.....	60
33 Replacing the palm-rest assembly.....	61
Procedure.....	61
Post-requisites.....	61
34 Device drivers.....	62
Intel Chipset Software Installation Utility.....	62
Video drivers.....	62
Intel Serial IO driver.....	62
Intel Trusted Execution Engine Interface.....	62
Intel Virtual Button driver.....	62
Wireless and Bluetooth drivers.....	62
35 System setup.....	63
System setup.....	63

Entering BIOS setup program.....	63
Navigation keys.....	63
Boot Sequence.....	64
System setup options.....	64
Clearing CMOS settings.....	68
Clearing BIOS (System Setup) and System passwords.....	69
36 Troubleshooting.....	70
Enhanced Pre-Boot System Assessment (ePSA) diagnostics.....	70
Running the ePSA diagnostics.....	70
System diagnostic lights.....	70
Recovering the operating system.....	71
Flashing BIOS (USB key).....	71
Flashing the BIOS.....	72
Flea power release.....	72
Wi-Fi power cycle.....	72
37 Getting help and contacting Dell.....	73

Before working inside your computer

 **NOTE:** The images in this document may differ from your computer depending on the configuration you ordered.

Topics:

- [Before you begin](#)

Before you begin

1. Save and close all open files and exit all open applications.
2. Shut down your computer. Click **Start** >  **Power** > **Shut down**.

 **NOTE:** If you are using a different operating system, see the documentation of your operating system for shut-down instructions.

3. Disconnect your computer and all attached devices from their electrical outlets.
4. Disconnect all attached network devices and peripherals, such as keyboard, mouse, and monitor from your computer.
5. Remove any media card and optical disc from your computer, if applicable.









After working inside your computer

 **CAUTION:** Leaving stray or loose screws inside your computer may severely damage your computer.

1. Replace all screws and ensure that no stray screws remain inside your computer.
2. Connect any external devices, peripherals, or cables you removed before working on your computer.
3. Replace any media cards, discs, or any other parts that you removed before working on your computer.
4. Connect your computer and all attached devices to their electrical outlets.
5. Turn on your computer.

Safety instructions

Use the following safety guidelines to protect your computer from potential damage and to ensure your personal safety. Unless otherwise noted, each procedure included in this document assumes that you have read the safety information that shipped with your computer.

-  **NOTE:** Before working inside your computer, read the safety information that shipped with your computer. For more safety best practices, see the Regulatory Compliance home page at www.dell.com/regulatory_compliance.
-  **NOTE:** Disconnect all power sources before opening the computer cover or panels. After you finish working inside the computer, replace all covers, panels, and screws before connecting to the electrical outlet.
-  **CAUTION:** To avoid damaging the computer, ensure that the work surface is flat and clean.
-  **CAUTION:** Handle components and cards with care. Do not touch the components or contacts on a card. Hold a card by its edges or by its metal mounting bracket. Hold a component such as a processor by its edges, not by its pins.
-  **CAUTION:** You should only perform troubleshooting and repairs as authorized or directed by the Dell technical assistance team. Damage due to servicing that is not authorized by Dell is not covered by your warranty. See the safety instructions that shipped with the product or at www.dell.com/regulatory_compliance.
-  **CAUTION:** Before touching anything inside your computer, ground yourself by using a wrist grounding strap or by periodically touching an unpainted metal surface, such as the metal at the back of the computer. While you work, periodically touch an unpainted metal surface to dissipate static electricity, which could harm internal components.
-  **CAUTION:** When you disconnect a cable, pull on its connector or on its pull tab, not on the cable itself. Some cables have connectors with locking tabs or thumb-screws that you must disengage before disconnecting the cable. When disconnecting cables, keep them evenly aligned to avoid bending any connector pins. When connecting cables, ensure that the ports and connectors are correctly oriented and aligned.
-  **CAUTION:** Press and eject any installed card from the media-card reader.
-  **NOTE:** The color of your computer and certain components may appear differently than shown in this document.

Topics:

- [Electrostatic discharge—ESD protection](#)
- [ESD field service kit](#)
- [Transporting sensitive components](#)

Electrostatic discharge—ESD protection

ESD is a major concern when you handle electronic components, especially sensitive components such as expansion cards, processors, memory DIMMs, and system boards. Very slight charges can damage circuits in ways that may not be obvious, such as intermittent problems or a shortened product life span. As the industry pushes for lower power requirements and increased density, ESD protection is an increasing concern.

Due to the increased density of semiconductors used in recent Dell products, the sensitivity to static damage is now higher than in previous Dell products. For this reason, some previously approved methods of handling parts are no longer applicable.

Two recognized types of ESD damage are catastrophic and intermittent failures.

- **Catastrophic** – Catastrophic failures represent approximately 20 percent of ESD-related failures. The damage causes an immediate and complete loss of device functionality. An example of catastrophic failure is a memory DIMM that has received a static shock and immediately generates a "No POST/No Video" symptom with a beep code emitted for missing or nonfunctional memory.
- **Intermittent** – Intermittent failures represent approximately 80 percent of ESD-related failures. The high rate of intermittent failures means that most of the time when damage occurs, it is not immediately recognizable. The DIMM receives a static shock, but the

tracing is merely weakened and does not immediately produce outward symptoms related to the damage. The weakened trace may take weeks or months to melt, and in the meantime may cause degradation of memory integrity, intermittent memory errors, etc.

The more difficult type of damage to recognize and troubleshoot is the intermittent (also called latent or "walking wounded") failure.

Perform the following steps to prevent ESD damage:

- Use a wired ESD wrist strap that is properly grounded. The use of wireless anti-static straps is no longer allowed; they do not provide adequate protection. Touching the chassis before handling parts does not ensure adequate ESD protection on parts with increased sensitivity to ESD damage.
- Handle all static-sensitive components in a static-safe area. If possible, use anti-static floor pads and workbench pads.
- When unpacking a static-sensitive component from its shipping carton, do not remove the component from the anti-static packing material until you are ready to install the component. Before unwrapping the anti-static packaging, ensure that you discharge static electricity from your body.
- Before transporting a static-sensitive component, place it in an anti-static container or packaging.

ESD field service kit

The unmonitored Field Service kit is the most commonly used service kit. Each Field Service kit includes three main components: anti-static mat, wrist strap, and bonding wire.

Components of an ESD field service kit

The components of an ESD field service kit are:

- **Anti-Static Mat** – The anti-static mat is dissipative and parts can be placed on it during service procedures. When using an anti-static mat, your wrist strap should be snug and the bonding wire should be connected to the mat and to any bare metal on the system being worked on. Once deployed properly, service parts can be removed from the ESD bag and placed directly on the mat. ESD-sensitive items are safe in your hand, on the ESD mat, in the system, or inside a bag.
- **Wrist Strap and Bonding Wire** – The wrist strap and bonding wire can be either directly connected between your wrist and bare metal on the hardware if the ESD mat is not required, or connected to the anti-static mat to protect hardware that is temporarily placed on the mat. The physical connection of the wrist strap and bonding wire between your skin, the ESD mat, and the hardware is known as bonding. Use only Field Service kits with a wrist strap, mat, and bonding wire. Never use wireless wrist straps. Always be aware that the internal wires of a wrist strap are prone to damage from normal wear and tear, and must be checked regularly with a wrist strap tester in order to avoid accidental ESD hardware damage. It is recommended to test the wrist strap and bonding wire at least once per week.
- **ESD Wrist Strap Tester** – The wires inside of an ESD strap are prone to damage over time. When using an unmonitored kit, it is a best practice to regularly test the strap prior to each service call, and at a minimum, test once per week. A wrist strap tester is the best method for doing this test. If you do not have your own wrist strap tester, check with your regional office to find out if they have one. To perform the test, plug the wrist-strap's bonding-wire into the tester while it is strapped to your wrist and push the button to test. A green LED is lit if the test is successful; a red LED is lit and an alarm sounds if the test fails.
- **Insulator Elements** – It is critical to keep ESD sensitive devices, such as plastic heat sink casings, away from internal parts that are insulators and often highly charged.
- **Working Environment** – Before deploying the ESD Field Service kit, assess the situation at the customer location. For example, deploying the kit for a server environment is different than for a desktop or portable environment. Servers are typically installed in a rack within a data center; desktops or portables are typically placed on office desks or cubicles. Always look for a large open flat work area that is free of clutter and large enough to deploy the ESD kit with additional space to accommodate the type of system that is being repaired. The workspace should also be free of insulators that can cause an ESD event. On the work area, insulators such as Styrofoam and other plastics should always be moved at least 12 inches or 30 centimeters away from sensitive parts before physically handling any hardware components.
- **ESD Packaging** – All ESD-sensitive devices must be shipped and received in static-safe packaging. Metal, static-shielded bags are preferred. However, you should always return the damaged part using the same ESD bag and packaging that the new part arrived in. The ESD bag should be folded over and taped shut and all the same foam packing material should be used in the original box that the new part arrived in. ESD-sensitive devices should be removed from packaging only at an ESD-protected work surface, and parts should never be placed on top of the ESD bag because only the inside of the bag is shielded. Always place parts in your hand, on the ESD mat, in the system, or inside an anti-static bag.
- **Transporting Sensitive Components** – When transporting ESD sensitive components such as replacement parts or parts to be returned to Dell, it is critical to place these parts in anti-static bags for safe transport.

ESD protection summary

It is recommended that all field service technicians use the traditional wired ESD grounding wrist strap and protective anti-static mat at all times when servicing Dell products. In addition, it is critical that technicians keep sensitive parts separate from all insulator parts while performing service and that they use anti-static bags for transporting sensitive components.

Transporting sensitive components

When transporting ESD sensitive components such as replacement parts or parts to be returned to Dell, it is critical to place these parts in anti-static bags for safe transport.

Lifting equipment

Adhere to the following guidelines when lifting heavy weight equipment:

 **CAUTION: Do not lift greater than 50 pounds. Always obtain additional resources or use a mechanical lifting device.**

1. Get a firm balanced footing. Keep your feet apart for a stable base, and point your toes out.
2. Tighten stomach muscles. Abdominal muscles support your spine when you lift, offsetting the force of the load.
3. Lift with your legs, not your back.
4. Keep the load close. The closer it is to your spine, the less force it exerts on your back.
5. Keep your back upright, whether lifting or setting down the load. Do not add the weight of your body to the load. Avoid twisting your body and back.
6. Follow the same techniques in reverse to set the load down.

Recommended tools













The procedures in this document may require the following tools:



- Phillips screwdriver #0
- Phillips screwdriver #1
- Torx #5 (T5) screwdriver
- Plastic scribe

Screw list

- NOTE:** When removing screws from a component, it is recommended to note the screw type, the quantity of screws, and then place them in a screw storage box. This is to ensure that the correct number of screws and correct screw type is restored when the component is replaced.
- NOTE:** Some computers have magnetic surfaces. Ensure that the screws are not left attached to such surface when replacing a component.
- NOTE:** Screw color may vary with the configuration ordered.

Table 1. Screw list

Component	Secured to	Screw type	Quantity	Screw image
Keyboard	Palm-rest assembly	M1.6x1.5	29	
Fingerprint-reader board	Palm-rest assembly	M1.6x1.5	1	
<p>NOTE: This component is only available on systems with fingerprint reader integrated on the power button.</p>				
Power button	Palm-rest assembly	M1.4x1.7	2	
System board	Palm-rest assembly	M1.6x2.5	10	
Fans	System board	M1.6x3L	2	
Speakers	Palm-rest assembly	M2x2	4	
Heat sink	System board	M2x3	4	
Headset port	Palm-rest assembly	M1.6x3	1	
Display assembly	Palm-rest assembly	M2.5x4	4	
Wireless antenna and camera cable bracket	System board	M1.6x3L	1	
Display cable bracket	System board	M1.6x2.5	2	
Solid-state drive shield and solid-state drive	System board	M2x3L	1	
Battery	Palm-rest assembly	M2x2	4	

Component	Secured to	Screw type	Quantity	Screw image
Battery	Palm-rest assembly	M1.6x4	1	
Base cover	Palm-rest assembly	M2x3, Torx	8	

Removing the base cover

NOTE: Before working inside your computer, read the safety information that shipped with your computer and follow the steps in [Before working inside your computer](#). After working inside your computer, follow the instructions in [After working inside your computer](#). For more safety best practices, see the Regulatory Compliance home page at www.dell.com/regulatory_compliance.

Topics:

- [Procedure](#)

Procedure

CAUTION: To avoid causing damage to the computer, do not pry open the base cover from the back.

1. Remove the eight screws (M2x3, Torx) that secure the base cover to the palm-rest assembly.

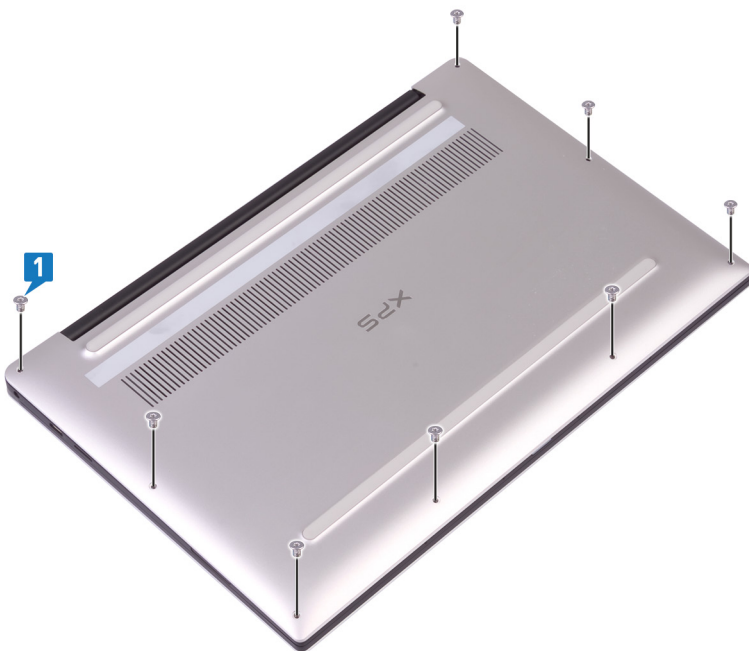

2. With the computer face-down, open the computer at an angle.
3. Using a plastic scribe, pry the base cover from the palm-rest assembly.

CAUTION: To avoid causing damage to your computer follow the instructions instead of lifting the base cover from the palm-rest assembly.

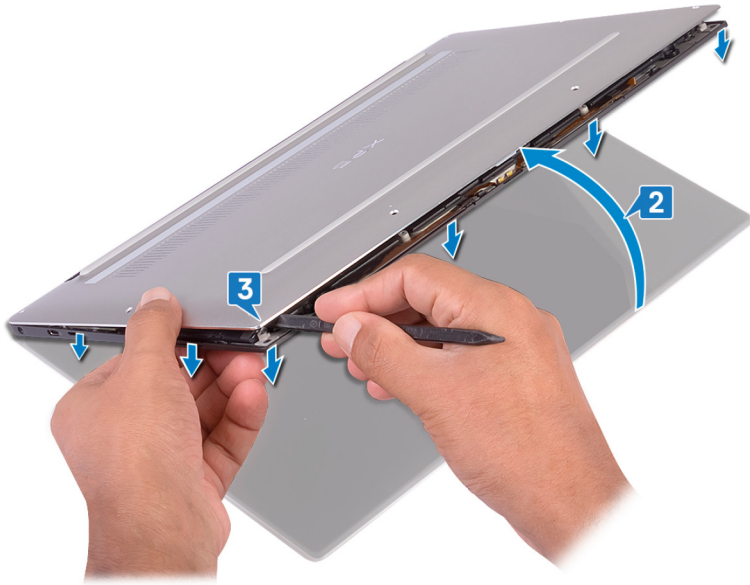

4. Moving the base cover from left to right, release the clips securing the base cover to the palm-rest assembly.
5. Lift the base cover from the palm-rest assembly.

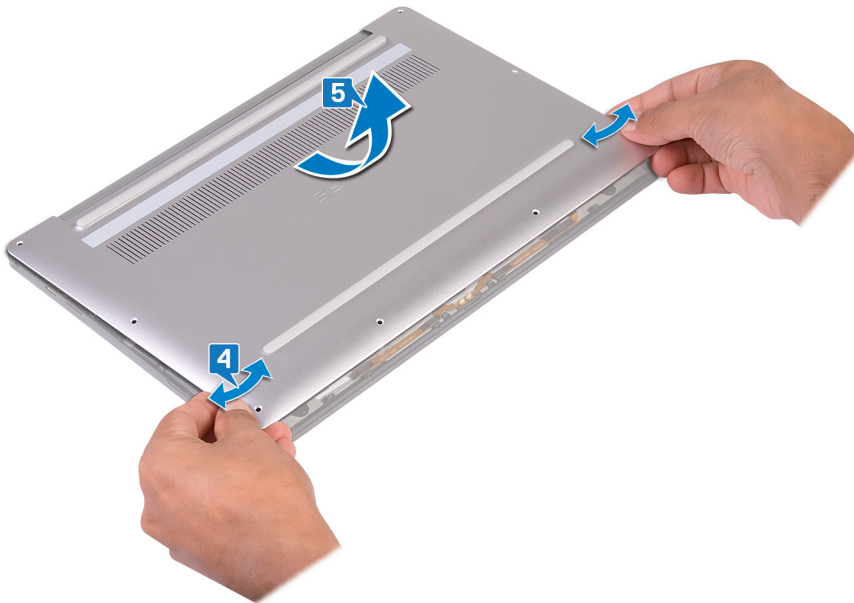

Replacing the base cover

NOTE: Before working inside your computer, read the safety information that shipped with your computer and follow the steps in [Before working inside your computer](#). After working inside your computer, follow the instructions in [After working inside your computer](#). For more safety best practices, see the Regulatory Compliance home page at www.dell.com/regulatory_compliance.

Topics:

- [Procedure](#)

Procedure

1. Align the screw holes on the base cover with the screw holes on the palm-rest assembly and slide in the base cover into place.

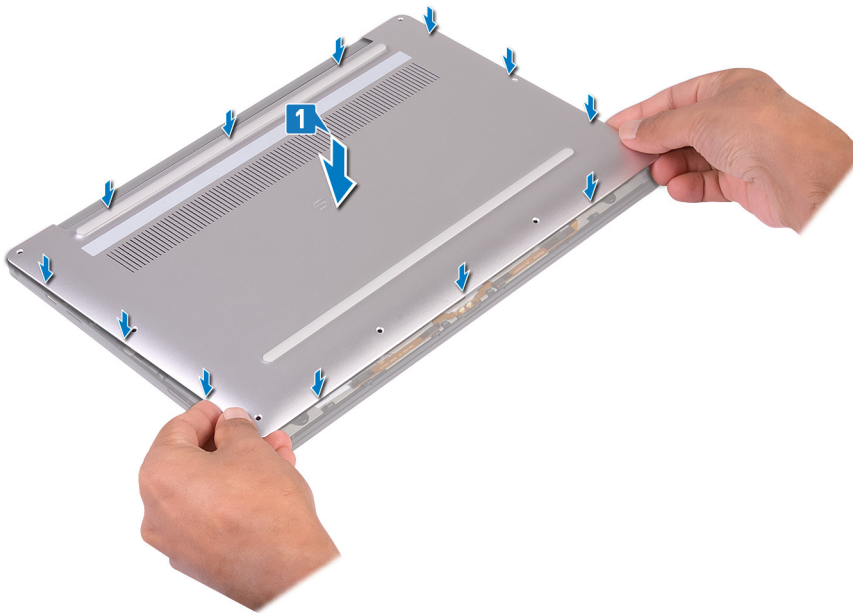

2. Replace the eight screws (M2x3, Torx) that secure the base cover to the palm-rest assembly.

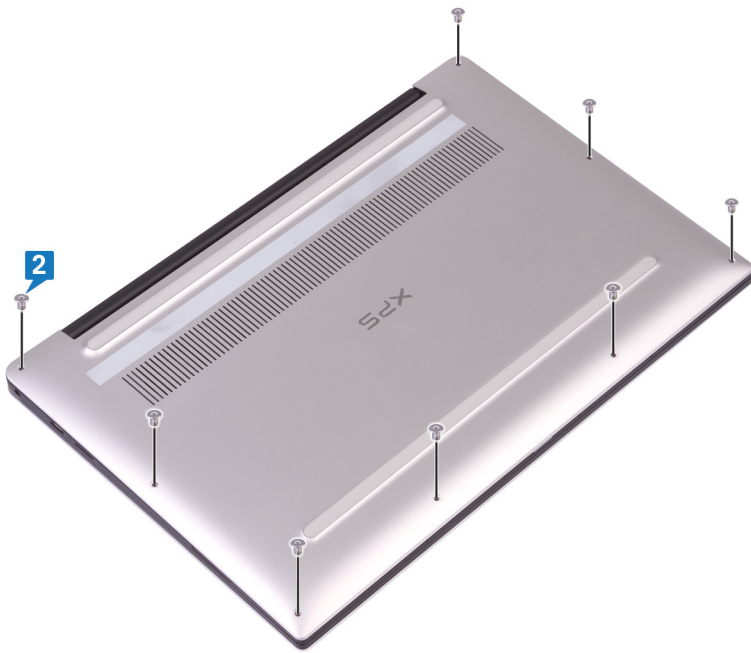

Removing the battery

NOTE: Before working inside your computer, read the safety information that shipped with your computer and follow the steps in [Before working inside your computer](#). After working inside your computer, follow the instructions in [After working inside your computer](#). For more safety best practices, see the Regulatory Compliance home page at www.dell.com/regulatory_compliance.

Topics:

- [Lithium-ion battery precautions](#)
- [Prerequisites](#)
- [Procedure](#)

Lithium-ion battery precautions

CAUTION:

- Exercise caution when handling Lithium-ion batteries.
- Discharge the battery as much as possible before removing it from the system. This can be done by disconnecting the AC adapter from the system to allow the battery to drain.
- Do not crush, drop, mutilate, or penetrate the battery with foreign objects.
- Do not expose the battery to high temperatures, or disassemble battery packs and cells.
- Do not apply pressure to the surface of the battery.
- Do not bend the battery.
- Do not use tools of any kind to pry on or against the battery.
- Ensure any screws during the servicing of this product are not lost or misplaced, to prevent accidental puncture or damage to the battery and other system components.
- If a battery gets stuck in a device as a result of swelling, do not try to free it as puncturing, bending, or crushing a Lithium-ion battery can be dangerous. In such an instance, contact for assistance and further instructions.
- If the battery gets stuck inside your computer as a result of swelling, do not try to release it as puncturing, bending, or crushing a lithium-ion battery can be dangerous. In such an instance, contact Dell technical support for assistance. See www.dell.com/contactdell.
- Always purchase genuine batteries from www.dell.com or authorized Dell partners and resellers.

Prerequisites

Remove the [base cover](#).

Procedure

1. Ensure that the battery cable is disconnected from the system board.

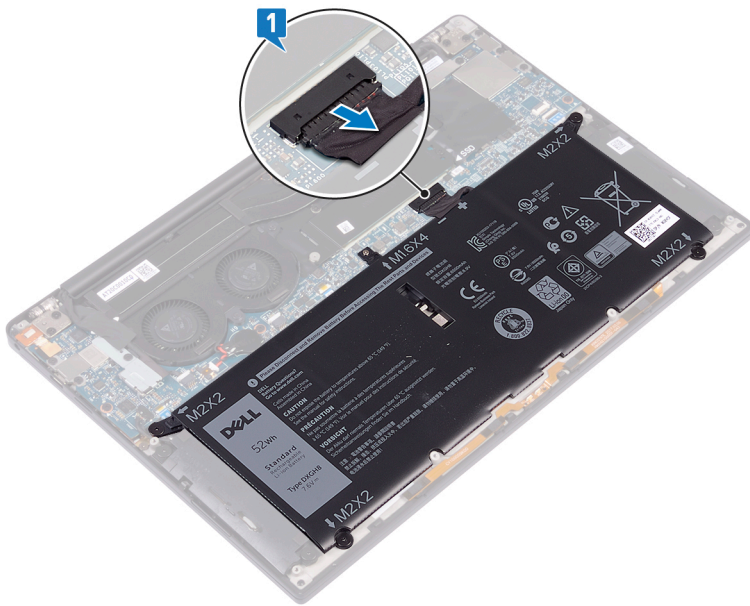

2. Remove the four screws (M2x2) that secure the battery to the palm-rest assembly.
3. Remove the screw (M1.6x4) that secures the battery to the palm-rest assembly.
4. Lift the battery off the palm-rest assembly.

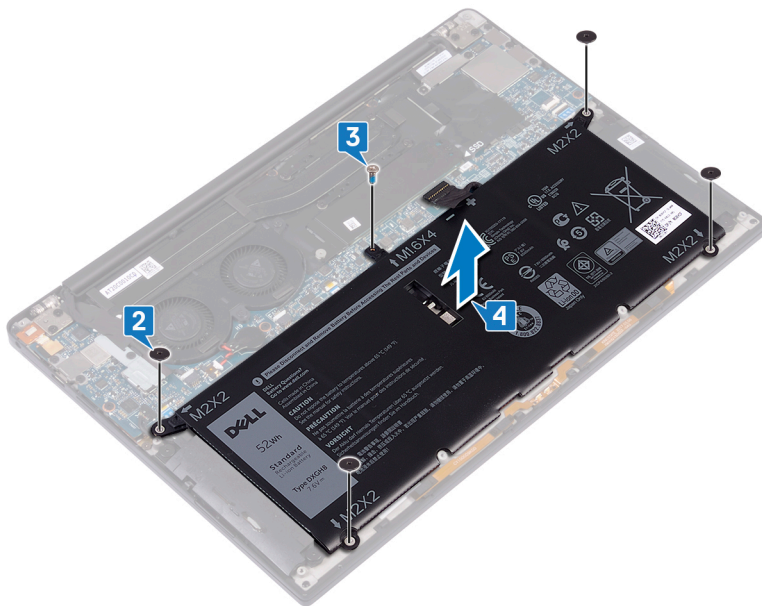

5. Turn the computer over, open the display, and press the power button for about 5 seconds to ground the computer.

Replacing the battery

NOTE: Before working inside your computer, read the safety information that shipped with your computer and follow the steps in [Before working inside your computer](#). After working inside your computer, follow the instructions in [After working inside your computer](#). For more safety best practices, see the Regulatory Compliance home page at www.dell.com/regulatory_compliance.

Topics:

- [Lithium-ion battery precautions](#)
- [Procedure](#)
- [Post-requisites](#)

Lithium-ion battery precautions

CAUTION:

- Exercise caution when handling Lithium-ion batteries.
- Discharge the battery as much as possible before removing it from the system. This can be done by disconnecting the AC adapter from the system to allow the battery to drain.
- Do not crush, drop, mutilate, or penetrate the battery with foreign objects.
- Do not expose the battery to high temperatures, or disassemble battery packs and cells.
- Do not apply pressure to the surface of the battery.
- Do not bend the battery.
- Do not use tools of any kind to pry on or against the battery.
- Ensure any screws during the servicing of this product are not lost or misplaced, to prevent accidental puncture or damage to the battery and other system components.
- If a battery gets stuck in a device as a result of swelling, do not try to free it as puncturing, bending, or crushing a Lithium-ion battery can be dangerous. In such an instance, contact for assistance and further instructions.
- If the battery gets stuck inside your computer as a result of swelling, do not try to release it as puncturing, bending, or crushing a lithium-ion battery can be dangerous. In such an instance, contact Dell technical support for assistance. See www.dell.com/contactdell.
- Always purchase genuine batteries from www.dell.com or authorized Dell partners and resellers.

Procedure

1. Align the screw holes on the battery with the screw holes on the palm-rest assembly.
2. Replace the four screws (M2x2) that secure the battery to the palm-rest assembly.
3. Replace the screw (M1.6x4) that secures the battery to the palm-rest assembly.

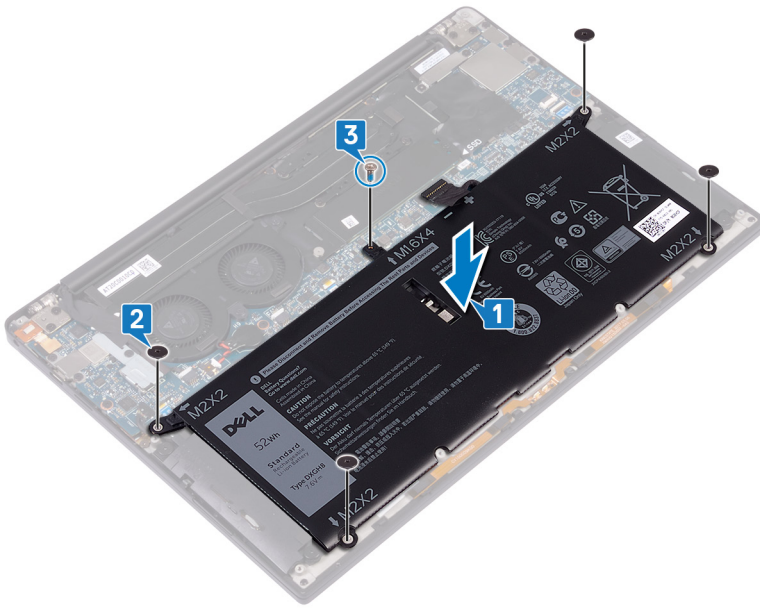

Post-requisites

Replace the [base cover](#).

Removing the solid-state drive

NOTE: Before working inside your computer, read the safety information that shipped with your computer and follow the steps in [Before working inside your computer](#). After working inside your computer, follow the instructions in [After working inside your computer](#). For more safety best practices, see the Regulatory Compliance home page at www.dell.com/regulatory_compliance.

CAUTION: Solid-state drives are fragile. Exercise care when handling the solid-state drive.

CAUTION: To avoid data loss, do not remove the solid-state drive while the computer is in sleep or on state.

Topics:

- [Prerequisites](#)
- [Procedure to remove M.2 2280 solid-state drive](#)

Prerequisites

1. Remove the [base cover](#).
2. Remove the [battery](#).

Procedure to remove M.2 2280 solid-state drive

1. Remove the screw (M2x3) that secures the solid-state drive shield and the solid-state drive to the system board.
2. Slide and remove the solid-state drive shield from the solid state drive slot.
3. Lift the solid-state drive at an angle, then slide and remove the solid-state drive from the solid-state drive slot.

NOTE: The 2280 solid-state drive has a unique thermal plate and cannot be interchanged with the 2230 solid-state drive thermal plate.

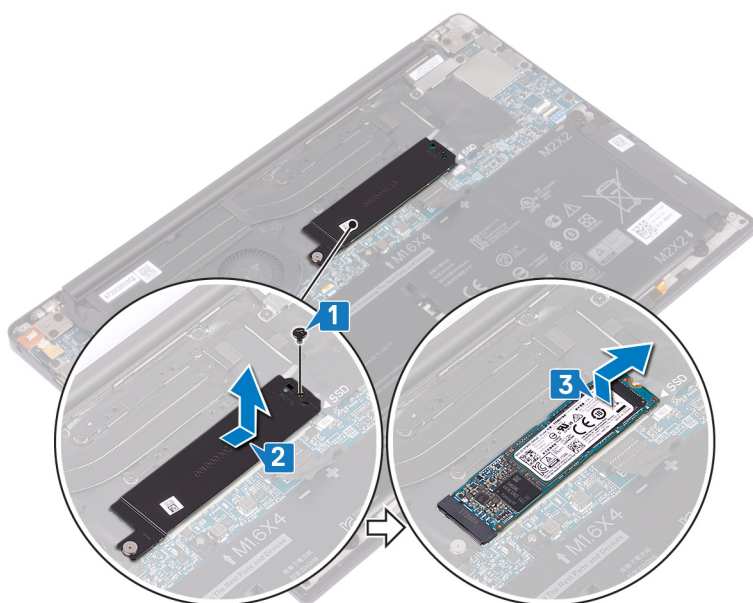

Procedure to remove M.2 2230 solid-state drive

1. Remove the screw (M2x3) that secures the solid-state drive shield and the solid-state drive to the system board.
2. Slide and remove the solid-state drive shield from the solid state drive slot.
3. Lift the solid-state drive at an angle, then slide and remove the solid-state drive from the solid-state drive slot.

i **NOTE:** The 2230 solid-state drive has a unique thermal plate and cannot be interchanged with the 2280 solid-state drive thermal plate.

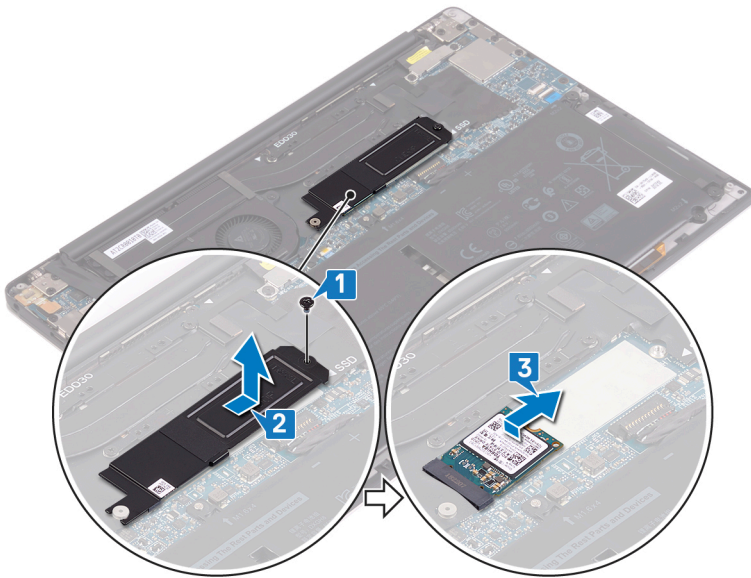

Replacing the solid-state drive

NOTE: Before working inside your computer, read the safety information that shipped with your computer and follow the steps in [Before working inside your computer](#). After working inside your computer, follow the instructions in [After working inside your computer](#). For more safety best practices, see the Regulatory Compliance home page at www.dell.com/regulatory_compliance.

CAUTION: Solid-state drives are fragile. Exercise care when handling the solid-state drive.

Topics:

- [Procedure to replace 2280 solid-state drive](#)
- [Post-requisites](#)

Procedure to replace 2280 solid-state drive

1. Align the notches on the solid-state drive with the tabs in the solid-state drive slot, then slide the solid-state drive at an angle into the solid-state drive slot.
2. Slide the solid-state drive shield into the solid-state drive shield slot. Then align the screw hole on the solid-state drive shield and solid-state drive to the screw hold on the system board.

NOTE: The 2230 solid-state drive has a unique thermal plate and cannot be interchanged with the 2280 solid-state drive thermal plate.

3. Replace the screw (M2x3) that secures the solid-state drive to the system board.

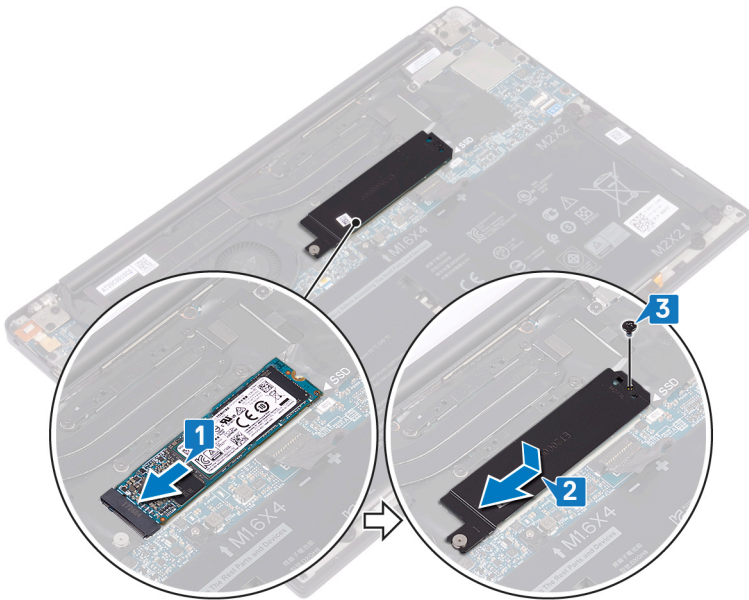

Procedure to replace 2230 solid-state drive

1. Align the notches on the solid-state drive with the tabs in the solid-state drive slot, then slide the solid-state drive at an angle into the solid-state drive slot.
2. Slide the solid-state drive shield into the solid-state drive shield slot. Then align the screw hole on the solid-state drive shield and solid-state drive to the screw hold on the system board.

NOTE: The 2230 solid-state drive has a unique thermal plate and cannot be interchanged with the 2280 solid-state drive thermal plate.

3. Replace the screw (M2x3) that secures the solid-state drive to the system board.

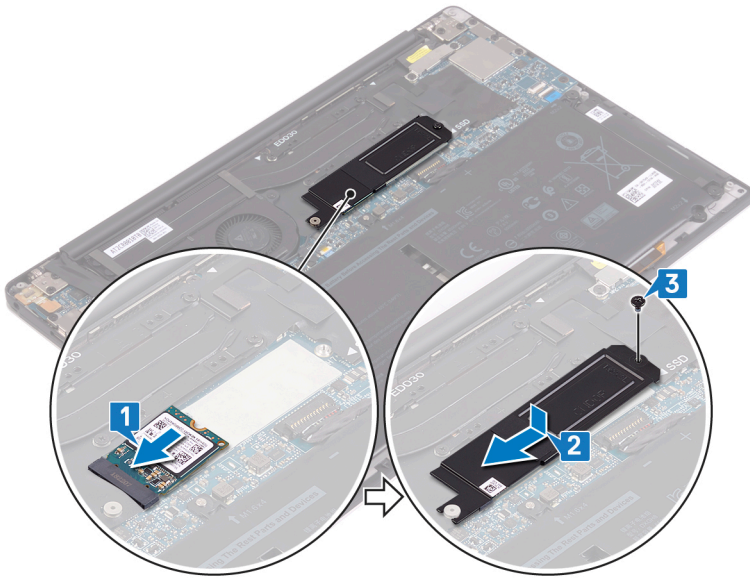

Post-requisites

1. Replace the [battery](#).
2. Replace the [base cover](#).

Removing the speakers

NOTE: Before working inside your computer, read the safety information that shipped with your computer and follow the steps in [Before working inside your computer](#). After working inside your computer, follow the instructions in [After working inside your computer](#). For more safety best practices, see the Regulatory Compliance home page at www.dell.com/regulatory_compliance.

Topics:

- [Prerequisites](#)
- [Procedure](#)

Prerequisites

1. Remove the [base cover](#).
2. Remove the [battery](#).

Procedure

1. Disconnect the speaker cable from the system board.
2. Remove the four screws (M2x2) that secure the left and right speakers to the palm-rest assembly.
3. Note the speaker-cable routing and peel off the tapes (4) that secure the speaker cable to the keyboard.
4. Lift the left and right speakers, along with their cables, off the palm-rest assembly.

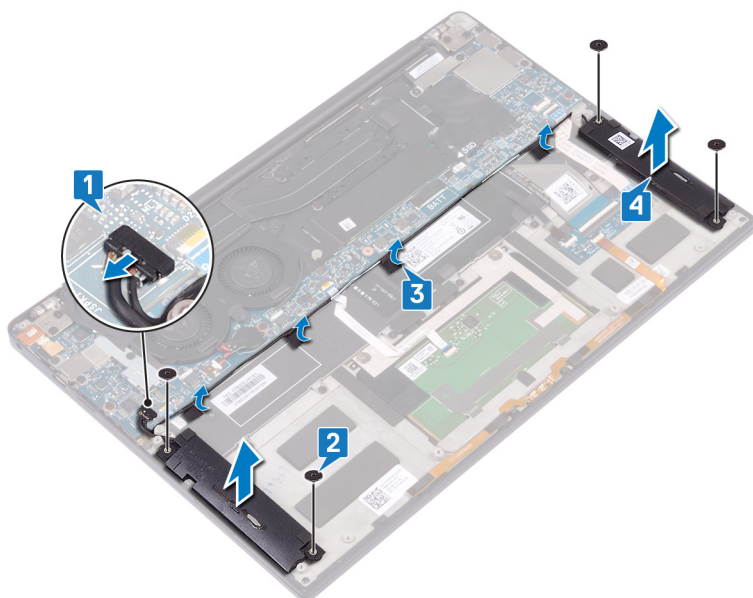

Replacing the speakers

NOTE: Before working inside your computer, read the safety information that shipped with your computer and follow the steps in [Before working inside your computer](#). After working inside your computer, follow the instructions in [After working inside your computer](#). For more safety best practices, see the Regulatory Compliance home page at www.dell.com/regulatory_compliance.

Topics:

- [Procedure](#)
- [Post-requisites](#)

Procedure

1. Using the alignment posts on the palm-rest assembly, place the left speaker on the palm-rest assembly.
2. Route the speaker cable on the system board and adhere the tape to the system board.
3. Using the alignment posts on the palm-rest assembly, place the right speaker on the palm-rest assembly.
4. Replace the four screws (M2x2) that secure the speakers to the palm-rest assembly.
5. Connect the speaker cable to the system board.

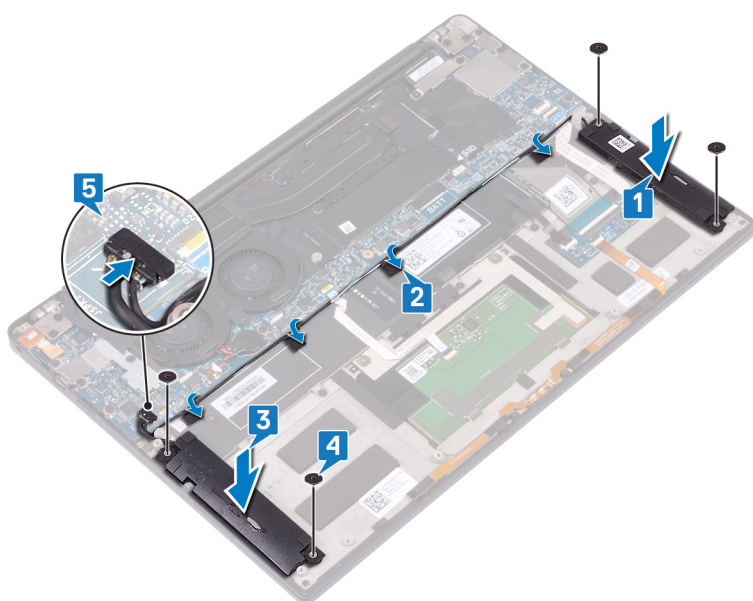

Post-requisites

1. Replace the [battery](#).
2. Replace the [base cover](#).

Removing the coin-cell battery

NOTE: Before working inside your computer, read the safety information that shipped with your computer and follow the steps in [Before working inside your computer](#). After working inside your computer, follow the instructions in [After working inside your computer](#). For more safety best practices, see the Regulatory Compliance home page at www.dell.com/regulatory_compliance.

CAUTION: Removing the coin-cell battery resets the BIOS setup program's settings to default. It is recommended that you note the BIOS setup program's settings before removing the coin-cell battery.

Topics:

- [Prerequisites](#)
- [Procedure](#)

Prerequisites

1. Remove the [base cover](#).
2. Remove the [battery](#).

Procedure

1. Disconnect the coin-cell battery cable from the system board.
2. Note the location of the coin-cell battery and pry it off the system board.

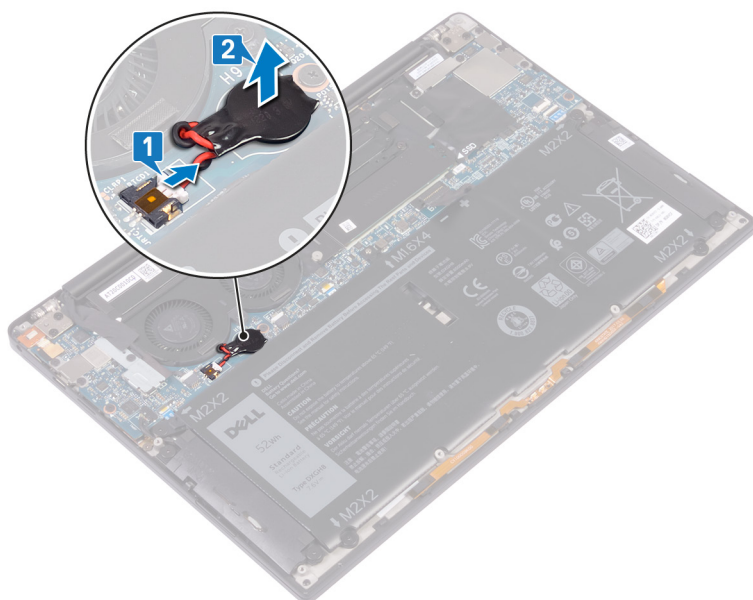

Replacing the coin-cell battery

NOTE: Before working inside your computer, read the safety information that shipped with your computer and follow the steps in [Before working inside your computer](#). After working inside your computer, follow the instructions in [After working inside your computer](#). For more safety best practices, see the Regulatory Compliance home page at www.dell.com/regulatory_compliance.

Topics:

- [Procedure](#)
- [Post-requisites](#)

Procedure

1. Adhere the coin-cell battery to the system board.
2. Connect the coin-cell battery cable to the system board.

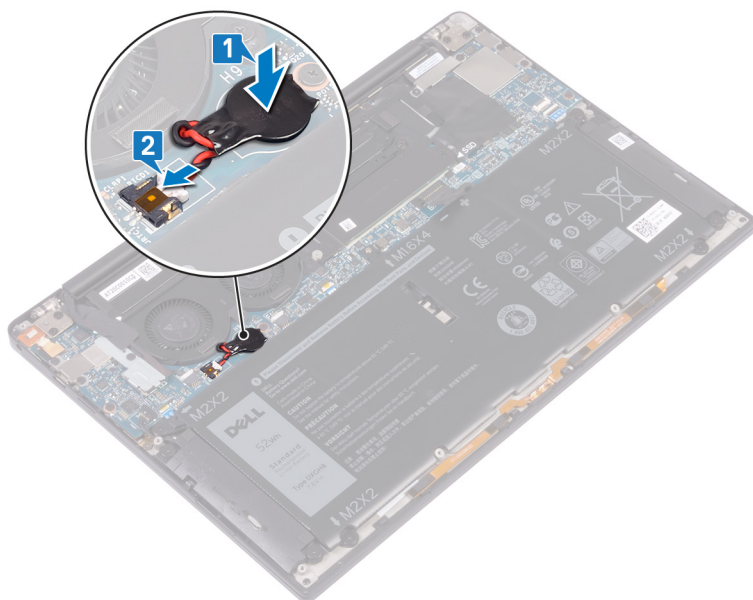

Post-requisites

1. Replace the [battery](#).
2. Replace the [base cover](#).

Removing the heat sink

NOTE: Before working inside your computer, read the safety information that shipped with your computer and follow the steps in [Before working inside your computer](#). After working inside your computer, follow the instructions in [After working inside your computer](#). For more safety best practices, see the Regulatory Compliance home page at www.dell.com/regulatory_compliance.

NOTE: The heat sink may become hot during normal operation. Allow sufficient time for the heat sink to cool before you touch it.

CAUTION: For maximum cooling of the processor, do not touch the heat transfer areas on the heat sink. The oils in your skin can reduce the heat transfer capability of the thermal grease.

Topics:

- [Prerequisites](#)
- [Procedure](#)

Prerequisites

1. Remove the [base cover](#).
2. Remove the [battery](#).

Procedure

The following procedure applies only to computers shipped with heat sink.

1. In reverse-sequential order (as indicated on the heat sink), remove the four screws (M2x3) that secure the heat sink to the system board.
2. Lift the heat sink off the system board.

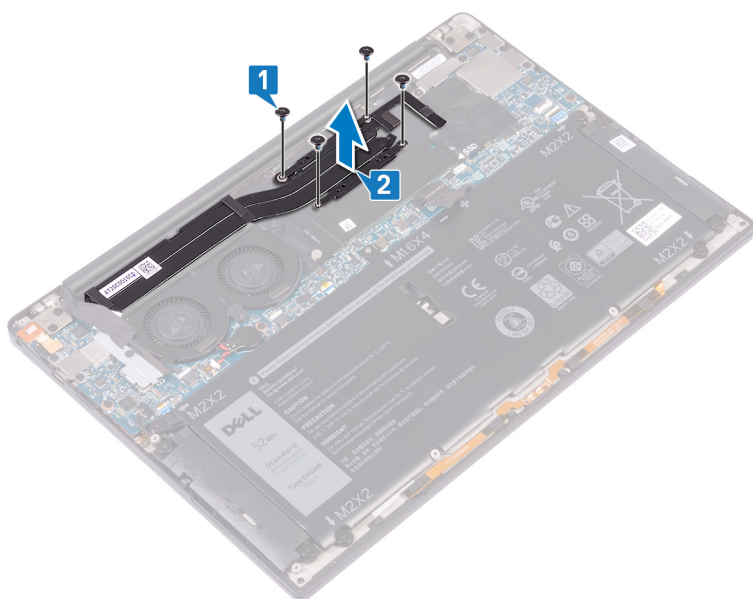

Replacing the heat sink

NOTE: Before working inside your computer, read the safety information that shipped with your computer and follow the steps in [Before working inside your computer](#). After working inside your computer, follow the instructions in [After working inside your computer](#). For more safety best practices, see the Regulatory Compliance home page at www.dell.com/regulatory_compliance.

CAUTION: Incorrect alignment of the heat sink can damage the system board and processor.

NOTE: If either the system board or the heat sink is replaced, use the thermal pad/paste provided in the kit to ensure that thermal conductivity is achieved.

Topics:

- [Procedure](#)
- [Post-requisites](#)

Procedure

The following procedure applies only to computers shipped with heat sink.

1. Align the screw holes on the heat sink with the screw holes on the system board.
2. Replace the four screws (M2x3) that secure the heat sink to the system board in sequential order (as indicated on the heat sink).

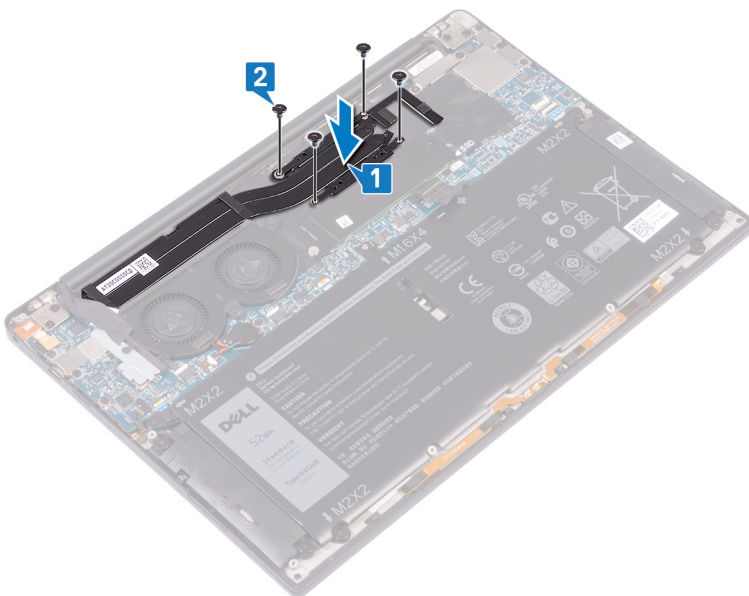

Post-requisites

1. Replace the [battery](#).
2. Replace the [base cover](#).

Removing the heat-sink assembly

NOTE: Before working inside your computer, read the safety information that shipped with your computer and follow the steps in [Before working inside your computer](#). After working inside your computer, follow the instructions in [After working inside your computer](#). For more safety best practices, see the Regulatory Compliance home page at www.dell.com/regulatory_compliance.

NOTE: The heat sink may become hot during normal operation. Allow sufficient time for the heat sink to cool before you touch it.

CAUTION: For maximum cooling of the processor, do not touch the heat transfer areas on the heat sink. The oils in your skin can reduce the heat transfer capability of the thermal grease.

Topics:

- [Prerequisites](#)
- [Procedure](#)

Prerequisites

1. Remove the [base cover](#).
2. Remove the [battery](#).

Procedure

The following procedure applies only to computers shipped with heat-sink assembly (combined heat sink and fans).

1. Remove the screw (M1.6x3) that secures the wireless antenna and camera-cable bracket to the system board.
2. Lift the wireless antenna and camera-cable bracket from the system board.
3. Disconnect and lift the wireless antenna and camera-cable bracket from the system board, peeling off the tape securing the camera cable to the heat-sink assembly.

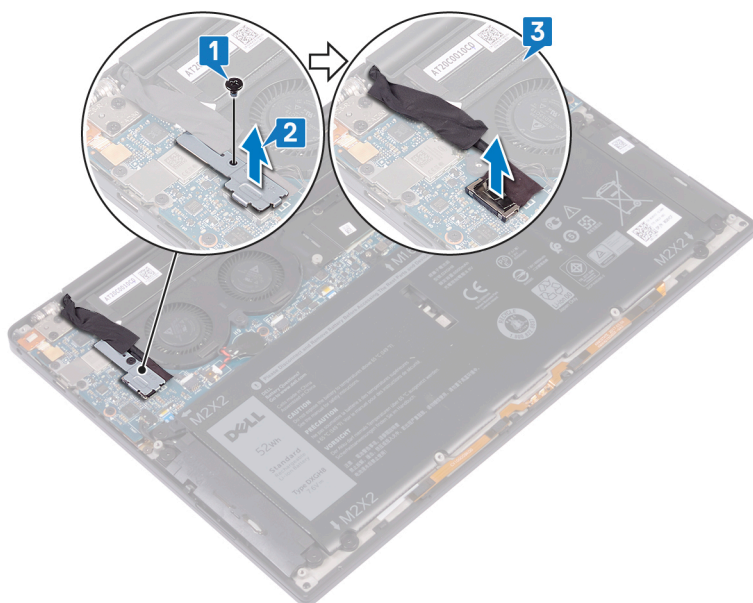

4. Disconnect the left-fan cable from the system board.
5. Disconnect the right-fan cable from the system board.

6. In reverse-sequential order (as indicated on the heat sink), remove the four screws (M2x3) that secure the heat-sink assembly to the system board.
7. Remove the two screws (M1.6x3) that secure the heat-sink assembly to the system board.
8. Lift the heat-sink assembly along with the left- and the right-fan cable off the system board.

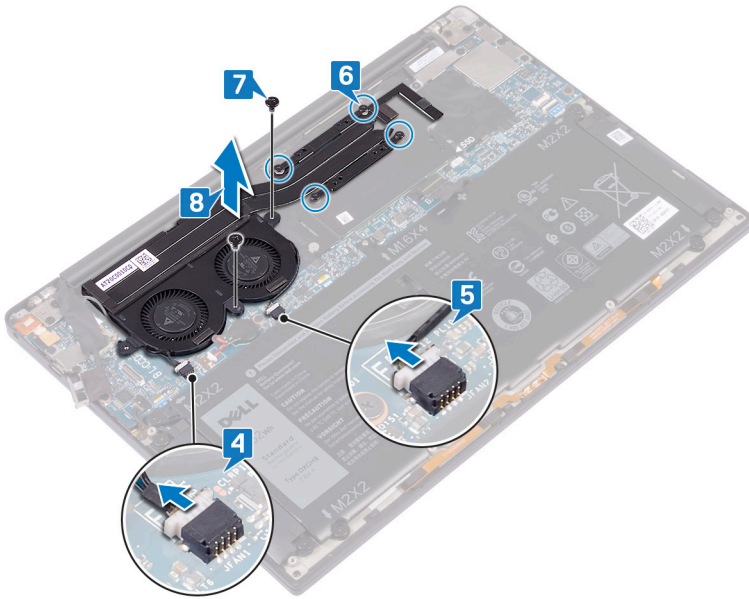

Replacing the heat-sink assembly

NOTE: Before working inside your computer, read the safety information that shipped with your computer and follow the steps in [Before working inside your computer](#). After working inside your computer, follow the instructions in [After working inside your computer](#). For more safety best practices, see the Regulatory Compliance home page at www.dell.com/regulatory_compliance.

CAUTION: Incorrect alignment of the heat sink can damage the system board and processor.

NOTE: If either the system board or the fan and heat-sink assembly is replaced, use the thermal pad/paste provided in the kit to ensure that thermal conductivity is achieved.

Topics:

- [Procedure](#)
- [Post-requisites](#)

Procedure

The following procedure applies only to computers shipped with heat-sink assembly (combined heat sink and fan).

1. Align the screw holes on the heat-sink assembly with the screw holes on the system board.
2. Replace the two screws (M1.6x3) that secure the heat-sink assembly to the system board.
3. Replace the four screws (M2x3) that secure the heat-sink assembly to the system board in sequential order (as indicated on the heat-sink assembly).
4. Connect the right-fan cable to the system board.
5. Connect the left-fan cable to the system board.

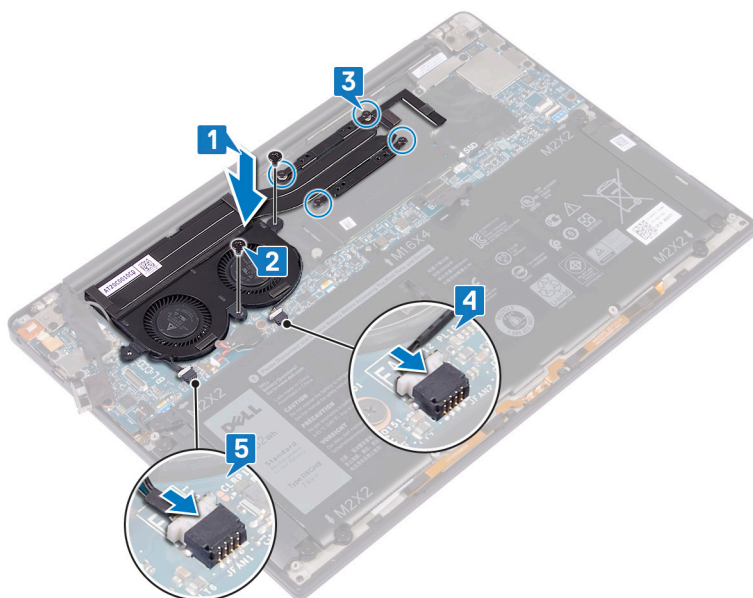

6. Connect the camera cable to the system board.
7. Align the screw hole on the wireless antenna and camera-cable bracket to the screw hole on the system board
8. Replace the screw (M1.6x3) that secures the wireless antenna and camera-cable bracket to the system board.

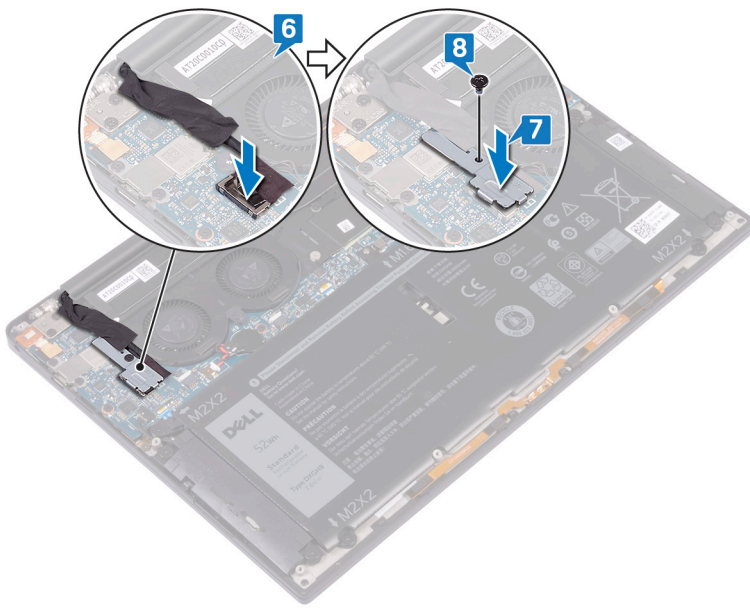

Post-requisites

1. Replace the [battery](#).
2. Replace the [base cover](#).

Removing the display assembly

NOTE: Before working inside your computer, read the safety information that shipped with your computer and follow the steps in [Before working inside your computer](#). After working inside your computer, follow the instructions in [After working inside your computer](#). For more safety best practices, see the Regulatory Compliance home page at www.dell.com/regulatory_compliance.

Topics:

- [Prerequisites](#)
- [Procedure](#)

Prerequisites

1. Remove the [base cover](#).
2. Remove the [battery](#).

Procedure

1. Remove the screw (M1.6x3) that secures the wireless antenna and camera cable bracket to the system board.
2. Lift the wireless antenna and camera cable bracket from the system board.
3. Disconnect and lift the camera cable from the system board, peeling off the tape securing the camera cable to the fans.
4. Remove the two screws (M1.6x2.5) that secure the display cable bracket to the system board.
5. Lift the display cable bracket from the system board.
6. Disconnect the display cable from the system board.

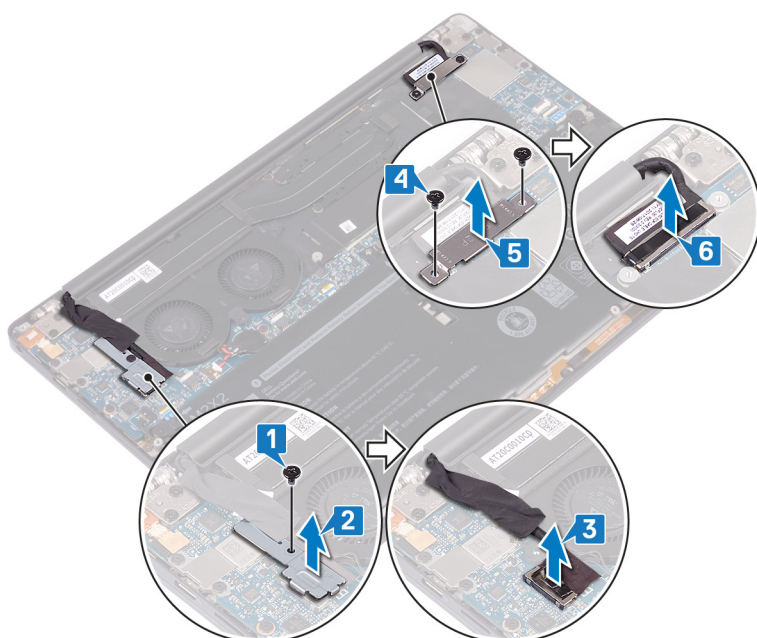

7. Disconnect the antenna cables from the system board.
8. Remove the four screws (M2.5x4) securing the display hinges to the palm-rest assembly.

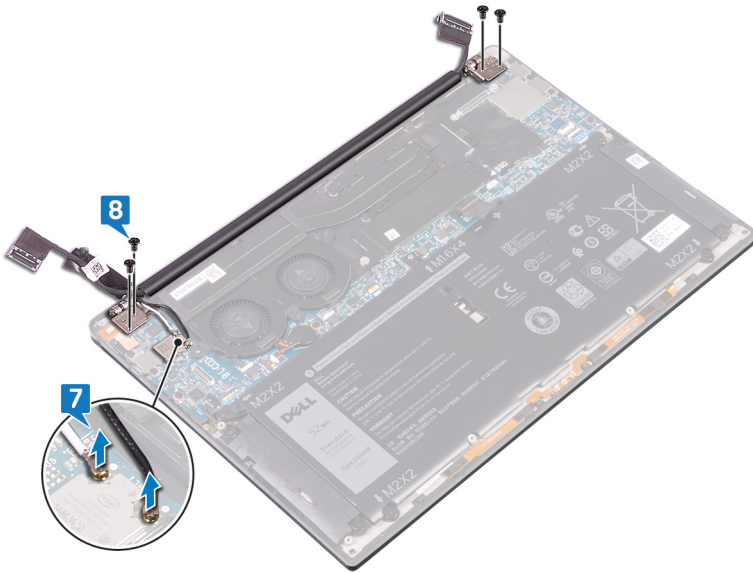

9. Place the top surface of the computer on a flat and clean surface, then open the computer at a 90 degree angle.
10. Gently slide and lift the display assembly from the palm-rest assembly.

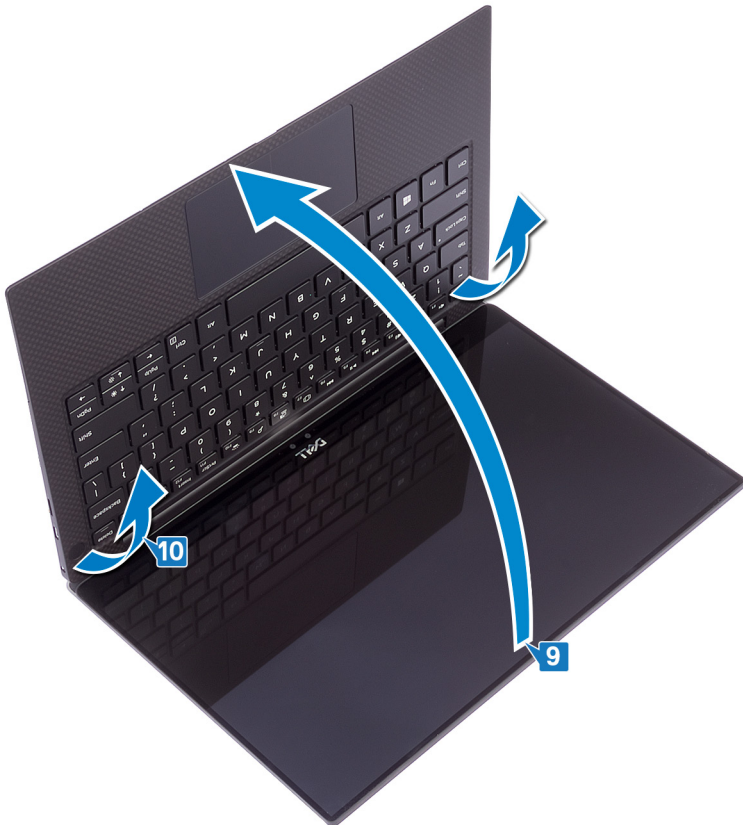

Replacing the display assembly

NOTE: Before working inside your computer, read the safety information that shipped with your computer and follow the steps in [Before working inside your computer](#). After working inside your computer, follow the instructions in [After working inside your computer](#). For more safety best practices, see the Regulatory Compliance home page at www.dell.com/regulatory_compliance.

Topics:

- [Procedure](#)
- [Post-requisites](#)

Procedure

1. Slide the palm-rest assembly under the hinges of the display assembly.

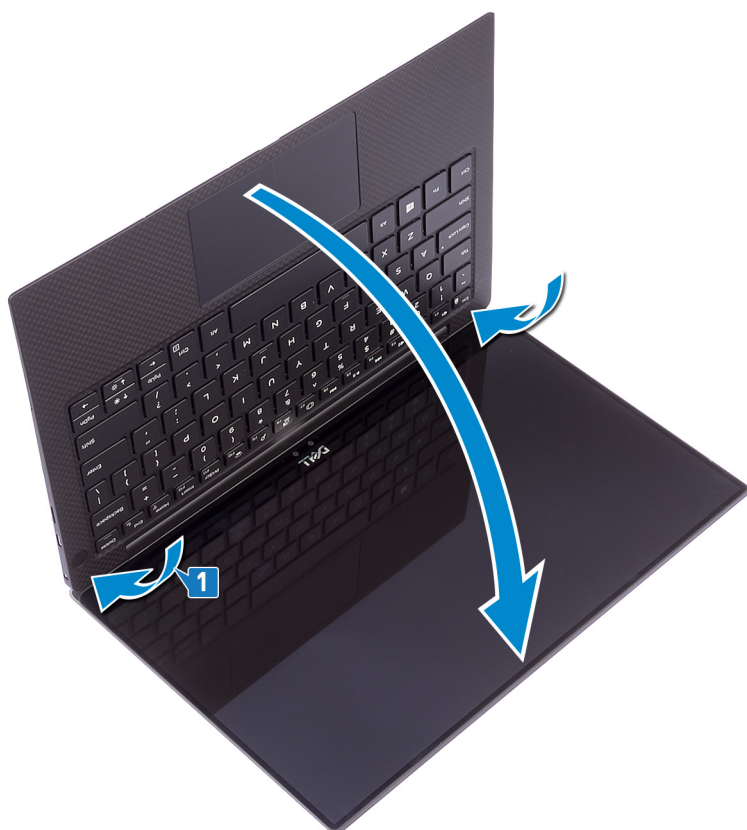

2. Using the alignment posts, press the display hinges down on the palm-rest assembly, aligning the screw holes on the display hinges with the screw holes on the palm-rest assembly.
3. Connect the antenna cables to the system board.

The following table provides the antenna cable color schemes for the wireless card supported by your computer.

Table 2. Antenna-cable color scheme

Connectors on the wireless card	Antenna-cable color
Main (white triangle)	White
Auxiliary (black triangle)	Black

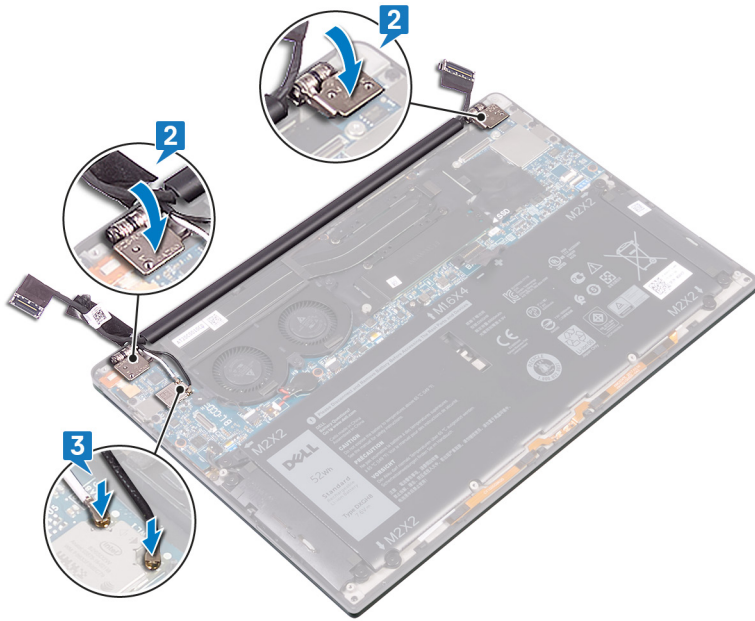

4. Replace the four screws (M2.5x4) securing the display hinges to the palm-rest assembly and connect the camera cable to the system board, adhering the tape securing the camera cable to the fans.
5. Align the screw hole on the wireless antenna and camera cable bracket to screw hole on the system board.
6. Replace the screw (M1.6x3) that secures the wireless antenna and camera cable bracket to the system board.
7. Connect the display cable to the system board.
8. Align the screw holes on the display-cable bracket with the screw holes on the system board.
9. Replace the two screws (M1.6x2.5) that secure the display-cable bracket to system board.

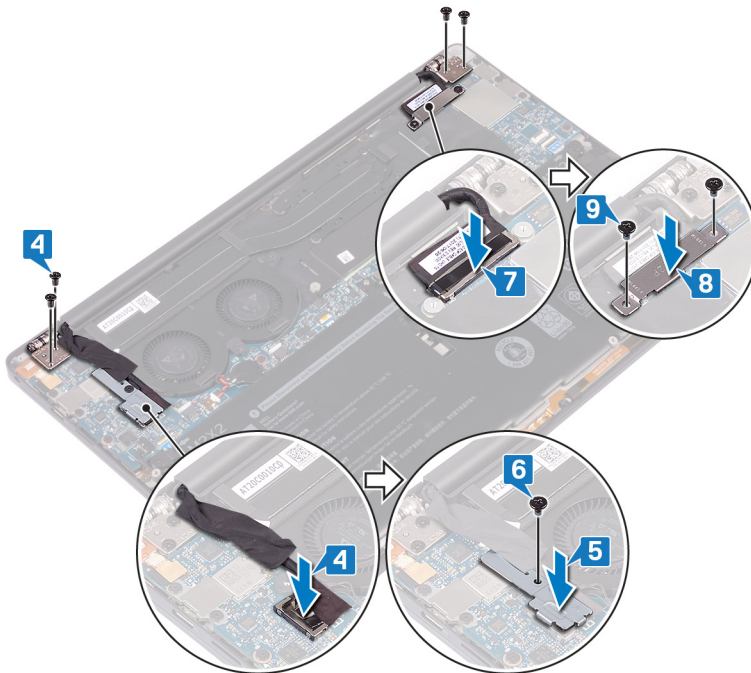

Post-requisites

1. Replace the [battery](#).
2. Replace the [base cover](#).

Removing the headset port

NOTE: Before working inside your computer, read the safety information that shipped with your computer and follow the steps in [Before working inside your computer](#). After working inside your computer, follow the instructions in [After working inside your computer](#). For more safety best practices, see the Regulatory Compliance home page at www.dell.com/regulatory_compliance.

Topics:

- [Prerequisites](#)
- [Procedure](#)

Prerequisites

1. Remove the [base cover](#).
2. Remove the [battery](#).

Procedure

1. Remove the two screws (M2.5x4) that secure the left hinge to the palm-rest assembly.

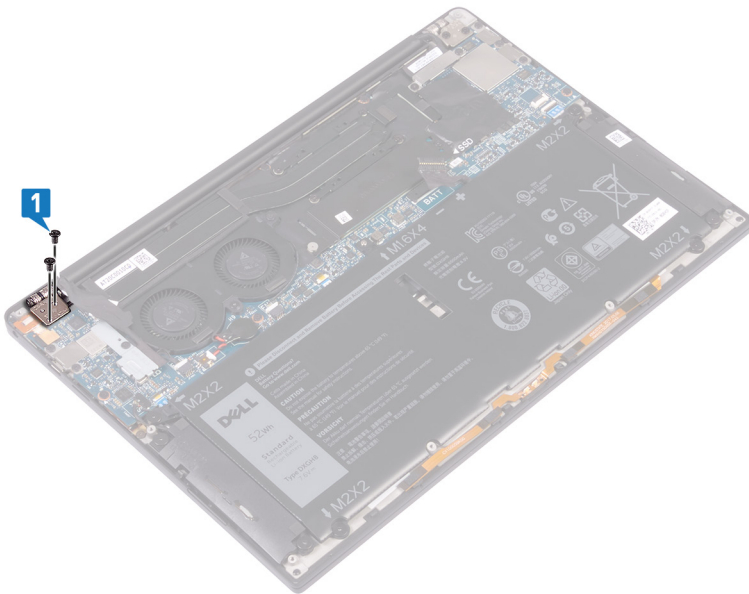

2. Place the top surface of the computer on a flat and clean surface, then open and close the computer.

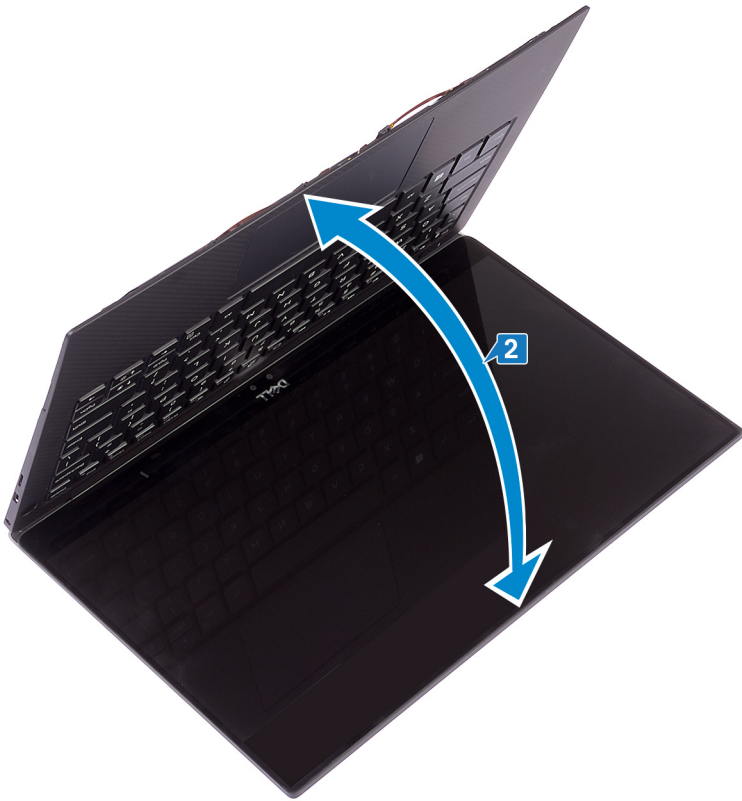

3. Disconnect the headset-port cable from the system board.
4. Remove the screw (M1.6x3) that secures the headset port to the palm-rest assembly.
5. Lift the headset port from the system board.

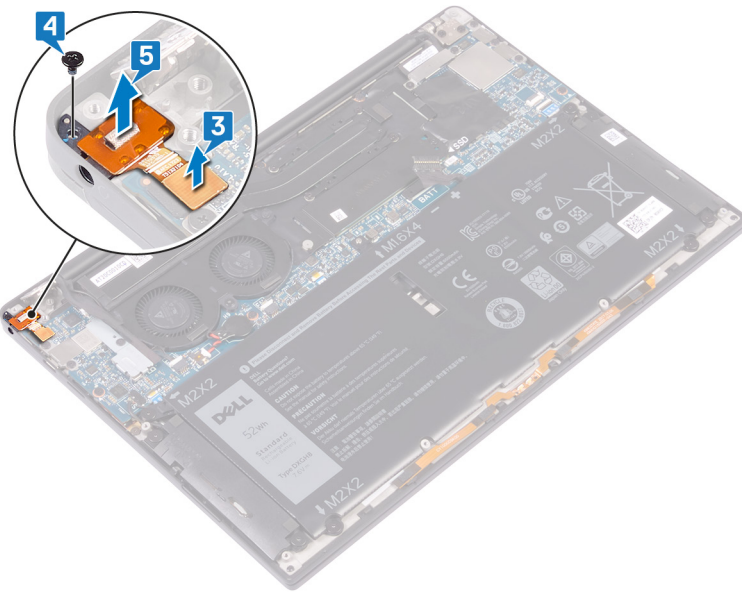

Replacing the headset port

NOTE: Before working inside your computer, read the safety information that shipped with your computer and follow the steps in [Before working inside your computer](#). After working inside your computer, follow the instructions in [After working inside your computer](#). For more safety best practices, see the Regulatory Compliance home page at www.dell.com/regulatory_compliance.

Topics:

- [Procedure](#)
- [Post-requisites](#)

Procedure

1. Place the headset port in its slot on the palm-rest assembly.
2. Replace the screw (M1.6x3) that secures the headset port to the palm-rest assembly
3. Reconnect the headset-port cable to the system board.

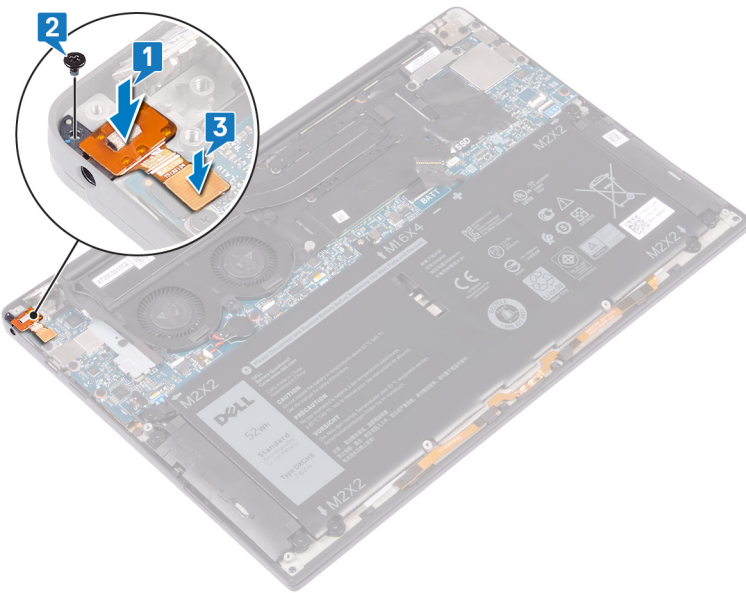

4. Using the alignment posts, press the right display hinge down to the palm-rest assembly aligning the screw holes on the display hinge to the screw holes on the palm-rest assembly.
5. Replace the two screws (M2.5x4) that secure the left hinge to the palm-rest assembly.

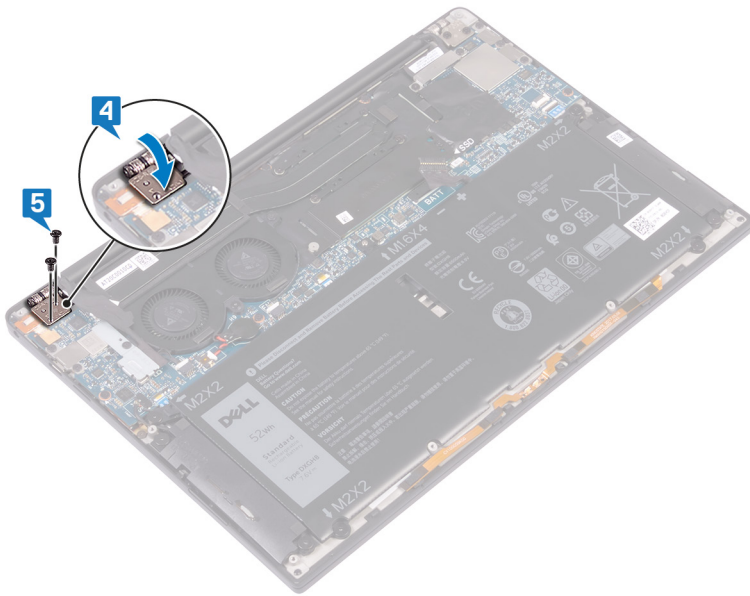

Post-requisites

1. Replace the [battery](#).
2. Replace the [base cover](#).

Removing the fans

NOTE: Before working inside your computer, read the safety information that shipped with your computer and follow the steps in [Before working inside your computer](#). After working inside your computer, follow the instructions in [After working inside your computer](#). For more safety best practices, see the Regulatory Compliance home page at www.dell.com/regulatory_compliance.

Topics:

- [Prerequisites](#)
- [Procedure](#)

Prerequisites

1. Remove the [base cover](#).
2. Remove the [battery](#).

Procedure

This procedure applies only to computers shipped with heat sink.

NOTE: If your computer is shipped with a heat-sink assembly (combined heat sink and fans), see [Removing the heat-sink assembly](#).

1. Remove the screw (M1.6x3) that secures the wireless antenna and camera-cable bracket to the system board.
2. Lift the wireless antenna and camera-cable bracket from the system board.
3. Disconnect and lift the camera cable from the system board, peeling off the tape securing the camera cable to the fans.

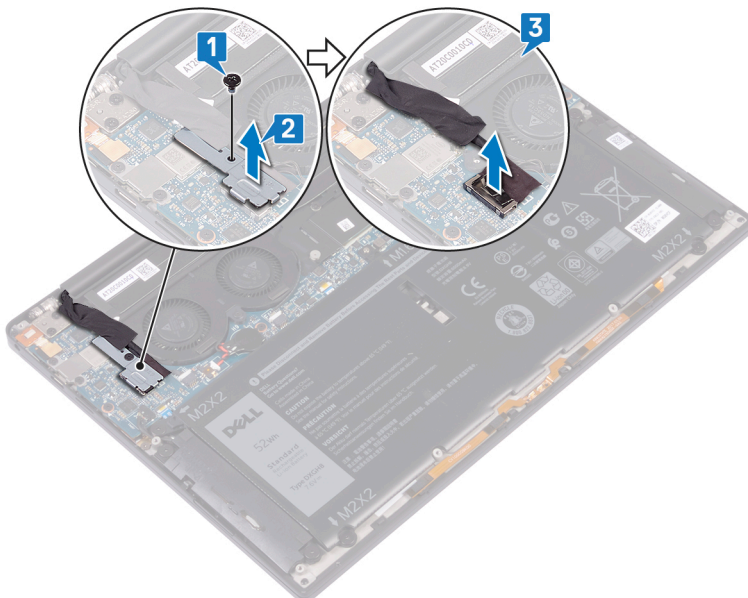

4. Disconnect the right-fan cable from the system board.
5. Disconnect the left-fan cable from the system board.
6. Remove the two screws (M1.6x3) that secure the left and the right fan to the system board.
7. Lift the left and the right fans along with their cables off the system board.

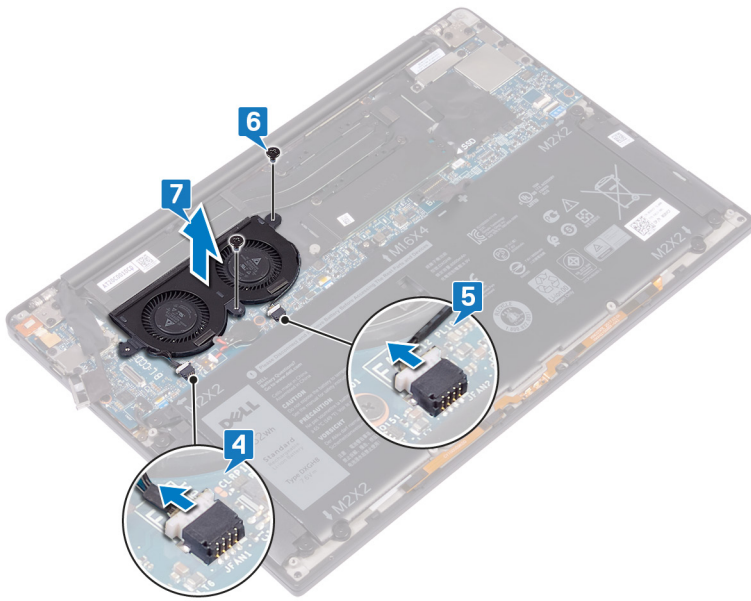

Replacing the fans

NOTE: Before working inside your computer, read the safety information that shipped with your computer and follow the steps in [Before working inside your computer](#). After working inside your computer, follow the instructions in [After working inside your computer](#). For more safety best practices, see the Regulatory Compliance home page at www.dell.com/regulatory_compliance.

Topics:

- [Procedure](#)
- [Post-requisites](#)

Procedure

This procedure applies only to computers shipped with heat sink.

NOTE: If your computer is shipped with a heat-sink assembly (combined heat sink and fans), see [Replacing the heat-sink assembly](#).

1. Align the screw holes on the left and the right fans with the screw holes on the system board.
2. Replace the two screws (M1.6x3) that secure the left and the right fans to the system board.
3. Connect the left- and the right-fan cables to the system board.

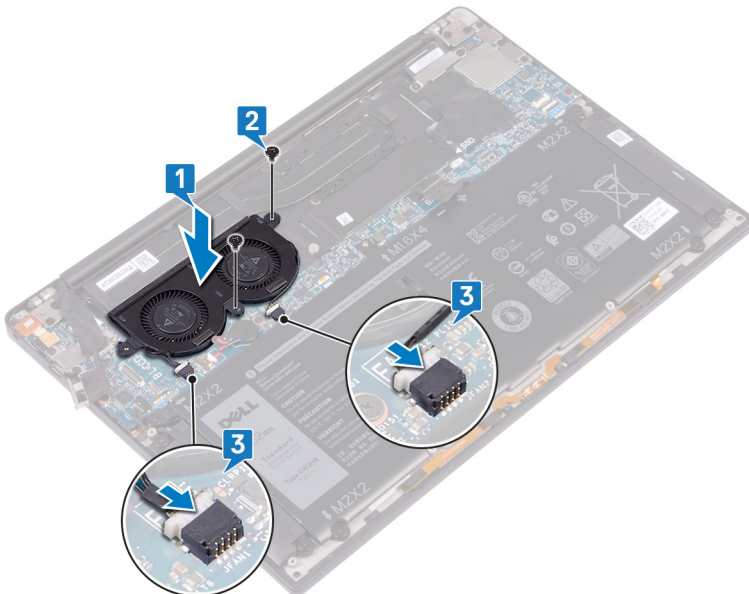

4. Connect the camera cable to the system board.
5. Align the screw hole on the wireless antenna and camera-cable bracket to the screw hole on the system board.
6. Replace the screw (M1.6x3) that secures the wireless antenna and camera-cable bracket to the system board.
7. Adhere the tape that secures the camera cable to the fans.

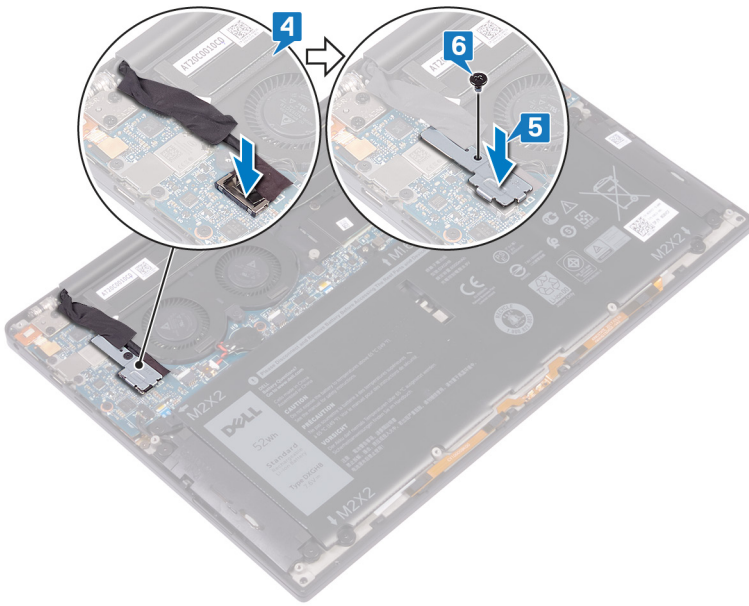

Post-requisites

1. Replace the [battery](#).
2. Replace the [base cover](#).

Removing the system board

- NOTE:** Before working inside your computer, read the safety information that shipped with your computer and follow the steps in [Before working inside your computer](#). After working inside your computer, follow the instructions in [After working inside your computer](#). For more safety best practices, see the Regulatory Compliance home page at www.dell.com/regulatory_compliance.
- NOTE:** Your computer's Service Tag is stored in the system board. You must enter the Service Tag in the BIOS setup program after you replace the system board.
- NOTE:** Replacing the system board removes any changes you have made to the BIOS using the BIOS setup program. You must make the appropriate changes again after you replace the system board.
- NOTE:** Before disconnecting the cables from the system board, note the location of the connectors so that you can reconnect the cables correctly after you replace the system board.

Topics:

- [Prerequisites](#)
- [Procedure](#)

Prerequisites

1. Remove the [base cover](#).
2. Remove the [battery](#).
3. Remove the [solid-state drive](#).
4. Remove the [heat sink](#).
5. Remove the [fans](#).

Procedure

1. Disconnect the antenna cables from the system board.
2. Disconnect the headset-port cable from the system board.
3. Disconnect the speaker cable from the system board.
4. Open the latch and disconnect the fingerprint-reader cable from the system board. Skip this step if the power button does not have the fingerprint reader.
5. Open the latch and disconnect the touchpad cable from the system board.
6. Open the latch and disconnect the keyboard-controller cable from the system board.
7. Remove the two screws (M1.6x2.5) that secure the display-cable bracket to the system board.
8. Lift the display-cable bracket from the system board.
9. Using the pull tab, disconnect the display cable from the system board.

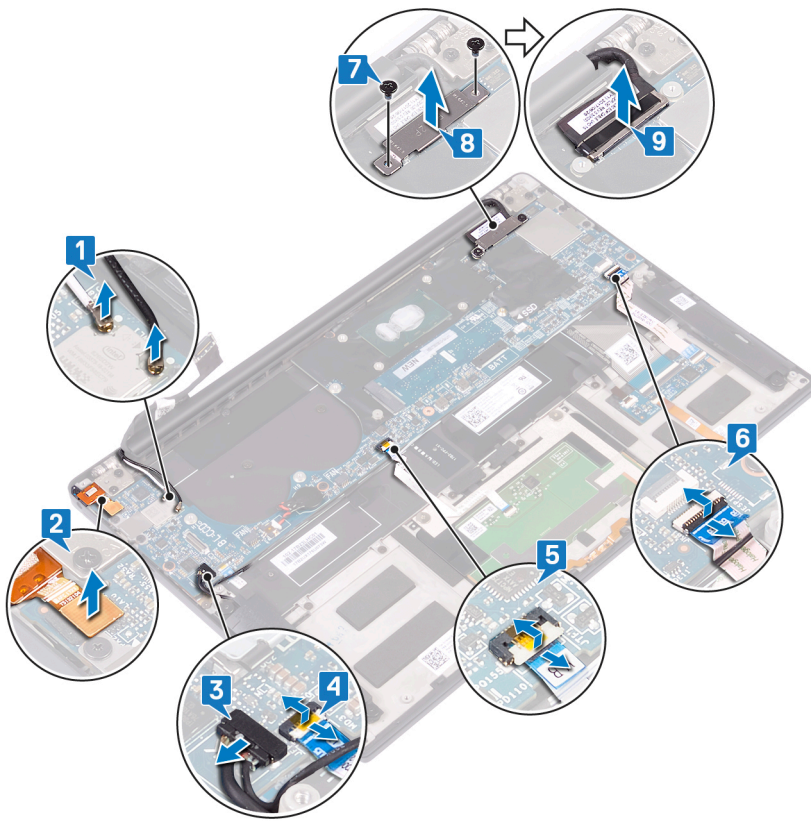

10. Remove the 10 screws (M1.6x2.5) securing the system board to the palm-rest assembly.
11. Lift the system board from the palm-rest assembly.

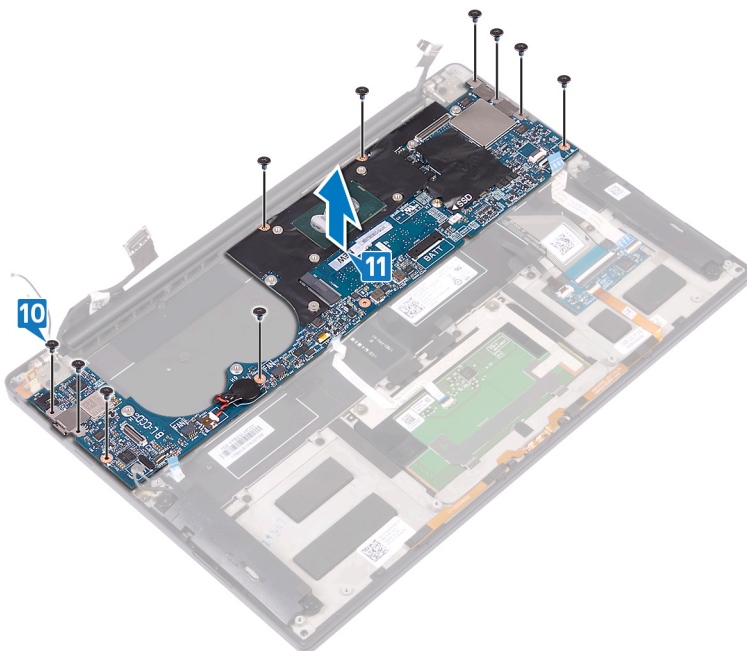

Replacing the system board

- NOTE:** Before working inside your computer, read the safety information that shipped with your computer and follow the steps in [Before working inside your computer](#). After working inside your computer, follow the instructions in [After working inside your computer](#). For more safety best practices, see the Regulatory Compliance home page at www.dell.com/regulatory_compliance.
- NOTE:** Your computer's Service Tag is stored in the system board. You must enter the Service Tag in the BIOS setup program after you replace the system board.
- NOTE:** Replacing the system board removes any changes you have made to the BIOS using the BIOS setup program. You must make the appropriate changes again after you replace the system board.

Topics:

- [Procedure](#)
- [Post-requisites](#)
- [Entering the Service Tag in the BIOS setup program](#)

Procedure

1. Using the alignment posts, place the system board on the palm-rest assembly and align the screw holes on the system board with the screw holes on the palm-rest assembly.
2. Replace the 10 screws (M1.6x2.5) that secure the system board to the palm-rest assembly.

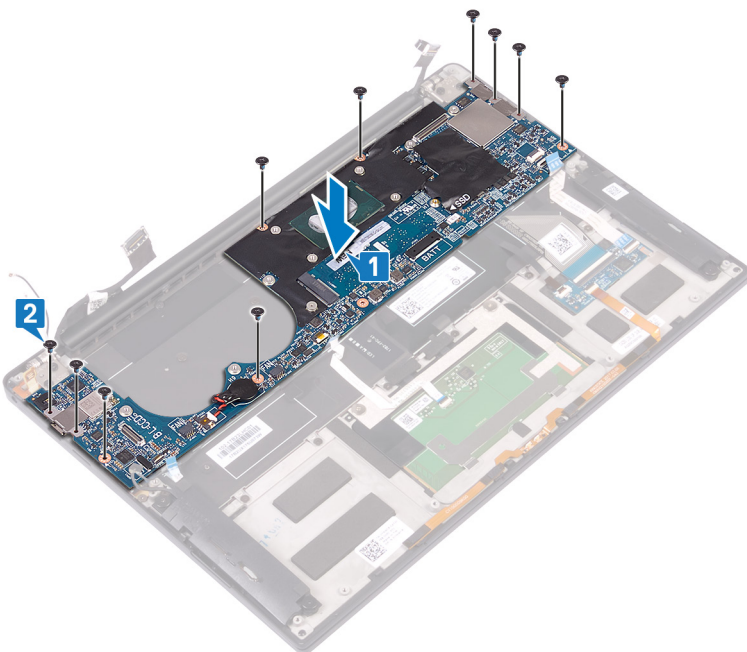

3. Connect the display cable to the system board.
4. Align and place the display cable bracket on the system board.
5. Replace the two screws (M1.6x2.5) that secure the display cable bracket to the system board.
6. Connect the keyboard-controller cable to the system board and close the latch to secure the cable.
7. Connect the touchpad cable to the system board and close the latch to secure the cable.

8. Connect the fingerprint-reader cable to the system board and close the latch to secure the cable. Skip this step if the power button does not have the fingerprint reader.
9. Connect the speaker cable to the system board.
10. Connect the headset-port cable to the system board.
11. Connect the antenna cables to the system board.

The following table provides the antenna cable color schemes for the wireless card supported by your computer.

Table 3. Antenna-cable color scheme

Connectors on the wireless card	Antenna-cable color
Main (white triangle)	White
Auxiliary (black triangle)	Black

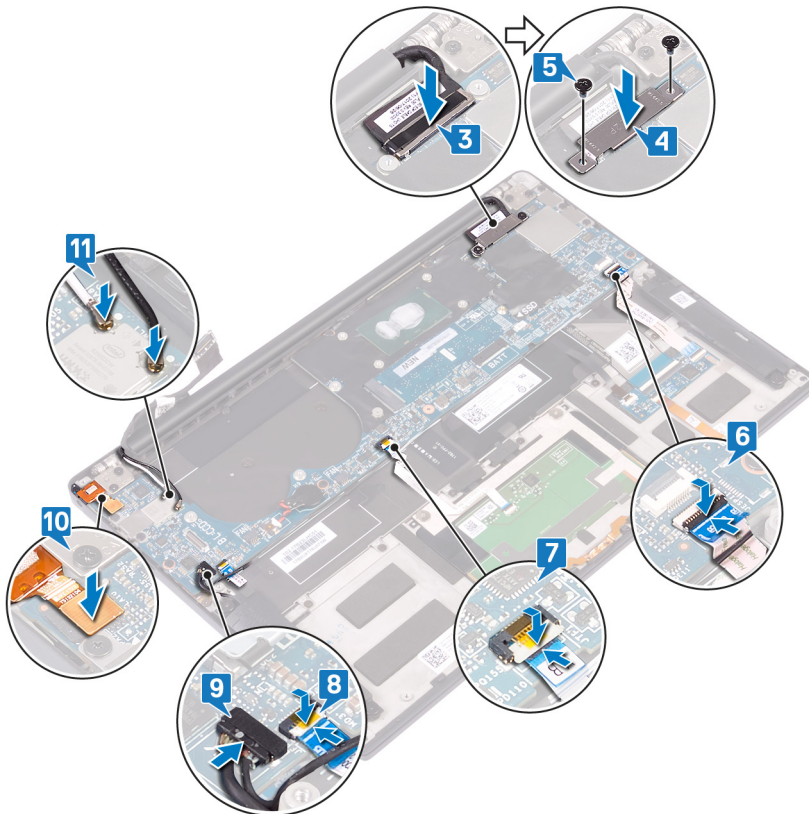

Post-requisites

1. Replace the [fans](#).
2. Replace the [heat sink](#).
3. Replace the [solid-state drive](#).
4. Replace the [battery](#).
5. Replace the [base cover](#).

Entering the Service Tag in the BIOS setup program

1. Turn on or restart your computer.
2. Press F2 when the Dell logo is displayed to enter the BIOS setup program.
3. Navigate to the **Main** tab and enter the Service Tag in the **Service Tag Input** field.

 **NOTE:** Service tag is the alphanumeric identifier located at the back side of your computer.

Removing the power button with optional fingerprint reader

NOTE: Before working inside your computer, read the safety information that shipped with your computer and follow the steps in [Before working inside your computer](#). After working inside your computer, follow the instructions in [After working inside your computer](#). For more safety best practices, see the Regulatory Compliance home page at www.dell.com/regulatory_compliance.

Topics:

- [Prerequisites](#)
- [Procedure](#)

Prerequisites

1. Remove the [base cover](#).
2. Remove the [battery](#).
3. Remove the [solid-state drive](#).
4. Remove the [fans](#).
5. Remove the [system board](#).

Procedure

NOTE: If the power button does not include the fingerprint reader, perform only steps 1 and 3. Complete all steps if the power button includes the fingerprint reader.

1. Remove the two screws (M1.4x1.7) that secure the power button to the palm-rest assembly.
2. Remove the screw (M1.6x1.5) that secures the fingerprint-reader board to the palm-rest assembly.
3. Lift the power button from the palm-rest assembly.
4. Peel and lift the power button cable from the keyboard.
5. Lift the fingerprint-reader board from the palm-rest assembly.

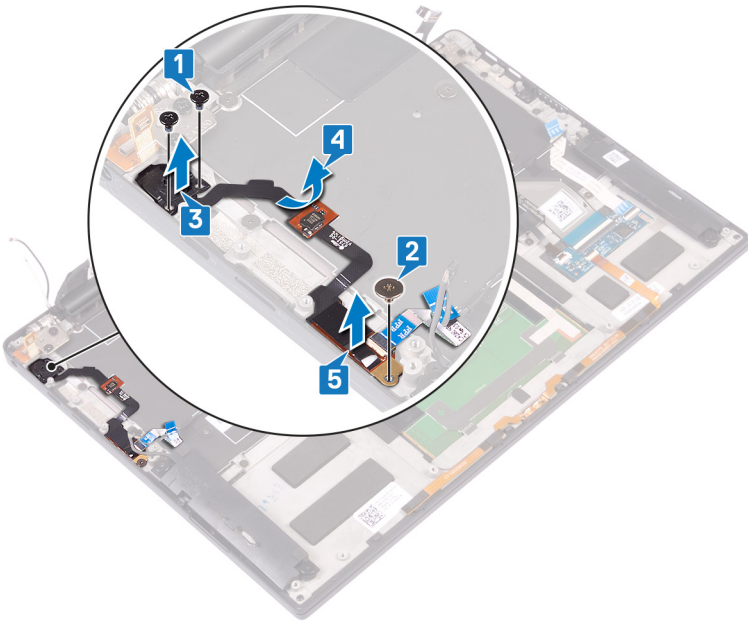

Replacing the power button with optional fingerprint reader

NOTE: Before working inside your computer, read the safety information that shipped with your computer and follow the steps in [Before working inside your computer](#). After working inside your computer, follow the instructions in [After working inside your computer](#). For more safety best practices, see the Regulatory Compliance home page at www.dell.com/regulatory_compliance.

Topics:

- [Procedure](#)
- [Post-requisites](#)

Procedure

NOTE: If the power button does not include the fingerprint reader, perform only steps 2 and 3. Complete all steps if the power button includes the fingerprint reader.

1. Place the fingerprint-reader board into its slot on the palm-rest assembly.
2. Place the power button into its slot on the palm-rest assembly.
3. Pressing down on the power button, replace the two screws (M1.4x1.7) that secure the power button to the palm-rest assembly.
4. Adhere the power button cable to the keyboard.
5. Replace the screw (M1.6x1.5) that secures the fingerprint-reader board to the palm-rest assembly.

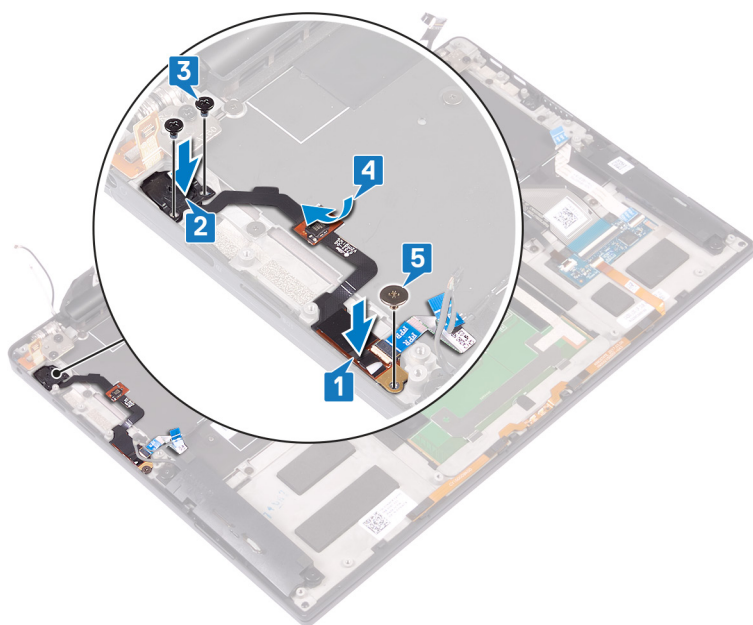

Post-requisites

1. Replace the [system board](#).
2. Replace the [fans](#).
3. Replace the [solid-state drive](#).

4. Replace the [battery](#).
5. Replace the [base cover](#).

Removing the keyboard

NOTE: Before working inside your computer, read the safety information that shipped with your computer and follow the steps in [Before working inside your computer](#). After working inside your computer, follow the instructions in [After working inside your computer](#). For more safety best practices, see the Regulatory Compliance home page at www.dell.com/regulatory_compliance.

Topics:

- [Prerequisites](#)
- [Procedure](#)

Prerequisites

1. Remove the [base cover](#).
2. Remove the [battery](#).
3. Remove the [solid-state drive](#).
4. Remove the [fans](#).
5. Remove the [system board](#).
6. Remove the [power button with optional fingerprint reader](#).

Procedure

1. Open the latch and disconnect the keyboard-backlight cable from the keyboard-controller board.
2. Open the latch and disconnect the keyboard-controller board cable from the keyboard-controller board.
3. Remove the 29 screws (M1.6x1.5) that secure the keyboard to the palm-rest assembly.
4. Peel the keyboard-backlight cable and the keyboard-controller board cable to the keyboard.
5. Slide the keyboard out from under the hinges off the palm-rest assembly.

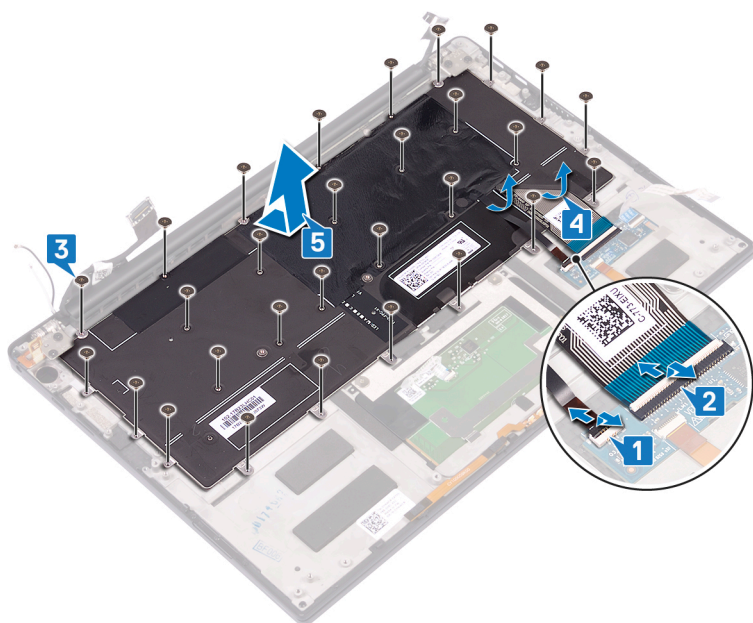

Replacing the keyboard

NOTE: Before working inside your computer, read the safety information that shipped with your computer and follow the steps in [Before working inside your computer](#). After working inside your computer, follow the instructions in [After working inside your computer](#). For more safety best practices, see the Regulatory Compliance home page at www.dell.com/regulatory_compliance.

Topics:

- [Procedure](#)
- [Post-requisites](#)

Procedure

1. Adhere the thermal pad and foil sticker that is shipped with the keyboard onto the replacement keyboard.
2. Align the screw holes on the keyboard with the screw holes on the palm-rest assembly and slide the keyboard under the display hinges into the palm rest assembly.
3. Replace the 29 screws (M1.6x1.5) that secure the keyboard to the palm-rest assembly.
4. Adhere the keyboard-backlight cable and the keyboard-controller board cable to the keyboard.
5. Slide the keyboard-backlight cable into the keyboard-controls board and close the latch to secure the cable.
6. Slide the keyboard-controls board cable into the keyboard-controls board and close the latch to secure the cable.

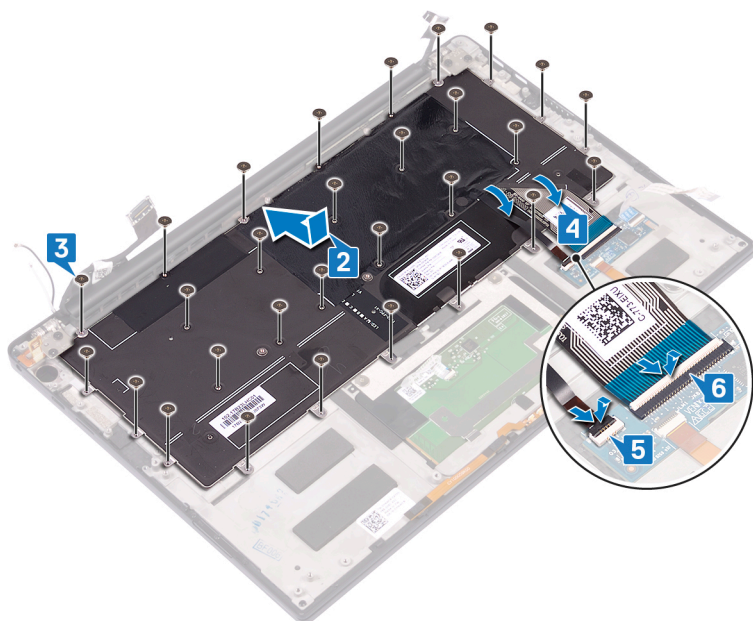

Post-requisites

1. Replace the [power button with optional fingerprint reader](#).
2. Replace the [system board](#).
3. Replace the [fans](#).
4. Replace the [solid-state drive](#).
5. Replace the [battery](#).
6. Replace the [base cover](#).

Removing the palm-rest assembly

NOTE: Before working inside your computer, read the safety information that shipped with your computer and follow the steps in [Before working inside your computer](#). After working inside your computer, follow the instructions in [After working inside your computer](#). For more safety best practices, see the Regulatory Compliance home page at www.dell.com/regulatory_compliance.

Topics:

- [Prerequisites](#)
- [Procedure](#)

Prerequisites

1. Remove the [base cover](#).
2. Remove the [battery](#).
3. Remove the [speakers](#).
4. Remove the [display assembly](#).
5. Remove the [headset port](#).
6. Remove the [fans](#).
7. Remove the [system board](#).
8. Remove the [power button with optional fingerprint reader](#).
9. Remove the [keyboard](#).

Procedure

After performing all the pre-requisites, we are left with the palm-rest assembly.



Replacing the palm-rest assembly

NOTE: Before working inside your computer, read the safety information that shipped with your computer and follow the steps in [Before working inside your computer](#). After working inside your computer, follow the instructions in [After working inside your computer](#). For more safety best practices, see the Regulatory Compliance home page at www.dell.com/regulatory_compliance.

Topics:

- [Procedure](#)
- [Post-requisites](#)

Procedure

Place the palm-rest assembly face down on a clean and flat surface.



Post-requisites

1. Replace the [keyboard](#).
2. Replace the [power button with optional fingerprint reader](#).
3. Replace the [system board](#).
4. Replace the [fans](#).
5. Replace the [headset port](#).
6. Replace the [display assembly](#).
7. Replace the [speakers](#).
8. Replace the [battery](#).
9. Replace the [base cover](#).

Device drivers

Intel Chipset Software Installation Utility

In the Device Manager, check if the chipset driver is installed.

Install the Intel chipset updates from www.dell.com/support.

Video drivers

In the Device Manager, check if the video driver is installed.

Install the video driver update from www.dell.com/support.

Intel Serial IO driver

In the Device Manager, check if the Intel Serial IO driver is installed.

Install the driver updates from www.dell.com/support.

Intel Trusted Execution Engine Interface

In the Device Manager, check if the Intel Trusted Execution Engine Interface driver is installed.

Install the driver update from www.dell.com/support.

Intel Virtual Button driver

In the Device Manager, check if the Intel Virtual Button driver is installed.

Install the driver updates from www.dell.com/support.

Wireless and Bluetooth drivers

In the Device Manager, check if the network card driver is installed.

Install the driver updates from www.dell.com/support.

In the Device Manager, check if the Bluetooth driver is installed.

Install the driver updates from www.dell.com/support.

System setup

NOTE: Depending on the computer and its installed devices, the items listed in this section may or may not be displayed.

Topics:

- System setup
- Entering BIOS setup program
- Navigation keys
- Boot Sequence
- System setup options
- Clearing CMOS settings
- Clearing BIOS (System Setup) and System passwords

System setup

CAUTION: Unless you are an expert computer user, do not change the settings in the BIOS Setup program. Certain changes can make your computer work incorrectly.

NOTE: Before you change BIOS Setup program, it is recommended that you write down the BIOS Setup program screen information for future reference.

Use the BIOS Setup program for the following purposes:

- Get information about the hardware installed in your computer, such as the amount of RAM and the size of the hard drive.
- Change the system configuration information.
- Set or change a user-selectable option, such as the user password, type of hard drive installed, and enabling or disabling base devices.

Entering BIOS setup program

1. Turn on (or restart) your computer.
2. During POST, when the DELL logo is displayed, watch for the F2 prompt to appear, and then press F2 immediately.

NOTE: The F2 prompt indicates that the keyboard is initialized. This prompt can appear very quickly, so you must watch for it, and then press F2. If you press F2 before the F2 prompt, this keystroke is lost. If you wait too long and the operating system logo appears, continue to wait until you see the desktop. Then, turn off your computer and try again.

Navigation keys

NOTE: For most of the System Setup options, changes that you make are recorded but do not take effect until you restart the system.

Keys	Navigation
Up arrow	Moves to the previous field.
Down arrow	Moves to the next field.
Enter	Selects a value in the selected field (if applicable) or follow the link in the field.
Spacebar	Expands or collapses a drop-down list, if applicable.
Tab	Moves to the next focus area.

Keys

Esc

Navigation

Moves to the previous page until you view the main screen. Pressing Esc in the main screen displays a message that prompts you to save any unsaved changes and restarts the system.

Boot Sequence

Boot Sequence allows you to bypass the System Setup–defined boot device order and boot directly to a specific device (for example: optical drive or hard drive). During the Power-on Self Test (POST), when the Dell logo appears, you can:

- Access System Setup by pressing F2 key
- Bring up the one-time boot menu by pressing F12 key

The one-time boot menu displays the devices that you can boot from including the diagnostic option. The boot menu options are:

- Removable Drive (if available)
- STXXXX Drive (if available)

NOTE: XXX denotes the SATA drive number.

- Optical Drive (if available)
- SATA Hard Drive (if available)
- Diagnostics

NOTE: Choosing Diagnostics, will display the ePSA diagnostics screen.

The boot sequence screen also displays the option to access the System Setup screen.

System setup options

NOTE: Depending on this computer and its installed devices, the items listed in this section may or may not appear.

Table 4. System setup options—System information menu

General-System Information

System Information	
BIOS Version	Displays the BIOS version number.
Service Tag	Displays the Service Tag of the computer.
Asset Tag	Displays the Asset Tag of the computer.
Ownership Tag	Displays the ownership tag of the computer.
Manufacture Date	Displays the manufacture date of the computer.
Ownership Date	Displays the ownership date of the computer.
Express Service Code	Displays the express service code of the computer.
Memory Information	
Memory Installed	Displays the total computer memory installed.
Memory Available	Displays the total computer memory available.
Memory Speed	Displays the memory speed.
Memory Channel Mode	Displays single or dual channel mode.
Memory Technology	Displays the technology used for the memory.
DIMM A Size	Displays the DIMM A memory size.
DIMM B Size	Displays the DIMM B memory size.
Processor Information	
Processor Type	Displays the processor type.

General-System Information

Core Count	Displays the number of cores on the processor.
Processor ID	Displays the processor identification code.
Current Clock Speed	Displays the current processor clock speed.
Minimum Clock Speed	Displays the minimum processor clock speed.
Maximum Clock Speed	Displays the maximum processor clock speed.
Processor L2 Cache	Displays the processor L2 Cache size.
Processor L3 Cache	Displays the processor L3 Cache size.
HT Capable	Displays whether the processor is HyperThreading (HT) capable.
64-Bit Technology	Displays whether 64-bit technology is used.
Device Information	
M.2 SATA	Displays the M.2 SATA SSD device information of the computer.
M.2 PCIe SSD-0	Displays the M.2 PCIe SSD information of the computer.
Video Controller	Displays the video controller type of the computer.
dGPU Video Controller	Displays the discrete graphics information of the computer.
Video BIOS Version	Displays the video BIOS version of the computer.
Video Memory	Displays the video memory information of the computer.
Panel Type	Displays the Panel Type of the computer.
Native Resolution	Displays the native resolution of the computer.
Audio Controller	Displays the audio controller information of the computer.
Wi-Fi Device	Displays the wireless device information of the computer.
Bluetooth Device	Displays the bluetooth device information of the computer.
Battery Information	Displays the battery health information.
Boot Sequence	
Boot Sequence	Displays the boot sequence.
Boot List Option	Displays the available boot options.
Advanced Boot Options	
Enable Legacy Option ROMs	Enable or disable the Legacy Option ROMs.
Enable Attempt Legacy Boot	Enable or disable Legacy Boot.
UEFI Boot Path Security	Enable or disable the system to prompt the user to enter the Admin password when booting a UEFI boot path from the F12 boot menu.
Date/Time	Displays the current date in MM/DD/YY format and current time in HH:MM:SS AM/PM format.

Table 5. System setup options—System Configuration menu

System Configuration

SATA Operation	Configure operating mode of the integrated SATA hard drive controller.
Drives	Enable or disable various drives on board.
SMART Reporting	Enable or disable SMART Reporting during system startup.
USB Configuration	

System Configuration

Enable USB Boot Support	Enable or disable booting from USB mass storage devices such as external hard drive, optical drive, and USB drive.
Enable External USB Port	Enable or disable booting from USB mass storage devices connected to external USB port.
Audio	Enable or disable the integrated audio controller.
Keyboard Illumination	Enables you to choose the operating mode of the keyboard illumination feature.
Keyboard Backlight with AC Power	When the backlight is enabled, if Fn+F10 keys are pressed to disable the backlight, the backlight stays off regardless of AC state.
Miscellaneous Devices	Enable or disable various onboard devices.
Enable Camera	Enable or disable the camera.

Table 6. System setup options—Video menu

Video

LCD Brightness	Set the panel brightness independently for Battery and AC power.
-----------------------	--

Table 7. System setup options—Security menu

Security

Admin Password	Set, change, or delete the administrator password.
System Password	Set, change, or delete the system password.
Strong Password	Enable or disable strong passwords.
Password Configuration	Control the minimum and maximum number of characters allowed for Admin and System passwords.
Password Bypass	Bypass the System (Boot) Password and the internal HDD password prompts during a system restart.
Password Change	Enable or disable changes to the System and Hard Disk passwords when an administrator password is set.
Non-Admin Setup Changes	Determines whether changes to the setup option are permitted when an administrator password is set.
UEFI Capsule Firmware Updates	Enable or disable BIOS updates through UEFI capsule update packages.
PTT Security	Enable or disable Platform Trust Technology (PTT) visibility to the operating system.
Computrace(R)	Enable or disable the BIOS module interface of the optional Computrace(R) Service from Absolute Software.
CPU XD Support	Enable or disable the Execute Disable mode of the Processor.
Admin Setup Lockout	Enable to prevent users from entering Setup when an Admin Password is set.
Master Password Lockout	Disables the master password support. Hard Disk passwords need to be cleared before changing the setting.

Table 8. System setup options—Secure Boot menu

Secure Boot

Secure Boot Enable	Enable or disable the secure boot feature.
Expert Key Management	
Expert Key Management	Enable or disable Expert Key Management.
Custom Mode Key Management	Select the custom values for expert key management.

Table 9. System setup options—Intel Software Guard Extensions menu

Intel Software Guard Extensions	
Intel SGX Enable	Enable or disable Intel Software Guard Extensions.
Enclave Memory Size	Set the Intel Software Guard Extensions Enclave Reserve Memory Size.
Performance	
Multi Core Support	Enable multiple cores. Default: Enabled.
Intel SpeedStep	Enable or disable Intel Speedstep Technology. Default: Enabled. i NOTE: If enabled, the processor clock speed and core voltage are adjusted dynamically based on the processor load.
C-States Control	Enable or disable additional processor sleep states. Default: Enabled.
Intel TurboBoost	Enable or disable Intel TurboBoost mode of the processor. Default: Enabled.
HyperThread control	Enable or disable HyperThreading in the processor. Default: Enabled.
Power Management	
AC Behavior	Enables the system to turn on automatically, when AC power is supplied.
Enable Intel Speed Shift Technology	Enable or disable Intel Speed Shift Technology.
Auto On Time	Enable to set the computer to turn on automatically every day or on a preselected date and time. This option can be configured only if the Auto On Time is set to Everyday, Weekdays or Selected Days. Default: Disabled.
USB Wake Support	Enable the USB devices to wake the computer from Standby.
Peak Shift	Enable or disable the minimal usage of AC power at times of peak demand.
Primary Battery Charge Configuration	Set the primary battery charge settings with a preselected custom charge start and stop. Default: Adaptive.
POST Behavior	
Adapter Warnings	Enable adapter warnings. Default: Enabled.
Fn Lock Options	Enable or disable the Fn lock mode.
Fastboot	Enable to set the speed of the boot process. Default: Thorough.
Extend BIOS POST Time	Configure additional pre-boot delay.
Full Screen Logo	Enable or disable to display full screen logo.
Warnings and Errors	Configure the Warnings and Errors options which causes the boot process to pause when warnings or errors are detected, rather than stop, prompt and wait for user input.
Prompt on Warnings and Errors	Enable or disable Prompt on Warnings and Errors

Intel Software Guard Extensions

Continue on Warnings	Enable or disable Continue on Warnings
Continue on Warnings and Errors	Enable or disable Continue on Warnings and Errors

Table 10. System setup options—Virtualization Support menu

Virtualization Support

Virtualization	Specify whether a Virtual Machine Monitor (VMM) can utilize the additional hardware capabilities provided by Intel Virtualization Technology.
VT for Direct I/O	Specify whether a Virtual Machine Monitor (VMM) can utilize the additional hardware capabilities provided by Intel Virtualization Technology for Direct I/O.

Table 11. System setup options—Wireless menu

Wireless

Wireless Switch	Determine which wireless devices can be controlled by the Wireless Switch.
Wireless Device Enable	Enable or disable internal wireless devices.

Table 12. System setup options—Maintenance menu

Maintenance

Service Tag	Display the system's Service Tag.
Asset Tag	Create a system Asset Tag.
BIOS Downgrade	Control flashing of the system firmware to previous revisions.
BIOS Recovery	Enable the user to recover from certain corrupted BIOS conditions from a recovery file on the user primary hard drive or an external USB key.

Table 13. System setup options—System Logs menu

System Logs

BIOS Events	Display BIOS events.
Thermal Events	Display Thermal events.
Power Events	Display Power events.

Table 14. System setup options—SupportAssist System Resolution menu

SupportAssist System Resolution

Auto OS Recovery Threshold	Control the automatic boot flow for SupportAssist System Resolution Console and for Dell OS Recovery tool.
SupportAssist OS Recovery	Enable or disable the boot flow for SupportAssist OS Recovery tool in the even of certain system errors.

Clearing CMOS settings

 **CAUTION:** Clearing CMOS settings will reset the BIOS settings on your computer.

1. Remove the [base cover](#).
2. Disconnect the battery cable from the system board.
3. Remove the [coin-cell battery](#).
4. Wait for one minute.
5. Replace the [coin-cell battery](#).
6. Connect the battery cable to the system board.
7. Replace the [base cover](#).

Clearing BIOS (System Setup) and System passwords

To clear the system or BIOS passwords, contact Dell technical support as described at www.dell.com/contactdell.

NOTE: For information on how to reset Windows or application passwords, refer to the documentation accompanying Windows or your application.

Troubleshooting

Enhanced Pre-Boot System Assessment (ePSA) diagnostics

The ePSA diagnostics (also known as system diagnostics) performs a complete check of your hardware. The ePSA is embedded with the BIOS and is launched by the BIOS internally. The embedded system diagnostics provides a set of options for particular devices or device groups allowing you to:

- Run tests automatically or in an interactive mode
- Repeat tests
- Display or save test results
- Run thorough tests to introduce additional test options to provide extra information about the failed device(s)
- View status messages that inform you if tests are completed successfully
- View error messages that inform you of problems encountered during testing

NOTE: Some tests for specific devices require user interaction. Always ensure that you are present at the computer terminal when the diagnostic tests are performed.

For more information, see [Dell ePSA Diagnostic 3.0](#).

Running the ePSA diagnostics

1. Turn on your computer.
2. As the computer boots, press the F12 key as the Dell logo appears.
3. On the boot menu screen, select the **Diagnostics** option.
4. Click the arrow at the bottom left corner. Diagnostics front page is displayed.
5. Click the arrow in the lower-right corner to go to the page listing. The items detected are listed.
6. To run a diagnostic test on a specific device, press Esc and click **Yes** to stop the diagnostic test.
7. Select the device from the left pane and click **Run Tests**.
8. If there are any issues, error codes are displayed. Note the error code and validation number and contact Dell.

System diagnostic lights

Battery-status light

Indicates the power and battery-charge status.

Solid white — Power adapter is connected and the battery has more than 5 percent charge.

Amber — Computer is running on battery and the battery has less than 5 percent charge.

Off

- Power adapter is connected and the battery is fully charged.
- Computer is running on battery and the battery has more than 5 percent charge.
- Computer is in sleep state, hibernation, or turned off.

The power and battery-status light blinks amber along with beep codes indicating failures.

For example, the power and battery-status light blinks amber two times followed by a pause, and then blinks white three times followed by a pause. This 2,3 pattern continues until the computer is turned off indicating no memory or RAM is detected.

The following table shows different power and battery-status light patterns and associated problems.

Table 15. LED codes

Diagnostic light codes	Problem description
2,1	Processor failure
2,2	System board: BIOS or ROM (Read-Only Memory) failure
2,3	No memory or RAM (Random-Access Memory) detected
2,4	Memory or RAM (Random-Access Memory) failure
2,5	Invalid memory installed
2,6	System-board or chipset error
2,7	Display failure
3,1	Coin-cell battery failure
3,2	PCI, video card/chip failure
3,3	Recovery image not found
3,4	Recovery image found but invalid
3,5	Power-rail failure
3,6	System BIOS Flash incomplete
3,7	Management Engine (ME) error

Camera status light: Indicates whether the camera is in use.

- Solid white — Camera is in use.
- Off — Camera is not in use.

Caps Lock status light: Indicates whether Caps Lock is enabled or disabled.

- Solid white — Caps Lock enabled.
- Off — Caps Lock disabled.

Recovering the operating system

When your computer is unable to boot to the operating system even after repeated attempts, it automatically starts Dell SupportAssist OS Recovery.

Dell SupportAssist OS Recovery is a standalone tool that is preinstalled in all Dell computers installed with Windows 10 operating system. It consists of tools to diagnose and troubleshoot issues that may occur before your computer boots to the operating system. It enables you to diagnose hardware issues, repair your computer, back up your files, or restore your computer to its factory state.

You can also download it from the Dell Support website to troubleshoot and fix your computer when it fails to boot into their primary operating system due to software or hardware failures.

For more information about the Dell SupportAssist OS Recovery, see *Dell SupportAssist OS Recovery User's Guide* at www.dell.com/support.

Flashing BIOS (USB key)

1. Follow the procedure from step 1 to step 7 in "[Flashing the BIOS](#)" to download the latest BIOS setup program file.
2. Create a bootable USB drive. For more information see the knowledge base article [SLN143196](#) at www.dell.com/support.
3. Copy the BIOS setup program file to the bootable USB drive.
4. Connect the bootable USB drive to the computer that needs the BIOS update.
5. Restart the computer and press **F12** when the Dell logo is displayed on the screen.
6. Boot to the USB drive from the **One Time Boot Menu**.
7. Type the BIOS setup program filename and press **Enter**.
8. The **BIOS Update Utility** appears. Follow the instructions on the screen to complete the BIOS update.

Flashing the BIOS

You may need to flash (update) the BIOS when an update is available or when you replace the system board.

Follow these steps to flash the BIOS:

1. Turn on your computer.
2. Go to www.dell.com/support.
3. Click **Product support**, enter the Service Tag of your computer, and then click **Submit**.

 **NOTE: If you do not have the Service Tag, use the auto-detect feature or manually browse for your computer model.**

4. Click **Drivers & downloads > Find it myself**.
5. Select the operating system installed on your computer.
6. Scroll down the page and expand **BIOS**.
7. Click **Download** to download the latest version of the BIOS for your computer.
8. After the download is complete, navigate to the folder where you saved the BIOS update file.
9. Double-click the BIOS update file icon and follow the instructions on the screen.

Flea power release

Flea power is the residual static electricity that remains on the computer even after it has been powered off and the battery has been removed. The following procedure provides the instructions on how to conduct flea power release:

1. Turn off your computer.
2. Remove the [base cover](#).
3. Remove the [battery](#).
4. Press and hold the power button for 15 seconds to drain the flea power.
5. Replace the [battery](#).
6. Replace the [base cover](#).
7. Turn on your computer.

Wi-Fi power cycle

If your computer is unable to access the Internet due to Wi-Fi connectivity issues a Wi-Fi power cycle procedure may be performed. The following procedure provides the instructions on how to conduct a Wi-Fi power cycle:

 **NOTE: Some ISPs (Internet Service Providers) provide a modem/router combo device.**



1. Turn off your computer.
2. Turn off the modem.
3. Turn off the wireless router.
4. Wait for 30 seconds.
5. Turn on the wireless router.
6. Turn on the modem.
7. Turn on your computer.

Getting help and contacting Dell

Self-help resources

You can get information and help on Dell products and services using these self-help resources:

Table 16. Self-help resources

Self-help resources	Resource location
Information about Dell products and services	www.dell.com
My Dell	
Tips	
Contact Support	In Windows search, type <code>Contact Support</code> , and press Enter.
Online help for operating system	www.dell.com/support/windows www.dell.com/support/linux
Troubleshooting information, user manuals, setup instructions, product specifications, technical help blogs, drivers, software updates, and so on.	www.dell.com/support
Dell knowledge base articles for a variety of computer concerns.	<ol style="list-style-type: none"> 1. Go to www.dell.com/support. 2. Type the subject or keyword in the Search box. 3. Click Search to retrieve the related articles.
Learn and know the following information about your product: <ul style="list-style-type: none"> • Product specifications • Operating system • Setting up and using your product • Data backup • Troubleshooting and diagnostics • Factory and system restore • BIOS information 	<p>See <i>Me and My Dell</i> at www.dell.com/support/manuals.</p> <p>To locate the <i>Me and My Dell</i> relevant to your product, identify your product through one of the following:</p> <ul style="list-style-type: none"> • Select Detect Product. • Locate your product through the drop-down menu under View Products. • Enter the Service Tag number or Product ID in the search bar.

Contacting Dell

To contact Dell for sales, technical support, or customer service issues, see www.dell.com/contactdell.

 **NOTE: Availability varies by country/region and product, and some services may not be available in your country/region.**

 **NOTE: If you do not have an active internet connection, you can find contact information on your purchase invoice, packing slip, bill, or Dell product catalog.**