



IP Function Module for KVM Switches



User Manual

DS-51000-1

Product Features

- Our products adopt KVM over IP technology and make full use of existing Ethernet network to replace dependence of special cables and signal systems.
- Expedient bandwidth control can make adjustments of frame rate and code rate for video transmission to adapt to different network bandwidth, fully guarantee the transmission quality of the image.
- Based on IP connection eliminates the distance analog KVM system and other restrictions, therefore achieve flexible centralized management.
- Because digital KVM signaling is based on IP agreement, the network administrator can use client applications to access in data center or anywhere in the world using one computer to control servers and other devices. It means can be added or change any number of users and devices without any complex reconfiguration.
- Client-side soft can fully make use of IP technology to provide rich administrative control which including process sharing, server status monitor, simulate multi-platform keyboard and centralized records.
- Multiple permissions setting to meet the use and operation of different users.
- Through the video transmission and data encryption of keyboard and mouse to make sure the safety of network transports.
- BIOS level connection is no limited by operating system, and applicable to various server, PC system and operating system.
- Absolute synchronistical technologies of mouse to ensure the operating accuracy of window.
- Support remote key combination to send
- 10M\100M\1000M network transmission
- Remote resolution can reach to 1920x1080@60Hz. Support screen zoom function with arbitrary proportion.
- Base on WEB UI, convenient for customer to access under different operation system. Support remote online update.

Hardware Specifications

Product view:

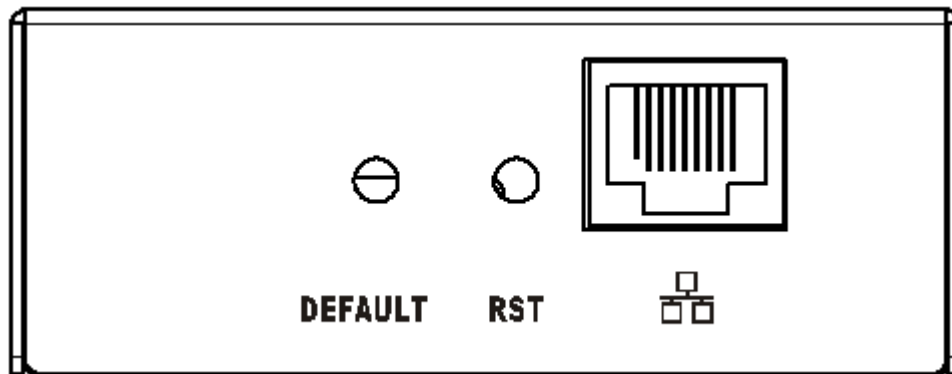

1. Reset: (RST)

Press this button to restart IP module DS-51000-1

2. Restore factory settings button: (DEFAULT)

Long press button for 5 seconds K (IP address, user name, login password) can return to the factory default settings

3. Network interface:

Can access the WAN (wide area network) or LAN (Local Area Network)

Packing List

- IP-KVM module
- CD software
- User manual

Check to make sure that all the components are present and that nothing was damaged in shipping. If you encounter a problem, contact your dealer.

Read this manual thoroughly and follow the installation and operation procedure carefully to prevent any damage to the unit, and/or any of the devices that connect to it.

Before Installation

1. Make sure that power to all the devices you will be connecting up have been turned off.
2. To prevent damage to your installation, make sure that all devices on the installation are properly grounded.

Specification

Product number	DS-51000-1
Control port	RJ45 port x 1
Reset	Network re-connect
Default	Initialize IP module default IP address, administrator name and initial password
Max resolution	1920 x 1080@60Hz
Operating temperature	0-50°C
Storage temperature	-20°C-60°C
Weight	0.5KG
Dimensions(L x W x H)	162*78*30mm

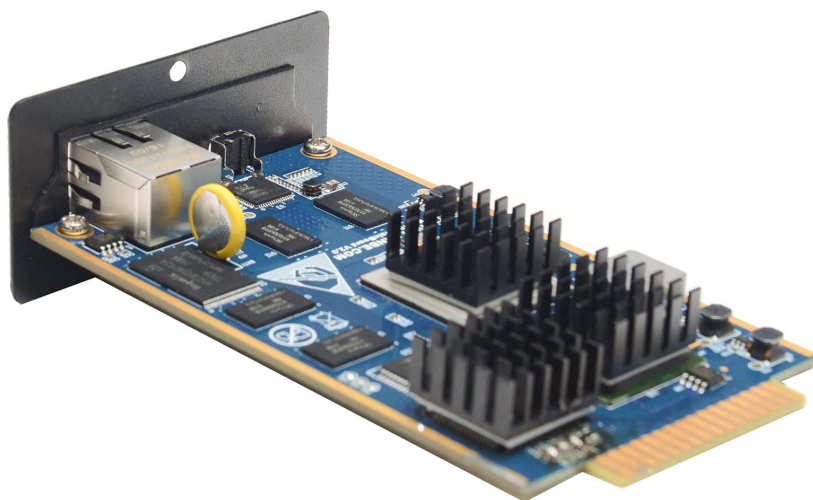

Installation

1. Remove the IP module blank of the KVM-compatible product extension, then push the IP module into the mounting cavity and install the fixing screws.
2. Using one end of crystal head of CAT5 UTP to plug RJ45 port on the switch panel.
3. Using other end of crystal head of CAT5 UTP to plug router or network interface which control PC in the LAN
4. This completes the installation, and you can turn on the power to the computers.

Installation Diagram

Expansion module installation

If you purchase the KVM switch and need to add remote control and operation, you can purchase the IP module directly that our company's products support with the dealer to upgrade and expand the equipment. The operation method is simple and fast, and can quickly improve the ability of KVM integrated management application.

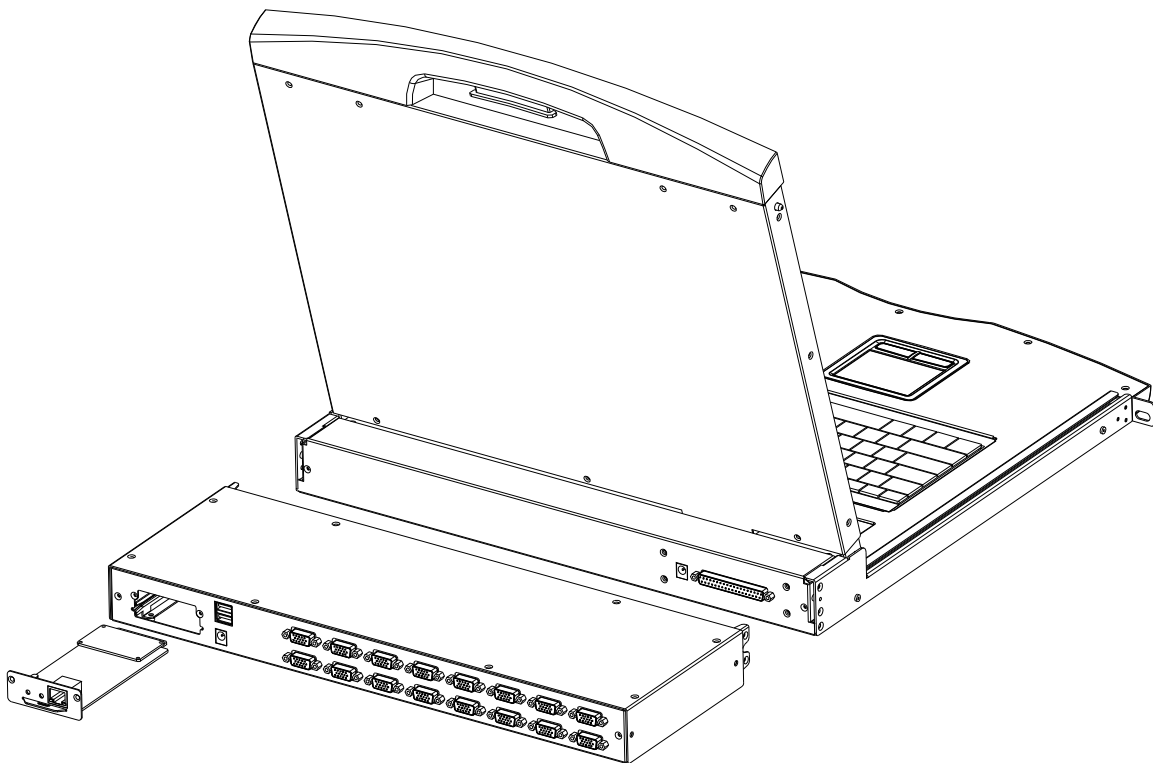

1. Locate the rear of the unit and install the outer bracket of the expansion slot. You need to prepare a screwdriver as a tool for disassembly and installation.

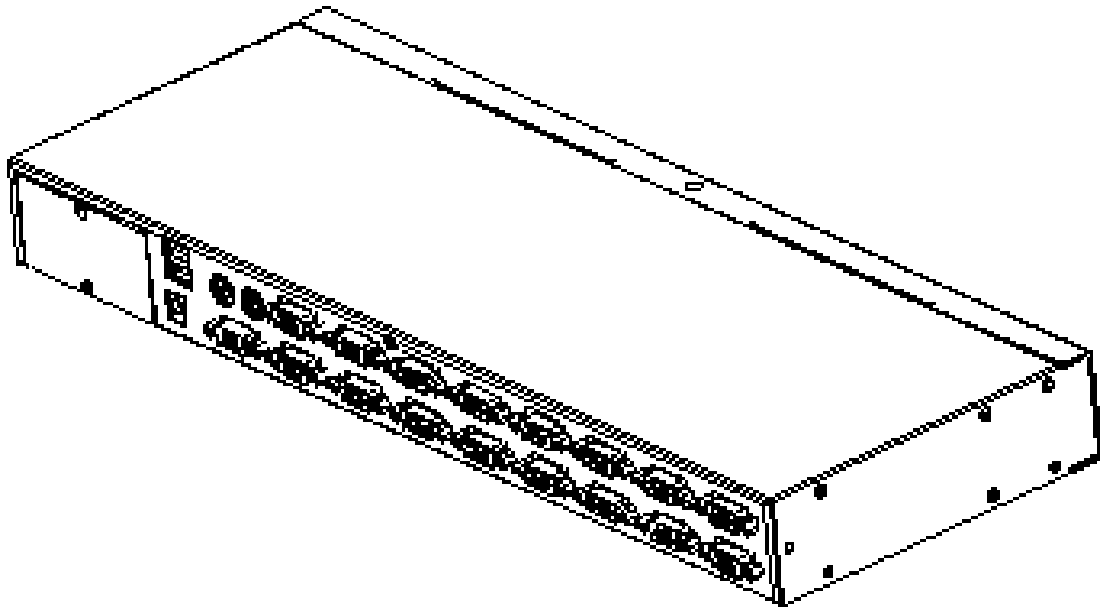

2. Use a screwdriver to remove the two fixing screws on the blank before installation.

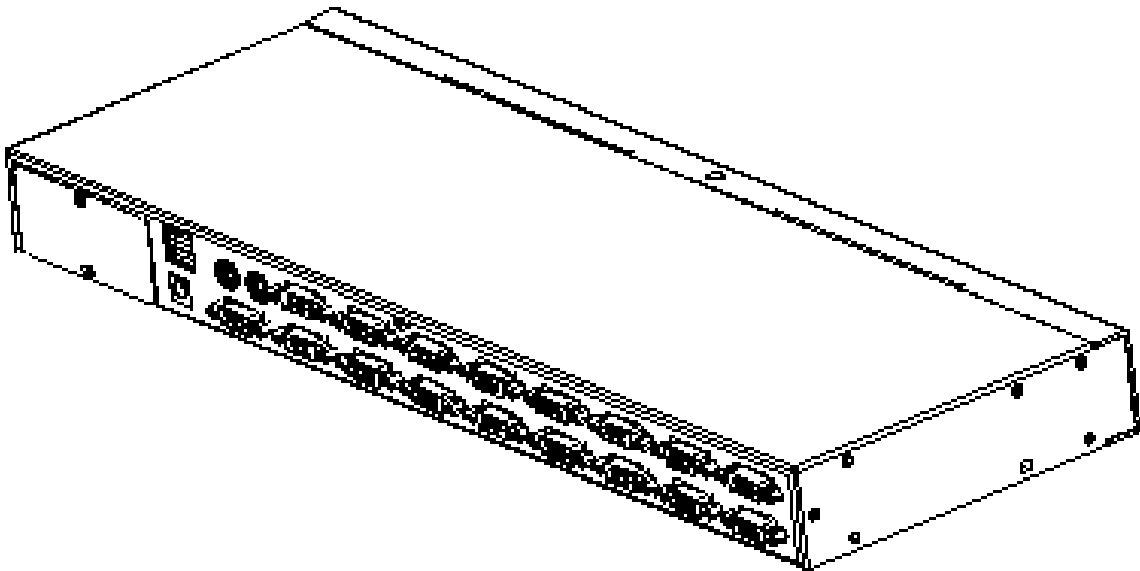

3. After removing the blank, you can see the mounting cavity of the IP module that needs to be expanded, and keep the removed screws for use.

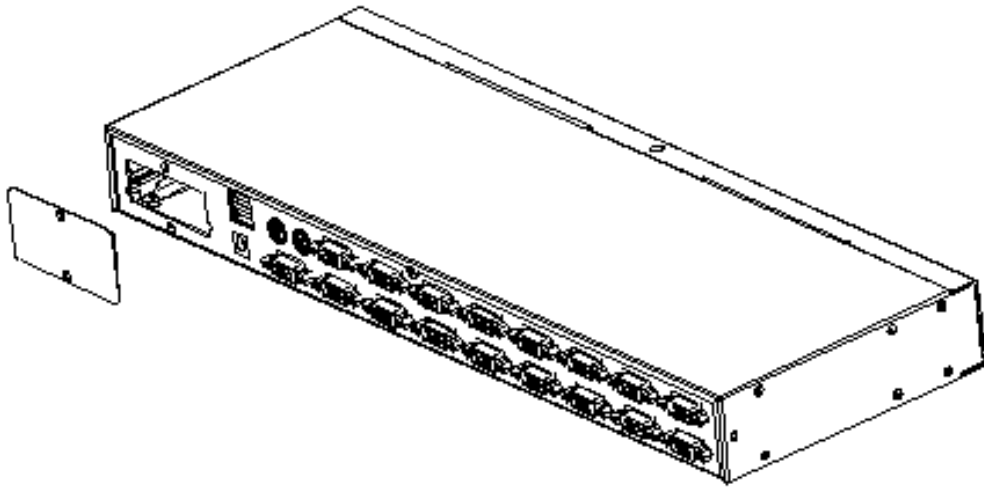

4. Remove the extended IP module and gently push it into the groove in the cavity of the module as shown.

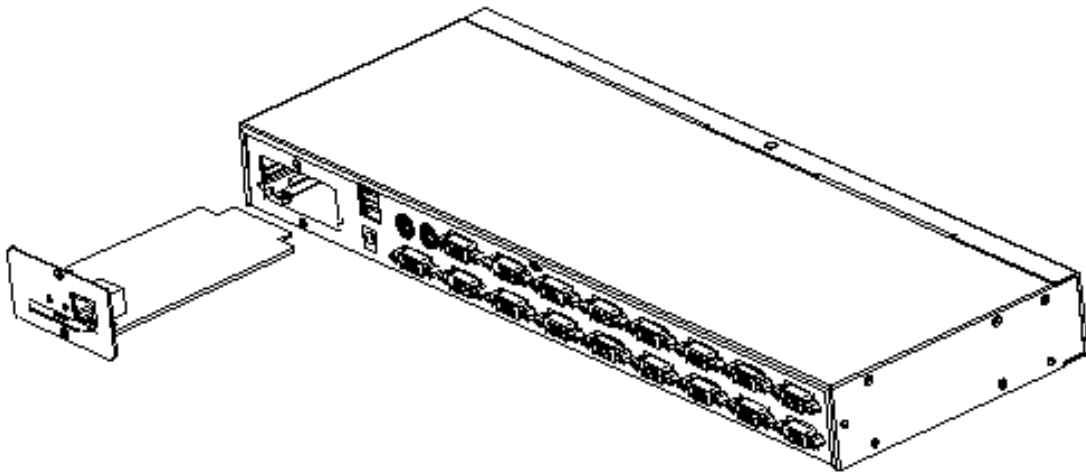

5. After pushing the IP module to the bottom, fix the IP module with the screws of the two fixed brackets that were removed before.

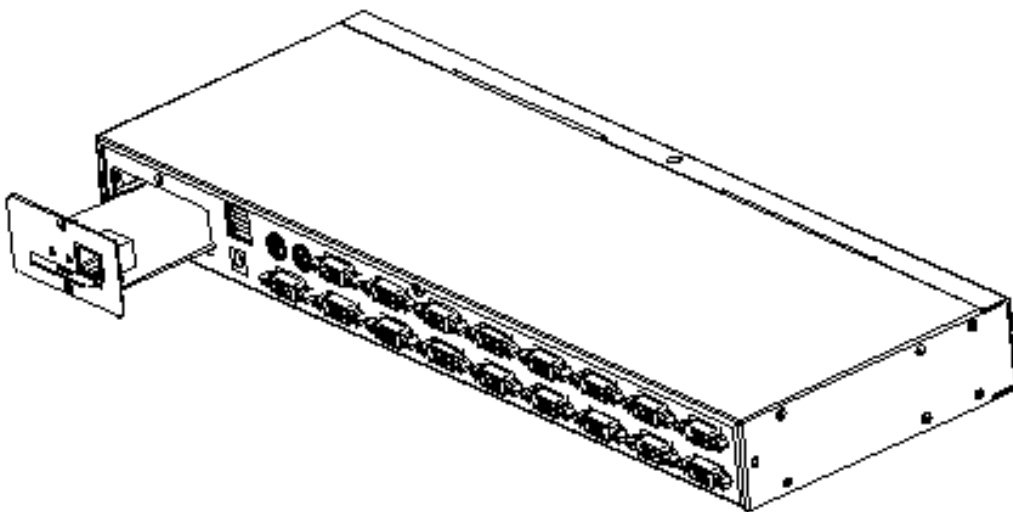

6. After the IP module is installed, before accessing the network cable to enter the switching device, follow the instructions of the IP module to install the related software and configure the network IP address of the device. After the setting is completed, you can access your network to log in. use. (For details, please refer to the product instruction manual of the IP module.)

Remark:

1. **Default user name:** admin
Password: admin
Default IP address is: 192.168.0.10.
2. Product can be stored up to 50 user names and 5 user names can on line at the same time
3. Log save up to 1000

Software Specification and installation

The application software of DS-51000-1:

1. Software was burned in the CD attached with product.
2. Install as following steps:

Find the folder "IP KVM"  and install it successfully; then connect well all the devices;

Plug in the product and connect to network, the default IP address is:

192.168.0.10. Using one PC which in the same network segment and enter

"http://192.168.0.10" in the browser and hit ENTER to access.

Mouse settings

Windows XP, Windows 2003 and Windows 2008 Settings

To configure KVM target servers running Microsoft. Windows XP.

Operating system, Windows 2003

Operating system or Windows 2008

Operating systems:

- i. Choose Start > Control Panel > Mouse
- ii. Click the Pointer Options tab
- iii. In the Motion group
- iv. Set the mouse motion speed setting to exactly the middle speed
- v. Disable the "Enhance pointer precision" option
- vi. Disable the Snap To option
- vii. Click OK

Windows 7 and Windows Vista Settings

To configure KVM target servers running Windows Vista operating system:

1. Choose Start > Settings > Control Panel > Mouse
2. Select "Advanced system settings" from the left navigation panel. The System Properties dialog opens;
3. Click the Pointer Options tab;
4. In the Motion group:
5. Set the mouse motion speed setting to exactly the middle speed;
6. Disable the "Enhanced pointer precision" option;
7. Click OK

To configure KVM target servers running Windows 7. operating system

- Choose Start > Control Panel > Hardware and Sound > Mouse
- Click the Pointer Options tab
- In the Motion group
- Set the mouse motion speed setting to exactly the middle speed
- Disable the "Enhanced pointer precision" option
- Click OK

Windows 2000 Settings

To configure KVM target servers running Microsoft. Windows 2000. operating system:

- i. Choose Start > Control Panel > Mouse
- ii. Click the Motion tab
- iii. Set the acceleration to None
- iv. Set the mouse motion speed setting to exactly the middle speed
- v. Click OK

To configure KVM target servers running Linux. (graphical user interface)

- i. Choose Main Menu > Preferences > Mouse. The Mouse Preferences dialog appears
- ii. Click the Motion tab
- iii. Within the Speed group, set the Acceleration slider to the exact center
- iv. Within the Speed group, set the Sensitivity towards low
- v. Within the Drag & Drop group, set the Threshold towards small
- vi. Close the Mouse Preferences dialog

Note: If these steps do not work, issue the `xset mouse 1 1` command as described in the Linux command line instructions.

To configure KVM target servers running Linux (command line)

- i. Set the mouse acceleration to exactly 1 and set the threshold to exactly 1. Enter this command: `xset mouse 1 1`. This should be set for execution upon login

To configure Red Hat servers using USB CIMs

- i. Locate the configuration file (usually `/etc/modules.conf`) in your system.

Using the editor of your choice, make sure that the alias `usb-controller` line in the `modules.conf` file is as follows: `alias usb-controller usb-uhci`

Note: If there is another line using `usb-uhci` in the `/etc/modules.conf` file, it needs to be removed or commented out

- ii. Save the file
- iii. Reboot the system in order for the changes to take effect.

Linux Settings (for Standard Mouse Mode)

Note: The following settings are optimized for Standard Mouse mode only
To configure KVM target servers running Linux. (graphical user interface)

- i. Red Hat 5 users, choose Main Menu > Preferences > Mouse
Red Hat 4 users, choose System > Preferences > Mouse. The Mouse Preferences dialog appears
- ii. Click on the Motion tab
- iii. Within the Speed group, set the Acceleration slider to the exact center
- iv. Within the Speed group, set the Sensitivity towards low;
- v. Within the Drag & Drop group, set the Threshold towards small;
- vi. Close the Mouse Preferences dialog.

Note: If these steps do not work, issue the `xset mouse 1 1` command as described in the Linux command line instructions

SUSE Linux 10.1 Settings

Note: Do not attempt to synchronize the mouse at the SUSE Linux. login prompt. You must be connected to the target server to synchronize the mouse cursors.

To configure the mouse settings:

- Choose Desktop > Control Center. The Desktop Preferences dialog appears;
- Click Mouse. The Mouse Preferences dialog appears;
- Open the Motion tab;
- Within the Speed group, set the Acceleration slider to the exact center position;
- Within the Speed group, set the Sensitivity slider to low;
- Within the Drag & Drop group, set the Threshold slider to small;
- Click Close.

Sun Solaris Settings

To configure KVM target servers running Sun. Solaris:

1. Set the mouse acceleration value to exactly 1 and the threshold to exactly 1.
This can be performed from:

The graphical user interface

To configure the mouse settings (Sun Solaris 10.1)

- a) Choose Launcher. Application Manager - Desktop Controls opens
- b) Choose Mouse Style Manager. The Style Manager - Mouse dialog appears
- c) Set the Acceleration slider to 1.0
- d) Set the Threshold slider to 1.0
- e) Click OK

BM AIX 5.3 Settings

Follow these steps to configure KVM target servers running IBM. AIX. 5.3

To configure the mouse:

- i. Go to Launcher
- ii. Choose Style Manager
- iii. Click Mouse. The Style Manager - Mouse dialog appears
- iv. Use the sliders to set the Mouse acceleration to 1.0 and Threshold to 1.0
- v. Click OK

WEB server operation

Login and using of WEB Server

Enter <http://192.168.0.10> in browser and click ENTER to access and will appear below login interface. The default user name is admin, and password is admin. Password can be revised after login.

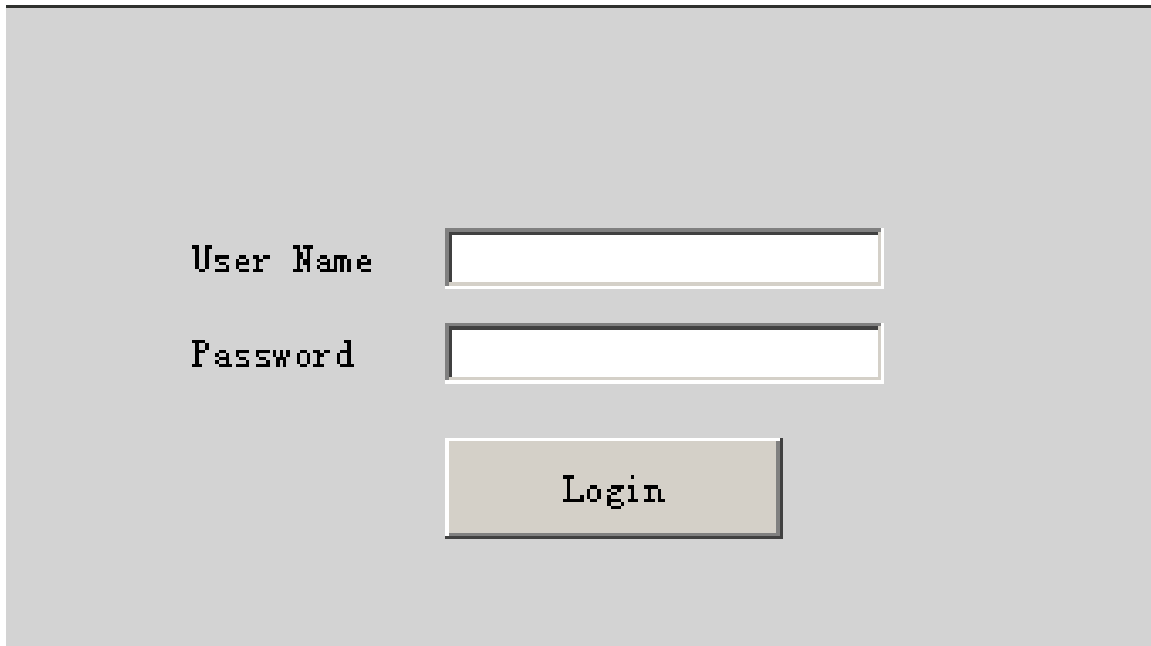

The image shows a login interface with a light gray background. It contains three main elements: a label 'User Name' followed by a white text input field, a label 'Password' followed by a white text input field, and a rectangular button with a light beige background and a dark border containing the text 'Login'.

Operation instructions

After login, the main interface will appear as below. Users can operate base on corresponding authority.

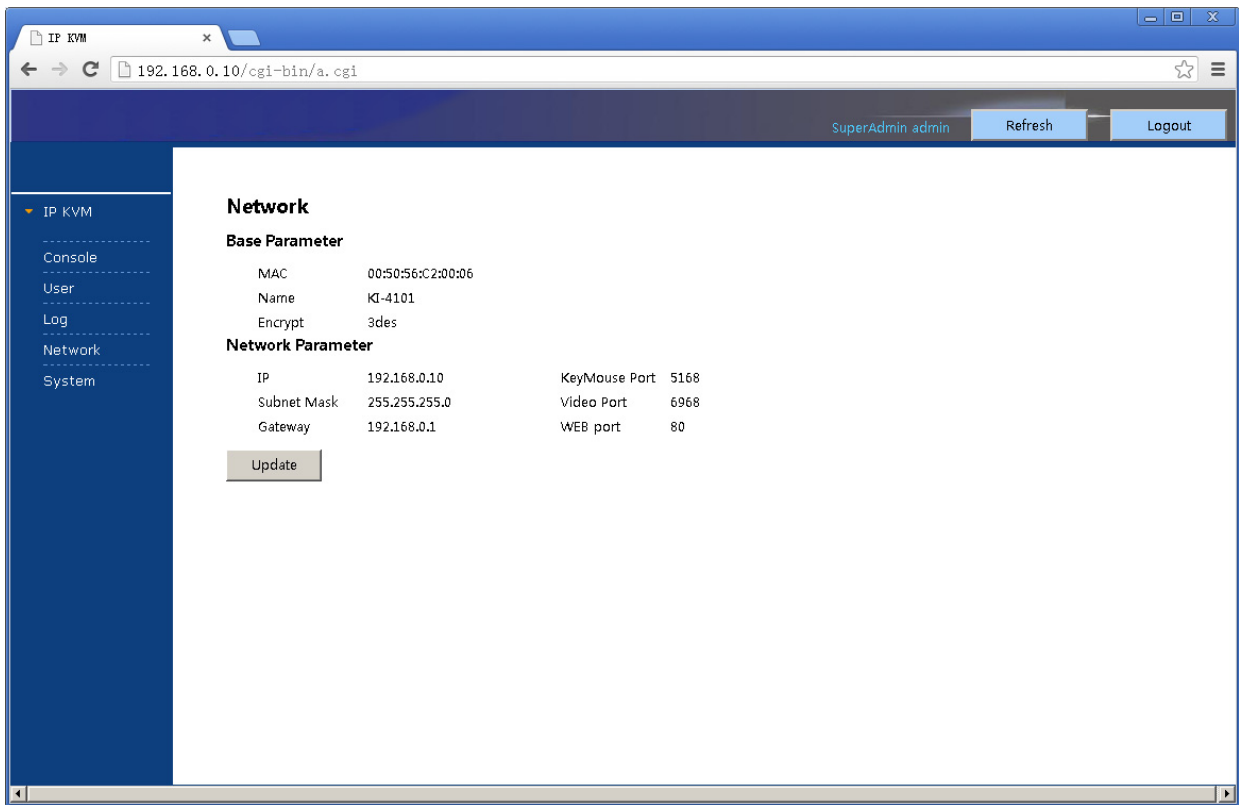

Five options of the functions on the function line of the left of main interface: Console, User, Log, Network, and System

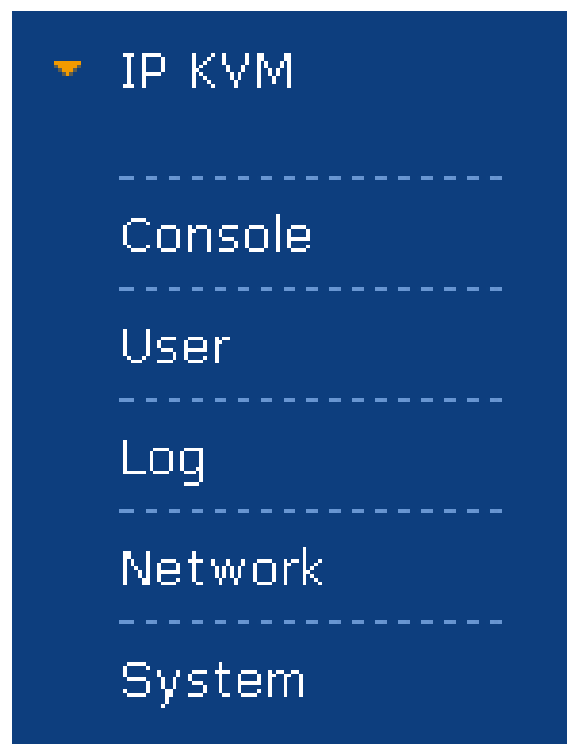

- Console: Click  on the left to modify equipment description or register information, as below picture.

Online Console

Modify	PortID	Name	Type	Group	UID	Status	Client	Position1	Position2	Department	Memo
	1	C1USB10000000	usb		C1USB10000000	idle					

Modify console

Name

Type

Group

UID

Online Status

Position1

Position2

Department

Memo

Share Mode

Bit Stream

Frame Rate

- User: Mainly for user management, include three grade: Super Administrator (only one and couldn't be deleted), Administrator, User. User system includes three groups which can be made based on actual using condition. Higher grade user can add, delete or modify lower grade user. It can be done by modify as below picture.

Group and User

Group

Level	Group	Query	Modify
super	SuperAdmin		
administrator	Adminstrat		
normal	User		

User

Name	Group	Name2	Status	Memo	Query	Modify	Delete
admin	SuperAdmin	ADMIN	online				

Insert user

Base Parameter

Name	<input type="text"/>	Name2	<input type="text"/>
Password	<input type="text"/>	Home Addr	<input type="text"/>
Password Confirm	<input type="text"/>	Company Addr	<input type="text"/>
Group	<input type="text" value="User"/>	Phone	<input type="text"/>
Memo	<input type="text"/>	Email	<input type="text"/>
		Memo2	<input type="text"/>

Console Privilege

uid0 Use Modify

- Log: Support many kinds of log query and log detail as below.

Log query

UserName Begin End Type

User Name	Time	Ip	Type	Query
admin	2016-11-30 14:07:50	192.168.0.130	update console	

Query log detail

Name	Old Value	New Value
uid	C1USB100000000002	C1USB100000000002
name	C1USB100000000002	C1USB100000000002
shareMode	full share	full share
type	usb	usb
group		
position1		office
position2		
department		
memo		
bit stream	2000	2000
frame rate	30	30

Quit

- Network: Some information of server like IP address, UID, name, etc, which can be modified.

Modify Network

Base Parameter

MAC

Name

Encrypt

Network Parameter

IP KeyMouse Port

Subnet Mask Video Port

Gateway WEB port

- System: Time setting and online update of equipment system

System Maintain

Product IPKVM Series

Version

Device Daytime

Set Device Daytime

Restart Device

Update Firmware



◆ Login

After successfully logging in to the WEB page, you can click on the " " icon in the Console page to perform a KVM session. As shown in Figure 4.1.1 below.





International standard DES is used in this software to encrypt user data, to avoid data leakage and guarantee security.

After login, system will automatically calibrate mouse. If it fail, please click

“” image on left to operate manually. Click “” can make display in full screen. If the mouse doesn't work, please click “” to get control authority in idle period of equipment and authority.

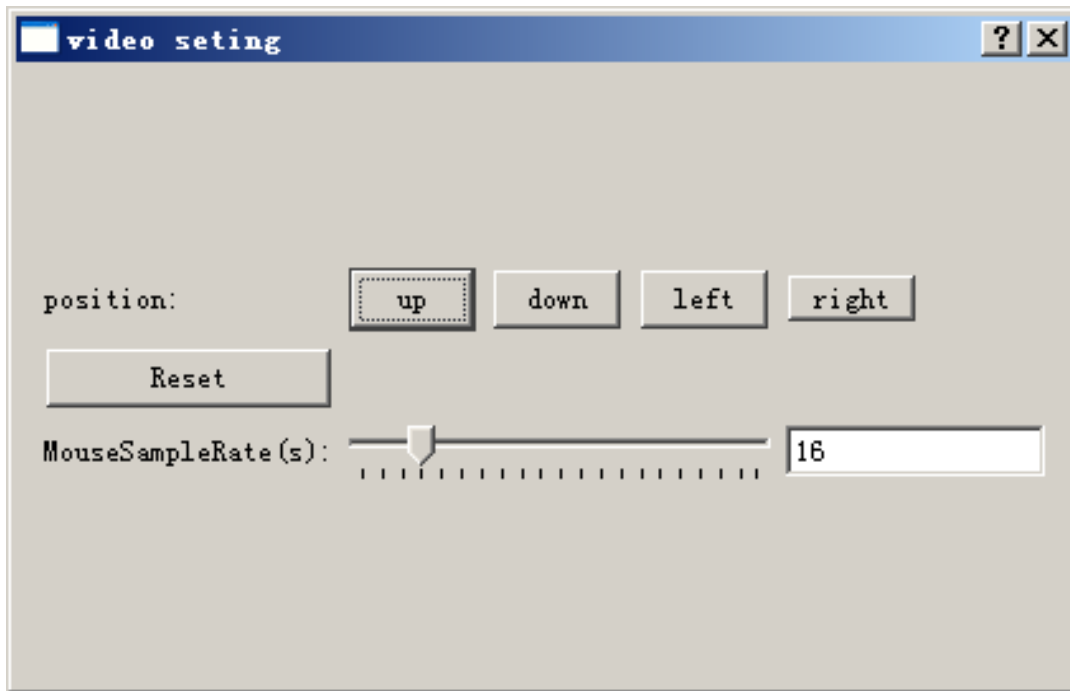
Adjusting display area of screen can be done by clicking “”, set as below picture. The screen can be moved around or reset to initial setting. It can also be used when display shows abnormal.



Click “” can hide local mouse. “” is remote hotkey editing button, click for a popup to add hotkey as below picture.

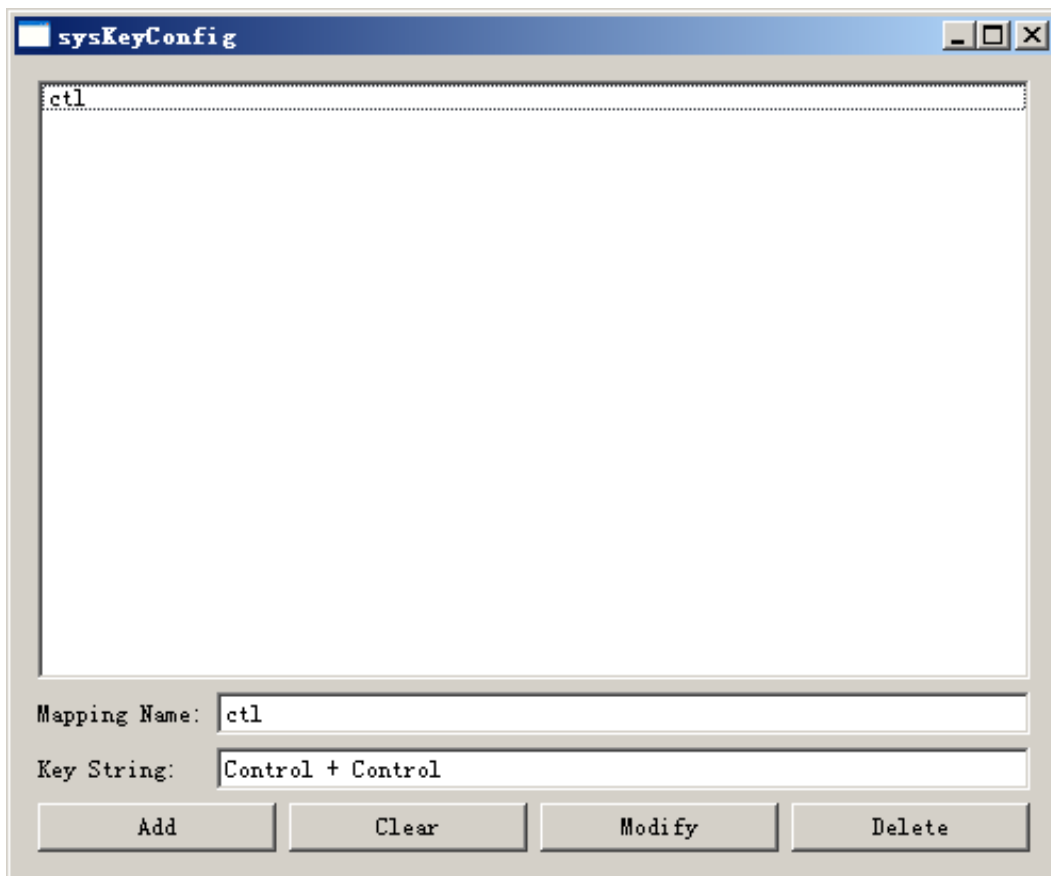

Click “” can choose remote shortcut key directly to operate the controlled machine.

Hereby Assmann Electronic GmbH, declares that the Declaration of Conformity is part of the shipping content. If the Declaration of Conformity is missing, you can request it by post under the below mentioned manufacturer address.

www.assmann.com

Assmann Electronic GmbH

Auf dem Schüffel 3

58513 Lüdenscheid

Germany

