

dji MAVIC 3 PRO

User Manual

v1.0 2023.04

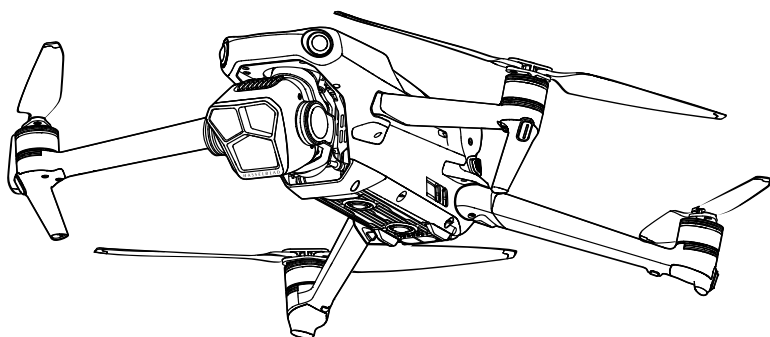



This document is copyrighted by DJI with all rights reserved. Unless otherwise authorized by DJI, you are not eligible to use or allow others to use the document or any part of the document by reproducing, transferring or selling the document. Users should only refer to this document and the content thereof as instructions to operate DJI UAV. The document should not be used for other purposes.

Searching for Keywords

Search for keywords such as “battery” and “install” to find a topic. If you are using Adobe Acrobat Reader to read this document, press Ctrl+F on Windows or Command+F on Mac to begin a search.

Navigating to a Topic

View a complete list of topics in the table of contents. Click on a topic to navigate to that section.

Printing this Document

This document supports high resolution printing.

Using this Manual

Legend

⚠ Important

💡 Hints and Tips

📖 Reference

Read Before the First Flight

DJI™ provides users with tutorial videos and the following documents:

1. Safety Guidelines
2. Quick Start Guide
3. User Manual

It is recommended to watch all tutorial videos and read the safety guidelines before using for the first time. Prepare for your first flight by reviewing the Quick Start Guide and refer to this User Manual for more information.

Video Tutorials

According to the corresponding aircraft, visit the link or scan the QR code below to watch the tutorial videos, which demonstrate how to use DJI MAVIC™ 3 Pro safely:

MAVIC 3 PRO CINE



<https://s.dji.com/guide57>

MAVIC 3 PRO



<https://s.dji.com/guide56>

Download the DJI Fly App

Make sure to use DJI Fly during flight. Scan the QR code above to download the latest version.

- ⚠ • The DJI RC Pro and DJI RC remote controllers have the DJI Fly app already installed. Users are required to download the DJI Fly app to their mobile device when using the DJI RC-N1 remote controller.
- The Android version of DJI Fly is compatible with Android v7.0 and later. The iOS version of DJI Fly is compatible with iOS v11.0 and later.

* For increased safety, flight is restricted to a height of 98.4 ft (30 m) and a range of 164 ft (50 m) when not connected or logged into the app during flight. This applies to DJI Fly and all apps compatible with DJI aircraft.

Download DJI Assistant 2

Download DJI ASSISTANT™ 2 (Consumer Drones Series)

<https://www.dji.com/mavic-3-pro/downloads>

-
-  • The operating temperature of this product is -10° to 40° C. It does not meet the standard operating temperature for military-grade application (-55° to 125° C), which is required to endure greater environmental variability. Operate the product appropriately and only for applications that meet the operating temperature range requirements of that grade.
-

Contents

Using this Manual	3
Legend	3
Read Before the First Flight	3
Video Tutorials	3
Download the DJI Fly App	3
Download DJI Assistant 2	4
Product Profile	9
Introduction	9
Feature Highlights	9
Using for the First Time	10
Preparing the Aircraft	10
Preparing the Remote Controller	11
Activating the DJI Mavic 3 Pro Aircraft	12
Binding the Aircraft and Remote Controller	12
Updating Firmware	12
Overview	13
Aircraft	13
DJI RC Pro	14
DJI RC Remote Controller	17
Flight Safety	20
Flight Environment Requirements	20
Operating the Aircraft Responsibly	20
Flight Restrictions	21
GEO (Geospatial Environment Online) System	21
Flight Limits	21
GEO Zones	23
Pre-Flight Checklist	23
Basic Flight	23
Auto Takeoff/Landing	23
Starting/Stopping the Motors	24
Controlling the Aircraft	25
Takeoff/Landing Procedures	26
Video Suggestions and Tips	26
Intelligent Flight Modes	27
FocusTrack	27
MasterShots	31

QuickShots	32
Hyperlapse	34
Waypoint Flight	36
Cruise Control	40
Aircraft	42
Flight Modes	42
Aircraft Status Indicators	43
Return to Home	44
Smart RTH	44
Low Battery RTH	47
Failsafe RTH	48
Landing Protection	49
Precision Landing	49
Vision Systems and Infrared Sensing System	50
Detection Range	50
Using the Vision System	51
Advanced Pilot Assistance Systems (APAS 5.0)	53
Landing Protection	53
Flight Recorder	54
Propellers	54
Attaching the propellers	54
Detaching the propellers	54
Intelligent Flight Battery	55
Battery Features	55
Using the Battery	56
Charging the Battery	57
Inserting/Removing the Battery	60
Gimbal and Camera	61
Gimbal Profile	61
Gimbal Operation Modes	61
Camera Profile	62
Storing and Exporting Photos and Videos	63
QuickTransfer	63
Usage	63
Remote Controller	66
DJI RC Pro	66
Operation	66
Remote Controller LEDs	71

Remote Controller Alert	71
Optimal Transmission Zone	71
Linking the Remote Controller	72
Operating the Touchscreen	73
Advanced Features	75
DJI RC	76
Operation	76
Remote Controller LEDs	80
Remote Controller Alert	81
Optimal Transmission Zone	81
Linking the Remote Controller	82
Operating the Touchscreen	83
Advanced Features	85
DJI Fly App	87
Home	87
Camera View	88
Buttons Description	88
Screen Shortcuts	91
Settings	92
Safety	92
Control	93
Camera	93
Transmission	95
About	95
Appendix	97
Specifications	97
Camera Function Matrix	105
Firmware Update	106
Using DJI Fly	106
Using DJI Assistant 2 (Consumer Drones Series)	106
Post-Flight Checklist	107
Maintenance Instructions	107
Troubleshooting Procedures	108
Risk and Warnings	108
Disposal	109
C2 Certification	109
FAR Remote ID Compliance Information	114
After-Sales Information	114

Product Profile

This chapter introduces the major features of the product.

Product Profile

Introduction

DJI Mavic 3 Pro features both an infrared sensing system and omnidirectional vision systems, allowing for hovering and flying indoors, outdoors, and for automatic Return to Home while avoiding obstacles in all directions. The aircraft has a maximum flight speed of 47 mph (75.6 kph) and a maximum flight time of 43 minutes.

The DJI RC Pro and DJI RC remote controllers have a built-in 5.5-in screen with a resolution of 1920×1080 pixels. Users can connect to the internet via Wi-Fi, while the Android operating system includes Bluetooth and GNSS. The remote controllers come with a wide range of aircraft and gimbal controls as well as customizable buttons. DJI RC Pro has a high-bright screen and has a maximum operating time of 3 hours. DJI RC has a maximum operating time of 4 hours.

Feature Highlights

Gimbal and Camera: DJI Mavic 3 Pro has a 4/3 CMOS sensor Hasselblad camera, capable of shooting 12-bit RAW format photos and the dynamic range is up to 12.8 stops. It is also equipped with a 1/1.3-in medium tele camera and a 1/2-in tele camera, which can shoot 4K 60fps video with 3x or 7x optical zoom. The newly added 10-bit D-Log M color mode provides a more convenient experience for post-production color correction.

Video Transmission: with DJI's long-range transmission O3+ technology, DJI Mavic 3 Pro offers a maximum transmission range of 15 km and video quality at up to 1080p 60fps from the aircraft to the DJI Fly app. The remote controller works at both 2.4 and 5.8 GHz, and is capable of selecting the best transmission channel automatically.

Intelligent Flight Modes: the user can focus on operating the aircraft, while the Advanced Pilot Assistance System 5.0 (APAS 5.0) helps the aircraft avoid obstacles in all directions. With Intelligent Flight Modes such as FocusTrack, MasterShots, Hyperlapse, QuickShots, or Waypoint Flight, the user can enjoy taking photos or videos with ease.



- Only the DJI Mavic 3 Pro Cine aircraft comes with a built-in 1TB SSD, which supports the recording and storing of Apple ProRes 422 HQ, Apple ProRes 422, and Apple ProRes 422 LT video. Otherwise, the features and functions described in this manual apply to both DJI Mavic 3 Pro and DJI Mavic 3 Pro Cine.



- The maximum flight time was tested in an environment without wind while flying at a consistent flight speed of 20.1 mph (32.4 kph). The maximum flight speed was tested at sea level altitude without wind.
- The remote control devices reach their maximum transmission distance (FCC) in a wide open area with no electromagnetic interference at an altitude of about 120 m (400 ft). The maximum transmission distance refers to the maximum distance that the aircraft can still send and receive transmissions. It does not refer to the maximum distance the aircraft can fly in a single flight. The maximum runtime was tested in a laboratory environment. This value is for reference only.
- 5.8 GHz is not supported in certain regions. Observe local laws and regulations.

Using for the First Time

DJI Mavic 3 Pro is folded before being packaged. Follow the steps below to unfold the aircraft and prepare the remote controller.

Preparing the Aircraft

1. Remove the storage cover.

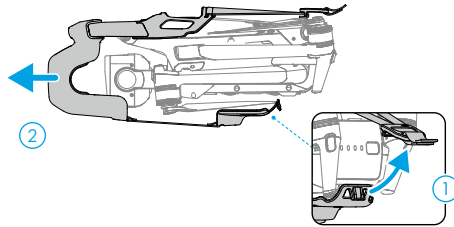

2. All Intelligent Flight Batteries are in hibernation mode before shipment to ensure safety. Use the provided charger to charge and activate the Intelligent Flight Batteries for the first time.
 - a. If using DJI 100W USB-C Power Adapter, it takes approximately 1 hour and 20 minutes to fully charge an Intelligent Flight Battery.

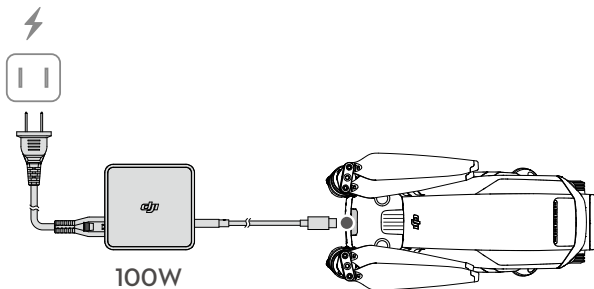

- b. If using DJI 65W Portable Charger, it takes approximately 1 hour and 36 minutes to fully charge an Intelligent Flight Battery. Charging time is tested when using the fixed cable of the charger. It is recommended to use this cable to charge the Intelligent Flight Battery.

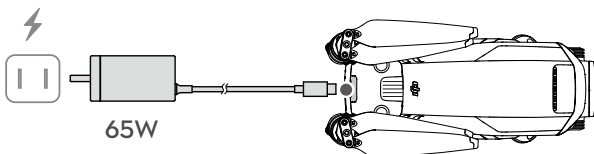

3. Unfold the front arms, followed by the rear arms, and then the propeller blades.

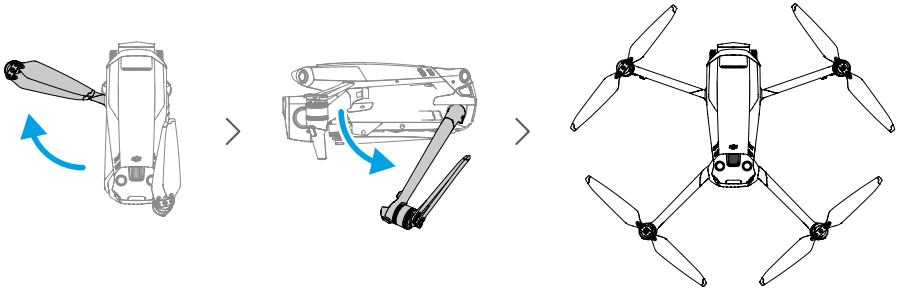

- ⚠ • Charger is not included with Mavic 3 Pro (Drone Only). It is recommended to use a PD 65W (or above) charger to charge the Intelligent Flight Battery.
- Use a power cable with compatible specifications for charging, and use a power adapter if necessary.
- Make sure to unfold the front arms before unfolding the rear arms.
- Make sure the gimbal protector is removed and all arms are unfolded before powering on the aircraft. Otherwise, it may affect the aircraft self-diagnostics.
- Attach the storage cover when the aircraft is not in use.

Preparing the Remote Controller

Follow the steps below to prepare the DJI RC Pro remote controller.

1. Use the provided charger to charge the remote controller via the USB-C port to activate the battery.

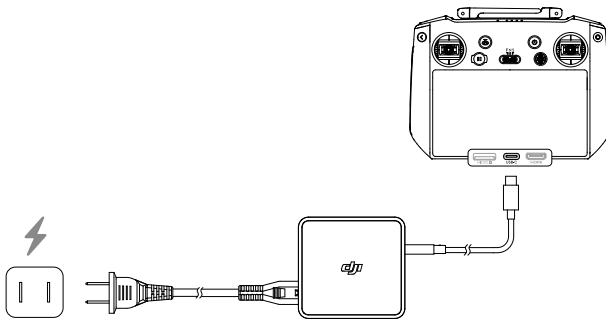

2. Remove the control sticks from the storage slots on the remote controller and screw them into place.
3. Unfold the antennas.

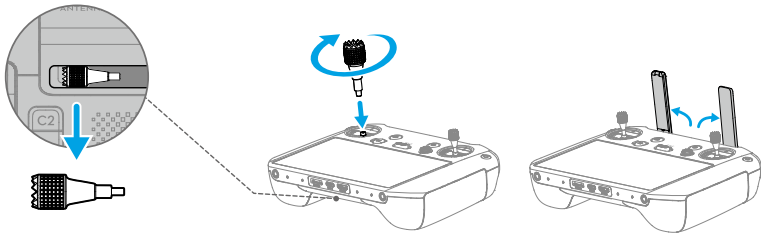

4. The remote controller needs to be activated before first use and an internet connection is required for activation. Press, and then press again and hold the power button to power on the remote controller. Follow the on-screen prompts to activate the remote controller.

Follow the steps below to prepare the DJI RC remote controller.

1. Remove the control sticks from the storage slots on the remote controller and screw them into place.

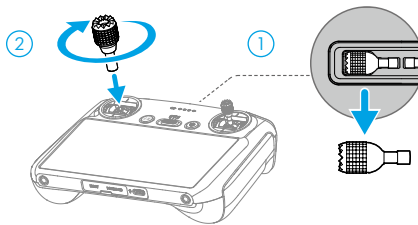

2. The remote controller needs to be activated before first use and an internet connection is required for activation. Press, and then press again and hold the power button to power on the remote controller. Follow the on-screen prompts to activate the remote controller.

Activating the DJI Mavic 3 Pro Aircraft

DJI Mavic 3 Pro requires activation before first use. After powering on the aircraft and remote controller, follow the on-screen prompts to activate DJI Mavic 3 Pro using DJI Fly. An internet connection is required for activation.

Binding the Aircraft and Remote Controller

It is recommended to bind the aircraft and remote controller to help ensure the best possible after-sales service. Follow the on-screen prompts after activation to bind the aircraft and remote controller.

Updating Firmware

A prompt will appear in DJI Fly when new firmware is available. Update the firmware whenever prompted to ensure optimal user experience.

Overview

Aircraft

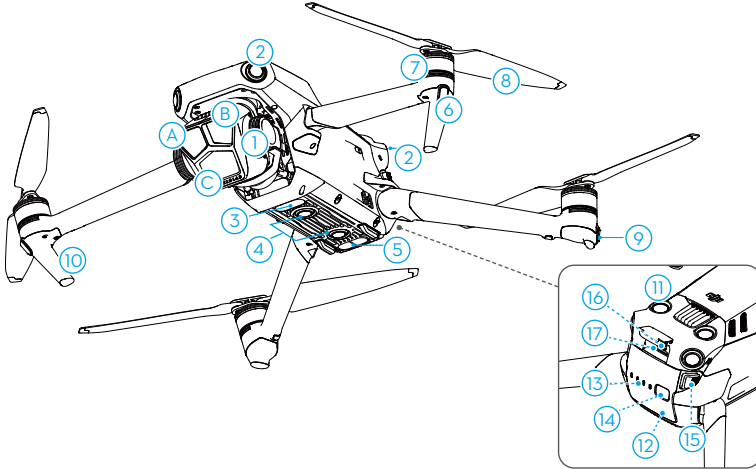

- | | |
|---|--------------------------------------|
| 1. Gimbal and Camera | 8. Propellers |
| A. Tele Camera | 9. Aircraft Status Indicators |
| B. Medium Tele Camera | 10. Landing Gear (Built-in antennas) |
| C. Hasselblad Camera | 11. Upward Vision System |
| 2. Horizontal Omnidirectional Vision System | 12. Intelligent Flight Battery |
| 3. Auxiliary Light | 13. Battery Level LEDs |
| 4. Downward Vision System | 14. Power Button |
| 5. Infrared Sensing System | 15. Battery Buckles |
| 6. Front LEDs | 16. USB-C Port |
| 7. Motors | 17. Camera microSD Card Slot |

DJI RC Pro

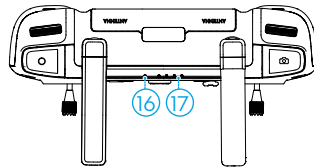
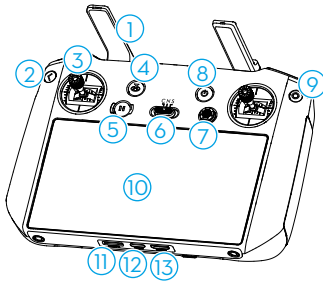

1. Antennas

Transmit control and video wireless signals between the remote controller and the aircraft.

2. Back/Function Button

Press once to return to the previous screen. Press twice to return to the home screen.

Use the back button in combinations with other buttons for additional functions. Refer to the Remote Controller Button Combinations section for more information.

3. Control Sticks

Use the control sticks to control the aircraft movements. Set the stick mode in DJI Fly. The control sticks are removable and easy to store.

4. Return to Home (RTH) Button

Press and hold to initiate RTH. Press again to cancel RTH.

5. Flight Pause Button

Press once to make the aircraft brake and hover in place (only when GNSS or Vision Systems are available).

6. Flight Mode Switch

For switching between three flight modes: Switch between Cine, Normal, and Sport mode.

7. 5D Button

View and set the 5D button features in DJI Fly by entering Camera View > Settings > Control > Button Customization.

8. Power Button

Press once to check the current battery level. Press, and then press and hold to power the remote controller on or off. When the remote controller is powered on, press once to turn the touchscreen on or off.

9. Confirm/Customizable C3 Button

Press once to confirm a selection. The button does not have a function by default when using DJI Fly. Set the function in DJI Fly by entering Camera View > Settings > Control > Button Customization.

10. Touchscreen

Touch the screen to operate the remote controller. Note that the touchscreen is not waterproof. Operate with caution.

11. microSD Card Slot

For inserting a microSD card.

12. USB-C Port

For charging and connecting the remote controller to the computer.

13. Mini HDMI Port

For outputting HDMI signal to an external monitor.

14. Gimbal Dial

Controls the tilt of the camera.

15. Record Button

Press once to start or stop recording.

16. Status LED

Indicates the status of the remote controller.

17. Battery Level LEDs

Display the battery level of the remote controller.

18. Focus/Shutter Button

Press halfway down on the button to autofocus and press all the way down to take a photo. Press once to switch to photo mode when in record mode.

19. Camera Control Dial

Control zoom in/out by default. Set the function in DJI Fly by entering Camera View > Settings > Control > Button Customization.

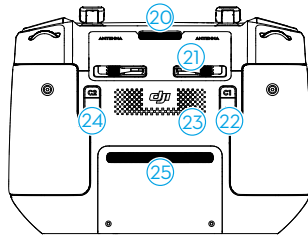

20. Air Vent

For heat dissipation. Do not block the air vent during usage.

21. Control Sticks Storage Slot

For storing the control sticks.

22. Customizable C1 Button

Switch between recentering the gimbal and pointing the gimbal downward. Set the function in DJI Fly by entering Camera View > Settings > Control > Button Customization.

23. Speaker

Outputs sound.

24. Customizable C2 Button

Press once to turn the auxiliary light on or off. Set the function in DJI Fly by entering Camera View > Settings > Control > Button Customization.

25. Air Intake

For heat dissipation. Do not block the air intake during usage.

DJI RC Remote Controller

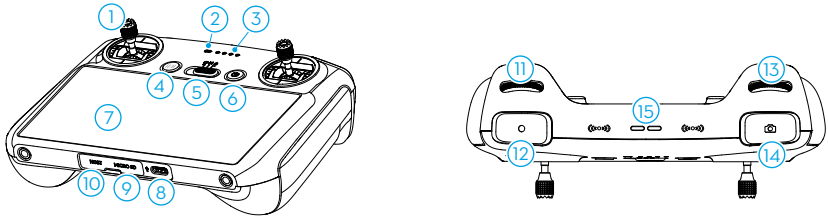

1. Control Sticks

Use the control sticks to control the aircraft movements. Set the stick mode in DJI Fly. The control sticks are removable and easy to store.

2. Status LED

Indicates the status of the remote controller.

3. Battery Level LEDs

Display the battery level of the remote controller.

4. Flight Pause/RTH Button

Press once to make the aircraft brake and hover in place (only when GNSS or Vision Systems are available). Press and hold to initiate RTH. Press again to cancel RTH.

5. Flight Mode Switch

For switching between three flight modes: Switch between Cine, Normal, and Sport mode.

6. Power Button

Press once to check the current battery level. Press, and then press and hold to power the remote controller on or off. When the remote controller is powered on, press once to turn the touchscreen on or off.

7. Touchscreen

Touch the screen to operate the remote controller. Note that the touchscreen is not waterproof. Operate with caution.

8. USB-C Port

For charging and connecting the remote controller to the computer.

9. microSD Card Slot

For inserting a microSD card.

10. Host Port (USB-C)

Reserved.

11. Gimbal Dial

Controls the tilt of the camera.

12. Record Button

Press once to start or stop recording.

13. Camera Control Dial

Control zoom in/out by default. Set the function in DJI Fly by entering Camera View > Settings > Control > Button Customization.

14. Focus/Shutter Button

Press halfway down on the button to autofocus and press all the way down to take a photo. Press once to switch to photo mode when in record mode.

15. Speaker

Outputs sound.

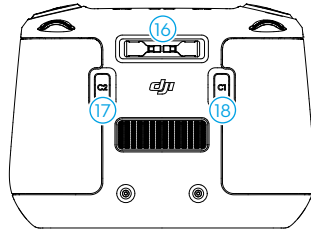

16. Control Sticks Storage Slot

For storing the control sticks.

17. Customizable C2 Button

Press once to turn the auxiliary light on or off. Set the function in DJI Fly by entering Camera View > Settings > Control > Button Customization.

18. Customizable C1 Button

Switch between recentering the gimbal and pointing the gimbal downward. Set the function in DJI Fly by entering Camera View > Settings > Control > Button Customization.

Flight Safety

This section describes safe flight practices and flight restrictions.

Flight Safety

Once pre-flight preparation is complete, it is recommended to hone your flight skills and practice flying safely. Pick a suitable area to fly in according to the following flight requirements and restrictions. Make sure you understand and comply with the local laws and regulations before flying. Read the Safety Guidelines before flight to ensure the safe use of the product.

Flight Environment Requirements

1. DO NOT operate the aircraft in severe weather conditions, including wind speeds exceeding 12 m/s, snow, rain, and fog.
2. Only fly in open areas. Tall buildings and large metal structures may affect the accuracy of the onboard compass and GNSS system. It is recommended to keep the aircraft at least 5 m away from structures.
3. Avoid obstacles, crowds, trees, and bodies of water (recommended height is at least 3 m above water).
4. Minimize interference by avoiding areas with high levels of electromagnetism, such as locations near power lines, base stations, electrical substations, and broadcasting towers.
5. DO NOT take off from an altitude more than 6000 m (19,685 ft) above sea level. The performance of the aircraft and its battery is limited when flying at high altitudes. Fly with caution.
6. GNSS cannot be used on the aircraft in polar regions. Use the vision system instead.
7. DO NOT take off from moving objects, such as cars and ships.
8. DO NOT use the aircraft, remote controller, battery, and battery charger near accidents, fires, explosions, floods, tsunamis, avalanches, landslides, earthquakes, dust, or sandstorms.
9. Use the battery charger in a temperature range of 5° to 40° C (41° to 104° F).
10. Operate the aircraft, battery, remote controller, and battery charger in a dry environment.
11. DO NOT use the battery charger in humid environments.

Operating the Aircraft Responsibly

To avoid serious injury and property damage, observe the following rules:

1. Make sure you are NOT under the influence of anesthesia, alcohol, or drugs or suffering from dizziness, fatigue, nausea, or other conditions that could impair the ability to operate the aircraft safely.
2. When landing, power off the aircraft first, then switch off the remote controller.
3. DO NOT drop, launch, fire, or otherwise project any dangerous payloads on or at any buildings, persons, or animals, which could cause personal injury or property damage.

4. DO NOT use an aircraft that has been crashed or accidentally damaged or an aircraft that is not in good condition.
5. Make sure to train sufficiently and have contingency plans for emergencies or when an incident occurs.
6. Make sure to have a flight plan. DO NOT fly the aircraft recklessly.
7. Respect the privacy of others when using the camera. Make sure to comply with local privacy laws, regulations, and moral standards.
8. DO NOT use this product for any reason other than general personal use.
9. DO NOT use it for illegal or inappropriate purposes such as spying, military operations, or unauthorized investigations.
10. DO NOT use this product to defame, abuse, harass, stalk, threaten, or otherwise violate legal rights such as the right to privacy and publicity of others.
11. DO NOT trespass onto the private property of others.

Flight Restrictions

GEO (Geospatial Environment Online) System

DJI's Geospatial Environment Online (GEO) System is a global information system that provides real-time information on flight safety and restriction updates and prevents UAVs from flying in restricted airspace. Under exceptional circumstances, restricted areas can be unlocked to allow flights in. Prior to that, the user must submit an unlocking request based on the current restriction level in the intended flight area. The GEO system may not fully comply with local laws and regulations. Users shall be responsible for their own flight safety and must consult with the local authorities on the relevant legal and regulatory requirements before requesting to unlock a flight in a restricted area. For more information about the GEO system, visit <https://fly-safe.dji.com>.

Flight Limits

For safety reasons, flight limits are enabled by default to help users operate this aircraft safely. Users can set flight limits on height and distance. Altitude limits, distance limits, and GEO zones function concurrently to manage flight safety when GNSS is available. Only altitude can be limited when GNSS is unavailable.

Flight Altitude and Distance Limits

Max altitude restricts an aircraft's flight altitude, while max distance restricts an aircraft's flight radius around the Home Point. These limits can be changed in the DJI Fly app for improved flight safety.

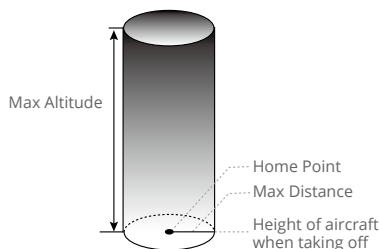

Home Point not manually updated during flight

Strong GNSS Signal

	Flight Restrictions	Prompt in DJI Fly App
Max Altitude	Altitude of the aircraft cannot exceed the value set in the DJI Fly app.	Max flight altitude reached.
Max Distance	The straight-line distance from the aircraft to the Home Point cannot exceed the max flight distance set in the DJI Fly app.	Max flight distance reached.

Weak GNSS Signal

	Flight Restrictions	Prompt in DJI Fly App
Max Altitude	<ul style="list-style-type: none"> Height is restricted to 30 m from the takeoff point if lighting is sufficient. Height is restricted to 5 m above the ground if lighting is not sufficient and the Infrared Sensing System is operating. Height is restricted to 30 m from the takeoff point if lighting is not sufficient and the Infrared Sensing System is not operating. 	Max flight altitude reached.
Max Distance	No limits	

- ⚠** • The altitude limit when the GNSS is weak will not be restricted if there was a strong GNSS signal (GNSS signal strength ≥ 2) when the aircraft was powered on.
- If an aircraft exceeds a specified limit, the pilot can still control the aircraft but cannot fly any closer to the restricted area.
 - For safety reasons, DO NOT fly the aircraft close to airports, highways, railway stations, railway lines, city centers, or other sensitive areas. Only fly the aircraft within a visual line of sight.

GEO Zones

DJI's GEO system designates safe flight locations, provides risk levels and safety notices for individual flights and offers information on restricted airspace. All restricted flight areas are referred to as GEO Zones, which are further divided into Restricted Zones, Authorization Zones, Warning Zones, Enhanced Warning Zones, and Altitude Zones. Users can view such information in real-time in the DJI Fly app. GEO Zones are specific flight areas, including but not limited to airports, large event venues, locations where public emergencies have occurred (such as forest fires), nuclear power plants, prisons, government properties, and military facilities. By default, the GEO system limits takeoffs and flights in zones that may cause safety or security concerns. A GEO Zone map that contains comprehensive information on GEO Zones around the globe is available on the official DJI website: <https://fly-safe.dji.com/nfz/nfz-query>.

Pre-Flight Checklist

1. Make sure the remote controller, mobile device, and Intelligent Flight Battery are fully charged.
2. Make sure the Intelligent Flight Battery and the propellers are mounted securely.
3. Make sure the aircraft arms are unfolded.
4. Make sure the gimbal and camera are functioning normally.
5. Make sure that there is nothing obstructing the motors and that they are functioning normally.
6. Make sure that the DJI Fly is successfully connected to the aircraft.
7. Make sure all camera lenses and sensors are clean.
8. Only use genuine DJI parts or DJI authorized parts. Unauthorized parts may cause system malfunctions and compromise flight safety.

Basic Flight

Auto Takeoff/Landing



Auto Takeoff

Use the Auto Takeoff function:

1. Launch DJI Fly and enter the camera view.
2. Complete all steps in the pre-flight checklist.
3. Tap . If conditions are safe for takeoff, press and hold the button to confirm.
4. The aircraft will take off and hover approx. 1.2 m (3.9 ft) above the ground.

Auto Landing

Use the Auto Landing function:

1. Tap . If conditions are safe for landing, press and hold the button to confirm.
2. Auto landing can be cancelled by tapping .
3. If the Downward Vision System is working normally, Landing Protection will be enabled.
4. Motors will stop automatically after landing.

 • Choose the proper place for landing.

Starting/Stopping the Motors

Starting the Motors

Perform the Combination Stick Command (CSC) as shown below to start the motors. Once the motors start spinning, release both sticks simultaneously.

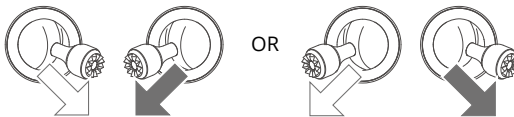

Stopping the Motors

The motors can be stopped in two ways:

Method 1: When the aircraft has landed, push the throttle stick down and hold until the motors stop.

Method 2: When the aircraft has landed, perform the same CSC used to start the motors until the motors stop.

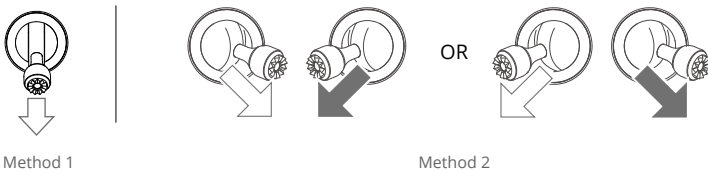

Stopping the Motors Mid-Flight

Stopping motors mid-flight will cause the aircraft to crash. The motors should only be stopped mid-flight in an emergency situation such as if the aircraft is involved in a collision, a motor has stalled, the aircraft is rolling in the air, or the aircraft is out of control and is ascending or descending very quickly. To stop the motors mid-flight, perform the same CSC that was used to start the motors for two seconds. The default setting can be changed in DJI Fly.

Controlling the Aircraft

The control sticks of the remote controller can be used to control the aircraft movements. The control sticks can be operated in Mode 1, Mode 2, or Mode 3, as shown below. The default control mode of the remote controller is Mode 2. Refer to the Remote Controller section for more details.

Mode 1

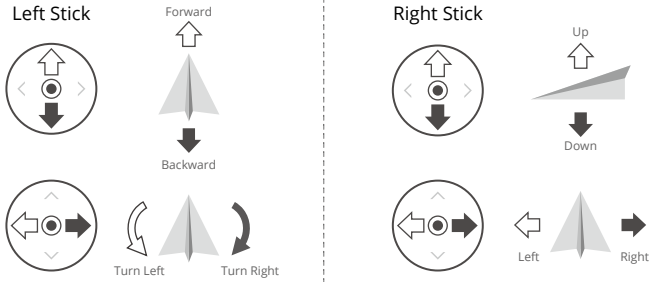

Mode 2

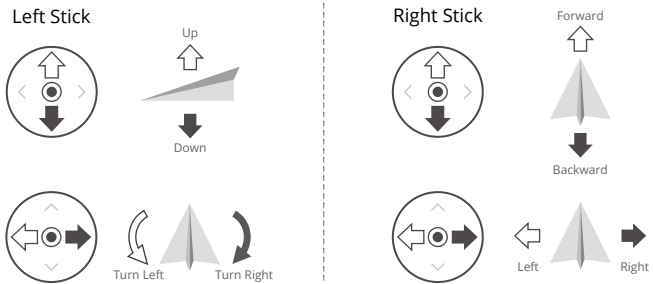

Mode 3

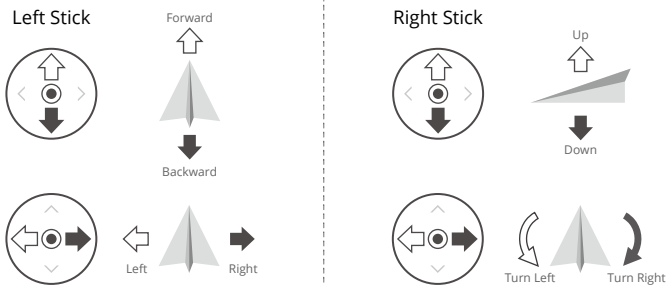

Takeoff/Landing Procedures

1. Place the aircraft in an open, flat area with the aircraft rear facing towards the user.
2. Power on the remote controller and the aircraft.
3. Launch DJI Fly and enter the camera view.
4. Tap Settings > Safety, and then set the Obstacle Avoidance Action to Bypass or Brake. Make sure to set an appropriate Max Altitude and RTH Altitude.
5. Wait for the aircraft self-diagnostics to complete. If DJI Fly does not show any irregular warning, the user can start the motors.
6. Push the throttle stick up slowly to takeoff.
7. To land, hover over a level surface and push the throttle stick down to descend.
8. After landing, push the throttle down and hold until the motors stop.
9. Power off the aircraft before the remote controller.

Video Suggestions and Tips

1. The pre-flight checklist is designed to help the user fly safely and shoot videos during flight. Go through the full pre-flight checklist before each flight.
2. Select the desired gimbal operation mode.
3. It is recommended to take photos or record videos when flying in Normal or Cine mode.
4. DO NOT fly in bad weather such as on rainy or windy days.
5. Choose the camera settings that best suit your needs.
6. Perform flight tests to establish flight routes and preview scenes.
7. Push the control sticks gently to ensure smooth and stable movement of the aircraft.



- Make sure to place the aircraft on a flat and steady surface before takeoff. DO NOT launch the aircraft from your palm or while holding it with your hand.
-

Intelligent Flight Modes

FocusTrack

FocusTrack includes Spotlight 2.0, Point of Interest 3.0, and ActiveTrack 5.0.

 • Refer to the Remote Controller and Controlling the Aircraft sections for more information about the roll, pitch, throttle, and yaw control sticks.

	Spotlight 2.0	Point of Interest 3.0 (POI 3.0)	ActiveTrack 5.0
Description	Control the aircraft manually while the camera remains locked on the subject.	The aircraft tracks the subject in a circle based on the set radius and flight speed. The max flight speed is 12 m/s and the flight speed may be adjusted dynamically according to the actual radius.	The aircraft keeps a certain distance and altitude from the tracked subject, and there are two modes: Trace and Parallel. The max flight speed is 12 m/s.
Supported Subjects	<ul style="list-style-type: none"> Stationary subjects Moving subjects such as vehicles, boats, and people 		<ul style="list-style-type: none"> Moving subjects such as vehicles, boats, and people
Control	Using the control sticks to move the aircraft: <ul style="list-style-type: none"> Move the roll stick to circle the subject Move the pitch stick to alter the distance from the subject Move the throttle stick to change the altitude Move the yaw stick to adjust the frame 	Using the control sticks to move the aircraft: <ul style="list-style-type: none"> Move the roll stick to change the circling speed of the aircraft around the subject Move the pitch stick to alter the distance from the subject Move the throttle stick to change the altitude Move the yaw stick to adjust the frame 	Using the control sticks to move the aircraft: <ul style="list-style-type: none"> Move the roll stick to circle the subject Move the pitch stick to alter the distance from the subject Move the throttle stick to change the altitude Move the yaw stick to adjust the frame
Obstacle Avoidance	When the vision systems are working normally, the aircraft will hover if an obstacle is detected, regardless of whether the obstacle avoidance action is set to Bypass or Brake in DJI Fly. Note: obstacle avoidance is disabled in Sport mode.	The aircraft will bypass obstacles regardless of the flight modes or obstacle avoidance action settings in DJI Fly when the vision systems are working normally.	

ActiveTrack 5.0

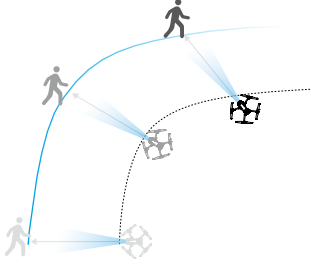
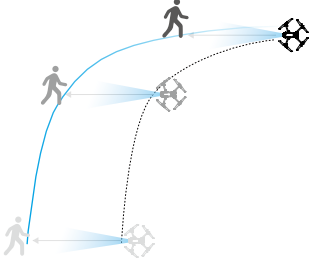
Trace	Parallel
<p>After setting the tracking direction (the default direction is Back), the aircraft tracks the subject as its moving direction, and the orientation towards the subject keeps constant as the tracking direction.</p> 	<p>The aircraft tracks the subject at a constant angle and distance from the side as the tracking starts.</p> 

- ⚠ • In Trace mode, the direction setting is only available when the subject is moving in a stable direction. The direction of tracking can be adjusted during tracking.

In ActiveTrack, the supported follow ranges of the aircraft and subject are as follows:

Subject	People		Vehicles/Boats	
Camera	Hasselblad Camera	Medium Tele Camera	Hasselblad Camera	Medium Tele Camera
Distance	4-20 m (Optimal: 5-10 m)	7-20 m	6-100 m (Optimal: 20-50 m)	16-100 m
Altitude	2-20 m (Optimal: 2-10 m)		6-100 m (Optimal: 10-50 m)	

- ⚠ • The aircraft will fly to the supported distance and altitude range if the distance and altitude is out of range when ActiveTrack begins. Fly the aircraft at the optimal distance and altitude for the best performance.

Using FocusTrack

1. Takeoff.

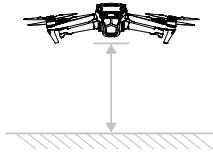

2. Drag-select the subject in the camera view, or enable Subject Scanning under Control settings in DJI Fly and tap the recognized subject to enable FocusTrack.

- ☀️ • FocusTrack must be used within the supported zoom ratio as follows, otherwise it will affect subject recognition:
 - a. Spotlight/Point of Interest: supports moving subjects such as vehicles, boats, people, and stationary subjects up to 7x zoom. The tele camera only supports stationary subjects.
 - b. ActiveTrack: supports moving subjects such as vehicles, boats, and people up to 3x zoom.
- a. The aircraft will enter Spotlight by default.

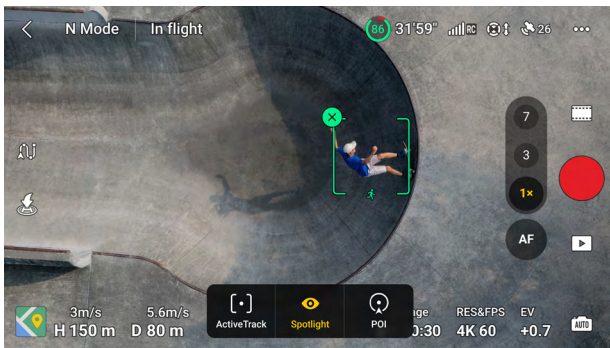

- b. Tap on the bottom of the screen to switch to Point of Interest. After setting the direction and speed, tap **GO** to start flying.

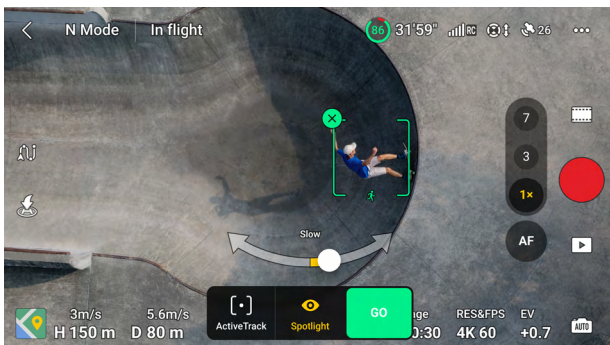

- c. Tap on the bottom of the screen to switch to ActiveTrack. In Trace mode, the tracking direction can be changed using the direction wheel (Front, Back, Left, Right, Front Diagonal Left, Front Diagonal Right, Back Diagonal Left, and Back Diagonal Right). The direction wheel will be minimized if there is no operation for an extended period or any other area of the screen is tapped.

Swipe the mode icon left or right to switch between Trace or Parallel once the direction wheel is minimized. The tracking direction will be reset to back once Trace is selected again. Tap **GO** to start tracking.



- 3. Tap the shutter/record button to take photos or start recording. View the footage in Playback .

Exiting FocusTrack

In Point of Interest or ActiveTrack, press the Flight Pause button once on the remote controller or tap **Stop** on the screen to return to return to Spotlight.

In Spotlight, press the Flight Pause button once on the remote controller to exit FocusTrack.

-  • DO NOT use FocusTrack in areas with people and animals running or vehicles moving.
- DO NOT use FocusTrack in areas with small or fine objects (e.g., tree branches or power lines), or transparent objects (e.g., water or glass).
- Operate the aircraft manually. In an emergency, press the Flight Pause button or tap Stop in DJI Fly.
- Be extra vigilant when using FocusTrack in any of the following situations:
 - a. The tracked subject is not moving on a level plane.
 - b. The tracked subject changes shape drastically while moving.
 - c. The tracked subject is out of sight for an extended period.
 - d. The tracked subject is moving on a snowy surface.
 - e. The tracked subject has a similar color or pattern to its surrounding environment.
 - f. The lighting is extremely low (<300 lux) or high (>10,000 lux).
- Make sure to follow local privacy laws and regulations when using FocusTrack.
- It is recommended to only track vehicles, boats, and people. Fly with caution when tracking other subjects.

- In supported moving subjects, vehicles and boats refer to cars and small to medium-sized yachts. DO NOT track a remotely controlled model car or boat.
- The tracking subject may inadvertently swap to another subject if they pass by each other.
- FocusTrack is disabled in Explore mode, or when recording in 5.1K and 120fps and above, and Apple ProRes 422HQ/422/422LT.
- When lighting is insufficient and the vision systems are unavailable, Spotlight and POI can still be used for static subjects, but obstacle sensing will be unavailable. ActiveTrack can not be used.
- FocusTrack is unavailable when the aircraft is on the ground.
- FocusTrack may not function properly when the aircraft is flying near flight limits or in a GEO Zone.

MasterShots

MasterShots keeps the subject at the center of the frame while executing different maneuvers in sequence to generate a short cinematic video.

Using MasterShots

1. Launch the aircraft and make it hover at least 2 m (6.6 ft) above ground.

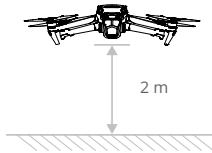

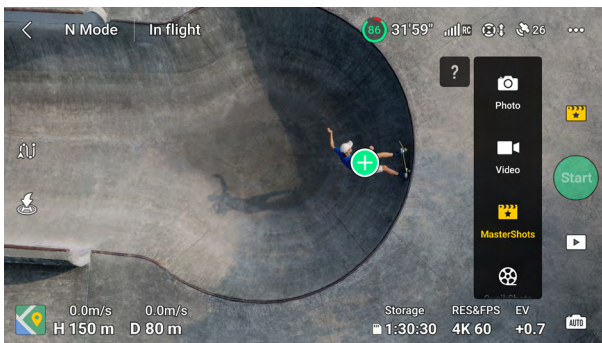

2. In DJI Fly, tap the shooting mode icon to select MasterShots and read the instructions. Make sure you understand how to use the shooting mode and there are no obstacles in the surrounding area.
3. Drag-select your target subject in the camera view, set the flight range. Tap **Start** to begin recording. The aircraft will fly back to its original position once shooting is finished.



4. Tap  to access, edit, or share the video to social media.







Exiting MasterShots

Press the flight pause button once or tap  in DJI Fly to exit MasterShots. The aircraft will brake and hover.

-
-  • Use MasterShots at locations that are clear of buildings and other obstacles. Make sure there are no humans, animals, or other obstacles in the flight path. When the lighting is sufficient and the environment is suitable for vision systems, the aircraft will brake and hover in place if there is an obstacle detected.
 - Pay attention to objects around the aircraft and use the remote controller to avoid collisions with the aircraft.
 - DO NOT use MasterShots in any of the following situations:
 - a. When the subject is blocked for an extended period or outside the line of sight.
 - b. When the subject is similar in color or pattern with the surroundings.
 - c. When the subject is in the air.
 - d. When the subject is moving fast.
 - e. When the lighting is extremely low (<300 lux) or high (>10,000 lux).
 - DO NOT use MasterShots in places close to buildings or where the GNSS signal is weak, otherwise the flight path may become unstable.
 - Make sure to follow local privacy laws and regulations when using MasterShots.
-

QuickShots

QuickShots shooting modes include Dronie, Rocket, Circle, Helix, Boomerang, and Asteroid. The aircraft records according to the selected shooting mode and automatically generates a short video. The video can be viewed, edited, or shared to social media from playback.

-  **Dronie:** The aircraft flies backward and ascends with the camera locked on the subject.
-  **Rocket:** The aircraft ascends with the camera pointing downward.
-  **Circle:** The aircraft circles around the subject.
-  **Helix:** The aircraft ascends and spirals around the subject.
-  **Boomerang:** The aircraft flies around the subject in an oval path, ascending as it flies away from its starting point and descending as it flies backward. The starting point of the aircraft forms one end of the long axis of the oval, while the other end is at the opposite side of the subject from the starting point.
-  **Asteroid:** The aircraft flies backward and upward, takes several photos, and then flies back to the starting point. The video generated starts with a panorama of the highest position and then shows the view from the aircraft as it descends.

-
-  • Make sure there is sufficient space when using Boomerang. Allow a radius of at least 30 m (99 ft) around the aircraft and a space of at least 10 m (33 ft) above the aircraft.
 - Make sure there is sufficient space when using Asteroid. Allow at least 40 m (131 ft) behind and 50 m (164 ft) above the aircraft.
-

Using QuickShots

1. Launch the aircraft and make it hover at least 2 m (6.6 ft) above ground.

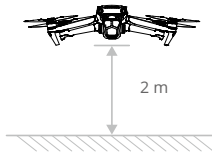

2. In DJI Fly, tap the shooting mode icon to select QuickShots and follow the prompts. Make sure you understand how to use the shooting mode and there are no obstacles in the surrounding area.
3. Choose a shooting mode, drag-select your target subject in the camera view, and tap **Start** to begin recording. The aircraft will fly back to its original position once shooting is finished.

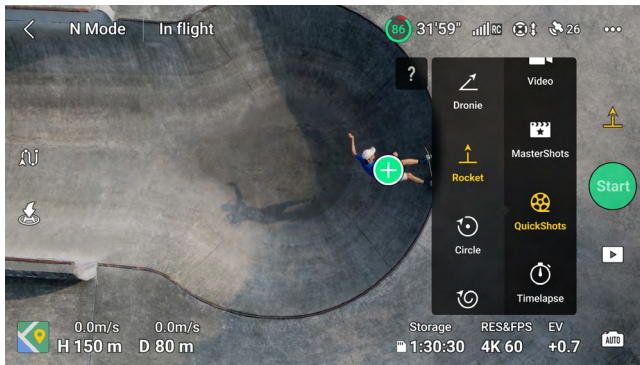

4. Tap  to access, edit, or share the video to social media.

Exiting QuickShots

Press the flight pause button once or tap  in DJI Fly to exit QuickShots. The aircraft will brake and hover. Tap the screen again and the aircraft will continue shooting.

Note: if you accidentally move a control stick, the aircraft will exit QuickShots and hover in place.

-  • Use QuickShots at locations that are clear of buildings and other obstacles. Make sure there are no humans, animals, or other obstacles in the flight path. When the lighting is sufficient and the environment is suitable for vision systems, the aircraft will brake and hover in place if there is an obstacle detected.
- Pay attention to objects around the aircraft and use the remote controller to avoid collisions with the aircraft.
- DO NOT use QuickShots in any of the following situations:
 - a. When the subject is blocked for an extended period or outside the line of sight.
 - b. When the subject is more than 50 m away from the aircraft.

- c. When the subject is similar in color or pattern with the surroundings.
- d. When the subject is in the air.
- e. When the subject is moving fast.
- f. When the lighting is extremely low (<300 lux) or high (>10,000 lux).
- DO NOT use QuickShots in places close to buildings or where the GNSS signal is weak, otherwise the flight path will become unstable.
- Make sure to follow local privacy laws and regulations when using QuickShots.

Hyperlapse

Hyperlapse shooting modes include Free, Circle, Course Lock, and Waypoint.

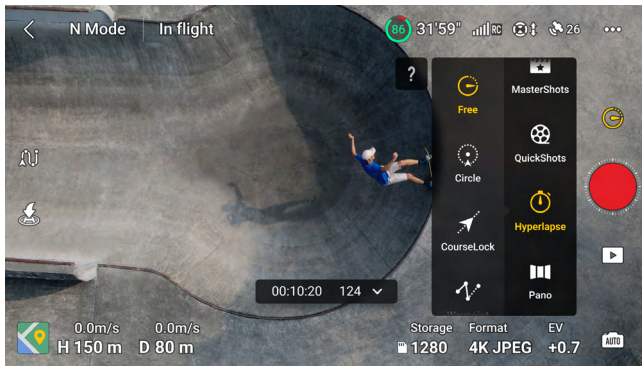

Free

The aircraft automatically takes photos and generates a timelapse video. Free mode can be used while the aircraft is on the ground. After takeoff, control the aircraft's movements and gimbal angle using the remote controller.

Follow the steps below to use Free:

1. Set the interval time, video duration, and max speed. The screen displays the number of photos that will be taken and the shooting duration.
2. Tap the shutter/record button to begin.

Circle

The aircraft automatically takes photos while flying around the selected subject to generate a timelapse video.

Follow the steps below to use Circle:

1. Set the interval time, video duration, and max speed. Circle can be set to either the clockwise or counter-clockwise direction. The screen displays the number of photos that will be taken and the shooting duration.

2. Drag-select a subject on the screen. Use the yaw stick and gimbal dial to adjust the frame.
3. Tap the shutter/record button to begin.

Course Lock

Course Lock allows the user to fix the flight direction. When using Course Lock, the user may either select an object so that the camera will always face the subject or not select an object so that the user can control the aircraft orientation and gimbal.

Follow the steps below to operate Course Lock:

1. Set the interval time, video duration, and speed. The screen displays the number of photos that will be taken and the shooting duration.
2. Set a flight direction.
3. If applicable, drag-select a subject. After selecting the subject, the aircraft will automatically control the orientation or gimbal to center the subject. At this time, the frame cannot be adjusted manually.
4. Tap the shutter/record button to begin.

Waypoints

The aircraft automatically takes photos on a flight path of two to five waypoints and generates a timelapse video. The aircraft can fly in sequence from waypoints 1 to 5 or 5 to 1.

Follow the steps below to use Waypoints:

1. Set the desired waypoints and the lens direction.
2. Set the interval time and video duration. The screen displays the number of photos that will be taken and the shooting duration.
3. Tap the shutter/record button to begin.

The aircraft will generate a timelapse video automatically, which is viewable in playback. Users can select Photo Type in Settings > Camera page in DJI Fly.



- For optimal performance, it is recommended to use Hyperlapse at an altitude higher than 50 m and to set a difference of at least two seconds between the interval and shutter time.
- It is recommended to select a static subject (e.g., high-rise buildings, mountainous terrain) located at a safe distance from the aircraft (further than 15 m). DO NOT select a subject that is too near the aircraft.
- When the lighting is sufficient and the environment is suitable for the vision systems, the aircraft will brake and hover in place if an obstacle is detected during Hyperlapse. If the lighting becomes insufficient or the environment is not suitable for the vision systems during Hyperlapse, the aircraft will continue to shoot without obstacle avoidance. Fly with caution.
- The aircraft will only generate a video after at least 25 photos have been taken, which is the amount required to generate a one-second video. The video will be generated by default regardless of whether Hyperlapse concludes normally or the aircraft exits from the mode unexpectedly (such as when Low Battery RTH is triggered).

Waypoint Flight

Waypoint Flight enables the aircraft to capture images during a flight according to the waypoint flight route generated by the preset waypoints. Points of Interest (POI) can be linked to the waypoints. The heading will point toward the POI during flight. A waypoint flight route can be saved and repeated.

Using Waypoint Flight

1. Enable Waypoint Flight

Tap  on the left of the camera view in DJI Fly to enable Waypoint Flight.



2. Waypoint Settings

Pin Waypoint

Waypoints can be pinned via the map before take off.

Waypoints can be pinned via the following methods after take off, GNSS is required.

- Using the Remote Controller: press once on the C1 button to pin a waypoint.
- Using the Operation Panel: tap  on the operation panel to pin a waypoint.
- Using the Map: enter and tap on the map to pin a waypoint. The default altitude of a waypoint via the map is set to 50 m from the take-off point.

Tap and hold on a waypoint to move its position on the map.

-
-  It is recommended to pin waypoints when flying to the location for a more accurate and smoother imaging result.
 - The aircraft horizontal GNSS position, altitude from the take-off point, heading, and gimbal tilt will be recorded if the waypoint is pinned by the remote controller and operation panel.
 - Connect the remote controller to the internet and download the map before using the map to pin a waypoint. When the waypoint is pinned via the map, only the aircraft horizontal GNSS position can be recorded.

-
-  The flight route will curve between waypoints, and the aircraft altitude may decrease during the flight route. Make sure to avoid any obstacles below when setting a waypoint.

Settings

Tap the waypoint number for settings, the waypoint parameters are described as follows:

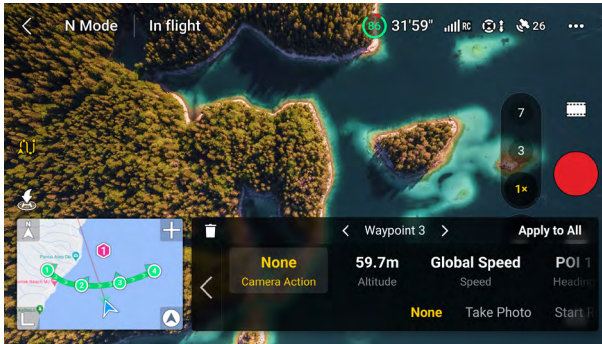

Camera Action	The camera action at the waypoint. Choose between None, Take Photo, and Start or Stop Recording.
Altitude	The altitude at the waypoint from the take-off point. Ensure to take off at the same take-off altitude to obtain better performance when a Waypoint Flight is repeated.
Speed	The flight speed at the waypoint. <ul style="list-style-type: none"> Global Speed: the aircraft will fly at the same speed during the waypoint flight route. Custom: the aircraft will accelerate or decelerate at a steady speed when flying between waypoints. The preset speed will be reached when the aircraft is at the waypoint.
Heading	The aircraft heading at the waypoint. <ul style="list-style-type: none"> Follow Course: the heading of the aircraft at a horizontal tangent to the flight route. POI*: tap the number of the POI to point the aircraft heading toward the POI. Manual: the aircraft heading can be adjusted by the user during a Waypoint Flight. Custom: drag the bar to adjust the heading. The heading can be previewed in the map view.
Gimbal Tilt	The gimbal tilt at the waypoint. <ul style="list-style-type: none"> POI*: tap the POI number to point the camera toward the specific POI. Manual: the gimbal tilt can be adjusted by the user during a Waypoint Flight. Custom: drag the bar to adjust the tilt of the gimbal.
Zoom	<ul style="list-style-type: none"> The camera zoom at the waypoint. Digital (1-3x): drag the bar to adjust the zoom ratio. Manual: the zoom ratio can be adjusted by the user during a Waypoint Flight. Auto: the zoom ratio will be adjusted by the aircraft when flying between two waypoints.

Hovering Time	The duration of the aircraft hovering time at the current waypoint.
---------------	---

* Before selecting POI for heading or gimbal tilt, make sure there are POIs in the flight route. If a POI is linked to a waypoint, the heading and gimbal tilt of the waypoint will be reset to toward the POI.

All the settings except camera action can be applied to all waypoints after selecting Apply to All. Tap  to delete the current selected waypoint.

3. POI Settings

Tap POI on the operation panel to switch to POI settings. Use the same method to pin a POI as used with a waypoint.



Tap the number of the POI to set the altitude of the POI, the POI can be linked to a waypoint. Multiple waypoints can be linked to the same POI, the camera will point toward the POI during the Waypoint Flight.

4. Plan a Waypoint Flight

Tap  or Next to set parameters for the flight route such as Global Speed, the behavior of End of Flight, On Signal Lost, and Start Point. The settings apply to all waypoints.

Global Speed	The flight speed during the entire flight route. After setting, the speed of all waypoints will be set to this speed.
End of Flight	The behavior of the aircraft after the flight task ends. It can be set to Hover, RTH, Land, or Back to Start.
On Signal Lost	The behavior of the aircraft when the remote controller signal is lost during flight. It can be set to RTH, Hover, Land, or Continue.
Start Point	After selecting the start waypoint, the flight route will be started from this waypoint to the subsequent waypoints.

5. Perform a Waypoint Flight

-  • Check the Obstacle Avoidance Action settings in the Settings > Safety page of DJI Fly before performing the Waypoint Flight. When set to Bypass or Brake, the aircraft will brake and hover in place if an obstacle is detected during the Waypoint Flight. The aircraft cannot sense obstacles if the Obstacle Avoidance Action is disabled. Fly with caution.
 - Observe the environment and ensure there are no obstacles on the route before performing Waypoint Flight.
 - Make sure to maintain visual line of sight (VLOS) with the aircraft. Press the flight pause button in an emergency situation.
-
-  • When the signal is lost during flight, the aircraft will perform the action set in On Signal Lost.
 - When the Waypoint Flight is finished, the aircraft will perform the action set in End of Flight.

- a. Tap **GO** to upload the waypoint flight task. Tap **⏏** to cancel the uploading process and return to the waypoint flight parameter settings.
 - b. The waypoint flight task will be performed after being uploaded, the flight duration, waypoints, and distance and will be displayed on the camera view. The control stick input will change the flight speed during a Waypoint Flight.
 - c. Tap **⏏** to pause the Waypoint Flight after the task begins. Tap **▶** to continue the Waypoint Flight. Tap **✕** to stop Waypoint Flight and return to the waypoint flight edit status.
6. Library

When planning a Waypoint Flight, the task will be generated automatically and saved every minute. Tap **☰** on the left to enter Library and save the task manually.

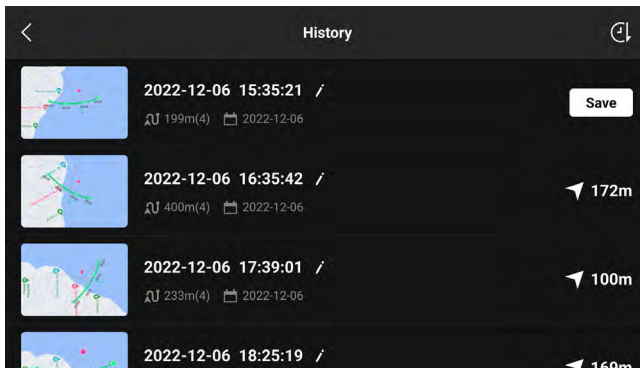

- In the flight route library, users can check the saved tasks, and tap to open or edit a task.
- Tap **/** to edit the name of the task.
- Slide left to delete a task.
- Tap the icon on the top right corner to change the order of the tasks.
 - 🕒 : tasks will be sorted by the time.
 - 📄 : tasks will be sorted by the distance between the start waypoint and the current position of the aircraft from shortest to farthest.

7. Exit Waypoint Flight

Tap **⏏** to exit Waypoint Flight. Tap **Save** and **Exit** to save the task to Library and exit.

Cruise Control

The cruise control function enables the aircraft to lock the current control stick input of the remote controller when conditions permit. Fly at the speed corresponding to the current control stick input without continually using control stick movements. The cruise control feature also supports aircraft movements such as spiraling up by increasing the control stick input.

Using Cruise Control

1. Set the Cruise Control Button

Go to DJI Fly, select Settings > Control > Button Customization, and then set the C1, C2 or C3 button to Cruise Control.

2. Enter Cruise Control

- Press the Cruise Control button while pushing the control stick, then the aircraft will fly at the current speed according to the control stick input. Once Cruise Control is set, the control stick can be released and will automatically return to the center.
- Before the control stick returns to the center, press the Cruise Control button again to reset the flight speed based on the current control stick input.
- Push the control stick after it returns to the center, the aircraft will fly at the increased speed based on the previous speed. In this case, press the Cruise Control button again, and the aircraft will fly at the increased speed.

3. Exit Cruise Control

Press the Cruise Control button without a control stick input, press the flight pause button on the remote controller, or tap  on the screen to exit cruise control. The aircraft will brake and hover.



- Cruise control is available in Normal, Cine, and Sport mode or APAS, Free Hyperlapse, and FocusTrack.
 - Cruise control cannot be started without a control stick input.
 - The aircraft cannot enter or will exit Cruise Control in the following situations:
 - a. When near the max altitude or max distance.
 - b. When the aircraft disconnects from the remote controller or DJI Fly.
 - c. When the aircraft senses an obstacle and will hover in place.
 - d. During RTH or auto landing.
 - Cruise control will exit automatically when switching flight modes.
 - The obstacle sensing in Cruise Control follows the current flight mode. Fly with caution.
-

Aircraft

DJI Mavic 3 Pro contains a flight controller, video downlink system, vision systems, infrared sensing system, propulsion system, and an Intelligent Flight Battery.

Aircraft

DJI Mavic 3 Pro contains a flight controller, video downlink system, vision systems, infrared sensing system, propulsion system, and an Intelligent Flight Battery.

Flight Modes

DJI Mavic 3 Pro supports the following flight modes. The flight modes can be switched via the Flight Mode switch on the remote controller.

Normal Mode

The aircraft utilizes GNSS, the Horizontal, Upward, and Downward Vision Systems, and the Infrared Sensing System to locate and stabilize itself. When the GNSS signal is strong, the aircraft uses GNSS to locate and stabilize itself. When the GNSS is weak, but the lighting and other environmental conditions are sufficient, it uses the vision systems. When the vision systems are enabled, and lighting and other environmental conditions are sufficient, the maximum tilt angle is 30° and the maximum flight speed is 15 m/s.

Sport Mode

In Sport Mode, the aircraft uses GNSS for positioning and the aircraft responses are optimized for agility and speed, making it more responsive to control stick movements. Note: Obstacle Avoidance is disabled and the maximum flight speed is 21 m/s.

Cine Mode

Cine mode is based on Normal mode with a limited flight speed, making the aircraft more stable during shooting.

If the aircraft is flying in the EU, the aircraft will switch to Low Speed mode when the flight mode is switched to C on the remote controller. Low Speed mode limits the maximum horizontal flight speed to 2.8 m/s based on Normal mode, and there is no limit for the ascent or descent speed.

The aircraft automatically changes to Attitude (ATTI) mode when the vision systems are unavailable or disabled and when the GNSS signal is weak or the compass experiences interference. In ATTI mode, the aircraft may be more easily affected by its surroundings. Environmental factors such as wind can result in horizontal shifting, which may present hazards, especially when flying in confined spaces. The aircraft will not be able to hover or brake automatically. Therefore the pilot should land the aircraft as soon as possible to avoid accidents.



• The flight modes are only valid for manual flight and cruise control.



- The vision systems are disabled in Sport mode, which means the aircraft cannot sense obstacles on its route automatically. The user must stay alert to the surrounding environment and control the aircraft to avoid obstacles.
- The maximum speed and braking distance of the aircraft significantly increase in Sport mode. A minimum braking distance of 30 m is required in windless conditions.

- A minimum braking distance of 10 m is required in windless conditions while the aircraft is ascending and descending in Sport mode or Normal mode.
- The responsiveness of the aircraft significantly increases in Sport mode, which means a small control stick movement on the remote controller translates into the aircraft moving a large distance. Make sure to maintain adequate maneuvering space during flight.

Aircraft Status Indicators

DJI Mavic 3 Pro has front LEDs and aircraft status indicators.

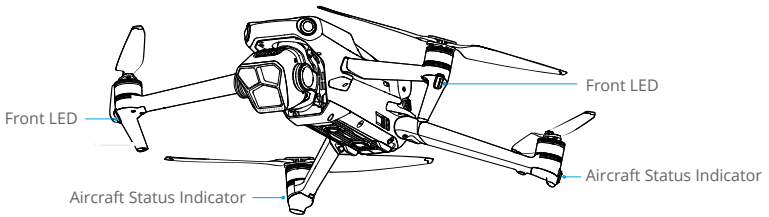

When the aircraft is powered on but the motors are not running, the front LEDs glow solid red to display the orientation of the aircraft.

When the aircraft is powered on, but the motors are not running, the aircraft status indicators will display the current status of the flight control system. Refer to the table below for more information about the aircraft status indicators.

Aircraft Status Indicators Descriptions

Normal States

	Blinks red, yellow, and green alternately	Powering on and performing self-diagnostic tests
	Blinks yellow four times	Warning up
	Blinks green slowly	GNSS enabled
	Blinks green twice repeatedly	Vision systems enabled
	Blinks yellow slowly	GNSS and vision systems disabled (ATTI mode enabled)

Warning States

	Blinks yellow quickly	Remote controller signal lost
	Blinks red slowly	Takeoff is disabled, e.g. low battery*
	Blinks red quickly	Critically low battery
	Solid red	Critical error
	Blinks red and yellow alternately	Compass calibration required



* If the aircraft cannot takeoff while the status indicators are blinking red slowly, launch DJI Fly on the remote controller to view the details.

After the motors start, the front LEDs blink red and green alternately, and the aircraft status indicators blink green. The green lights indicate the aircraft is a UAV and the red lights indicate the heading and position of the aircraft.



- ⚠ • To obtain better footage, the front LEDs turn off automatically when shooting if the front LEDs are set to auto in DJI Fly. Lighting requirements vary depending on the region. Observe local laws and regulations.

Return to Home

Return to Home (RTH) brings the aircraft back to the last recorded Home Point when the positioning system is functioning normally. There are three types of RTH: Smart RTH, Low Battery RTH, and Failsafe RTH. The aircraft automatically flies back to the Home Point and lands when Smart RTH is initiated, the aircraft enters Low Battery RTH, or the signal between the remote controller and the aircraft is lost during flight.

	GNSS	Description
Home Point	 10	<p>The first location where the aircraft receives a strong to moderately strong GNSS signal (indicated by a white icon) will be recorded as the default Home Point. The Home Point can be updated before takeoff as long as the aircraft receives another strong to moderately strong GNSS signal. If the signal is weak, the Home Point will not be updated. After the Home Point is recorded, a prompt will appear in DJI Fly.</p> <p>If it is necessary to update the Home Point during a flight (such as where the position of the user has changed), the Home Point can be manually updated in Settings > Safety page in DJI Fly.</p>

Smart RTH

If the GNSS signal is sufficiently strong, Smart RTH can be used to bring the aircraft back to the Home Point. Smart RTH is initiated either by tapping  in DJI Fly or by pressing and holding the RTH button on the remote controller until it beeps. Exit Smart RTH by tapping  in DJI Fly or by pressing the RTH button on the remote controller. After exiting RTH, users will regain control of the aircraft.

Advanced RTH

Advanced RTH is enabled if the lighting is sufficient and the environment is suitable for vision systems when Smart RTH is triggered. The aircraft will automatically plan the best RTH path, which will be displayed in DJI Fly and will adjust according to the environment.

RTH Settings

RTH settings are available for Advanced RTH. Go to the camera view in DJI Fly, tap System > Safety, and then RTH.

- Optimal: regardless of the RTH Altitude settings, the aircraft automatically plans the optimal RTH path and adjusts the altitude according to environmental factors such as obstacles

and transmission signals. The optimal RTH path means the aircraft will travel the shortest distance possible, reducing the amount of battery power used and increasing flight time.



2. **Preset:** if the aircraft is further than 50 m from the Home Point when RTH begins, the aircraft will plan the RTH path, fly to an open area while avoiding obstacles, ascend to the RTH Altitude, and return to home using the best path.

When the aircraft is at a distance of 5 to 50 m from the home point when RTH begins, the aircraft will not ascend to the RTH Altitude and instead return to home using the best path at the current altitude.

When the aircraft is near the Home Point, the aircraft will descend while flying forward if the current altitude is higher than the RTH Altitude.



Advanced RTH Procedure

1. The Home Point is recorded.
2. Advanced RTH is triggered.
3. The aircraft brakes and hover in place.
 - a. The aircraft lands immediately if it is less than 5 m from the Home Point when RTH begins.
 - b. If the aircraft is farther than 5 m from the home point when RTH begins, the aircraft will plan the best path according to the RTH settings and fly to the Home Point while sensing obstacles and avoiding GEO zones. The aircraft front will always point in the same direction as the flight direction.
4. The aircraft will fly automatically according to the RTH settings, environment, and transmission signal during RTH.
5. The aircraft lands and the motors stop after reaching the Home Point.

Straight Line RTH

The aircraft will enter Straight Line RTH when the lighting is not sufficient and the environment is not suitable for Advanced RTH.

Straight Line RTH Procedure:

1. The Home Point is recorded.
2. Straight Line RTH is triggered.
3. The aircraft brakes and hover in place.
 - a. If the aircraft is farther than 50 m from the Home Point when RTH begins, the aircraft first ascends to a height of 20 m (this step is skipped if the current height is higher than 20 m), then the aircraft adjusts its orientation and ascends to the preset RTH altitude and flies to the Home Point. If the current altitude is higher than the RTH altitude, the aircraft will fly to the Home Point at the current altitude.
 - b. If the aircraft is at a distance of 5 to 50 m from the Home Point when RTH begins, the aircraft adjusts its orientation and flies to the Home Point at the current altitude. If the current altitude is lower than 2 m when RTH begins, the aircraft will ascend to 2 m and flies back to the Home Point.
 - c. The aircraft lands immediately if it is less than 5 m from the Home Point when RTH begins.
4. The aircraft lands and the motors stop after reaching the Home Point.

-
-  • During Advanced RTH, the aircraft will adjust the flight speed automatically to suit environmental factors such as wind speed and obstacles.
- The aircraft cannot avoid small or fine objects such as tree branches or power lines. Fly the aircraft to an open area before using Smart RTH.
 - Set Advanced RTH as Preset if there are power lines or towers that the aircraft cannot avoid on the RTH path and make sure the RTH Altitude is set higher than all obstacles.
 - The aircraft will brake and return to home according to the latest settings if the RTH settings are changed during RTH.
 - If the max altitude is set below the current altitude during RTH, the aircraft will descend to the max altitude and return to home.
 - The RTH Altitude cannot be changed during RTH.
 - If there is a large difference in the current altitude and the RTH altitude, the amount of battery power used cannot be calculated accurately due to wind speeds at different altitudes. Pay extra attention to the battery power and warning prompts in DJI Fly.
 - Advanced RTH will not be available if the lighting condition and environment are not suitable for vision systems during takeoff or RTH.
 - During Advanced RTH, the aircraft will enter Straight Line RTH if the lighting condition and environment are not suitable for vision systems and the aircraft cannot sense obstacles. An appropriate RTH altitude must be set before entering RTH.

- When the remote controller signal is normal during Advanced RTH, the pitch stick can be used to control the flight speed, but the orientation and altitude cannot be controlled and the aircraft cannot be flown left or right. Acceleration uses more power. The aircraft cannot sense obstacles if the flight speed exceeds the effective sensing speed. The aircraft will brake and hover in place and exit from RTH if the pitch stick is pulled all the way down. The aircraft can be controlled after the pitch stick is released.
 - If the home point is in the Altitude Zones while the aircraft is outside, the advanced RTH will fly the aircraft below the altitude limit, which may be lower than the set RTH altitude. Fly with caution.
 - When the remote controller signal is normal during Straight Line RTH, the flight speed and altitude can be controlled using the remote controller, but the orientation of the aircraft cannot be controlled and the aircraft cannot be flown left or right. The aircraft cannot sense obstacles if the pitch stick is used to accelerate and the flight speed exceeds the effective sensing speed. When the aircraft is ascending or flying forward, push the control stick in the opposite direction to exit RTH. Release the control stick to regain control of the aircraft.
 - If the aircraft reaches the max altitude while it is ascending during RTH, the aircraft stops and returns to the Home Point at the current altitude.
 - The aircraft will hover in place if it reaches the max altitude while it is ascending after detecting obstacles in front of the aircraft.
-

Low Battery RTH

When the Intelligent Flight Battery level is too low and there is not enough power to return home, land the aircraft as soon as possible.

To avoid unnecessary danger caused by insufficient power, the aircraft automatically calculates if the battery power is sufficient to return to the Home Point according to the current position, environment, and flight speed. A warning prompt will appear in DJI Fly when the battery level is low and only enough to complete an RTH flight. The aircraft will automatically fly to the Home Point if no action is taken after a 10-second countdown.

The user can cancel RTH by pressing the RTH button on the remote controller. A low battery level warning will be prompted only once during a flight. If RTH is canceled following the warning, the Intelligent Battery may not have enough power for the aircraft to land safely, which may lead to the aircraft crashing or being lost.

The aircraft will land automatically if the current battery level can only support the aircraft long enough to descend from its current altitude. Auto landing cannot be canceled, but the remote controller can be used to alter the horizontal movement and the speed of descent of the aircraft during landing. If there is sufficient power, the throttle stick can be used to make the aircraft ascend at a speed of 1 m/s.

During auto landing, move the aircraft horizontally to find an appropriate place to land as soon as possible. The aircraft will fall if the user keeps pushing the throttle stick upward until the power is depleted.

Failsafe RTH

The action of the aircraft when the remote controller signal is lost can be set to RTH, land, or hover in Setting > Safety > Advanced Safety Settings in DJI Fly. If the Home Point was successfully recorded and the compass is functioning normally, Failsafe RTH automatically activates after the remote controller signal is lost for more than six seconds.

When the lighting is sufficient and the vision systems are working normally, DJI Fly will display the RTH path that was generated by the aircraft before the remote controller signal was lost using Advanced RTH according to the RTH settings. The aircraft will remain in RTH even if the remote controller signal is restored. DJI Fly will update the RTH path accordingly.

When the lighting is not sufficient and the vision systems are not available, the aircraft will enter Original Route RTH.

Original Route RTH Procedure:

1. The aircraft brakes and hover in place.
2.
 - a. If the aircraft is farther than 50 m from the Home Point, the aircraft adjusts its orientation and flies backward for 50 m on its original flight route before entering Straight Line RTH.
 - b. If the aircraft is farther than 5 m but less than 50 m from the Home Point, it enters Straight Line RTH.
 - c. The aircraft lands immediately if it is less than 5 m from the Home Point when RTH begins.
3. The aircraft lands and the motors stop after reaching the Home Point.

The aircraft will enter or remain in Straight Line RTH if the remote controller signal is restored during RTH.



- If the RTH is triggered through DJI Fly and the aircraft is farther than 5 m from the Home Point, a prompt will appear in the app to select a landing option.
 - The aircraft may not be able to return to the Home Point normally if the GNSS signal is weak or unavailable. The aircraft may enter ATTI mode if the GNSS signal becomes weak or unavailable after entering Failsafe RTH. The aircraft will hover in place for a while before landing.
 - It is important to set a suitable RTH altitude before each flight. Launch DJI Fly and set the RTH altitude. The default RTH altitude is 100 m.
 - The aircraft cannot sense obstacles during Failsafe RTH if the vision systems are unavailable.
 - GEO zones may affect the RTH. Avoid flying near GEO zones.
 - The aircraft may not be able to return to the Home Point when the wind speed is too high. Fly with caution.
 - Be aware of small or fine objects (such as tree branches or power lines) or transparent objects (such as water or glass) during RTH. Exit RTH and control the aircraft manually in an emergency.
 - RTH may not be available in some environments even if the vision systems are working. The aircraft will exit RTH in such cases.
-

Landing Protection

If the user triggers RTH or auto landing using the remote controller or the app, Landing Protection will activate during Smart RTH.

Landing Protection is enabled once the aircraft begins to land.

1. During Landing Protection, the aircraft will automatically detect and carefully land on suitable ground.
2. If the ground is determined unsuitable for landing, the aircraft will hover and wait for pilot confirmation.
3. If Landing Protection is not operational, DJI Fly will display a landing prompt when the aircraft descends to 0.5 m from the ground. Tap confirm or push the throttle stick all the way down and hold for one second, and the aircraft will land.

Precision Landing

The aircraft automatically scans and attempts to match the terrain features below during RTH. The aircraft will land when the current terrain matches the Home Point. A prompt will appear in DJI Fly if the terrain match fails.

-
- ⚠ • Landing Protection is activated during Precision Landing.
 - The performance of Precision Landing is subject to the following conditions:
 - a. The Home Point must be recorded upon takeoff and must not be changed during flight. Otherwise, the aircraft will have no record of the terrain features of the Home Point.
 - b. During takeoff, the aircraft must ascend at least 7 m before moving horizontally.
 - c. The Home Point terrain features must remain largely unchanged.
 - d. The terrain features of the Home Point must be sufficiently distinctive. Terrain such as a snow-covered field is not suitable.
 - e. The lighting conditions must not be too light or too dark.
 - The following actions are available during Precision Landing:
 - a. Press the throttle stick down to accelerate landing.
 - b. Move the control sticks in any direction apart from the throttle direction to stop Precision Landing. The aircraft will descend vertically after the control sticks are released.
-

Vision Systems and Infrared Sensing System

DJI Mavic 3 Pro is equipped with both an infrared sensing system and horizontal, upward, and downward vision systems.

The upward and downward vision systems consist of two cameras each, and the forward, backward, and lateral vision systems consist of four cameras in total.

The infrared sensing system consists of two 3D infrared modules. The downward vision system and infrared sensing system help the aircraft maintain its current position, hover more precisely, and fly indoors or in other environments where GNSS is unavailable.

The auxiliary light located at the bottom of the aircraft can assist the downward vision system. It will automatically turn on by default in low-light environments when the flight altitude is under 5 m. Users can also turn it on or off manually in the DJI Fly app. Each time the aircraft is restarted, the auxiliary bottom light will revert back to the default setting Auto.

⚠ • The auxiliary LED is set to auto when used in the EU and cannot be changed. The aircraft Front Arm LEDs are always on when used in the EU and cannot be changed.

Horizontal Omnidirectional Vision System

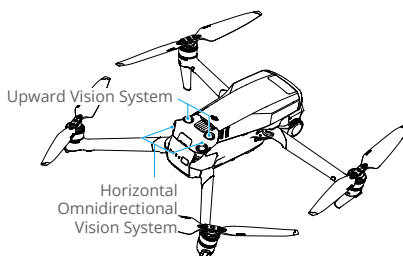
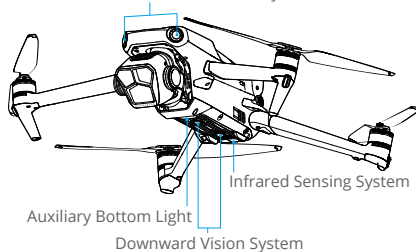

Detection Range

Forward Vision System	Precision Measurement Range: 0.5-20 m; FOV: 90° (horizontal), 103° (vertical)
Backward Vision System	Precision Measurement Range: 0.5-16 m; FOV: 90° (horizontal), 103° (vertical)
Lateral Vision System	Precision Measurement Range: 0.5-25 m; FOV: 90° (horizontal), 85° (vertical)
Upward Vision System	Precision Measurement Range: 0.2-10 m; FOV: 100° (front and back), 90° (left and right)
Downward Vision System	Precision Measurement Range: 0.3-18 m; FOV: 130° (front and back), 160° (left and right) The Downward Vision System works best when the aircraft is at an altitude of 0.5 to 30 m.

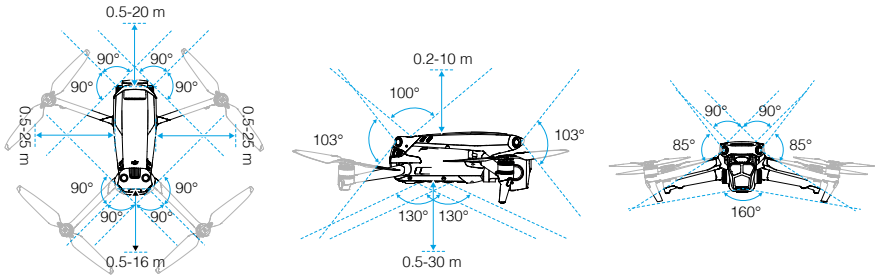

Using the Vision System

The positioning function of the downward vision system is applicable when GNSS signals are unavailable or weak. It is automatically enabled in Normal or Cine mode.

The horizontal and upward vision systems will activate automatically when the aircraft is in Normal or Cine mode and Obstacle Avoidance is set to Bypass or Brake in DJI Fly. The aircraft can actively brake when detecting obstacles when using the horizontal and upward vision systems. The horizontal and upward vision systems work best with adequate lighting and clearly marked or textured obstacles. Due to inertia, users must make sure the aircraft brakes within a reasonable distance.

- ⚠️ • Pay attention to the flight environment. The vision systems and infrared sensing system only work in certain scenarios and cannot replace human control and judgment. During a flight, always pay attention to the surrounding environment and the warnings on DJI Fly, and be responsible for and maintain control of the aircraft at all times.
- The downward vision system works best when the aircraft is at an altitude from 0.5 to 30 m if there is no GNSS available. Extra caution is required if the altitude of the aircraft is above 30 m as the vision positioning performance may be affected.
- In low-light environments, the vision systems may not achieve optimal positioning performance even if the auxiliary bottom light is turned on. Fly with caution if the GNSS signal is weak in such environments.
- The downward vision system may not work properly when the aircraft is flying near water. Therefore, the aircraft may not be able to actively avoid water below it when landing. It is recommended to maintain flight control at all times, make reasonable judgments based on the surrounding environment, and avoid over-relying on the downward vision system.
- The vision system cannot work properly near surfaces without clear pattern variations or where the light is too weak or too strong. The vision system cannot work properly in the following situations:
 - a. Flying near monochrome surfaces (e.g., pure black, white, red, or green).
 - b. Flying near highly reflective surfaces.
 - c. Flying near water or transparent surfaces.
 - d. Flying near moving surfaces or objects.

- e. Flying in an area with frequent and drastic lighting changes.
 - f. Flying near extremely dark (< 10 lux) or bright (> 40,000 lux) surfaces.
 - g. Flying near surfaces that strongly reflect or absorb infrared waves (e.g., mirrors).
 - h. Flying near surfaces without clear patterns or textures.
 - i. Flying near surfaces with repeating identical patterns or textures (e.g., tiles with the same design).
 - j. Flying near obstacles with small surface areas (e.g., tree branches).
- Keep the sensors clean at all times. DO NOT scratch or tamper with the sensors. DO NOT use the aircraft in dusty or humid environments.
 - Vision system cameras may need to be calibrated after being stored for an extended period. A prompt will appear in DJI Fly and calibration will be performed automatically.
 - DO NOT fly when it is rainy, smoggy, or the visibility is lower than 100 m.
 - Check the following each time before takeoff:
 - a. Make sure there are no stickers or any other obstructions over the glass of the infrared sensing systems and vision systems.
 - b. Use soft cloth if there is any dirt, dust, or water on the glass of the vision systems and infrared sensing system. DO NOT use any cleaning product that contains alcohol.
 - c. Contact DJI Support if there is any damage to the lenses of the infrared sensing and vision systems.
 - DO NOT obstruct the infrared sensing system.
-

Advanced Pilot Assistance Systems (APAS 5.0)

The Advanced Pilot Assistance Systems 5.0 (APAS 5.0) feature is available in Normal mode and Cine mode. When APAS is enabled, the aircraft will continue to respond to user commands and plan its path according to both control stick inputs and the flight environment. APAS makes it easier to avoid obstacles, obtain smoother footage, and provide a better flying experience.

Keep moving the control sticks in any direction. The aircraft will avoid obstacles by flying above, below, or to the left or right of the obstacle. The aircraft can also respond to the control stick inputs while avoiding obstacles.

When APAS is enabled, the aircraft can be stopped by pressing the Flight Pause button on the remote controller. The aircraft brakes and hovers for three seconds and awaits further pilot commands.

To enable APAS, open DJI Fly, enter Settings > Safety, and enable APAS by selecting Bypass. Select Normal or Nifty mode when using Bypass. In Nifty mode, the aircraft can fly faster, smoother, and closer to obstacles obtaining better footage while avoiding obstacles. However, the risk of crashing into obstacles will increase. Fly with caution.

Nifty mode cannot work normally in the following situations:

1. When aircraft orientation changes rapidly flying near obstacles.
2. When flying through narrow obstacles such as canopies or bushes at high speed.
3. When flying near obstacles that are too small to detect.
4. When flying with the propeller guard.

Landing Protection

Landing Protection will activate if Obstacle Avoidance is set to Bypass or Brake and the user pulls the throttle stick down to land the aircraft. Landing Protection is enabled once the aircraft begins to land.

1. During Landing Protection, the aircraft will automatically detect if an area is suitable for landing, and then land the aircraft.
2. If the ground is determined to be unsuitable for landing, the aircraft will hover when the aircraft descends to 0.8 m above ground. Pull down on the throttle stick for at least five seconds, and the aircraft will land without obstacle sensing.



- Make sure to use APAS when the vision systems are available. Make sure there are no people, animals, objects with small surface areas (e.g., tree branches), or transparent objects (e.g., glass or water) along the desired flight path.
- Make sure to use APAS when the downward vision systems are available or the GNSS signal is strong. APAS may not function properly when the aircraft is flying over water or snow-covered areas.
- Be extra cautious when flying in extremely dark (<300 lux) or bright (>10,000 lux) environments.
- Pay attention to DJI Fly and make sure APAS is working normally.
- APAS may not function properly when the aircraft is flying near flight limits or in a GEO zone.

Flight Recorder

Flight data, including flight telemetry, aircraft status information, and other parameters, are automatically saved to the internal data recorder of the aircraft. The data can be accessed using DJI Assistant 2 (Consumer Drones Series).

Propellers

There are two types of DJI Mavic 3 Pro Quick-Release Propellers designed to spin in different directions. Marks are used to indicate which propellers should be attached to which motors. Make sure to match the propeller and motor following the instructions.

Attaching the propellers

Attach the propellers with marks to the motors with marks and the unmarked propellers to the motors without marks. Hold the motor, press the propeller down, and rotate in the direction marked on the propeller until it pops up and locks in place.

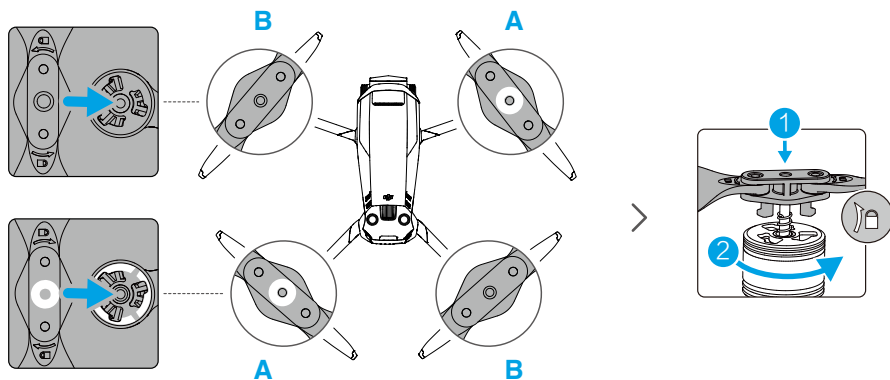

Detaching the propellers

Hold the motor, press the propeller down, and rotate in the opposite direction to the one marked on the propeller until it pops out.

- ⚠ • The propeller blades are sharp. Handle with care.
- Only use official DJI propellers. DO NOT mix propeller types.
- Propellers are consumable components. Purchase additional propellers if necessary.
- Make sure that the propellers and motors are installed securely before each flight.
- Make sure that all propellers are in good condition before each flight. DO NOT use aged, chipped, or broken propellers.
- To avoid injury, stay away from rotating propellers or motors.

- To avoid damaging the propellers, place the aircraft in the direction shown in the carrying case during transportation or storage. DO NOT squeeze or bend the propellers. If propellers are damaged, the flight performance may be affected.
- Make sure the motors are mounted securely and rotating smoothly. Land the aircraft immediately if a motor is stuck and unable to rotate freely.
- DO NOT attempt to modify the structure of the motors.
- DO NOT touch or let hands or body parts come in contact with the motors after flight, as they may be hot.
- DO NOT block any of the ventilation holes on the motors or the body of the aircraft.
- Make sure the ESCs sound normal when powered on.

Intelligent Flight Battery

The Mavic 3 Intelligent Flight Battery is a 15.4V, 5000mAh battery with smart charging and discharging functionality.

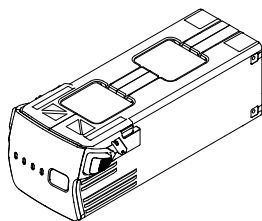

Battery Features

1. **Battery Level Display:** the battery level LEDs display the current battery level.
2. **Auto-Discharging Function:** to prevent swelling, the battery automatically discharges to 96% of the battery level when it is idle for three days, and automatically discharges to 60% of the battery level when it is idle for nine days. It is normal to feel moderate heat being emitted from the battery during the discharging process.
3. **Balanced Charging:** during charging, the voltages of the battery cells are automatically balanced.
4. **Overcharge Protection:** the battery stops charging automatically once fully charged.
5. **Temperature Detection:** to prevent damage, the battery only charges when the temperature is between 5° and 40° C (41° and 104° F).
6. **Overcurrent Protection:** the battery stops charging if an excess current is detected.
7. **Over-Discharge Protection:** discharging stops automatically to prevent excess discharge when the battery is not in use. Over-discharge protection is not enabled when the battery is in use.
8. **Short Circuit Protection:** the power supply is automatically cut if a short circuit is detected.
9. **Battery Cell Damage Protection:** the app will display a warning prompt when a damaged

battery cell is detected.

10. Hibernation Mode: the battery switches off after 20 minutes of inactivity to save power. If the battery level is less than 5%, the battery will enter Hibernation mode after six hours to prevent over-discharge. In Hibernation mode, the battery level indicators do not illuminate. Charge the battery to wake it from hibernation.
11. Communication: information about the voltage, capacity, and current of the battery is transmitted to the aircraft.

⚠ • Refer to the Safety Guidelines and the stickers on the battery before use. Users shall take full responsibility for all operations and usage.

Using the Battery

Checking the Battery Level

Press the power button once to check the battery level.

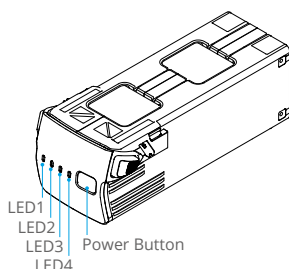

📖 The battery level LEDs display the power level of the battery during discharging. The statuses of the LEDs are defined below:

● : LED is on ● (with radiating lines) : LED is flashing ○ : LED is off

LED1	LED2	LED3	LED4	Battery Level
●	●	●	●	88%-100%
●	●	●	● (flashing)	76%-87%
●	●	●	○	63%-75%
●	●	● (flashing)	○	51%-62%
●	●	○	○	38%-50%
●	● (flashing)	○	○	26%-37%
●	○	○	○	13%-25%
● (flashing)	○	○	○	0%-12%

Powering On/Off

Press the power button once, then press again, and hold for two seconds to power the battery on or off. The battery level LEDs display the battery level when the aircraft is powered on.

Low-Temperature Notice

1. Battery capacity is significantly reduced when flying at low temperatures from -10° to 5° C (14° to 41° F). It is recommended to hover the aircraft in place for a while to heat the battery. Make sure to fully charge the battery before takeoff.
2. Batteries cannot be used in extremely low-temperature environments of lower than -10° C (14° F).
3. When in low-temperature environments, end the flight as soon as DJI Fly displays the low battery level warning.
4. To ensure optimal performance, keep the battery temperature above 20° C (68° F).
5. The reduced battery capacity in low-temperature environments reduces the wind speed resistance performance of the aircraft. Fly with caution.
6. Take extra caution when at high altitudes.

Charging the Battery

Fully charge the battery before each use. It is recommended to use the charging devices provided by DJI, such as the DJI 100W USB-C Power Adapter, DJI 65W Portable Charger, or other USB Power Delivery chargers.

Using A Charger

1. Connect the charger to an AC power supply (100-240V, 50/60 Hz; use a power cable with suitable specifications for charging, and use a power adapter if necessary).
2. Attach the aircraft to the charger using the battery charging cable with the battery powered off.
3. The battery level LEDs display the current battery level during charging.
4. The Intelligent Flight Battery is fully charged when all the battery level LEDs are off. Detach the charger when the battery is fully charged.

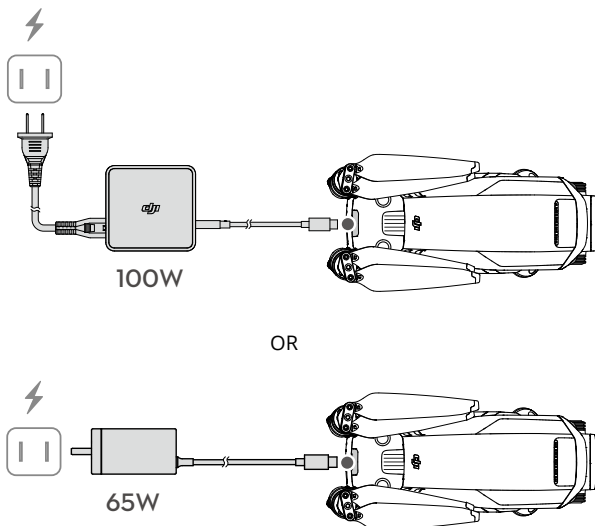

- ⚠ • DO NOT charge an Intelligent Flight Battery immediately after flight as it may be too hot. Wait for the battery to cool down to the operating temperature before charging again.
 - The charger stops charging the battery if the battery cell temperature is not within the operating range of 5° to 40° C (41° to 104° F). The ideal charging temperature is from 22° to 28° C (71.6° to 82.4° F).
 - Fully charge the battery at least once every three months to maintain battery health.
- 💡 • For safety purposes, keep the batteries at a low power level in transit. Before transportation, it is recommended to discharge the batteries to 30% or lower.

The table below shows the battery level during charging.

LED1	LED2	LED3	LED4	Battery Level
				0%-50%
				51%-75%
				76%-99%
				100%

Using the Charging Hub

DJI Mavic 3 Series 100W Battery Charging Hub is designed for use with Mavic 3 Intelligent Flight Batteries. When used with the DJI 100W USB-C Power Adapter, it can charge up to three Intelligent Flight Batteries in sequence from high to low power level. The charging time for one battery is approximately 1 hour and 10 minutes.

How to Charge

1. Insert the Intelligent Flight Battery into the battery port. Connect the charging hub to a power outlet (100-240 V, 50-60 Hz) using the DJI 100W USB-C Power Adapter.
2. The Intelligent Flight Battery with the highest power level will be charged first, and then the rest will be charged in sequence according to their power levels. Refer to the Status LED Indicator Descriptions for more information about the blinking patterns of the status LED indicator.
3. The Intelligent Flight Battery can be disconnected from the charging hub when charging is complete.

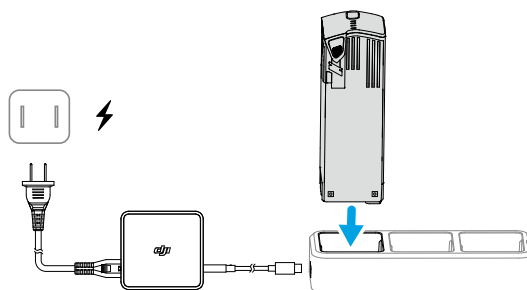

























Status LED Indicator Descriptions

Blinking Pattern	Description
Solid yellow	No battery is inserted.
Pulses green	Charging
Solid green	All batteries fully charged
Blinks yellow	Temperature of batteries too low or too high (no further operation needed)
Solid red	Power supply or battery error (remove and reinsert the batteries or unplug and plug in the charger)

-  • It is recommended to use a DJI 100W USB-C Power Adapter when using the charging hub to charge Mavic 3 Intelligent Flight Batteries.
- The charging hub is only compatible with BWX260-5000-15.4 Intelligent Flight Batteries. DO NOT attempt to use the charging hub with other battery models.
 - Place the charging hub on a flat and stable surface when in use. Make sure the device is properly insulated to prevent fire hazards.
 - DO NOT attempt to touch the metal terminals on the battery ports.
 - Clean the metal terminals with a clean, dry cloth if there is any noticeable buildup.

Battery Protection Mechanisms

The battery level LEDs can display battery protection notifications triggered by abnormal charging conditions.

Battery Protection Mechanisms					
LED1	LED2	LED3	LED4	Blinking Pattern	Status
				LED2 blinks twice per second	Overcurrent detected
				LED2 blinks three times per second	Short circuit detected
				LED3 blinks twice per second	Overcharge detected
				LED3 blinks three times per second	Over-voltage charger detected
				LED4 blinks twice per second	Charging temperature is too low
				LED4 blinks three times per second	Charging temperature is too high

If any of the battery protection mechanisms are activated, unplug the charger, and plug it in again to resume charging. If the charging temperature is abnormal, wait for it to return to normal. The battery will automatically resume charging without the need to unplug and plug the charger again.

Inserting/Removing the Battery

Insert the Intelligent Flight Battery into the battery compartment of the aircraft. Make sure it is mounted securely and that the battery buckles are clicked into place.

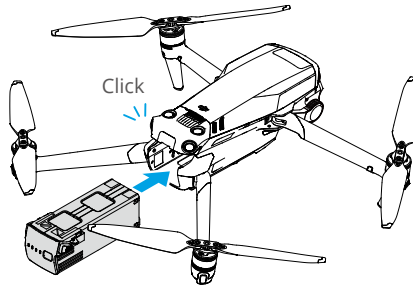

Press and hold the textured part of the battery buckles on the sides of the battery to remove it from the compartment.

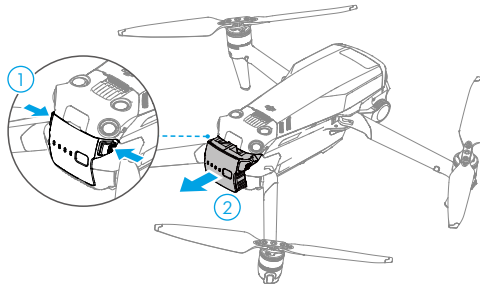

-
- ⚠ • DO NOT insert or remove the battery while the aircraft is powered on.
 - Make sure the battery is mounted securely.
-

Gimbal and Camera

Gimbal Profile

The 3-axis gimbal provides stabilization for the camera, allowing you to capture clear and stable images and video. The control tilt range is -90° to $+35^{\circ}$ and the control pan range is -5° to $+5^{\circ}$.

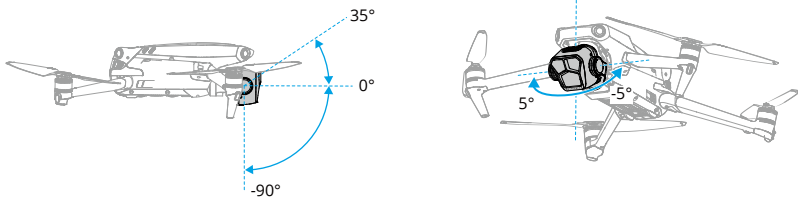

Use the gimbal dial on the remote controller to control the tilt of the camera. Alternatively, do so through the camera view in DJI Fly. Press and hold the screen until the camera adjustment bar appears. Drag the bar up or down to control the tilt and left or right to control the pan.

Gimbal Operation Modes

Two gimbal operation modes are available. Switch between the operation modes in Settings > Control in DJI Fly.

Follow Mode: the angle of the gimbal remains stable relative to the horizontal plane. Users can adjust the gimbal tilt. This mode is suitable for shooting stills.

FPV Mode: when the aircraft is flying forward, the gimbal synchronizes with the movement of the aircraft to provide a first-person flying experience.

- ⚠ • DO NOT tap or knock the gimbal after the aircraft is powered on. Launch the aircraft from open and flat ground to protect the gimbal during takeoff.
- After installing the wide-angle lens, make sure the gimbal is level and forward before takeoff, so that the aircraft can correctly detect the installation status of the Wide-Angle Lens. The gimbal will be level when the aircraft is powered on, if the gimbal rotates, recenter the gimbal using the remote controller or DJI Fly, as follows:
 - a. Tap Recenter Gimbal on the Settings > Control page of DJI Fly.
 - b. Press the Customizable C1 Button on the remote controller (the default function recenters the gimbal and points the gimbal downward, this can be customized).
- Pano and Asteroid functions will not be available after the Wide-Angle Lens is installed.
- Precision elements in the gimbal may be damaged by a collision or impact, which may cause the gimbal to function abnormally.
- Avoid getting dust or sand on the gimbal, especially in the gimbal motors.
- A gimbal motor may enter protection mode in the following situations: a. The aircraft is on uneven ground, and the gimbal is obstructed. b. The gimbal experiences an excessive external force, such as during a collision.

- DO NOT apply external force to the gimbal after the gimbal is powered on. DO NOT add any extra payload other than an official accessory to the gimbal, as this may cause the gimbal to function abnormally or lead to permanent motor damage.
 - Remove the gimbal protector before powering on the aircraft. Attach the gimbal protector when the aircraft is not in use.
 - Flying in heavy fog or clouds may make the gimbal wet, leading to temporary failure. The gimbal will recover full functionality once it is dry.
-

Camera Profile

DJI **Mavic 3 Pro** is equipped with 3 cameras, capable of switching freely between different focal lengths to adapt to the shooting composition of various scenes.

DJI **Mavic 3 Pro** uses a 4/3 CMOS sensor Hasselblad L2D-20c camera, which can take 20MP photos and record at 5.1K 50fps/DCI 4K 120fps Apple ProRes 422 HQ, Apple ProRes 422, Apple ProRes 422 LT and H.264/H.265 format videos. The camera also supports 10-bit D-Log video, has a dynamic range of 12.8 stops and an adjustable aperture of f/2.8 to f/11. The equivalent focal length is 24 mm and shoots from 1 m to infinity.

The medium tele camera boasts a 1/1.3-in CMOS sensor, with an aperture of f/2.8, 3x optical zoom and up to 7x digital zoom. It can take 48MP photos and 4K 60fps videos. The equivalent focal length is 70 mm and shoots from 3 m to infinity.

The tele camera boasts a 1/2-in CMOS sensor, with an aperture of f/3.4 and 7x optical zoom. It can take 12MP photos and 4K 60fps videos. The equivalent focal length is 166 mm and shoot from 3 m to infinity. When in Explore mode, the tele camera can zoom at 28x.



- Make sure the temperature and humidity are within suitable ranges for the camera during use and storage.
 - Use a lens cleanser to clean the lens to avoid damage or poor image quality.
 - DO NOT block any ventilation holes on the camera as the heat generated may damage the device or injure the user.
 - Only the DJI **Mavic 3 Pro** Cine supports the recording and storing of Apple ProRes 422 HQ, Apple ProRes 422, and Apple ProRes 422 LT video.
 - **Mavic 3 Pro** uses SmartPhoto mode by default in Single Shot, which integrates features such as scene recognition or HDR for optimal results. SmartPhoto needs to take multiple shots continuously for image synthesis. When the aircraft is moving or using the medium tele camera at 48MP resolution, SmartPhoto will not be supported, and the photo performance will differ.
 - The cameras may not focus correctly in the following situations:
 - a. Shooting dark objects far away.
 - b. Shooting objects with repeating identical patterns and textures or without clear patterns and textures.
 - c. Shooting shiny or reflective objects (such as street lighting and glass).
 - d. Shooting flashing objects.
 - e. Shooting fast-moving objects.
 - f. When the aircraft/gimbal is moving fast.
 - g. Shooting objects with varying distances in the focus range.
-

Storing and Exporting Photos and Videos

Storing Photos and Videos

DJI Mavic 3 Pro has 8GB of built-in storage and supports the use of a microSD card to store photos and videos. A SDXC, or UHS-I microSD card is required due to the fast read and write speeds necessary for high-resolution video data. Refer to the Specifications section for more information about recommended microSD cards.

In addition, DJI Mavic 3 Pro Cine aircraft comes with a built-in 1TB SSD. The footage can be output quickly via the DJI 10Gbps Lightspeed Data Cable.

Exporting Photos and Videos

Use QuickTransfer to export the footage to a mobile phone. Connect the aircraft to a computer or use a card reader to export the footage to a computer.



- DO NOT remove the microSD card from the aircraft when taking photos or videos. Otherwise, the microSD card may be damaged.
 - To ensure the stability of the camera system, single video recordings are limited to 30 minutes.
 - Check camera settings before use to ensure they are configured correctly.
 - Before shooting important photos or videos, shoot a few images to test whether the camera is operating correctly.
 - Photos and videos cannot be transmitted or copied from the camera if the aircraft is powered off.
 - Make sure to power off the aircraft correctly. Otherwise, the camera parameters will not be saved, and any recorded videos may be affected. DJI is not responsible for any loss caused by an image or video recorded in a way that is not machine-readable.
-

QuickTransfer

DJI Mavic 3 Pro can connect directly to mobile devices via Wi-Fi, enabling users to download photos and videos from the aircraft to the mobile device through DJI Fly without using the remote controller. Users can enjoy faster and more convenient downloads with a transmission rate of up to 80 MB/s.

Usage

1. Power on the aircraft and wait until the self-diagnostic tests of the aircraft are complete.
2. Make sure Bluetooth and Wi-Fi are enabled on the mobile device. Launch DJI Fly and a prompt will appear to connect to the aircraft.
3. Tap Connect. Once successfully connected, the files on the aircraft can be accessed and downloaded at high speed. When connecting the mobile device to the aircraft for the first time, press and hold the power button of the aircraft for two seconds to confirm.

- ⚠ • The maximum download rate can only be achieved in countries and regions where the 5.8 GHz frequency is permitted by local laws and regulations. To achieve the maximum download rate, the device must support a 5.8 GHz frequency band and Wi-Fi 6 connection, and the footage must be using the internal storage of aircraft in an environment without interference or obstruction. If 5.8 GHz is not allowed by local regulations (such as in Japan), or the mobile device of the user does not support the 5.8 GHz frequency band, then QuickTransfer will use the 2.4 GHz frequency band and its maximum download rate will reduce to 10 MB/s.
 - Make sure that Bluetooth, Wi-Fi, and location services are enabled on the mobile device before using QuickTransfer.
 - When using QuickTransfer, it is not necessary to enter the Wi-Fi password on the settings page of the mobile device in order to connect. Launch DJI Fly and a prompt will appear to connect the aircraft.
 - Use QuickTransfer in an unobstructed environment with no interference and stay away from sources of interference such as wireless routers, Bluetooth speakers, or headphones.
-

Remote Controller

This section describes the features of the remote controller and includes instructions for controlling the aircraft and the camera.

Remote Controller

DJI RC Pro

The DJI RC Pro remote controller features O3+, works at both 2.4 GHz and 5.8 GHz, is capable of selecting the best transmission channel automatically, and can transmit a live HD view from the camera of the aircraft at a distance of up to 15 km (compliant with FCC standards, measured in a wide open area without interference). The built-in 5.5-in high brightness 1000 cd/m² screen boasts a resolution of 1920×1080 pixels while the remote controller comes with a wide range of aircraft and gimbal controls as well as customizable buttons. Users can connect to the internet via Wi-Fi and the Android 10 operating system comes with a variety of functions such as Bluetooth and GNSS (GPS+GLONASS+Galileo).

With the built-in speaker, the remote controller supports H.264 4K/120fps and H.265 4K/120fps video, which also supports video output via the Mini HDMI port. The internal storage of the remote controller is 32 GB and also supports the use of microSD cards to store the photos and videos.

The 5000mAh 36Wh battery provides the remote controller with a maximum operating time of three hours.

Operation

Powering On/Off

Press the power button once to check the current battery level.

Press, then press and hold the power button to power the remote controller on or off.

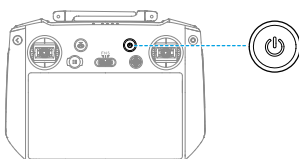

Charging the Battery

Use a USB-C cable to connect the charger to the USB-C port of the remote controller.

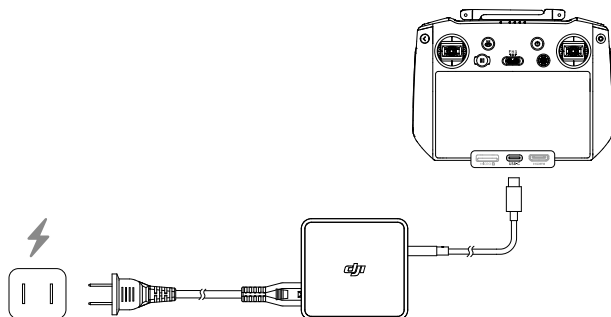

Controlling the Gimbal and Camera

Focus/Shutter Button: press halfway down to auto-focus, and press all the way down to take a photo.

Record Button: press once to start or stop recording.

Camera Control Dial: use to adjust the zoom by default. The dial function can be set to adjust the focal length, EV, aperture, shutter speed, and ISO.

Gimbal Dial: control the tilt of the gimbal.

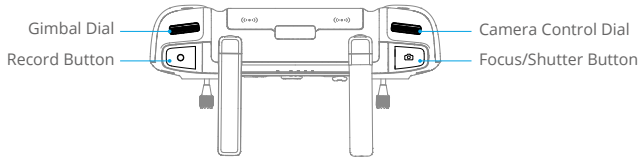

Controlling the Aircraft

Three preprogrammed modes (Mode 1, Mode 2, and Mode 3) are available and custom modes can be configured in the DJI Fly app.

Mode 1

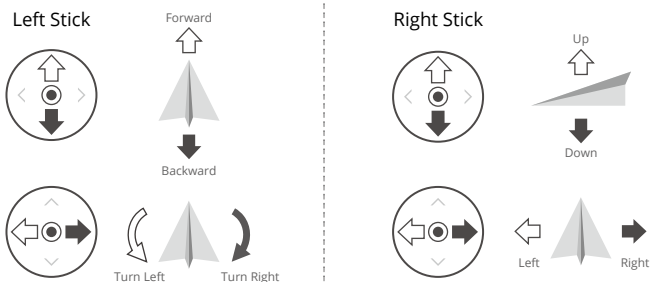

Mode 2

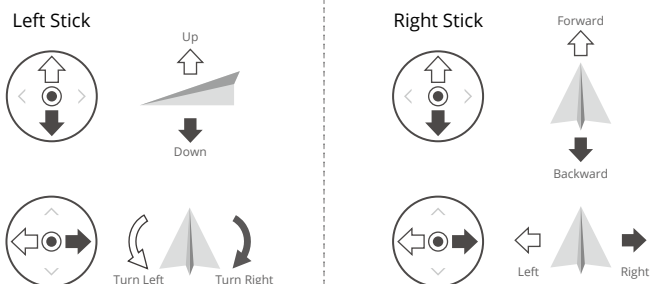



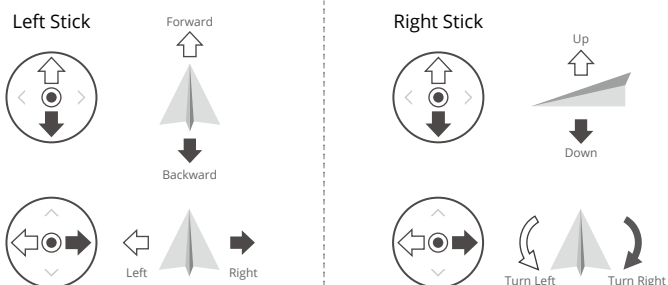



Mode 3

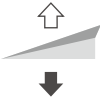

The default control mode of the remote controller is Mode 2. In this manual, Mode 2 is used as an example to illustrate how to use the control sticks.

- Stick Neutral/Center Point: control sticks are in the center.
- Moving the control stick: the control stick is pushed away from the center position.

Remote Controller (Mode 2)	Aircraft	Remarks
		<p>Throttle Stick: moving the left stick up or down changes the altitude of the aircraft.</p> <p>Push the stick up to ascend and push down to descend. The aircraft hovers in place if the stick is in the center. Use the left stick to take off when the motors are spinning at an idle speed.</p> <p>The more the stick is pushed away from the center, the faster the aircraft changes elevation. Push the stick gently to prevent sudden and unexpected changes in altitude.</p>
		<p>Yaw Stick: moving the left stick to the left or right controls the orientation of the aircraft.</p> <p>Push the stick left to rotate the aircraft counterclockwise and right to rotate the aircraft clockwise. The aircraft hovers in place if the stick is in the center.</p> <p>The more the stick is pushed away from the center, the faster the aircraft rotates.</p>
		<p>Pitch Stick: moving the right stick up and down to change the pitch of the aircraft.</p> <p>Push the stick up to fly forward and down to fly backward. The aircraft hovers in place if the stick is in the center.</p> <p>The more the stick is pushed away from the center, the faster the aircraft moves.</p>
		<p>Roll Stick: moving the right stick to the left or right changes the roll of the aircraft.</p> <p>Push the stick left to fly left and right to fly right. The aircraft hovers in place if the stick is in the center.</p> <p>The more the stick is pushed away from the center, the faster the aircraft moves.</p>

Flight Mode Switch

Toggle the switch to select the desired flight mode.

Position	Flight Mode
S	Sport Mode
N	Normal Mode
C	Cine Mode*

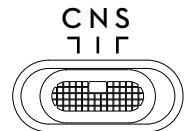

* Low Speed mode in EU.

RTH Button

Press and hold the RTH button until the remote controller beeps to start RTH. The aircraft will fly to the last updated Home Point. Press the button again to cancel RTH and regain control of the aircraft.

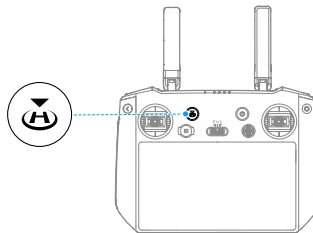

Customizable Buttons

Including C1, C2, C3, and the 5D button. Go to Settings > Control in DJI Fly to customize the function of the button.

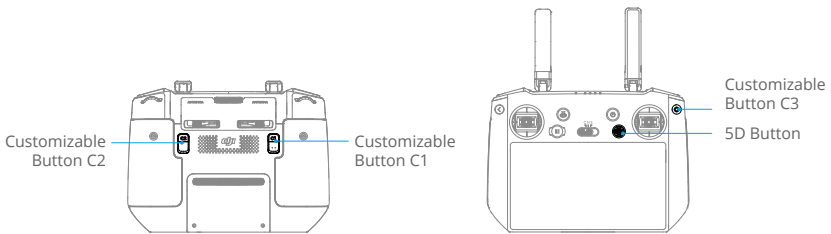







Combination Buttons

Some frequently used features can be activated by using combination buttons. To use combination buttons, press and hold the back button and operate the other button in the combination. In actual use, enter the home page of the remote controller and tap Tips to check all available combination buttons quickly.

















Combination Operation	Function
Back Button + Left Dial	Adjust Brightness
Back Button + Right Dial	Adjust Volume
Back Button + Record Button	Record Screen
Back Button + Shutter Button	Screenshot
Back Button + 5D Button	Toggle up - Home; Toggle down - Shortcut settings; Toggle left - Recently opened apps

Remote Controller LEDs

Status LED

Blinking Pattern	Descriptions
 — Solid red	Disconnected from the aircraft
 Blinks red	The temperature of the remote controller is too high, or the battery level of the aircraft is low
 — Solid green	Connected with the aircraft
 Blinks blue	The remote controller is linking to an aircraft
 — Solid yellow	Firmware update failed
 Blinks yellow	The battery level of the remote controller is low
 Blinks cyan	Control sticks not centered

Battery Level LEDs

Blinking Pattern				Battery Level
				76%-100%
				51%-75%
				26%-50%
				0%-25%

Remote Controller Alert

The remote controller vibrates or beeps twice to indicate an error or warning. Pay attention when prompts appear on the touchscreen or in DJI Fly. Slide down from the top of the screen and select Do Not Disturb or Mute to disable alerts.

The remote controller sounds an alert during RTH. The alert cannot be canceled. The remote controller sounds an alert when the battery level of the remote controller is low (6% to 10%). A low battery level alert can be canceled by pressing the power button. The critical low battery level alert, which is triggered when the battery level is less than 5%, cannot be canceled.

Optimal Transmission Zone

The signal between the aircraft and the remote controller is most reliable when the antennas are positioned in relation to the aircraft, as illustrated below.

The optimal transmission range is where the antennas face the aircraft, with the angle between the antennas and the back of the remote controller being 180° or 270°.

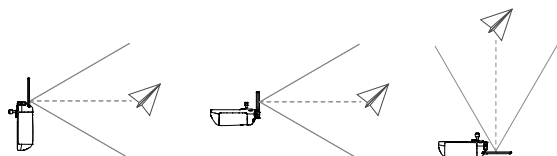

-
- ⚠ • DO NOT operate other wireless devices at the same frequency as the remote controller to avoid signal interference.
 - A prompt will be displayed in DJI Fly if the transmission signal is weak during flight. Adjust the antennas to make sure that the aircraft is in the optimal transmission range.
-

Linking the Remote Controller

The remote controller is already linked to the aircraft when purchased together as a combo. Otherwise, follow the steps below to link the remote controller and the aircraft after activation.

Method 1: Using Button Combinations

1. Power on the aircraft and the remote controller.
2. Press the C1, C2, and Record buttons simultaneously until the status LED blinks blue and the remote controller beeps.
3. Press and hold the power button of the aircraft for more than four seconds. The aircraft beeps twice after a short beep, and its battery level LEDs blink in sequence to indicate it is ready to link. The remote controller will beep twice, and its status LED will turn solid green to indicate linking is successful.

Method 2: Using DJI Fly

1. Power on the aircraft and the remote controller.
2. Launch DJI Fly, in camera view tap ●●● and select Control and then Connect to the Aircraft. During linking, the status LED of the remote controller blinks blue and the remote controller beeps.
3. Press and hold the power button of the aircraft for more than four seconds. The aircraft beeps twice after a short beep, and its battery level LEDs blink in sequence to indicate it is ready to link. The remote controller will beep twice, and its status LED will turn solid green to indicate linking is successful.

-
- 💡 • Make sure the remote controller is within 0.5 m of the aircraft during linking.
 - The remote controller will automatically unlink from an aircraft if a new remote controller is linked to the same aircraft.
 - Turn off the Bluetooth and Wi-Fi of the remote controller for optimal video transmission.
-

- ⚠ • Fully charge the remote controller before each flight. The remote controller sounds an alert when the battery level is low.
 - If the remote controller is powered on and is not in use for five minutes, an alert will sound. After six minutes, the aircraft automatically powers off. Move the control sticks or press any button to cancel the alert.
 - Fully charge the battery at least once every three months to maintain battery health.
-

Operating the Touchscreen

Home

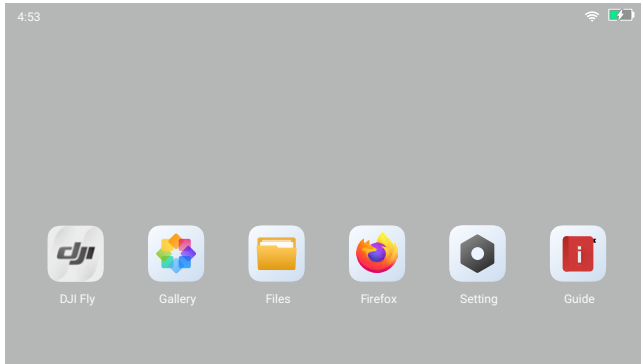

The top of the touchscreen displays the time, Wi-Fi signal, and battery level of the remote controller.

Some apps are already installed by default such as DJI Fly, Gallery, Files, Firefox, Settings, and Tips. Settings includes network, display, voice, and Bluetooth configurations. Users can quickly learn about the features under Tips.

Screen Gestures

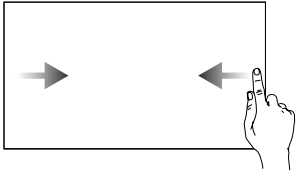

Slide from the left or right to the center of the screen to return to the previous screen.

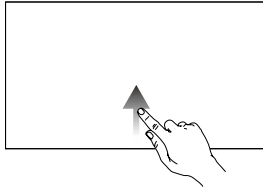

Slide up from the bottom of the screen to return to the homepage.

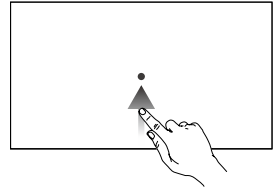

Slide up from the bottom of the screen and hold to access recently opened apps.

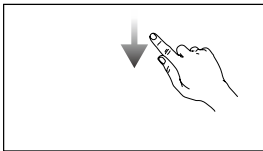

Slide down from the top of the screen to open the status bar when in DJI Fly. The status bar displays information such as time, Wi-Fi signal, and remote controller battery level.

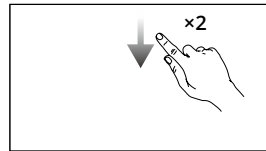

Open Quick Settings: slide down twice from the top of the screen to open Quick Settings when in DJI Fly. Slide down once from the top of the screen to open Quick Settings when not in DJI Fly.

Quick Settings

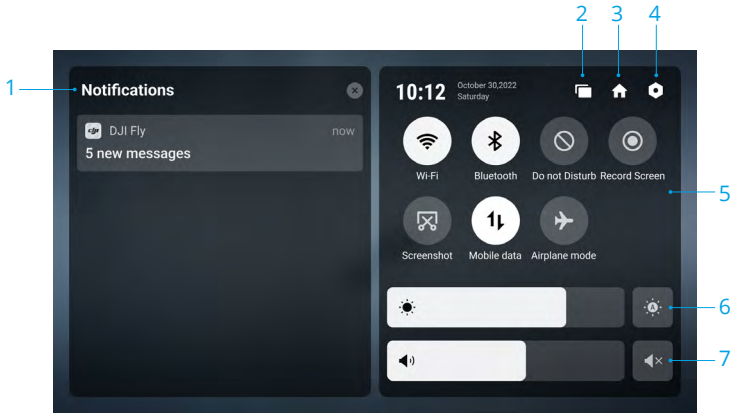

1. Notifications

Tap to check system notifications.

2. Recent

Tap to check recently opened apps.

3. Home

Tap to return to the home screen.

4. System Settings

Tap to access system settings.

5. Shortcuts

Wi-Fi : Tap to enable or disable Wi-Fi. Hold to enter settings and connect to or add a Wi-Fi network.

Bluetooth : Tap to enable or disable Bluetooth. Hold to enter settings and connect with nearby Bluetooth devices.

Do Not Disturb : Tap to enable Do Not Disturb mode. In this mode, system prompts will be disabled.

Record Screen : Tap to start recording the screen. While recording, the screen displays the recording time. Tap Stop to stop recording.

Screenshot : Tap to screenshot the screen.

Mobile data.

Airplane mode : Tap to enable Airplane mode. Wi-Fi, Bluetooth, and mobile data will be disabled.

6. Adjusting Brightness

Brightness icon : The screen is in auto brightness mode when the icon is highlighted. Tap or slide the bar will switch to manual brightness mode.

7. Adjusting Volume

Slide the bar to adjust the volume and tap Mute to mute.

Advanced Features

Calibrating the Compass

The compass may need to be calibrated after the remote controller is used in areas with electromagnetic interference. A warning prompt will appear if the compass of the remote controller requires calibration. Tap the warning prompt to start calibrating. In other cases, follow the steps below to calibrate your remote controller.

1. Power on the remote controller and enter the home page.
2. Select System Settings , scroll down, and tap Compass.
3. Follow the on-screen instructions to calibrate the compass.
4. A prompt will be displayed when the calibration is successful.

HDMI Settings

The touchscreen can be shared with a display screen via an HDMI cable.

The resolution can be set in Settings > Display, and then HDMI.

DJI RC

When used with DJI Mavic 3 Pro, DJI RC remote controller features O3+ video transmission, works at both 2.4 GHz and 5.8 GHz frequency bands. It is capable of selecting the best transmission channel automatically and can transmit up to 1080p 60fps HD live view from the aircraft to the remote controller at a distance of up to 15 km (compliant with FCC standards, and measured in a wide open area without interference). The DJI RC is also equipped with a 5.5-in touchscreen (1920×1080 pixel resolution) and a wide range of controls and customizable buttons, enabling users to easily control the aircraft and remotely change the aircraft settings.

The built-in 5200 mAh battery with a power of 18.72 Wh provides the remote controller with a maximum operating time of four hours. The DJI RC comes with many other functions such as Wi-Fi connection, built-in GNSS (GPS+BeiDou+Galileo), Bluetooth, built-in speakers, detachable control sticks, and microSD storage.

Operation

Powering On/Off

Press the power button once to check the current battery level.

Press, then press and hold the power button for two seconds to power the remote controller on or off.

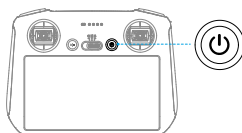

Charging the Battery

Use a USB-C cable to connect the charger to the USB-C port of the remote controller. The battery can be fully charged in about 1 hour and 30 minutes with a maximum charging power of 15 W (5V/3A).

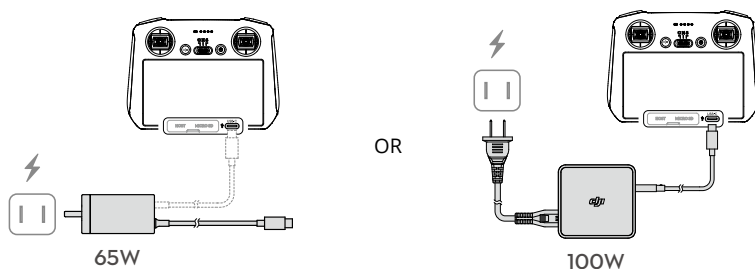

Controlling the Gimbal and Camera

Focus/Shutter Button: press halfway down to auto-focus and press all the way down to take a photo.

Record Button: press once to start or stop recording.

Camera Control Dial: Use to adjust the zoom by default. The dial function can be set to adjust the focal length, EV, aperture, shutter speed, and ISO.

Gimbal Dial: control the tilt of the gimbal.

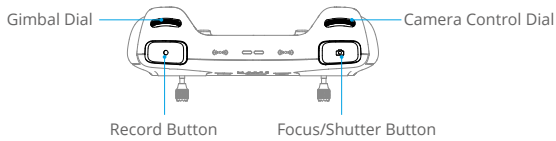

Controlling the Aircraft

Three preprogrammed modes (Mode 1, Mode 2, and Mode 3) are available and custom modes can be configured in DJI Fly.

Mode 1

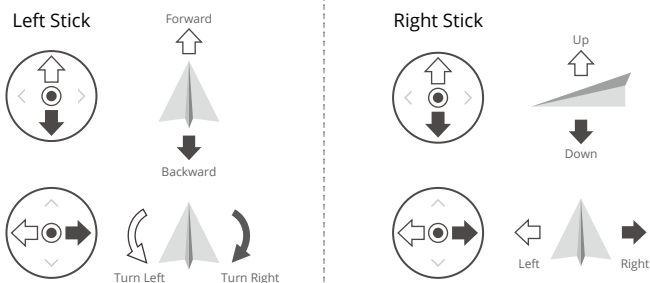

Mode 2

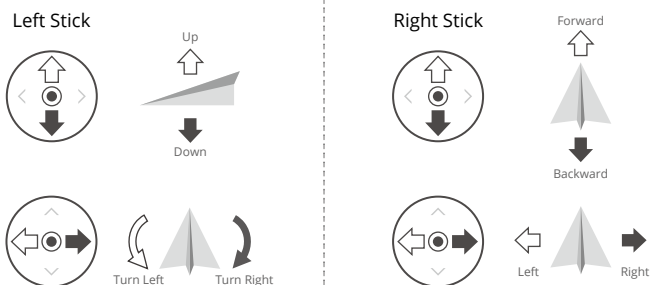

Mode 3

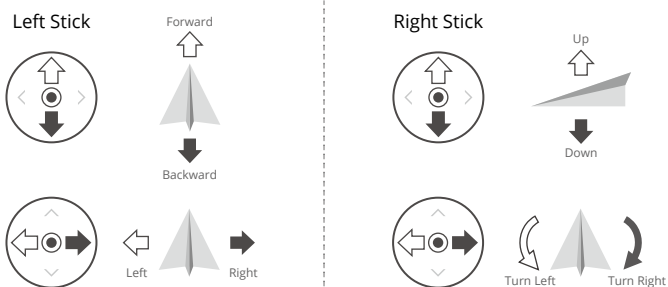









The default control mode of the remote controller is Mode 2. In this manual, Mode 2 is used as an example to illustrate how to use the control sticks.



- **Stick Neutral/Center Point:** control sticks are in the center.

- **Moving the control stick:** the control stick is pushed away from the center position.

Remote Controller (Mode 2)	Aircraft	Remarks
		<p>Throttle Stick: moving the left stick up or down changes the altitude of the aircraft.</p> <p>Push the stick up to ascend and down to descend. The more the stick is pushed away from the center position, the faster the aircraft will change altitude.</p> <p>Push the stick gently to prevent sudden and unexpected changes in altitude.</p>
		<p>Yaw Stick: moving the left stick to the left or right controls the orientation of the aircraft.</p> <p>Push the stick left to rotate the aircraft counterclockwise and right to rotate the aircraft clockwise. The aircraft hovers in place if the stick is in the center.</p> <p>The more the stick is pushed away from the center, the faster the aircraft rotates.</p>
		<p>Pitch Stick: moving the right stick up and down to change the pitch of the aircraft.</p> <p>Push the stick up to fly forward and down to fly backward. The aircraft hovers in place if the stick is in the center.</p> <p>The more the stick is pushed away from the center, the faster the aircraft moves.</p>
		<p>Roll Stick: moving the right stick to the left or right changes the roll of the aircraft.</p> <p>Push the stick left to fly left and right to fly right. The aircraft hovers in place if the stick is in the center.</p> <p>The more the stick is pushed away from the center, the faster the aircraft moves.</p>

Flight Mode Switch

Toggle the switch to select the desired flight mode.

Position	Flight Mode
S	Sport Mode
N	Normal Mode
C	Cine Mode*

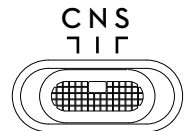

* Low Speed mode in EU.

Flight Pause/RTH Button

Press once to make the aircraft brake and hover in place. Press and hold the button until the remote controller beeps and starts RTH, the aircraft will return to the last recorded Home Point. Press this button again to cancel RTH and to regain control of the aircraft.

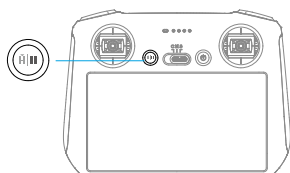





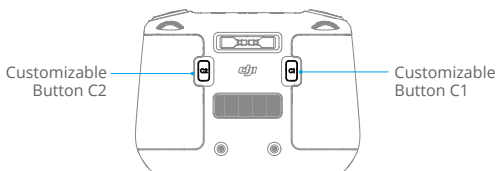



Customizable Buttons

Go to Settings > Control in DJI Fly to set the functions of the customizable C1 and C2 buttons.



Remote Controller LEDs

Status LED

Blinking Pattern	Descriptions
 —	Solid red Disconnected from the aircraft
	Blinking red The battery level of the aircraft is low
 —	Solid green Connected with the aircraft
	Blinking blue The remote controller is linking to an aircraft
 —	Solid yellow Firmware update failed
 —	Solid blue Firmware update successful
	Blinking yellow The battery level of the remote controller is low
	Blinking cyan Control sticks not centered

Battery Level LEDs

Blinking Pattern				Battery Level
				76%-100%
				51%-75%
				26%-50%
				0%-25%

Remote Controller Alert

The remote controller beeps to indicate an error or warning. Pay attention when prompts appear on the touchscreen or in DJI Fly. Slide down from the top of the screen and select Mute to disable all alerts, or slide the volume bar to 0 to disable some alerts.

The remote controller sounds an alert during RTH. The alert cannot be canceled. The remote controller sounds an alert when the battery level of the remote controller is low (6% to 10%). A low battery level alert can be canceled by pressing the power button. The critical low battery level alert, which is triggered when the battery level is less than 5%, cannot be canceled.

Optimal Transmission Zone

The signal between the aircraft and the remote controller is most reliable when the remote controller is positioned towards the aircraft as depicted below.

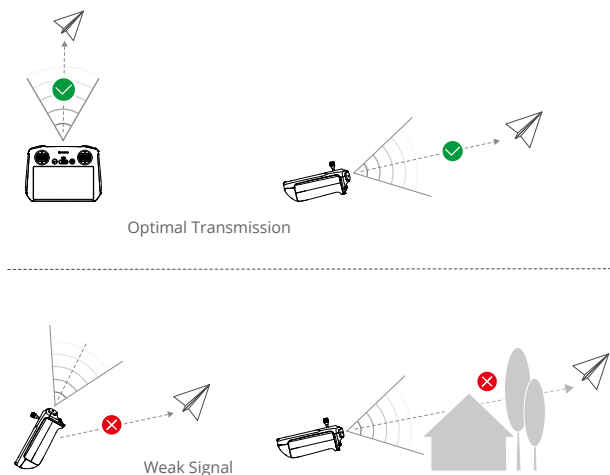

- ⚠ DO NOT operate other wireless devices at the same frequency as the remote controller to avoid signal interference.
- A prompt will be displayed in DJI Fly if the transmission signal is weak during flight. Adjust the remote controller orientation to make sure that the aircraft is in the optimal transmission range.

Linking the Remote Controller

The remote controller is already linked to the aircraft when purchased together as a combo. Otherwise, follow the steps below to link the remote controller and the aircraft after activation.

1. Power on the aircraft and the remote controller.
2. Launch DJI Fly.
3. In camera view, tap ●●● and select Control and then Connect to the Aircraft. During linking, the status LED of the remote controller blinks blue and the remote controller beeps.
4. Press and hold the power button of the aircraft for more than four seconds. The aircraft beeps twice after a short beep, and its battery level LEDs blink in sequence to indicate it is ready to link. The remote controller will beep twice, and its status LED will turn solid green to indicate linking is successful.



- Make sure the remote controller is within 0.5 m of the aircraft during linking.
- The remote controller will automatically unlink from an aircraft if a new remote controller is linked to the same aircraft.
- Turn off the Bluetooth and Wi-Fi of the remote controller for optimal video transmission.



- Fully charge the remote controller before each flight. The remote controller sounds an alert when the battery level is low.
 - If the remote controller is powered on and not in use for five minutes, an alert will sound. After six minutes, the aircraft automatically powers off. Move the control sticks or press any button to cancel the alert.
 - Fully charge the battery at least once every three months to maintain battery health.
-

Operating the Touchscreen

Home

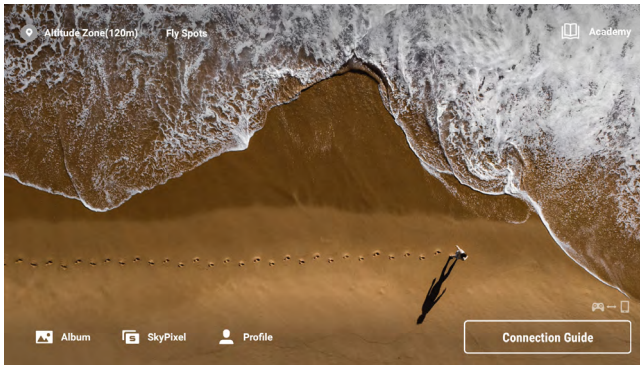

Screen Gestures

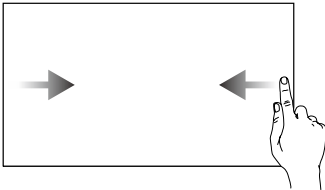

Slide from the left or right to the center of the screen to return to the previous screen.

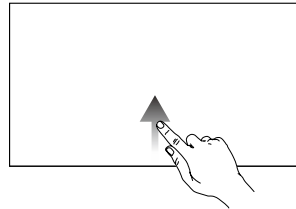

Slide up from the bottom of the screen to return to DJI Fly.

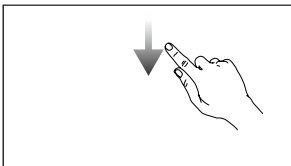

Slide down from the top of the screen to open the status bar when in DJI Fly.

The status bar displays the time, Wi-Fi signal, battery level of the remote controller, etc.

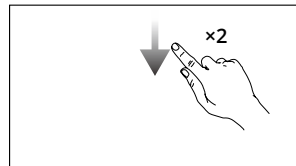

Slide down twice from the top of the screen to open Quick Settings when in DJI Fly.

Quick Settings

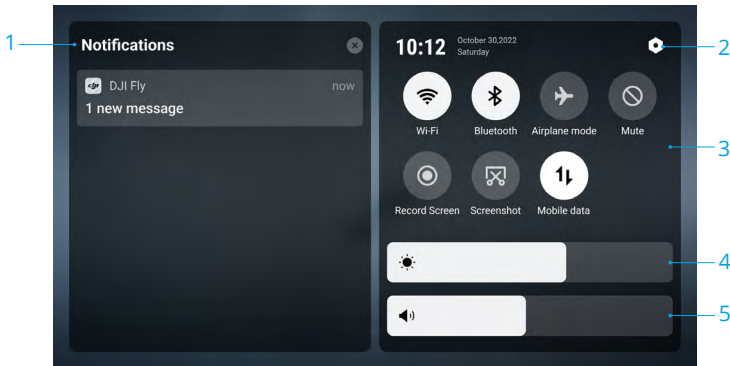

1. Notifications

Tap to check system notifications.

2. System Settings

Tap to access system settings and configure settings such as Bluetooth, volume, and network. You can also view the Guide to learn more about the controls and status LEDs.

3. Shortcuts

 : Tap to enable or disable Wi-Fi. Hold to enter settings and then connect to or add a Wi-Fi network.

 : Tap to enable or disable Bluetooth. Hold to enter settings and connect with nearby Bluetooth devices.

 : Tap to enable Airplane mode. Wi-Fi and Bluetooth will be disabled.

 : Tap to turn off system notifications and disable all alerts.

 : Tap to start recording the screen. The function will be available only after a microSD card is inserted into the microSD slot on the remote controller.

 : Tap to take a screenshot. The function will be available only after a microSD card is inserted into the microSD slot on the remote controller.

 : Mobile data.

4. Adjusting Brightness

Slide the bar to adjust the screen brightness.

5. Adjusting Volume

Slide the bar to adjust the volume.

Advanced Features

Calibrating the Compass

The compass may need to be calibrated after the remote controller is used in areas with electromagnetic interference. A warning prompt will appear if the compass of the remote controller requires calibration. Tap the warning prompt to start calibrating. In other cases, follow the steps below to calibrate the remote controller.

1. Power on the remote controller, and enter Quick Settings.
2. Select System Settings , scroll down, and tap Compass.
3. Follow the on-screen instructions to calibrate the compass.
4. A prompt will be displayed when the calibration is successful.

DJI Fly App

This section introduces the main functions of the DJI Fly app.

DJI Fly App

Home

Launch DJI Fly and enter the home screen.

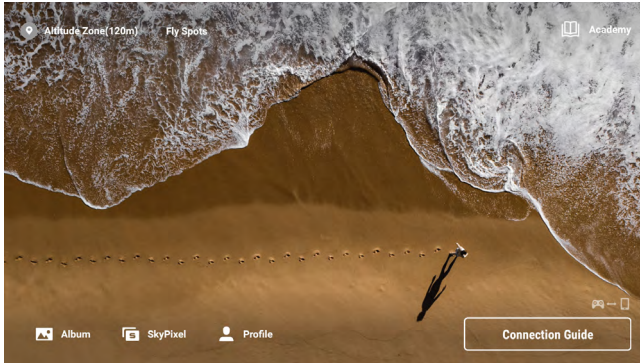

Fly Spots

View or share flight and shooting locations nearby, learn more about GEO Zones, and preview aerial photos of different locations taken by other users.

Academy

Tap the icon in the top right corner to enter Academy and view product tutorials, flight tips, flight safety notices, and manual documents.

Album

Allows you to view photos and videos from the aircraft album or saved on the local device. Tap Create and select Templates or Pro. Templates provides an auto-edit feature for imported footage. Pro allows users to edit footage manually.

SkyPixel

Enter SkyPixel to view videos and photos shared by other users.

Profile

View account information and flight records, visit the DJI forum and online store, access the Find My Drone feature, offline maps, and other settings such as firmware updates, camera view, cached data, account privacy, and language.

Camera View

Buttons Description

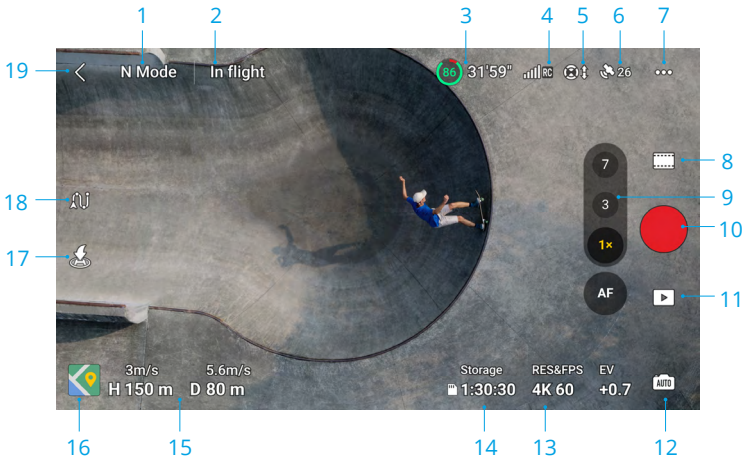

1. Flight Mode

N Mode: displays the current flight mode.

2. System Status Bar

In Flight: displays aircraft flight status and various warning messages.

3. Battery Information

86% 31:59: displays the current battery level and remaining flight time. Tap to view more information about the battery.

4. Video Downlink Signal Strength

Signal strength icon: displays the video downlink signal strength between the aircraft and the remote controller.

5. Vision System Status

Vision system icon: the left side of the icon indicates the status of the horizontal vision system and the right side of the icon indicates the status of the upward and downward vision systems. The icon is white when the vision system is working normally and turns red when the vision system is unavailable.







6. GNSS Status

GNSS signal strength icon: displays the current GNSS signal strength. Tap to check the GNSS signal status. The Home Point can be updated when the icon is white, which indicates the GNSS signal is strong.

7. Settings

•••: tap to view or set parameters for safety, control, camera, and transmission. Refer to the Settings section for more information.



8. Shooting Modes

	Photo: Single, Explore, AEB, Burst Shooting, and Time Shot.
	Video: Normal, Night, Explore, and Slow Motion.
	MasterShots: drag-select a subject. The aircraft will record while executing different maneuvers in sequence and keep the subject in the center of the frame. A short cinematic video will be generated afterward.
	QuickShots: Dronie, Rocket, Circle, Helix, Boomerang, and Asteroid.
	Hyperlapse: Free, Circle, Course Lock, and Waypoints.
	Pano: Sphere, 180°, Wide Angle, and Vertical. The aircraft will automatically take several photos and synthesize a panoramic photo based on the selected panoramic photo type.

-  • Explore mode uses the tele and medium tele cameras of Mavic 3 Pro as a safer way to explore views from farther distances. In Explore mode, users can use the hybrid zoom in any of the following ways:
 - a. Tap the zoom button and switch between a series of zooms, including 1x, 3x, 7x, 14x, and 28x.
 - b. Tap and hold the zoom button and drag up and down to adjust camera zoom.
 - c. Use two fingers on the screen to zoom in or out.
 - d. Use the camera control dial of the remote controller to zoom in or out.
- Night mode provides better noise reduction and cleaner footage, supports up to 12800 ISO.

-  • Night mode currently supports 4K 24/25/30fps.
 - Obstacle sensing will be disabled in Night mode. Fly with caution.
 - Night mode will be exited automatically when RTH or landing is started.
 - During RTH or auto landing, Night mode is not available.
 - FocusTrack is not supported in Night mode.

9. Camera Switch/Focus Button

Tap  to switch to the tele camera, and tap  to switch to the medium tele camera. Tap  to switch to the Hasselblad camera.

Press and hold the camera button to bring up the zoom bar and adjust the digital zoom.

-  • Digital zoom is only supported in Normal video and Explore mode.
 - When zooming in or out, the larger the zoom ratio, the slower the aircraft will rotate, to achieve a smooth view.

AF/MF: tap to switch between AF and MF. Press and hold the icon to display the focus bar.

10. Shutter/Record Button

 : tap to take a photo or to start or stop recording a video.

11. Playback

 : tap to enter playback and preview photos and videos as soon as they are captured.

12. Camera Modes Switch

 : tap to switch between Auto and Pro mode. Different parameters can be set in different modes.

13. Shooting Parameters

 : displays the current shooting parameters. Tap to access parameter settings.

14. Storage Information

 : displays the remaining number of photos or videos recording time of the current storage. Tap to view the available capacity of the microSD card or the aircraft internal storage.

15. Flight Telemetry

Displays the horizontal distance (D) and speed as well as vertical distance (H) and speed between the aircraft and the Home Point.

16. Map

 : tap to switch to the Attitude Indicator, which supports being centered by the aircraft or the remote controller, and displays information such as the orientation and tilt angle of the aircraft, as well as the locations of the remote controller and the Home Point.

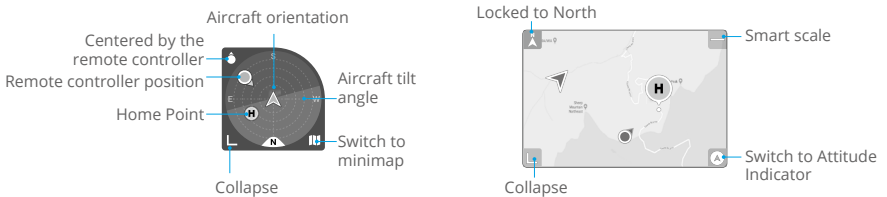

17. Auto Takeoff/Landing/RTH

 : tap the icon. When the prompt appears, press and hold the button to initiate auto takeoff or landing.

 : tap to initiate Smart RTH and have the aircraft return to the last recorded Home Point.

18. Waypoint Flight

 : tap to enable/disable Waypoint Flight.

19. Back

 : tap to return to the home screen.

Screen Shortcuts

Tap to Aim

During flight double-tap the point of interest on the screen, the aircraft will automatically move the point of interest to the center of the frame.

Gimbal Angle Adjustment

Press and hold on the screen to bring up the gimbal adjustment bar to adjust the gimbal angle.

Focus/Spot Metering

Tap on the screen to enable focus or spot metering. Focus or spot metering will display differently depending on the shooting mode, focus mode, exposure mode, and spot metering mode.

After using spot metering:

- Drag  next to the box up and down to adjust the EV (exposure value).
- Press and hold on the screen to lock the exposure. To unlock the exposure, tap and hold on the screen again or tap on another area of the screen.

Settings

Safety

- Flight Assistance

Obstacle Avoidance Action	Horizontal vision system is enabled after setting Obstacle Avoidance Action to Bypass or Brake. The aircraft cannot sense obstacles if Obstacle Avoidance is disabled.
Bypassing Options	Select Normal or Nifty mode when using Bypass.
Display Radar Map	When enabled, the real-time obstacle detection radar map will be displayed.

- Return to Home (RTH): tap to set Advanced RTH, Auto RTH Altitude, and to update the Home Point.
- Flight Protection: tap to set the max altitude and the max distance for flights.
- Sensors: tap to view the IMU and compass statuses and start calibration if necessary.
- Battery: tap to view battery information such as battery cell status, serial number, and number of times charged.
- Auxiliary LED: tap to set the auxiliary LED to auto, on, or off. DO NOT turn on the Auxiliary LED before takeoff.
- Aircraft Front Arm LEDs: tap to set the aircraft front arm LEDs to auto or on. In auto mode, the aircraft front LEDs will be disabled during shooting to ensure the quality is not affected.
- Unlock GEO Zone: tap to view information about unlocking GEO Zones.
- Find My Drone: this feature helps to find the location of the aircraft, either by enabling the aircraft LEDs, beeping, or by using the map.
- Advanced Safety Settings

Signal Lost	The behavior of the aircraft when the remote controller signal is lost can be set to RTH, Descend, or Hover.
Emergency Propeller Stop	Emergency Only, indicates that the motors can only be stopped by performing a combination stick command (CSC) mid-flight in an emergency situation such as if there is a collision, a motor has stalled, the aircraft is rolling in the air, or the aircraft is out of control and is ascending or descending very quickly. Anytime, indicates that the motors can be stopped mid-flight anytime once user performs a CSC. Stopping the motors mid-flight will cause the aircraft to crash.
Airsense	An alert will appear in DJI Fly when a manned aircraft is detected if AirSense is enabled. Read the disclaimer in the DJI Fly prompt before using AirSense.

Control

- Aircraft Settings

Units	Can be set to metric or imperial.
Subject Scanning	When enabled, the aircraft automatically scans and displays subjects in the camera view (only available for single-shot and normal video modes).
Gain and Expo Tuning	Supports the gain and expo settings to be fine-tuned for the aircraft and the gimbal in different flight modes, including the max horizontal speed, max ascent speed, max descent speed, max angular velocity, yaw smoothness, brake sensitivity, expo, and the gimbal max tilt control speed and tilt smoothness.



- When releasing the control stick, an increased brake sensitivity reduces the braking distance of the aircraft, while a decreased brake sensitivity increases the braking distance. Fly with caution.

- Gimbal Settings: tap to set the gimbal mode, perform gimbal calibration, and recenter or move the gimbal downward.
- Remote Controller Settings: tap to set the function of the customizable button, calibrate the remote controller, switch control stick modes. Make sure to understand the operations of a stick mode before changing the control stick mode.
- Flight Tutorial: view the flight tutorial.
- Re-pair to Aircraft (Link): tap to start linking when the aircraft is not linked to the remote controller.

Camera

- Camera Parameter Settings: displays different settings according to the shooting mode.

Shooting Modes	Settings
Photo Mode	Format, Aspect Ratio
Record Mode	Format, Color, Coding Format, Video Bitrate, Video Subtitles
MasterShots	Format, Color, Coding Format, Video Bitrate, Video Subtitles
QuickShots	Format, Color, Coding Format, Video Bitrate, Video Subtitles
Hyperlapse	Photo Type, Shot Frame, Format
Pano	Photo Type

- General Settings

Anti-Flicker	When enabled, the footage flicker caused by the light source will be reduced when shooting in environments with lights.  In Pro mode, anti-flicker will only take effect when shutter speed and ISO are set to auto.
Histogram	When enabled, users can check the screen to view whether the exposure is appropriate.
Peaking Level	When enabled in MF mode, the objects in focus will be outlined in red. The higher the peaking level, the thicker the outline.
Overexposure Warning	When enabled, the overexposure area will be indentified with diagnol lines.
Gridlines	Enable gridlines such as diagonal lines, nine-square grids, and center point.
White Balance	Set to auto, or manually adjust the color temperature.

- Storage

Storage	Store the recorded files to the microSD card on the aircraft or the internal storage of the aircraft. Mavic 3 Pro has an internal storage of 8 GB. While Mavic 3 Pro Cine has a built-in 1TB SSD.
Custom Folder Naming	When changed, a new folder will be automatically created on the aircraft storage to store future files.
Custom File Naming	When changed, the new name will be applied to future files on the aircraft storage.
Cache When Recording	When enabled, the liveview on the remote controller will be stored in the remote controller storage when recording video.
Max Video Cache Capacity	When the cache limit is reached, the earliest caches will be automatically deleted.

- Reset Camera Settings: tap to restore camera parameters to the default settings.
- USB Mode: Mavic 3 Pro Cine supports USB mode, enabling users to copy footage when the battery level of the aircraft is low. Power on the aircraft, enable USB mode in DJI Fly, and connect the aircraft to a computer to use USB mode. During this time, the storage of the aircraft can be accessed.

Disconnect the aircraft from the computer and restart the aircraft to exit USB mode. USB mode will be enabled once again when the aircraft is restarted and connected to a computer if it was disabled via DJI Assistant 2.

-
-  In USB mode, the aircraft will disconnect from the remote controller, the frame arm light will turn off, and the fan inside the aircraft will stop.
-

Transmission

A livestreaming platform can be selected to broadcast the camera view in real time. The HDMI output, frequency band, and channel mode can also be set in the transmission settings.

-
-  • Live streaming platforms and HDMI output are not supported when using DJI RC.
-

About

Displays information such as the Device Name, Wi-Fi Name, Model, App Version, Aircraft Firmware, RC Firmware, FlySafe Data, SN, etc.

Tap Reset All Settings to reset settings including camera, gimbal and safety settings to default.

Tap Clear All Data to reset all settings to default, and delete all the data stored in internal storage and microSD card, including flight log. It is recommended to provide proof (flight log) when claiming compensation. Contact DJI support before clearing the flight log if an accident occurs during flight.

-
-  • Fully charge the device before launching DJI Fly.
- Mobile cellular data is required when using DJI Fly. Contact your wireless carrier for data charges.
 - DO NOT accept phone calls or use texting features during flight if you are using a mobile phone as your display device.
 - Read all safety prompts, warning messages, and disclaimers carefully. Familiarize yourself with relevant regulations in your area. You are solely responsible for being aware of all relevant regulations and flying in a way that is compliant.
 - a. Read and understand the warning messages before using the auto-takeoff and auto-landing features.
 - b. Read and understand the warning messages and disclaimers before setting the altitude beyond the default limit.
 - c. Read and understand the warning messages and disclaimers before switching flight modes.
 - d. Read and understand the warning messages and disclaimer prompts near or in GEO zones.
 - e. Read and understand the warning messages before using the Intelligent Flight modes.
 - Land the aircraft immediately at a safe location if a prompt appears in the app instructing you to do so.
 - Review all warning messages on the checklist displayed in the app before each flight.
 - Use the in-app tutorial to practice your flight skills if you have never operated the aircraft or if you do not have sufficient experience to operate the aircraft with confidence.
 - The app is designed to assist your operation. Use sound discretion and DO NOT rely on the app to control the aircraft. The use of the app is subject to DJI Fly Terms of Use and DJI Privacy Policy. Read them carefully in the app.
-

Appendix

Appendix

Specifications

Aircraft

Takeoff Weight	Mavic 3 Pro: 958 g Mavic 3 Pro Cine: 963 g
Dimensions	Folded (without propellers): 231.1×98×95.4 mm Unfolded (without propellers): 347.5×290.8×107.7 mm
Max Ascent Speed	8 m/s
Max Descent Speed	6 m/s
Max Horizontal Speed (at sea level, no wind)	21 m/s
Max Takeoff Altitude	6000 m
Max Flight Time ^[1]	43 minutes
Max Hovering Time ^[2]	37 minutes
Max Flight Distance	28 km
Max Wind Speed	12 m/s
Resistance	
Max Tilt Angle	35°
Operating Temperature	-10° to 40° C (14° to 104° F)
GNSS	GPS + Galileo + BeiDou
Hovering Accuracy Range	Vertical: ±0.1 m (with vision positioning), ±0.5 m (with GNSS positioning) Horizontal: ±0.3 m (with vision positioning), ±0.5 m (with high-precision positioning system)
Internal Storage	Mavic 3 Pro: 8 GB (approx. 7.9GB available space) Mavic 3 Pro Cine: 1 TB (approx. 934.8GB available space)

Camera

Image Sensor	Hasselblad Camera: 4/3 CMOS, Effective Pixels: 20 MP Medium Tele Camera: 1/1.3-inch CMOS, Effective Pixels: 48 MP Tele Camera: 1/2-inch CMOS, Effective Pixels: 12 MP
--------------	---

Lens	Hasselblad Camera FOV: 84° Format Equivalent: 24 mm Aperture: f/2.8-f/11 Focus: 1 m to ∞
	Medium Tele Camera FOV: 35° Format Equivalent: 70 mm Aperture: f/2.8 Focus: 3 m to ∞

	Tele Camera FOV: 15° Format Equivalent: 166 mm Aperture: f/3.4 Focus: 3 m to ∞
ISO Range	Video Normal and Slow Motion: 100-6400 (Normal) 400-1600 (D-Log) 100-1600 (D-Log M) 100-1600 (HLG) Night: 800-12800 (Normal) Photo 100-6400
Shutter Speed	Hasselblad Camera: 8-1/8000 s Medium Tele Camera: 2-1/8000 s Tele Camera: 2-1/8000 s
Max Image Size	Hasselblad Camera: 5280×3956 Medium Tele Camera: 8064×6048 Tele Camera: 4000×3000
Still Photography Modes	Hasselblad Camera Single Shot: 20 MP Burst Shooting: 20 MP, 3/5/7 frames Automatic Exposure Bracketing (AEB): 20 MP, 3/5 frames at 0.7 EV step Timed: 20 MP, 2/3/5/7/10/15/20/30/60 s Medium Tele Camera Single Shot: 12 MP or 48 MP Burst Shooting: 12 MP or 48 MP, 3/5/7 frames Automatic Exposure Bracketing (AEB): 12 MP or 48 MP, 3/5 frames at 0.7 EV step Timed: 12 MP: 2/3/5/7/10/15/20/30/60 s 48 MP: 7/10/15/20/30/60 s Tele Camera Single Shot: 12 MP Burst Shooting: 12 MP, 3/5/7 frames Automatic Exposure Bracketing (AEB): 12 MP, 3/5 frames at 0.7 EV step Timed: 12 MP, 2/3/5/7/10/15/20/30/60 s
Photo Format	JPEG/DNG (RAW)

Video Resolution	<p>Hasselblad Camera Apple ProRes 422 HQ Apple ProRes 422 Apple ProRes 422 LT 5.1K: 5120×2700@24/25/30/48/50fps DCI 4K: 4096×2160@24/25/30/48/50/60/120*fps 4K: 3840×2160@24/25/30/48/50/60/120*fps</p> <p>H.264/H.265 5.1K: 5120×2700@24/25/30/48/50fps DCI 4K: 4096×2160@24/25/30/48/50/60/120*fps 4K: 3840×2160@24/25/30/48/50/60/120*fps FHD: 1920×1080@24/25/30/48/50/60/120*/200*fps</p> <p>* Recording frame rates. The corresponding video plays as slow-motion video.</p> <p>Medium Tele Camera Apple ProRes 422 HQ Apple ProRes 422 Apple ProRes 422 LT 4K: 3840×2160@24/25/30/48/50/60fps</p> <p>H.264/H.265 4K: 3840×2160@24/25/30/48/50/60fps FHD: 1920×1080@24/25/30/48/50/60fps</p> <p>Tele Camera Apple ProRes 422 HQ Apple ProRes 422 Apple ProRes 422 LT 4K: 3840×2160@24/25/30/48/50/60fps</p> <p>H.264/H.265 4K: 3840×2160@24/25/30/50/60fps FHD: 1920×1080@24/25/30/50/60fps</p>
Video Format	MP4/MOV (MPEG-4 AVC/H.264, HEVC/H.265) MOV (Apple ProRes 422 HQ/422/422 LT)
Max Video Bitrate	H.264/H.265: 200 Mbps Apple ProRes 422 HQ: 3772 Mbps Apple ProRes 422: 2514 Mbps Apple ProRes 422 LT: 1750 Mbps
Supported File System	exFAT

Color Mode and Sampling Method	Hasselblad Camera
	Normal: 10-bit 4:2:2 (Apple ProRes 422 HQ/422/422 LT) 8-bit 4:2:0 (H.264/H.265) D-Log: 10-bit 4:2:2 (Apple ProRes 422 HQ/422/422 LT) 10-bit 4:2:0 (H.264/H.265) HLG/D-Log M: 10-bit 4:2:2 (Apple ProRes 422 HQ/422/422 LT) 10-bit 4:2:0 (H.265)
	Medium Tele Camera
	Normal: 10-bit 4:2:2 (Apple ProRes 422 HQ/422/422 LT) 8-bit 4:2:0 (H.264/H.265) HLG/D-Log M: 10-bit 4:2:2 (Apple ProRes 422 HQ/422/422 LT) 10-bit 4:2:0 (H.265)
	Tele Camera
	Normal: 10-bit 4:2:2 (Apple ProRes 422 HQ/422/422 LT) 8-bit 4:2:0 (H.264/H.265)

Digital Zoom (only in Normal Video Mode and Explore Mode)	Hasselblad Camera: 1-3× Medium Tele Camera: 3-7× Tele Camera: 7-28×
---	---

Gimbal

Stabilization	3-axis mechanical gimbal (tilt, roll, pan)
---------------	--

Mechanical Range	Tilt: -140° to 50° Roll: -50° to 50° Pan: -23° to 23°
------------------	---

Controllable Range	Tilt: -90° to 35° Pan: -5° to 5°
--------------------	-------------------------------------

Max Control Speed (tilt)	100°/s
--------------------------	--------

Angular Vibration Range	Hovering Without Wind: $\pm 0.001^\circ$ Normal Mode: $\pm 0.003^\circ$ Sport Mode: $\pm 0.005^\circ$
-------------------------	---

Sensing

Sensing Type	Omnidirectional binocular vision system, supplemented with an infrared sensor at the bottom of the aircraft
--------------	---

Forward	Measurement Range: 0.5-20 m Detection Range: 0.5-200 m Effective Sensing Speed: Flight Speed ≤ 15 m/s FOV: Horizontal 90°, Vertical 103°
---------	--

Backward	Measurement Range: 0.5-16 m Effective Sensing Speed: Flight Speed ≤ 12 m/s FOV: Horizontal 90°, Vertical 103°
Lateral	Measurement Range: 0.5-25 m Effective Sensing Speed: Flight Speed ≤ 15 m/s FOV: Horizontal 90°, Vertical 85°
Upward	Measurement Range: 0.2-10 m Effective Sensing Speed: Flight Speed ≤ 6 m/s FOV: Front and Back 100°, Left and Right 90°
Downward	Measurement Range: 0.3-18 m Effective Sensing Speed: Flight Speed ≤ 6 m/s FOV: Front and Back 130°, Left and Right 160°
Operating Environment	Forward, Backward, Left, Right, and Upward: surfaces with discernible patterns and adequate lighting (lux > 15) Downward: surfaces with discernible patterns, diffuse reflectivity > 20% (e.g. walls, trees, people), and adequate lighting (lux > 15)

Video Transmission

Video Transmission System	O3+
Live View Quality	Remote Controller: 1080p/30fps, 1080p/60fps
Operating Frequency ^[3]	2.400-2.4835 GHz, 5.725-5.850 GHz
Transmitter Power (EIRP)	2.4 GHz: <33 dBm (FCC), <20 dBm (CE/SRRC/MIC) 5.8 GHz: <33 dBm (FCC), <14 dBm (CE), <30 dBm (SRRC)
Max Transmission Distance (unobstructed, free of interference) ^[4]	15 km (FCC), 8 km (CE/SRRC/MIC)
Max Transmission Distance (unobstructed, with interference) ^[5]	Strong Interference: urban landscape, approx. 1.5-3 km Medium Interference: suburban landscape, approx. 3-9 km Low Interference: suburb/seaside, approx. 9-15 km
Max Transmission Distance (obstructed, with interference) ^[6]	Low Interference and Obstructed by Buildings: approx. 0-0.5 km Low Interference and Obstructed by Trees: approx. 0.5-3 km
Max Download Speed	O3+: 5.5 MB/s (with DJI RC-N1 Remote Controller) 15 MB/s (with DJI RC Pro) 5.5 MB/s (with DJI RC) Wi-Fi 6: 80 MB/s*
	* Measured in a laboratory environment with little interference in countries/regions that support both 2.4 GHz and 5.8 GHz, with footage saved to the internal storage. Download speeds may vary depending on the actual conditions.

Lowest Latency ^[7]	130 ms (with DJI RC-N1 Remote Controller) 120 ms (with DJI RC Pro) 130 ms (with DJI RC)
Antenna	4 antennas, 2T4R
Storage	
Recommended microSD Cards	Lexar 1066x 64GB V30 A2 microSDXC Lexar 1066x 128GB V30 A2 microSDXC Lexar 1066x 256GB V30 A2 microSDXC Lexar 1066x 512GB V30 A2 microSDXC SanDisk High Endurance 64GB V30 microSDXC SanDisk High Endurance 128GB V30 microSDXC SanDisk High Endurance 256GB V30 microSDXC Kingston Canvas Go! Plus 64GB V30 A2 microSDXC Kingston Canvas Go! Plus 128GB V30 A2 microSDXC Kingston Canvas Go! Plus 256GB V30 A2 microSDXC Kingston Canvas Go! Plus 512GB V30 A2 microSDXC Samsung EVO Plus 512GB V30 A2 microSDXC Samsung PRO Plus 256GB V30 A2 microSDXC Samsung PRO Plus 512GB V30 A2 microSDXC
Intelligent Flight Battery	
Capacity	5000 mAh
Weight	335.5 g
Nominal Voltage	15.4 V
Max Charging Voltage	17.6 V
Type	Li-ion 4S
Chemical System	LiCoO2
Energy	77 Wh
Charging Temperature	5° to 40° C (41° to 104° F)
Charging Time	Use the included data cable of the DJI 65W Portable Charger: Approx. 96 minutes Use the DJI 100W USB-C Power Adapter and DJI Mavic 3 Series 100W Battery Charging Hub: Approx. 70 minutes
Charger	
Input	DJI 65W Portable Charger: 100-240 V AC, 50-60 Hz, 2 A DJI 100W USB-C Power Adapter: 100-240 V AC, 50-60 Hz, 2.5 A
Output	DJI 65W Portable Charger: USB-C: 5 V = 5 A / 9 V = 5 A / 12 V = 5 A / 15 V = 4.3 A / 20 V = 3.25 A / 5 V~20 V = 3.25 A USB-A: 5.0 V = 2.0 A

DJI 100W USB-C Power Adapter:

Max 100 W (total)

When both ports are used, the max output power of one port is 82 W, and the charger will dynamically allocate the output power of the two ports according to the power load.

Rated Power	DJI 65W Portable Charger: 65 W DJI 100W USB-C Power Adapter: 100 W
-------------	---

DJI RC Pro

Operating Temperature	-10° to 40° C (14° to 104° F)
-----------------------	-------------------------------

GNSS	GPS + Galileo + GLONASS
------	-------------------------

Battery	Li-ion (5000 mAh @ 7.2 V)
---------	---------------------------

Battery Type	Li-ion
--------------	--------

Chemical System	LiNiMnCoO2
-----------------	------------

Operating Time	Approx. 3 hours
----------------	-----------------

Storage Capacity	Internal Storage (ROM): 64 GB Support microSD card to expand capacity
------------------	--

Video Transmission

Video Transmission System	O3+
---------------------------	-----

Operating Frequency ^[3]	2.400-2.4835 GHz, 5.725-5.850 GHz
------------------------------------	-----------------------------------

Transmitter Power (EIRP)	2.4 GHz: <33 dBm (FCC), <20 dBm (CE/SRRC/MIC) 5.8 GHz: <33 dBm (FCC), <14 dBm (CE), <23 dBm (SRRC)
--------------------------	---

Wi-Fi

Protocol	802.11 a/b/g/n/ac/ax Support 2x2 MIMO Wi-Fi
----------	--

Operating Frequency ^[3]	2.400-2.4835 GHz, 5.725-5.850 GHz
------------------------------------	-----------------------------------

Transmitter Power (EIRP)	2.4 GHz: <26 dBm (FCC), <20 dBm (CE/SRRC/MIC) 5.8 GHz: <26 dBm (FCC/SRRC), <14 dBm (CE)
--------------------------	--

Bluetooth

Protocol	Bluetooth 5.1
----------	---------------

Operating Frequency	2.400-2.4835 GHz
---------------------	------------------

Transmitter Power (EIRP)	<10 dBm
--------------------------	---------

DJI RC

Operating Temperature	-10° to 40° C (14° to 104° F)
-----------------------	-------------------------------

GNSS	GPS + Galileo + BeiDou
------	------------------------

Battery	5200 mAh
---------	----------

Battery Type	Li-ion
--------------	--------

Chemical System	LiNiMnCoO2
-----------------	------------

Operating Time	Approx. 4 hours
Storage Capacity	Support microSD card to expand capacity

Video Transmission

Video Transmission System	When used with different aircraft hardware configurations, the DJI RC Remote Controller will automatically select the corresponding firmware version for updating. It supports the O3+ transmission technology when linked with DJI Mavic 3 Pro.
---------------------------	--

Operating Frequency ^[3]	2.400-2.4835 GHz, 5.725-5.850 GHz
Transmitter Power (EIRP)	2.4 GHz: <26 dBm (FCC), <20 dBm (CE/SRRC/MIC) 5.8 GHz: <26 dBm (FCC), <14 dBm (CE), <23 dBm (SRRC)

Wi-Fi

Protocol	802.11 a/b/g/n
Operating Frequency ^[3]	2.400-2.4835 GHz, 5.150-5.250 GHz, 5.725-5.850 GHz
Transmitter Power (EIRP)	2.4 GHz: <23 dBm (FCC), <20 dBm (CE/SRRC/MIC) 5.1 GHz: <23 dBm (FCC/CE/SRRC/MIC) 5.8 GHz: <23 dBm (FCC/SRRC), <14 dBm (CE)

Bluetooth

Protocol	Bluetooth 4.2
Operating Frequency	2.400-2.4835 GHz
Transmitter Power (EIRP)	<10 dBm

- [1] Measured in a controlled test environment. Specific test conditions are as follows: flying at a constant speed of 32.4 kph in a windless environment at sea level, with APAS off, AirSense off, camera parameters set to 1080p/24fps, video mode off, and from 100% battery level until 0%. Results may vary depending on the environment, actual use, and firmware version.
- [2] Measured in a controlled test environment. Specific test conditions are as follows: hovering in a windless environment at sea level, with APAS off, AirSense off, camera parameters set to 1080p/24fps, video mode off, and from 100% battery level until 0%. Results may vary depending on the environment, actual use, and firmware version.
- [3] In some countries and regions, the 5.8 and 5.1GHz frequencies are prohibited, or the 5.1GHz frequency is only allowed for indoor use. Check local laws and regulations for more information.
- [4] Measured in an unobstructed outdoor environment free of interference. The above data shows the farthest communication range for one-way, non-return flights under each standard. During your flight, please pay attention to RTH reminders in the DJI Fly app.
- [5] Data tested under FCC standard in unobstructed environments with typical interference. Used for reference purposes only and provides no guarantee for actual transmission distance.
- [6] Data tested under FCC standard in environments with typical low interference. Used for reference purposes only and provides no guarantee for actual transmission distance.
- [7] Depending on the actual environment and mobile device.

Camera Function Matrix

		Hasselblad Camera	Medium Tele Camera	Tele Camera
Photo	Single Shot	√	√	√
	Burst Shooting	√	√	√
	AEB	√	√	√
	Timed	√	√	√
	DNG	√	√	√
	Pano	√	×	×
	Hyperlapse	√	√	×
Video	Slow Motion	4K 120fps C4K 120fps 1080p 200fps	×	×
	Color Mode	Hasselblad HNCS D-Log D-Log M HLG	Normal D-Log M HLG	Normal
	Night Mode	√	×	×
	QuickShots	√	×	×
	MasterShots	√	×	×
	FocusTrack	√	√	Only supports Spotlight and POI, ActiveTrack is not supported

Firmware Update

Use DJI Fly or DJI Assistant 2 (Consumer Drones Series) to update the aircraft firmware.

Using DJI Fly

When connecting the aircraft or remote controller to DJI Fly, you will be notified if a new firmware update is available. To start updating, connect your remote controller or mobile device to the internet and follow the on-screen instructions. Note that you cannot update the firmware if the remote controller is not linked to the aircraft. An internet connection is required.

Using DJI Assistant 2 (Consumer Drones Series)

Update the aircraft and remote controller firmware separately using DJI Assistant 2 (Consumer Drones Series).

Follow the instructions below to update the aircraft firmware:

1. Launch DJI Assistant 2 (Consumer Drones Series) and log in with your DJI account.
2. Power on the aircraft and connect the aircraft to the computer via the USB-C port within 20 seconds.
3. Select DJI Mavic 3 Pro and click Firmware Updates.
4. Select the firmware version.
5. Wait for the firmware to download. The firmware update will start automatically.
6. The aircraft will reboot automatically after the firmware update is complete.

Follow the instructions below to update the remote controller firmware:

1. Launch DJI Assistant 2 (Consumer Drones Series) and log in with your DJI account.
2. Power on the remote controller and connect it to the computer via the USB-C port.
3. Select DJI Mavic 3 Pro Remote Controller and click Firmware Updates.
4. Select the firmware version.
5. Wait for the firmware to download. The firmware update will start automatically.
6. Wait for the firmware update to be completed.

-
-  • The battery firmware is included in the aircraft firmware. Be sure to update all batteries.
- Make sure follow all the steps to update firmware. Otherwise, the update may fail.
 - Make sure the computer is connected to the internet during the update.
 - Before performing an update, make sure the Intelligent Flight Battery is at least 40% charged and the remote controller is at least 30% charged.
 - DO NOT unplug the USB-C cable during an update.
 - The firmware update will take approximately ten minutes. It is normal that the gimbal goes limp, aircraft status indicators blink, and the aircraft reboots. Wait patiently until the update is complete.
-

Refer to the Mavic 3 Pro Release Notes for more firmware update information for Traceability.

Post-Flight Checklist

- Make sure to perform a visual inspection so that the aircraft, remote controller, gimbal camera, Intelligent Flight Batteries, and propellers are in good condition. Contact DJI support if any damage is noticed.
- Make sure that the camera lens and vision system sensors are clean.
- Make sure to store aircraft correctly before transporting it.

Maintenance Instructions

To avoid serious injury to children and animals, observe the following rule:

1. Small parts, such as cables and straps, are dangerous if swallowed. Keep all parts out of reach of children and animals.
2. Store the Intelligent Flight Battery and remote controller in a cool, dry place away from direct sunlight to ensure the built-in LiPo battery does NOT overheat. Recommended storage temperature: between 22° and 28° C (71° and 82° F) for storage periods of more than three months. Never store in environments outside the temperature range of 14° to 113° F (-10° to 45° C).
3. DO NOT allow the camera to come into contact with or become immersed in water or other liquids. If it gets wet, wipe dry with a soft, absorbent cloth. Turning on an aircraft that has fallen in water may cause permanent component damage. DO NOT use substances containing alcohol, benzene, thinners, or other flammable substances to clean or maintain the camera. DO NOT store the camera in humid or dusty areas.
4. DO NOT connect this product to any USB interface older than version 3.0. DO NOT connect this product to any “power USB” or similar devices.
5. Check every aircraft part after any crash or serious impact. If there are any problems or questions, contact a DJI authorized dealer.
6. Regularly check the Battery Level Indicators to see the current battery level and overall battery life. The battery is rated for 200 cycles. It is not recommended to continue use afterward.
7. Make sure to transport the aircraft with the arms folded when powered off.
8. Make sure to transport the remote controller with antennas folded when powered off.
9. The battery will enter sleep mode after long-term storage. Charge the battery to exit from sleep mode.
10. Use the ND filter if the exposure time needs to be prolonged. Refer to the product information on how to install the ND filters.
11. Store and transport the aircraft, remote controller, battery, and charger in a dry environment. It is recommended to store and transport the product in an environment with an ambient temperature of 15° to 25° C and a humidity of about 40%.
12. Remove the battery before servicing the aircraft (e.g., cleaning or attaching and detaching the propellers). Make sure that the aircraft and the propellers are clean by removing any dirt or dust with a soft cloth. Do not clean the aircraft with a wet cloth or use a cleanser that

contains alcohol. Liquids can penetrate the aircraft housing, which can cause a short circuit and destroy the electronics.

13. Make sure to turn off the battery to replace or to check the propellers.

Troubleshooting Procedures

1. Why can the battery not be used before the first flight?
The battery must be activated by charging before using it for the first time.
2. How to solve the gimbal drift issue during flight?
Calibrate IMU and compass in DJI Fly. If the problem persists, contact DJI Support.
3. No function
Check if the Intelligent Flight battery and the remote controller are activated by charging. If the problems persist, contact DJI support.
4. Power-on and start-up problems
Check if the battery has power. If yes, contact DJI support if it cannot be started normally.
5. SW update issues
Follow the instructions in the user manual to update the firmware. If the firmware update fails, restart all the devices and try again. If the problem persists, contact DJI support.
6. Procedures to reset to factory default or last known working configuration
Use the DJI Fly app to reset to factory default.
7. Shutdown and power-off problems
Contact DJI support.
8. How to detect careless handling or storage in unsafe conditions
Contact DJI support.

Risk and Warnings

When the aircraft detects a risk after powering on, there will be a warning prompt on DJI Fly.

Pay attention to the list of situations below.

1. If the location is not suitable for takeoff.
2. If an obstacle is detected during flight.
3. If the location is not suitable for landing.
4. If the compass and IMU experience interference and need to be calibrated.
5. Follow the on-screen instructions when prompted.

Disposal



Observe the local regulations related to electronic devices when disposing of the aircraft and remote controller.

Battery Disposal

Dispose of the batteries in specific recycling containers only after a complete discharge. DO NOT dispose of the batteries in regular trash containers. Strictly follow the local regulations regarding the disposal and recycling of batteries.

Dispose of a battery immediately if it cannot be powered on after over-discharging.

If the power on/off button on the Intelligent Flight Battery is disabled and the battery cannot be fully discharged, contact a professional battery disposal/recycling agency for further assistance.

C2 Certification

Mavic 3 Pro is comply with C2 certification, there are some requirements and restrictions when using Mavic 3 Pro in European Economic Area (EEA, i.e. EU plus Norway, Iceland and Liechtenstein). Mavic 3 Pro/Mavic 3 Pro Cine and its similar products are distinguished by model name.

UAS Class	C2
Sound Power Level	82 dB
Maximum Propeller Speed	7500 RPM

MTOM Statement

The MTOM of Mavic 3 Pro (Model L2S)/Mavic 3 Pro Cine (Model L2E), including the SD card, is 895 g (Model L2S)/963 g (Model L2E) to comply with C2 requirements.

Users must follow the instructions below to comply with the MTOM C2 requirements.

Otherwise, the aircraft cannot be used as a C2 UAV:

1. DO NOT add any payload to the aircraft, such as the propeller guards, etc.
2. DO NOT use any non-qualified replacement parts, such as Intelligent Flight Batteries or propellers, etc.
3. DO NOT retrofit the aircraft.

-
- The prompt "Low Battery RTH" will not appear in case of a horizontal distance between the pilot and aircraft is lower than 5 m.
- FocusTrack will exit automatically if the horizontal distance between the subject and the aircraft is further than 50 m (only available when using FocusTrack in the EU).
 - The auxiliary LED is set to auto when used in the EU and cannot be changed. The aircraft Front Arm LEDs are always on when used in the EU and cannot be changed.

- The maximum flight speed of RTH is 16 m/s, and the maximum flight speed of Waypoint Flight is 15 m/s.
-

Direct Remote ID

1. Transport Method: Wi-Fi Beacon
2. Method of uploading the UAS Operator Registration Number to the aircraft: Enter DJI Fly > Safety > UAS Remote Identification, and then upload UAS Operator Registration Number.

List of Items, including qualified accessories

1. DJI Mavic 3 Low-Noise Propellers (Model: 9453F, 8.5g)
2. DJI Mavic 3 Pro ND Filters Set (ND 8/16/32/64) (5.1 g)
3. DJI Mavic 3 Intelligent Flight Battery (Model: BWX260-5000-15.4, 335.5 g)

List of Spare and Replacement Parts

1. DJI Mavic 3 Low-Noise Propellers (Model: 9453F)
2. DJI Mavic 3 Intelligent Flight Battery (Model: BWX260-5000-15.4)

Remote Controller Warnings

The remote controller indicator will glow red after disconnecting from the aircraft for more than two seconds.

DJI Fly will prompt a warning after disconnecting from the aircraft for more than 4.5 seconds.

The remote controller will beep and power off automatically after disconnecting from the aircraft or without operation for a long time.



- Avoid interference between the remote controller and other wireless equipment. Make sure to turn off the Wi-Fi on nearby mobile devices. Land the aircraft as soon as possible if there is interference.
 - DO NOT operate the aircraft if lighting conditions are too bright or dark when using a mobile phone to monitor the flight. Users are responsible for correctly adjusting the display brightness when using the monitor in direct sunlight during flight operation.
 - Release the control sticks or press the flight pause button if an unexpected operation occurs.
-

GEO Awareness

GEO Awareness contains the features listed below.

UGZ (Unmanned Geographical Zone) Data update: user can update the fly safe data through GPS by using the data update feature and store the data in the aircraft.

GEO Awareness Map Drawing: after the latest UGZ data is updated, a flight map with a restricted zone will be displayed in the DJI Fly app. Name, effective time, height limit, etc., can be viewed by tapping the area.

GEO Awareness Pre-Warning: the app will prompt the user with warning information when the

aircraft is near or in a restricted area, the horizontal distance is less than 160 m, or the vertical distance is less than 40 m from the zone to remind the user to fly with caution.

AGL (Above Ground Level) Statement

The vertical part of “Geo-awareness” may use the AMSL altitude or the AGL height. The choice between these two references is specified individually for each UGZ. Neither AMSL altitude nor the AGL height is supported by DJI Mavic 3 Pro. The height H appears in the DJI Fly app camera view, which is the height from the aircraft takeoff point to the aircraft. The height above the takeoff point may be used as an approximation but may differ more or less from the given altitude/height for a specific UGZ. The remote pilot remains responsible for not breaching the vertical limits of the UGZ.

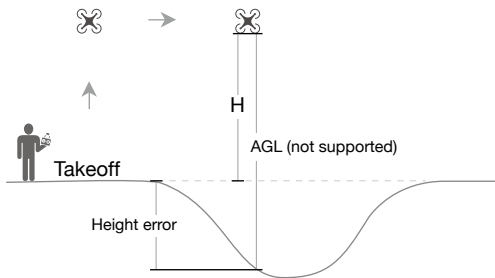

Restricted Zones

Appear red in the DJI app. Users will be prompted with a warning, and flight is prevented. UA cannot fly or takeoff in these zones. Restricted Zones may be unlocked, to unlock contact flysafed@DJI.com or go to Unlock A Zone at DJI.com/flysafed.

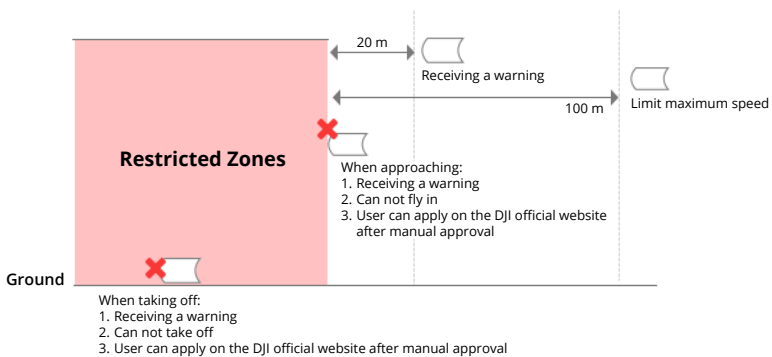

Authorization Zones

Appear blue in the DJI app. Users will be prompted with a warning, and flight is limited by default. UA cannot fly or takeoff in these zones unless authorized. Authorization Zones may be unlocked by authorized users using a DJI verified account.

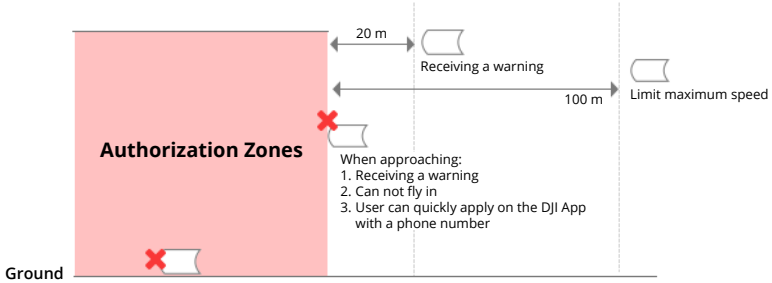

Altitude Zones

Altitude zones are zones with a limited altitude and appear in gray on the map. When approaching, users receive warnings in the DJI app.

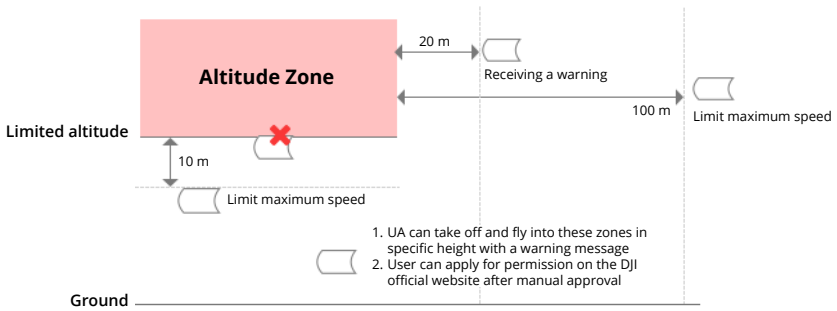

Enhanced Warning Zones

A warning message will prompt users when the drone reaches the edge of the zone.



Warning Zones

A warning message will prompt users when the drone reaches the edge of the zone.

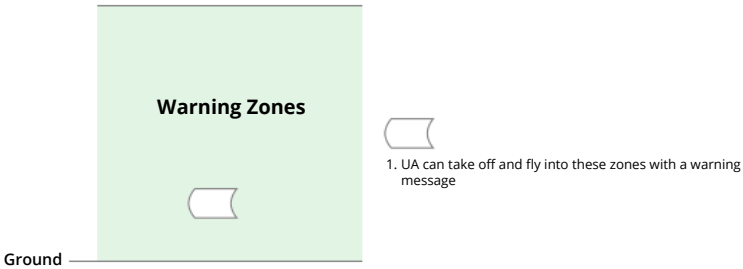

-
- ⚠ • When the aircraft and DJI Fly app cannot obtain a GPS signal, the GEO awareness function will be inoperative. Interference of the aircraft antenna or disabling the GPS authorization in DJI Fly will cause the GPS signal fails to be obtained.
-

EASA Notice

Make sure to read the Drone Information Notices document included in the package before use.

Visit the link below for more EASA notice information on traceability.

<https://www.easa.europa.eu/en/document-library/general-publications/drones-information-notices>

Original Instructions

This manual is provided by SZ DJI Technology, Inc., and the content is subject to change.

Address: Lobby of T2, DJI Sky City, No. 53 Xianyuan Road, Xili Community, Xili Street, Nanshan District, Shenzhen, China, 518055.

FAR Remote ID Compliance Information

The aircraft complies with the requirements of 14 CFR Part 89:

- The aircraft automatically broadcasts Remote ID messages from takeoff to shut down. An external device such as a cell phone or tablet is required to be connected as a location source to DJI mobile devices without an integrated GNSS system^[1], and must run the DJI flight control app such as DJI Fly in the foreground and always allow the DJI flight control app to obtain its accurate location information. The connected external device must minimally be one of the following:
 - 1) FCC Certified personal wireless device that uses GPS with SBAS (WAAS) for location services; or
 - 2) FCC Certified personal wireless device with integrated GNSS.Also, the external device must be operated in a way that does not interfere with the location reported and its correlation to the operator location.
- The aircraft automatically initiates a pre-flight self-test (PFST) of the Remote ID system before takeoff and cannot take off if it does not pass the PFST^[2]. The results of the PFST of the Remote ID system can be viewed in either a DJI flight control app such as DJI Fly or DJI goggles.
- The aircraft monitors the Remote ID system functionality from pre-flight to shut down. If the Remote ID system malfunctions or has a failure, an alarm will be displayed in either a DJI flight control app such as DJI Fly or DJI goggles.

Footnotes

- [1] DJI mobile devices without an integrated GNSS system such as DJI RC-N1, DJI FPV Goggles V2, and DJI Goggles 2.
- [2] The pass criterion for PFST is that the hardware and software of the Remote ID required-data source and radio transmitter in the Remote ID system are functioning properly.

After-Sales Information

Visit <https://www.dji.com/support> to learn more about after-sales service policies, repair services, and support.

WE ARE HERE FOR YOU



Contact
DJI SUPPORT

Trademark Recognition



The Adopted Trademarks HDMI, HDMI High-Definition Multimedia Interface, and the HDMI Logo are trademarks or registered trademarks of HDMI Licensing Administrator, Inc. in the United States and other countries

This content is subject to change.

<https://www.dji.com/mavic-3-pro/downloads>

If you have any questions about this document, please contact DJI by sending a message to **DocSupport@dji.com**.

DJI and MAVIC are trademarks of DJI.

Copyright © 2023 DJI All Rights Reserved.