

dyson v12 detect slim

User manual

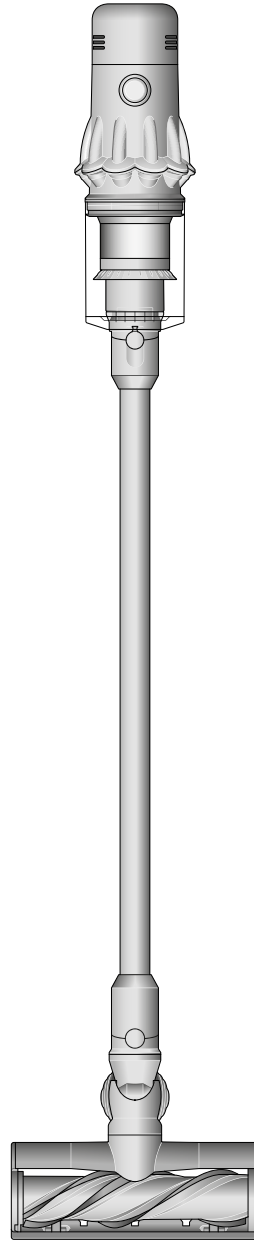

Contents

In the box

Getting started

The LCD screen

Caring for your floors

Charging your machine

Changing your click-in battery

Emptying your bin

Cleaning your bin

Clearing blockages

Clearing obstructions from your

Motorbar™ cleaner head

Clearing blockages from your

Hair screw tool

Washing your filter

Washing your Illuminated

cleaner head brush bar

Cleaning your tools

Looking after your machine

In the box

Your machine will come with one or more of these cleaner heads – not all will be included.

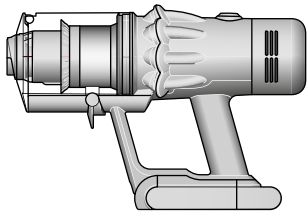

Vacuum cleaner

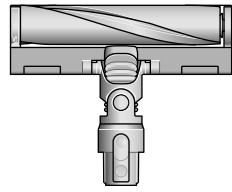

Illuminated cleaner head
The illuminated cleaner head makes invisible dust visible on hard floors.

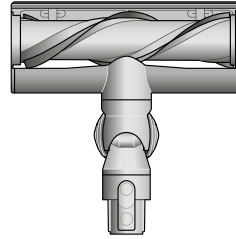

Motorbar™ cleaner head
De-tangling vanes automatically clear wrapped hair from the brush bar as you clean.

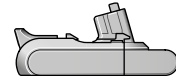

Additional click-in battery



Wand



Charger
Charges your vacuum with or without a dock.

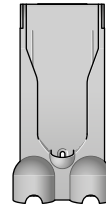

Wall dock
The Dyson cordless vacuum drops into the wall-mounted charging dock, ready for your next clean.

Some tools may not be included.

You can buy additional tools at www.dyson.com.



Combination tool
Two tools in one – wide nozzle and brush, for quick switching between cleaning and dusting tasks around your home or car.



Crevice tool
Engineered for precise cleaning around tricky edges and into hard-to-reach narrow spaces.



Extension hose
Adds up to 61cm of flexible reach to any tool attachment, to clean up high or down low in your home or car.

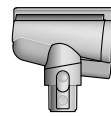

Hair screw tool
Anti-tangle conical brush bar spirals hair off and into the bin. Motor-driven cleaning for smaller spaces.



Low-reach adaptor
Bends to comfortably reach down low. Engineered to clean further under low furniture by adjusting the wand angle up to 90°.



Light pipe crevice tool
Crevice tool with LED lights lets you reach into dark, narrow spaces and see where you're cleaning.



Soft dusting brush
Enclosed in a skirt of soft nylon bristles for gentle, vacuum-assisted dusting of delicate objects and surfaces.



Stubborn dirt brush
Stiff nylon bristles dislodge ground-in dirt from coarse carpets, high traffic areas and car interiors.



Up-top adaptor
Bends and locks at different angles. Fits any compatible tool for effective cleaning in hard-to-reach high areas of your home.

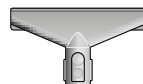

Fabric and mattress tool
Removes dust, dirt and allergens from mattresses and upholstery.



Wand clip
Clips to your vacuum's wand to hold tools.

Getting started

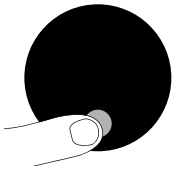

Power modes

Your machine has three power modes for different tasks. Change power modes quickly using a single button.



Eco mode

Maximum run time for longer cleans all around your home.



Auto and Med mode

The optimum balance of power and run time. Attach your cleaner head or Hair screw tool to activate Auto mode. Suction power automatically adapts to dust levels.



Boost mode

Designed for intensive spot cleaning of ground-in dirt.

Turn your laser on and off

Turn your laser on or off with the slider switch on your cleaner head.

Class 1 laser product – safe for pets and humans. Avoid looking directly into the beam.

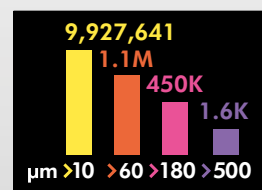
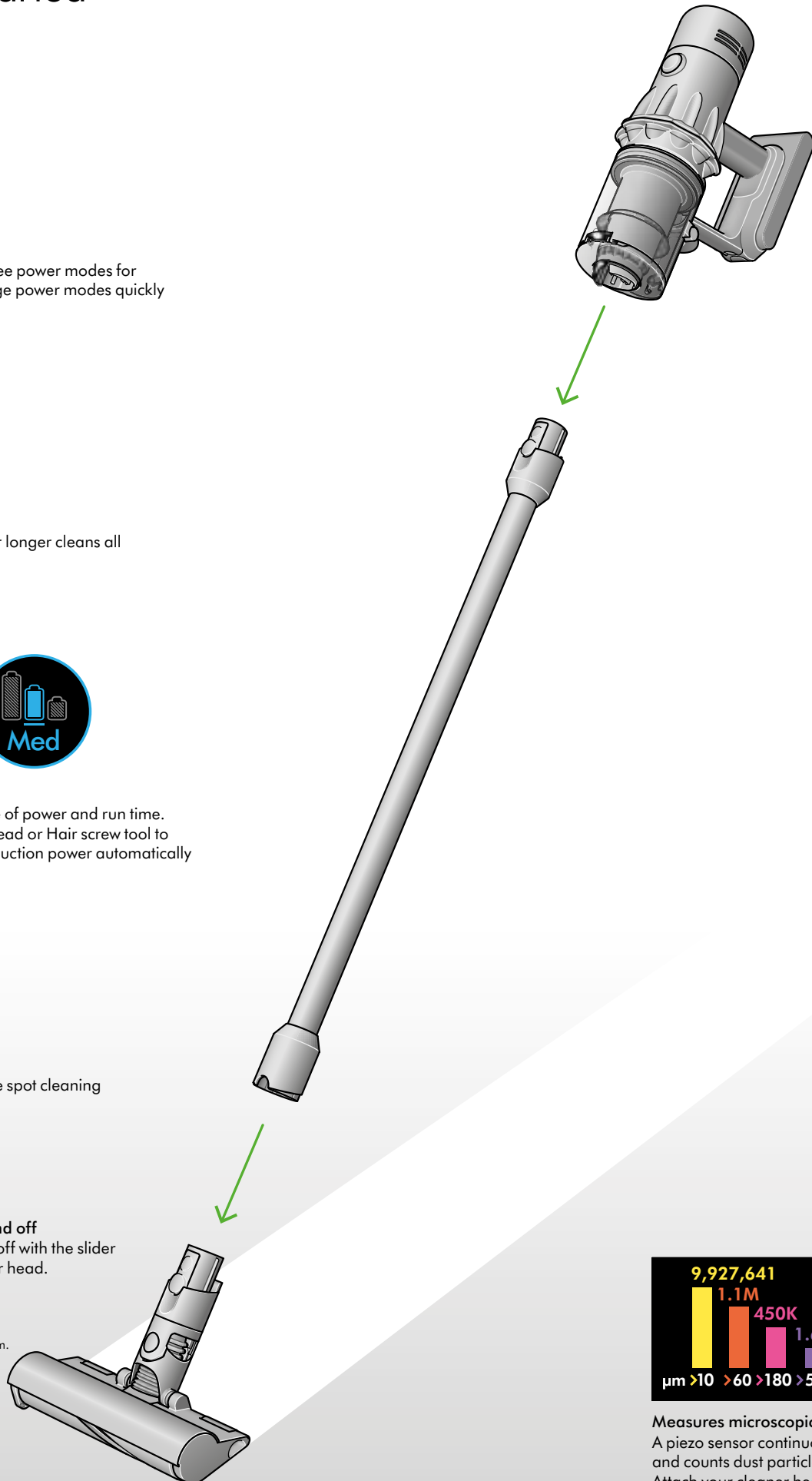

Measures microscopic dust particles

A piezo sensor continuously sizes and counts dust particles at the inlet. Attach your cleaner head or Hair screw tool and use in Auto mode to automatically increase suction power when needed.

The LCD screen

The LCD screen shows your particle count information and performance, including the cleaning mode selected, remaining run time, filter maintenance and blockage information.

Settings menu

Control the settings on your machine using the button. To enter the settings menu, press and hold the button until the menu screen appears. Tap to scroll through the options available.

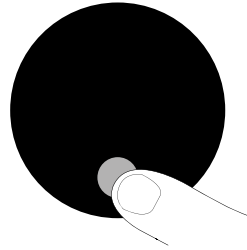

Particle count and graph

Select to turn the measuring and counting of particles on and off. Turn off the measuring and counting of particles to stop your machine automatically adjusting suction power and turn off the graph.

Adjust reactive suction power sensitivity.

Use the selection button to change how sensitive the particle count is. This will change how your machine automatically reacts to the dust particles.

For more information and support for your machine go online: www.dyson.com/support

Change language

To change the language on your screen, press the button and hold until the language list appears. Release the button.

Tap the button to scroll through the language list to your preferred language. Press and hold the button until the countdown ends.

A green tick will appear on the screen to show your language selection is complete.

To cancel your selection, release the button during the countdown.



Change alert settings

You can turn the alert motor pulse off. Your motor will no longer pulse but run time alert information will continue to be displayed on the LCD screen when your machine needs your attention.

Turning off alerts will not turn off the blockage alert pulsing. This is to ensure you clear any blockages, preventing damage to your machine.

Tap to scroll through the settings menu. Select the 'Alerts' option.

Scroll to select on or off. Hold the button until the countdown ends and a tick appears on the screen. To cancel your selection, release the button during the countdown

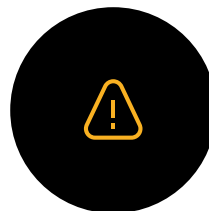

Run time countdown

When the battery needs charging, your machine will pulse three times and a low run time icon will appear on the screen.

When your battery is empty, a red warning icon will appear on the screen.

When Particle count and graph is turned on, low run time will be in amber and red when in Boost mode.

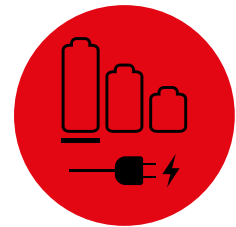

Battery health

To get the best performance and life from your battery, use Eco or Auto/Med mode.



Alerts

The alerts you might see are:

Filter – the filter isn't fitted correctly, or needs cleaning.

Blockage – your machine has a blockage that needs removing.



Exit settings menu

To exit the settings menu, tap to scroll through the selection menu. Select 'Exit menu'.

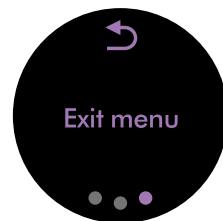

Caring for your floors

Check that the underside of the cleaner head or tool is clean and free from any objects that may cause damage.

Before vacuuming your flooring, rugs, and carpets, check the manufacturer's recommended cleaning instructions.

The brush bar on your machine can damage certain carpet types and floors. Some carpets will fuzz if a rotating brush bar is used when vacuuming. If this happens, we recommend vacuuming without the motorised floor tool and consulting with your flooring manufacturer.

Charging your machine

It's important to fully charge your new machine before using it for the first time, and after every clean. This is because the battery and monitoring system's algorithm 'learns' over time, and fully charging your machine helps it to more accurately calculate and display remaining run time.

Connect to the charger either directly or in the dock.

The blue LEDs on either side of the battery will flash during charging.

When the battery is fully charged, both LEDs will light for 5 seconds.

Your battery is fully charged when the display shows 100%.

Your machine won't operate or charge if the ambient temperature is below 5°C (41°F). This is designed to protect both the motor and battery.

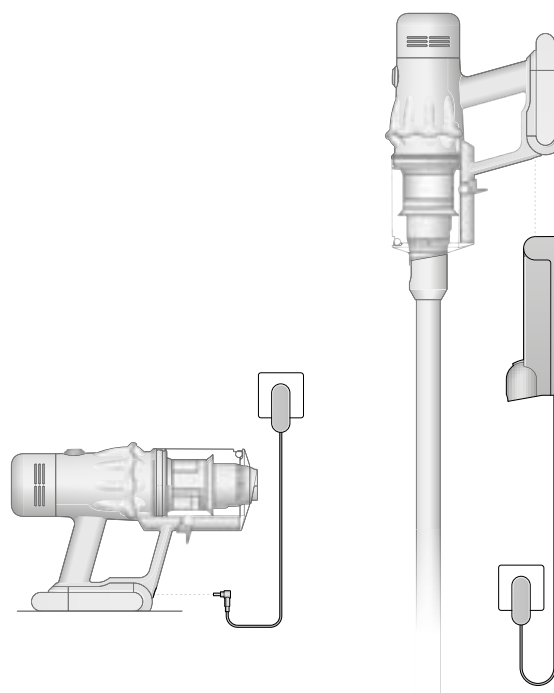

Changing your click-in battery

If you have additional click-in batteries, we recommend that you alternate the batteries to maintain even performance.

Removing your battery

Push the Battery release button on the handle and slide the battery off your machine.

Charge the battery.

Refitting your battery

Align your battery with the handle and slide it in. Push firmly until it clicks into place.

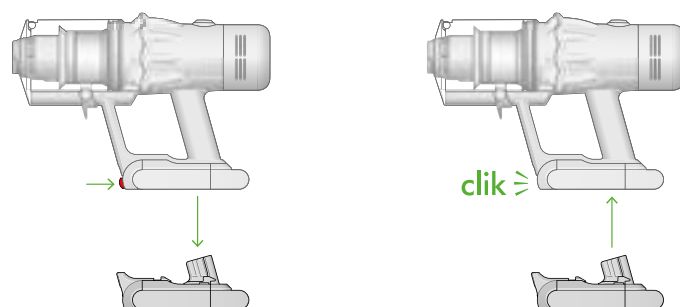

Emptying your bin

Empty as soon as the dirt reaches the MAX level – don't overfill. Using your machine when the dirt is above the MAX line may affect the performance and require more frequent filter washing.

Overfilling your bin could result in inaccurate readings on the particle graph.

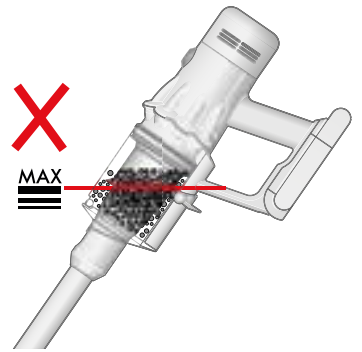

Remove your wand

Press the red wand release button, on the top of the wand, and pull the wand away from the bin.

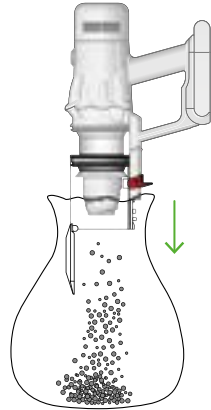

Release the dirt

Hold the machine over the bin, pointing downwards.

Firmly push the red bin release button. The bin will slide down, cleaning the shroud as it goes, and the bin base will open.

The bin base won't open if the red bin release button isn't pushed down all the way.

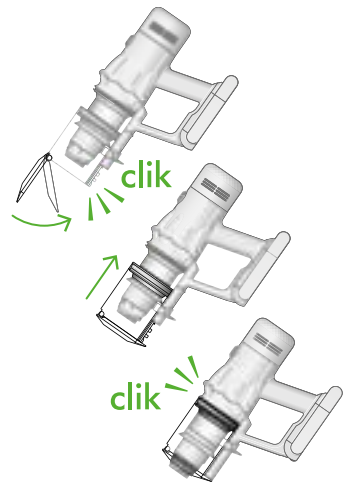

Minimise dust contact

Cover your bin tightly in a dust proof bag while you empty. Remove your bin carefully, seal the bag tightly and dispose.

Close the bin

Push the bin base upwards until your bin and bin base click into place.

Cleaning your bin

Remove your bin

If it is necessary to clean your bin, empty it as shown in the 'Emptying your bin' section.

Press the red button located on the bin runner to release the bin and slide your bin off the runner.

Only use a damp, lint-free cloth to clean your bin.

Make sure that your bin and seals are completely dry before replacing.

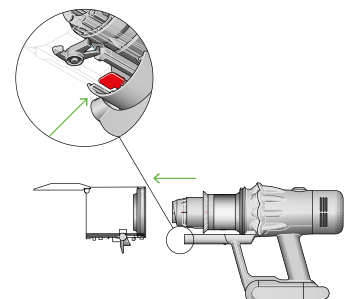

Refit your bin

Insert the spine on to the bin runner.

Close your bin by pushing the bin base upwards until the bin and bin base click into place.

Your bin isn't dishwasher safe and the use of detergents, polishes or air fresheners to clean your bin isn't recommended, as it may damage your machine.

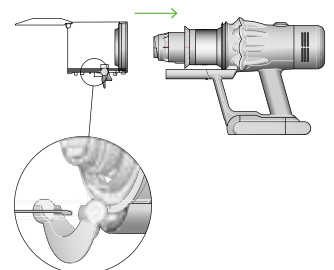

Clearing blockages

Disconnect your machine from the charger before looking for blockages. Be careful not to touch the trigger and be aware of sharp objects.

Leave your machine to cool down before looking for blockages.

Don't use your machine when looking for blockages as this could cause injury.

If your machine detects a blockage, the motor will pulse and you won't be able to use your machine until the blockage has been cleared.

If you try to use your machine when the motor is pulsing, it will automatically cut out.

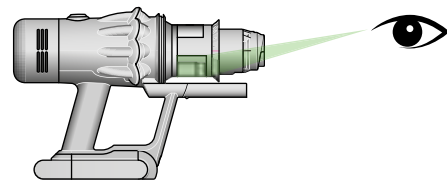
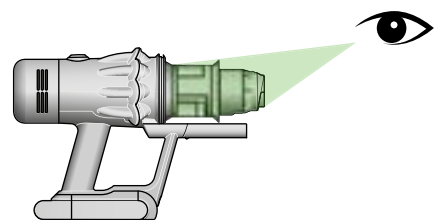

Check the main body

Remove the bin and check for blockages in the main body of your machine.

Make sure any blockages are completely cleared and all parts are fitted before using your machine.

Check the wand and cleaner head

Check the wand for blockages.

Check your cleaner head for blockages, following the instructions to remove the brush bar, where necessary.

Re-assemble your machine

Refit all parts securely before using your machine.

Clearing blockages isn't covered by your guarantee.

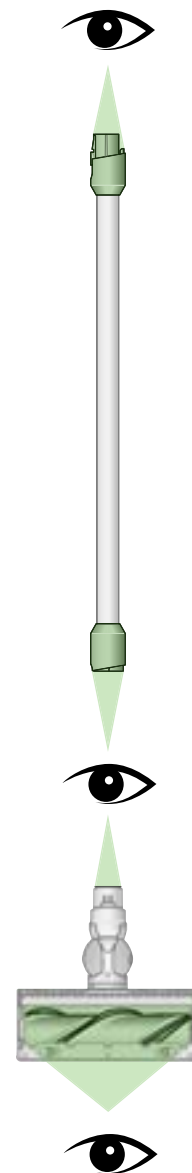

Clearing obstructions from your Motorbar™ cleaner head

Your Motorbar™ cleaner head doesn't have a washable brush bar. To maintain optimum performance, check your brush bar regularly and clear any obstructions.

Make sure your machine is disconnected from the charger and take care not to touch the trigger.



Remove your brush bar

Don't put any part of your machine in a dishwasher or use detergents, polishes or air fresheners.

Press the cleaner head release button on the end of the wand. Place the cleaner head upside down.

Use a coin to unlock the end cap.

Twist the end cap and remove it from your brush bar. Don't wash the end cap.

Slide your brush bar out of the cleaner head.

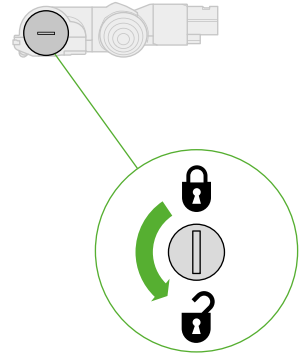

Look for obstructions

Clear any debris from your brush bar.

Check inside the cleaner head and remove any debris or blockages.

Your Motorbar™ cleaner head and brush bar aren't washable. Wipe over with a damp lint-free cloth.

Replace your brush bar

Push the end cap back on to your brush bar and slide it back into the cleaner head.

Turn the end cap clockwise into the locked position.

Your cleaner head isn't washable and should only be wiped over with a damp lint-free cloth.

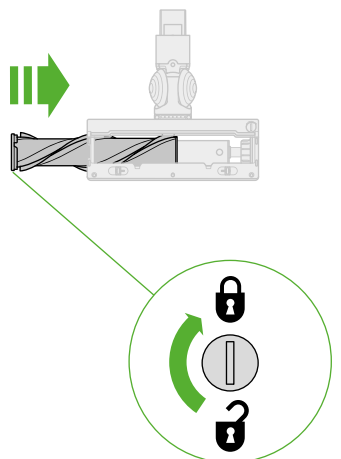

Clearing blockages from your Hair screw tool

Your Hair screw tool doesn't have a washable brush bar. To maintain optimum performance, check your brush bar regularly and clear any obstructions.

Make sure your machine is disconnected from the charger and take care not to touch the trigger.

Remove the cover and brush bar

Remove the Hair screw tool from the wand or machine.

Push the base plate open. Press the red lever down to release the cleaner head cover.

Pull the cleaner head cover off the main body of the tool.

Look for obstructions

Pull your brush bar firmly to remove it from the main body.

Check and remove any obstructions from all three parts of your Hair screw tool.

Your Hair screw tool isn't washable. Wipe over with a damp lint-free cloth.

Don't put any part of your machine in a dishwasher or use detergents, polishes or air fresheners.

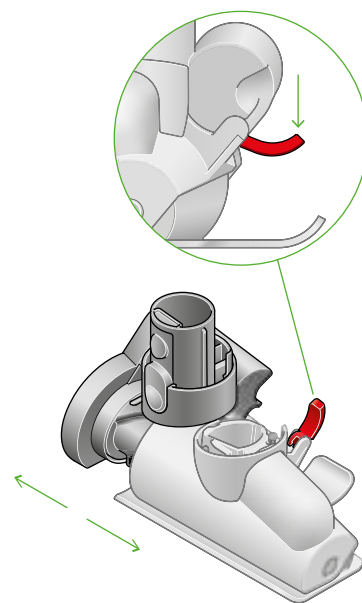

Re-assemble Hair screw tool

Put your brush bar back into position and press firmly until it clicks back into position.

Check the red locking lever is in the unlocked position. Align the cleaner head cover with the guide on the main body. Push it down until it clicks into position.

Push the red locking lever up until it clicks into position and push the base plate back into place.

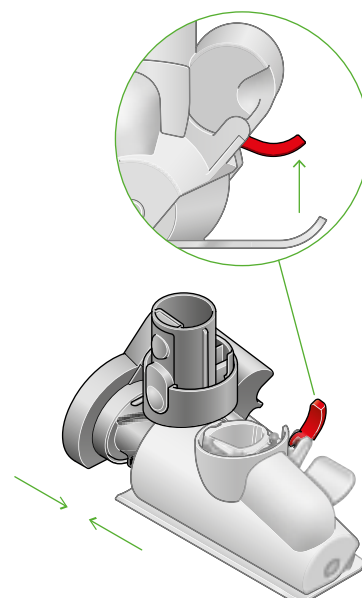

Washing your filter

Wash your filter at least once a month to maintain optimum suction power.

For more information and support videos for your machine go online: www.dyson.com/support

Twist off your filter

Twist your filter anti-clockwise and pull it away from your machine.

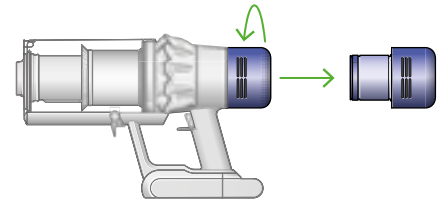

Tap your filter

Before washing your filter, tap it gently over a bin to remove any loose dust and debris.

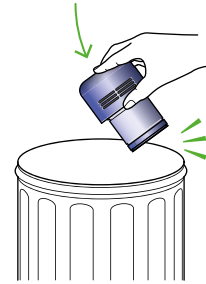

Wash your filter

Wash with warm, running tap water – gently rubbing your filter with your fingers to remove the dirt.

Fill and shake

Place your hand over one end of your filter.

Fill the filter with warm tap water.

Place your hand over the open end of the filter and shake it firmly to remove trapped dirt and debris.

Repeat these steps until the water runs clear.

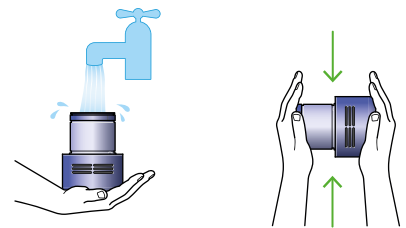

Shake and dry

Empty the filter and shake firmly to remove excess water.

Keep shaking until there's no water coming from the filter.

Place your filter end up, as shown.

Place the filter on its end and leave to dry for at least 24 hours in a well ventilated, warm place.

Don't dry your filter in a tumble dryer, microwave or near a naked flame.

Important: your filter must be completely dry before you put it back into the machine. Your machine could be damaged if used with a damp filter.

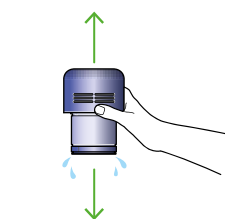

Washing your Illuminated cleaner head brush bar

Your Illuminated cleaner head has a washable brush bar. To maintain optimum performance, check and wash your brush bar regularly.

Make sure your machine is disconnected from the charger and take care not to touch the trigger.

Remove your brush bar

Don't put any part of your machine in a dishwasher or use detergents, polishes or air fresheners.

Press the cleaner head release button on the end of the wand. Place the cleaner head upside down.

Push the end cap up fully and pull the brush bar out of the cleaner head.

Remove the end cap from the brush bar. Don't wash the end cap.

Slide your brush bar out of the cleaner head.

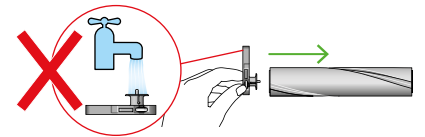
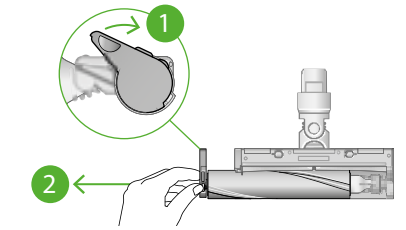

Wash and dry your brush bar

Hold your brush bar under running water and gently rub to remove any lint or dirt.

Stand your brush bar upright as shown. Leave to dry completely for at least 24 hours.

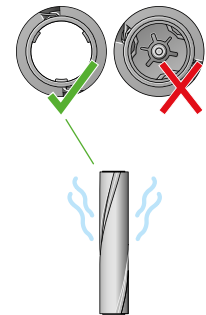

Replace your brush bar

Before replacing, check that your brush bar is completely dry.

Reattach the end cap to your brush bar.

Slide your brush bar into the cleaner head. Push the end cap back down to the closed position.

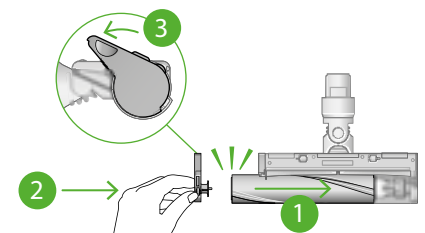

Cleaning your optic lens

To maintain optimum performance, keep your optic lens clean. Only clean the lens when the cleaner head is not attached to your machine.

Use a soft, dry, lint-free cloth to wipe the lens.

Cleaning your tools

Don't put any part of your machine in a dishwasher or use detergents, polishes or air fresheners.

Wipe with a damp, lint-free cloth, without touching the connector end.

Make sure your tools are completely dry before using.



Combination tool



Crevice tool



Extension hose



Light pipe crevice tool

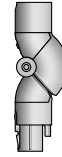

Low-reach adaptor

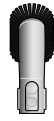

Soft dusting brush



Stubborn dirt brush



Up-top adaptor

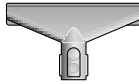

Fabric and mattress tool

Looking after your machine

To always get the best performance from your machine, it's important to clean it regularly and check for blockages.

Look after your machine

If your machine is dusty, wipe with a damp lint-free cloth.

Check for blockages in the cleaner head, tools and main body of your machine.

Wash your filter regularly and leave to dry completely.

Don't use detergents or polishes to clean your machine.

Look after your battery

To get the best performance and life from your battery, use Eco or Auto/Med mode.

Your machine won't operate or charge if the ambient temperature is below 5°C (41°F). This is designed to protect both the motor and battery.

Your serial numbers

You can find your serial numbers on your machine, battery and charger. Use your serial number to register.

For more information and support videos for your machine go online: www.dyson.com/support