



# IC-6220DC

## User Manual

06-2016 / v1.0

---

### **Edimax Technology Co., Ltd.**

No.3, Wu-Chuan 3rd Road, Wu-Gu, New Taipei City 24891, Taiwan  
Email: [support@edimax.com.tw](mailto:support@edimax.com.tw)

---

### **Edimax Technology Europe B.V.**

Fijenhof 2, 5652 AE Eindhoven, The Netherlands  
Email: [support@edimax.nl](mailto:support@edimax.nl)

---

### **Edimax Computer Company**

3350 Scott Blvd., Bldg.15 Santa Clara, CA 95054, USA  
Live Tech Support: 1(800) 652-6776  
Email: [support@edimax.com](mailto:support@edimax.com)



Copyright © Edimax Technology Co., Ltd. all rights reserved. No part of this publication may be reproduced, transmitted, transcribed, stored in a retrieval system, or translated into any language or computer language, in any form or by any means, electronic, mechanical, magnetic, optical, chemical, manual or otherwise, without the prior written permission from Edimax Technology Co., Ltd.

Edimax Technology Co., Ltd. makes no representations or warranties, either expressed or implied, with respect to the contents hereof and specifically disclaims any warranties, merchantability, or fitness for any particular purpose. Any software described in this manual is sold or licensed as is. Should the programs prove defective following their purchase, the buyer (and not this company, its distributor, or its dealer) assumes the entire cost of all necessary servicing, repair, and any incidental or consequential damages resulting from any defect in the software. Edimax Technology Co., Ltd. reserves the right to revise this publication and to make changes from time to time in the contents hereof without the obligation to notify any person of such revision or changes.

The product you have purchased and the setup screen may appear slightly different from those shown in this QIG. For more information about this product, please refer to the user manual on the CD-ROM. The software and specifications are subject to change without notice. Please visit our website [www.edimax.com](http://www.edimax.com) for updates. All brand and product names mentioned in this manual are trademarks and/or registered trademarks of their respective holders.

**Edimax Technology Co., Ltd.**

Add: No. 3, Wu-Chuan 3rd Rd., Wu-Ku Industrial Park, New Taipei City, Taiwan

Tel: +886-2-77396888

Email: [sales@edimax.com.tw](mailto:sales@edimax.com.tw)

**Notice According to GNU General Public License Version 2**

Certain Edimax products include software code developed by third parties, software code is subject to the GNU General Public License ("GPL") or GNU Lesser General Public License ("LGPL"). Please see the [GNU](http://www.gnu.org) (www.gnu.org) and [LGPL](http://www.gnu.org) (www.gnu.org) Websites to view the terms of each license.

The GPL Code and LGPL Code used in Edimax products are distributed without any warranty and are subject to the copyrights of their authors. For details, see the GPL Code and LGPL Code licenses. You can download the firmware-files at <http://www.edimax.com> under "Download" page.

<b>I. Product Information.....</b>	<b>5</b>
I-1. Package Contents.....	5
I-2. System Requirements.....	5
I-3. LED Status .....	7
I-4. Product Label .....	8
I-5. Reset .....	8
<b>II. Camera Setup.....</b>	<b>9</b>
II-1. Door Installation.....	9
II-2. EdiLife App .....	14
II-3. EdiView Finder.....	17
II-3-1. Windows .....	17
II-3-2. Mac .....	22
II-3-3. Using EdiView Finder .....	25
<b>III. Pair Button.....</b>	<b>27</b>
<b>IV. Web-Based Management Interface .....</b>	<b>28</b>
IV-1. Basic.....	33
IV-1-1. Network .....	34
IV-1-2. Dynamic DNS.....	35
IV-1-3. RTSP .....	36
IV-1-4. Date & Time .....	37
IV-1-5. Users .....	38
IV-1-6. UPnP .....	39
IV-1-7. Bonjour .....	40
IV-2. Video.....	41
IV-2-1. Privacy Protector .....	41
IV-3. Events.....	42
IV-3-1. Human Motion Detection .....	42
IV-3-1-1. Human Motion Detection .....	42
IV-3-1-2. Schedule Settings .....	44
IV-3-2. Notification .....	46
IV-3-2-1. Mail Settings.....	46
IV-3-2-2. Push .....	48
IV-3-2-3. HTTP.....	49
IV-4. Storage Settings.....	50
IV-4-1. Storage Directory.....	50
IV-4-2. NAS Settings .....	51
IV-4-3. SD Card Settings .....	52

IV-4-4. File Management.....	53
IV-4-4-1. JPEG .....	53
IV-4-5. Cloud Setting .....	54
IV-5. System.....	55
IV-5-1. Basic .....	55
IV-5-2. Advanced .....	56
IV-5-3. Cloud Service .....	58
IV-6. Status .....	59
IV-6-1. System Information .....	59
IV-6-2. System Log .....	60
<b>V. Myedimax.com .....</b>	<b>61</b>
<b>VI. FAQs .....</b>	<b>64</b>

# I. Product Information

---

## I-1. Package Contents

 **Do not remove the sticker from the camera viewer until the bolt has been installed through your peep hole.**

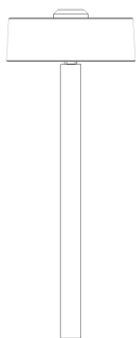

**Camera Viewer**



**Camera Battery Unit**

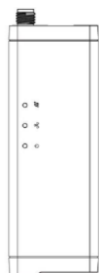

**Gateway**

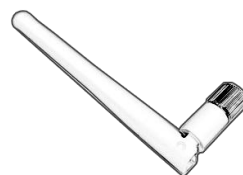

**Antenna**



**Power Adapter**



**Ethernet Cable**

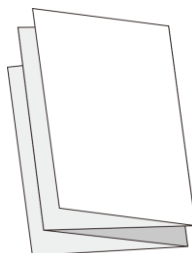

**QIG**



**Installation Kit: A**



**Installation Kit: B**



**Installation Kit: C**

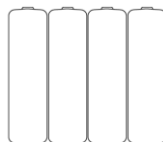



**Alkaline Battery**

## **I-2. System Requirements**

- Intel Pentium 4 2.4GHz (above or similar)
- VGA card (1024\*768 or above)
- CD-ROM Drive
- At least 128MB hard disk space (256 MB recommended)
- Windows XP, Vista, 7 or 8, Mac OS X or above
- Web browser (Internet Explorer 7.0, Firefox 3.6, Chrome 10, Opera 11, Safari 5 or above)

### I-3. LED Status

#### Gateway:

LED	LED Color	LED Status	Description
<b>Power</b> 	Green	On	Gateway is on and connected to cloud server.
		Quick Flashing	Gateway is restarting.
		Slow Flashing	Gateway is starting up <b>or</b> is not connected to cloud server.
<b>LAN</b> 	Green	On	Gateway is connected to the local network.
		Quick Flashing	LAN activity (transferring data).
<b>Internet</b> 	Orange	On	Connected to Internet.
		Quick Flashing	Gateway is restarting.
		Slow Flashing (1 x per second)	Not connected to Internet.

#### Camera:

LED	LED Color	LED Status	Description
<b>Status</b>	Green	On	Camera is on and connected to cloud server.
	Orange	Slow Flashing	PIR motion detection trigger.
<b>Battery</b>	Red	Flashing	Low battery warning.



*The camera's Status LED displays off when the camera is switched on but not in use.*

## I-4. Product Label

The product label located on the underside of the network camera displays the serial number, MAC address and cloud ID of your network camera.

 ***The MAC address and cloud ID are the same for easy reference.***

The cloud ID allows you to view a live stream from your network camera remotely (from any Internet connection) as described later in **V.**

**Myedimax.com.**



## I-5. Reset

If you experience problems with your network camera, you can reset the camera back to its factory default settings. This resets **all** settings back to default.

Press and hold the Pair/Reset button on the back panel for at least 10 seconds. Release the button when the power LED is **flashing quickly green**, and wait a couple of minutes for the unit to restart.

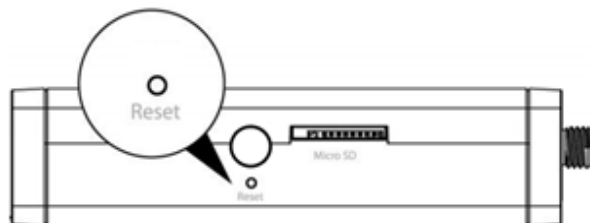

 ***Take care to hold the button for at least 10 seconds. The Pair/Reset button will clear the wireless pairing between your gateway unit and camera unit if held for only 5 seconds. Refer to III. Pair Button.***



## II. Camera Setup

---

### II-1. Door Installation

The door camera unit mounts conveniently and securely to your door's peephole. Carefully remove any existing viewer/cover on your peephole before you begin.

1. Screw on the included antenna to the gateway unit and connect the power adapter. The **green** power LED will **flash slowly** when the gateway is ready.

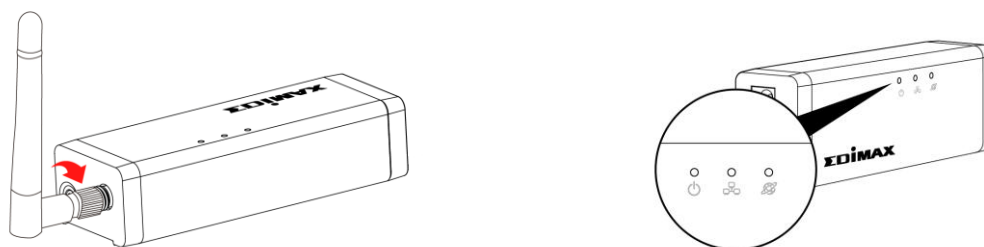

2. Use an Ethernet cable to connect the gateway to your wireless router or access point. The **green** power LED and **orange** Internet LED will display on to indicate successful cloud and Internet connections.

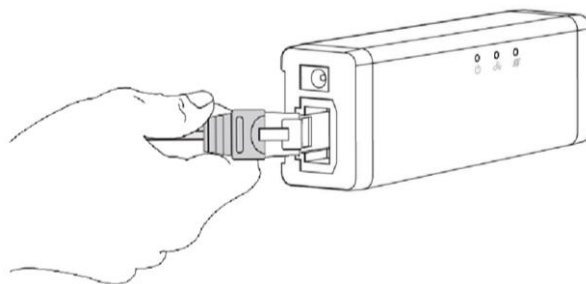

- 3.** Twist to remove the cover and insert 4 x AA batteries into the camera battery unit.

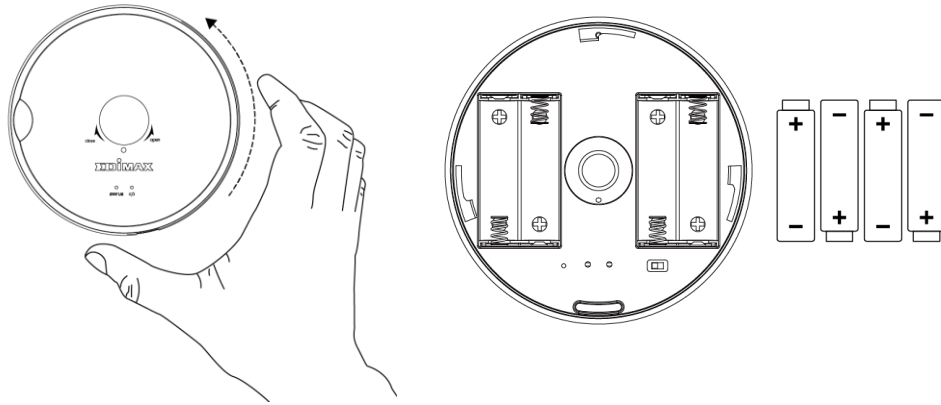

- 4.** To remove an existing peephole from your door, you can usually simply unscrew it using a coin.

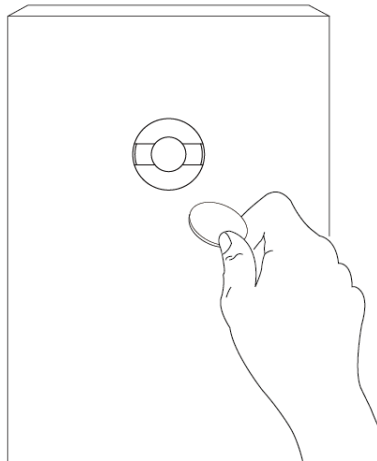

- 5.** Remove the warning sticker from the camera viewer.

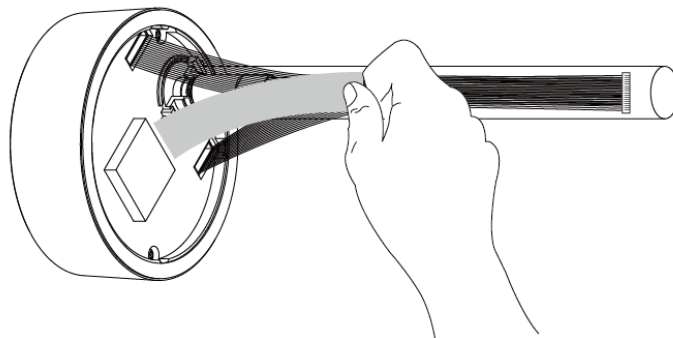

- 6.** Remove the sticker from the black double-sided tape on the camera viewer.

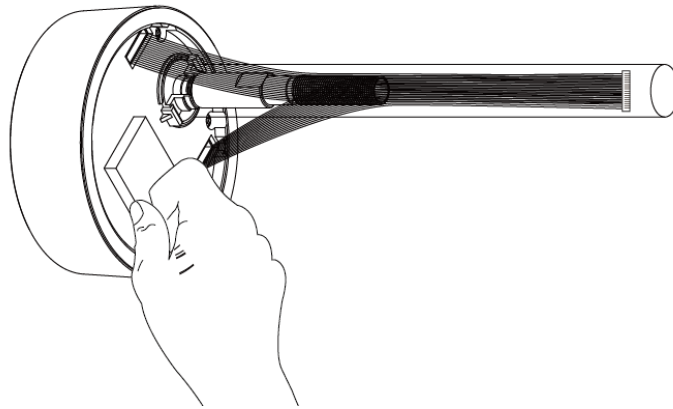

- 7.** From the front of your door, insert the camera viewer's bolt through your door's peephole until the unit is flush to your door.

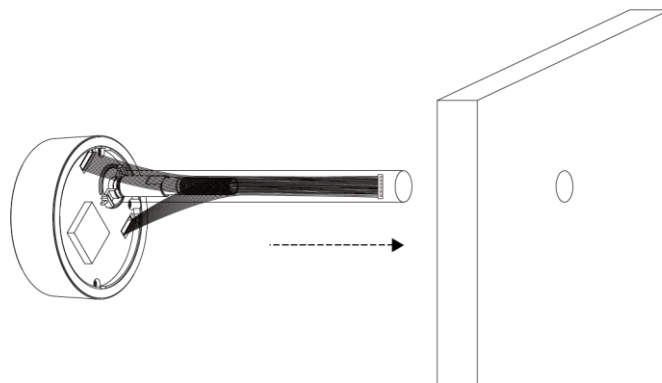

- 8.** Remove the plastic tube from the bolt.

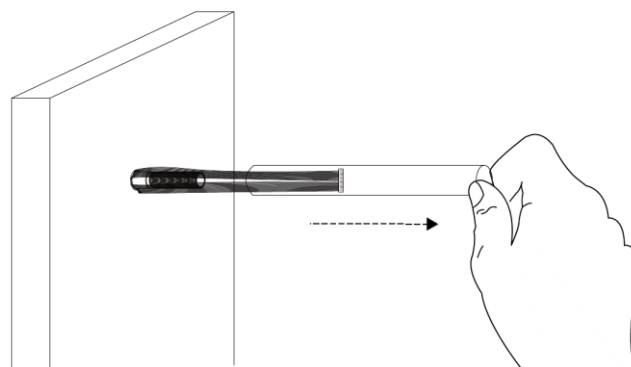

- 9.** From the inside of your door, screw on the included **Installation Kit A** (nut) onto the camera viewer's bolt, until tight to your door.

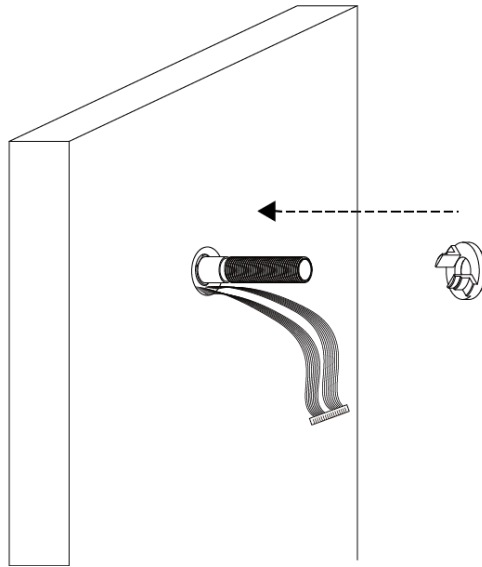

- 10.** Screw on the included **Installation Kit B** (washer) onto the camera unit's bolt.

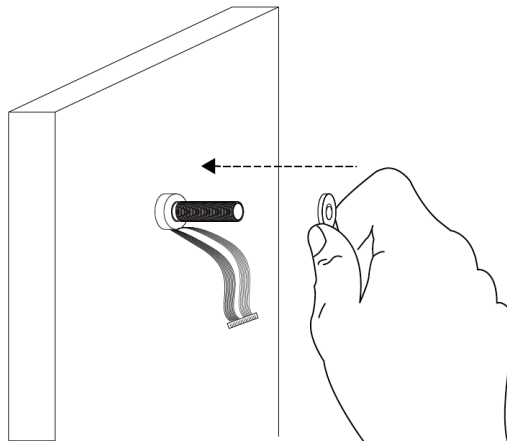

- 11.** Connect the cable to the terminal on the camera battery unit.

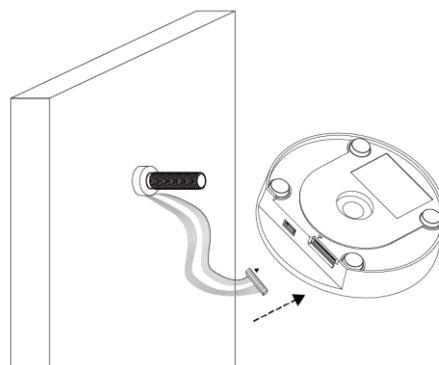

- 12.** Place the camera battery unit onto the viewer unit's bolt with the battery side facing away from the door, and then screw the included **Installation Kit C** (cap) onto the bolt to secure the battery unit in place.

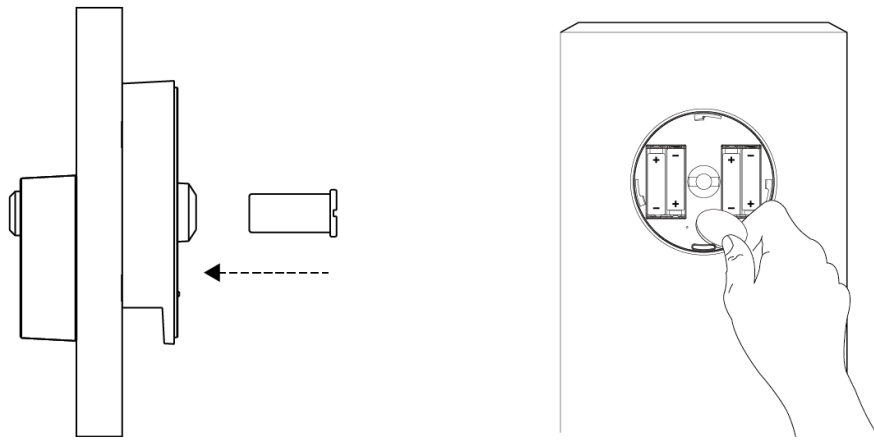

- 13.** Switch the camera's power switch on and re-attach the cover by twisting into place.

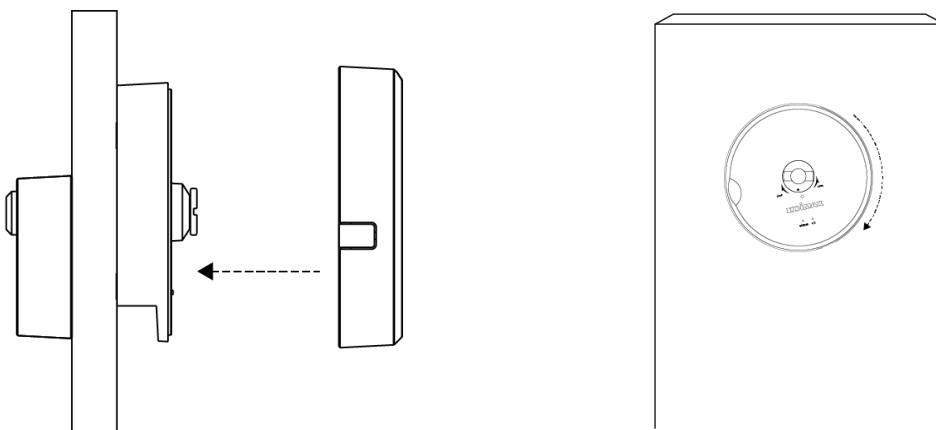

## II-2. EdiLife App

1. Use a smartphone or tablet to search, download and install the EdiLife app from Google Play or the Apple App Store.



2. Open the EdiLife app and tap the + icon in the top right corner of the screen.

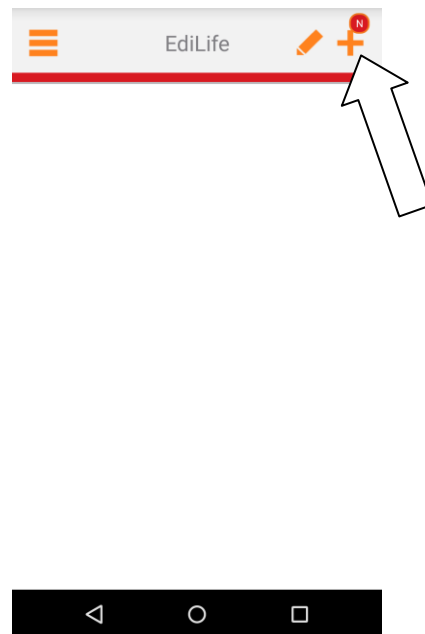
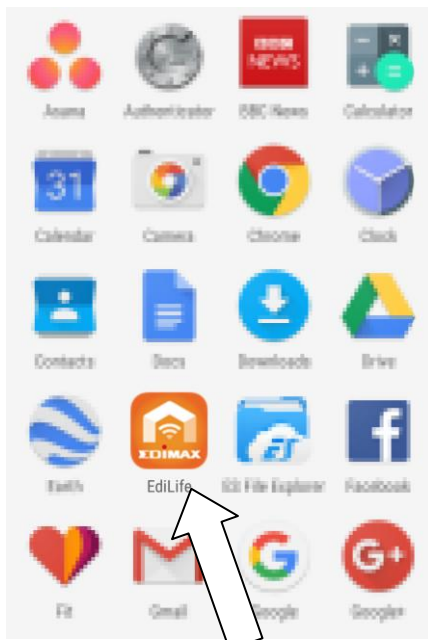

3. Select your camera from the **available device list** and wait a moment for the app to make a connection.

**Tap refresh in the top right corner if your camera isn't listed.**

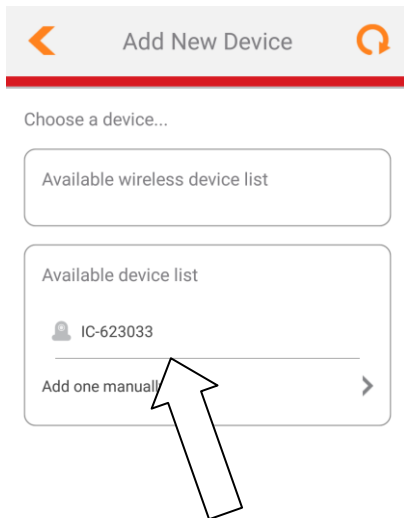

4. For better security, enter a new device name and password when prompted. Tap the **check mark** to continue.

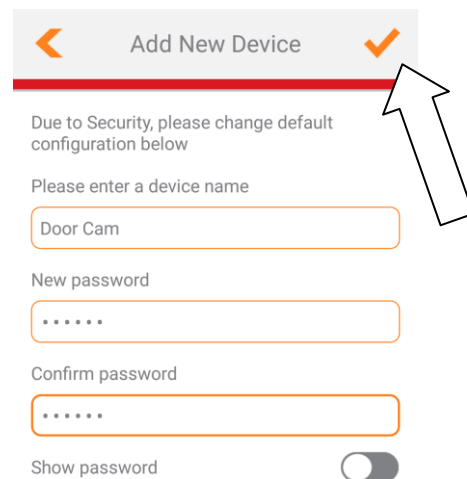
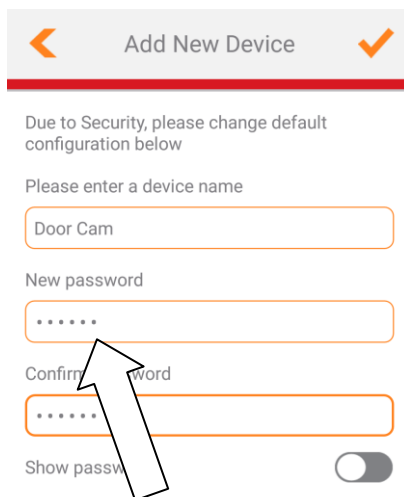

- 5.** Setup is complete. Your camera should be listed on the EdiLife home screen. Tap your camera to see a live stream which you can view anytime you are connected to the Internet.

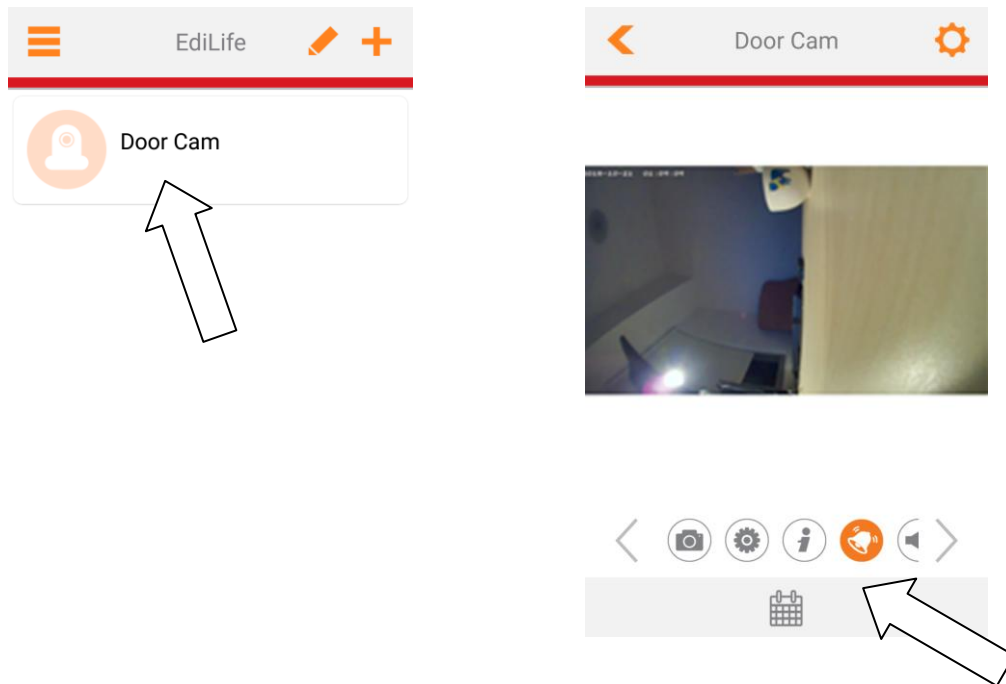

 ***You can configure your camera's settings and functions using the icons below the live image.***

- 6.** If you have a microSD card, insert the card into the microSD slot on the back on the gateway unit.



## II-3. EdiView Finder



**Ensure your computer is connected to the same router as the network camera using an Ethernet cable.**

### II-3-1. Windows

1. Insert the included CD into your CD-ROM drive and if the setup utility does not automatically open, please locate and open the “Autorun.exe” file in the “Autorun” folder.
2. Click “Setup Utility” to install the EdiView Finder software utility.

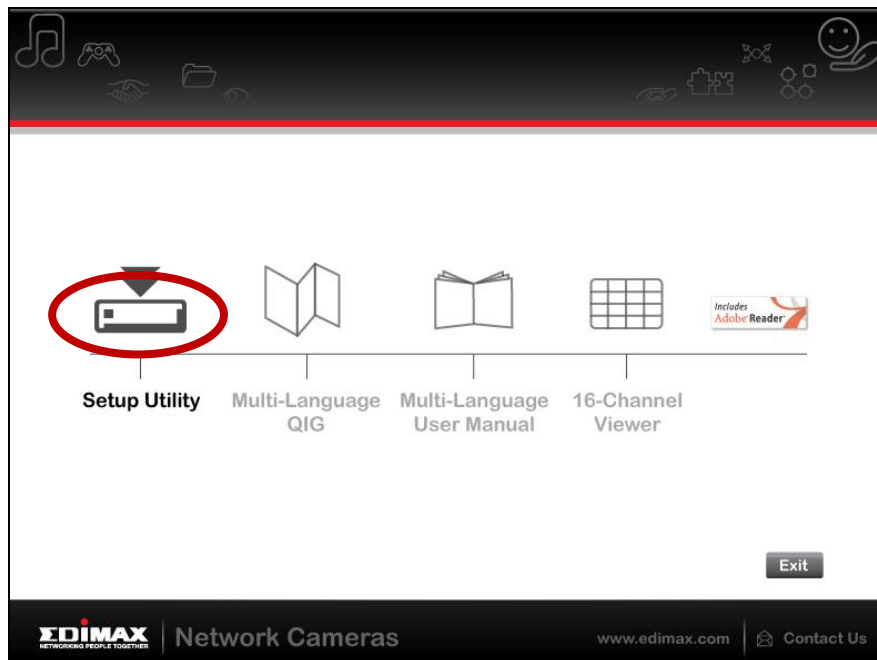

3. Click “Next” and follow the on-screen instructions to install the EdiView Finder software utility.

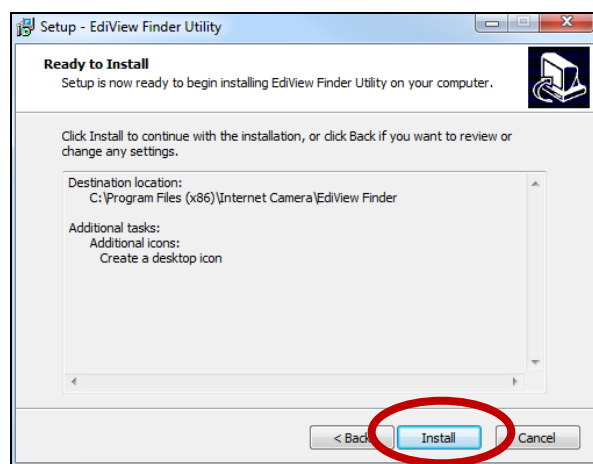
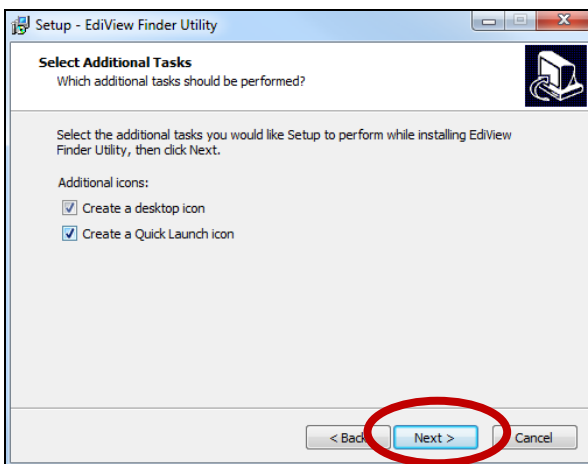
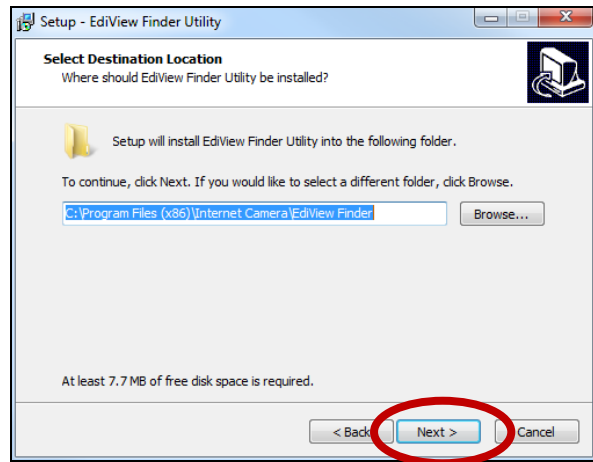
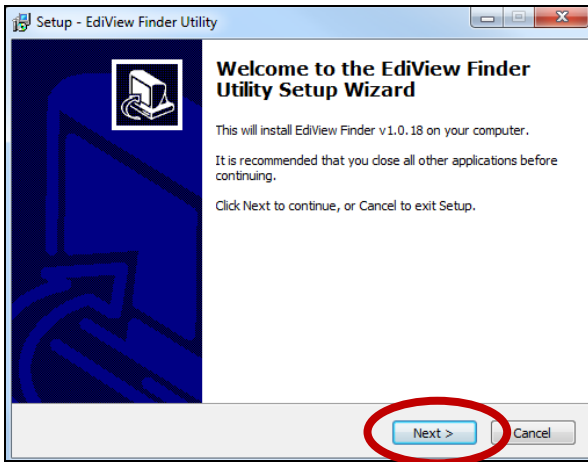

4. When installation is complete, select “Launch EdiView Finder Utility” before clicking “Finish”. Or double click the “EdiView Finder Utility” icon on your desktop to launch EdiView Finder.

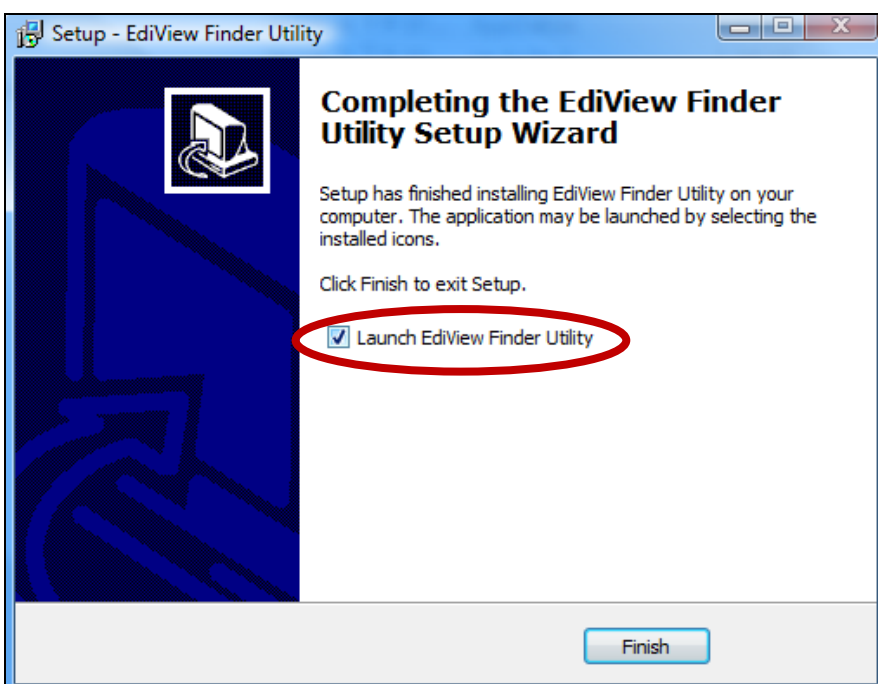

5. EdiView Finder will list all cameras on your local network, along with each camera's name, model, IP address and MAC address.



***Click the search icon to refresh the list if your camera is not displayed.***

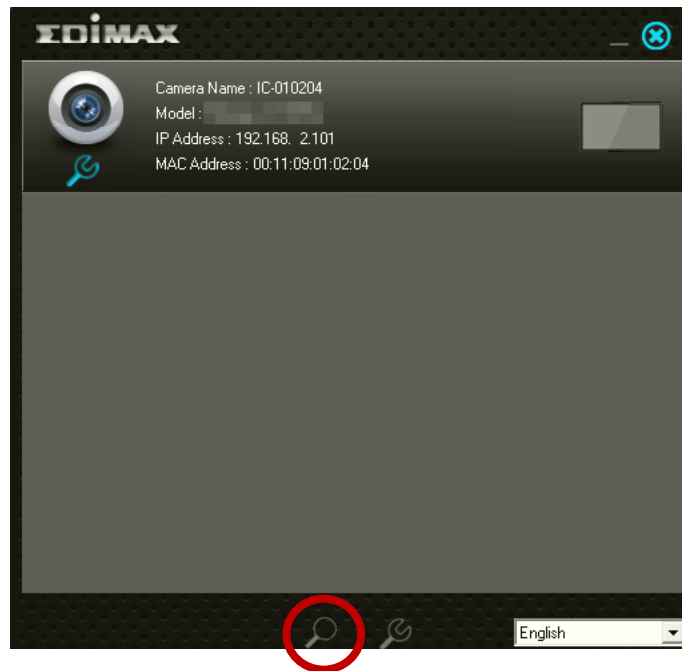

***The network camera's IP address is displayed on this screen. After setup, you can enter this IP address into the URL bar of a web browser on the same local network to access your network camera's web-based configuration interface.***

6. Double click your camera and then choose "Yes" or "No" if you wish to set up a wireless connection. If you choose "No" please go to **step 10**.
7. Unplug the Ethernet cable from your network camera and click "Next". Please wait a moment for the camera to detect the connection.

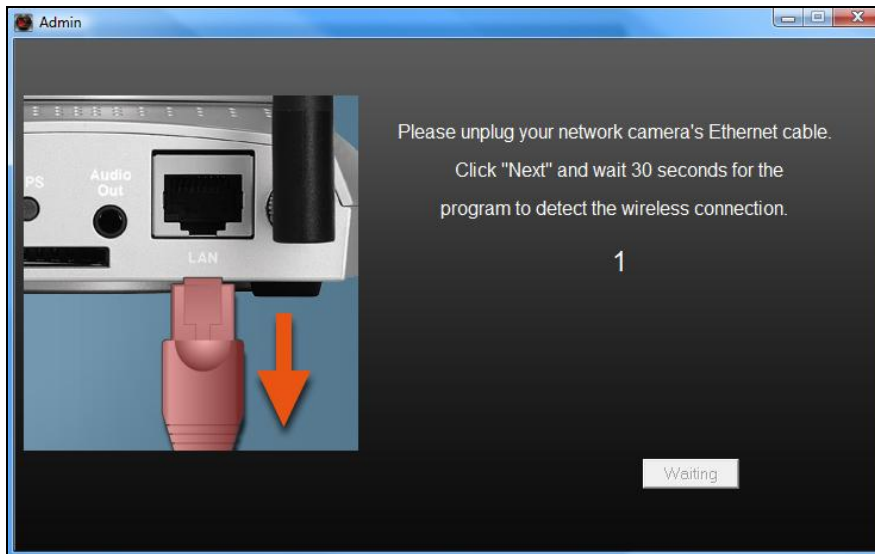

8. When the connection is detected as shown below, please click “Next”.

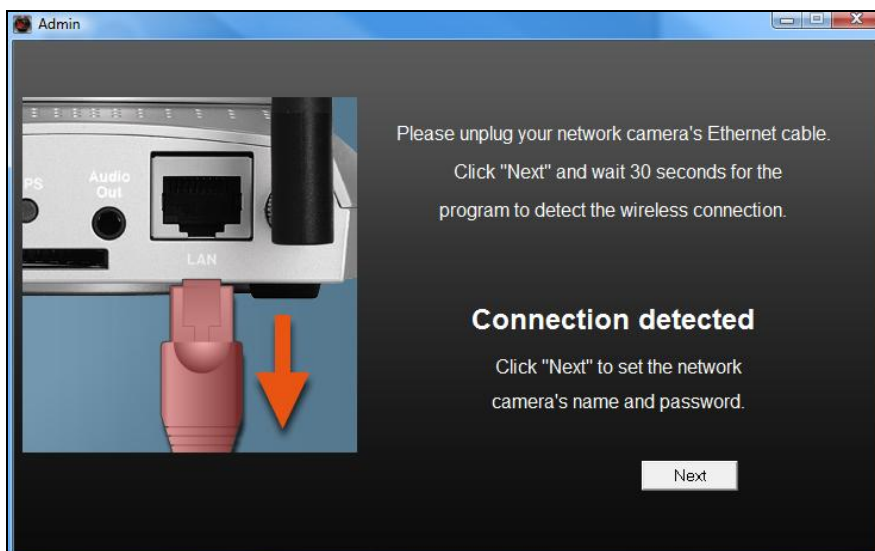

9. Enter a name and password for your camera. The password will be used later to log in to your camera remotely via its cloud ID, web interface or via the EdiView II smartphone app. Click “OK” to continue.

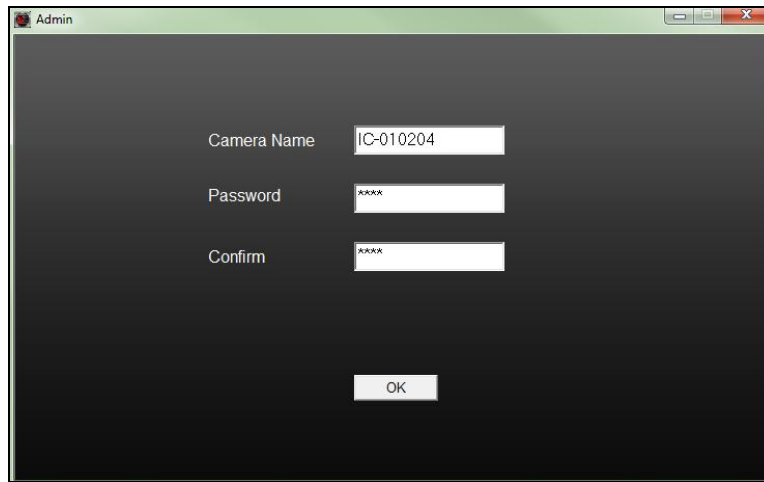

**10.** The next screen will indicate that setup is complete. The camera is operational and ready for use. Click “OK” or click the URL and a preview window showing a live stream from your camera may open.



## II-3-2. Mac



***EdiView Finder for Mac will not set up your network camera's wireless connection. After this chapter, please continue to IV-1-2. Wireless to set up the camera's wireless connection.***

1. Insert the included CD into your CD-ROM drive and browse to the "Mac" folder.

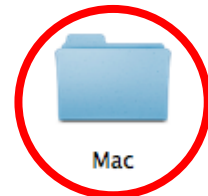

2. Copy the "EdiView Finder" file to your desktop and double click the icon to open EdiView Finder.



***EdiView Finder is also available for download from the Edimax website:***

**<http://www.edimax.com/EdiViewFinder.htm>**



**3.**EdiView Finder will list all cameras on your local network, along with each camera’s name, model, IP address and MAC address.

 **Click the search icon to refresh the list if your camera is not displayed.**

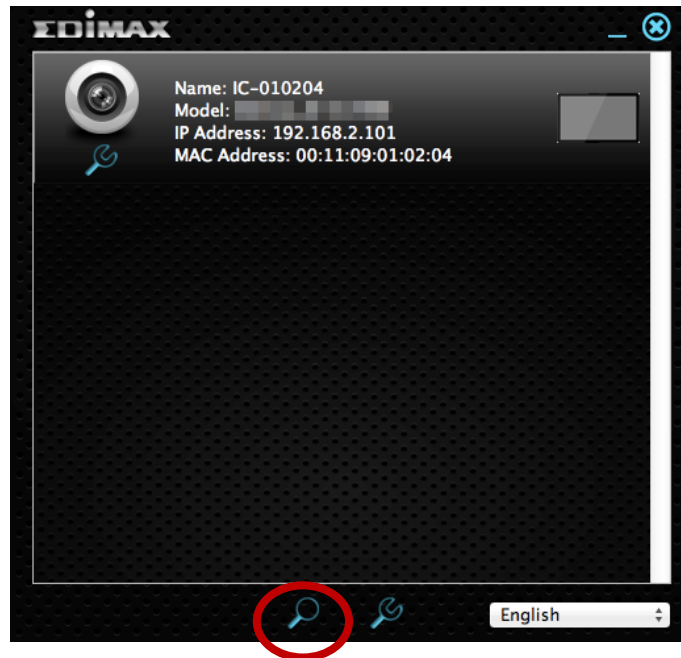

 **The network camera’s IP address is displayed on this screen. After setup, you can enter this IP address into the URL bar of a web browser on the same local network to access your network camera’s web-based configuration interface.**

**4.** Double click your network camera and wait a moment for the network camera to obtain an IP address and test the cloud connection. EdiView should display “Success” as shown below.

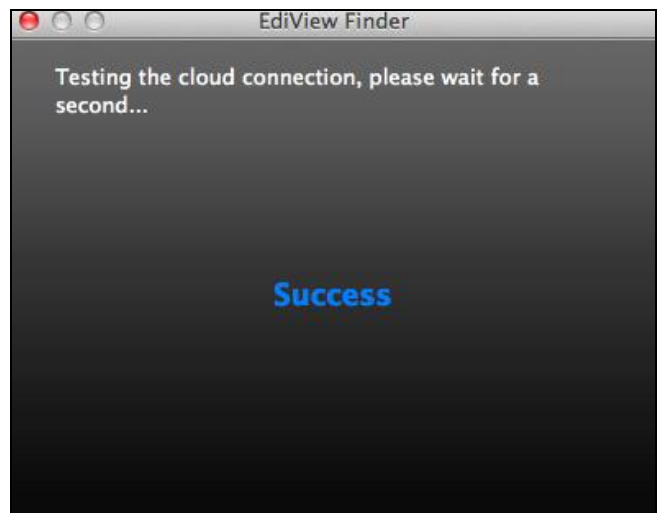
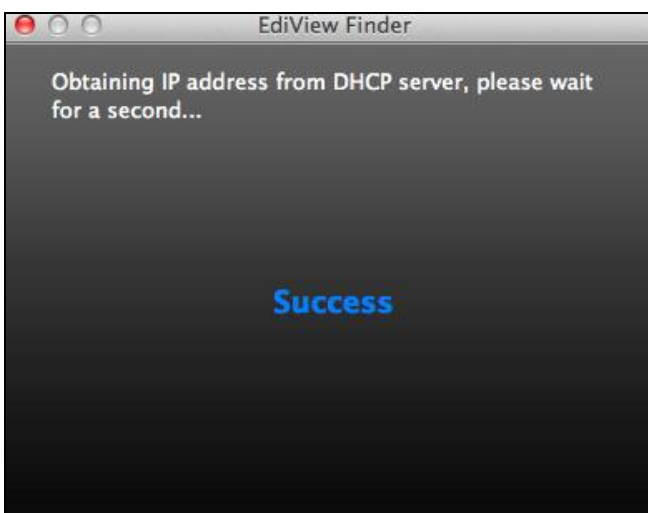

5. Enter a name and password for your camera. The password will be used later to log in to your camera remotely via its cloud ID, web interface or via the EdiView II smartphone app. Click “Next” to continue.



6. The next screen will indicate that setup is complete. The camera is operational and ready to be configured for a wireless connection. Click “Finish” and a preview window showing a live stream from your camera may open.

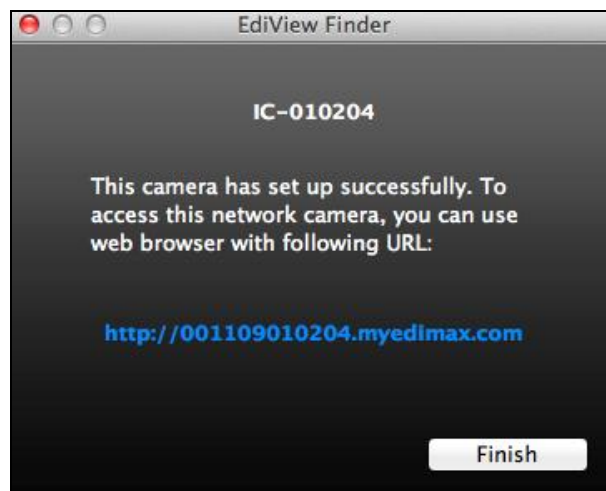



### II-3-3. Using EdiView Finder

You can also use EdiView Finder to find your network camera's IP address, view a live stream, or modify the network camera's IP address. Double click the TV icon on the right side to view a live stream in a pop-up window, or click the wrench icon to open a new window with the network camera's IP address settings:

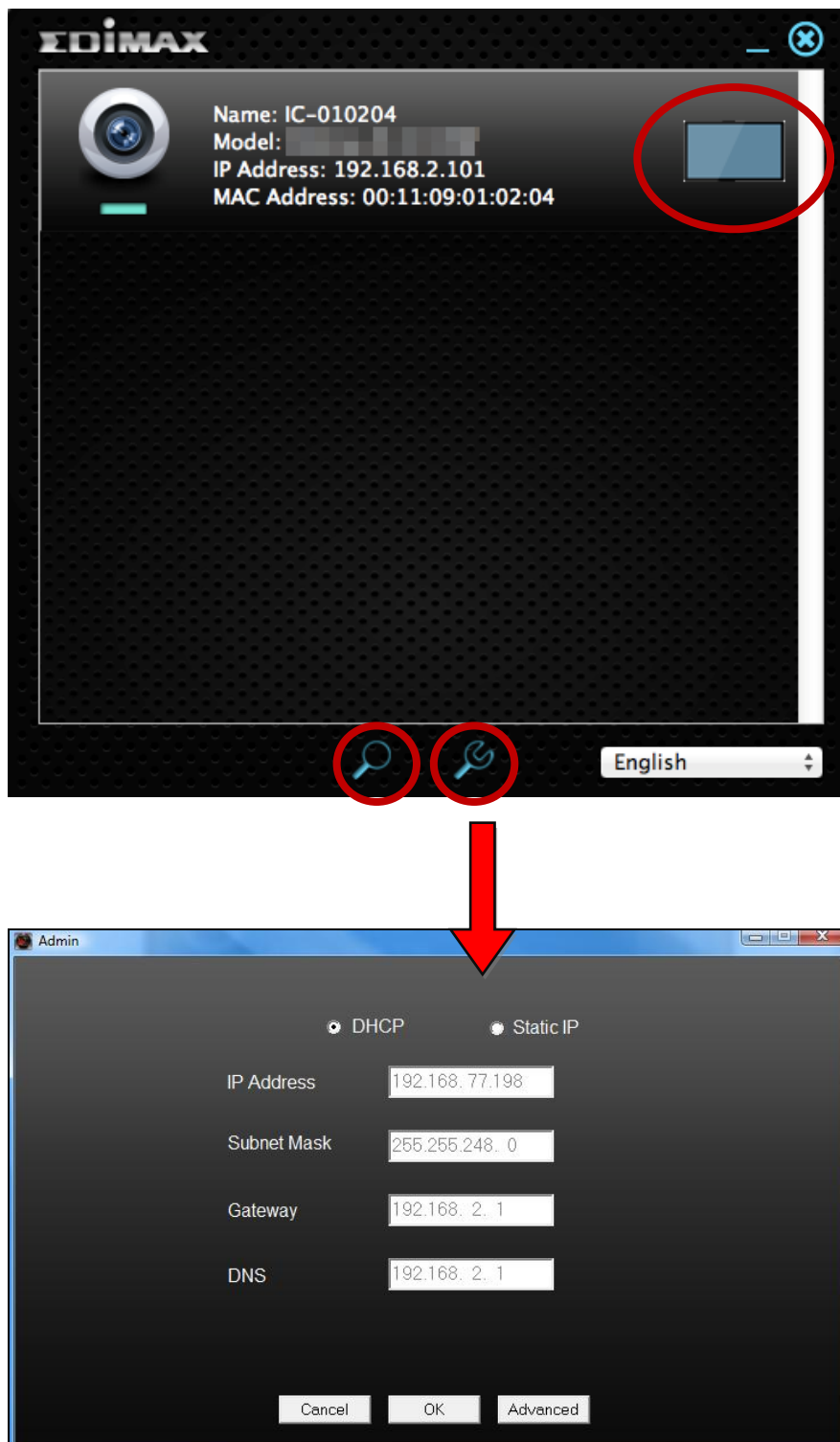



***EdiView Finder will locate your network camera as long as you are on the same local network. Static IP users who may be using a different IP address subnet to the network camera should still be able to locate the network camera with EdiView Finder. If you encounter difficulties, it is recommended that you use a DHCP server – though you can manually set the network camera’s IP address using EdiView Finder (above) or using the web-based configuration interface (see IV-1-1. Network) if you need.***

### III. Pair Button

---

Your gateway unit and camera unit are wirelessly paired at the factory and manual pairing is not necessary. However, if you need to re-pair your units for some reason, or if you accidentally clear the existing pairing, follow the instructions below. The pair/reset button will clear existing pairings when pressed for 5 seconds.



***Your gateway unit and camera unit are already paired when you purchase them and under normal circumstances no manual pairing is necessary.***

- 1.** Push the **Pair** button on the gateway unit for 5 seconds to activate pairing. After a quick flash of the Power LED for 5 seconds, press the **Pair** button on the gateway again.

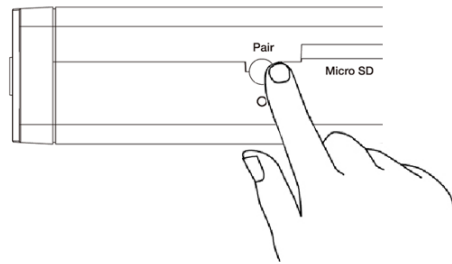

- 2.** Within 30 seconds, push the **Pair** button on the camera unit for 2 seconds. After a few seconds, the camera's **Status** LED will flash quickly **orange** to indicate successful pairing.

## IV. Web-Based Management Interface

---

When you are using the **same local** network as your camera, you can use the web-based management interface to view or configure the camera and to use the camera's functions.

You can access the web-based management interface with a web browser on a smartphone or computer. For smartphone users, the appearance of the interface will vary slightly to that which is displayed here, though the menu functions which are described later from **IV-1. Basic** onwards are the same.

1. Enter the network camera's IP address into the URL bar of a web browser. The camera's IP address can be found by opening EdiView Finder, as displayed below:

 **Internet Explorer is recommended.**

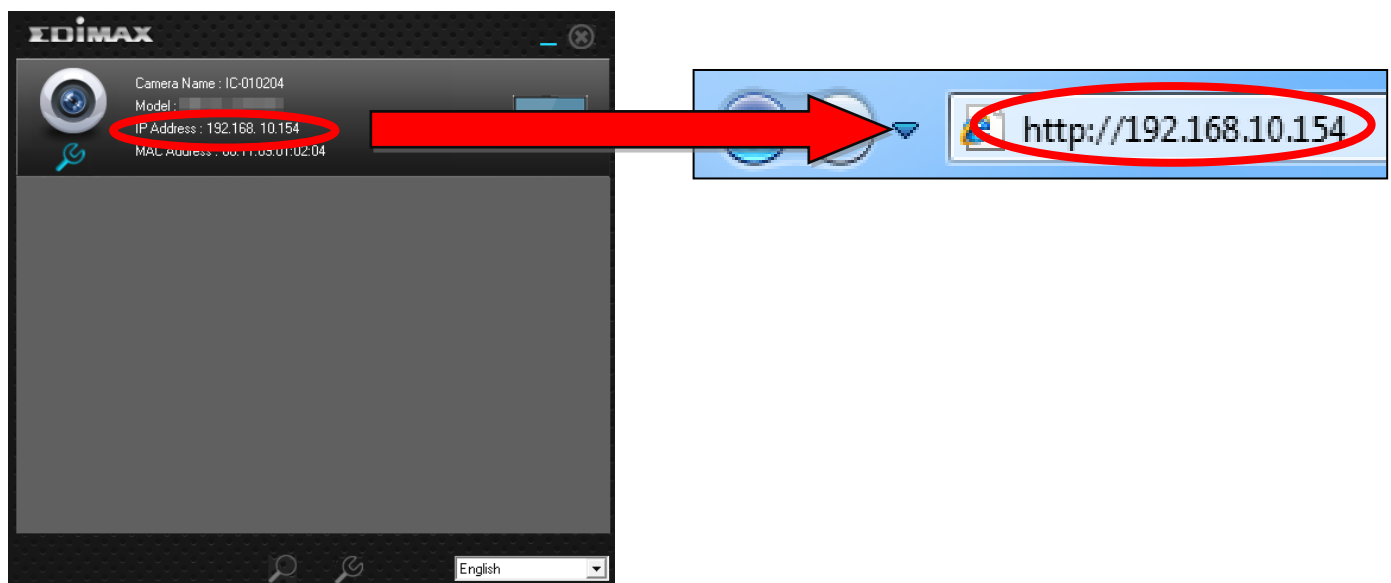

2. You may be prompted to allow a Java add-on to run. Please click the message where it says “click here” and then click “Run Add-on”.

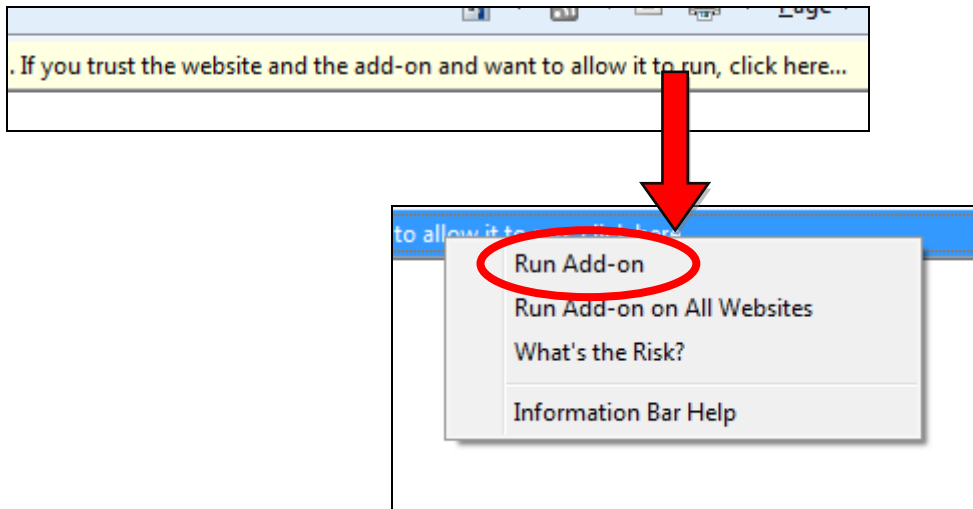

 ***If any other security warnings/prompts appear, please select “Run” or “Allow” or similar, depending on your browser.***

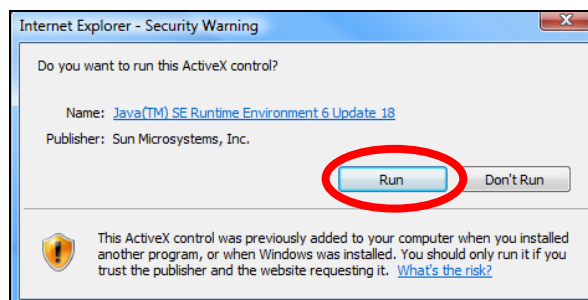

3. Enter the username and password for your network camera (default username: *admin* default password: *1234*). The network camera’s web-based management interface will then be displayed in your browser.

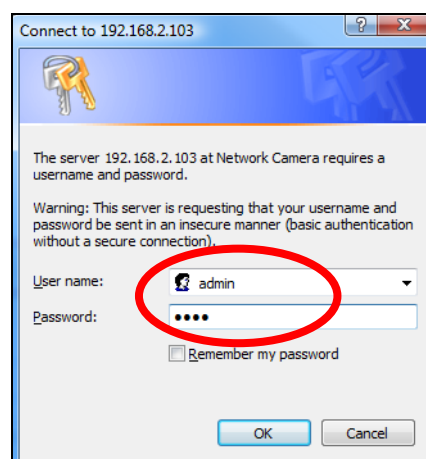

4. For computer users, the “Live View” screen will be displayed, as shown below. On the live view screen you can see a live stream from your camera and use the icons on the left side to pan, tilt and take snapshots or recordings.

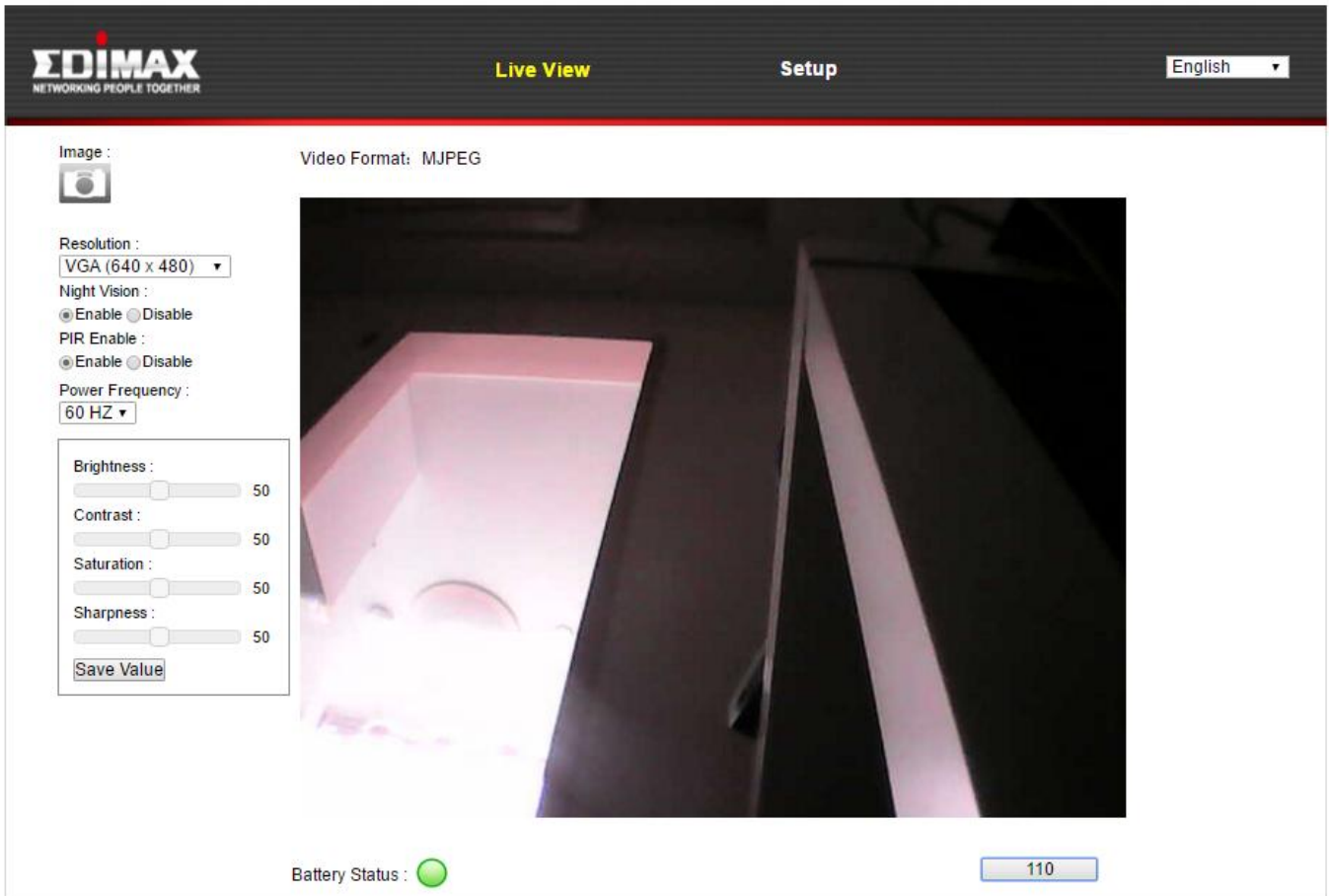

<b>Image</b> 	Save a snapshot (image) of the network camera’s current view. You will be prompted to select a location to save the image.
<b>Resolution</b>	Set the video resolution according to your preference.
<b>Night Vision</b>	Enable or disable night vision.
<b>PIR Enable</b>	Enable or disable the camera’s passive infrared (PIR) sensor which senses motion.
<b>Power Frequency</b>	Set 50MHz or 60MHz power frequency according to your display’s capabilities.
<b>Brightness/ Contrast/</b>	Adjust various parameters relating to the network camera’s image appearance using

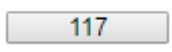
<b>Saturation/ Sharpness/</b>	the sliders. Click and drag the blue lever to change the value for each category and click <b>Save Value</b> .
<b>Battery Status</b>	Color-coded (green, orange, red) status of the camera battery.
<b>Timer</b> 	Counts down from 120 seconds until the camera will go into standby. After 120 seconds the button is labelled “Continue”. The camera will remain in standby to conserve battery power until: A. The button is clicked. B. Motion is detected. C. The EdiLife app live view is activated.

5. Select “Setup” at the top center and use the menu down the left side to navigate to the network camera’s various settings. Each menu item is described in the following chapters.

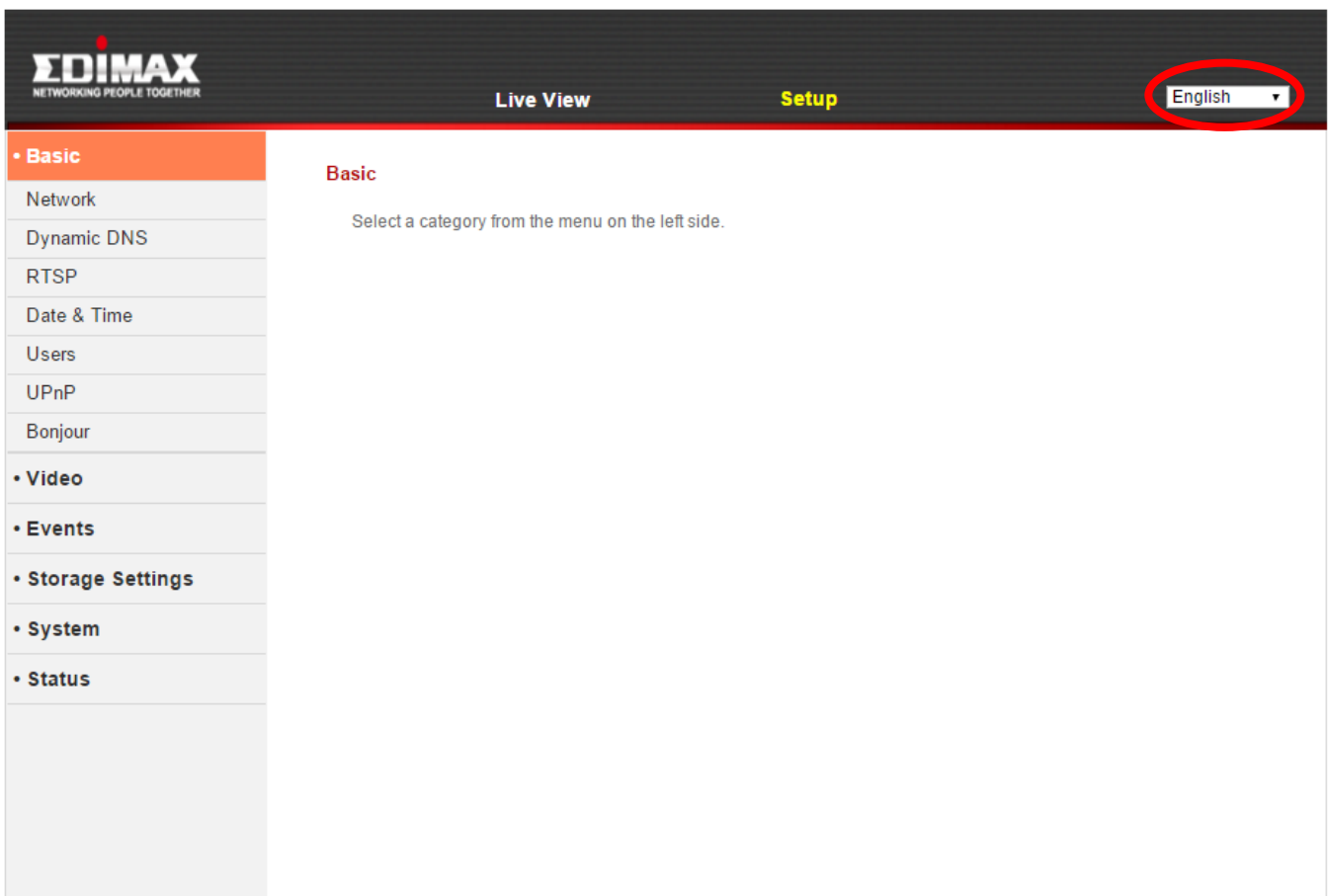

6. After making any changes, click “Save Settings” to save the settings and bring the changes into effect.

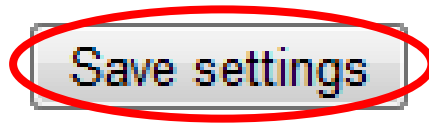



## IV-1. Basic

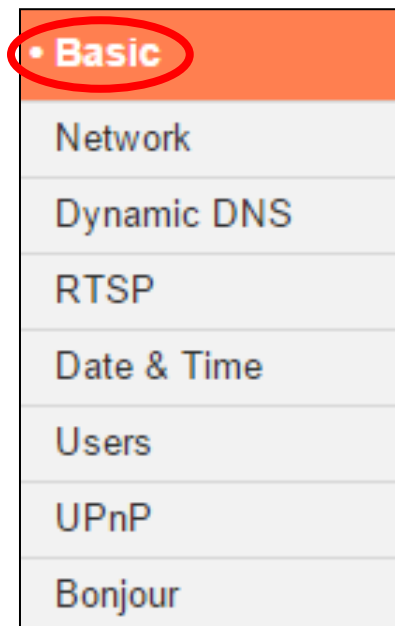

The “Basic” menu opens a submenu with eight categories of settings for your network camera’s basic operation. Select a category and refer to the appropriate chapter.

## IV-1-1. Network

Network settings are displayed on this page, as shown below. You can configure your network camera to dynamically receive a local IP address from your router's DHCP server or you can specify a local static IP address for your network camera.

**Network**

Network Type:

**Static IP**

IP Address:

Subnet Mask:

Gateway:

Primary DNS:

Secondary DNS:

HTTP Port:

<b>Network Type</b>	Select "DHCP" to automatically assign an IP address to your network camera from your router or "Static IP" to manually set a static IP address using the fields below.
---------------------	--

<b>IP Address</b>	Static IP users specify an IP address here, which will be the IP address of your network camera.
<b>Subnet Mask</b>	Enter the subnet mask of the IP address.
<b>Gateway</b>	Enter the gateway address of your network.
<b>Primary DNS</b>	Enter the IP address of your primary DNS server.
<b>Secondary DNS</b>	Enter the IP address of your secondary DNS server (optional).
<b>HTTP Port</b>	You can edit the HTTP port number to any value between 1024 – 65535. The default value is 80.

## IV-1-2. Dynamic DNS

Dynamic DNS (DDNS) is a service which provides a hostname-to-IP service for dynamic IP users. If your Internet service provider didn't issue a fixed IP address, you can use a third-party dynamic DNS provider to map your current IP address to a fixed IP address. Several free or paid DDNS services are available online, please use the information provided by your DDNS provider to configure the settings on this page.

### Dynamic DNS

Enable DDNS:  Enable  Disable

Provider:

Host Name:

Username:

Password:

<b>Enable DDNS</b>	Select "Enable" to enable DDNS functionality, or select "Disable" to disable DDNS functionality.
<b>Provider</b>	Select your dynamic DNS service provider from the dropdown menu.
<b>Host Name</b>	Enter the hostname you registered with the DDNS service provider.
<b>User Name</b>	Enter the user name you registered with the DDNS service provider.
<b>Password</b>	Enter the password you registered with the DDNS service provider.

### IV-1-3. RTSP

Real Time Streaming Protocol (RTSP) enables the network camera to be used with a streaming media server. Enter the required RTSP settings.

#### RTSP Settings

RTSP Port:

MJPEG RTSP Path: .sdp

RTP Port Range:  -

Verification:

<b>RTSP Port</b>	Enter the RTSP port.
<b>MJPEG RTSP Path</b>	Enter the MJPEG RTSP path.
<b>RTP Port Range</b>	Enter the RTP port range.
<b>Verification</b>	Select a verification type from the drop down menu.

## IV-1-4. Date & Time

You can set and adjust the network camera's system time and date on this page. Maintaining a correct system time is particularly important for recorded video organization/playback.

### Date & Time

Mode:  NTP  Manual Setting

Set Time & Date Manually:  /  /   :  :

NTP Server:

Time Zone:

Daylight Saving:  Enable  Disable

<b>Mode</b>	Select "NTP" or "Manual Setting". NTP (Network Time Protocol) can set and maintain the time and date automatically via an NTP server on the local network, if available.
<b>Set Time &amp; Date Manually</b>	For manual setting mode, enter the correct time and date in the following format: YYYY/MM/DD HH:MM:SS
<b>Synchronize to PC time</b>	Click here to automatically enter the same time and date as your computer.
<b>NTP Server</b>	For NTP mode, enter the NTP server's hostname or IP address.
<b>Time Zone</b>	Select the correct time zone.
<b>Daylight Saving</b>	Enable or disable daylight saving according your local time zone.

## IV-1-5. Users

In addition to the default administrator account, you can configure several different login accounts for the network camera, with two different levels of access – operator and guest.

Operator accounts can configure partial functions of the network camera similar to the administrator account, while guest accounts can only view the camera's image.

### Users

The screenshot shows a web interface for user management. At the top is a 'User List' table, which is currently empty. Below the table are three input fields labeled 'User Name:', 'Password:', and 'Confirm Password:'. At the bottom of the form are three buttons: 'Add', 'Modify', and 'Remove'.

<b>User List</b>	Existing users are listed here. Select a user here to modify the settings.
<b>User Name</b>	Input user's name here.
<b>Password</b>	Input user's password here.
<b>Confirm password</b>	Input user's password here again for confirmation.
<b>Add</b>	Add a new user.
<b>Modify</b>	Save the changes to an existing, selected user.
<b>Remove</b>	Remove selected user.

## IV-1-6. UPnP

Universal plug-and-play (UPnP) is a set of networking protocols which enables network devices to communicate and automatically establish working configurations with each other. When enabled, Windows computers can automatically discover the network camera on the local area network. The network camera also supports IGD.

### UPnP

Enable  Disable

Save settings

### IGD (UPnP Port Forward)

IGD Enable (UPnP Port Forward):  Enable  Disable

IGD Configuration (External Port):  IGD Fully Automation (Auto)  IGD Semi Automation (Manually)

External HTTP Port:

External RTSP Port:

<b>Enable/Disable</b>	Enable or disable UPnP.
<b>IGD Enable (UPnP Port Forward)</b>	Enable or disable Internet Gateway Device (IGD).
<b>IGD Configuration (External Port)</b>	Select fully-automated or semi-automated IGD.
<b>External HTTP Port</b>	Enter an external HTTP port.
<b>External RTSP Port</b>	Enter an external RTSP port.

## IV-1-7. Bonjour

Bonjour is a feature of Mac computers which allows Safari web browser to discover devices and services on the local network and provide a quick shortcut for access. When enabled, Safari users on the local network can find a shortcut to the network camera under Safari's "Bonjour" menu. Select "Enable" or "Disable".

Bonjour

Enable  Disable



## IV-2. Video



• Video

Privacy Protector

The “Video” menu consists of three categories for configuring the network camera’s video settings. Select an item from the submenu and refer to the appropriate following chapter.

### IV-2-1. Privacy Protector

Privacy Protector is a function which will display the camera’s live view as a black screen. This can be a useful tool when occupants are at home to address privacy concerns about network intruders.

Privacy Protector

Enable  Disable

Save settings

## IV-3. Events

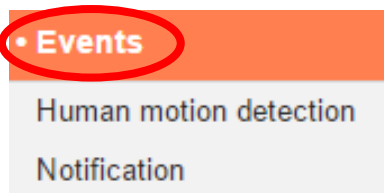

Select an item from the “Events” menu and refer to the appropriate following chapter. You can configure settings for motion detection, scheduling, SMTP and FTP.

### IV-3-1. Human Motion Detection

#### IV-3-1-1. Human Motion Detection

The network camera features a motion detection function and various options for (motion detection) events notification. When motion is detected, it is defined as an “event” and the camera will record for a specified length of time. You can set the camera to send this recording as a notification via email and/or to local storage such as a NAS or microSD card inside the camera.

You can also set the camera to send a push notification for each event to a smartphone with EdiLife installed. You can view a 10 second recording of the event, which is automatically stored in the network camera’s memory, from the app’s “Events” menu.



***Recordings stored automatically in the network camera are limited to 10 seconds and only a limited quantity can be stored. These recordings are separate from any recordings saved to local storage or sent via email, and will be overwritten as new recordings are created.***

## Human motion detection

PIR Enable :  Enable  Disable

## Email Notification

Send Event File to Email :  Enable  Disable

## Save Video To Local Storage

Save Event Files to NAS or SD :  Enable  Disable

Video Recording Time : 10

<b>PIR Enable</b>	Enable or disable the passive infrared sensor (PIR) motion detection function of your network camera.
<b>Send Event File to Email</b>	A video recording of a detected event can be sent to a designated email recipient. Select “Enable” or “Disable” for this function. When enabled, you need to configure email settings in the “Events → Notifications → Mail Settings” menu.
<b>Save Event Files to NAS or SD</b>	Enable or disable the camera’s function to save video files to NAS or MicroSD card. When enabled, you need to configure the settings in the “Storage Settings” menu.
<b>Video Recording Time</b>	Specify the length of time for the NAS or microSD video recording here.

## IV-3-1-2. Schedule Settings

The network camera's motion detection function can be scheduled to be active on/at specified times and days. Select "Enable" to enable this feature and then define which times the network camera's motion detection will be active using the table below.

For each day, click and drag across the timeline on the times which you want motion detection to be active. A blue box indicates a scheduled recording. In the example below, motion detection is scheduled for 8am – 6pm Monday to Saturday.



***By default, the schedule may be full. Delete existing entries if necessary.***

### Schedule Settings

Schedule :  Enable  Disable

00:00 03:00 06:00 09:00 12:00 15:00 18:00 21:00 24:00

Sunday

Monday

Tuesday

Wednesday

Thursday

Friday

Saturday

Delete Delete all Select all Store

Start : 08 : 00  
End : 18 : 00

<b>Delete</b>	Delete the selected blue recording block on the timeline.
<b>Delete All</b>	Delete all blue recording blocks on the timeline.
<b>Select All</b>	Select all blue recording blocks.
<b>Store</b>	Store the recording settings on the timeline.

## IV-3-2. Notification

### IV-3-2-1. Mail Settings

Recordings of events (motion detected) can be sent to a designated email recipient. This function must be enabled in “Motion Detection” settings in the “Events” menu. Enter the required information about your sender and recipient email accounts as shown below.

#### Mail Settings

Email Service Provider:	<input type="text" value="Manual Settings"/>
SMTP Server:	<input type="text"/>
SMTP Port:	<input type="text" value="25"/>
Recipient Email Address:	<input type="text"/>
Sender Email Address:	<input type="text"/>
SSL/TLS:	<input type="text" value="None"/>
SMTP Authentication:	<input type="radio"/> Enable <input checked="" type="radio"/> Disable
Account:	<input type="text"/>
Password:	<input type="text"/>
<input type="button" value="Save settings"/> <input type="button" value="Send test email"/>	

<b>Email Service Provider</b>	Select “Manual Settings” to enter the information manually or select a common email provider to enter some of the information automatically.
<b>SMTP Server</b>	Input the host name or IP address of the SMTP server for the email sender. This information can be provided by your email service provider.
<b>SMTP Port</b>	Input the SMTP port number for the email sender. Most SMTP servers use port number 25, while some SMTP servers use encrypted connections with a port number of 465. This information can be provided by your email

	service provider.
<b>Recipient E-Mail Address</b>	Enter the email recipient's email address here.
<b>Sender E-Mail Address</b>	Enter the sender's email address here to avoid spam filter issues.
<b>SSL/TLS</b>	Select 'SSL or TLS' when your SMTP server requires encryption.  Consult your mail server administrator when in doubt.
<b>SMTP Authentication</b>	Select 'Enable' when your SMTP server requires authentication. This information can be provided by your email service provider.
<b>Account</b>	Input the SMTP account name when your SMTP server requires authentication. This information can be provided by your email service provider.
<b>Password</b>	Input the password used for SMTP server authentication.
<b>Send Test Email</b>	Click here to send a test email with the current settings.



***Gmail users please ensure that “Less Secure Apps” is enabled in your Google account “Security” settings, otherwise your email password may be rejected.***

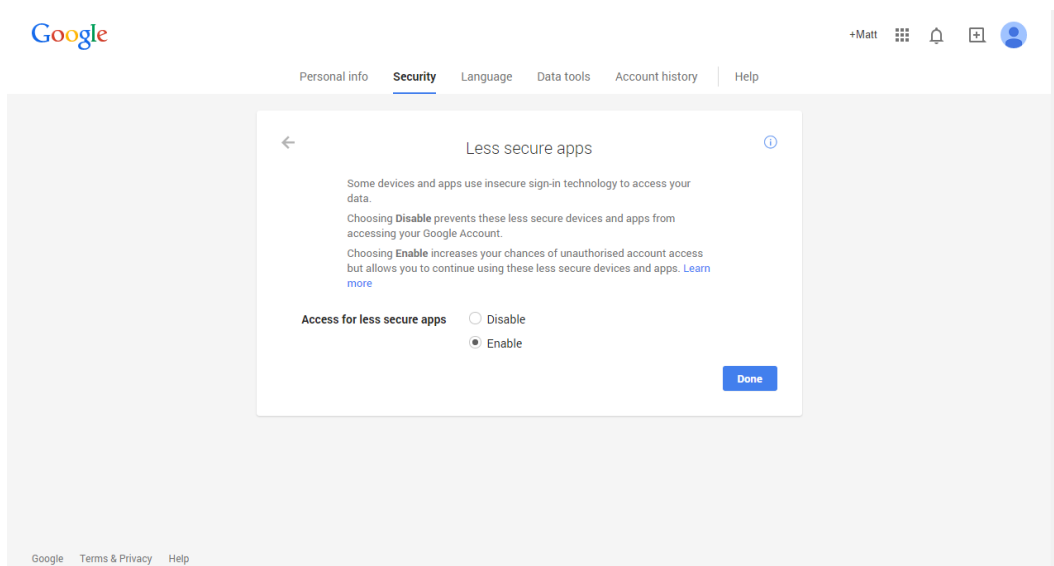

## IV-3-2-2. Push

The network camera can send push notifications to your smartphone if you have the EdiLife app installed. Push notifications can be sent based on motion detection events, and also when your camera reconnects to the Internet after a disconnection.



***Reconnection alerts are sent when the camera actually reconnects to the Internet, not when a disconnection occurs.***

### Push notification

- Push notification:  Enable  Disable
- Video motion alert:  On  Off
- Low Battery alert:  On  Off
- Reconnected to Internet alert:  On  Off

<b>Push notification</b>	Enable or disable all push notifications.
<b>Video motion alert</b>	Switch push notifications for motion detection events on or off.
<b>Low battery alert</b>	Switch push notifications for low battery status on or off.
<b>Reconnected to Internet alert</b>	Switch push notifications for Internet reconnection on or off.



### IV-3-2-3. HTTP

The network camera can send notifications to a HTTP server which is configured to listen. The destination server must be configured. Configure the camera's HTTP notification settings using the menu below. Notifications can be sent based on motion detection events. Select "PIR" from the list to begin configurations.

#### HTTP Notification

List:

Notification:  Enable  Disable

URL: http://  :  /

Method:  GET  POST

Authentication:  Enable  Disable

Username:

Password:

Timeout:  second

<b>Notification</b>	Enable or disable HTTP notifications.
<b>URL</b>	Enter the URL of the HTTP server including the port number.
<b>Method</b>	Select whether to use the GET or POST method for your HTTP server.
<b>Authentication</b>	Enable or disable authentication with your HTTP server.
<b>Username</b>	When authentication is enabled, enter the username.
<b>Password</b>	When authentication is enabled, enter the password.
<b>Timeout</b>	Set a timeout interval in seconds.

## IV-4. Storage Settings

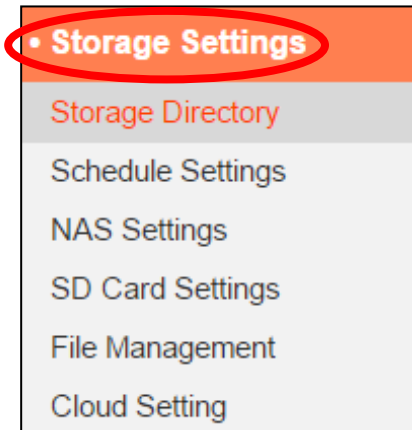

The “Storage Settings” menu enables you to configure the settings for local storage of motion detection events/recordings. You can also configure scheduled recording.

### IV-4-1. Storage Directory

The network camera can store recordings of motion detection events to local storage: NAS or MicroSD. Select your storage location and click “Save settings”.

#### Storage

Please select storage directory:

SD Card ▼

Save settings



***A MicroSD card must be installed in the network camera to use this function.***



***Configure the settings for your NAS or MicroSD card in the “NAS Settings” or “SD Card Settings” menu respectively.***

## IV-4-2. NAS Settings

If using a NAS server for local storage, configure the settings on this page according to your NAS.

### NAS Settings

Status: **Disconnected**

NAS IP & Sharing Resource : \\  \  \

Notification for space full :  Enable  Disable

Cycle Recording :  Enable  Disable

Authentication : **Anonymous** ▼

Username :

Password :

<b>Status</b>	Displays the status (connected or disconnected) of your network camera and NAS server.
<b>NAS IP &amp; Sharing Resource</b>	Enter the local IP address of your NAS and the path of a shared folder to store your network camera's recordings.
<b>Notification for space full</b>	Enable or disable email notifications when your storage space is full.
<b>Cycle Recording</b>	Enable or disable cycle recording. When enabled, cycle recording will overwrite the earliest recordings when the storage space becomes full. When disabled, recording will stop when storage is full.
<b>Authentication</b>	Select "Account" and enter the username and password in the fields below if your NAS server requires authentication. Select "Anonymous" if no authentication is required.
<b>Username</b>	Enter the username if "Account" is selected above.
<b>Password</b>	Enter the password if "Account" is selected above.

### IV-4-3. SD Card Settings



**Unmount your MicroSD card using the “Unmount” button before removing the card from your network camera.**

#### SD Card Settings

Status : No SD card available

Available Space :

Notify when space is not enough :  Enable  Disable

Cycle Recording :  Enable  Disable

<b>Status</b>	Displays the MicroSD card status of your network camera: available or unavailable.
<b>Available Space</b>	Displays the available space on the MicroSD card in your network camera.
<b>Notify when space is not enough</b>	Enable or disable email notifications when your storage space is full.
<b>Cycle Recording</b>	Enable or disable cycle recording. When enabled, cycle recording will overwrite the earliest recordings when the storage space becomes full. When disabled, recording will stop when storage is full.
<b>Format SD Card</b>	Click to format your MicroSD card. This will erase all data on your MicroSD card.
<b>Unmount</b>	Click to unmount your MicroSD card from the network camera. This is recommended before removing the MicroSD card from the camera.

## IV-4-4. File Management

### IV-4-4-1. JPEG

The file management tool enables you to browse, download and delete JPEG files on your MicroSD card.

Folders are organized by date, and then grouped chronologically beginning with 001. Individual file names consist of the date and time of the JPEG.

#### File List

1 - 4 File ( Total 4 )

[Back](#) [First Page](#) [Previous Page](#) [Next Page](#) [Last Page](#)

Select	File Name
<input type="checkbox"/>	 <a href="#">1970_01_01</a>
<input type="checkbox"/>	 <a href="#">2014_05_07</a>
<input type="checkbox"/>	 <a href="#">2014_05_08</a>
<input type="checkbox"/>	 <a href="#">2014_05_22</a>

[Select All](#) [Select None](#) [Delete](#)

<b>Back</b>	Go back to the previous page in the file browser.
<b>First Page</b>	Go back to the first page in the file browser.
<b>Previous Page</b>	Go back to the previous page in the file browser.
<b>Next Page</b>	Go to the next page in the file browser.
<b>Last Page</b>	Go to the last page in the file browser.
<b>Select All</b>	Select all files or folders visible in the file browser.
<b>Select None</b>	Deselect all selected files or folders.
<b>Delete</b>	Delete selected files or folders.

## IV-4-5. Cloud Setting

The network camera can store recordings of motion detection events to online cloud storage services such as Dropbox.



**Setup your Dropbox account using the EdiLife app.**

### Cloud Setting

Status : Disable

Cloud Setting :  Enable  Disable

Service Provider : Not selected

Folder Location : Edimax\_Cloud\_Recording/IPCamera\_Events/Door Cam

Cycle Recording :  Enable  Disable

Cycle Recording Notification :  Enable  Disable

Recycle Time :  Day

<b>Status</b>	Displays the status of the cloud storage function.
<b>Cloud Setting</b>	Enable or disable the cloud storage function.
<b>Service Provider</b>	Select a provider from the dropdown list if you want to unlink your cloud storage account from the camera.
<b>Folder Location</b>	Displays the folder location where recordings will be saved in your account.
<b>Cycle Recording</b>	Enable or disable cycle recording. When enabled, cycle recording will overwrite the earliest recordings when the storage space becomes full or at the specified number of days (below). When disabled, recording will stop when storage is full.
<b>Cycle Recording Notification</b>	Enable or disable notifications when a new recording cycle occurs and begins to overwrite previous recordings.
<b>Recycle Time</b>	Specify how many days a recording cycle can occur before beginning to overwrite earlier recordings.

## IV-5. System

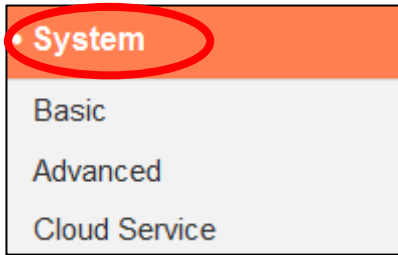

The “System” menu consists of three categories, “Basic”, “Advanced” and “Cloud Service”. Select a category and follow the appropriate chapter for more information.

### IV-5-1. Basic

The “Basic” menu enables you to set the camera’s name and administrator password, as well as switch the LED(s) on/off according to your preference.

#### Basic

Network Camera Name:

Administrator Password:

Confirm Password:

LED Indicators:  On  Off

<b>Network Camera Name</b>	Set the name of the network camera for reference/identification purposes. This is especially useful when managing multiple network cameras.
<b>Administrator Password</b>	Enter your desired administrator password here. This is the password used to log into the camera with the “admin” account. The default password is 1234.
<b>Confirm Password</b>	Confirm your desired administrator password here.
<b>LED Indication</b>	Select “On” or “Off” to switch the network camera’s LED(s) on or off. Switching off the LEDs can be a power saving measure or can be for security purposes, so that anybody who can see the network camera is unaware if the camera is active.

## IV-5-2. Advanced

The “Advanced” page allows you to upgrade the network camera’s firmware, backup or restore the network camera’s settings, and reset or restart the network camera. Please check the Edimax website for the latest firmware for your network camera.



***Do not switch off or disconnect the device during a firmware upgrade, as this could damage the device.***

### Upgrade Firmware

Firmware Filename:  No file chosen

### Backup/Restore Settings

Backup Settings:

Restore Settings:  No file chosen

### Reset

Restart:

Reset to Default:  Keep Network Settings  Default Settings

<b>Firmware Filename</b>	Click “Browse” to locate the firmware file on your computer.
<b>Upgrade Firmware</b>	Click to upgrade the firmware to your selected file.
<b>Backup Settings</b>	Click “Apply” to save the current settings on your computer as config.bin file.
<b>Restore Settings</b>	Click “Browse” to find a previously saved config.bin file and then click “Upload” to replace your current settings.
<b>Restart</b>	Click “Restart Network Camera” to restart the network camera. Please wait a couple of minutes for network camera to boot up after a restart. Restarting will not affect the camera’s current configuration.
<b>Reset to default</b>	Select “Keep Network Settings” or “Default



Settings” and then click “Reset to Default”.

When the camera resets, “Keep Network Settings” will reset all settings but keep the current network settings. The network camera’s IP address will remain the same.

“Default Settings” will reset all of the camera’s settings, including network settings, back to the factory default status.

### IV-5-3. Cloud Service

Edimax Plug & View is a function to allow you to view your network camera remotely via a cloud server (see **V. Myedimax.com**). You can enable or disable this feature here.

Plug & View

Enable  Disable

## IV-6. Status

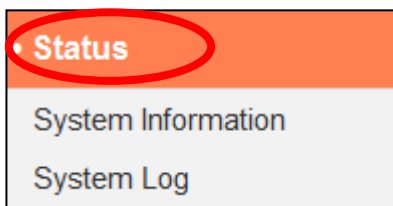

The “Status” menu provides important information about the status of the network camera. This information is useful for troubleshooting purposes or for network configuration.

### IV-6-1. System Information

A summary of system-wide information about the network camera is displayed on this page, displayed under four categories: System, LAN and IGD (UPnP Port Forward).

#### System

Firmware Version :	v1.00 (Mar 22 2016 18:16:42)
Activex Version :	v2.0.0.4
Device Uptime :	3 hours 10 min 27 sec
System Time :	2016/04/15 19:52:39

#### LAN

IP Address :	192.168.0.105
Subnet Mask :	255.255.255.0
Gateway :	192.168.0.1
DNS Server 1 :	192.168.0.1
DNS Server 2 :	0.0.0.0
MAC Address :	00:11:09:62:30:33
HTTP Port :	80

#### IGD (UPnP Port Forward)

Link Status :	Disconnected
External IP Address :	
External HTTP Port :	
External RTSP Port :	

## IV-6-2. System Log

A system log provides information about the network camera's usage and actions. The system log can also be sent to a remote server for archiving.

### System Log

Log Level:

Remote Log:  Enable  Disable

Remote Log Server:

```

May 22 06:26:25 VideoServer[1510]: <eventID>4</eventID><eventTime>2014/05/22 06:26:25</eventTime><det
May 22 06:26:25 recorder[1470]: [recorder.c:4867] Get Event (4)
May 22 06:26:25 pushNotifier[1390]: [pushNotifier.c:456] event.eventID = 4
May 22 06:26:25 pushNotifier[1390]: [pushNotifier.c:194] now - timestamp[IPCAM_EVENT_PIR] = 1400739985
May 22 06:26:25 pushNotifier[1390]: [pushNotifier.c:332] curl 'https://54.251.97.30:55443/push/notify.php' -d '<f
May 22 06:26:25 recorder[1472]: Storage media was not has enough space!! (0)
May 22 06:26:25 recorder[1472]: No enough space.
May 22 06:26:26 recorder[1470]: [recorder.c:4900] remove /tmp/eventRec/ImagePIR/2014-05-22-06-23-46-PIRE
May 22 06:26:26 recorder[1470]: [recorder.c:4906] remove /tmp/eventRec/ImagePIR/2014-05-22-06-23-46-PIRE
May 22 06:26:26 recorder[7424]: [recorder.c:1113] Connect socket: /tmp/mjpegPreRecStream
May 22 06:26:26 recorder[7424]: [recorder.c:1113] Connect socket: /tmp/audioMJPEGPreStream
May 22 06:26:26 recorder[7424]: [recorder.c:4019] Initial record file, start reocrd
May 22 06:26:26 VideoServer[1517]: [videoServer.c:1394] AudioMJPEG PreRec accept client sock=36
May 22 06:26:26 VideoServer[1517]: AudioMPJEG PreRec current connected socket: 175
May 22 06:26:26 VideoServer[1513]: [videoServer.c:1218] mjpeg PreRec accept client sock=46
May 22 06:26:26 VideoServer[1513]: mjpeg PreRec current connected socket: 116
May 22 06:26:26 recorder[1470]: [recorder.c:4941] (1/475139)thread record file /tmp/eventRec/ImagePIR/2014-0
May 22 06:26:28 recorder[1472]: Storage media was not has enough space!! (0)
May 22 06:26:28 recorder[1472]: No enough space.
May 22 06:26:31 recorder[1472]: Storage media was not has enough space!! (0)
May 22 06:26:31 recorder[1472]: No enough space.
May 22 06:26:34 recorder[1472]: Storage media was not has enough space!! (0)

```

<b>Log Level</b>	Select a level of detail for the log from the dropdown list, from 0 - 4. 0 (minimum) will only log critical information, while 4 (maximum) will log everything.
<b>Remote Log</b>	Enable or disable the network camera's remote log function, to send the log to a remote server for archiving. The network camera supports syslog log servers.
<b>Remote Log Server</b>	Enter the IP address or host name of the log server you wish to use.

## V. Myedimax.com

---

You can use your network camera's Myedimax.com cloud ID to monitor your camera remotely using a web browser from any Internet connection. The network camera's **green** power LED must display **on** to indicate a successful cloud connection, in order for this function to work.

 **Internet Explorer is recommended. Performance may vary according to browser.**

1. Identify your network camera's cloud ID. The cloud ID is displayed in EdiView Finder (see II-2. **EdiView Finder**) and on the product label on the back of the network camera (see I-4. **Product Label**).

 **The cloud ID is a string of 12 characters consisting of numbers 0 – 9 and letters A – F which is unique to your network camera.**



XXXXXXXXXXXXXXXXXXXX  
MAC/Cloud ID  
C3  
Setup SSID: EdiView.SetupC3

2. Enter **cloudID.myedimax.com** into the URL bar of a web browser.

For example, if your cloud ID is **001109010204** then enter **001109010204.myedimax.com** into your web browser.

 **Internet Explorer is recommended.**

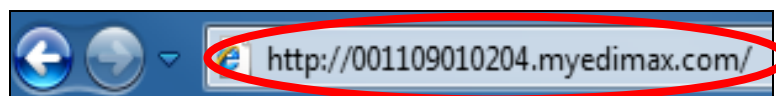

3. You may be prompted to allow a Java add-on to run. Please click the message where it says “click here” and then click “Run Add-on”.

. If you trust the website and the add-on and want to allow it to run, click here...

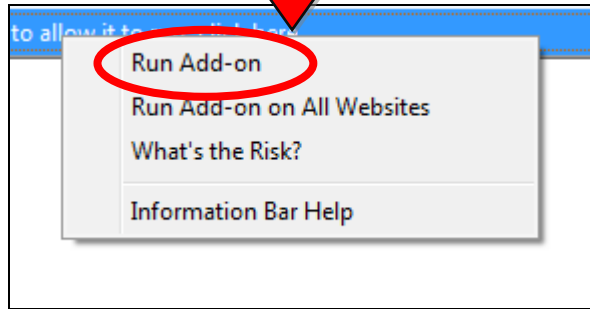

 ***If any other security warnings/prompts appear, please select “Run” or “Allow” or similar, depending on your browser.***

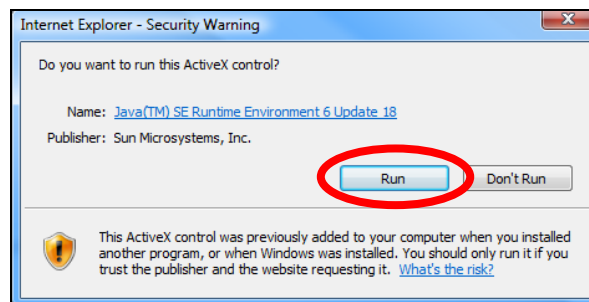

**4.** Enter your camera's password (default password: 1234) and click "OK" to see a live stream from your network camera.

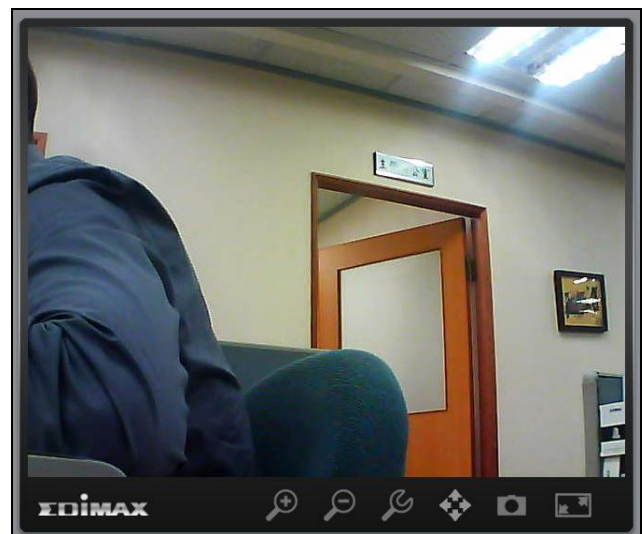

5. The network camera can be operated and configured using the icons in the toolbar located below the image.



To configure the network camera, click  to show the configuration menu window:

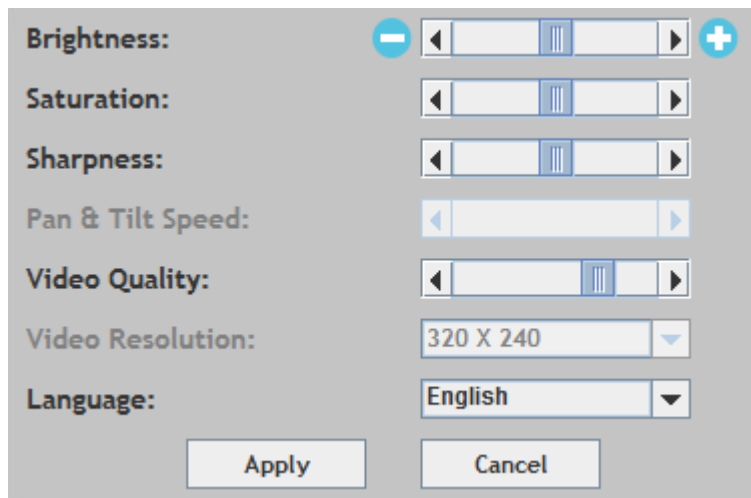

6. Use the slider controls to change the image brightness, saturation, sharpness, video quality and pan & tilt speed. Use the dropdown lists to change the video resolution and operating language, and click “Apply” when finished.

 **Functionality of myedimax.com may vary according to version.**

## VI. FAQs

If you are experiencing problems with your camera, please check below before contacting your dealer of purchase for help.

### 1. How can I setup my IC-6220DC to store recordings to a Dropbox account?

- a. You need to enter your Dropbox account login credentials into the EdiLife app after the camera is setup and working properly.

Go to **Settings** → **Advanced** → **Cloud Storage**.



Tap the **Login** switch to login to your account. You can enable **cycle recording** (overwrite earlier recordings when data storage is full) with **push notifications** and check the **cloud status**, as well as **enable** or **disable** the cloud service function altogether.



### 2. Are there any microSD/SDHC cards recommended for the IC-6220DC, IC-6230DC, IC-5160GC, IC-9110W, IC-7113W & IC-3140W?

- b. Minimum 8GB capacity is recommended with Class 10 speed rating. Below 2GB and above 32GB are not supported.

The following Class 10 cards have been tested for compatibility without issues:

Kingston 4GB  
Sandisk 4GB  
Sandisk 8GB  
Toshiba 8GB



Sandisk Ultra 16GB  
Kingston 32GB  
Fujitsu 32GB

### **3. How do I remove my microSD card from the camera?**

- a. Never unplug the card while the camera is on. This can damage your card. Ensure all recording functions such as event triggers are disabled and switch off your camera before removing the card.
- b. Alternatively go to 'SD Card Settings' in the camera's user interface and click "unmounts" before removing the card.

### **4. I see the error message "SD card has unexpected error, device system cannot write file anymore". Can my card still record?**

- a. No, there's a problem with your card. Typically microSD/SDHC cards have limited read-write times. After frequent or long-term usage, the file system can encounter this error. Format your card and try again or contact the card manufacturer for support. Be aware that formatting your card removes all existing data, and backup accordingly.

### **5. My camera stopped recording to my microSD/SDHC card.**

- a. Go to 'SD Card Settings' in the camera's user interface:
  1. Ensure there is enough space on your microSD/SDHC card.
  2. Try using "cycle recording" to periodically overwrite old recordings.
- b. Alternatively you can try formatting your SD card. Be aware that formatting your card removes all existing data, and backup accordingly.

### **6. My camera image is not clear?**

- a. Additionally try cleaning the lens with cleaning fabric as it may accumulate dust/fingerprints etc. over time and affect image quality.

### **7. My door camera is switched on but appears to be off.**

- a. Since the camera unit is battery powered to enable convenient wire-free installation, the camera will automatically power down and "standby" when not in use in order to conserve battery life. The camera will activate automatically when motion is detected or when you manually check the live feed using the web UI or the EdiLife app.

## *Federal Communication Commission Interference Statement*

This equipment has been tested and found to comply with the limits for a Class B digital device, pursuant to Part 15 of FCC Rules. These limits are designed to provide reasonable protection against harmful interference in a residential installation. This equipment generates, uses, and can radiate radio frequency energy and, if not installed and used in accordance with the instructions, may cause harmful interference to radio communications. However, there is no guarantee that interference will not occur in a particular installation. If this equipment does cause harmful interference to radio or television reception, which can be determined by turning the equipment off and on, the user is encouraged to try to correct the interference by one or more of the following measures:

1. Reorient or relocate the receiving antenna.
2. Increase the separation between the equipment and receiver.
3. Connect the equipment into an outlet on a circuit different from that to which the receiver is connected.
4. Consult the dealer or an experienced radio technician for help.

### **FCC Caution**

Any changes or modifications not expressly approved by the party responsible for compliance could void the authority to operate equipment.

This device complies with Part 15 of the FCC Rules. Operation is subject to the following two conditions: (1) this device may not cause harmful interference, and (2) this device must accept any interference received, including interference that may cause undesired operation.

### **FCC Radiation Exposure Statement:**

This equipment complies with FCC radiation exposure limits set forth for an uncontrolled environment. This equipment should be installed and operated with minimum distance 20cm between the radiator & your body. For product available in the USA/Canada market, only channel 1~11 can be operated. Selection of other channels is not possible. This device and its antenna(s) must not be co-located or operating in conjunction with any other antenna or transmitter.

### **R&TTE Compliance Statement**

This equipment complies with all the requirements of DIRECTIVE 1999/5/EC OF THE EUROPEAN PARLIAMENT AND THE COUNCIL of March 9, 1999 on radio equipment and telecommunication terminal equipment and the mutual recognition of their conformity (R&TTE). The R&TTE Directive repeals and replaces in the directive 98/13/EEC (Telecommunications Terminal Equipment and Satellite Earth Station Equipment) As of April 8, 2000.

### **Safety**

This equipment is designed with the utmost care for the safety of those who install and use it. However, special attention must be paid to the dangers of electric shock and static electricity when working with electrical equipment. All guidelines of this and of the computer manufacture must therefore be allowed at all times to ensure the safe use of the equipment.

### **EU Countries Intended for Use**

The ETSI version of this device is intended for home and office use in Austria, Belgium, Bulgaria, Cyprus, Czech, Denmark, Estonia, Finland, France, Germany, Greece, Hungary, Ireland, Italy, Latvia, Lithuania, Luxembourg, Malta, Netherlands, Poland, Portugal, Romania, Slovakia, Slovenia, Spain, Sweden, Turkey, and United Kingdom. The ETSI version of this device is also authorized for use in EFTA member states: Iceland, Liechtenstein, Norway, and Switzerland.

### **EU Countries Not Intended for Use**

None

## EU Declaration of Conformity

- English:** This equipment is in compliance with the essential requirements and other relevant provisions of Directive 1995/95/EC, 2011/65/EC.
- Français:** Cet équipement est conforme aux exigences essentielles et autres dispositions de la directive 1995/95/CE, 2011/65/CE.
- Čeština:** Toto zařízení je v souladu se základními požadavky a ostatními příslušnými ustanoveními směrnic 1995/95/ES, 2011/65/ES.
- Polski:** Urządzenie jest zgodne z ogólnymi wymaganiami oraz szczególnymi warunkami określonymi Dyrektywą UE 1995/95/EC, 2011/65/EC..
- Română:** Acest echipament este în conformitate cu cerințele esențiale și alte prevederi relevante ale Directivei 1995/95/CE, 2011/65/CE.
- Русский:** Это оборудование соответствует основным требованиям и положениям Директивы 1995/95/EC, 2011/65/EC.
- Magyar:** Ez a berendezés megfelel az alapvető követelményeknek és más vonatkozó irányelveknek (1995/95/EK, 2011/65/EK).
- Türkçe:** Bu cihaz 1995/95/EC, 2011/65/EC direktifleri zorunlu istekler ve diğer hükümlerle ile uyumludur.
- Українська:** Обладнання відповідає вимогам і умовам директиви 1995/95/EC, 2011/65/EC.
- Slovenčina:** Toto zariadenie spĺňa základné požiadavky a ďalšie príslušné ustanovenia smerníc 1995/95/ES, 2011/65/ES.
- Deutsch:** Dieses Gerät erfüllt die Voraussetzungen gemäß den Richtlinien 1995/95/EC, 2011/65/EC.
- Español:** El presente equipo cumple los requisitos esenciales de la Directiva 1995/95/EC, 2011/65/EC.
- Italiano:** Questo apparecchio è conforme ai requisiti essenziali e alle altre disposizioni applicabili della Direttiva 1995/95/CE, 2011/65/CE.
- Nederlands:** Dit apparaat voldoet aan de essentiële eisen en andere van toepassing zijnde bepalingen van richtlijn 1995/95/EC, 2011/65/EC..
- Português:** Este equipamento cumpre os requisitos essenciais da Directiva 1995/95/EC, 2011/65/EC.
- Norsk:** Dette utstyret er i samsvar med de viktigste kravene og andre relevante regler i Direktiv 1995/95/EC, 2011/65/EC.
- Svenska:** Denna utrustning är i överensstämmelse med de väsentliga kraven och övriga relevanta bestämmelser i direktiv 1995/95/EG, 2011/65/EG.
- Dansk:** Dette udstyr er i overensstemmelse med de væsentligste krav og andre relevante forordninger i direktiv 1995/95/EC, 2011/65/EC.
- suomen kieli:** Tämä laite täyttää direktiivien 1995/95/EY, 2011/65/EY oleelliset vaatimukset ja muut asiaankuuluvat määräykset.

FOR USE IN 



---

### WEEE Directive & Product Disposal



At the end of its serviceable life, this product should not be treated as household or general waste. It should be handed over to the applicable collection point for the recycling of electrical and electronic equipment, or returned to the supplier for disposal.

## Declaration of Conformity

We, Edimax Technology Co., Ltd., declare under our sole responsibility, that the equipment described below complies with the requirements of the European R&TTE directive (1999/5/EC, 2006/95/EC) .

**Equipment:** Wireless Door Camera  
**Model No.:** IC-6220DC

The following European standards for essential requirements have been followed:

**Spectrum:** ETSI EN 300 328 V1.9.1 (2015-02)  
**EMC:** EN 301 489-1 V1.9.2 (2011-09);  
EN 301 489-17 V2.2.1 (2012-09)  
**EMF:** EN 62311:2008  
**Safety (LVD):** IEC 60950-1:2005 (2nd Edition);Am1:2009+ Am2:2013  
EN-60950-1:2006+A11:2009+A1:2010+A12:2011+ A2:2013

Edimax Technology Europe B.V.  
Fijenhof 2,  
5652 AE Eindhoven  
THE NETHERLANDS

a company of :  
Edimax Technology Co., Ltd.,  
No. 3, Wu Chuan 3<sup>rd</sup> Road,  
Wu-Ku Industrial Park,  
New Taipei City, Taiwan

Signature:

Printed Name: Vivian Ma  
Title: Director  
Edimax Technology Europe B.V.

Date of Signature: June. 30, 2016

Signature:



Printed Name: Albert Chang

Title: Director

Edimax Technology Co., Ltd.



## Notice According to GNU General Public License Version 2

This product includes software that is subject to the GNU General Public License version 2. The program is free software and distributed without any warranty of the author. We offer, valid for at least three years, to give you, for a charge no more than the costs of physically performing source distribution, a complete machine-readable copy of the corresponding source code.

Das Produkt beinhaltet Software, die den Bedingungen der GNU/GPL-Version 2 unterliegt. Das Programm ist eine sog. „Free Software“, der Autor stellt das Programm ohne irgendeine Gewährleistungen zur Verfügung. Wir bieten Ihnen für einen Zeitraum von drei Jahren an, eine vollständige maschinenlesbare Kopie des Quelltextes der Programme zur Verfügung zu stellen – zu nicht höheren Kosten als denen, die durch den physikalischen Kopiervorgang anfallen.

### GNU GENERAL PUBLIC LICENSE

Version 2, June 1991

Copyright (C) 1989, 1991 Free Software Foundation, Inc. 51 Franklin Street, Fifth Floor, Boston, MA 02110-1301, USA  
Everyone is permitted to copy and distribute verbatim copies of this license document, but changing it is not allowed.

#### Preamble

The licenses for most software are designed to take away your freedom to share and change it. By contrast, the GNU General Public License is intended to guarantee your freedom to share and change free software—to make sure the software is free for all its users. This General Public License applies to most of the Free Software Foundation’s software and to any other program whose authors commit to using it. (Some other Free Software Foundation software is covered by the GNU Lesser General Public License instead.) You can apply it to your programs, too.

When we speak of free software, we are referring to freedom, not price. Our General Public Licenses are designed to make sure that you have the freedom to distribute copies of free software (and charge for this service if you wish), that you receive source code or can get it if you want it, that you can change the software or use pieces of it in new free programs; and that you know you can do these things.

To protect your rights, we need to make restrictions that forbid anyone to deny you these rights or to ask you to surrender the rights. These restrictions translate to certain responsibilities for you if you distribute copies of the software, or if you modify it.

For example, if you distribute copies of such a program, whether gratis or for a fee, you must give the recipients all the rights that you have. You must make sure that they, too, receive or can get the source code. And you must show them these terms so they know their rights.

We protect your rights with two steps: (1) copyright the software, and (2) offer you this license which gives you legal permission to copy, distribute and/or modify the software.

Also, for each author’s protection and ours, we want to make certain that everyone understands that there is no warranty for this free software. If the software is modified by someone else and passed on, we want its recipients to know that what they have is not the original, so that any problems introduced by others will not reflect on the original authors’ reputations.

Finally, any free program is threatened constantly by software patents. We wish to avoid the danger that redistributors of a free program will individually obtain patent licenses, in effect making the program proprietary. To prevent this, we have made it clear that any patent must be licensed for everyone’s free use or not licensed at all.

The precise terms and conditions for copying, distribution and modification follow.

#### TERMS AND CONDITIONS FOR COPYING, DISTRIBUTION AND MODIFICATION

0. This License applies to any program or other work which contains a notice placed by the copyright holder saying it may be distributed under the terms of this General Public License. The “Program”, below, refers to any such program or work, and a “work based on the Program” means either the Program or any derivative work under copyright law: that is to say, a work containing the Program or a portion of it, either verbatim or with modifications and/or translated into another language. (Hereinafter, translation is included without limitation in the term “modification”.) Each licensee is addressed as “you”.

Activities other than copying, distribution and modification are not covered by this License; they are outside its scope. The act of running the Program is not restricted, and the output from the Program is covered only if its contents constitute a work based on the Program (independent of having been made by running the Program). Whether that is true depends on what the Program does.

1. You may copy and distribute verbatim copies of the Program's source code as you receive it, in any medium, provided that you conspicuously and appropriately publish on each copy an appropriate copyright notice and disclaimer of warranty; keep intact all the notices that refer to this License and to the absence of any warranty; and give any other recipients of the Program a copy of this License along with the Program.

You may charge a fee for the physical act of transferring a copy, and you may at your option offer warranty protection in exchange for a fee.

2. You may modify your copy or copies of the Program or any portion of it, thus forming a work based on the Program, and copy and distribute such modifications or work under the terms of Section 1 above, provided that you also meet all of these conditions:

- a) You must cause the modified files to carry prominent notices stating that you changed the files and the date of any change.
- b) You must cause any work that you distribute or publish, that in whole or in part contains or is derived from the Program or any part thereof, to be licensed as a whole at no charge to all third parties under the terms of this License.
- c) If the modified program normally reads commands interactively when run, you must cause it, when started running for such interactive use in the most ordinary way, to print or display an announcement including an appropriate copyright notice and a notice that there is no warranty (or else, saying that you provide a warranty) and that users may redistribute the program under these conditions, and telling the user how to view a copy of this License. (Exception: if the Program itself is interactive but does not normally print such an announcement, your work based on the Program is not required to print an announcement.)

These requirements apply to the modified work as a whole. If identifiable sections of that work are not derived from the Program, and can be reasonably considered independent and separate works in themselves, then this License, and its terms, do not apply to those sections when you distribute them as separate works. But when you distribute the same sections as part of a whole which is a work based on the Program, the distribution of the whole must be on the terms of this License, whose permissions for other licensees extend to the entire whole, and thus to each and every part regardless of who wrote it.

Thus, it is not the intent of this section to claim rights or contest your rights to work written entirely by you; rather, the intent is to exercise the right to control the distribution of derivative or collective works based on the Program.

In addition, mere aggregation of another work not based on the Program with the Program (or with a work based on the Program) on a volume of a storage or distribution medium does not bring the other work under the scope of this License.

3. You may copy and distribute the Program (or a work based on it, under Section 2) in object code or executable form under the terms of Sections 1 and 2 above provided that you also do one of the following:

- a) Accompany it with the complete corresponding machine-readable source code, which must be distributed under the terms of Sections 1 and 2 above on a medium customarily used for software interchange; or,
- b) Accompany it with a written offer, valid for at least three years, to give any third party, for a charge no more than your cost of physically performing source distribution, a complete machine-readable copy of the corresponding source code, to be distributed under the terms of Sections 1 and 2 above on a medium customarily used for software interchange; or,
- c) Accompany it with the information you received as to the offer to distribute corresponding source code. (This alternative is allowed only for noncommercial distribution and only if you received the program in object code or executable form with such an offer, in accord with Subsection b above.)

The source code for a work means the preferred form of the work for making modifications to it. For an executable work, complete source code means all the source code for all modules it contains, plus any associated interface definition files, plus the scripts used to control compilation and installation of the executable. However, as a special exception, the source code distributed need not include anything that is normally distributed (in either source or binary form) with the major components (compiler, kernel, and so on) of the operating system on which the executable runs, unless that component itself accompanies the executable.

If distribution of executable or object code is made by offering access to copy from a designated place, then offering equivalent access to copy the source code from the same place counts as distribution of the source code, even though third parties are not compelled to copy the source along with the object code.

4. You may not copy, modify, sublicense, or distribute the Program except as expressly provided under this License. Any attempt otherwise to copy, modify, sublicense or distribute the Program is void, and will automatically terminate your rights under this License. However, parties who have received copies, or rights, from you under this License will not have their licenses terminated so long as such parties remain in full compliance.

5. You are not required to accept this License, since you have not signed it. However, nothing else grants you permission to modify or distribute the Program or its derivative works. These actions are prohibited by law if you do not accept this License.

Therefore, by modifying or distributing the Program (or any work based on the Program), you indicate your acceptance of this License to do so, and all its terms and conditions for copying, distributing or modifying the Program or works based on it.

6. Each time you redistribute the Program (or any work based on the Program), the recipient automatically receives a license from the original licensor to copy, distribute or modify the Program subject to these terms and conditions. You may not impose any further restrictions on the recipients' exercise of the rights granted herein. You are not responsible for enforcing compliance by third parties to this License.

7. If, as a consequence of a court judgment or allegation of patent infringement or for any other reason (not limited to patent issues), conditions are imposed on you (whether by court order, agreement or otherwise) that contradict the conditions of this License, they do not excuse you from the conditions of this License. If you cannot distribute so as to satisfy simultaneously your obligations under this License and any other pertinent obligations, then as a consequence you may not distribute the Program at all. For example, if a patent license would not permit royalty-free redistribution of the Program by all those who receive copies directly or indirectly through you, then the only way you could satisfy both it and this License would be to refrain entirely from distribution of the Program.

If any portion of this section is held invalid or unenforceable under any particular circumstance, the balance of the section is intended to apply and the section as a whole is intended to apply in other circumstances.

It is not the purpose of this section to induce you to infringe any patents or other property right claims or to contest validity of any such claims; this section has the sole purpose of protecting the integrity of the free software distribution system, which is implemented by public license practices. Many people have made generous contributions to the wide range of software distributed through that system in reliance on consistent application of that system; it is up to the author/donor to decide if he or she is willing to distribute software through any other system and a licensee cannot impose that choice.

This section is intended to make thoroughly clear what is believed to be a consequence of the rest of this License.

8. If the distribution and/or use of the Program is restricted in certain countries either by patents or by copyrighted interfaces, the original copyright holder who places the Program under this License may add an explicit geographical distribution limitation excluding those countries, so that distribution is permitted only in or among countries not thus excluded. In such case, this License incorporates the limitation as if written in the body of this License.

9. The Free Software Foundation may publish revised and/or new versions of the General Public License from time to time. Such new versions will be similar in spirit to the present version, but may differ in detail to address new problems or concerns.

Each version is given a distinguishing version number. If the Program specifies a version number of this License which applies to it and "any later version", you have the option of following the terms and conditions either of that version or of any later version published by the Free Software Foundation. If the Program does not specify a version number of this License, you may choose any version ever published by the Free Software Foundation.

10. If you wish to incorporate parts of the Program into other free programs whose distribution conditions are different, write to the author to ask for permission. For software which is copyrighted by the Free Software Foundation, write to the Free Software Foundation; we sometimes make exceptions for this. Our decision will be guided by the two goals of preserving the free status of all derivatives of our free software and of promoting the sharing and reuse of software generally.

#### **NO WARRANTY**

11. BECAUSE THE PROGRAM IS LICENSED FREE OF CHARGE, THERE IS NO WARRANTY FOR THE PROGRAM, TO THE EXTENT PERMITTED BY APPLICABLE LAW. EXCEPT WHEN OTHERWISE STATED IN WRITING THE COPYRIGHT HOLDERS AND/OR OTHER PARTIES PROVIDE THE PROGRAM "AS IS" WITHOUT WARRANTY OF ANY KIND, EITHER EXPRESSED OR IMPLIED, INCLUDING, BUT NOT LIMITED TO, THE IMPLIED WARRANTIES OF MERCHANTABILITY AND FITNESS FOR A PARTICULAR PURPOSE. THE ENTIRE RISK AS TO THE QUALITY AND PERFORMANCE OF THE PROGRAM IS WITH YOU. SHOULD THE PROGRAM PROVE DEFECTIVE, YOU ASSUME THE COST OF ALL NECESSARY SERVICING, REPAIR OR CORRECTION.

12. IN NO EVENT UNLESS REQUIRED BY APPLICABLE LAW OR AGREED TO IN WRITING WILL ANY COPYRIGHT HOLDER, OR ANY OTHER PARTY WHO MAY MODIFY AND/OR REDISTRIBUTE THE PROGRAM AS PERMITTED ABOVE, BE LIABLE TO YOU FOR DAMAGES, INCLUDING ANY GENERAL, SPECIAL, INCIDENTAL OR CONSEQUENTIAL DAMAGES ARISING OUT OF THE USE OR INABILITY TO USE THE PROGRAM (INCLUDING BUT NOT LIMITED TO LOSS OF DATA OR DATA BEING RENDERED INACCURATE OR LOSSES SUSTAINED BY YOU OR THIRD PARTIES OR A FAILURE OF THE PROGRAM TO OPERATE WITH ANY OTHER PROGRAMS), EVEN IF SUCH HOLDER OR OTHER PARTY HAS BEEN ADVISED OF THE POSSIBILITY OF SUCH DAMAGES.



**ΣDIMAX**  
NETWORKING PEOPLE TOGETHER

The logo features the Greek letter Sigma (Σ) followed by the word 'DIMAX' in a bold, sans-serif font. A small red dot is positioned above the 'I'. Below the main text, the tagline 'NETWORKING PEOPLE TOGETHER' is written in a smaller, all-caps font. The background is a dark grey/black band filled with various white line-art icons, including a handshake, musical notes, a smiley face, a game controller, a laptop, and a network diagram.