



Questo manuale d'istruzione è fornito da trovaprezzi.it. Scopri tutte le offerte per [AOC AGON PRO AG246FK](#) o cerca il tuo prodotto tra le [migliori offerte di Monitor](#)



Questo manuale d'istruzione è fornito da trovaprezzi.it. Scopri tutte le offerte per [AOC AGON PRO AG246FK](#) o cerca il tuo prodotto tra le [migliori offerte di Monitor](#)



LCD Monitor
User Manual
AG246FK

AOC

Safety.....	1
National Conventions.....	1
Power.....	2
Installation.....	3
Cleaning.....	4
Other.....	5
Setup.....	6
Contents in Box.....	6
Setup Stand & Base.....	7
Adjusting the monitor.....	8
Connecting the Monitor.....	9
Wall Mounting.....	10
Adaptive-Sync function.....	12
HDR.....	13
Adjusting.....	14
Hotkeys.....	14
Quick Switch.....	15
OSD Key Guide (Menu).....	16
OSD Setting.....	18
Game Setting.....	19
Luminance.....	21
PIP Setting.....	22
Color Setup.....	23
Audio.....	24
Light FX.....	25
Extra.....	26
OSD Setup.....	27
LED Indicator.....	28
Troubleshoot.....	29
Specification.....	30
General Specification.....	30
Preset Display Modes.....	31
Pin Assignments.....	32
Plug and Play.....	33

Safety

National Conventions

The following subsections describe notational conventions used in this document.

Notes, Cautions, and Warnings

Throughout this guide, blocks of text may be accompanied by an icon and printed in bold type or in italic type. These blocks are notes, cautions, and warnings, and they are used as follows:



NOTE: A NOTE indicates important information that helps you make better use of your computer system.





CAUTION: A CAUTION indicates either potential damage to hardware or loss of data and tells you how to avoid the problem.



WARNING: A WARNING indicates the potential for bodily harm and tells you how to avoid the problem. Some warnings may appear in alternate formats and may be unaccompanied by an icon. In such cases, the specific presentation of the warning is mandated by regulatory authority.

Power

 The monitor should be operated only from the type of power source indicated on the label. If you are not sure of the type of power supplied to your home, consult your dealer or local power company.

 The monitor is equipped with a three-pronged grounded plug, a plug with a third (grounding) pin. This plug will fit only into a grounded power outlet as a safety feature. If your outlet does not accommodate the three-wire plug, have an electrician install the correct outlet, or use an adapter to ground the appliance safely. Do not defeat the safety purpose of the grounded plug.

 Unplug the unit during a lightning storm or when it will not be used for long periods of time. This will protect the monitor from damage due to power surges.

 Do not overload power strips and extension cords. Overloading can result in fire or electric shock.

 To ensure satisfactory operation, use the monitor only with UL listed computers which have appropriate configured receptacles marked between 100-240V AC, Min. 5A.

 The wall socket shall be installed near the equipment and shall be easily accessible.

Installation

! Do not place the monitor on an unstable cart, stand, tripod, bracket, or table. If the monitor falls, it can injure a person and cause serious damage to this product. Use only a cart, stand, tripod, bracket, or table recommended by the manufacturer or sold with this product. Follow the manufacturer's instructions when installing the product and use mounting accessories recommended by the manufacturer. A product and cart combination should be moved with care.

! Never push any object into the slot on the monitor cabinet. It could damage circuit parts causing a fire or electric shock. Never spill liquids on the monitor.

! Do not place the front of the product on the floor.

! If you mount the monitor on a wall or shelf, use a mounting kit approved by the manufacturer and follow the kit instructions.

! Leave some space around the monitor as shown below. Otherwise, air-circulation may be inadequate hence overheating may cause a fire or damage to the monitor.

! To avoid potential damage, for example the panel peeling from the bezel, ensure that the monitor does not tilt downward by more than -5 degrees. If the -5 degree downward tilt angle maximum is exceeded, the monitor damage will not be covered under warranty.

See below the recommended ventilation areas around the monitor when the monitor is installed on the wall or on the stand:

Installed with stand

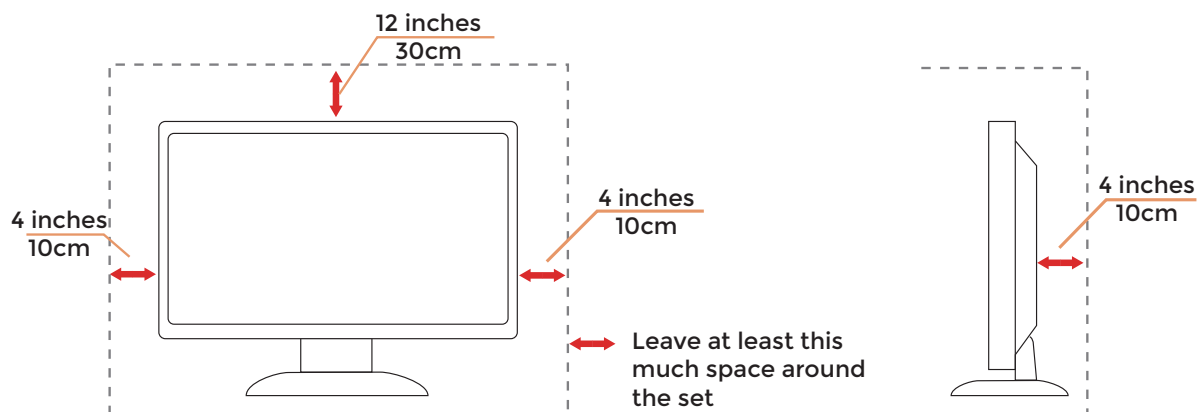

Cleaning

⚠ Clean the cabinet regularly with a water-dampened, soft cloth.

⚠ When cleaning use a soft cotton or microfiber cloth. The cloth should be damp and almost dry, do not allow liquid into the case.



⚠ Please disconnect the power cord before cleaning the product.

Other

 If the product is emitting a strange smell, sound or smoke, disconnect the power plug IMMEDIATELY and contact a Service Center.

 Make sure that the ventilating openings are not blocked by a table or curtain.

 Do not engage the LCD monitor in severe vibration or high impact conditions during operation.

 Do not knock or drop the monitor during operation or transportation.

Setup

Contents in Box

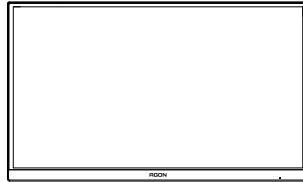

Monitor

*



Quick Start Guide

*



Warranty Card



Stand

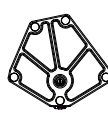

Base

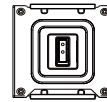

Wall Mount Bracket



Screwdriver



Screws



Power Cable

*



DP Cable

*



HDMI Cable

*



USB B-A Cable

*



Quick Switch Keypad

* Not all signal cables will be provided for all countries and regions. Please check with the local dealer or AOC branch office for confirmation.

Setup Stand & Base

Please setup or remove the base following the steps as below.

Setup:

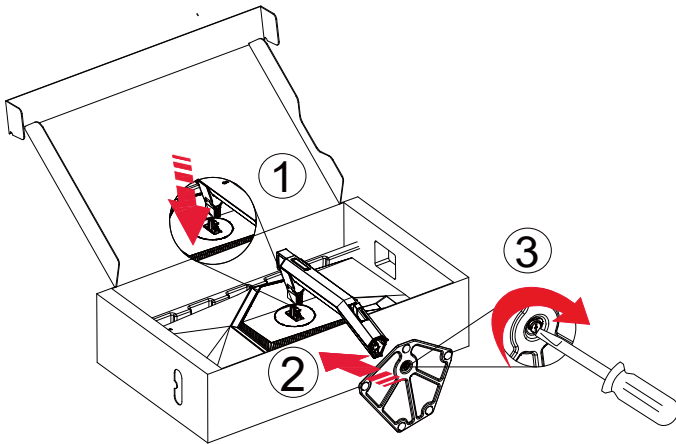

Remove:

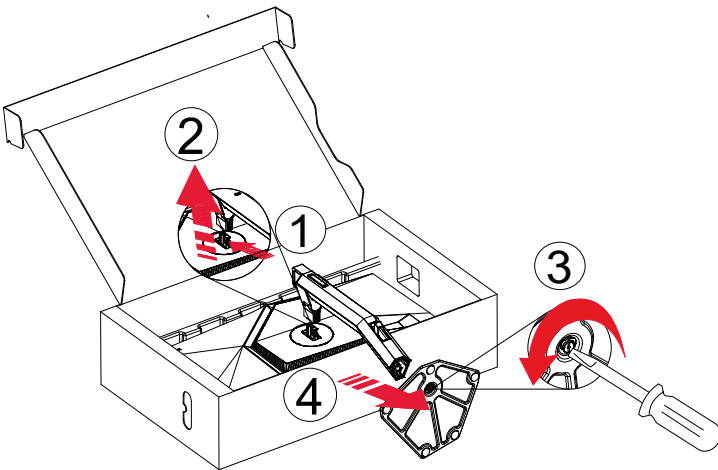

 **NOTE:** Display design may differ from those illustrated.

Adjusting the monitor

For optimal viewing it is recommended to look at the full face of the monitor, then adjust the monitor's angle to your own preference.

Hold the stand so you will not topple the monitor when you change the monitor's angle.

You are able to adjust the monitor as below:

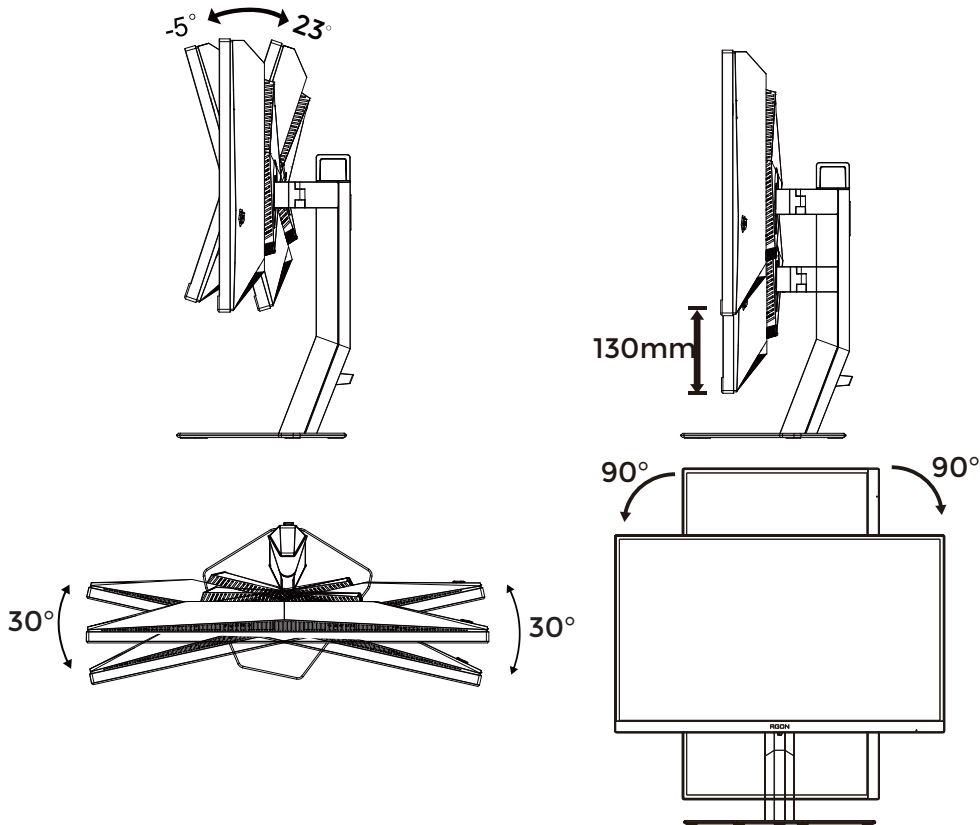

 **NOTE:**

Do not touch the LCD screen when you change the angle. Touching the LCD screen may cause damage.

Warning:

1. To avoid potential screen damage, such as panel peeling, ensure that the monitor does not tilt downward by more than -5 degrees.
2. Do not press the screen while adjusting the angle of the monitor. Grasp only the bezel.

Connecting the Monitor

Cable Connections In Back of Monitor.

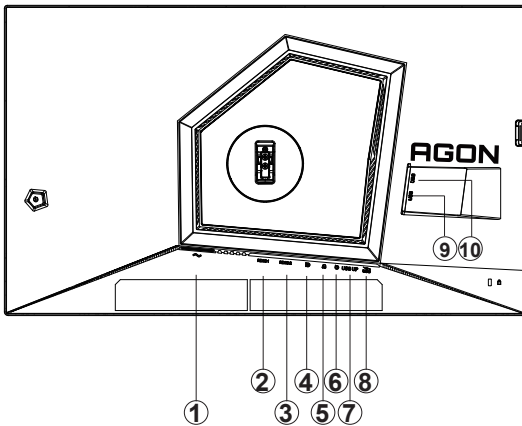

1. Power
2. HDMI1
3. HDMI2
4. DP
5. Earphone
6. Quick Switch port
7. USB3.2 Gen1 upstream
8. USB3.2 Gen1 downstream + fast charging
9. USB3.2 Gen1 downstream
10. USB3.2 Gen1 downstream

Connect to PC

1. Connect the power cord to the back of the display firmly.
2. Turn off your computer and unplug its power cable.
3. Connect the display signal cable to the video connector on your computer.
4. Plug the power cord of your computer and your display into a nearby outlet.
5. Turn on your computer and display.

If your monitor displays an image, installation is complete. If it does not display an image, please refer Troubleshooting.

To protect equipment, always turn off the PC and LCD monitor before connecting.

Wall Mounting

Preparing to Install An Optional Wall Mounting Arm.

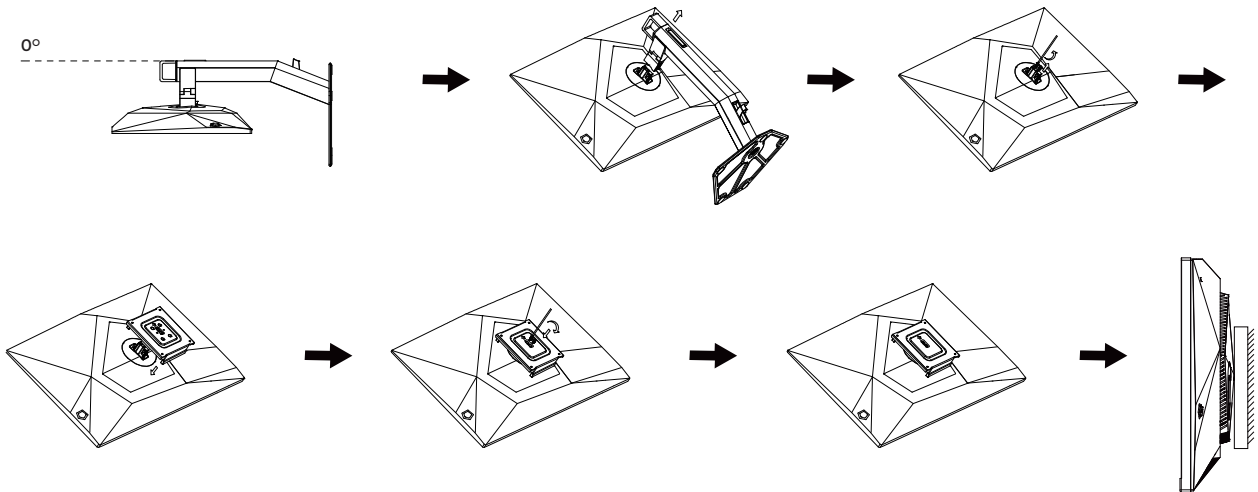

This monitor can be attached to a wall mounting arm you purchase separately. Disconnect power before this procedure. Follow these steps:

1. Remove the base.
2. Follow the manufacturer's instructions to assemble the wall mounting arm.
3. Place the wall mounting arm onto the back of the monitor. Line up the holes of the arm with the holes in the back of the monitor.
4. Reconnect the cables. Refer to the user's manual that came with the optional wall mounting arm for instructions on attaching it to the wall.

Wall hanger:

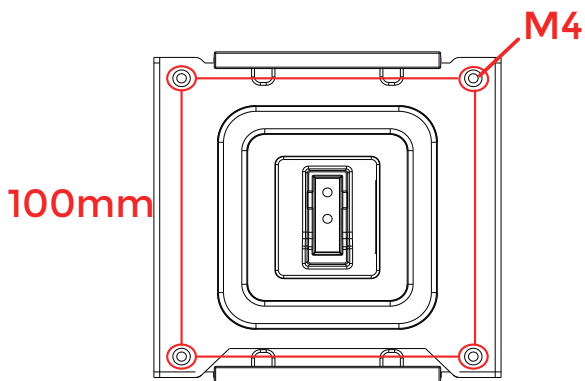

Specification of wall hanger screws: M4*(12+X)mm, (X=Thickness of Wall mount bracket)

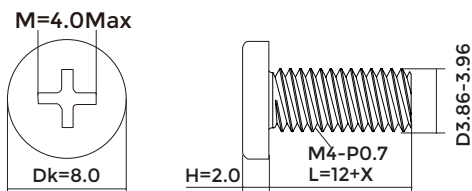

 **Noted:** VESA mounting screw holes are not available for all models, please check with the dealer or official department of AOC. Always contact manufacturer for wall-mount installation.

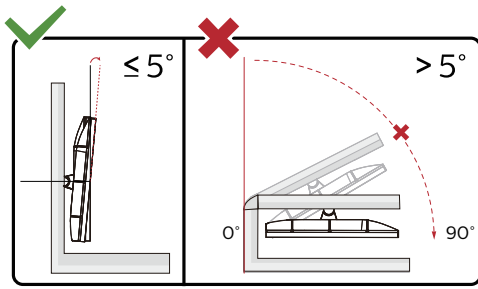

* Display design may differ from those illustrated.

Warning:

1. To avoid potential screen damage, such as panel peeling, ensure that the monitor does not tilt downward by more than -5 degrees.
2. Do not press the screen while adjusting the angle of the monitor. Grasp only the bezel.

Adaptive-Sync function

1. Adaptive-Sync function is working with DP/HDMI
2. Compatible Graphics Card: Recommend list is as the below, also could be checked by visiting www.AMD.com

Graphics Cards

- Radeon™ RX Vega series
- Radeon™ RX 500 series
- Radeon™ RX 400 series
- Radeon™ R9/R7 300 series (R9 370/X, R7 370/X, R7 265 except)
- Radeon™ Pro Duo (2016)
- Radeon™ R9 Nano series
- Radeon™ R9 Fury series
- Radeon™ R9/R7 200 series (R9 270/X, R9 280/X except)

Processors

- AMD Ryzen™ 7 2700U
- AMD Ryzen™ 5 2500U
- AMD Ryzen™ 5 2400G
- AMD Ryzen™ 3 2300U
- AMD Ryzen™ 3 2200G
- AMD PRO A12-9800
- AMD PRO A12-9800E
- AMD PRO A10-9700
- AMD PRO A10-9700E
- AMD PRO A8-9600
- AMD PRO A6-9500
- AMD PRO A6-9500E
- AMD PRO A12-8870
- AMD PRO A12-8870E
- AMD PRO A10-8770
- AMD PRO A10-8770E
- AMD PRO A10-8750B
- AMD PRO A8-8650B
- AMD PRO A6-8570
- AMD PRO A6-8570E
- AMD PRO A4-8350B
- AMD A10-7890K
- AMD A10-7870K
- AMD A10-7850K
- AMD A10-7800
- AMD A10-7700K
- AMD A8-7670K
- AMD A8-7650K
- AMD A8-7600
- AMD A6-7400K

HDR

It is compatible with input signals in HDR10 format.

The display may automatically activate the HDR function if the player and content are compatible. Please contact the device manufacturer and the content provider for information on the compatibility of your device and content. Please select "OFF" for the HDR function when you have no need for automatical activation function.

Note:

1. No special setting is needed for the DisplayPort/HDMI interface in WIN10 versions lower (older) than V1703.
2. Only the HDMI interface is available and the DisplayPort interface cannot function in WIN10 version V1703.
3. 3840x2160@50Hz/60Hz not suggestion used in PC device only for UHD player or Xbox-ones / PS4-Pro. Display Settings:
 - a. The display resolution is set to 1920*1080.
 - b. After entering an application, the best HDR effect can be achieved when the resolution is changed to 1920*1080 (if available).

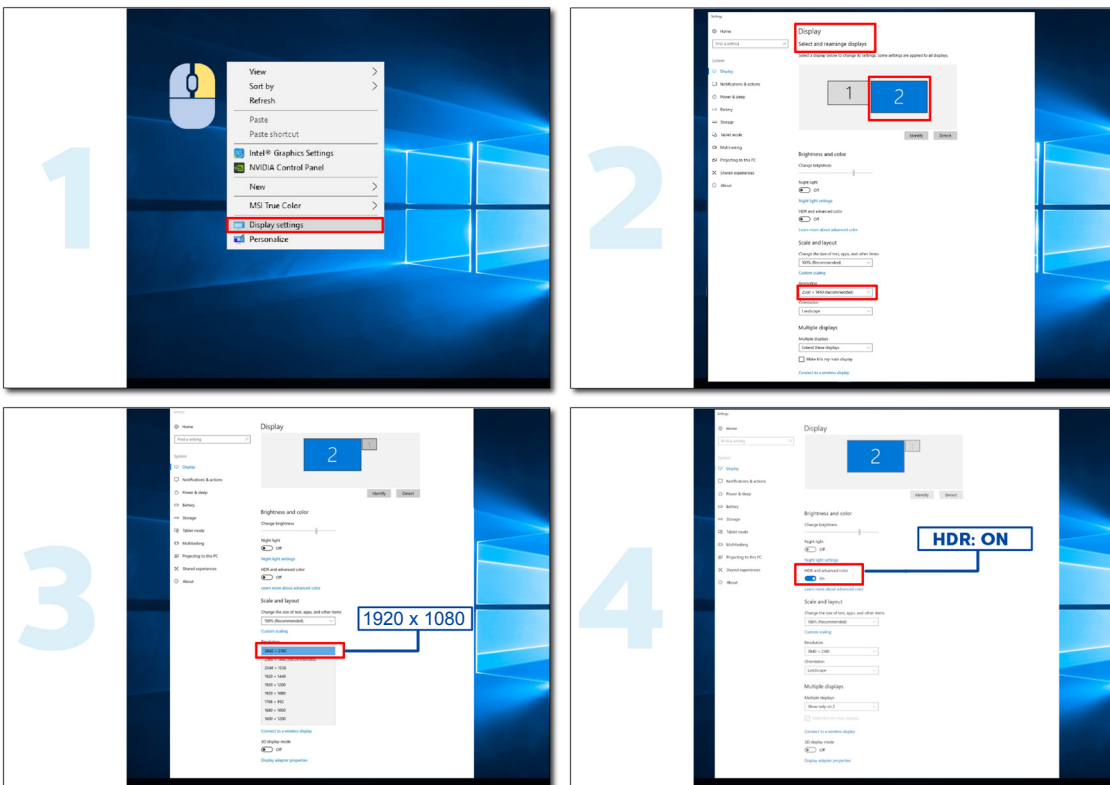

Adjusting

Hotkeys

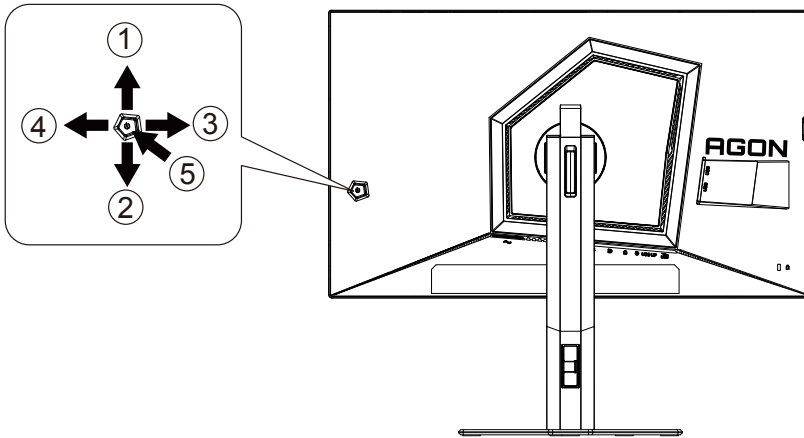

1	Source/Up
2	Down
3	Game Mode/Left
4	Right
5	Power/Menu/Enter

Power/Menu/Enter

Press the Power button to turn on the monitor.

When there is no OSD, Press to display the OSD or confirm the selection. Press about 2 seconds to turn off the monitor.

Game Mode/Left

When there is no OSD, press "Left" key to open game mode function, then press "Left" or "Right" key to select game mode (FPS1,FPS2,FPS3,RTS, Racing, Gamer 1, Gamer 2 or Gamer 3) basing on the different game types.

Source/Up

When the OSD is closed, press Source/Auto/Up button will be Source hot key function.

Quick Switch

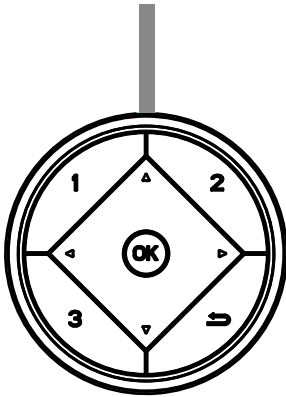

◀:

When there is no OSD, press the ◀ button to open game mode function, then press ◀ or ▶ key to select game mode (FPS, RTS, Racing, Gamer 1, Gamer 2 or Gamer 3) basing on the different game types.

▶:

When there is no OSD, press "Right" key to active Light FX function.

Menu/OK:

When there is no OSD, Press to display the OSD or confirm the selection.

▲:

When the OSD is closed, press ▲ button will be Source hot key function.

▼:

When there is no OSD, press Dial Point button to show / hide Dial Point.

1:

Press the 1 button to select Gamer 1 mode

2:

Press the 2 button to select Gamer 2 mode

3:

Press the 3 button to select Gamer 3 mode



Press to exit OSD.

OSD Key Guide (Menu)



Enter : Use Enter key to enter the next OSD level
Move : Use Left / Up / Down key to move OSD selection
Exit : Use Right key to exit OSD

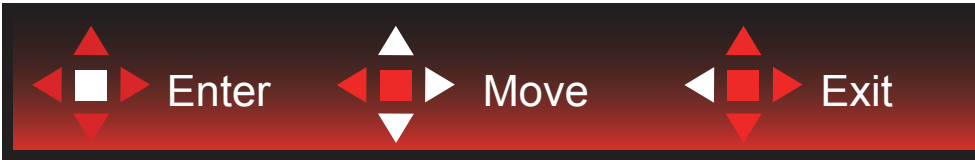

Enter : Use Enter key to enter the next OSD level
Move : Use Right / Up / Down key to move OSD selection
Exit : Use Left key to exit OSD



Enter : Use Enter key to enter the next OSD level
Move : Use Up / Down key to move OSD selection
Exit : Use Left key to exit OSD

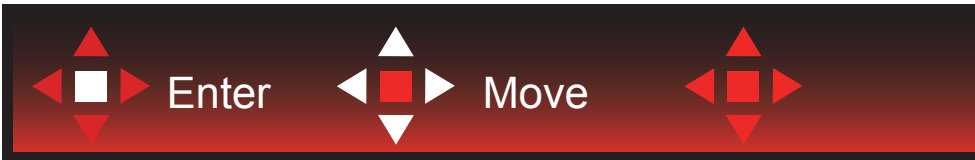

Move : Use Left / Right / Up / Down Key to move OSD selection



Exit : Use Left key to exit OSD to previous OSD level
Enter : Use Right key to enter next OSD level
Select : Use Up / Down key to move OSD selection



Enter : Use Enter key to apply the OSD setting and back to previous OSD level
Select : Use Down key to adjust OSD setting



Select : Use Up / Down key to adjust OSD setting



Enter : Use Enter key to exit OSD to previous OSD level
Select : Use Left / Right key to adjust OSD setting

OSD Setting

Basic and simple instruction on the control keys.

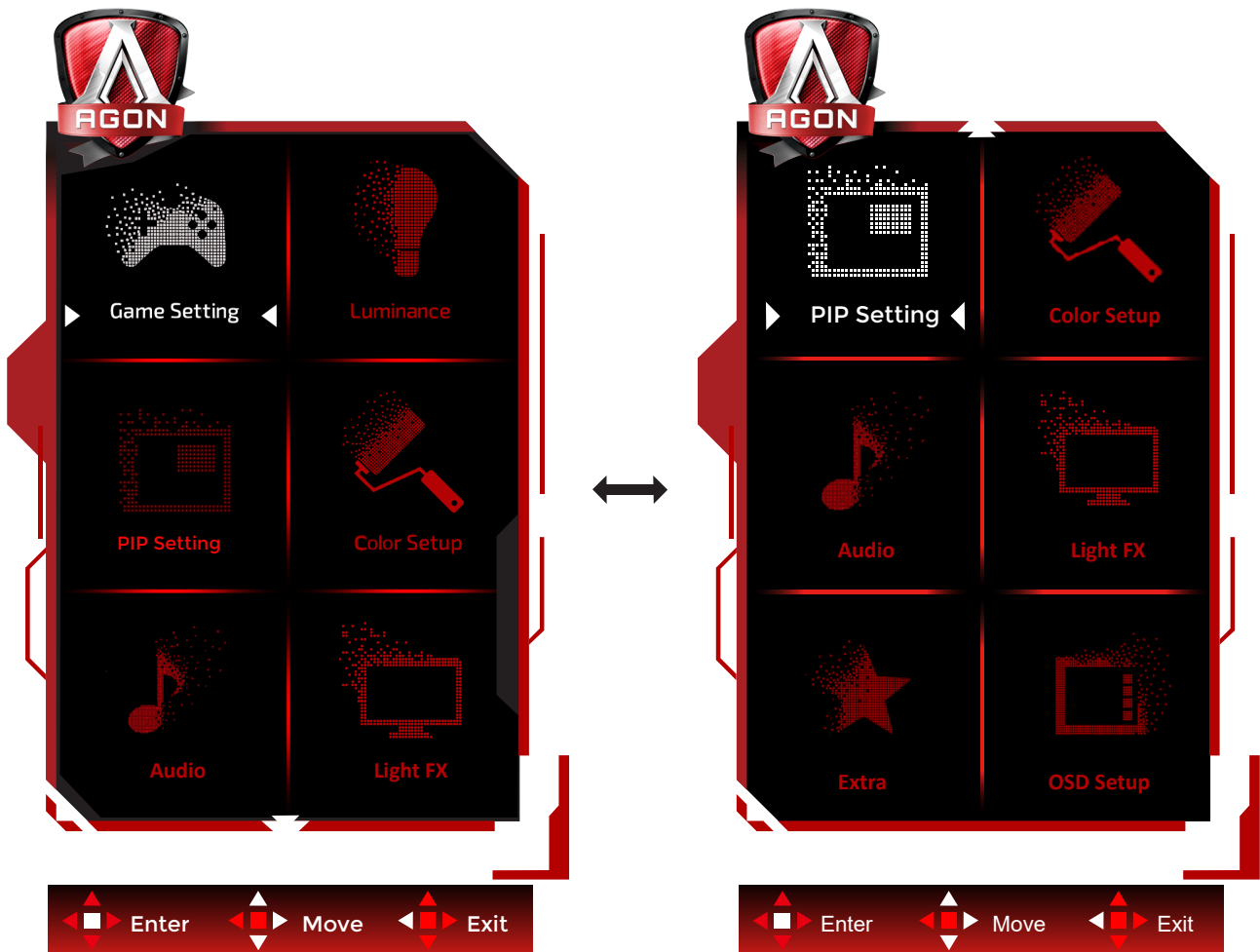

- 1). Press the MENU-button to activate the OSD window.
- 2). Follow Key Guide to move or select (adjust) OSD settings
- 3). OSD Lock/Unlock Function: To lock or unlock the OSD, press and hold the Down-button for 10s while OSD function is not active.

Notes:

- 1). If the product has only one signal input, the item of "Input Select" is disable to adjust.
- 2). ECO modes (except Standard mode) and DCR, for these two states that only one state can exist.

Game Setting



	Game Mode	FPS1	For playing FPS1/FPS2/FPS3 (First Person Shooters) games. Improves dark theme black level details.
		FPS2	
		FPS3	
		RTS	For playing RTS (Real Time Strategy). Improves the image quality.
		Racing	For playing Racing games, Provides fastest response time and high color saturation.
		Gamer 1	User's preference settings saved as Gamer 1.
		Gamer 2	User's preference settings saved as Gamer 2.
		Gamer 3	User's preference settings saved as Gamer 3.
		Off	No optimization by Game Mode.
	Shadow Control	0-20	Shadow Control Default is 0, then end-user can adjust from 0 to 20 or 0 to increase contrast for clear picture. 1. If picture is too dark to be saw the detail clearly, adjusting from 0 to 20 for clear picture. 2. If picture is too white to be saw the detail clearly, adjusting from 20 to 0 for clear picture.
Game Color	0-20	Game Color will provide 0-20 level for adjusting saturation to get better picture.	

Sniper Scope	Off / 1.0 / 1.5 / 2.0	Zoom in locally to make it easier to target when shooting.
MBR	0-20	Adjust the Motion Blur Reduction.
MBR Sync	On / Off	Disable or Enable MBR Sync((Motion Blur Remove). Note: The MBR function can be adjusted when Adaptive-Sync is turned off, and the refresh rate ≥ 75 Hz.
Adaptive-Sync	On / Off	Disable or Enable Adaptive-Sync.
Overdrive	Weak / Medium / Strong / Boost / Off	Adjust the response time.
Low Input lag	On / Off	Turn off frame buffer to decrease input lag
QuickSwitch LED	On / Off	Disable or Enable QuickSwitch LED
Frame Counter	Off / Right-Up / Right-Down / Left-Down / Left-Up	Display V frequency on the corner selected (Frame counter feature only works with AMD graphic card.)
Over Clock	On / Off	Disable or Enable Over Clock

Note:

1. When "HDR Mode" under "Brightness" is set to non-off, "Shadow Control" and "Game Color" can't be adjusted.
2. When "HDR" under "Brightness" is set to non-off, "Game Mode", "Shadow Control", "Game Color", "MBR", "MBR Sync" and "Boost" under "Overdrive" can't be adjusted or selected.
3. When the "Color Gamut" under "Color Setup" is set to sRGB, the items "Shadow Control", "Game Color", can't be adjusted.

Luminance

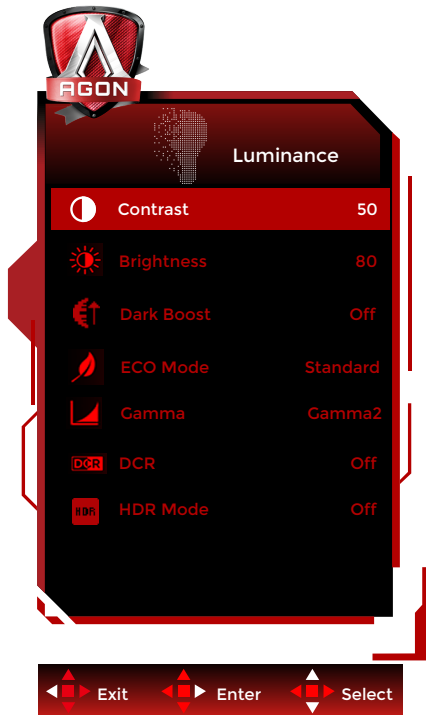

	Contrast	0-100	Contrast from Digital-register.
	Brightness	0-100	Backlight Adjustment
	Dark Boost	Off / Level 1 / Level 2 / Level 3	Enhance the screen details in the dark or bright area to adjust the brightness in the bright area and ensure that it is not oversaturated.
	Eco mode	Standard	Standard Mode
		Text	Text Mode
		Internet	Internet Mode
		Game	Game Mode
		Movie	Movie Mode
		Sports	Sports Mode
		Reading	Reading Mode
	Uniformity	Uniformity Mode	
	Gamma	Gamma1	Adjust to Gamma 1
		Gamma2	Adjust to Gamma 2
Gamma3		Adjust to Gamma 3	
DCR	Off / On	Disable/ Enable dynamic contrast ratio	
HDR	Off / DisplayHDR / HDR Picture / HDR Movie / HDR Game	Set the HDR profile according to your usage requirements. Note: When HDR content is detected, the HDR option will be displayed for adjustment.	
HDR Mode	Off / HDR Picture / HDR Movie / HDR Game	Optimized for the color and contrast of the picture, which simulates HDR effect. Note: When HDR content is not detected, the HDR mode option will be displayed for adjustment.	

Note:

1. When "HDR Mode" under "Brightness" is set to non-off, "Contrast", "Eco Mode", "Dark Boost" and "Gamma" can't be adjusted.
2. When "HDR" under "Brightness" is set to non-off, all items under "Luminance" can't be adjusted.

3. When “Color Gamut” under “Color Setup” is set to sRGB, “Contrast”, “Eco Mode”, “Dark Boost”, “HDR”, “HDR Mode” and “Gamma” can’t be adjusted.

PIP Setting

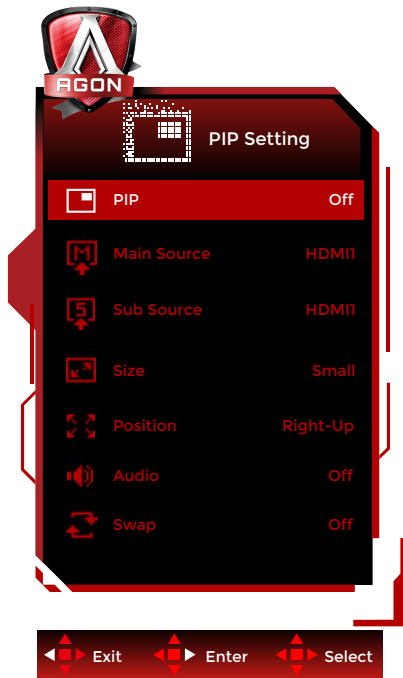

	PIP	Off / PIP / PBP	Disable or Enable PIP or PBP.
	Main Source		Select main screen source.
	Sub Source		Select sub screen source.
	Size	Small / Middle / Large	Select screen size.
	Position	Right-Up / Right-Down / Left-Down / Left-Up	Set the screen location.
	Audio	Off / On	Optimized for the color and contrast of the picture, which simulates HDR effect. Note: When HDR content is not detected, the HDR mode option will be displayed for adjustment.
	Swap	Off / On	Disable or enable zone dimming.

Note:

- 1). When “HDR” under “Brightness” is set to non-closed state, all items under “PIP” are not adjustable.
- 2). The OSD menu color adjustment is only valid for the main screen, so the main screen and the sub screen may have different colors.
- 3). When PBP/PIP is enabled, the compatibility of the main screen/sub-screen input source is shown in the following table:

PIP/PBP		Main source		
		HDMI1	HDMI2	DP
Sub sources	HDMI1	V	V	V
	HDMI2	V	V	V
	DP	V	V	V

Color Setup

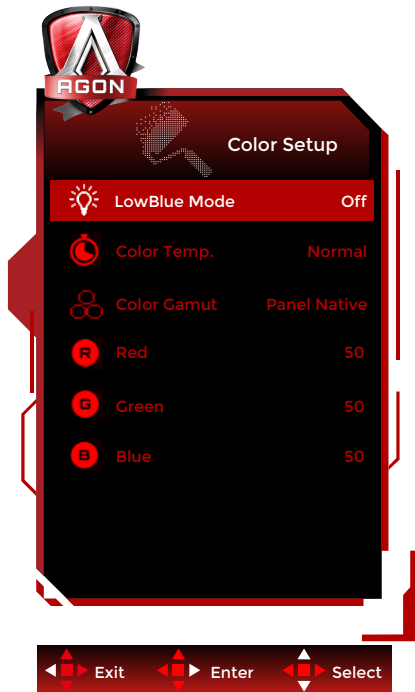

	LowBlue Mode	Off / Multimedia / Internet / Office / Reading	Decrease blue light wave by controlling color temperature.
	Color Temp.	Warm	Recall Warm Color Temperature from EEPROM.
		Normal	Recall Normal Color Temperature from EEPROM.
		Cool	Recall Cool Color Temperature from EEPROM.
		User	Red Gain from Digital-register
	Color Gamut		Green Gain Digital-register.
			Blue Gain from Digital-register
		Panel Native	Standard color space panel.
		sRGB	Recall sRGB Color Temperature from EEPROM.
	Red	0-100	Red gain from Digital-register.
Green	0-100	Green gain from Digital-register.	
Blue	0-100	Blue gain from Digital-register.	

Note:

When "HDR Mode" or "HDR" under "Luminance" is set to "non-off", all items under "Color Setup" cannot be adjusted.

When the "Color Gamut" under "Color Setup" is set to sRGB, all other items under "Color Setup" cannot be adjusted.

Audio

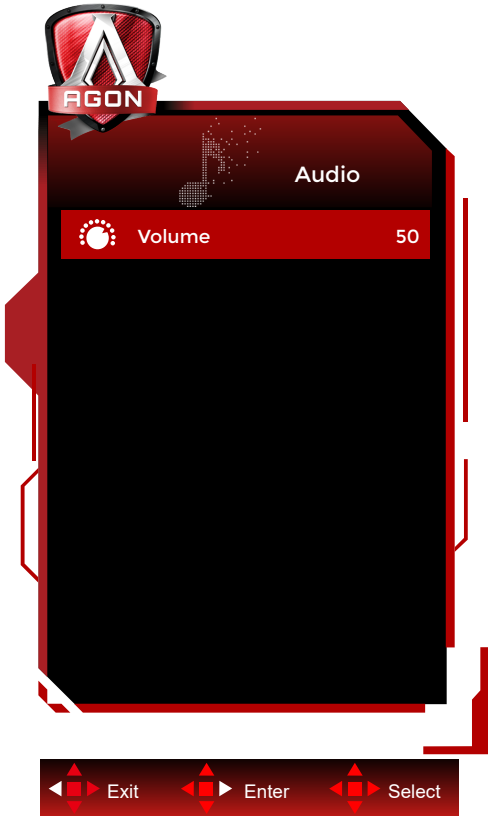

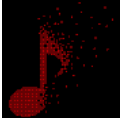
	Volume	0-100	Adjust volume setting
---	--------	-------	-----------------------

Light FX

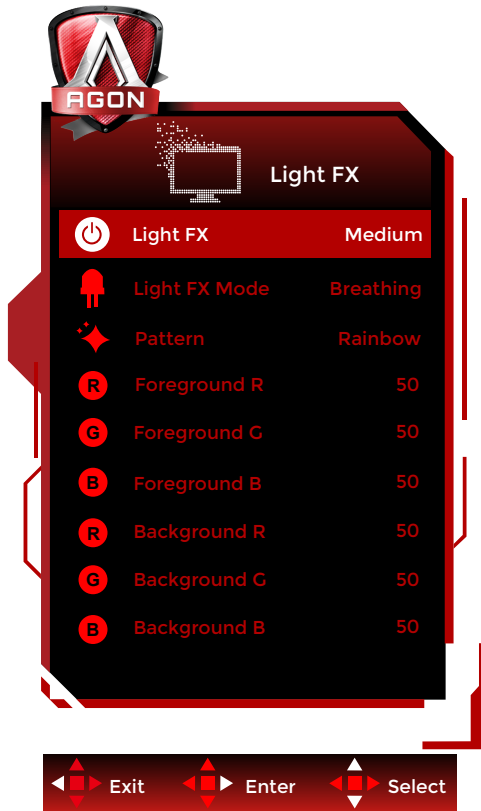

	Light FX	Off / Low / Medium / Strong	Select the intensity of Light FX.
	Light FX Mode	Audio1 / Audio2 / Static / Dark Point Sweep / Gradient Shift / Spread Fill / Drip Fill / Spreading Drip Fill / Breathing / Light Point Sweep / Zoom / Rainbow / Wave / Flashing / Demo	Select Light FX Mode
	Pattern	Red / Green / Blue / Rainbow / User Define	Select Light FX Pattern
	Foreground R	0-100	User can adjust Light FX foreground color, when Pattern setting to user define
	Foreground G		
	Foreground B		
	Background R	0-100	User can adjust Light FX background color, when Pattern setting to user define
Background G			
Background B			

Extra



	Input Select	Auto / HDMI1 / HDMI2 / DP	Select Input Signal Source
	Off timer	0-24hrs	Select DC off time
	Image Ratio	Wide / Aspect / 4:3 / 1:1 / 17"(4:3) / 19"(4:3) / 19"(5:4) / 19"W(16:10) / 21.5"W(16:9) / 22"W(16:10) / 23"W(16:9) / 23.6"W(16:9) / 24"W(16:9)	Select image ratio for display.
	DDC/CI	Yes or No	Turn ON/OFF DDC/CI Support
	Reset	Yes or No	Reset the menu to default

OSD Setup

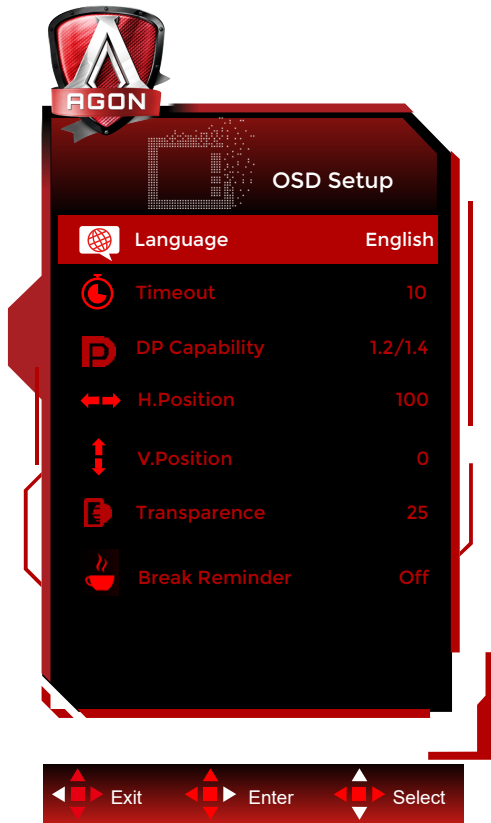

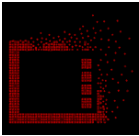
	Language		Select the OSD language
	Timeout	5-120	Adjust the OSD Timeout
	DP Capability	1.1 / 1.2 / 1.4	please be noted that only DP1.2/DP1.4 support Adaptive-Sync function
	H. Position	0-100	Adjust the horizontal position of OSD
	V. Position	0-100	Adjust the vertical position of OSD
	Transparence	0-100	Adjust the transparence of OSD
	Break Reminder	On / Off	Break reminder if the user continuously work for more than 1hrs

LED Indicator

Status	LED Color
Full Power Mode	White
Active-off Mode	Orange

Troubleshoot

Problem & Question	Possible Solutions
Power LED Is Not On	Make sure the power button is ON and the Power Cord is properly connected to a grounded power outlet and to the monitor.
No Images On The Screen	<ul style="list-style-type: none"> ● Is the power cord connected properly? Check the power cord connection and power supply. ● Is the video cable connected correctly?? (Connected using the VGA cable) Check the VGA cable connection. (Connected using the HDMI cable) Check the HDMI cable connection. (Connected using the DP cable) Check the DP cable connection. * VGA/HDMI/DP input is not available on every model. ● If the power is on, reboot the computer to see the initial screen (the login screen.) If the initial screen (the login screen) appears, boot the computer in the applicable mode (the safe mode for Windows 7/8/10) and then change the frequency of the video card. (Refer to the Setting the Optimal Resolution) If the initial screen (the login screen) does not appear, contact the Service Center or your dealer. ● Can you see "Input Not Supported" on the screen? You can see this message when the signal from the video card exceeds the maximum resolution and frequency that the monitor can handle properly. Adjust the maximum resolution and frequency that the monitor can handle properly. ● Make sure the AOC Monitor Drivers are installed.
Picture Is Fuzzy & Has Ghosting Shadowing Problem	Adjust the Contrast and Brightness Controls. Press hot-key (AUTO) to auto-adjust. Make sure you are not using an extension cable or switch box. We recommend plugging the monitor directly to the video card output connector on the back.
Picture Bounces, Flickers Or Wave Pattern Appears In The Picture	Move electrical devices that may cause electrical interference as far away from the monitor as possible. Use the maximum refresh rate your monitor is capable of at the resolution you are using.
Monitor Is Stuck In Active Off-Mode	The Computer Power Switch should be in the ON position. The Computer Video Card should be snugly fitted in its slot. Make sure the monitor's video cable is properly connected to the computer. Inspect the monitor's video cable and make sure no pin is bent. Make sure your computer is operational by hitting the CAPS LOCK key on the keyboard while observing the CAPS LOCK LED. The LED should either turn ON or OFF after hitting the CAPS LOCK key.
Missing One Of The Primary Colors (RED, GREEN, or BLUE)	Inspect the monitor's video cable and make sure that no pin is damaged. Make sure the monitor's video cable is properly connected to the computer.
Screen Image Is Not Centered Or Sized Properly	Adjust H-Position and V-Position or press hot-key (AUTO).
Picture Has Color Defects (White Does Not Look White)	Adjust RGB color or select desired color temperature.
Horizontal Or Vertical Disturbances On the screen	Use Windows 7/8/10 shut-down mode to adjust CLOCK and FOCUS. Press hot-key (AUTO) to auto-adjust.
Regulation & Service	Please refer to Regulation & Service Information which is in the CD manual or www.aoc.com (to find the model you purchase in your country and to find Regulation & Service Information in Support page.)

Specification

General Specification

Panel	Model name	AG246FK		
	Driving system	TFT Color LCD		
	Viewable Image Size	61.3 cm diagonal		
	Pixel pitch	0.279mm(H) x 0.276mm(V)		
	Display Color	16.7M Colors		
Others	Horizontal scan range	30k~255kHz (HDMI)		
		30k~510kHz (DP)		
	Horizontal scan Size(Maximum)	535.68mm		
	Vertical scan range	60~240Hz(HDMI)		
		60~540Hz(DP)		
	Vertical Scan Size(Maximum)	298.08mm		
	Optimal preset resolution	1920x1080@60Hz		
	Max resolution	1920x1080@240Hz (HDMI)		
		1920x1080@540Hz ^[1] (DP)		
	Plug & Play	VESA DDC2B/CI		
Power Source	100-240V~ 50/60Hz 1.5A			
Power Consumption	Typical (default brightness and contrast)	30W		
	Max. (Brightness = 100, contrast =100)	≤80W		
	Standby mode	≤0.5W		
Physical Characteristics	Connector Type	HDMIx2/DP/USBx4/USB UP/Earphone		
	Signal Cable Type	Detachable		
Environmental	Temperature	Operating	0°C ~ 40°C	
		Non-Operating	-25°C ~ 55°C	
	Humidity	Operating	10% ~ 85% (non-condensing)	
		Non-Operating	5% ~ 93% (non-condensing)	
	Altitude	Operating	0m ~ 5000m (0ft ~ 16404ft)	
		Non-Operating	0m ~ 12192m (0ft ~ 40000ft)	

Note:

[1] : If you want to experience FHD@540Hz, upgrade your operating system to Windows11 and update to the latest version. Versions released before November 1, 2023 do not support FHD@540Hz (up to 500Hz).



Preset Display Modes

STANDARD	RESOLUTION (+/-1Hz)	HORIZONTAL FREQUENCY(kHz)	VERTICAL FREQUENCY(Hz)
VGA	640x480@60Hz	31.469	59.94
VGA	640x480@67Hz	35	66.667
VGA	640x480@72Hz	37.861	72.809
VGA	640x480@75Hz	37.5	75
VGA	640x480@100Hz	51.08	99.769
VGA	640x480@120Hz	61.91	119.518
DOS MODE	720x400@70Hz	31.469	70.087
DOS MODE	720x480@60Hz	29.855	59.71
SD	720x576@50Hz	31.25	50
SVGA	800x600@56Hz	35.156	56.25
SVGA	800x600@60Hz	37.879	60.317
SVGA	800x600@72Hz	48.077	72.188
SVGA	800x600@75Hz	46.875	75
SVGA	800x600@100Hz	63.684	99.662
SVGA	800x600@120Hz	76.302	119.97
SVGA	832x624@75Hz	49.725	74.551
XGA	1024x768@60Hz	48.363	60.004
XGA	1024x768@70Hz	56.476	70.069
XGA	1024x768@75Hz	60.023	75.029
XGA	1024x768@100Hz	81.577	99.972
XGA	1024x768@120Hz	97.551	119.989
SXGA	1280x1024@60Hz	63.981	60.02
SXGA	1280x1024@75Hz	79.975	75.025
Full HD	1920x1080@60Hz	67.5	60
Full HD	1920x1080@120Hz	135	120
Full HD	1920x1080@144Hz	161.999	144
Full HD	1920x1080@240Hz	274.519	240
Full HD (DP)	1920x1080@300Hz	366.3	300
Full HD (DP)	1920x1080@360Hz	403.56	360
Full HD (DP)	1920x1080@480Hz	538.081	480
Full HD (DP)	1920x1080@500Hz	560.5	500
Full HD (DP)	1920x1080@540Hz	605.34	540

Note: According to the VESA standard, there may be a certain error (+/-1Hz) when calculating the refresh rate (field frequency) of different operating systems and graphics cards. In order to improve compatibility, the nominal refresh rate of this product has been rounded off. Please refer to the actual product.

Pin Assignments



19-Pin Color Display Signal Cable

Pin No.	Signal Name	Pin No.	Signal Name	Pin No.	Signal Name
1.	TMDS Data 2+	9.	TMDS Data 0-	17.	DDC/CEC Ground
2.	TMDS Data 2 Shield	10.	TMDS Clock +	18.	+5V Power
3.	TMDS Data 2-	11.	TMDS Clock Shield	19.	Hot Plug Detect
4.	TMDS Data 1+	12.	TMDS Clock-		
5.	TMDS Data 1Shield	13.	CEC		
6.	TMDS Data 1-	14.	Reserved (N.C. on device)		
7.	TMDS Data 0+	15.	SCL		
8.	TMDS Data 0 Shield	16.	SDA		

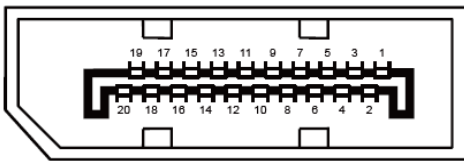

20-Pin Color Display Signal Cable

Pin No.	Signal Name	Pin No.	Signal Name
1	ML_Lane 3 (n)	11	GND
2	GND	12	ML_Lane 0 (p)
3	ML_Lane 3 (p)	13	CONFIG1
4	ML_Lane 2 (n)	14	CONFIG2
5	GND	15	AUX_CH(p)
6	ML_Lane 2 (p)	16	GND
7	ML_Lane 1 (n)	17	AUX_CH(n)
8	GND	18	Hot Plug Detect
9	ML_Lane 1 (p)	19	Return DP_PWR
10	ML_Lane 0 (n)	20	DP_PWR

Plug and Play

Plug & Play DDC2B Feature

This monitor is equipped with VESA DDC2B capabilities according to the VESA DDC STANDARD. It allows the monitor to inform the host system of its identity and, depending on the level of DDC used, communicate additional information about its display capabilities.

The DDC2B is a bi-directional data channel based on the I2C protocol. The host can request EDID information over the DDC2B channel.