



Questo manuale d'istruzione è fornito da trovaprezzi.it. Scopri tutte le offerte per [Asus MB16AHV](#) o cerca il tuo prodotto tra le [migliori offerte di Monitor](#)



Questo manuale d'istruzione è fornito da trovaprezzi.it. Scopri tutte le offerte per [Asus MB16AHV](#) o cerca il tuo prodotto tra le [migliori offerte di Monitor](#)

# **ASUS<sup>®</sup>**

# **MB16AHV**

# **Portable USB Monitor**

# **Hybrid Signal Solution**

## *User Guide*

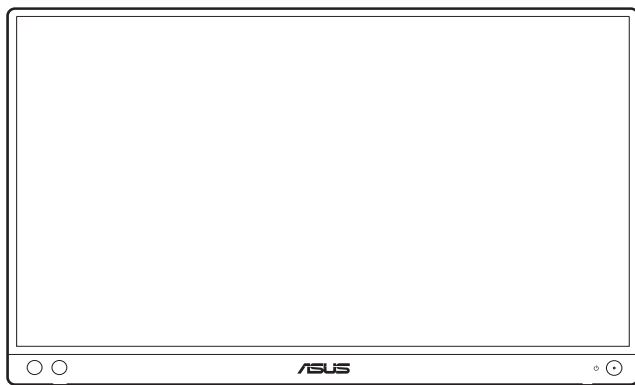

First Edition  
August 2023

**Copyright © 2023 ASUSTeK COMPUTER INC. All Rights Reserved.**

No part of this manual, including the products and software described in it, may be reproduced, transmitted, transcribed, stored in a retrieval system, or translated into any language in any form or by any means, except documentation kept by the purchaser for backup purposes, without the express written permission of ASUSTeK COMPUTER INC. ("ASUS").

Product warranty or service will not be extended if: (1) the product is repaired, modified or altered, unless such repair, modification or alteration is authorized in writing by ASUS; or (2) the serial number of the product is defaced or missing.

ASUS PROVIDES THIS MANUAL "AS IS" WITHOUT WARRANTY OF ANY KIND, EITHER EXPRESS OR IMPLIED, INCLUDING BUT NOT LIMITED TO THE IMPLIED WARRANTIES OR CONDITIONS OF MERCHANTABILITY OR FITNESS FOR A PARTICULAR PURPOSE. IN NO EVENT SHALL ASUS, ITS DIRECTORS, OFFICERS, EMPLOYEES OR AGENTS BE LIABLE FOR ANY INDIRECT, SPECIAL, INCIDENTAL, OR CONSEQUENTIAL DAMAGES (INCLUDING DAMAGES FOR LOSS OF PROFITS, LOSS OF BUSINESS, LOSS OF USE OR DATA, INTERRUPTION OF BUSINESS AND THE LIKE), EVEN IF ASUS HAS BEEN ADVISED OF THE POSSIBILITY OF SUCH DAMAGES ARISING FROM ANY DEFECT OR ERROR IN THIS MANUAL OR PRODUCT.

SPECIFICATIONS AND INFORMATION CONTAINED IN THIS MANUAL ARE FURNISHED FOR INFORMATIONAL USE ONLY, AND ARE SUBJECT TO CHANGE AT ANY TIME WITHOUT NOTICE, AND SHOULD NOT BE CONSTRUED AS A COMMITMENT BY ASUS. ASUS ASSUMES NO RESPONSIBILITY OR LIABILITY FOR ANY ERRORS OR INACCURACIES THAT MAY APPEAR IN THIS MANUAL, INCLUDING THE PRODUCTS AND SOFTWARE DESCRIBED IN IT.

Products and corporate names appearing in this manual may or may not be registered trademarks or copyrights of their respective companies, and are used only for identification or explanation and to the owners' benefit, without intent to infringe.

# Contents

Contents .....	iii
Notices .....	iv
Safety information .....	vi
Care & Cleaning .....	vii
Takeback Services .....	viii
Product information for EU energy label .....	viii
<b>Chapter 1: Product introduction</b>	
1.1 Welcome! .....	1-1
1.2 Package contents .....	1-1
1.3 Monitor introduction .....	1-2
1.3.1 Front/Side view .....	1-2
<b>Chapter 2: Setup</b>	
2.1 Monitor standing positions .....	2-1
2.2 Adjusting the monitor .....	2-1
2.3 Connect the USB monitor with system .....	2-2
2.4 Turning on the monitor .....	2-3
2.5 Announcements .....	2-4
<b>Chapter 3: General instructions</b>	
3.1 OSD (On-Screen Display) menu .....	3-1
3.1.1 How to reconfigure .....	3-1
3.1.2 OSD function introduction .....	3-2
3.2 Specifications summary .....	3-8
3.3 Outline dimensions .....	3-9
3.4 Troubleshooting (FAQ) .....	3-10
3.5 Supported operating modes .....	3-12

# Notices

## Federal Communications Commission Statement

This device complies with Part 15 of the FCC Rules. Operation is subject to the following two conditions:

- This device may not cause harmful interference, and
- This device must accept any interference received including interference that may cause undesired operation.

This equipment has been tested and found to comply with the limits for a Class B digital device, pursuant to Part 15 of the FCC Rules. These limits are designed to provide reasonable protection against harmful interference in a residential installation. This equipment generates, uses and can radiate radio frequency energy and, if not installed and used in accordance with the instructions, may cause harmful interference to radio communications. However, there is no guarantee that interference will not occur in a particular installation. If this equipment does cause harmful interference to radio or television reception, which can be determined by turning the equipment off and on, the user is encouraged to try to correct the interference by one or more of the following measures:

- Reorient or relocate the receiving antenna.
- Increase the separation between the equipment and receiver.
- Connect the equipment into an outlet on a circuit different from that to which the receiver is connected.
- Consult the dealer or an experienced radio/TV technician for help.



---

The use of shielded cables for connection of the monitor to the graphics card is required to assure compliance with FCC regulations. Changes or modifications to this unit not expressly approved by the party responsible for compliance could void the user's authority to operate this equipment.

---

## ENERGY STAR complied product



ENERGY STAR is a joint program of the U.S. Environmental Protection Agency and the U.S. Department of Energy helping us all save money and protect the environment through energy efficient products and practices.

All ASUS products with the ENERGY STAR logo comply with the ENERGY STAR standard, and the power management feature is enabled by default. The monitor and computer are automatically set to sleep after 10 and 30 minutes of user inactivity. To wake your computer, click the mouse or press any key on the keyboard. Please visit <http://www.energystar.gov/powermanagement> for detail information on power management and its benefits to the environment. In addition, please visit <http://www.energystar.gov> for detail information on the ENERGY STAR joint program.



---

NOTE: Energy Star is NOT supported on FreeDOS and Linux-based operating system.

---

### **Canadian Department of Communications Statement**

This digital apparatus does not exceed the Class B limits for radio noise emissions from digital apparatus set out in the Radio Interference Regulations of the Canadian Department of Communications.

This class B digital apparatus complies with Canadian ICES-003.

This Class B digital apparatus meets all requirements of the Canadian Interference - Causing Equipment Regulations.

Cet appareil numérique de la classe B respecte toutes les exigences du Règlement sur le matériel brouiller du Canada.



## Safety information

- Before setting up the monitor, carefully read all the documentation that came with the package.
- To prevent fire or shock hazard, never expose the monitor to rain or moisture.
- Never try to open the monitor cabinet. The dangerous high voltages inside the monitor may result in serious physical injury.
- If the power supply is broken, do not try to fix it by yourself. Contact a qualified service technician or your retailer.
- Before using the product, make sure all cables are correctly connected and the power cables are not damaged. If you detect any damage, contact your dealer immediately.
- Slots and openings on the back or top of the cabinet are provided for ventilation. Do not block these slots. Never place this product near or over a radiator or heat source unless proper ventilation is provided.
- The monitor should be operated only from the type of power source indicated on the label. If you are not sure of the type of power supply to your home, consult your dealer or local power company.
- Use the appropriate power plug which complies with your local power standard.
- Do not overload power strips and extension cords. Overloading can result in fire or electric shock.
- Avoid dust, humidity, and temperature extremes. Do not place the monitor in any area where it may become wet. Place the monitor on a stable surface.
- Unplug the unit during a lightning storm or if it will not be used for a long period of time. This will protect the monitor from damage due to power surges.
- Never push objects or spill liquid of any kind into the slots on the monitor cabinet.
- To ensure satisfactory operation, use the monitor only with UL listed computers which have appropriate configured receptacles marked between 100-240V AC.
- If you encounter technical problems with the monitor, contact a qualified service technician or your retailer.
- Adjustment of the volume control as well as the equalizer to other settings than the center position may increase the ear-/headphones output voltage and therefore the sound pressure level.
- Ensure to connect the power cord to a socket-outlet with earthing connection.
- The supplied power adapter and/or power cable are designed to use with the product only. Do not use with other products.



This symbol of the crossed out wheeled bin indicates that the product (electrical, electronic equipment, and mercury-containing button cell battery) should not be placed in municipal waste. Please check local regulations for disposal of electronic products.

## AEEE yönetmeliğine uygundur

## Care & Cleaning

- Before you lift or reposition your monitor, it is better to disconnect the cables and power cord. Follow the correct lifting techniques when positioning the monitor. When lifting or carrying the monitor, grasp the edges of the monitor. Do not lift the display by the stand or the cord.
- Cleaning. Turn your monitor off and unplug the power cord. Clean the monitor surface with a lint-free, non-abrasive cloth. Stubborn stains may be removed with a cloth dampened with mild cleaner.
- Avoid using a cleaner containing alcohol or acetone. Use a cleaner intended for use with the monitor. Never spray cleaner directly on the screen, as it may drip inside the monitor and cause an electric shock.

### The following symptoms are normal with the monitor:

- You may find slightly uneven brightness on the screen depending on the desktop pattern you use.
- When the same image is displayed for hours, an afterimage of the previous screen may remain after switching the image. The screen will recover slowly or you can turn off the Power Switch for hours.
- When the screen becomes black or flashes, or cannot work anymore, contact your dealer or service center to fix it. Do not repair the screen by yourself!
- (For OLED models) Damage resulting from long-term static images displayed (also referred as “Image Sticking”) or improper use.
- (For OLED models) Defect of color accuracy shift resulting from display color decay accelerated by user’s behaviors.

### Conventions used in this guide



**WARNING:** Information to prevent injury to yourself when trying to complete a task.



**CAUTION:** Information to prevent damage to the components when trying to complete a task.



**IMPORTANT:** Information that you **MUST** follow to complete a task.



**NOTE:** Tips and additional information to aid in completing a task.

## Where to find more information

Refer to the following sources for additional information and for product and software updates.

### 1. ASUS websites

The ASUS websites worldwide provide updated information on ASUS hardware and software products. Refer to <http://www.asus.com>

### 2. Optional documentation

Your product package may include optional documentation that may have been added by your dealer. These documents are not part of the standard package.

## Takeback Services

ASUS recycling and takeback programs come from our commitment to the highest standards for protecting our environment. We believe in providing solutions for our customers to be able to responsibly recycle our products, batteries and other components as well as the packaging materials.

Please go to <http://csr.asus.com/english/Takeback.htm> for detail recycling information in different region.

## Product information for EU energy label



MB16AHV

## 1.1 Welcome!

Thank you for purchasing the ASUS® Portable USB Monitor!

The latest ASUS Portable USB Monitor provides great portability and simplicity to your daily life, enhancing both of your viewing experience and style.

## 1.2 Package contents

Check your package for the following items:

- ✓ Portable USB monitor
- ✓ Quick start guide
- ✓ Warranty card
- ✓ Power adapter
- ✓ USB Type-C to Type-C cable
- ✓ HDMI to mini HDMI adapter
- ✓ ZenScreen sleeve



---

If any of the above items is damaged or missing, contact your retailer immediately.

---



---

**IMPORTANT:** Use only the bundled power adapter and USB cable to charge your monitor. Using different power adapter and cable might bring potential damage to your device. For the best performance, please use inbox power adapter for MB16AHV.

---



---

**WARNING:** The adapter may become warm to hot while in use. **DO NOT** cover the adapter and keep it away from your body while it is connected to a power source. If your device becomes unusually hot, disconnect the USB cable from your device and send the device including the power adapter and USB cable to an ASUS qualified service personnel.

---



---

If you need to replace the power cord or the connection cable(s), please contact ASUS customer service.

---

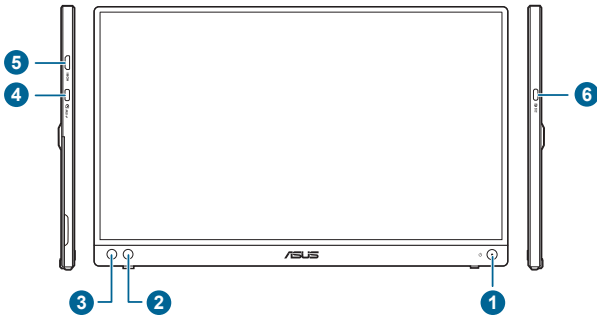

# 1.3 Monitor introduction

## 1.3.1 Front/Side view



1.  Power button/power indicator
  - Turns the monitor on/off.
  - The color definition of the power indicator is as the below table.

Status	Description
Blue	On
Amber	Standby mode
Off	Off

2.  Shortcut button:
  - Default: Blue light filter hotkey. Adjusts the energy level of blue light emitted from LED backlight.
  - To change the hotkey function, go to the Shortcut > Shortcut menu.
3.  Menu button:
  - Press this button to enter the OSD menu.
  - Toggles the Key Lock function between on and off with a long press for 5 seconds.
4. USB Type-C port:
  - This port is for connection with a DP-Alt mode compatible device and also be able to connect the power adapter. If the other Type-C port is connected with the power adapter, this port can provide 15W power output.
5. Mini HDMI port:
  - This port is for connection with an HDMI compatible device.
6. USB Type-C port:
  - This port is for connection with a DP-Alt mode compatible device and also be able to connect the power adapter.

## 2.1 Monitor standing positions

You can stand up the monitor in the following positions.

**A**

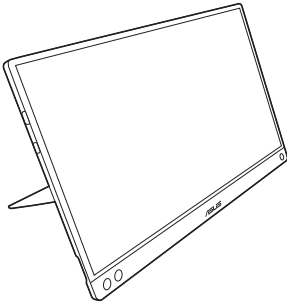

**B**

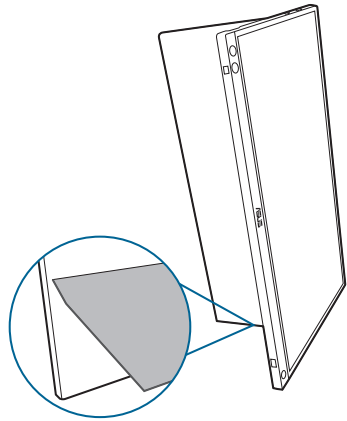

## 2.2 Adjusting the monitor

- For optimal viewing, we recommend that you look at the full face of the monitor, then adjust the monitor to the angle that is most comfortable for you.
- Hold the stand to prevent the monitor from falling when you change its angle.
- You can adjust the monitor's angle at  $15^{\circ} \sim 35^{\circ}$ .

(Tilt)

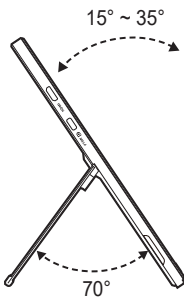

## 2.3 Connect the USB monitor with system

A

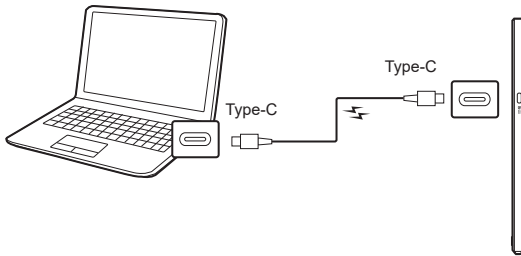

or

B

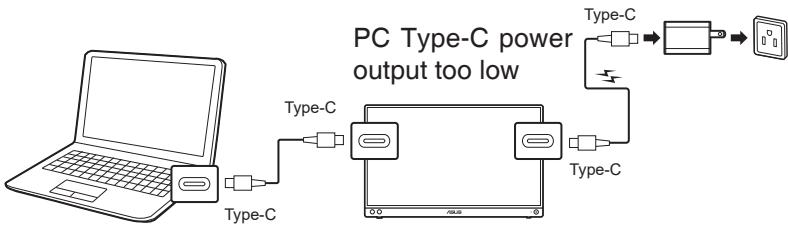

C

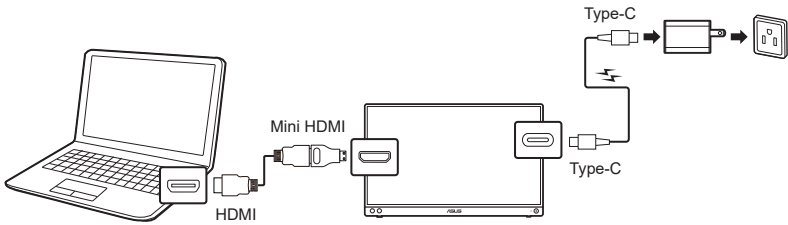



When connecting with the system by HDMI port, please connect inbox adapter to power up the monitor.



The USB Type-C video signal can only work when your PC/Laptop supports "DP Alt Mode", please contact the PC/Laptop manufacturer to confirm if the function is supported.

## 2.4 Turning on the monitor

Press the power button . See page 1-2 for the location of the power button. The power indicator  lights up in blue to show that the monitor is ON.

## 2.5 Announcements

As this product includes magnet in the structure, there could be potential risk to cause the damage of computer hard disc and objects that are sensitive to magnet.



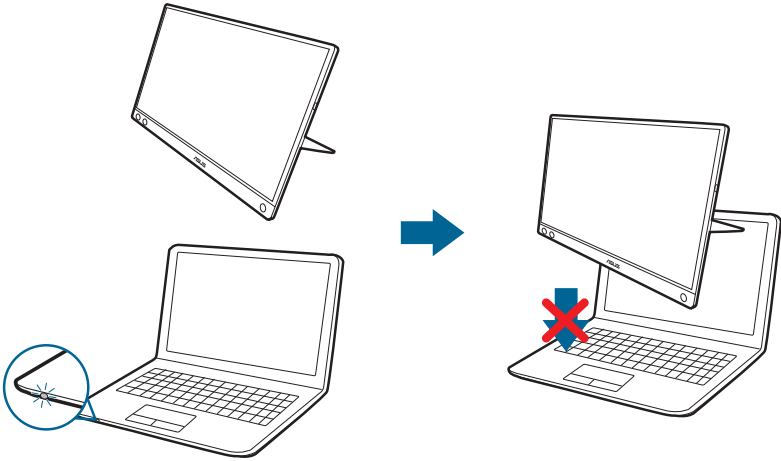



Please ensure not to stack the product with the computer when computer is in use (power on or standby mode) otherwise the hard drive could possibly be influenced by the result of permanent data missing or the computer display could be switched off due to computer auto protection mechanism. When placing this product together with the computer in a bag, you must have the computer power off to avoid possible hard drive damage.

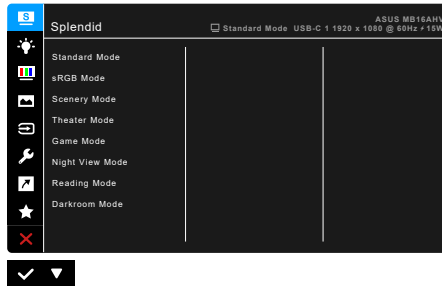

## 3.1 OSD (On-Screen Display) menu

### 3.1.1 How to reconfigure



1. Press the  Menu button to activate the OSD menu.
2. Press the  button to toggle between options in the Menu. As you move from one icon to another, the option name is highlighted.
3. To select the highlighted item on the menu press the  button.
4. Press the  button to select the desired parameter.
5. Press the  button to enter the slide bar and then use the  button, according to the indicators on the menu, to make your changes.
6. Select the  button to return to previous menu or to accept and return to previous menu.

### 3.1.2 OSD function introduction

#### 1. Splendid

This function contains 8 sub-functions you can select for your preference. Each mode has the Reset selection, allowing you to maintain your setting or return to the preset mode.



- **Standard Mode:** Best choice for document editing with Splendid Video Enhancement.



---

Standard Mode meets Energy Star® requirements.

---

- **sRGB Mode:** best choice for viewing photos and graphics from PCs.
- **Scenery Mode:** Best choice for scenery photo display with Splendid Video Enhancement.
- **Theater Mode:** Best choice for movies with Splendid Video Enhancement.
- **Game Mode:** Best choice for game playing with Splendid Video Enhancement.
- **Night View Mode:** Best choice for dark-scene games or movies with Splendid Video Enhancement.
- **Reading Mode:** This is the best choice for book reading.
- **Darkroom Mode:** This is the best choice for a weak ambient light environment.



- In the Standard mode, the following function(s) are not user-configurable: Saturation, Skin Tone, Sharpness, ASCR.
  - In the sRGB mode, the following function(s) are not user-configurable: Brightness, Contrast, Saturation, Color Temp., Skin Tone, Sharpness, ASCR.
  - In the Reading mode, the following function(s) are not user-configurable: Contrast, Saturation, Color Temp., Skin Tone, Sharpness, ASCR.
-

## 2. Blue Light Filter

In this function, you can adjust the blue light filter level.

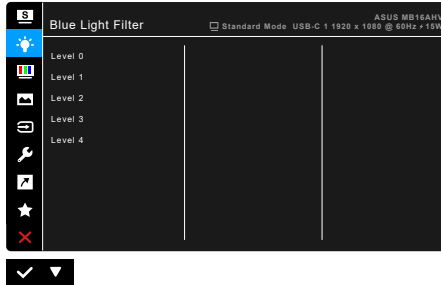

- **Level 0:** No change.
- **Level 1~4:** The higher the level, the less blue light is scattered. When Blue Light Filter is activated, the default settings of Standard Mode will be automatically imported. Between Level 1 to Level 3, the Brightness function is user-configurable. Level 4 is optimized setting. It is in compliance with TUV Low Blue Light Certification. The Brightness function is not user-configurable.



---

Please refer to the following to alleviate eye strains:

- Users should take some time away from the display if working for long hours. It is advised to take short breaks (at least 5 mins) after around 1 hour of continuous working at the computer. Taking short and frequent breaks is more effective than a single longer break.
  - To minimize eye strain and dryness in your eyes, users should rest the eye periodically by focusing on objects that are far away.
  - Eye exercises can help to reduce eye strain. Repeat these exercises often. If eye strain continues please consult a physician. Eye exercises: (1) Repeating look up and down (2) Slowly roll your eyes (3) Move your eyes diagonal.
  - High energy blue light may lead to eye strain and AMD (Age-Related Macular Degeneration). Blue light Filter to reduce 70% (max.) harmful blue light to avoiding CVS (Computer Vision Syndrome).
-

### 3. Color

Set a desired color setting from this menu.

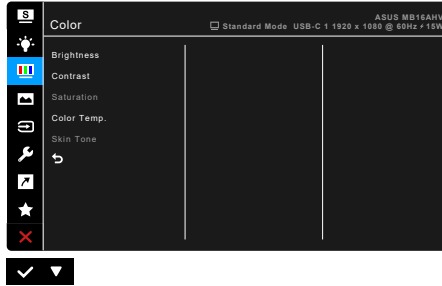

- **Brightness:** The adjusting range is from 0 to 100.
- **Contrast:** The adjusting range is from 0 to 100.
- **Saturation:** The adjusting range is from 0 to 100.
- **Color Temp.:** Contains 4 modes including Cool, Normal, Warm and User Mode.
- **Skin Tone:** Contains three color modes including Reddish, Natural, and Yellowish.

### 4. Image

Set the image related setting from this menu.



- **Sharpness:** The adjusting range is from 0 to 100.
- **Trace Free:** Adjusts the response time of the monitor.
- **Aspect Control:** Adjusts the aspect ratio to Full or 4:3.



---

4:3 is only available when input source is in 4:3 format.

---

- **VividPixel:** Enhances the outline of the displayed picture and generates high-quality images on screen.

- **ASCR:** Turns on/off the ASCR (ASUS Smart Contrast Ratio) function.

## 5. Input Select

In this function, you can select your desired input source or decide if you want the monitor to automatically searches for input sources.



## 6. System Setup

Allows you to adjust the system.

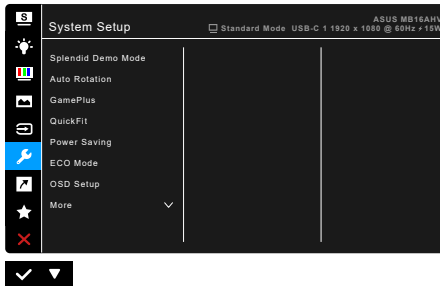

- **Splendid Demo Mode:** Splits the screen into two for Splendid modes comparison. (Scenery mode only)
- **Auto Rotation:** To enable or disable automatic image rotation. Note that this function is only working under Windows OS after installing the DisplayWidget Center software.
- **GamePlus:** The GamePlus function provides a toolkit and creates a better gaming environment for users when playing different types of games.
  - \* **Crosshair:** The crosshair overlays with 6 different crosshair options letting you choose the one that best suits the game you're playing.
  - \* **Timer:** You can position the timer on the upper left corner of the display so you can keep track of the gaming time.

- \* **Display Alignment:** Display Alignment displays alignment lines on 4 sides of the screen, serving as an easy and handy tool for you to line up multiple monitors perfectly.
- **QuickFit:** You can have a preview of the document or photo layout directly on screen without printing test copies.
  - \* **Alignment:** This facilitates designers and users to organize content and layout on one page and achieve a consistent look and feel.

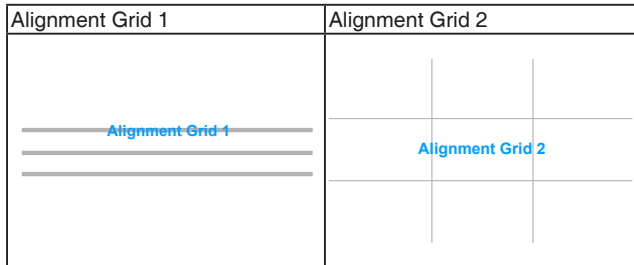

- \* **Photo:** The various real photo sizes displayed provides photographers and other users to accurately view and edit their photos in real size on the screen.

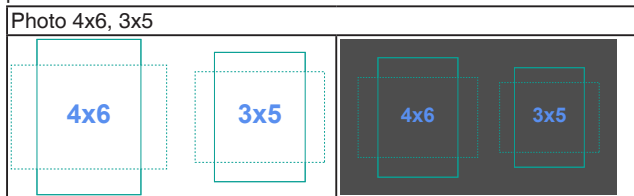

- **Power Saving:** Reduces power consumption. The default setting is “Deep Level”. When “Deep Level” is selected, the maximum brightness value is fixed and Splendid mode is fixed at “Standard Mode”.
- **ECO Mode:** Reduces power consumption.
- **OSD Setup:**
  - \* Adjusts the OSD timeout from 10 to 120 seconds.
  - \* Enables or disables the DDC/CI function.
  - \* Adjusts the OSD background from opaque to transparent.

- **Language:** There are 22 languages for your selection, including English, French, German, Italian, Spanish, Dutch, Portuguese, Russian, Czech, Croatian, Polish, Romanian, Hungarian, Turkish, Simplified Chinese, Traditional Chinese, Japanese, Korean, Thai, Indonesian, Persian, Ukrainian.
- **Key Lock:** To disable all function keys. Press and hold the MENU button for over five seconds to cancel the key lock function.
- **Information:** Shows the monitor information.
- **Power Indicator:** Turns the power LED indicator on/off.
- **Power Key Lock:** Enables or disables the power key.
- **All Reset:** “Yes” allows you to restore the default settings.

## 7. Shortcut

Defines the function for the Shortcut button.



- **Shortcut:** Selects a function for the Shortcut button.



When a certain function is selected or activated, your shortcut key may not support. Available function choices for shortcut: Blue Light Filter, Splendid, Brightness, Contrast, Auto Rotation, Color Temp., QuickFit, GamePlus.

## 8. MyFavorite

Loads/Saves all settings on the monitor.

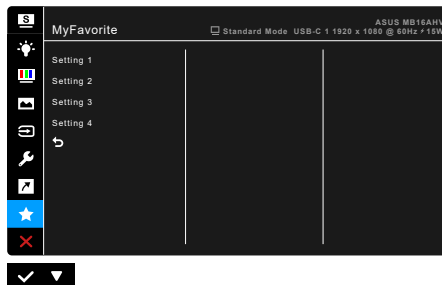

## 3.2 Specifications summary

<b>Panel Type</b>	TFT LCD
<b>Panel size</b>	15.6" (16:9, 39.49 cm) wide screen
<b>Max. Resolution</b>	1920 x 1080
<b>Pixel pitch</b>	0.179 mm
<b>Brightness (Typ.)</b>	250 cd/m <sup>2</sup>
<b>Contrast Ratio (Typ.)</b>	800:1
<b>Viewing angle (H/V) CR&gt;10</b>	178°/178°
<b>Display colors</b>	262 K
<b>Response time</b>	≤ 5 ms
<b>Splendid selection</b>	8 video preset modes
<b>Auto adjustment</b>	No
<b>Color temperature selection</b>	4 color temperatures
<b>Analog input</b>	No
<b>Digital input</b>	DisplayPort™ Alt Mode for USB Type-C, mini HDMI
<b>1/4" Tripod Socket</b>	Yes
<b>Antibacterial treatment</b>	Yes
<b>Colors</b>	Black
<b>Power LED</b>	Blue (On)/Amber (Standby)
<b>Tilt</b>	15°~35°
<b>DC input voltage</b>	12.0V --- 2.5A, or 15.0V --- 2.0A, or 20.0V --- 1.5A
<b>Power consumption</b>	Power On: < 15 W** (Typ.), Standby: < 0.5 W (Typ.), Power Off: < 0.3 W
<b>Temperature (Operating)</b>	0°C~40°C
<b>Temperature (Non-operating)</b>	-20°C~+60°C
<b>Dimension (W x H x D)</b>	357.9 x 224.8 x 10.5 mm 450 x 297 x 114 mm (package)
<b>Weight (Esti.)</b>	0.91 kg (net); 2.12 kg (gross)
<b>Multi-languages</b>	22 languages (English, French, German, Italian, Spanish, Dutch, Portuguese, Russian, Czech, Croatian, Polish, Romanian, Hungarian, Turkish, Simplified Chinese, Traditional Chinese, Japanese, Korean, Thai, Indonesian, Persian, Ukrainian)
<b>Accessories</b>	Quick start guide, warranty card, power adapter, USB Type-C to Type-C cable, HDMI to mini HDMI adapter, ZenScreen sleeve
<b>Compliance and Standards</b>	cTUVus, FCC, ICES-3, CB, CE, ErP, EU Energy, WEEE, UkrSEPRO, EAC(CU), CCC, CEL, BSMI, RCM, MEPS, VCCI, PC Recycle, J-MOSS, PSE, KC, ES 8.0, KCC, e-Standby, Vietnam Energy, RoHS, WHQL Windows 10/11, TUV Low Blue Light

\*Specifications are subject to change without notice.

\*\*Measuring a screen brightness of 200 nits without audio/USB/Card reader connection.

### 3.3 Outline dimensions

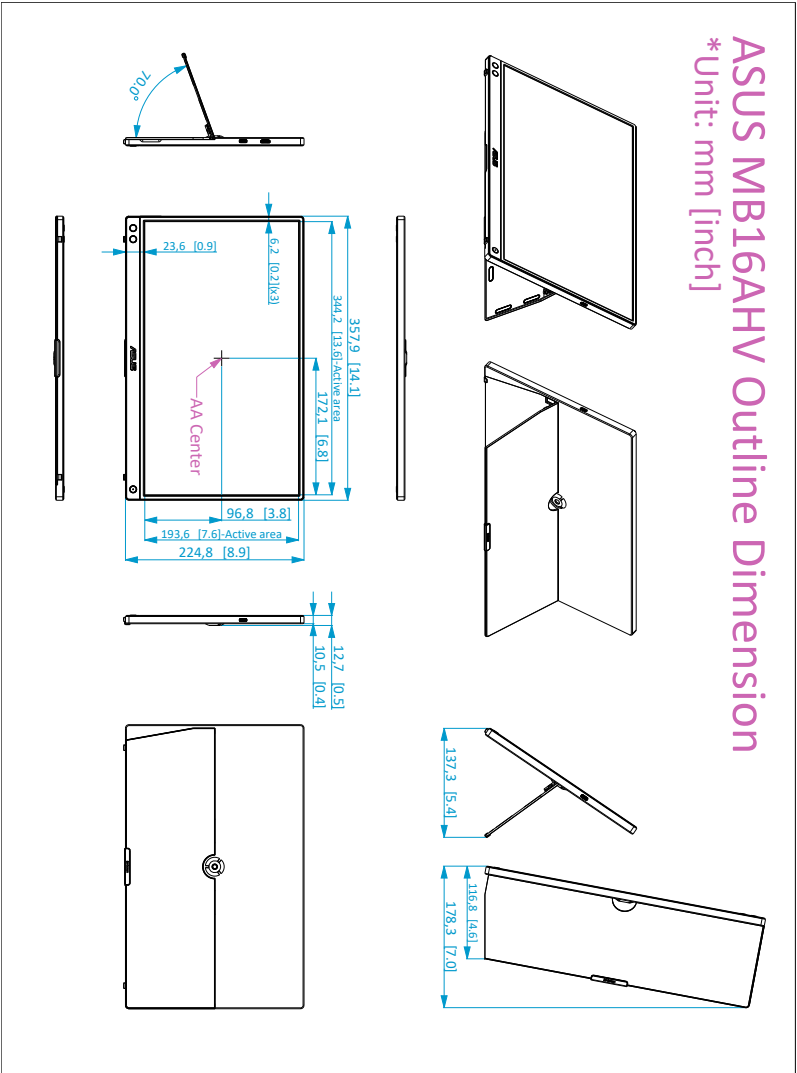

### 3.4 Troubleshooting (FAQ)

Problem	Possible Solution
Power LED is not ON	<ul style="list-style-type: none"> <li>• Press the  button to check if the monitor is in the ON mode.</li> <li>• Check if the power cord is properly connected to the monitor and the power outlet.</li> <li>• Check if the power switch is ON.</li> </ul>
The power LED lights amber and there is no screen image	<ul style="list-style-type: none"> <li>• Check if the monitor and the computer are in the ON mode.</li> <li>• Make sure the signal cable is properly connected the monitor and the computer.</li> <li>• Inspect the signal cable and make sure none of the pins are bent.</li> <li>• Connect the computer with another available monitor to check if the computer is properly working.</li> </ul>
Screen image is too light or dark	<ul style="list-style-type: none"> <li>• Adjust the Contrast and Brightness settings via OSD.</li> </ul>
Screen image bounces or a wave pattern is present in the image	<ul style="list-style-type: none"> <li>• Make sure the USB Type-C cable is properly connected to the monitor and the computer.</li> <li>• Move electrical devices that may cause electrical interference.</li> </ul>
Screen image has color defects (white does not look white)	<ul style="list-style-type: none"> <li>• Inspect the USB Type-C cable and make sure that none of the pins are bent.</li> </ul>

Problem	Possible Solution
<p>After connecting with the USB Type-C source device, the power LED lights continuously blinking or showing ASUS logo repeatedly</p>	<ul style="list-style-type: none"> <li>• Insufficient power supply from source USB Type-C devices. Please follow below steps:               <ol style="list-style-type: none"> <li>1. Press the Blue Light Filter button , and then connect the USB Type-C cable. This operation will enable built-in safe mode. After displaying ASUS logo, please release the Blue Light Filter button. After ASUS Logo disappearing, there is “safe mode” message OSD showing up. Once “safe mode” message OSD disappears, please set background color to white image or nearly white image (*1).</li> <li>2. Press MENU button, main menu OSD is showing. The upper left corner of the OSD will display small red-colored font “S”, indicating it is now in safe mode. Enter brightness setup, press the up key to tune up brightness. During the process, please note down brightness value “Y” up until MB16AC re-start.(*2). For example, if brightness value shows “70” and MB16AC restarts when adjusting to “71”, “70” is the “Y” value to note down and is the highest brightness value for the connecting USB-C source device.</li> <li>3. Press MENU button, main menu OSD is showing. The upper left corner still indicate “S” as safe mode. Adjust the OSD brightness value to “Y”</li> <li>4. Close the OSD and press Low Blue Low Filter hot key for 5 seconds to turn off safe mode.</li> <li>5. Complete.</li> </ol> </li> </ul>

\*1: White color background will consume higher power, so it's better to use white color background to test the power limit from source USB Type-C device.

\*2: If the monitor does not re-start when adjusting to value 100, that means source USB Type-C device has sufficient power supply.

## 3.5 Supported operating modes

Resolution Frequency	Horizontal Frequency (KHz)	Vertical Frequency (Hz)	Pixel (MHz)
640 x 480	31.47(N)	59.94(N)	25.18
800 x 600	37.88(P)	60.32(P)	40
1024 x 768	48.36(N)	60.00(N)	65
1280 x 720	45.00(P)	60.00(N)	74.25
1280 x 800	49.7(P)	60.00(N)	83.5
1280 x 960	60.00(P)	60.00(N)	108
1280 x 1024	63.98(P)	60.02(P)	108
1440 x 900	55.94(N)	59.89(P)	106.5
1600 x 1200	75.00(P)	60.00(P)	162
1680 x 1050	65.29(N)	60.00(P)	146.25
1920 x 1080	67.5(P)	60.00(P)	148.5

\* "P" / "N" stands for "Positive" / "Negative" polarity of incoming H-sync/V-sync (input timing).