



Questo manuale d'istruzione è fornito da trovaprezzi.it. Scopri tutte le offerte per [Asus ProArt PA329CRV](#) o cerca il tuo prodotto tra le [migliori offerte di Monitor](#)



Questo manuale d'istruzione è fornito da trovaprezzi.it. Scopri tutte le offerte per [Asus ProArt PA329CRV](#) o cerca il tuo prodotto tra le [migliori offerte di Monitor](#)

# **ASUS<sup>®</sup>**

## **PA329CRV**

### **Series LCD Monitor**

# *User Guide*

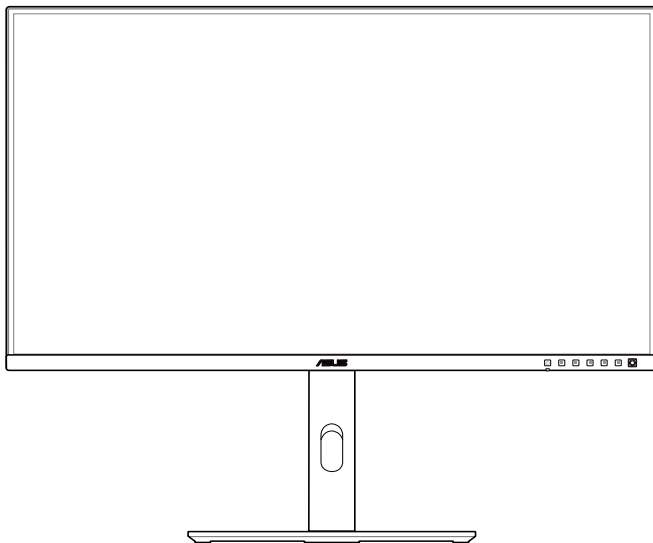

**HDMI<sup>™</sup>**  
HIGH-DEFINITION MULTIMEDIA INTERFACE

First Edition

January 2023

**Copyright © 2023 ASUSTeK COMPUTER INC. All Rights Reserved.**

No part of this manual, including the products and software described in it, may be reproduced, transmitted, transcribed, stored in a retrieval system, or translated into any language in any form or by any means, except documentation kept by the purchaser for backup purposes, without the express written permission of ASUSTeK COMPUTER INC. ("ASUS").

Product warranty or service will not be extended if: (1) the product is repaired, modified or altered, unless such repair, modification or alteration is authorized in writing by ASUS; or (2) the serial number of the product is defaced or missing.

ASUS PROVIDES THIS MANUAL "AS IS" WITHOUT WARRANTY OF ANY KIND, EITHER EXPRESS OR IMPLIED, INCLUDING BUT NOT LIMITED TO THE IMPLIED WARRANTIES OR CONDITIONS OF MERCHANTABILITY OR FITNESS FOR A PARTICULAR PURPOSE. IN NO EVENT SHALL ASUS, ITS DIRECTORS, OFFICERS, EMPLOYEES OR AGENTS BE LIABLE FOR ANY INDIRECT, SPECIAL, INCIDENTAL, OR CONSEQUENTIAL DAMAGES (INCLUDING DAMAGES FOR LOSS OF PROFITS, LOSS OF BUSINESS, LOSS OF USE OR DATA, INTERRUPTION OF BUSINESS AND THE LIKE), EVEN IF ASUS HAS BEEN ADVISED OF THE POSSIBILITY OF SUCH DAMAGES ARISING FROM ANY DEFECT OR ERROR IN THIS MANUAL OR PRODUCT.

SPECIFICATIONS AND INFORMATION CONTAINED IN THIS MANUAL ARE FURNISHED FOR INFORMATIONAL USE ONLY, AND ARE SUBJECT TO CHANGE AT ANY TIME WITHOUT NOTICE, AND SHOULD NOT BE CONSTRUED AS A COMMITMENT BY ASUS. ASUS ASSUMES NO RESPONSIBILITY OR LIABILITY FOR ANY ERRORS OR INACCURACIES THAT MAY APPEAR IN THIS MANUAL, INCLUDING THE PRODUCTS AND SOFTWARE DESCRIBED IN IT.

Products and corporate names appearing in this manual may or may not be registered trademarks or copyrights of their respective companies, and are used only for identification or explanation and to the owners' benefit, without intent to infringe.

# Contents

Contents .....	iii
Notices.....	iv
TCO certified .....	vi
Safety information .....	vii
Care & Cleaning.....	ix
Takeback Services.....	x
Product information for EU energy label.....	x
<b>Chapter 1: Product introduction</b>	
1.1 Welcome! .....	1-1
1.2 Package contents.....	1-1
1.3 Monitor introduction .....	1-2
1.3.1 Front view .....	1-2
1.3.2 Back view .....	1-4
1.3.3 Other Function(s) .....	1-5
<b>Chapter 2: Setup</b>	
2.1 Assembling the monitor arm/base .....	2-1
2.2 Detaching the arm/base (for VESA wall mount) .....	2-2
2.3 Adjusting the monitor.....	2-3
2.4 Connecting the cables.....	2-4
2.5 Turning on the monitor .....	2-5
<b>Chapter 3: General instructions</b>	
3.1 OSD (On-Screen Display) menu .....	3-1
3.1.1 How to reconfigure.....	3-1
3.1.2 OSD function introduction.....	3-2
3.2 Specifications summary.....	3-12
3.3 Outline dimensions.....	3-14
3.4 Troubleshooting (FAQ).....	3-15
3.5 Supported operating modes .....	3-16

# Notices

## Federal Communications Commission Statement

This device complies with Part 15 of the FCC Rules. Operation is subject to the following two conditions:

- This device may not cause harmful interference, and
- This device must accept any interference received including interference that may cause undesired operation.

This equipment has been tested and found to comply with the limits for a Class B digital device, pursuant to Part 15 of the FCC Rules. These limits are designed to provide reasonable protection against harmful interference in a residential installation. This equipment generates, uses and can radiate radio frequency energy and, if not installed and used in accordance with the instructions, may cause harmful interference to radio communications. However, there is no guarantee that interference will not occur in a particular installation. If this equipment does cause harmful interference to radio or television reception, which can be determined by turning the equipment off and on, the user is encouraged to try to correct the interference by one or more of the following measures:

- Reorient or relocate the receiving antenna.
- Increase the separation between the equipment and receiver.
- Connect the equipment into an outlet on a circuit different from that to which the receiver is connected.
- Consult the dealer or an experienced radio/TV technician for help.



---

The use of shielded cables for connection of the monitor to the graphics card is required to assure compliance with FCC regulations. Changes or modifications to this unit not expressly approved by the party responsible for compliance could void the user's authority to operate this equipment.

---

## ENERGY STAR complied product



ENERGY STAR is a joint program of the U.S. Environmental Protection Agency and the U.S. Department of Energy helping us all save money and protect the environment through energy efficient products and practices.

All ASUS products with the ENERGY STAR logo comply with the ENERGY STAR standard, and the power management feature is enabled by default. The monitor and computer are automatically set to sleep after 10 and 30 minutes of user inactivity. To wake your computer, click the mouse or press any key on the keyboard. Please visit <http://www.energystar.gov/powermanagement> for detail information on power management and its benefits to the environment. In addition, please visit <http://www.energystar.gov> for detail information on the ENERGY STAR joint program.



---

NOTE: Energy Star is NOT supported on FreeDOS and Linux-based operating system.

---

## **Canadian Department of Communications Statement**

This digital apparatus does not exceed the Class B limits for radio noise emissions from digital apparatus set out in the Radio Interference Regulations of the Canadian Department of Communications.

This class B digital apparatus complies with Canadian ICES-003.

This Class B digital apparatus meets all requirements of the Canadian Interference - Causing Equipment Regulations.

Cet appareil numérique de la classe B respecte toutes les exigences du Règlement sur le matériel brouiller du Canada.



## **Hardware Low Blue Light compliance**

The Monitor use Low Blue Light panel and compliance with TUV Rheinland (Hardware Solution) at factory reset/default setting model (Preset mode: Standard).

Decreases the blue light emitted from the display to reduce the risk of blue light exposure to your eyes.

- Place the screen 20 - 28 inches [50 - 70 cm] away from your eyes and a little below eye level.
- Consciously blinking the eyes every now and then will help to reduce eye strain after extended screen time.
- Take breaks for 20 minutes every 2 hours.
- Look away from the screen and gaze at a distant object for at least 20 seconds during breaks.
- Make stretches to relieve body fatigue or pain during breaks.

## **Flicker-Free technology**

The Monitor adopts Flicker-Free technology, which clears the eye visible flicker, brings comfort viewing experience and preventing users suffer from eye strain and fatigue.

# TCO certified

A third-party certification according to ISO 14024



Toward sustainable IT products

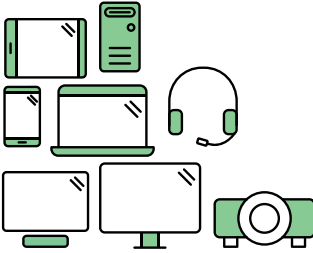

## Say hello to a more sustainable product

IT products are associated with a wide range of sustainability risks throughout their life cycle. Human rights violations are common in the factories. Harmful substances are used both in products and their manufacture. Products can often have a short lifespan because of poor ergonomics, low quality and when they are not able to be repaired or upgraded.

**This product is a better choice.** It meets all the criteria in TCO Certified, the world's most comprehensive sustainability certification for IT products. Thank you for making a responsible product choice, that help drive progress towards a more sustainable future!

Criteria in TCO Certified have a life-cycle perspective and balance environmental and social responsibility. Conformity is verified by independent and approved verifiers that specialize in IT products, social responsibility or other sustainability issues. Verification is done both before and after the certificate is issued, covering the entire validity period. The process also includes ensuring that corrective actions are implemented in all cases of factory non-conformities. And last but not least, to make sure that the certification and independent verification is accurate, both TCO Certified and the verifiers are reviewed regularly.

### Want to know more?

Read information about TCO Certified, full criteria documents, news and updates at [tcocertified.com](https://www.tcocertified.com). On the website you'll also find our Product Finder, which presents a complete, searchable listing of certified products.

# Safety information

- Before setting up the monitor, carefully read all the documentation that came with the package.
- To prevent fire or shock hazard, never expose the monitor to rain or moisture.
- Never try to open the monitor cabinet. The dangerous high voltages inside the monitor may result in serious physical injury.
- If the power supply is broken, do not try to fix it by yourself. Contact a qualified service technician or your retailer.
- Before using the product, make sure all cables are correctly connected and the power cables are not damaged. If you detect any damage, contact your dealer immediately.
- Slots and openings on the back or top of the cabinet are provided for ventilation. Do not block these slots. Never place this product near or over a radiator or heat source unless proper ventilation is provided.
- The monitor should be operated only from the type of power source indicated on the label. If you are not sure of the type of power supply to your home, consult your dealer or local power company.
- Use the appropriate power plug which complies with your local power standard.
- Do not overload power strips and extension cords. Overloading can result in fire or electric shock.
- Avoid dust, humidity, and temperature extremes. Do not place the monitor in any area where it may become wet. Place the monitor on a stable surface.
- Unplug the unit during a lightning storm or if it will not be used for a long period of time. This will protect the monitor from damage due to power surges.
- Never push objects or spill liquid of any kind into the slots on the monitor cabinet.
- To ensure satisfactory operation, use the monitor only with UL listed computers which have appropriate configured receptacles marked between 100-240V AC.
- By means of a power cord connected to a socket-outlet with earthing connection.
- If you encounter technical problems with the monitor, contact a qualified service technician or your retailer.
- Adjustment of the volume control as well as the equalizer to other settings than the center position may increase the ear-/headphones output voltage and therefore the sound pressure level.



This symbol of the crossed out wheeled bin indicates that the product (electrical, electronic equipment, and mercury-containing button cell battery) should not be placed in municipal waste. Please check local regulations for disposal of electronic products.

## Prevent Tipping

When using the display, fasten the LCD to a wall using a cord or chain that can support the weight of the monitor in order to prevent the monitor from falling.

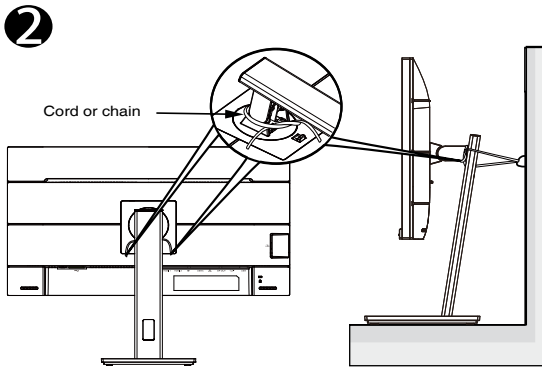
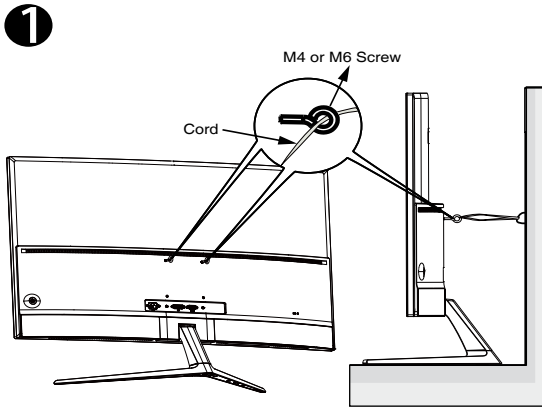

- Display design may differ from those illustrated.
- Installing must be done by a qualified technician , and please contact your supplier for more information.
- For the Models with net weight  $\geq 7\text{kg}$ . Please select the suitable way to Prevent Tipping.
- For the models with VESA Mount, please use method 1, install the screws with ring to the VESA Mount hole, then tie the cord or chain to the wall. Otherwise, please use method 2 to tie the cord or chain to the stand and then fix it to the wall.

## **AEEE yönetmeliğine uygundur**

### **Care & Cleaning**

- Before you lift or reposition your monitor, it is better to disconnect the cables and power cord. Follow the correct lifting techniques when positioning the monitor. When lifting or carrying the monitor, grasp the edges of the monitor. Do not lift the display by the stand or the cord.
- Cleaning. Turn your monitor off and unplug the power cord. Clean the monitor surface with a lint-free, non-abrasive cloth. Stubborn stains may be removed with a cloth dampened with mild cleaner.
- Avoid using a cleaner containing alcohol or acetone. Use a cleaner intended for use with the monitor. Never spray cleaner directly on the screen, as it may drip inside the monitor and cause an electric shock.

### **The following symptoms are normal with the monitor:**

- You may find slightly uneven brightness on the screen depending on the desktop pattern you use.
- When the same image is displayed for hours, an afterimage of the previous screen may remain after switching the image. The screen will recover slowly or you can turn off the Power Switch for hours.
- When the screen becomes black or flashes, or cannot work anymore, contact your dealer or service center to fix it. Do not repair the screen by yourself!

### **Conventions used in this guide**



**WARNING:** Information to prevent injury to yourself when trying to complete a task.



**CAUTION:** Information to prevent damage to the components when trying to complete a task.



**IMPORTANT:** Information that you **MUST** follow to complete a task.



**NOTE:** Tips and additional information to aid in completing a task.

## Where to find more information

Refer to the following sources for additional information and for product and software updates.

### 1. ASUS websites

The ASUS websites worldwide provide updated information on ASUS hardware and software products. Refer to <http://www.asus.com>

### 2. Optional documentation

Your product package may include optional documentation that may have been added by your dealer. These documents are not part of the standard package.

## Takeback Services

ASUS recycling and takeback programs come from our commitment to the highest standards for protecting our environment. We believe in providing solutions for our customers to be able to responsibly recycle our products, batteries and other components as well as the packaging materials.

Please go to <http://csr.asus.com/english/Takeback.htm> for detail recycling information in different region.

## Product information for EU energy label



PA329CRV



## 1.1 Welcome!

Thank you for purchasing the ASUS® LCD monitor!

The latest widescreen LCD monitor from ASUS provides a broader, brighter and crystal-clear display, plus a host of features that enhance your viewing experience.

With these features, you can enjoy the convenience and delightful visual experience that the monitor brings to you!

## 1.2 Package contents

Check your package for the following items:

- ✓ LCD monitor
- ✓ Monitor base
- ✓ Quick start guide
- ✓ Warranty card
- ✓ Power cord
- ✓ HDMI cable (optional)
- ✓ DisplayPort cable (optional)
- ✓ USB C to C cable (optional)
- ✓ Color calibration testing report
- ✓ ProArt welcome card



---

If any of the above items is damaged or missing, contact your retailer immediately.

---



---

If you need to replace the power cord or the connection cable(s), please contact ASUS customer service.

---



# 1.3 Monitor introduction

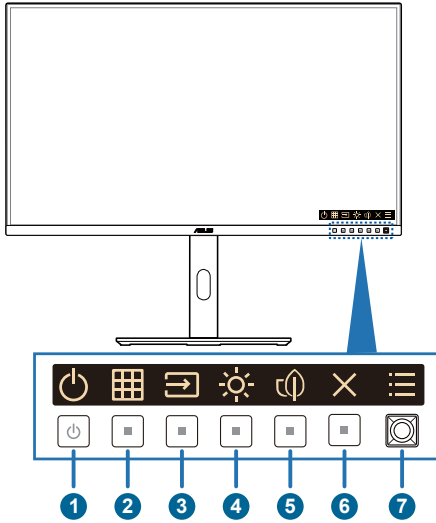



## 1.3.1 Front view



- 1.  Power button/power indicator
  - Turns the monitor on/off. Press and hold this button for 0.6 seconds will shut down the monitor.
  - The color definition of the power indicator is as the below table.

Status	Description
White	On
Amber	Standby mode
Off	Off

- 2.  QuickFit Plus button:
  - Press this button to display the OSD menu when the OSD is off.
  - Selects the QuickFit Plus function.
- 3.  Signal button:
  - Press this button to display the OSD menu when the OSD is off.
  - Press this button to switch to next active input source (if available).

4.  Shortcut 2
  - Press this button to display the OSD menu when the OSD is off.
  - Default: Brightness hotkey
  - To change the hotkey function, go to the Shortcut > Shortcut 2 menu.
5.  Shortcut 1
  - Press this button to display the OSD menu when the OSD is off.
  - Default: Energy Saving hotkey
  - To change the hotkey function, go to the Shortcut > Shortcut 1 menu.
6.  Exit button:
  - Press this button to display the OSD menu when the OSD is off.
  - Exits the OSD menu.
7.  Menu (5-way) button:
  - Press this button to display the OSD menu when the OSD is off. Press this button again to enter the OSD main menu.
  - Enacts the selected OSD menu items.
  - Increases/Decreases values or moves your selection up/down/left/right.
  - Push the 5-way button down for over 5 seconds to toggle the Key Lock function between on and off.

## 1.3.2 Back view

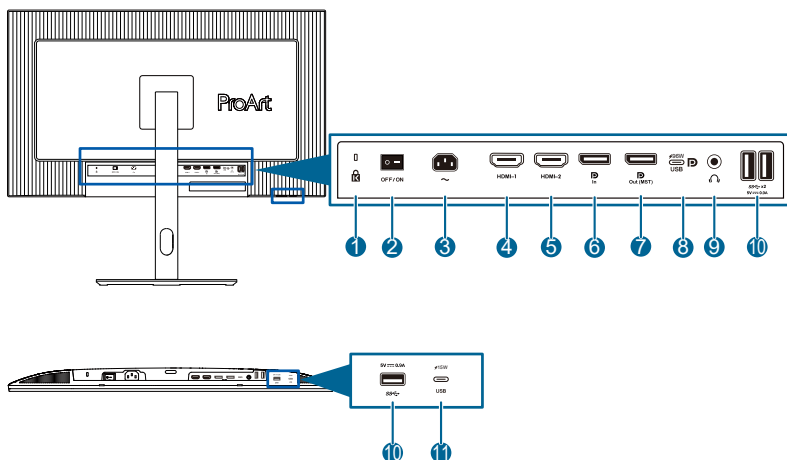

1. **Kensington lock slot.**
2. **Power switch:** Press the switch to turn on/off power.
3. **AC-IN port:** This port connects the power cord.
4. **HDMI-1 port:** This port is for connection with an HDMI compatible device.
5. **HDMI-2 port:** This port is for connection with an HDMI compatible device.
6. **DisplayPort in:** This port is for connection with a DisplayPort compatible device.
7. **Daisy-Chain DisplayPort output:** This port allows you to connect multiple DisplayPort compatible monitors.
8. **USB 3.2 Gen 1 Type-C:** This port is for connection with a USB upstream cable. The connection supports USB power and data delivery.



This monitor is Super-Speed USB 3.2 Gen 1 compatible(5Gbps). The port offer 96W power delivery with output voltage of 5V/3A, 9V/3A, 12V/3A 15V/3A, 20V/4.8A.

9. **Earphone jack:** This port is only available when an HDMI/DisplayPort/USB Type-C cable is connected.
10. **USB 3.2 Gen 1 Type-A:** These ports are for connection with USB devices, such as USB keyboard/mouse, USB flash drive, etc.
11. **USB 3.2 Gen 1 Type-C:** This port is for connection with USB devices, such as USB keyboard/mouse, USB flash drive, etc.

### 1.3.3 Other Function(s)

#### 1. Daisy chaining (for selected models)

The monitor supports daisy chain on DisplayPort and USB Type-C. Daisy Chaining allows up to 4 monitors to be connected in series with the video signal being passed from the source to a monitor (when the input source is 3840 x 2160 @60Hz and no USB-C device is connected). In order to enable daisy chaining, please make sure the source transported.



This function is only available when Power Saving is Normal Level. If you set Power Saving to Deep Level, all the connected monitors will display the same content at the same time (clone). Note: Input port will be fixed (no auto detection) when DP out cable is plugged.

3840 x 2160 @60Hz

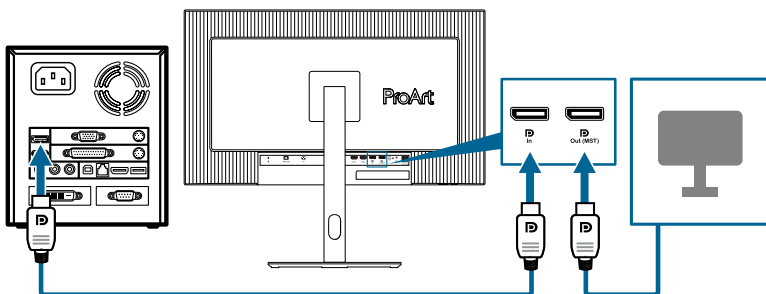

3840 x 2160 @60Hz

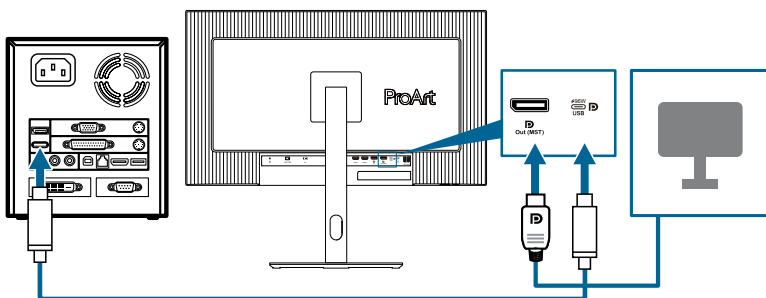

## 2.1 Assembling the monitor arm/base

To assemble the monitor base:

1. Make sure the triangle marks of VESA cover aligned.
2. Attach the arm into the VESA cover.
3. Shut the lock to make the arm and VESA cover assembled.
4. Have the front of the monitor face down on a table, slide the tabs on the arm into the slots on the VESA cover.
5. Press down the arm assembly to snap it into place.
6. Attach the base into the arm, making sure the tab on the arm fits into the groove on the base.
7. Fix the base to the arm by fastening the bundled screw.



We recommend that you cover the table surface with soft cloth to prevent damage to the monitor.

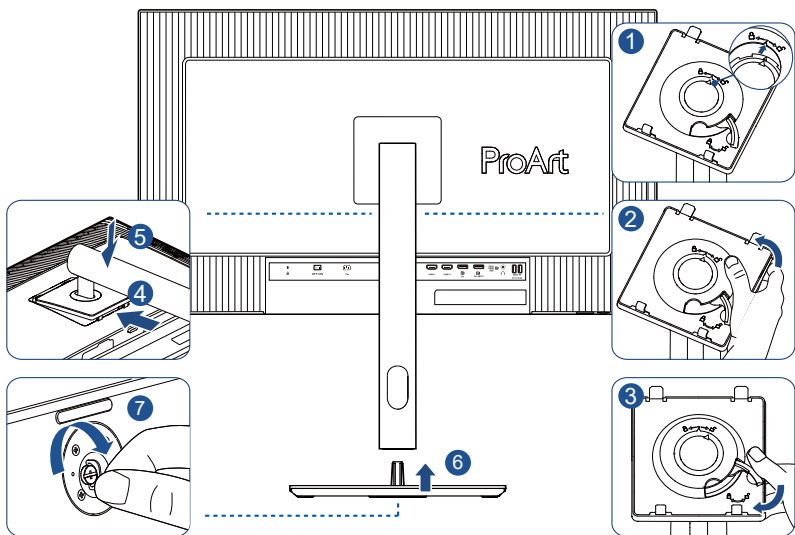

Base screw size: M6 x 16.2 mm.

## 2.2 Detaching the arm/base (for VESA wall mount)

The detachable arm/base of this monitor is specially designed for VESA wall mount.

To detach the arm/base:

1. Have the front of the monitor face down on a table.
2. Press the release button, and then detach the arm/base from the monitor (Figure 1).

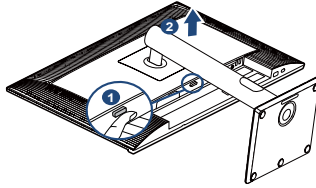

---

We recommend that you cover the table surface with soft cloth to prevent damage to the monitor.

---



- The VESA wall mount kit (100 x 100 mm) is purchased separately.
  - Use only with UL/CSA/GS Listed Wall Mount Bracket with minimum weight/load bearing capacity of 10.6 kg (23.37 lb) (Screw size: M4 x 10 mm).
-

## 2.3 Adjusting the monitor

- For optimal viewing, we recommend that you look at the full face of the monitor, then adjust the monitor to the angle that is most comfortable for you.
- Hold the stand to prevent the monitor from falling when you change its angle.
- You can adjust the monitor's angle from  $+23^\circ$  to  $-5^\circ$ ,  $\pm 30^\circ$  swivel adjustment from either left or right, and it allows  $\pm 90^\circ$  pivot adjustment. You can also adjust the monitor's height within  $\pm 130$  mm.

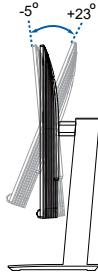

(Tilt)

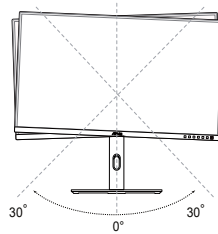

(Swivel)

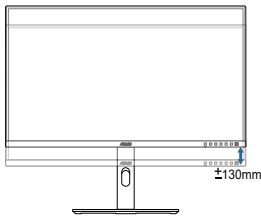

(Height adjustment)

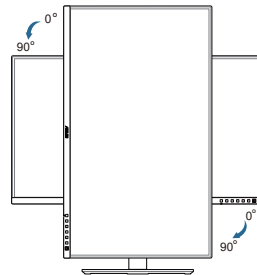

(Pivot)



It is normal that the monitor slightly shakes while you adjust the viewing angle.

## 2.4 Connecting the cables

Connect the cables as the following instructions:

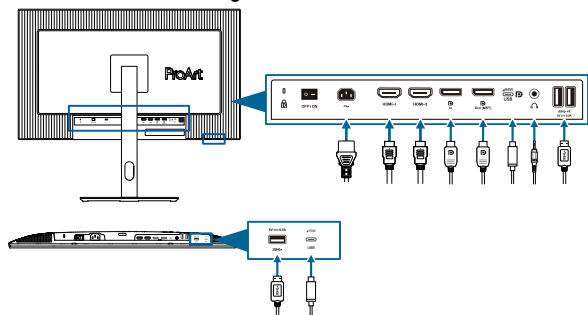

- **To connect the power cord:** Connect one end of the power cord securely to the monitor's AC input port, the other end to a power outlet.
- **To connect the HDMI/DisplayPort/USB Type-C\* cable:**
  - a. Plug one end of the HDMI/DisplayPort/USB Type-C\* cable to the monitor's HDMI/DisplayPort/USB Type-C jack.
  - b. Connect the other end of the HDMI/DisplayPort/USB Type-C\* cable to your device's HDMI/DisplayPort/USB Type-C jack.



It is suggested to use USB certified Type-C cable. If the signal source supports DP Alt mode, all video, audio and data signal can be transmitted.

- **To use the earphone:** connect the end with plug type to the monitor's earphone jack when an HDMI/DisplayPort/USB Type-C signal is fed.
- **To use the USB 3.2 Gen 1 ports:**
  - » Upstream: Use an USB Type-C cable and plug on end of the Type-C connector to the monitor's USB Type-C port as upstream and the other end to your computer's USB Type-C jack. Or use an USB Type-C to Type-A cable and plug the Type-C connector to the the monitor's USB Type-C as upstream and the Type-A connector to your computer's USB Type-A jack. Make sure your computer is installed with the Windows, macOS operating system. That will enable the USB ports on the monitor to work.
  - » Downstream: Use an USB cable to connect your device with the monitor's USB Type-A jack.





When these cables are connected, you can choose the desired signal from the **Signal** item in the OSD menu.



If you need to replace the power cord or the connection cable(s), please contact ASUS customer service.







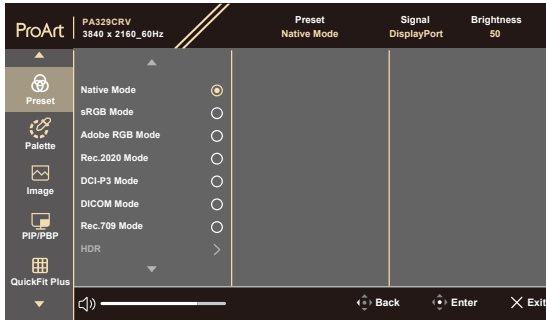

## 2.5 Turning on the monitor

Press the power button . See page 1-2 for the location of the power button. The power indicator  lights up in white to show that the monitor is ON.

## 3.1 OSD (On-Screen Display) menu

### 3.1.1 How to reconfigure



1. Press any button to display the OSD menu.
2. Press the  Menu (5-way) button to enter the OSD main menu.
3. Move the  Menu (5-way) button up/down/left/right to navigate through the functions. Highlight the desired function and press the Menu (5-way) button to activate it. If the function selected has a sub-menu, move the  Menu (5-way) button up/down to navigate through the sub-menu functions. Highlight the desired sub-menu function and press the  Menu (5-way) button or move the  Menu (5-way) button to activate it.
4. Move the  Menu (5-way) button up/down to change the settings of the selected function.
5. To exit and save the OSD menu, press the  button or move the  Menu (5-way) left repeatedly until the OSD menu disappears. To adjust other functions, repeat steps 1-4.

### 3.1.2 OSD function introduction

#### 1. Preset

This function contains 10 sub-functions you can select for your preference. Each mode has the Reset selection, allowing you to maintain your setting or return to the preset mode.

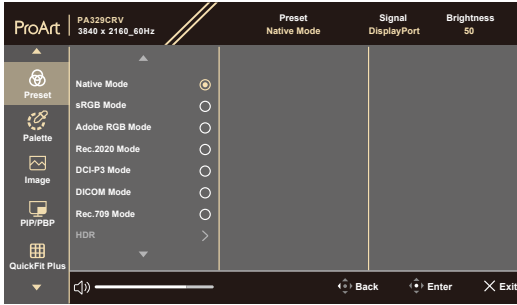

- **Native Mode:** Best choice for document editing.
- **sRGB Mode:** Compatible with sRGB color space, sRGB mode is the best choice for document editing.



Energy star® cert done in native mode.

- **Adobe RGB Mode:** Compatible with Adobe RGB color space.
- **Rec.2020 Mode:** Compatible with Rec.2020 color space.
- **DCI-P3 Mode:** Compatible with DCI-P3 color space.
- **DICOM Mode:** Compatible with DICOM standard, best choice for medical image checking.
- **Rec. 709 Mode:** Compatible with Rec. 709 color space.
- **HDR:** High Dynamic Range. Contains three HDR modes (**PQ Optimized**, **PQ Clip**, and **PQ Basic**).



To activate this function, you need to do the following: turn off PIP/PBP. For better HDR performance (to meet DisplayHDR standard), you need to do the following: set Dynamic Dimming to Fast and HDR mode to PQ Clip.

- **User Mode 1/User Mode 2:** Allows you to make color adjustments in the Advanced Setting.

Below table shows the default configurations for each ProArt Preset mode:

Function	Native Mode	sRGB Mode	Adobe RGB Mode	Rec. 2020 Mode	DCI-P3 Mode	DICOM	Rec. 709 Mode	Mode HDR	User Mode 1/ User Mode 2
Color Temp.	6500K	Fixed (6500K)	Fixed (6500K)	6500K	P3-Theater	6500K	6500K	Fixed (6500K)	6500K
Brightness	50	Fixed 80 nits	160 nits	100 nits	48 nits	50	100 nits	250 nits/ Max	50
Contrast	80	80	80	80	80	80	80	Fixed	80
Sharpness	Enable (0)	Enable (0)	Enable (0)	Enable (0)	Enable (0)	Enable (0)	Enable (0)	Enable (0)	Enable (0)
Saturation	Middle (50)	Fixed	Middle (50)	Middle (50)	Middle (50)	Middle (50)	Middle (50)	Fixed	Middle (50)
Hue	Middle (50)	Fixed	Middle (50)	Middle (50)	Middle (50)	Middle (50)	Middle (50)	Fixed	Middle (50)
ProArt Palette/ Color	Enable (Default)	Fixed	Enable (Default)	Enable (Default)	Enable (Default)	Enable (Default)	Enable (Default)	Enable (RGB Gain only)	Enable (RGB Gain only)
Black Level	Enable (Default)	Enable (Default)	Enable (Default)	Enable (Default)	Enable (Default)	Enable (Default)	Enable (Default)	Enable (Default)	Enable (Default)
Gamma	Enable (2.2)	Fixed (2.2)	Fixed (2.2)	Enable (2.4)	Enable (2.2, 2.6 only)	Fixed (DICOM)	Enable (2.4)	Fixed	Fixed (2.2)
Input Range	Enable (Auto)	Enable (Auto)	Enable (Auto)	Enable (Auto)	Enable (Auto)	Enable (Auto)	Enable (Auto)	Enable (Auto)	Enable (Auto)

## 2. Palette

Set a desired color setting from this menu.

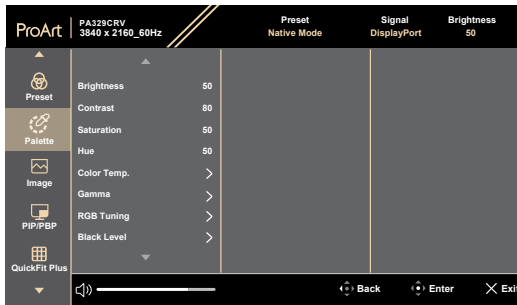

- **Brightness:** The adjusting range is from 0 to 100.
- **Contrast:** The adjusting range is from 0 to 100.
- **Saturation:** The adjusting range is from 0 to 100.
- **Hue:** Shifts the image color between green and purple.
- **Color Temp.:** Contains 5 modes including 9300K, 6500K, 5500K, 5000K and P3-Theater. P3-Theater is only available for DCI-P3 Mode.
- **Gamma:** Allows you to set the color mode to 2.6, 2.4, 2.2, 2.0 or 1.8 (Mac).
- **RGB Tuning:**
  - \* **Gain:** The adjusting range is from 0 to 100.
  - \* **Offset:** The adjusting range is from 0 to 100.
- **Black Level:** To adjust the initialized 1st signal level of darkest gray level.
  - \* **Signal:** The adjusting range is from 0 to 100.
  - \* **Backlight:** To adjust darkness of backlight.
- **Color Reset:**
  - \* **Current mode color reset:**  
Resets the color settings of current color mode to the factory default value.
  - \* **All modes color reset:**  
Resets the color settings of all color modes to the factory default value.

### 3. Image

Set the image related setting from this menu.

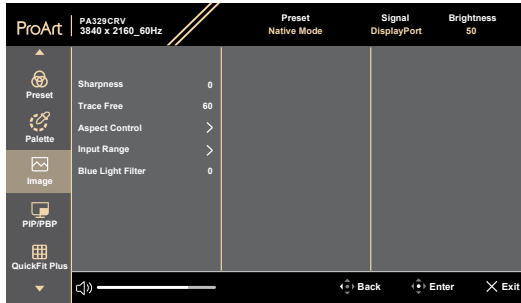

- **Sharpness:** The adjusting range is from 0 to 100.
- **Trace Free:** Adjusts the response time of the monitor.



To activate this function, you need to do the following: turn off PIP/PBP and disable HDR on your device.

- **Aspect Control:** Adjusts the aspect ratio to **Full**, **Dot to Dot** or **1:1 Ratio**.



To activate this function, you need to do the following: turn off **MediaSync** and **PBP**.

- **Input Range:** To map signal range with whole black to white presented range of display.
- **Blue Light Filter:** Adjust the strength of blue light filter.



To activate this function, you need to do the following: disable HDR on your device.

#### 4. PIP/PBP

The PIP/PBP menu allows you to open up another sub-window connected from another video source (when input source is below 60Hz) besides the main-window from your original video source.



To activate this function, you need to do the following: turn off **MediaSync/VRR/Dynamic Dimming** and disable HDR on your device.

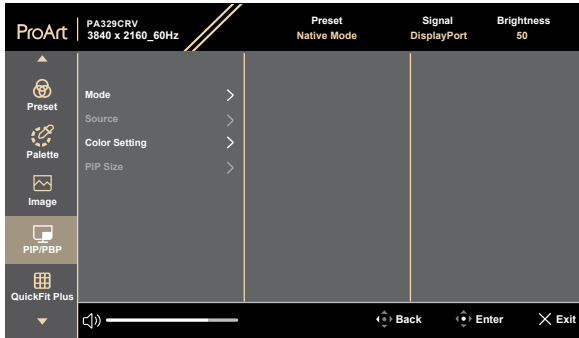

- **Mode:** Selects **PIP**, **PBP** function, or turn it off.



To scale both displays to full screen in PBP mode, set resolution settings for both as 1920 x 2160 in OS display settings. (And make sure that the scaling option is "Maintain Display Scaling" if you are using an Intel graphic card.)

- **Source:** Selects the video input source from among **HDMI-1**, **HDMI-2**, **DisplayPort** and **USB Type-C**. The table below shows the input source combinations.
- **Color setting:** Select color Preset for Main and Sub windows.
- **PIP Size:** Adjusts the PIP size to **Small**, **Medium** or **Large** (Only available for the PIP mode).



## 5. QuickFit Plus

In this function, you can use different kinds of alignment patterns.

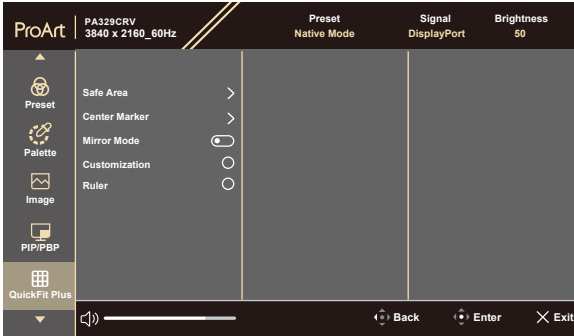

To activate this function, you need to do the following: turn off PIP/PBP, disable HDR on your device and restore your screen back to normal position (do not rotate).



- **Safe Area:** Facilitates designers and users to organize content and layout on one page and achieve a consistent look and feel. The selections are: **1:1, Action Safe, Title Safe, 3 x 3.**
- **Center Marker:** Adjusts the **Type 1, Type 2, Type 3.**
- **Mirror Mode:** Flip the image horizontally.
- **Customization:** You can decide the frame size by moving the  Menu (5-way) button up/down/left/right. You can press the  Menu (5-way) button for longer than 3 seconds to switch the measurements between millimeter and inch.
- **Ruler:** This pattern presents physical ruler on top and left side. You can press the  Menu (5-way) button for longer than 3 seconds to switch the measurements between metric and imperial.

## 6. Signal

In this function, you can select your desired input source.

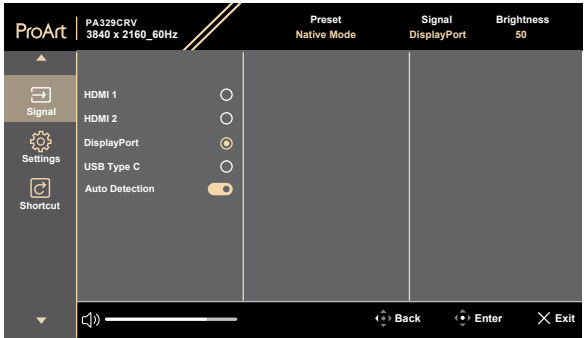

- **Auto Detection:** automatically detects other active signals when current input signal is inactive.



---

To activate this function, you need to do the following: remove the connection of Daisy-Chain DisplayPort output (to disable MST output).

---

## 7. Settings

Allows you to adjust the system.

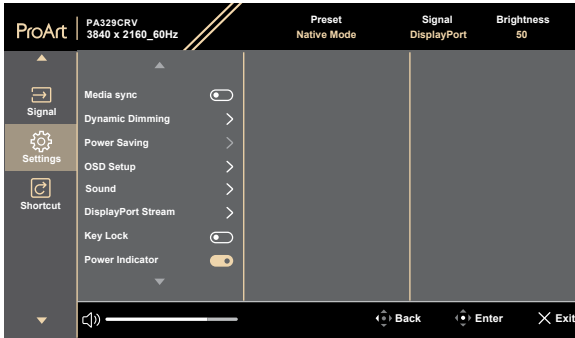

- **MediaSync:** Turn on VESA MediaSync support.
  - \* MediaSync can only be activated within 48Hz ~ 60Hz.
  - \* For supported GPUs, minimum PC system and driver requirements, please contact the GPU manufactures.



---

To activate this function, you need to do the following: turn off PIP/PBP.

---

- **Dynamic Dimming:** Synchronizes with contents while contrast changing to execute backlight dynamic dimming. You can adjust the synchronization speed as “**Fast**”, “**Medium**”, “**Gradual**” or “**Off**”.



---

To activate this function, you need to do the following: turn off **PIP/PBP**.

---

- **Power Saving:** Select **Normal Level** for power on hub during power saving. Select **Deep Level** for power off hub during power saving.



---

To activate daisy chaining, you need to do the following: set Power Saving to Normal Level. Note: Input port will be fixed (no auto detection) when DP out cable is plugged.

---

- **OSD Setup:**

- \* Adjusts the **OSD Timeout** from 10 to 120 seconds.
- \* Enables or disables the **DDC/CI** function.
- \* Adjusts the OSD background from **opaque** to **Transparent**.
- \* Enables or disables the **OSD Auto Rotation** function.



---

To activate OSD Auto Rotation, you need to do the following: turn off PIP/PBP.

---

- **Sound:**

- \* Adjusts **Volume** from 0 to 100.
- \* Mute or un-Mute the audio output.
- \* Select audio input from PIP/PBP **Sources**.



---

To activate Sound function, you need to do the following: turn on PIP/PBP.

---

- **DisplayPort Stream:** Compatibility with graphic card. Select **DisplayPort 1.2**, **DisplayPort 1.4** or **DisplayPort 1.4 + USB 3.2** by graphic card DP version.

- **Key Lock:** To disable all function keys. Push the 5-way button down for over 5 seconds to cancel the key lock function.
- **Power Indicator:** Turns the power LED indicator on/off.
- **Language:** There are 22 languages for your selection, including English, French, German, Italian, Spanish, Dutch, Portuguese, Russian, Czech, Croatian, Polish, Romanian, Hungarian, Turkish, Simplified Chinese, Traditional Chinese, Japanese, Korean, Thai, Indonesian, Persian, Ukrainian.
- **Information:** Shows the monitor information.
- **All Reset:** "Yes" allows you to restore the default settings.

## 8. Shortcut

Defines the functions for Shortcut 1 and 2 buttons.

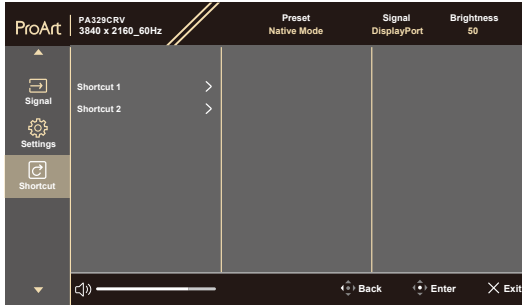

- **Shortcut 1/Shortcut 2:** Selects a function for Shortcut 1 and 2 buttons.



---

When a certain function is selected or activated, your shortcut key may not support. Available function choices for shortcut: Blue Light Filter, Brightness, HDR, Contrast, PIP/PBP, Color Temp., Volume, Energy Saving, User Mode 1, User Mode 2.

---

## 3.2 Specifications summary

<b>Panel Type</b>	TFT LCD
<b>Panel size</b>	31.5" (16:9, 80 cm) wide screen
<b>Max. Resolution</b>	3840 x 2160
<b>Pixel pitch</b>	0.182 mm x 0.182 mm
<b>Brightness (Typ.)</b>	350 cd/m <sup>2</sup> (SDR), 400 cd/m <sup>2</sup> (HDR)
<b>Contrast Ratio (Typ.)</b>	1000:1
<b>Contrast Ratio (Dynamic)</b>	3000:1
<b>Viewing angle (H/V) CR&gt;10</b>	178°/178°
<b>Display colors</b>	1,073.7M(8-bit+FRC)
<b>Response time</b>	5 ms (GTG)
<b>ProArt Preset selection</b>	10 color preset modes
<b>Auto adjustment</b>	No
<b>Color temperature selection</b>	5 color temperatures
<b>Analog input</b>	No
<b>Digital input</b>	DisplayPort v1.4, HDMI 2.0 x 2, DisplayPort over USB Type-C
<b>Digital Output</b>	DisplayPort
<b>Earphone jack</b>	Yes
<b>Audio input</b>	No
<b>Speaker (Built-in)</b>	2 W x 2 Stereo, RMS
<b>USB 3.2 Gen 1 port</b>	1 x USB 3.2 Gen 1 Type-C 3 x USB 3.2 Gen 1 Type-A
<b>Colors</b>	Black
<b>Power LED</b>	White (On)/Amber (Standby)
<b>Tilt</b>	+23° ~ -5°
<b>Pivot</b>	+90° ~ -90°
<b>Swivel</b>	+30° ~ -30°
<b>Height Adjustment</b>	130 mm
<b>Kensington lock</b>	Yes
<b>AC input voltage</b>	AC: 100~240V
<b>Power consumption</b>	Power On: 26.22 W**(Typ.), Power Standby: ≤ 0.5 W, DC Power Off: 0.3 W, AC Switch Off: 0 W
<b>Temperature (Operating)</b>	0°C~50°C
<b>Temperature (Non-operating)</b>	-20°C~+60°C
<b>Dimension (W x H x D) without stand</b>	713.8 mm x 419.3 mm x 44.7 mm
<b>Dimension (W x H x D) with stand</b>	713.8 mm x 617.67mm x 240 mm (highest) 713.8 mm x 487.67mm x 240 mm (lowest) 828mm x 509mm x 142mm (package)
<b>Weight (Esti.)</b>	9.9 kg (Net); 6.7 kg (Net, without stand); 14.2 kg (Gross)

<b>Multi-languages</b>	22 languages (English, French, German, Italian, Spanish, Dutch, Portuguese, Russian, Czech, Croatian, Polish, Romanian, Hungarian, Turkish, Simplified Chinese, Traditional Chinese, Japanese, Korean, Thai, Indonesian, Persian, Ukrainian)
<b>Accessories</b>	Quick start guide, warranty card, power cord, HDMI cable (optional), DisplayPort cable (optional), USB C to C cable (optional), color calibration testing report, ProArt welcome card
<b>Compliance and Standards</b>	cTUVus, FCC, ICES-3, EPEAT Gold, CB, CE, ErP, WEEE, EU Energy, TUV-GS, TUV-Ergo, ISO 9241-307, UkrSEPRO, CU, CCC, CEL, BSMI, RCM, MEPS, VCCI, PSE, PC Recycle, J-MOSS, KC, KCC, e-Standby, PSB, Energy Star®, TCO, RoHs, HF, CEC, BIS, Windows 10/11 WHQL, Flicker Free, Low Blue Light, CECP

**\*Specifications are subject to change without notice.**

**\*\*Power consumption of On Mode as defined in Energy Star 8.0 version.**



## 3.4 Troubleshooting (FAQ)

Problem	Possible Solution
Power LED is not ON	<ul style="list-style-type: none"><li>• Press the  button to check if the monitor is in the ON mode.</li><li>• Check if the power cord is properly connected to the monitor and the power outlet.</li><li>• Check if the power switch is ON.</li></ul>
The power LED lights amber and there is no screen image	<ul style="list-style-type: none"><li>• Check if the monitor and the computer are in the ON mode.</li><li>• Make sure the signal cable is properly connected the monitor and the computer.</li><li>• Inspect the signal cable and make sure none of the pins are bent.</li><li>• Connect the computer with another available monitor to check if the computer is properly working.</li></ul>
Screen image is too light or dark	<ul style="list-style-type: none"><li>• Adjust the Contrast and Brightness settings via OSD.</li></ul>
Screen image bounces or a wave pattern is present in the image	<ul style="list-style-type: none"><li>• Make sure the signal cable is properly connected to the monitor and the computer.</li><li>• Move electrical devices that may cause electrical interference.</li></ul>
Screen image has color defects (white does not look white)	<ul style="list-style-type: none"><li>• Inspect the signal cable and make sure that none of the pins are bent.</li><li>• Perform All Reset via OSD.</li><li>• Adjust the R/G/B color settings or select the Color Temperature via OSD.</li></ul>
No sound or sound is low	<ul style="list-style-type: none"><li>• Ensure that the HDMI/DisplayPort/USB Type C cable is properly connected to the monitor and the computer.</li><li>• Adjust the volume settings of both your monitor and HDMI/DisplayPort/USB Type C device.</li><li>• Ensure that the computer sound card driver is properly installed and activated.</li></ul>

### 3.5 Supported operating modes

Resolution Frequency	Horizontal Frequency (KHz)	Vertical Frequency (Hz)	Pixel (MHz)
640 x 480	37.47(P)	59.94(N)	25.18
800 x 600	35.16(P)	56.25(P)	36
800 x 600	37.88(P)	60.32(P)	40
848 x 480	31.0(P)	60(P)	33.75
1024 x 768	48.36(N)	60.00(N)	65
1280 x 720	44.77(N)	60	74.5
1280 x 768	47.8(N)	60(N)	79.5
1280 x 800	49.7(N)	60(P)	84.5
1280 x 960	60.00(P)	60.00(N)	108
1280 x 1024	63.98(P)	60.02(P)	108
1366 x 768	47.712(P)	59.79(P)	85.5
1400 x 1050	65.3(N)	60(P)	121.75
1440 x 900	55.94(N)	59.89(P)	106.5
1600 x 1200	75.00(P)	60.00(P)	162
1680 x 1050	65.29(N)	60.00(P)	146.25
1920 x 1080	67.5(P)	60.00(P)	148.5
1920 x1200 (Reduced Blanking)	74.038(P)	59.95(N)	154
1920 x1200	74.556(N)	59.885(P)	193.25
2560x1080	66.636(P)	59.978(N)	181.25
2560 x1440	87.787(P)	59.951(N)	241.5
3840 x2160	52.593(N)	24(P)	266.75
3840 x2160	54.786(N)	25	278.75
3840 x2160	67.5(P)	30(P)	297
3840 x2160	111.174(N)	50(P)	587
3840 x2160 (Reduced Blanking)	133.313(P)	60(N)	533.25
3840 x2160	135.0(N)	60.0(N)	594

“P” / “N” stands for “Positive” / “Negative” polarity of incoming H-sync/V-sync (input timing).

**When the monitor is operating in the video mode (ie, not displaying data), the following high definition modes shall be supported in addition to standard definition video.**

<b>Resolution</b>	<b>Vertical Frequency (Hz)</b>
1920 x 1080p	24Hz
	25Hz
	30Hz
	50Hz
	59.94Hz
	60Hz
1920 x 1080i	50Hz
	59.94Hz
	60Hz
1440 x 480p	59.94Hz
	60Hz
1440 x 576p	50Hz
1280 x 720p	50Hz
	59.94Hz
720 x 576p	60Hz
	50Hz
720 x 480p	59.94Hz
	60Hz
640 x 480p(VGA)	59.94Hz
	60Hz
720(1440) x 576i	50Hz
720(1440) x 480i	59.94Hz
	60Hz