



Questo manuale d'istruzione è fornito da trovaprezzi.it. Scopri tutte le offerte per [Asus ROG Strix XG349C](#) o cerca il tuo prodotto tra le [migliori offerte di Monitor](#)



Questo manuale d'istruzione è fornito da trovaprezzi.it. Scopri tutte le offerte per [Asus ROG Strix XG349C](#) o cerca il tuo prodotto tra le [migliori offerte di Monitor](#)



REPUBLIC OF
GAMERS

ROG STRIX

XG349C

CURVED GAMING MONITOR

ASUS

Copyright © 2021 ASUSTeK COMPUTER INC. All Rights Reserved.

No part of this manual, including the products and software described in it, may be reproduced, transmitted, transcribed, stored in a retrieval system, or translated into any language in any form or by any means, except documentation kept by the purchaser for backup purposes, without the express written permission of ASUSTeK COMPUTER INC. ("ASUS").

Product warranty or service will not be extended if: (1) the product is repaired, modified or altered, unless such repair, modification or alteration is authorized in writing by ASUS; or (2) the serial number of the product is defaced or missing.

ASUS PROVIDES THIS MANUAL "AS IS" WITHOUT WARRANTY OF ANY KIND, EITHER EXPRESS OR IMPLIED, INCLUDING BUT NOT LIMITED TO THE IMPLIED WARRANTIES OR CONDITIONS OF MERCHANTABILITY OR FITNESS FOR A PARTICULAR PURPOSE. IN NO EVENT SHALL ASUS, ITS DIRECTORS, OFFICERS, EMPLOYEES OR AGENTS BE LIABLE FOR ANY INDIRECT, SPECIAL, INCIDENTAL, OR CONSEQUENTIAL DAMAGES (INCLUDING DAMAGES FOR LOSS OF PROFITS, LOSS OF BUSINESS, LOSS OF USE OR DATA, INTERRUPTION OF BUSINESS AND THE LIKE), EVEN IF ASUS HAS BEEN ADVISED OF THE POSSIBILITY OF SUCH DAMAGES ARISING FROM ANY DEFECT OR ERROR IN THIS MANUAL OR PRODUCT.

SPECIFICATIONS AND INFORMATION CONTAINED IN THIS MANUAL ARE FURNISHED FOR INFORMATIONAL USE ONLY, AND ARE SUBJECT TO CHANGE AT ANY TIME WITHOUT NOTICE AND SHOULD NOT BE CONSTRUED AS A COMMITMENT BY ASUS. ASUS ASSUMES NO RESPONSIBILITY OR LIABILITY FOR ANY ERRORS OR INACCURACIES THAT MAY APPEAR IN THIS MANUAL, INCLUDING THE PRODUCTS AND SOFTWARE DESCRIBED IN IT.

Products and corporate names appearing in this manual may or may not be registered trademarks or copyrights of their respective companies, and are used only for identification or explanation and to the owners' benefit, without intent to infringe.

Table of Contents

Notices	iv
Safety information.....	v
Care & Cleaning	viii
1.1 Welcome!.....	1- 1
1.2 Package Contents.....	1- 1
1.3 Assembling the Monitor	1-2
1.4 Connect Cables.....	1-4
1.4.1 Rear of the LCD Monitor	1-4
1.5 Monitor Introduction.....	1-5
1.5.1 Using the Control Buttons	1-5
1.5.2 GamePlus Function.....	1-7
1.5.3 GameVisual Function.....	1-8
2.1 Detaching the Stand (for VESA Wall Mount).....	2- 1
2.2 Adjusting the Monitor	2-3
3.1 OSD (On-Screen Display) Menu.....	3- 1
3.1.1 How to Reconfigure	3- 1
3.1.2 OSD Function Introduction.....	3-2
3.2 Aura.....	3- 10
3.3 Specifications.....	3- 11
3.4 Troubleshooting (FAQ).....	3- 12
3.5 Supported Timing List.....	3- 13

Notices

Federal Communications Commission Statement

This device complies with Part 15 of the FCC Rules. Operation is subject to the following two conditions:

- This device may not cause harmful interference.
- This device must accept any interference received including interference that may cause undesired operation.

This equipment has been tested and found to comply with the limits for a Class B digital device, pursuant to Part 15 of the FCC Rules. These limits are designed to provide reasonable protection against harmful interference in a residential installation. This equipment generates, uses and can radiate radio frequency energy and, if not installed and used in accordance with the instructions, may cause harmful interference to radio communications. However, there is no guarantee that interference will not occur in a particular installation. If this equipment does cause harmful interference to radio or television reception, which can be determined by turning the equipment off and on, the user is encouraged to try to correct the interference by one or more of the following measures:

- Reorient or relocate the receiving antenna.
- Increase the separation between the equipment and receiver.
- Connect the equipment to an outlet on a circuit different from that to which the receiver is connected.
- Consult the dealer or an experienced radio/TV technician for help.



WARNING: The use of shielded cables for connection of the monitor to the graphics card is required to assure compliance with FCC regulations. Changes or modifications to this unit not expressly approved by the party responsible for compliance could void the user's authority to operate this equipment.

Canadian Department of Communications Statement

This digital apparatus does not exceed the Class B limits for radio noise emissions from digital apparatus set out in the Radio Interference Regulations of the Canadian Department of Communications.

This class B digital apparatus complies with Canadian ICES-003.

This Class B digital apparatus meets all requirements of the Canadian Interference-Causing Equipment Regulations.

Cet appareil numérique de la classe B respecte toutes les exigences du Règlement sur le matériel brouilleur du Canada.

Safety information

- Before setting up the monitor, carefully read all the documentation that came with the package.
- To prevent fire or shock hazard, never expose the monitor to rain or moisture.
- Never try to open the monitor cabinet. The dangerous high voltages inside the monitor may result in serious physical injury.
- If the power supply is broken, do not try to fix it by yourself. Contact a qualified service technician or your retailer.
- Before using the product, make sure all cables are correctly connected and the power cables are not damaged. If you detect any damage, contact your dealer immediately.
- Slots and openings on the back or top of the cabinet are provided for ventilation. Do not block these slots. Never place this product near or over a radiator or heat source unless proper ventilation is provided.
- The monitor should be operated only from the type of power source indicated on the label. If you are not sure of the type of power supply to your home, consult your dealer or local power company.
- Use the appropriate power plug which complies with your local power standard.

- Do not overload power strips and extension cords. Overloading can result in fire or electric shock.
- Avoid dust, humidity, and temperature extremes. Do not place the monitor in any area where it may become wet. Place the monitor on a stable surface.
- Unplug the unit during a lightning storm or if it will not be used for a long period of time. This will protect the monitor from damage due to power surges.
- Never push objects or spill liquid of any kind into the slots on the monitor cabinet.
- To ensure satisfactory operation, use the monitor only with UL listed computers which have appropriate configured receptacles marked between 100 ~ 240V AC.
- The socket-outlet shall be installed near the equipment and shall be easily accessible.
- If you encounter technical problems with the monitor, contact a qualified servicer.
- Provide an earthing connection before the mains plug is connected to the mains. And, when disconnecting the earthing connection, be sure to disconnect after pulling out the mains plug from the mains.
- Please use ADP-120VH BE adapter.
- If provided with a 3-pin attachment plug on the power cord, plug the cord into a grounded (earthed) 3-pin outlet. Do not disable the power cord grounding pin, for example, by attaching a 2-pin adapter. The grounding pin is an important safety feature.

Stability Hazard

- The product may fall, causing serious personal injury or death. To prevent injury, this product must be securely attached to the floor/wall in accordance with the installation instructions.
- A product may fall, causing serious personal injury or death. Many injuries, particularly to children, can be avoided by taking simple precautions such as:
- ALWAYS use cabinets or stands or installation methods recommended by the manufacturer of the product set.

- ALWAYS use furniture that can safely support the product.
- ALWAYS ensure the product is not overhanging the edge of the supporting furniture.
- ALWAYS educate children about the dangers of climbing on furniture to reach the product or its controls.
- ALWAYS route cords and cables connected to your product so they cannot be tripped over, pulled or grabbed.
- NEVER place a product in an unstable location.
- NEVER place the product on tall furniture (for example, cupboards or bookcases) without anchoring both the furniture and the product to a suitable support.
- NEVER place the product on cloth or other materials that may be located between the product and supporting furniture.
- NEVER place items that might tempt children to climb, such as toys and remote controls, on the top of the product or furniture on which the product is placed.
- If the existing product is going to be retained and relocated, the same considerations as above should be applied.



WARNING: Usage of other than specified head- or earphones can result in hearing loss due to excessive sound pressures.

Restriction on Hazardous Substances statement (India)

This product complies with the “India E-Waste (Management) Rules, 2016” and prohibits use of Lead, Mercury, Hexavalent Chromium, polybrominated biphenyls(PBBs) and polybrominated diphenyl ethers(PBDEs) in concentration exceeding 0.1% by weight in homogenous materials and 0.01% by weight in homogenous materials for cadmium, except of exemptions listed in Schedule 2 of the Rule.

HDMI
HIGH-DEFINITION MULTIMEDIA INTERFACE

EAC

Prevent Tipping

When using the display, fasten the LCD to a wall using a cord or chain that can support the weight of the monitor in order to prevent the monitor from falling.

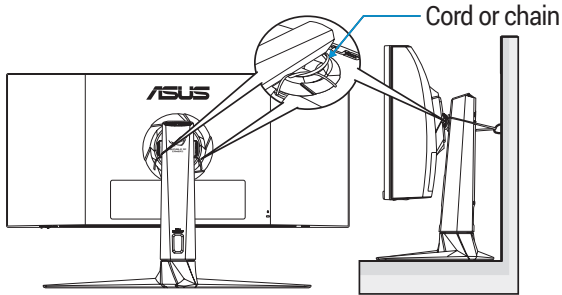

- Display design may differ from those illustrated.
- Installing must be done by a qualified technician , and please contact your supplier for more information.
- For the Models with net weight $\geq 7\text{kg}$. Please select the suitable way to Prevent Tipping.
- Please use the method discribed in the above image to tie the cord or chain to the stand and then fix it to the wall.

Care & Cleaning

- Before you lift or reposition your monitor, it is better to disconnect the cables and power cord. Follow the correct lifting techniques when positioning the monitor. When lifting or carrying the monitor, grasp the edges of the monitor. Do not lift the display by the stand or the cord.
- Cleaning. Turn your monitor off and unplug the power cord. Clean the monitor surface with a lint-free, non-abrasive cloth. Stubborn stains may be removed with a cloth dampened with mild cleaner.
- Avoid using a cleaner containing alcohol or acetone. Use a cleaner intended for use with the LCD. Never spray cleaner directly on the screen, as it may drip inside the monitor and cause an electric shock.



This symbol of the crossed out wheeled bin indicates that the product (electrical, electronic equipment, and mercury-containing button cell battery) should not be placed in municipal waste.

Please check local regulations for disposal of electronic products.

AEEE yönetmeliğine uygundur

The following symptoms are normal with the monitor:

- The screen may flicker during the initial use due to the nature of the fluorescent light. Turn off the Power Switch and turn it on again to make sure that the flicker disappears.
- You may find slightly uneven brightness on the screen depending on the desktop pattern you use.
- When the same image is displayed for hours, an afterimage of the previous screen may remain after switching the image. The screen will recover slowly or you can turn off the Power Switch for hours.
- When the screen becomes black or flashes, or cannot work anymore, contact your dealer or service center to fix it. Do not repair the screen by yourself!

Conventions used in this guide



WARNING: Information to prevent injury to yourself when trying to complete a task.



CAUTION: Information to prevent damage to the components when trying to complete a task.



IMPORTANT: Information that you **MUST** follow to complete a task.



NOTE: Tips and additional information to aid in completing a task.

Where to find more information

Refer to the following sources for additional information and for product and software updates.

1. ASUS websites

The ASUS websites worldwide provide updated information on ASUS hardware and software products. Refer to <http://www.asus.com>

2. Optional documentation

Your product package may include optional documentation that may have been added by your dealer. These documents are not part of the standard package.

1.1 Welcome!

Thank you for purchasing the ASUS® LCD monitor!

The latest widescreen LCD monitor from ASUS provides a crisper, broader, and brighter display, plus a host of features that enhance your viewing experience.

With these features, you can enjoy the convenience and delightful visual experience that the monitor brings to you!

1.2 Package Contents

Check your package for the following items:

- ✓ LCD Monitor
- ✓ Monitor Stand
- ✓ Monitor Base
- ✓ Quick Start Guide
- ✓ Warranty Card
- ✓ 1x Power Cord
- ✓ 1x HDMI Cable
- ✓ 1x DP Cable
- ✓ 1x Power Adapter
- ✓ 1x USB 3.0 Cable
- ✓ 1x USB-C Cable
- ✓ ROG Sticker
- ✓ VESA Cover
- ✓ VESA Kits
- ✓ Color Calibration data report



-
- If any of the above items is damaged or missing, contact your retailer immediately.
-

1.3 Assembling the Monitor

To assemble the monitor:



- While assembling the monitor arm/base, we recommend that you keep the monitor inside its EPS (Expanded Polystyrene) packaging.

1. Take out all accessory from the upside EPS.

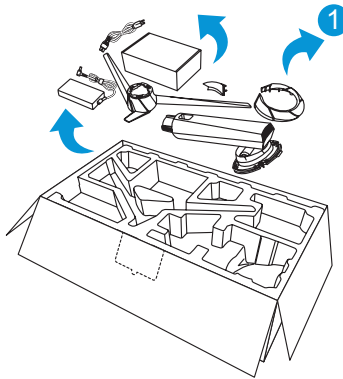

2. Take out upside EPS from carton box.
3. Push open stand assembly hole.

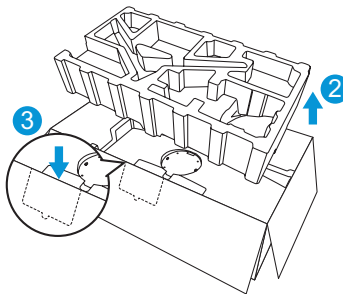

4. Align the screw holes on the monitor with the bundled screws on the arm.
5. Install the arm to the monitor and fix by fastening the four (4) bundled screws.

- Cover the VESA cover.

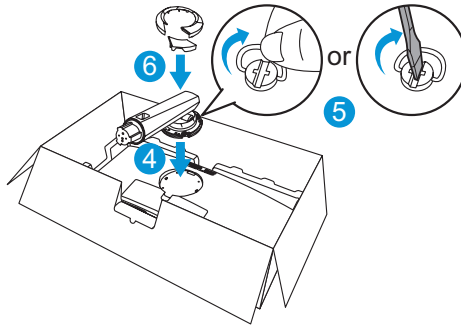

- Align and install the base to the arm.
- Fix the base to the arm by fastening the two (2) bundled screws.

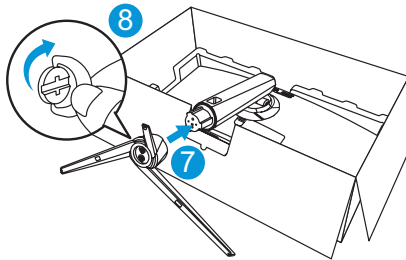

- Remove the monitor from its EPS packaging.

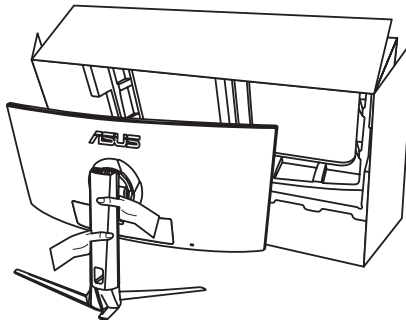

- Please do not hold the panel, we recommend hold the monitor stand to pick up monitor.
- Base screw size is M6 x 15 mm.

Adjust the monitor to the angle that is most comfortable for you.

1.4 Connect Cables

1.4.1 Rear of the LCD Monitor

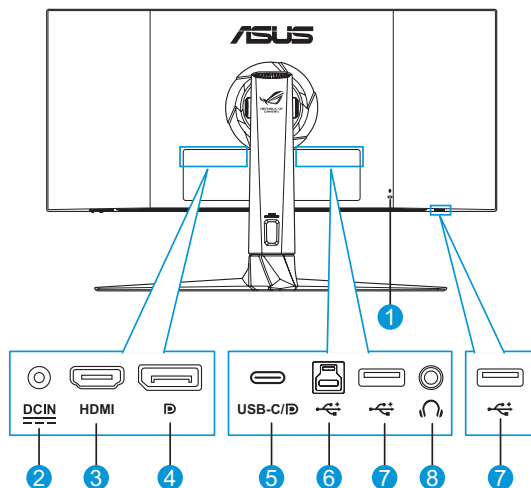



1. Kensington Lock
2. DC-IN Port
3. HDMI Port
4. DisplayPort
5. USB C/DP Port (PD 5V/3A or 9V/2A)
6. USB3.0 Upstream Port
7. USB3.0 Downstream Ports (x2)
8. Earphone Jack

1.5 Monitor Introduction

1.5.1 Using the Control Buttons

Use control buttons on the bottom of the monitor to adjust the monitor settings.



- Press the Input Select  button or the  button to call out the quick OSD menu.

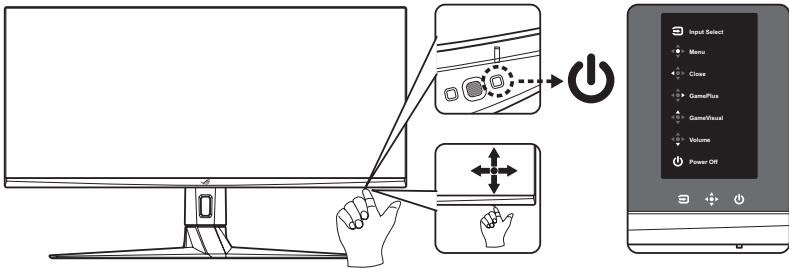

1. Power Indicator:

- The color definition of the power indicator is as the table below.



Status	Description
White	ON
Amber	Standby mode
OFF	OFF

2. Power Button:

- Press this button to turn the monitor on/off.

3. Navigation Button:

- Turn on the OSD menu. Enact the selected OSD menu item.
- Increase/Decrease values or moves your selection up/down/left/right.
-  Close Button: Exit the OSD menu or move to the previous menu.

-  **GamePlus Button:** This is a shortcut key. The default setting is GamePlus.
 - Activate Crosshair, Timer, FPS Counter, or Display Alignment function.
 - Move the  button up/down to select and press  to confirm the function needed.





-
- For more information on GamePlus function, refer to [page 1-7](#).
-



-  **GameVisual Button:** This is a shortcut key. The default setting is GameVisual.
 - Switch from eight video preset modes (Scenery Mode, Racing Mode, Cinema Mode, RTS/RPG Mode, FPS Mode, sRGB Mode, MOBA Mode, and User Mode) with GameVisual™ Video Intelligence Technology.



-
- For more information on GameVisual function, refer to [page 1-8](#).
-

-  **Volume Button:** This is a shortcut key. The default setting is Volume. Move the  button up/down to adjust the volume level.

4. **Input Select Button:**



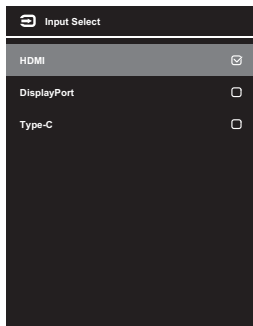







- This is a shortcut key. The default setting is Input Select. Move the  button up/down to select the input source from HDMI > DisplayPort > Type-C. Then press  to confirm.



1.5.2 GamePlus Function

The GamePlus function provides a toolkit and creates a better gaming environment for users when playing different types of games. The crosshair overlay with four different crosshair options lets you choose the one that best suits the game you are playing. There is also an onscreen timer you can position on the left of the display so you can keep track of the elapsed gaming time; while the FPS (frames per second) counter lets you know how smooth the game is running. Display Alignment displays alignment lines on 4 sides of the screen, serving as an easy and handy tool for you to line up multiple monitors perfectly.

To active GamePlus:

1. Press the  or Input Select  button to display the quick OSD menu.
2. Press the GamePlus hotkey .
3. Move the  button up/down to select among different functions.
4. Press the  button or move the  button right to confirm the function you choose, and move the  button up/down to navigate through the settings. Move the  button left to go back, off, or exit.
5. Highlight the desired setting and press the  button to activate it. Press the Input Select  button to inactivate it.

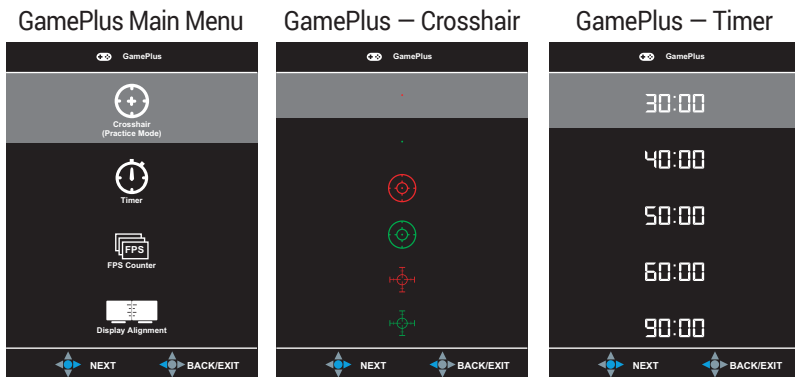

GamePlus – FPS Counter

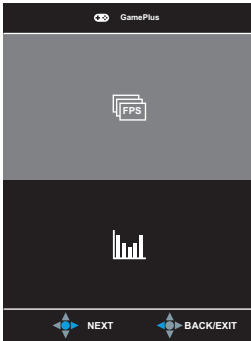

1.5.3 GameVisual Function

The GameVisual function helps you select among different picture modes in a convenient way.

To active GameVisual:

Press the GameVisual hotkey repeatedly to select.

- **Scenery Mode:** This is the best choice for scenery photo displaying with GameVisual™ Video intelligence Technology.
- **Racing Mode:** This is the best choice for racing game playing with GameVisual™ Video intelligence Technology.
- **Cinema Mode:** This is the best choice for movie watching with GameVisual™ Video intelligence Technology.
- **RTS/RPG Mode:** This is the best choice for Real-Time Strategy (RTS)/ Role-Playing Game (RPG) playing with GameVisual™ Video intelligence Technology.
- **FPS Mode:** This is the best choice for First Person Shooter game playing with GameVisual™ Video intelligence Technology.
- **sRGB Mode:** This is the best choice for viewing photos and graphics from PCs.

- **MOBA Mode:** This is the best choice for Multiplayer Online Battle Arena (MOBA) games playing with GameVisual™ Video intelligence Technology.
- **User Mode:** More items are adjustable in the Color menu.



-
- In the Racing Mode, the Saturation, Sharpness, and ASCR functions are not user-configurable.
 - In the sRGB, the Saturation, Color Temp., Sharpness, Brightness, Contrast, and ASCR functions are not user-configurable.
 - In the MOBA Mode, the Saturation and ASCR functions are not user-configurable.
-

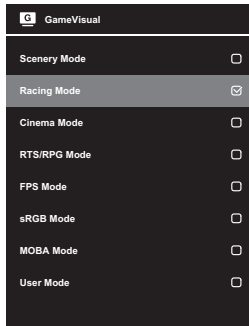

2.1 Detaching the Stand (for VESA Wall Mount)



-
- Avoid damaging the monitor surface. While detaching the monitor stand, always keep the monitor inside its EPS packaging.
-

The detachable stand of this monitor is specially designed for VESA wall mount.

1. Disconnect power and signal cables. Carefully put the monitor facedown on its EPS packaging.
2. Remove the covers on where the monitor and the arm meet.
3. Loosen the four (4) bundled screws securing the arm to the rear of the monitor.
4. Detach the stand (arm and base) from the monitor.
5. Attach the four screw standoffs to the respective screw holes on the rear of the monitor.
6. Secure the wall mount bracket to the monitor with the four (4) screws.

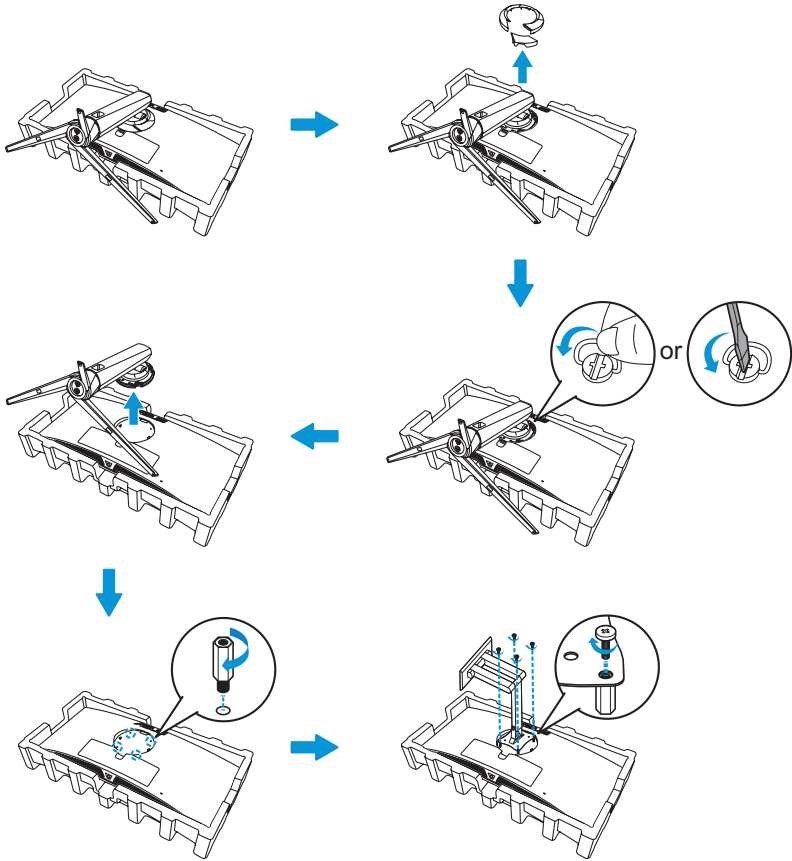

- The VESA wall mount kit (100 x 100 mm) is purchased separately.
- Use only the UL Listed Wall Mount Bracket with minimum weight/load 22.7kg (screw size is M4 x 10 mm).

2.2 Adjusting the Monitor

- For optimal viewing, we recommend that you look at the full face of the monitor, then adjust the monitor to the angle that is most comfortable for you.
- Hold the stand to prevent the monitor from falling when you change its angle.
- You can adjust the monitor's angle from -5° to 20° and it allows 25° swivel adjustment from either left or right. You can also adjust the monitor's height within ± 10 cm.

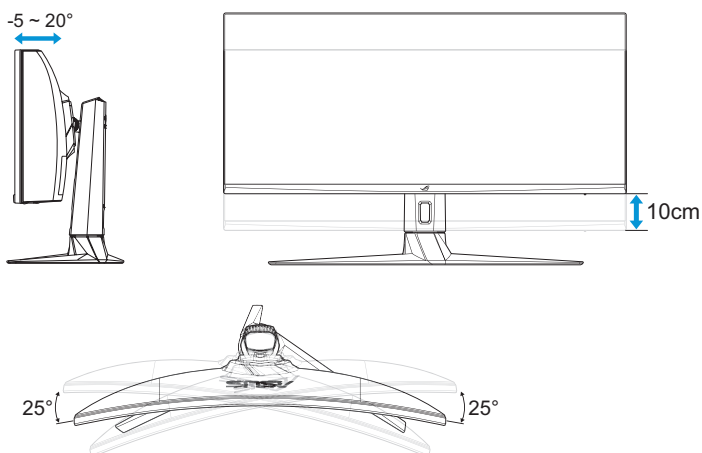

-
- It is normal that the monitor slightly shakes while you adjust the viewing angle.
-

3.1 OSD (On-Screen Display) Menu

3.1.1 How to Reconfigure

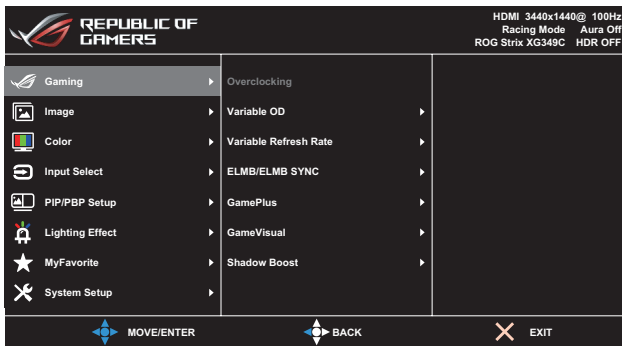

1. Press the button or Input Select button to display the quick OSD menu.
2. Press the button to activate the OSD menu.
3. Move the button up/down to navigate through the functions. Highlight the desired function and press the button or move the button right to enter its sub-menu. In submenu, move the button up/down again to navigate through the sub-menu functions. Highlight the desired sub-menu function and press the button to select an option or move the button up/down to adjust the setting.
4. Move the button up/down to change the settings of the selected function.
5. To exit and save the OSD menu, press the Input Select button or move the button left repeatedly until the OSD menu disappears. To adjust other functions, repeat steps 1 to 4.

3.1.2 OSD Function Introduction

1. Gaming

Configure your gaming preferences.

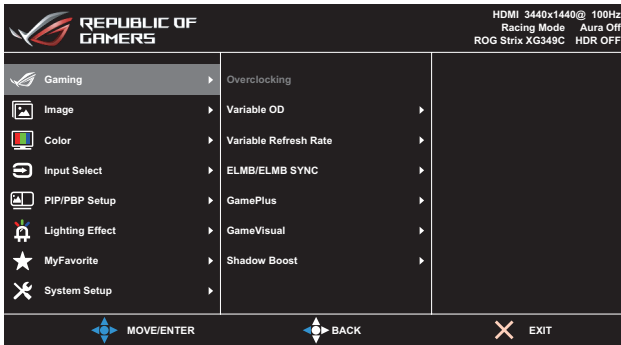

- **Overclocking:** Allows to adjust the refresh rate.

 - Overclocking is available only if the input source is DisplayPort.



- **Variable OD:** Speeds up the response time by Over Drive technology. Including **Level 0~Level 5**.
- **Variable Refresh Rate:** Allows a Variable Refresh Rate supported graphics source to dynamically adjust display refresh rate based on typical content frame rates for power efficient, virtually stutter free and low-latency display update.



- To activate Variable Refresh Rate, turn off ELMB function first.
- Variable Refresh Rate can only be activated within:
 - HDMI source: 48Hz ~ 100Hz
 - Type C source: 48Hz ~ 120Hz
 - DisplayPort source: 48Hz ~ 144Hz
 - DisplayPort OverClocking source: 48Hz ~ 180Hz
- **ELMB/ELMB SYNC:** Extreme Low Motion Blur. Decreases motion blur and minimizes ghosting part when on-screen objects are fast moving.



- To activate ELMB, turn off Variable Refresh Rate function first.
- If ELMB is enabled, the Adaptive-Sync, PIP/PBP Mode, Dynamic Dimming, and ASCR functions will be disabled.
- ELMB is disabled if input V frequency is less than 75Hz.

- **GamePlus:** Configures the gaming environment. For more information, refer to pages 1-7 and 1-8.
- **GameVisual:** Selects the picture mode. For more information, refer to pages 1-8 and 1-9.
- **Shadow Boost:** Adjusts the monitor gamma curve to enrich the dark tones in an image making dark scenes and objects much easier be found. Available options: **OFF, Level 1~ Level 3.**

2. Image

Configure the image parameters.

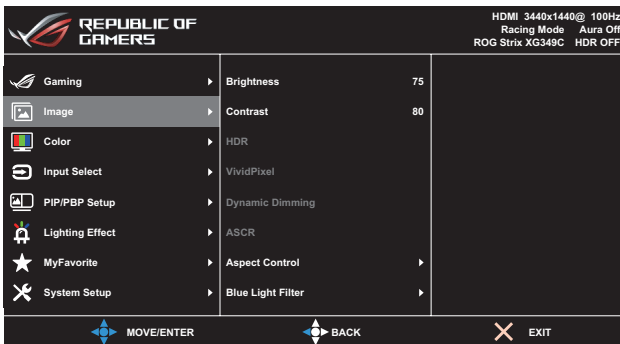

- **Brightness:** Adjusts the brightness level. The adjusting range is from **0** to **100**.
- **Contrast:** Adjusts the contrast level. The adjusting range is from **0** to **100**.
- **HDR:** High Dynamic Range. Contains several HDR modes. The HDR mode is selectable when input video is correct HDR source.
- **VividPixel:** ASUS Exclusive Technology that brings lifelike visuals for crystal-clear and detail-oriented enjoyment. The adjusting range is from **0** to **100**.

- **Dynamic Dimming:** Synchronizes with contents while contrast changing to execute backlight dynamic dimming.
- **ASCR:** Select **ON** or **OFF** to enable or disable dynamic contrast ratio function.



-
- ASCR is not available if the Dynamic Dimming function is enabled.
-

- **Aspect Control:** Adjusts the aspect ratio to **Full**, **4:3**, **16:9 (24"W)**, and **16:9 (27"W)**.



-
- Select 4:3 to display the picture according to the original aspect ratio of the input source.
-

- **Blue Light Filter:** Reduces the energy level of blue light emitted from LED backlight. To turn off the Blue Light Filter, select **Level 0**.



-
- When Blue Light Filter is activated, the default settings of Racing Mode will be automatically imported.
 - Between Level 1 to Level 3, the Brightness function is user-configurable.
 - Level 4 is optimized setting. It is compliance with TUV Low Blue Light Certification. The Brightness function is not user-configurable.
-



Please refer to the following to alleviate eye strains:

- Users should take some time away from the display if working for long hours. It is advised to take short breaks (at least 5 mins) after around 1 hour of continuous working at the computer. Taking short and frequent breaks is more effective than a single longer break.
 - To minimize eye strain and dryness in your eyes, users should rest the eye periodically by focusing on objects that are far away.
 - Eye exercises can help to reduce eye strain. Repeat these exercises often. If eye strain continues please consult a physician. Eye exercises: (1) Repeating look up and down (2) Slowly roll your eyes (3) Move your eyes diagonal.
 - High energy blue light may lead to eye strain and AMD (Age-Related Macular Degeneration). Blue light filter to reduce 70% (max.) harmful blue light to avoiding CVS (Computer Vision Syndrome).
-

3. Color

Select the image color you like from this menu.

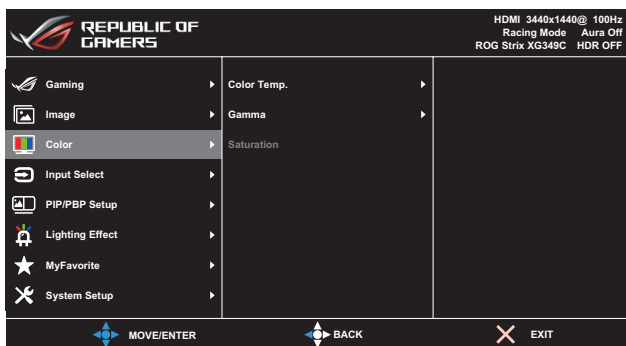

- **Color Temp.:** Selects the desired color temperature. Available options: **Cool, Normal, Warm, and User Mode.**



- In the User Mode, colors of R (Red), G (Green), and B (Blue) are user-configurable; the adjusting range is from 0 to 100.

- **Gamma:** Sets the color mode to **1.8, 2.2, or 2.5.**
- **Saturation:** Adjusts the saturation level. The adjusting range is from **0 to 100.**

4. Input Select

Select the input source:

- **HDMI, DisplayPort, and Type-C**

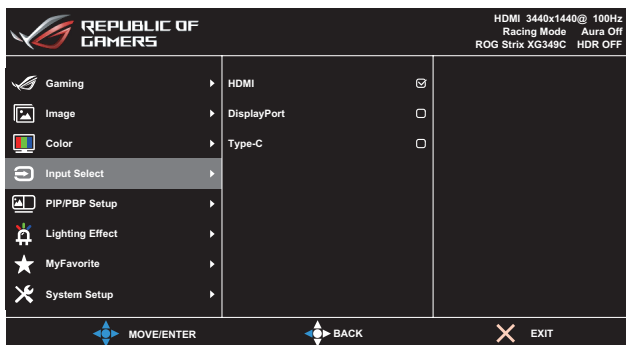

5. PIP/PBP Setup

Configure the multi-picture related settings.

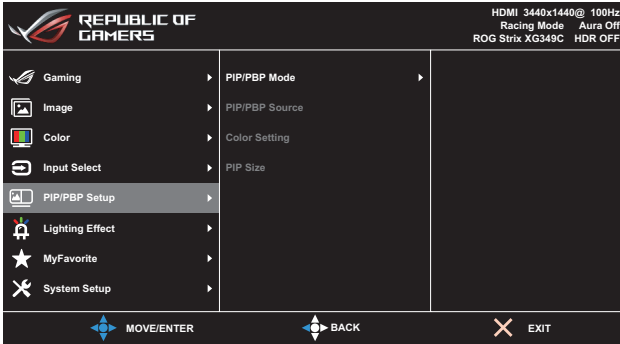

- **PIP/PBP Mode:** Select your preferred PIP/PBP mode or disable the function.
- **PIP/PBP Source:** Selects the video input source among, **HDMI**, **DisplayPort**, and **Type-C**.
- **Color Setting:** Sets GameVisual mode for each PIP/PBP window.
- **PIP Size:** Adjusts the PIP size to **Small**, **Middle**, or **Large**.

6. Lighting Effect

Configure the lighting effect parameters.

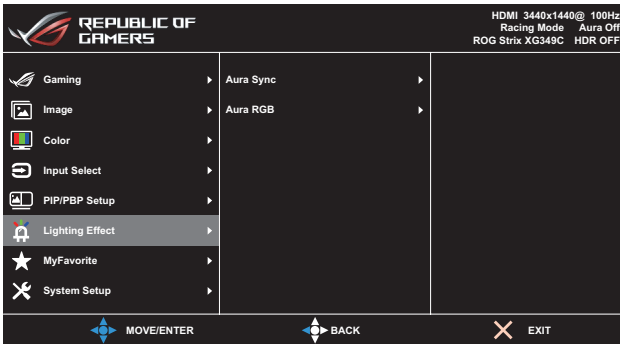

- **Aura Sync:** Allows you to turn on or off the Aura Sync function that synchronizes the Aura RGB light effect among all supported devices.
- **Aura RGB:** Sets the Aura RGB light pattern on the rear of the monitor. Available options: **Color Cycle**, **Static**, **Breathing**, **Strobing**, and **OFF**.



- For Aura RGB patterns, such as Static, Breathing, and Strobing you can set your preferred color. The color options include red (R), green (G), blue (B), cyan (C), magenta (M), and yellow (Y).
- If the Aura Sync function is turned ON, the Aura RGB function will become unavailable.
- See page 3-10 for information on how to customize Aura light effects from your computer.

7. MyFavorite

You can adjust Shortcut and Customized Setting from this main function.

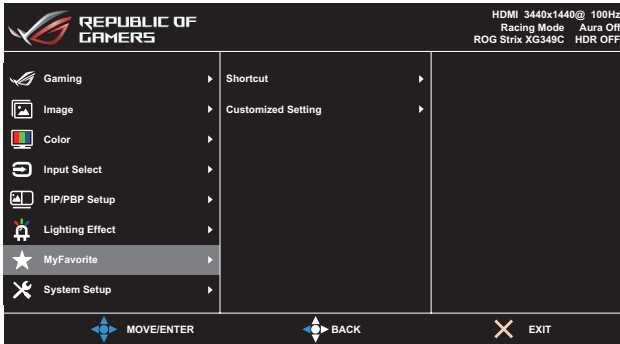

- **Shortcut:** User can select from **GamePlus**, **GameVisual**, **Brightness**, **Contrast**, **PIP/PBP Setup**, **Input Select**, **HDR**, **Blue Light Filter**, **Color Temp.**, **Volume**, **KVM**, **MyFavorite-1 (Load)**, **MyFavorite-2 (Load)** and set as shortcut key.
- **Customized Setting:** You can do your setting according to your preference.

8. System Setup

Adjust the system configuration.

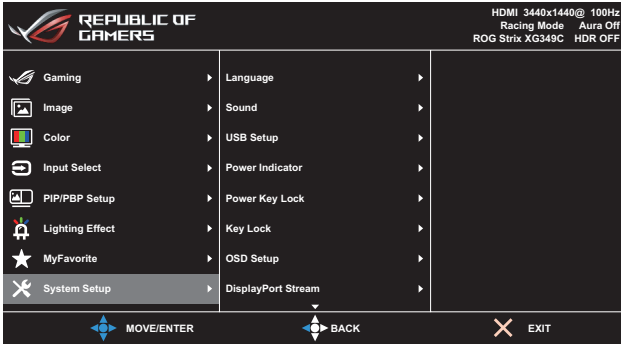

(Page 1/2)

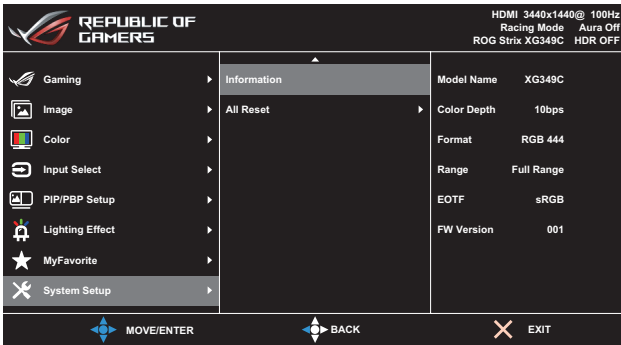

(Page 2/2)

- **Language:** Selects an available language for the OSD menu. The options include **English, French, German, Spanish, Italian, Dutch, Russian, Polish, Czech, Croatian, Hungarian, Romanian, Portuguese, Turkish, Simplified Chinese, Traditional Chinese, Japanese, Korean, Thai, Indonesian, and Persian.**
- **Sound:**
 - **Volume:** Adjusts the volume level from **0** to **100**.
 - **Mute:** If checked, mutes the volume.

- **USB Setup:**
 - **KVM:** Switches USB downstream port to USB-C or USB-B upstream port.
 - **Type-C Bandwidth:** Select USB Type-C with USB 2.0 or USB 3.1. USB 3.1 is up to 3440x1440-60Hz.
 - **USB Hub:** Sets the USB Hub operation to **On During Standby** (USB Type A ports on the LCD monitor can be used for charging a USB device during standby) or **Off During Standby** (USB Type A ports cannot be used for charging a USB device during standby).



-
- When using the Type B to Type A USB cable, it can be connected between upstream- and downstream-facing ports for USB devices such as keyboard, mouse, or flash drive.
-

- **Power Indicator:** Turns the power LED indicator on/off.
- **Power Key Lock:** Disables or enables the power key.
- **Key Lock:** Pressing down the  button for more than five seconds to activate or deactivate the key lock function.
- **OSD Setup:** Adjusts the **OSD Timeout, DDC/CI, and Transparency** of the OSD screen.
- **DisplayPort Stream:** Select **DP 1.1** if your graphics card is not compatible with **DP 1.4**.
- **Information:** Displays the monitor information.
- **All Reset:** Select **YES** to revert all settings to the factory default mode.

3.2 Aura

Armoury Crate is a software program that controls the colorful LEDs on supported devices, such as monitors, motherboards, graphic cards, desktop PCs, etc. Aura allows you to adjust the color of the RGB LEDs on these devices and select different light effects. You can also correct or adjust the color of the LEDs by calibrating them.

To activate Aura:

1. Turn ON the **Aura Sync** function in the OSD menu.
2. Connect the USB 3.0 upstream port of the monitor to the USB port of your computer.
3. Install Armoury Crate and then restart the computer.
4. Execute Armoury Crate.

Below is the overview of this program.

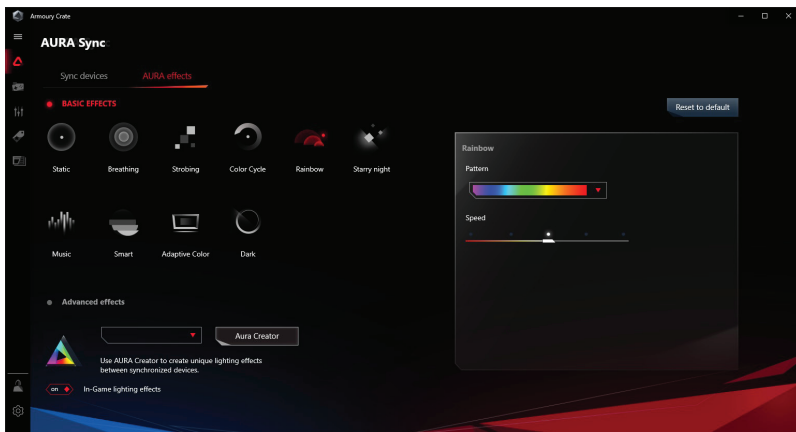

- If the USB upstream connection between the monitor and computer is disconnected, to resume the Aura function, you need to re-connect the USB 3.0 upstream port of the monitor to the computer and then restart the computer.
- Visit https://rog.asus.com/innovation/armoury_crate/ for more details.

3.3 Specifications

Model	XG349C
Panel Size	34.14" W (86.72cm)
Max. Resolution	3440x1440
Brightness (Typ.)	400 nits (typical)
Contrast Ratio (Typ.)	1000:1
Viewing Angle (CR≤10)	178°(H)/178°(V)
Display Colors	1.07B
Response Time	1ms (G to G)
Sound from HDMI	Yes
HDMI Input	Yes
DisplayPort Input	Yes
PIP/PBP	Yes
USB3.0 Port	Upstream x1, Downstream x2 (USB port without power charger when upstream no link)
USB-C Port	Yes
Earphone	Yes
Power ON consumption	<40W (Measuring a screen brightness of 200 nits without audio/ USB/Card reader connection)
Chassis Colors	Black
Power Saving Mode	< 0.5W
Power Off Mode	< 0.3W
Tilt	-5° ~ +20°
Phys. Dimension with Stand (WxHxD)	815 x (511.0~411.0) x 279 mm
Phys. Dimension without Stand (WxHxD)	815 x 366 x 142 mm
Box Dimension (WxHxD)	887 x 469 x 329 mm
Net Weight (Esti.)	9.2 kg
Gross Weight (Esti.)	13.4 kg
Voltage Rating	Adapter 20Vdc, 6A
Temperature	Operating temperature: 0~40°C Storage temperature: -30~65°C

*Specifications subject to change without notice.

3.4 Troubleshooting (FAQ)

Problem	Possible Solution
Power LED is not ON	<ul style="list-style-type: none">• Press the  button to check if the monitor is turned on.• Check if the adapter and power cord are properly connected to the monitor and the power outlet.• Check the Power Indicator function in the OSD menu. Select "ON" to turn on the power LED.
The power LED lights white and there is no screen image	<ul style="list-style-type: none">• Check if the monitor and the computer are turned on.• Make sure the signal cable is properly connected to the monitor and the computer.• Inspect the signal cable and make sure none of the pins are bent.• Connect the computer with another available monitor to check if the computer is properly working.
Screen image is too light or dark Screen image bounces or a wave pattern is present in the image	<ul style="list-style-type: none">• Adjust the Contrast and Brightness settings via OSD.• Make sure the signal cable is properly connected to the monitor and the computer.• Move electrical devices that may cause electrical interference.
Screen image has color defects (white does not look white)	<ul style="list-style-type: none">• Inspect the signal cable and make sure that none of the pins are bent.• Perform All Reset via OSD.• Select the appropriate color temperature (Color Temp.) via OSD.
No sound or sound is low	<ul style="list-style-type: none">• Adjust the volume settings of your monitor or computer.• Make sure the computer sound card driver is properly installed and activated.• Check the audio source.

3.5 Supported Timing List

PC Supported Primary Timing

Resolution	H Freq (KHz)	V Freq (Hz)	DCLK (MHz)	HDMI	DP/ Type-C
640x480-60Hz	31.46	59.94	25.17	V	V
640x480-67Hz	35	67	30.24	V	V
640x480-72Hz	37.86	72.80	31.5	V	V
640x480-75Hz	37.5	75	31.5	V	V
720x400-70Hz	31.46	70.16	28.35	V	V
800x600-56Hz	35.15	56.25	36	V	V
800x600-60Hz	37.87	60.31	40	V	V
800x600-72Hz	48.07	72.18	50	V	V
800x600-75Hz	46.87	75	49.5	V	V
1024x768-60Hz	48.36	60	65	V	V
1024x768-70Hz	56.47	70.06	75	V	V
1024x768-75Hz	60.02	75.02	78.75	V	V
1152x864-75Hz	67.5	75	108	V	V
1280x720-60Hz(RB)	44.77	59.85	74.5	V	V
1280x720-60Hz	45	60	74.25	V	V
1280x960-60Hz	60	60	108	V	V
1280x1024-60Hz	63.98	60	108	V	V
1280x1024-75Hz	79.97	75.02	135	V	V
1440x900-60Hz(CVT RB)	55.46	59.90	88.75	V	V
1440x900-60Hz	55.93	59.88	106.5	V	V
1680x1050-60Hz(CVT RB)	64.67	59.88	119	V	V
1680x1050-60Hz	65.29	59.95	146.25	V	V
1920x1080-60Hz	67.5	60	148.5	V	V
2560x1440-120Hz	183	120	497.76	V	N/A
2560x1440-144Hz	222.14	143.97	592.25	N/A	V
3440x1440-50Hz(CVT RB)	74.05	50	266.58	V	N/A
3440x1440-60Hz(CVT RB)	88.81	59.97	319.75	V	V
3440x1440-100Hz(CVT RB)	150.97	99.98	543.5	V	V
3440x1440-120Hz(Only Type-C)	182.82	119.88	643.51	N/A	V
3440x1440-144Hz (Only DP)	221.97	143.85	964.31	N/A	V
3440x1440-180Hz (Only DP)	270.18	180	951.03	N/A	V

CEA Timing

Resolution	H Freq (KHz)	V Freq (Hz)	DCLK (MHz)	HDMI	DP/ Type-C
640x480p-60 Hz	31.46	59.94	25.17	V	V
720x480p-60 Hz	31.46	59.94	27	V	V
720x480p-60 Hz	31.46	59.94	27	V	V
1280x720p-60 Hz	45	60	74.25	V	V
1920x1080i-60 Hz	33.75	60	74.25	V	V
1440x480p-60 Hz	31.46	59.94	54	N/A	V
1440x480p-60 Hz	31.46	59.94	54	N/A	V
1920x1080p-60 Hz	67.5	60	148.5	V	V
720x576p-50 Hz	31.25	50	27	V	N/A
1280x720p-50 Hz	37.5	50	74.25	V	V
1920x1080i-50 Hz	28.12	50	74.25	V	N/A
1440x576p-50 Hz	31.25	50	54	N/A	V
1440x576p-50 Hz	31.25	50	54	N/A	V
1920x1080p-50 Hz	56.25	50	148.5	V	V
1920x1080p-120 Hz	135	120	297	V	N/A
1920x1080p-100 Hz	112.5	100	297	V	N/A
2560x1080p-50 Hz	56.25	50	185.62	N/A	V
2560x1080p-60 Hz	66	60	198	V	V
2560x1080p-100 Hz	125	100	371.25	N/A	V
2560x1080p-120 Hz	150	120	495	N/A	V
3840x2160p-24 Hz	54	24	297	N/A	V
3840x2160p-25 Hz	56.25	25	297	N/A	V
3840x2160p-30 Hz	67.5	30	297	N/A	V
3840x2160p-50 Hz	112.5	50	594	V	N/A
3840x2160p-60 Hz	135	60	594	V	V

PxP Supported Timing

Resolution	H Freq (KHz)	V Freq (Hz)	DCLK (MHz)	HDMI	DP/ Type-C
1280x1440-60Hz (2560*1440)	88.77	59.94	120.72	V	N/A
1720x1440-60Hz (3440*1440)	88.76	59.93	166.88	V	N/A
1920x1600-60Hz (3840*1600)	98.66	59.94	197.32	V	N/A
1920x2160-60Hz (3840*2160)	133.29	59.98	277.25	V	N/A



REPUBLIC OF
GAMERS

