



Questo manuale d'istruzione è fornito da trovaprezzi.it. Scopri tutte le offerte per [Asus ZenScreen MB229CF](#) o cerca il tuo prodotto tra le [migliori offerte di Monitor](#)



Questo manuale d'istruzione è fornito da trovaprezzi.it. Scopri tutte le offerte per [Asus ZenScreen MB229CF](#) o cerca il tuo prodotto tra le [migliori offerte di Monitor](#)

ASUS[®]

ZenScreen MB229CF

Portable Monitor

User Guide

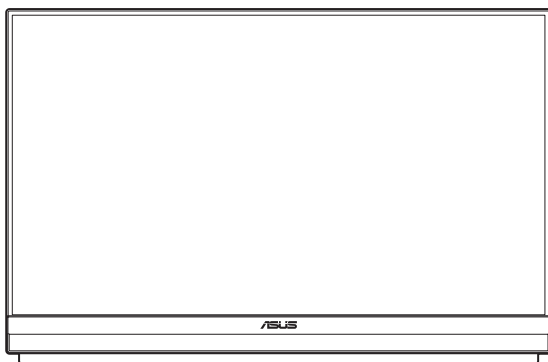

HDMI[™]
HIGH-DEFINITION MULTIMEDIA INTERFACE

First Edition

November 2023

Copyright © 2023 ASUSTeK COMPUTER INC. All Rights Reserved.

No part of this manual, including the products and software described in it, may be reproduced, transmitted, transcribed, stored in a retrieval system, or translated into any language in any form or by any means, except documentation kept by the purchaser for backup purposes, without the express written permission of ASUSTeK COMPUTER INC. ("ASUS").

Product warranty or service will not be extended if: (1) the product is repaired, modified or altered, unless such repair, modification or alteration is authorized in writing by ASUS; or (2) the serial number of the product is defaced or missing.

ASUS PROVIDES THIS MANUAL "AS IS" WITHOUT WARRANTY OF ANY KIND, EITHER EXPRESS OR IMPLIED, INCLUDING BUT NOT LIMITED TO THE IMPLIED WARRANTIES OR CONDITIONS OF MERCHANTABILITY OR FITNESS FOR A PARTICULAR PURPOSE. IN NO EVENT SHALL ASUS, ITS DIRECTORS, OFFICERS, EMPLOYEES OR AGENTS BE LIABLE FOR ANY INDIRECT, SPECIAL, INCIDENTAL, OR CONSEQUENTIAL DAMAGES (INCLUDING DAMAGES FOR LOSS OF PROFITS, LOSS OF BUSINESS, LOSS OF USE OR DATA, INTERRUPTION OF BUSINESS AND THE LIKE), EVEN IF ASUS HAS BEEN ADVISED OF THE POSSIBILITY OF SUCH DAMAGES ARISING FROM ANY DEFECT OR ERROR IN THIS MANUAL OR PRODUCT.

SPECIFICATIONS AND INFORMATION CONTAINED IN THIS MANUAL ARE FURNISHED FOR INFORMATIONAL USE ONLY, AND ARE SUBJECT TO CHANGE AT ANY TIME WITHOUT NOTICE, AND SHOULD NOT BE CONSTRUED AS A COMMITMENT BY ASUS. ASUS ASSUMES NO RESPONSIBILITY OR LIABILITY FOR ANY ERRORS OR INACCURACIES THAT MAY APPEAR IN THIS MANUAL, INCLUDING THE PRODUCTS AND SOFTWARE DESCRIBED IN IT.

Products and corporate names appearing in this manual may or may not be registered trademarks or copyrights of their respective companies, and are used only for identification or explanation and to the owners' benefit, without intent to infringe.

Contents

Notices.....	iv
Safety Information.....	vi
Care & Cleaning.....	vii
Takeback Services.....	viii
Chapter 1: Product Introduction	
1.1 Welcome!.....	1-1
1.2 Package contents.....	1-1
1.3 Monitor introduction.....	1-2
1.3.1 I/O ports.....	1-2
1.3.2 Control buttons.....	1-3
Chapter 2: Setup	
2.1 Adjusting the monitor.....	2-1
2.1.1 Using the kickstand.....	2-1
2.1.2 Using the partition hook kit.....	2-2
2.1.3 Using the C-clamp arm.....	2-3
2.2 Outline dimension.....	2-5
2.3 Wall mounting.....	2-6
2.3.1 Detaching the C-clamp arm.....	2-6
2.3.2 Mounting the monitor to the wall.....	2-7
2.4 Turning on the monitor.....	2-7
Chapter 3: General Instructions	
3.1 OSD (On-Screen Display) menu.....	3-1
3.1.1 How to reconfigure.....	3-1
3.1.2 OSD function introduction.....	3-2
3.2 Specifications.....	3-14
3.3 Troubleshooting (FAQ).....	3-15
3.4 Supported timing list.....	3-16

Notices

Federal Communications Commission Statement

This device complies with Part 15 of the FCC Rules. Operation is subject to the following two conditions:

- This device may not cause harmful interference, and
- This device must accept any interference received including interference that may cause undesired operation.

This equipment has been tested and found to comply with the limits for a Class B digital device, pursuant to Part 15 of the FCC Rules. These limits are designed to provide reasonable protection against harmful interference in a residential installation. This equipment generates, uses and can radiate radio frequency energy and, if not installed and used in accordance with the instructions, may cause harmful interference to radio communications. However, there is no guarantee that interference will not occur in a particular installation. If this equipment does cause harmful interference to radio or television reception, which can be determined by turning the equipment off and on, the user is encouraged to try to correct the interference by one or more of the following measures:

- Reorient or relocate the receiving antenna.
- Increase the separation between the equipment and receiver.
- Connect the equipment to an outlet on a circuit different from that to which the receiver is connected.
- Consult the dealer or an experienced radio/TV technician for help.

Canadian Department of Communications Statement

This digital apparatus does not exceed the Class B limits for radio noise emissions from digital apparatus set out in the Radio Interference Regulations of the Canadian Department of Communications.

This class B digital apparatus complies with Canadian ICES-003.



NOTE: This monitor is ENERGY STAR certified.

This product qualifies for ENERGY STAR® in the factory default (Home configuration) setting. Changing the factory default settings or enabling other features may increase power consumption that could exceed the limits necessary to qualify for ENERGY STAR®. Refer to ENERGYSTAR.gov (www.energystar.gov) for more information on the ENERGY STAR® program.



Declaration of Conformity

This device complies with the requirements set out in the Council Directive on the Approximation of the Laws of the Member States relating to Electromagnetic Compatibility (2014/30/EU), Low-voltage Directive (2014/35/EU), ErP Directive (2009/125/EC) and RoHS directive (2011/65/EU). This product has been tested and found to comply with the harmonized standards for Information Technology Equipment, these harmonized standards published under Directives of Official Journal of the European Union.

WEEE Symbol Statement

This symbol on the product or on its packaging indicates that this product must not be disposed of with your other household waste. Instead, it is your responsibility to dispose of your waste equipment by handing it over to a designated collection point for the recycling of waste electrical and electronic equipment. The separate collection and recycling of your waste equipment at the time of disposal will help to conserve natural resources and ensure that it is recycled in a manner that protects human health and the environment. For more information about where you can drop off your waste equipment for recycling, please contact your local city office, your household waste disposal service or the shop where you purchased the product.



AEEE yönetmeliğine uygundur

■ ASUS CONTACT INFORMATION		
■ ASUSTeK Computer Inc.	■ ASUS Computer International (America)	■ ASUS Computer GmbH (Germany and Austria)
Address 1F, No.15, Lide Rd., Beitou Dist., Taipei City, 112	Address 48720 Kato Rd, Fremont, CA 94538, USA	Address Harkortstr. 21-23 D-40880 Ratingen, Germany
Telephone +886-2-2894-3447	Telephone +1-510-739-3777	Telephone +49-1805-010920
Fax +886-2-2894-7798	Fax +1-510-608-4555	Website http://www.asus.de/
E-mail info@asus.com.tw	Website http://usa.asus.com/	Online Contact http://www.asus.de/sales
Website http://www.asus.com.tw/		
■ Technical Support	■ Technical Support	■ Technical Support
Telephone +86-21-38429911	Telephone +1-812-282-2787 (English Only) +1-905-370-2787 (French Only)	Telephone +49-1805-010923
	Online Support http://support.asus.com/	Support Fax +49-2102-959911
		Online Support http://support.asus.com/

Safety Information

- Before setting up this Portable Monitor, carefully read all the documentation that came with the package.
- To prevent fire or shock hazard, never expose this Portable Monitor to rain or moisture.
- Never try to open this Portable Monitor cabinet.
- Before using this Portable Monitor, make sure all cables are correctly connected and the power cables are not damaged. If you detect any damage, contact your dealer immediately.
- Avoid dust, humidity, and temperature extremes. Do not place this Portable Monitor in any area where it may become wet. Place this Portable Monitor on a stable surface.
- Never push objects or spill liquid of any kind into the slots on this Portable Monitor cabinet.
- If you encounter technical problems with this Portable Monitor, contact a qualified service technician or your retailer.
- DO NOT dispose of this Portable Monitor in fire.
- DO NOT use this Portable Monitor near heating equipment or in places where there is likelihood of high temperature.
- Keep this Portable Monitor away from sharp objects.
- DO NOT place objects on the top of this Portable Monitor.

WARNING

Restriction on Hazardous Substances statement (India) This product complies with the "India E-Waste (Management) Rules, 2016" and prohibits use of Lead, Mercury, Hexavalent Chromium, polybrominated biphenyls(PBBs) and polybrominated diphenyl ethers(PBDEs) in concentration exceeding 0.1% by weight in homogenous materials and 0.01% by weight in homogenous materials for cadmium, except of exemptions listed in Schedule 2 of the Rule.

Care & Cleaning

- Cleaning. Turn your monitor off and unplug the adaptor. Clean the monitor surface with a lint-free, non-abrasive cloth. Stubborn stains may be removed with a cloth dampened with mild cleaner.
- Avoid using a cleaner containing alcohol or acetone. Use a cleaner intended for use with the LCD. Never spray cleaner directly on the screen, as it may drip inside the monitor and cause an electric shock.

The following symptoms are normal with the monitor:

- You may find slightly uneven brightness on the screen depending on the desktop pattern you use.
- When the same image is displayed for hours, an afterimage of the previous screen may remain after switching the image. The screen will recover slowly or you can turn off the Power Switch for hours.
- When the screen becomes black or flashes, or cannot work anymore, contact your dealer or service center to fix it. Do not repair the screen by yourself!

Conventions used in this guide



WARNING: Information to prevent injury to yourself when trying to complete a task.



CAUTION: Information to prevent damage to the components when trying to complete a task.



IMPORTANT: Information that you **MUST** follow to complete a task.



NOTE: Tips and additional information to aid in completing a task.

Where to find more information

Refer to the following sources for additional information and for product and software updates.

1. ASUS websites

The ASUS websites worldwide provide updated information on ASUS hardware and software products. Refer to <http://www.asus.com>

2. Optional documentation

Your product package may include optional documentation that may have been added by your dealer. These documents are not part of the standard package.

3. About Flicker

https://www.asus.com/Microsite/display/eye_care_technology/

Takeback Services

ASUS recycling and takeback programs come from our commitment to the highest standards for protecting our environment. We believe in providing solutions for our customers to be able to responsibly recycle our products, batteries and other components as well as the packaging materials.

Please go to <http://csr.asus.com/english/Takeback.htm> for detail recycling information in different region.

Product information for EU energy label



1.1 Welcome!

Thank you for purchasing the ASUS® Portable Monitor!

The latest ASUS Portable Monitor provides great portability and simplicity to your daily life, enhancing both of your viewing experience and style.

1.2 Package contents

Check your package for the following items:

- ✓ Portable Monitor
- ✓ Quick Start Guide
- ✓ Warranty Card
- ✓ USB Type-C Cable
- ✓ Power Cord
- ✓ HDMI Cable
- ✓ Power Adaptor
- ✓ Monitor Arm
- ✓ Partition Hook Kit
- ✓ L-shaped Screwdriver
- ✓ Screw



- If any of the above items is damaged or missing, contact your retailer immediately.
-

1.3 Monitor introduction

1.3.1 I/O ports

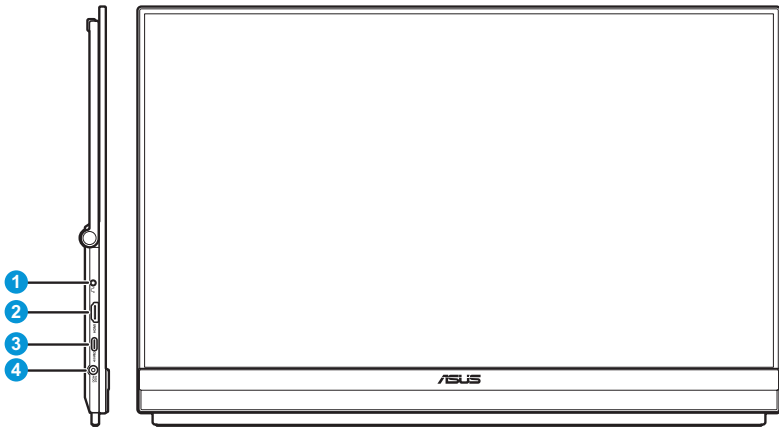

1. Earphone jack
2. HDMI port
3. USB Type-C port (PD 5V/3A, 9V/3A, 12V/3A, 15V/3A, or 20V/3A)
4. DC-IN jack

1.3.2 Control buttons

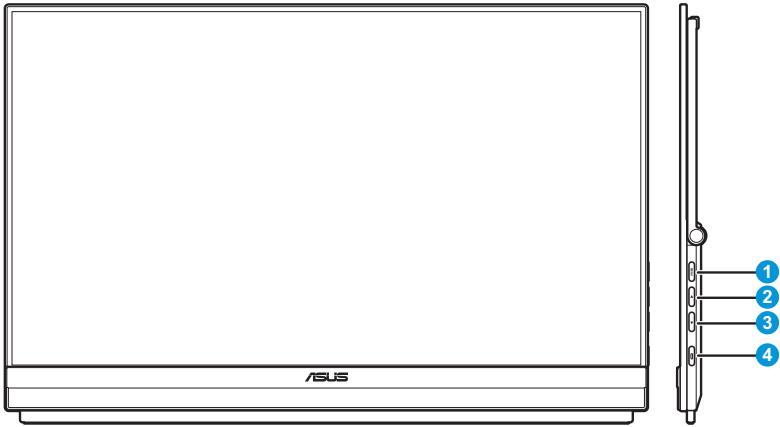

1. **MENU** Menu Button:

- Press this button to display the Quick menu.

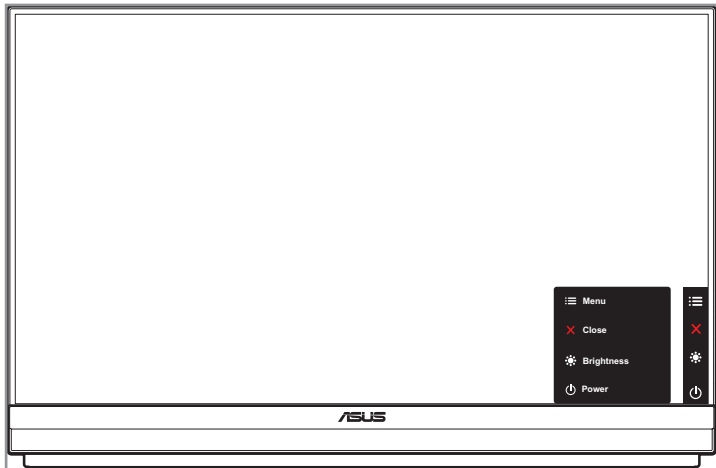

- When the Quick menu is ON, press this button to display the OSD menu.
- Toggles the Key Lock function between on and off with a long press for 5 seconds.

2. ▲ Up Button:
 - Press this button to display the Quick menu.
 - When the Quick menu is ON, press this button to exit the Quick menu.
3. ▼ Down Button:
 - Press this button to display the Quick menu.
 - When the Quick menu is ON, this is a Shortcut key. The default setting is **Brightness**.
To change the preset hotkey function, go to the **Shortcut** menu.
4. Power Button/Power Indicator:
 - Press this button to turn the monitor on/off.
 - The color definition of the power indicator is as the table below.

Status	Description
White	ON
Amber	Standby mode
OFF	OFF

2.1 Adjusting the monitor

2.1.1 Using the kickstand

For optimal viewing, you can adjust the monitor to the angle that is most comfortable for you.

- Unfold and open the kickstand to adjust the monitor's angle between 12° to 60° .

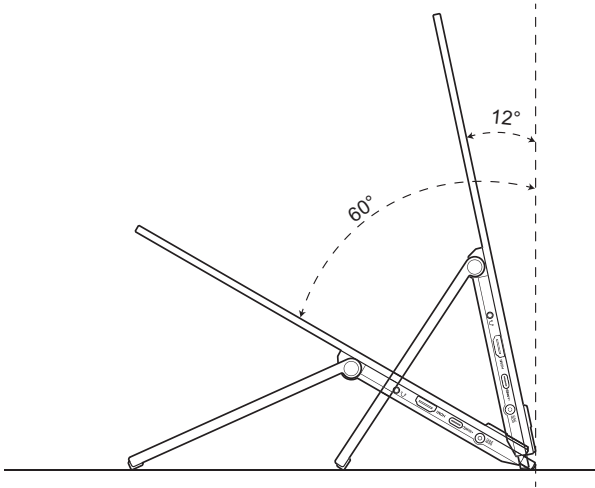

2.1.2 Using the partition hook kit

1. Install the hook pad at the desired height on the hook L-bracket. Then attach the screw and secure it using an L-shaped screwdriver.
2. Loosen the knob to release the clamp of the hook. Then hang the hook to the partition wall.
3. Adjust the clamp to fit the thicknesses of the partition. Then tighten the knob to secure the hook in place.
4. To install another partition hook, repeat the previous steps.



Make sure both left and right hook pads are parallel.

5. Fold the the kickstand upward. Then by holding the monitor with both hands, hang the kickstand of the monitor on the hook.

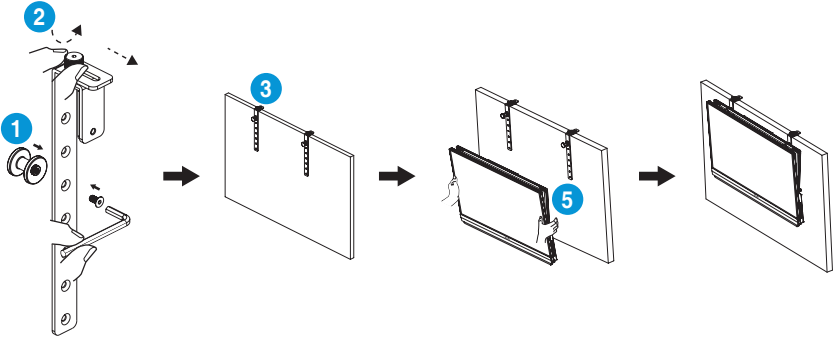

2.1.3 Using the C-clamp arm

1. Install the z-axis adjustable clip to the C-clamp arm. Then attach the screw and secure it using an L-shaped screwdriver.
2. Install the C-clamp arm to your desk. Then tighten the hand screw to secure the pole in place.
3. Fold the the kickstand upward and install the tripod socket to the rear of the monitor. Then tighten the hinged D-ring screw to secure the tripod socket in place.
4. Attach the tripod socket of the monitor to the clip.

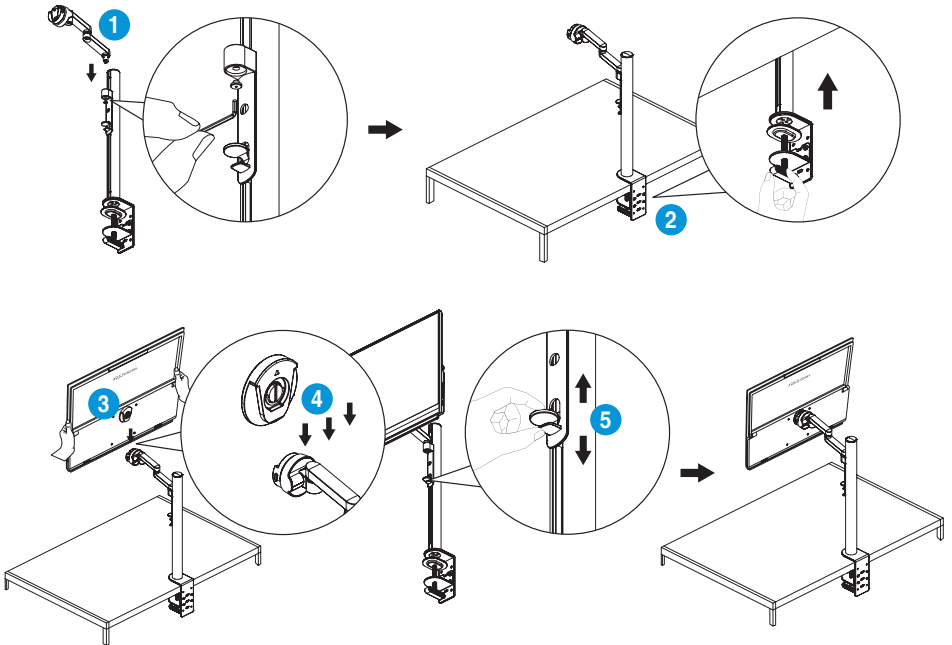

5. Adjust the monitor to the angle that is most comfortable for you.

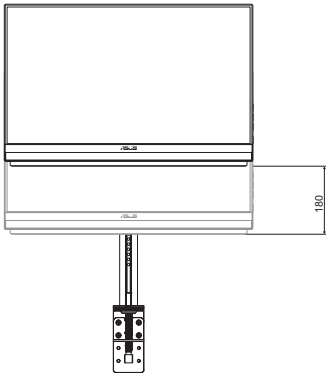

Height adjustment (up to 180mm)

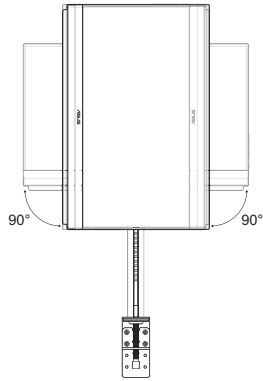

Pivot adjustment ($\pm 90^\circ$)

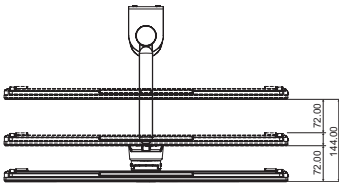

Extension/Retraction adjustment
(up to 144mm)

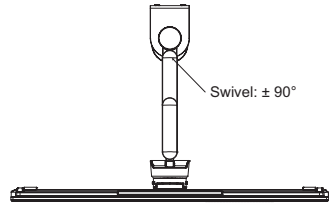

Swivel adjustment (-90° to 90°)

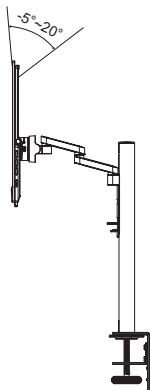

Tilt adjustment (-5° to 20°)

2.2 Outline dimension

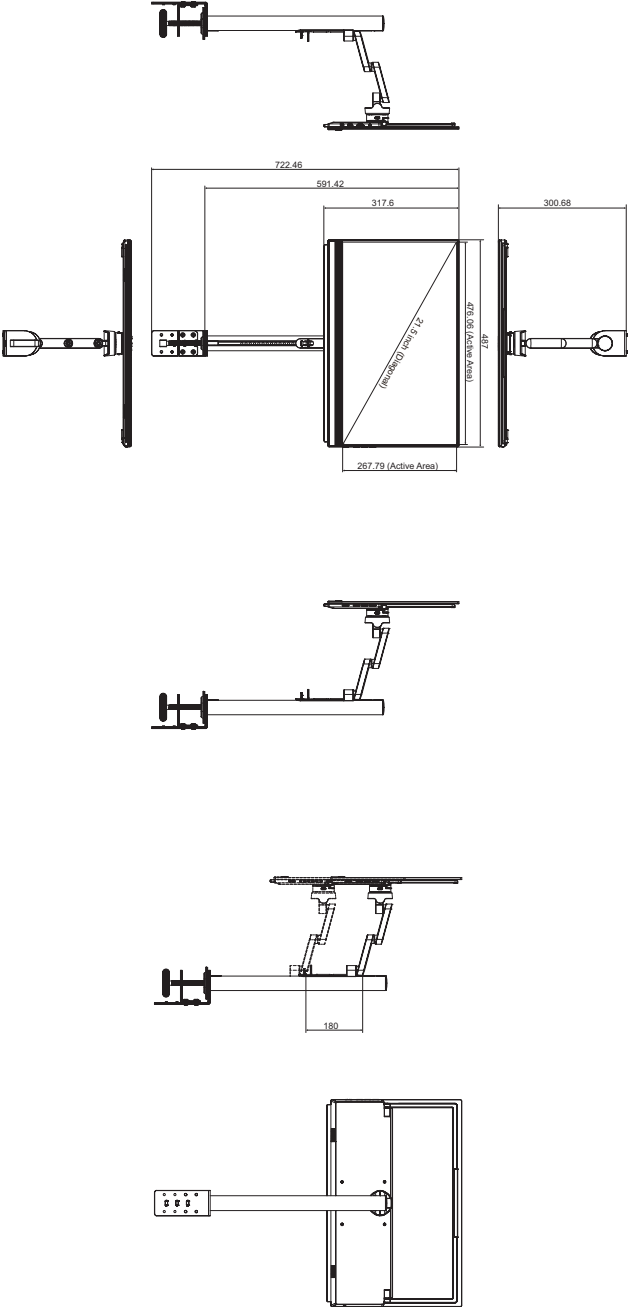

2.3 Wall mounting

2.3.1 Detaching the C-clamp arm

1. Push the locking latches inward to disengage the monitor from the z-axis adjustable clip. Then by holding the monitor with both hands, lift to remove the monitor.
2. By holding the monitor with both hands, lift to remove the monitor.
3. Loosen the hand screw securing the pole. Then remove the C-clamp arm from your desk.
4. Using an L-shaped screwdriver, remove the screw securing the z-axis adjustable clip to the C-clamp arm. Then remove the z-axis adjustable clip.

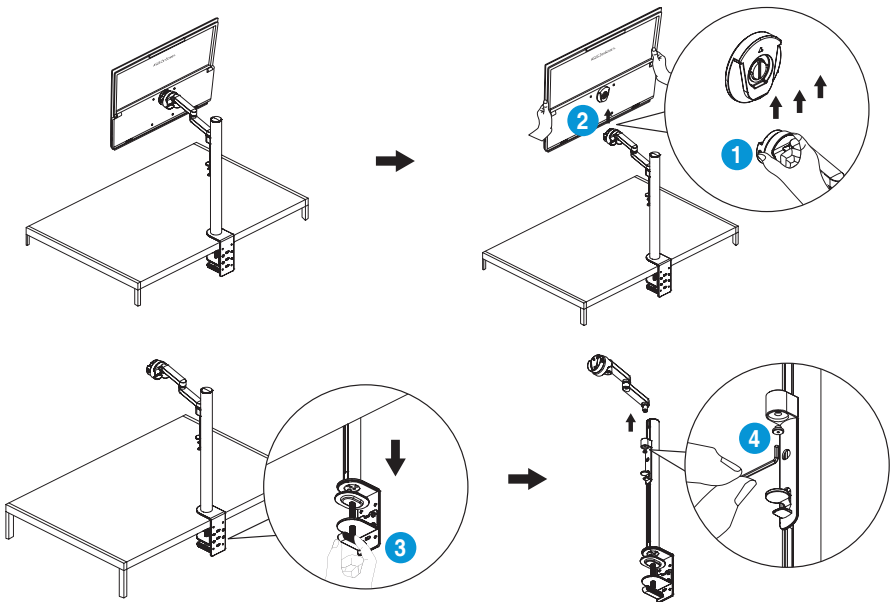

2.3.2 Mounting the monitor to the wall

1. Loosen the hinged D-ring screw securing the tripod socket. Then remove the tripod socket from the rear of the monitor.
2. Using a screwdriver, remove the four screws from the rear of the monitor. Then mount the monitor on the wall.

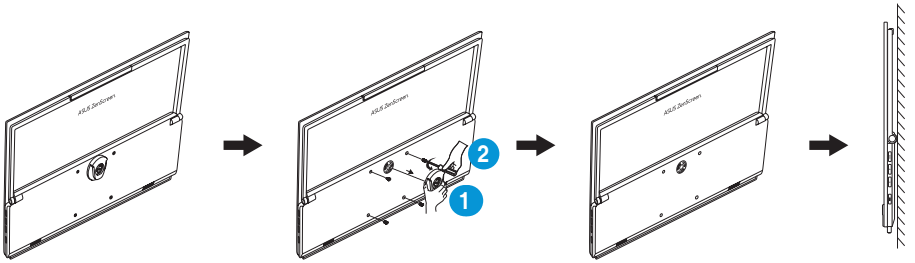

- Only use the UL Listed Wall Mount Bracket with minimum weight/load 22.7kg (Screw size: M4 x 10mm).
- Tripod screw size: INCH 3/8 x L 10.4 mm.

2.4 Turning on the monitor

Press the **Power** button. The power indicator lights up in white to show that the monitor is ON.

3.1 OSD (On-Screen Display) menu

3.1.1 How to reconfigure

1. Press the **Menu** button twice to activate the OSD menu.

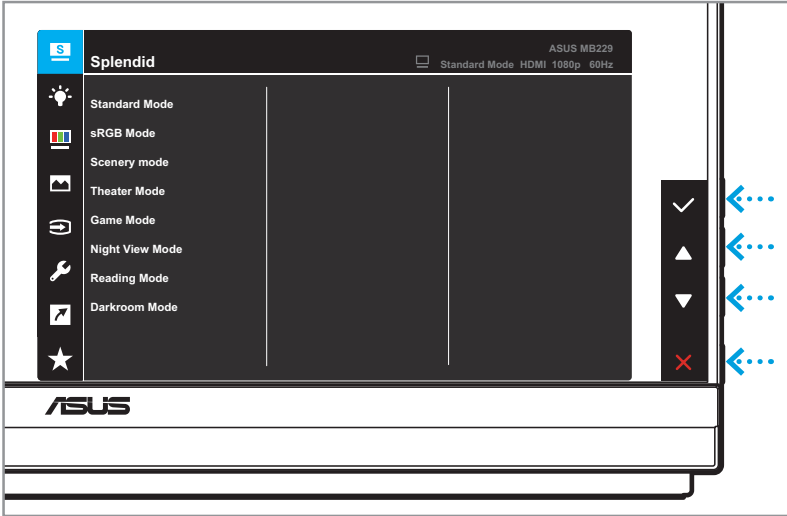

Press the corresponding buttons on the monitor to navigate through the menu and make adjustments.

2. Press the ▲ or ▼ button to navigate through the functions. Highlight the desired function and press the ✓ button to enter its sub-menu.
3. In the sub-menu, press the ▲ or ▼ button again to navigate through the sub-menu functions. Highlight the desired sub-menu function and press the ✓ button to select an option or press the ▲ or ▼ button to adjust the setting.
4. Press the ▲ or ▼ button to change the settings of the selected function. Then press the ↶ button to return to the previous menu.
5. To exit the OSD menu, press the ✗ button.

3.1.2 OSD function introduction

1. Splendid

This function contains eight sub-functions that you can select for your preference.

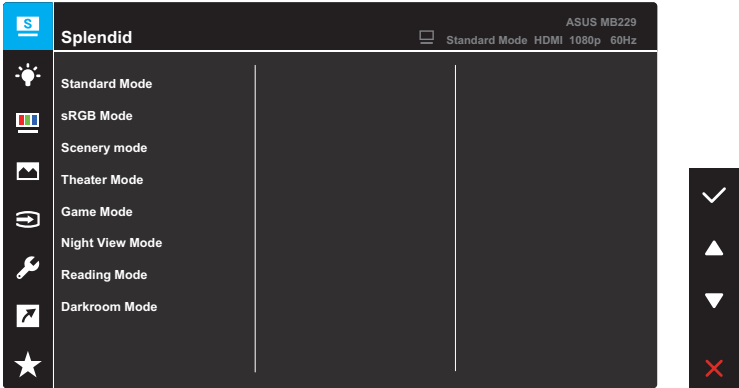

- **Standard Mode:** This is the best choice for document editing with SILENDID™ Video Intelligence Technology.
- **sRGB Mode:** This is the best choice for viewing photos and graphics from PCs.
- **Scenery Mode:** This is the best choice for scenery photo displaying with SILENDID™ Video Intelligence Technology.
- **Theater Mode:** This is the best choice for movie watching with SILENDID™ Video Intelligence Technology.
- **Game Mode:** This is the best choice for game playing with SILENDID™ Video Intelligence Technology.
- **Night View Mode:** This is the best choice for playing dark-scene game or watching dark-scene movie with SILENDID™ Video Intelligence Technology.
- **Reading Mode:** This is the best choice for book reading.
- **Darkroom Mode:** This is the best choice for a weak ambient light environment.



- In the Standard mode, the following function(s) are not user-configurable: Saturation, Skin Tone, Sharpness, and ASCR.
- In the sRGB mode, the following function(s) are not user-configurable: Brightness, Contrast, Saturation, Color Temp., Skin Tone, Sharpness, and ASCR.
- In the Reading mode, the following function(s) are not user-configurable: Contrast, Saturation, Color Temp., Skin Tone, and ASCR.

2. Blue Light Filter

In this function, you can adjust the blue light filter setting to better protect your eyes. Press the **Menu** button to enter this menu.

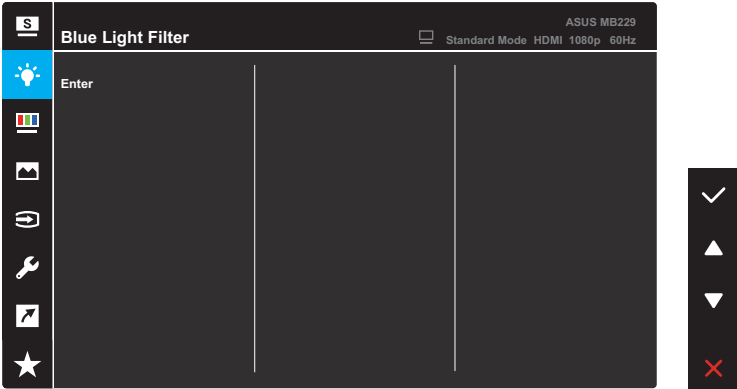

Then you can adjust the blue light filter setting.

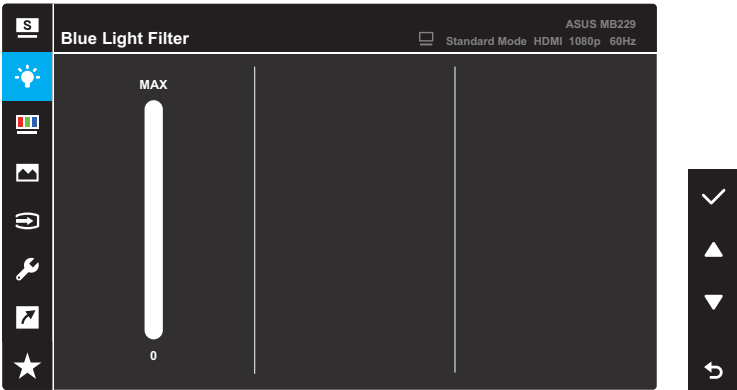

- **0:** No changes.
- **Max:** The higher the level, the less blue light is scattered. When blue light filter is activated, the default settings of Standard Mode will be automatically imported. Besides maximum level, the brightness is user-configurable. Maximum is the optimized setting. It is compliance with TUV low blue light certification*. The brightness function is not user configurable.



*When the user adjusts blue light filter bar to maximum level.



Please refer to the following to alleviate eye strains:

- Users should take some time away from the display if working for long hours: It is advised to take short breaks (at least 5 mins) after around 1 hour of continuous working at the computer. Taking short and frequent breaks is more effective than a single longer break.
 - To minimize eye strain and dryness in your eyes, users should rest the eye periodically by focusing on objects that are far away.
 - Eye exercises can help to reduce eye strain. Repeat these exercises often. If eye strain continues, please contact a physician. Eye exercises: (1) Repeating look up and down (2) Slowly roll your eyes (3) Move your eyes diagonal.
 - High energy blue light may lead to eye strain and AMD(Age-Related Macular Degeneration). Blue light Filter reduces 70% (max.) harmful blue light to avoid CVS(Computer Vision Syndrome) when the user adjusts the blue light filter bar to the maximum level.
-

3. Color

Set a desired color setting from this menu.

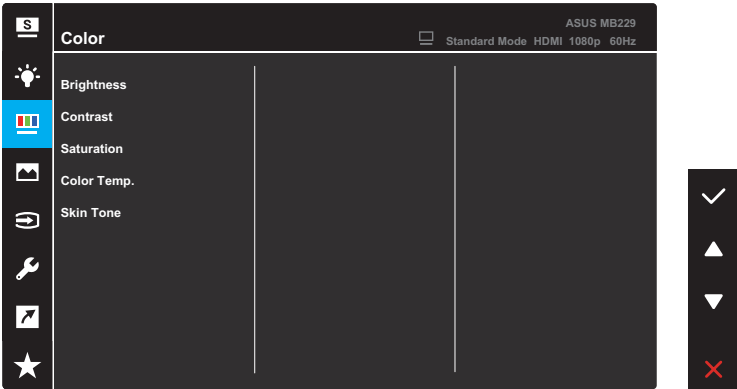

- **Brightness:** Adjust the brightness level. The adjusting range is from 0 to 100.
- **Contrast:** Adjust the contrast level. The adjusting range is from 0 to 100.
- **Saturation:** Adjust the saturation level. The adjusting range is from 0 to 100.
- **Color Temp.:** Select the desired color temperature. Available options: **Cool, Normal, Warm, and User Mode.**



In the User Mode, colors of R (Red), G (Green), and B (Blue) are user-configurable; the adjusting range is from 0 to 100.

- **Skin Tone:** Select the desired skin tone. Available options: **Reddish, Natural, and Yellowish.**

4. Image

Set the image related setting from this menu.

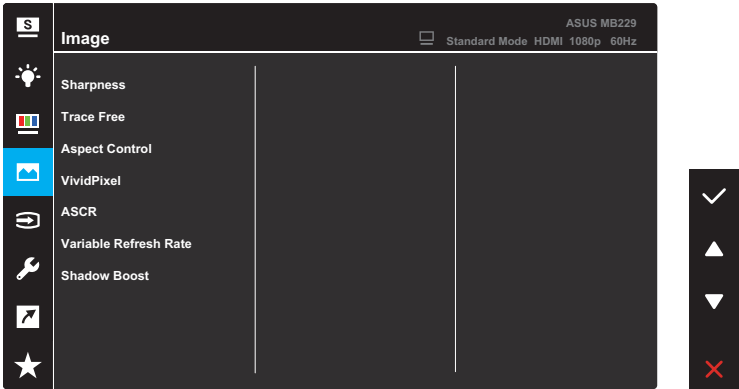

- **Sharpness:** Adjust the picture sharpness. The adjusting range is from 0 to 100.
- **Trace Free:** Adjust the response time of the monitor.
- **Aspect Control:** Adjust the aspect ratio to **Full** or **4:3**.



4:3 is only available when the input resolution H:V < 16:9.

- **VividPixel:** ASUS Exclusive Technology that brings lifelike visuals for crystal-clear and detail-oriented enjoyment. The adjusting range is from 0 to 100.
- **ASCR:** Turn on/off the ASCR (ASUS Smart Contrast Ratio) function.
- **Variable Refresh Rate:** Allow a Variable Refresh Rate supported graphics source to dynamically adjust display refresh rate based on typical content frame rates for power efficient, virtually stutter free and low-latency display update.
- **Shadow Boost:** Dark color enhancement adjust monitor gamma curve to enrich the dark tones in an image making dark scenes and objects much easier be found.

5. Input Select

Select the input source from HDMI or USB Type-C input signal.

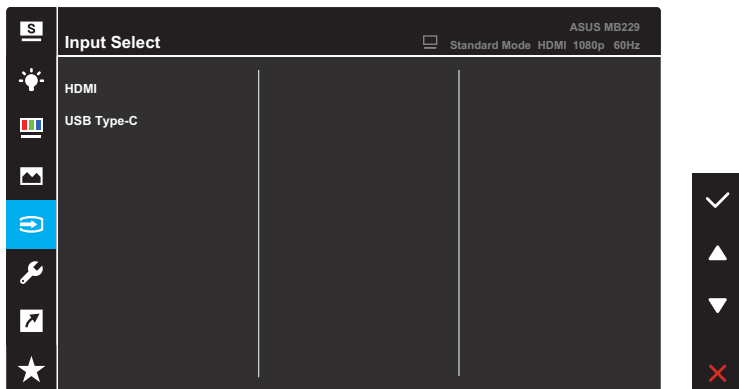

6. System Setup

Adjust the system configuration.



(Page 1/2)

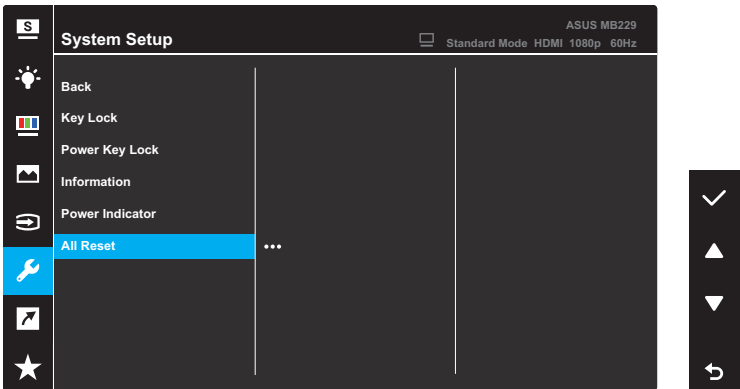

(Page 2/2)

- **Splendid Demo Mode:** Activate the demo mode for the Splendid function.
- **Volume:** Adjust the volume level.

- **GamePlus:** The GamePlus function provides a toolkit and creates a better gaming environment for users when playing different types of games.

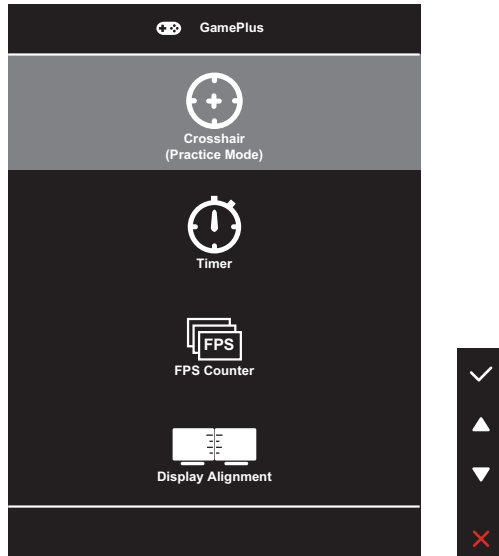

- **Crosshair:** The crosshair overlay with different crosshair options lets you choose the one that best suits the game you're playing.
- **Timer:** You can position the timer on the upper left corner of the display so you can keep track of the gaming time.
- **FPS Counter:** The FPS (frames per second) counter lets you know how smooth the game is running.
- **Display Alignment:** Display Alignment displays alignment lines on 4 sides of the screen, serving as an easy and handy tool for you to line up multiple monitors perfectly.

- **QuickFit:** You can have a preview of the document or photo layout directly on screen without printing test copies.

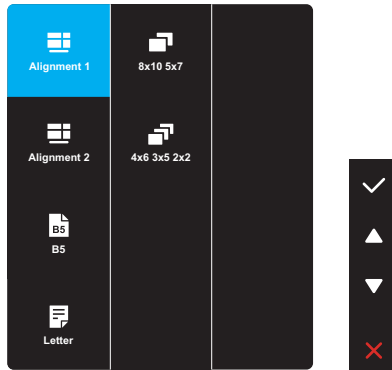

- **Alignment:** This facilitates designers and users to organize content and layout on one page and achieve a consistent look and feel.

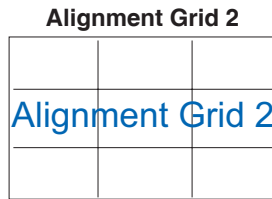
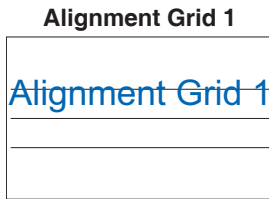

- **Paper size:** You can view the documents in real size on the screen.

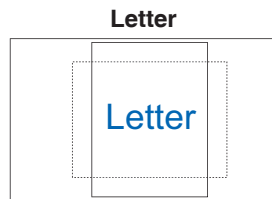
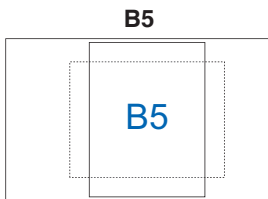

- **Photo:** The various real photo sizes displayed provides photographers and other users to accurately view and edit their photos in real size on the screen.

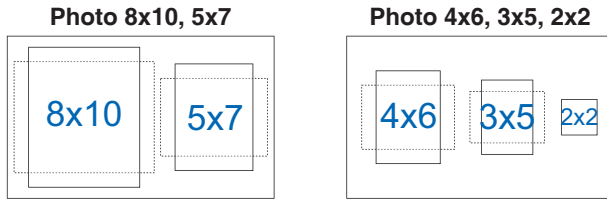

- **ECO Mode:** Activate this ecology mode for power saving.
- **OSD Setup:** Configure the OSD screen related settings.
 - **OSD Timeout:** Adjusts the OSD timeout from 10 to 120 seconds.
 - **DDC/CI:** Enables or disables the DDC/CI function.
 - **Transparency:** Adjusts the OSD background from opaque to transparent.
- **Language:** Select the OSD language.
- **More:** Return the next page of the *System Setup* menu.
- **Back:** Return the previous page of the *System Setup* menu.
- **Key Lock:** Select **ON** to disable all function keys. To cancel the key lock function, press the **Menu** button for more than five seconds.
- **Power Key Lock:** Disable/Enable the **Power** button.
- **Information:** Display the monitor information.
- **Power Indicator:** Turn the power LED indicator on/off.
- **All Reset:** Select **YES** to revert all settings to the factory default mode.

7. Shortcut

Assign the specific function to the shortcut key.

Available function choices for shortcut: Blue Light Filter, Splendid, Brightness, Contrast, Color Temp., Volume, QuickFit, and GamePlus.

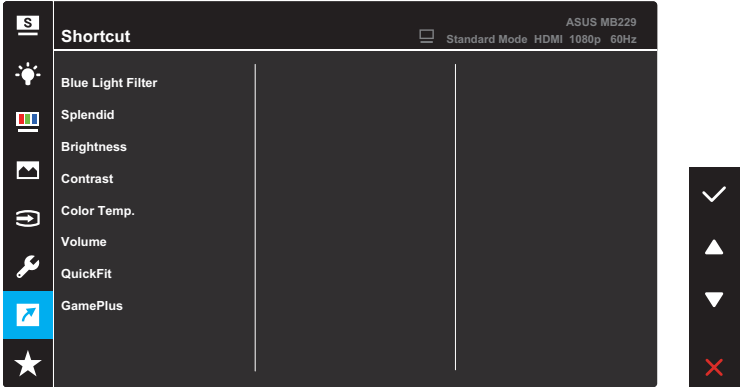

When a certain function is selected or activated, your shortcut key may not support.

8. MyFavorite

Load/Save all settings on the monitor.



3.2 Specifications

Model	MB229CF
Panel Size	21.5" (16:9, 54.61cm) wide screen
Max. Resolution	1920 x 1080
Brightness (Typ.)	250 cd/m ²
Contrast Ratio (Typ.)	1000:1
Display Colors	16.7 M
Digital Input	<ul style="list-style-type: none">• DisplayPort™ Alt Mode for USB Type-C™• HDMI
Colors	Black
Power consumption	13W (typical)
Operating temperature	0 ~ 40°C
Storage temperature	-20 ~ 60°C
Speaker	1W*2(Tweeter) + 1.5W(Woofers)
Phys. Dimension (HxWxD)	317.6 x 487 x 22.1 mm
Box Dimension (HxWxD)	398 x 547 x 129 mm
Net Weight (Esti.)	2.2 kg
Gross Weight (Esti.)	6 kg
Voltage Rating	<ul style="list-style-type: none">• Adaptor: 19V===4.74A• USB Type-C power input: 5-20Vdc, 3A (max.)
Adaptor	<ul style="list-style-type: none">• ASUS/ADP-90LE B• 100-240V~50/60Hz 1.5A• 19V ---, 4.74A

*Specifications subject to change without notice.

3.3 Troubleshooting (FAQ)

Problem	Possible Solution
Power LED is not ON	<ul style="list-style-type: none">• Press the Power button to check if the monitor is turned on.• Check if the adaptor is properly connected to the monitor and the power outlet.• Check the Power Indicator function in the OSD menu. Select “ON” to turn on the Power LED.• Make sure the USB Type-C or HDMI cable is properly connected between the Portable Monitor and the computer. Then check if the signal source is turned on.
The power LED lights amber and there is no screen image	<ul style="list-style-type: none">• Check if the monitor and the computer are turned on.• Make sure the USB Type-C or HDMI cable is properly connected between the Portable Monitor and the computer.• Inspect the signal cable and make sure none of the pins are bent.• Connect the computer with another available monitor to check if the computer is properly working.
Screen image is too light or dark	<ul style="list-style-type: none">• Adjust the Brightness setting via OSD.• USB Type-C cable can be used to light up the screen. If the power supply specification is less than 15W, you need to use an adapter instead.• When the device is powered by USB Type-C, please use a power supply above 15W. If the power supply is between 15 and 27W, some functions may be limited.
Screen image bounces or a wave pattern is present in the image	<ul style="list-style-type: none">• Make sure the USB Type-C or HDMI cable is properly connected between the Portable Monitor and the computer.• Move electrical devices that may cause electrical interference.
Screen image has color defects (white does not look white)	<ul style="list-style-type: none">• Inspect the signal cable (USB Type-C or HDMI) and make sure that none of the pins are bent.

3.4 Supported timing list

PC Supported Primary Timing

Resolution	Horizontal Frequency (KHz)	Vertical Frequency (Hz)	DCLK (MHz)
640x350-70Hz	31.469	70.087	25.175
640x480-60Hz	31.469	59.94	25.175
640x480-67Hz	35	66.667	30.24
640x480-72Hz	37.861	72.809	31.5
640x480-75Hz	37.5	75	31.5
720x400-70Hz	31.469	70.087	28.322
800x600-56Hz	35.156	56.25	36
800x600-60Hz	37.879	60.317	40
800x600-72Hz	48.077	72.188	50
800x600-75Hz	46.875	75	49.5
832x624-75Hz	49.725	74.551	57.283
1024x768-60Hz	48.363	60.004	65
1024x768-70Hz	56.476	70.069	75
1024x768-75Hz	60.023	75.029	78.75
1152x864-75Hz	67.5	75	108
1280x720-60Hz	44.772	59.855	74.5
1280x800-60Hz	49.702	59.81	83.5
1280x960-60Hz	60	60	108
1280x1024-60Hz	63.981	60.02	108
1280x1024-75Hz	79.976	75.025	135
1360x765-60Hz	47.712	59.79	85.5
1440x900-60Hz	55.935	59.887	106.5
1680x1050-60Hz	65.29	59.954	146.25
1920x1080-50Hz	56.25	50	120.6
1920x1080-60Hz	67.5	60	148.5
1920x1080-75Hz	83.894	74.973	174.5
1920x1080-100Hz (HDMI)	110	100	228.8
1920x1080-100Hz (TYPE C)	110	100	220

* Modes not listed in the table may not be supported. For optimal resolution, we recommend that you choose a mode listed in the table above.