



Questo manuale d'istruzione è fornito da trovaprezzi.it. Scopri tutte le offerte per [BenQ EX240N](#) o cerca il tuo prodotto tra le [migliori offerte di Monitor](#)



Questo manuale d'istruzione è fornito da trovaprezzi.it. Scopri tutte le offerte per [BenQ EX240N](#) o cerca il tuo prodotto tra le [migliori offerte di Monitor](#)



MOBIUZ

LCD Monitor
User Manual

EX Series

Copyright

Copyright © 2022 by BenQ Corporation. All rights reserved. No part of this publication may be reproduced, transmitted, transcribed, stored in a retrieval system or translated into any language or computer language, in any form or by any means, electronic, mechanical, magnetic, optical, chemical, manual or otherwise, without the prior written permission of BenQ Corporation.

Disclaimer

BenQ Corporation makes no representations or warranties, either expressed or implied, with respect to the contents hereof and specifically disclaims any warranties, merchantability or fitness for any particular purpose. Further, BenQ Corporation reserves the right to revise this publication and to make changes from time to time in the contents hereof without obligation of BenQ Corporation to notify any person of such revision or changes.

BenQ flicker-free technology maintains a stable backlight with a DC dimmer that eliminates the primary cause of monitor flicker, making it easier on the eyes. The performance of flicker-free may be affected by external factors such as poor cable quality, unstable power supply, signal interference, or poor grounding, and not limited to the above mentioned external factors. (Applicable for flicker-free models only.)

BenQ ecoFACTS

BenQ has been dedicated to the design and development of greener product as part of its aspiration to realize the ideal of the "Bringing Enjoyment 'N Quality to Life" corporate vision with the ultimate goal to achieve a low-carbon society. Besides meeting international regulatory requirement and standards pertaining to environmental management, BenQ has spared no efforts in pushing our initiatives further to incorporate life cycle design in the aspects of material selection, manufacturing, packaging, transportation, using and disposal of the products. BenQ ecoFACTS label lists key eco-friendly design highlights of each product, hoping to ensure that consumers make informed green choices at purchase. Check out BenQ's CSR Website at <http://csr.BenQ.com/> for more details on BenQ's environmental commitments and achievements.



Product support

This document aims to provide the most updated and accurate information to customers, and thus all contents may be modified from time to time without prior notice. Please visit the website for the latest version of this document and other product information. Available files vary by model.

1. Make sure your computer is connected to the Internet.
2. Visit the local website from Support.BenQ.com. The website layout and content may vary by region/country.
 - User manual and related document
 - Drivers and applications
 - (EU only) Dismantled information: Available on the user manual download page. This document is provided based on Regulation (EU) 2019/2021 to repair or recycle your product. Always contact the local customer service for servicing within the warranty period. If you wish to repair an out-of-warranty product, you are recommended to go to a qualified service personnel and obtain repair parts from BenQ to ensure compatibility. Do not disassemble the product unless you are aware of the consequences. If you cannot find the dismantled information on your product, contact the local customer service for assistance.

EPREL Registration Number:

EX240: 1225290

EX240N: 1225291

Q&A index

Start with the topics that you are interested in.

Setup

How to set up the monitor and turn it on?

Safety precautions	6
How to assemble your monitor hardware (for monitors with height adjustment stand)	19
How to assemble your monitor hardware (for monitors without height adjustment stand)	28

How to adjust the monitor viewing angle?

Tilt the monitor. (for models with height adjustment stand)	23
Tilt the monitor. (for monitors without height adjustment stand)	31

How to wall mount the monitor?

Using the monitor wall mounting kit (purchased separately) (for models with height adjustment stand)	27
Using the monitor wall mounting kit (purchased separately) (for models without height adjustment stand)	34

Input source and image display

How to switch inputs from different devices quickly?

Setting up your monitor for different scenarios	38
Switching the inputs quickly with the looping key	39
Working with the Quick Menu	40

How to obtain the best HDR effect?

Working with the HDRi hot key	43
Game HDRi	53
Cinema HDRi	53

Menus and accessories

How to use the OSD menu?

5-way controller and basic menu operations	37
Navigating the main menu	48

What menu options are available to each color mode?

Available menu options to each Color Mode	42
---	----

Maintenance and product support

How to clean the monitor?

Care and cleaning	8
-------------------	---

How to keep the monitor not in use for a long time?

How to detach the stand and the base (for monitors with height adjustment stand)	25
How to detach the stand and the base (for monitors without height adjustment stand)	33
Care and cleaning	8

I need more support.

Product support

3

Servicing

9

Safety precautions

Power safety



Please follow these safety instructions for best performance, and long life for your monitor.

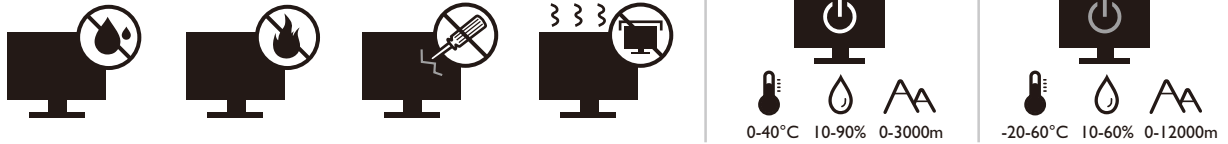

- The AC plug isolates this equipment from the AC supply.
- The power supply cord serves as a power disconnect device for pluggable equipment. The socket outlet should be installed near the equipment and be easily accessible.
- This product should be operated from the type of power indicated on the marked label. If you are not sure of the type of power available, consult your dealer or local power company.
- The Class I pluggable equipment Type A must be connected to protective earth.
- An approved power cord greater or equal to H03VV-F or H05VV-F, 2G or 3G, 0.75mm² must be used.
- Use only the power cord provided by BenQ. Never use a power cord that appears to be damaged or frayed.
- To avoid possible damage to the monitor, do not use it in a region where power supply is unstable.
- Ensure that the power cord is connected to a grounded power outlet before turning on the monitor.
- To avoid possible danger, observe the total electric load when using the monitor with a (multi-outlet) extension cord.
- Always turn off the monitor before unplugging the power cord.

For Germany only:

- (If the weight of the product is less than or equal to 3 kg) An approved power cord greater or equal to H03VV-F, 3G, 0.75mm² must be used.
- (If the weight of the product is more than 3 kg) An approved power cord greater or equal to H05VV-F or H05RR-F, 3G, 0.75mm² must be used.
- (If a remote control is provided) RISK OF EXPLOSION IF BATTERY IS REPLACED BY AN INCORRECT TYPE. DISPOSE OF USED BATTERIES ACCORDING TO THE INSTRUCTIONS.

For models with adapter:

- Use only the power adapter supplied with your LCD Monitor. Use of another type of power adapter will result in malfunction and/or danger.
- Allow adequate ventilation around the adapter when using it to operate the device or charge the battery. Do not cover the power adapter with paper or other objects that will reduce cooling. Do not use the power adapter while it is inside a carrying case.
- Connect the power adapter to a proper power source.
- Do not attempt to service the power adapter. There are no service parts inside. Replace the unit if it is damaged or exposed to excess moisture.

Installation

- Do not use your monitor under any of the following environmental conditions:
 - Extremely high or low temperature, or in direct sunlight
 - Dusty places
 - Highly humid, exposed to rain, or close to water
 - Exposed to vibrations or impacts in places such as cars, buses, trains, and other rail vehicles
 - Near heating appliances such as radiators, heaters, fuel stoves, and other heat-generating items (including audio amplifiers)
 - An enclosed place (such as a closet or bookcase) without appropriate ventilation
 - An uneven or sloping surface
 - Exposed to chemical substances or smoke
- Carry the monitor carefully.
- Do not place heavy loads on the monitor to avoid possible personal injury or damage to the monitor.
- Ensure that children do not hang or climb onto the monitor.
- Keep all packing bags out of reach of children.

Operation

- To protect your eyesight, please refer to the user manual to set the optimal screen resolution and the viewing distance.
- To reduce eye fatigue, take a break on a regular basis while using the monitor.
- Avoid taking either one of the following actions for a long time. Otherwise, burn marks may occur.
 - Play images that cannot occupy the screen entirely.
 - Place a still image on the screen.
- To avoid possible damage to the monitor, do not touch the monitor panel by finger tip, pen, or any other sharp objects.
- Excessively frequent plug and unplug of video connectors may cause damage to the monitor.
- This monitor is designed mainly for personal use. If you want to use the monitor in a public place or a harsh environment, contact your nearest BenQ service center for assistance.
- To avoid possible electric shock, do not disassemble or repair the monitor.
- If a bad smell or an abnormal sound appears to come from the monitor, contact your nearest BenQ service center for assistance immediately.

Caution

- The monitor should be 50 ~ 70 cm (20 ~ 28 inches) away from your eyes.
- Looking at the screen for an extended period of time causes eye fatigue and may deteriorate your eyesight. Rest your eyes for 5 ~ 10 minutes for every 1 hour of product use.
- Reduce your eye strain by focusing on objects far away.
- Frequent blinking and eye exercise help keep your eyes from drying out.

Safety notice for remote control (applicable if a remote control is provided)

- Do not put the remote control in the direct heat, humidity, and avoid fire.
- Do not drop the remote control.
- Do not expose the remote control to water or moisture. Failure to do so could result in malfunction.
- Confirm there is no object between the remote control and the remote sensor of the product.
- When the remote control will not be used for an extended period, remove the batteries.

Battery safety notice (applicable if a remote control is provided)

The use of the wrong type of batteries may cause chemical leaks or explosion. Please note the following:

- Always ensure that the batteries are inserted with the positive and negative terminals in the correct direction as shown in the battery compartment.
- Different types of batteries have different characteristics. Do not mix different types.
- Do not mix old and new batteries. Mixing old and new batteries will shorten battery life or cause chemical leaks from the old batteries.
- When batteries fail to function, replace them immediately.
- Chemicals which leak from batteries may cause skin irritation. If any chemical matter seeps out of the batteries, wipe it up immediately using a dry cloth, and replace the batteries as soon as possible.
- Due to varying storage conditions, the battery life for the batteries included with your product may be shortened. Replace them within 3 months or as soon as you can after initial use.
- There may be local restrictions on the disposal or recycling of batteries. Consult your local regulations or waste disposal provider.

If the supplied remote control contains a coin / button cell battery, pay attention to the following notice as well.

- Do not ingest battery. Chemical Burn Hazard.
- The remote control supplied with this product contains a coin / button cell battery. If the coin / button cell battery is swallowed, it can cause severe internal burns in just 2 hours and can lead to death.
- Keep new and used batteries away from children. If the battery compartment does not close securely, stop using the product and keep it away from children.
- If you think batteries might have been swallowed or placed inside any part of the body, seek immediate medical attention.

Care and cleaning

- Do not place the monitor face down on the floor or a desk surface directly. Otherwise, scratches on the panel surface may occur.
- The equipment is to be secured to the building structure before operation.
- (For models that support wall or ceiling mounting)
 - Install your monitor and monitor mounting kit on a wall with flat surface.
 - Ensure that the wall material and the standard wall mount bracket (purchased separately) are stable enough to support the weight of the monitor.
 - Turn off the monitor and the power before disconnecting the cables from the LCD monitor.

- Always unplug the product from the power outlet before cleaning. Clean the LCD monitor surface with a lint-free, non-abrasive cloth. Avoid using any liquid, aerosol or glass cleaners.
- Slots and openings on the back or top of the cabinet are for ventilation. They must not be blocked or covered. Your monitor should never be placed near or over a radiator or heat sources, or in a built-in installation unless proper ventilation is provided.
- Do not place heavy loads on the monitor to avoid possible personal injury or damage to the monitor.
- Consider keeping the box and packaging in storage for use in the future when you may need to transport the monitor.
- Refer to the product label for information on power rating, manufacture date, and identification markings.

Servicing

- Do not attempt to service this product yourself, as opening or removing covers may expose you to dangerous voltages or other risks. If any of the above mentioned misuse or other accident such as dropping or mishandling occurs, contact qualified service personnel for servicing.
- Contact your place of purchase or visit the local website from Support.BenQ.com for more support.





General warranty information

Note that the monitor warranty may be void if any of the following conditions occurs:

- Documents required for warranty services have been altered by unauthorized use or is illegible.
- The model number or production number on the product has been altered, deleted, removed or made illegible.
- Repairs, modifications, or alterations have been made by unauthorized service organizations or persons.
- Damage caused by improper storage of the monitor (including but not limited to force majeure, direct exposure to sunlight, water, or fire).
- Reception problems occurred due to external signals (such as antenna, Cable TV) outside the monitor.
- Defects caused by abuse or misuse of the monitor.
- Before using the monitor, it is the sole responsibility of the user to check whether the monitor is compatible with local technical standards if the user brings the monitor out of its intended sales area. Failure to do so may cause product breakdown and the user will have to pay the repairing costs.
- It is the sole responsibility of the user if problems (such as data loss and system failure) occurred due to non-factory provided software, parts, and/or non-original accessories.
- Please use the original accessories (e.g. power cable) only with the device to avoid possible dangers such as electric shock and fire.

Typography

Icon / Symbol	Item	Meaning
	Warning	Information mainly to prevent the damage to components, data, or personal injury caused by misuse and improper operation or behavior.
	Tip	Useful information for completing a task.
	Note	Supplementary information.

In this document, the steps needed to reach a menu may be shown in condensed form, for example:
Menu > System > Information.

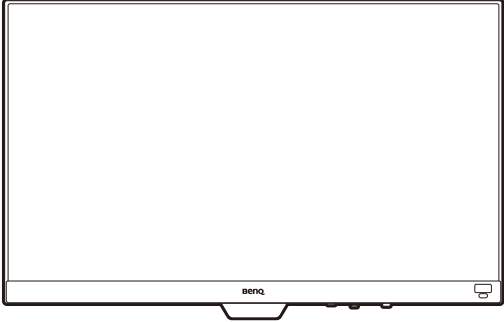
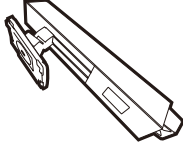

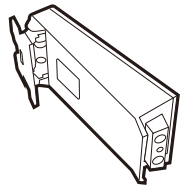



Table of Contents



Copyright	2
Product support	3
Q&A index	4
Safety precautions	6
Power safety	6
Installation	7
Operation.....	7
Safety notice for remote control (applicable if a remote control is provided)	8
Battery safety notice (applicable if a remote control is provided)	8
Care and cleaning.....	8
Servicing.....	9
General warranty information	9
Getting started	13
Getting to know your monitor	15
Front view	15
Back view	16
Connections	17
How to assemble your monitor hardware (for monitors with height adjustment stand)	19
How to detach the stand and the base (for monitors with height adjustment stand)	25
Using the monitor wall mounting kit (purchased separately) (for models with height adjustment stand)	27
How to assemble your monitor hardware (for monitors without height adjustment stand) ...	28
How to detach the stand and the base (for monitors without height adjustment stand)	33
Using the monitor wall mounting kit (purchased separately) (for models without height adjustment stand)	34
How to adjust your monitor	36
The control panel.....	36
5-way controller and basic menu operations	37
Setting up your monitor for different scenarios.....	38
Switching the inputs quickly with the looping key.....	39
Working with the Quick Menu	40
Available menu options to each Color Mode	42
Adjustable OSD settings.....	42
Working with the HDRi hot key.....	43
Adjusting screen brightness automatically (Bright Intelligence Plus).....	43
Working with HDR technology.....	44
Choosing an audio scenario.....	45
Adjusting display mode	45
Choosing an appropriate color mode.....	45
Connecting the monitor to your MacBook series product.....	45
Enabling color vision accessibility (Color Weakness).....	45

Activating FreeSync™ Premium	46
Working with Video Format Support technology.....	46
Initial setup for playing games at 165 Hz	46
Navigating the main menu	48
Input menu	49
Quick Menu	50
Color Mode menu	52
Eye care menu	55
Audio menu	57
System menu	58
Troubleshooting	61
Frequently asked questions (FAQ).....	61
Need more help?.....	63

Getting started

When unpacking please check you have the following items. If any are missing or damaged, please contact the place of purchase for a replacement.

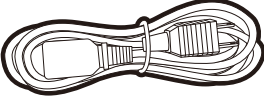
BenQ LCD Monitor	
Monitor Stand (for EX240)	
Monitor Base (for EX240)	
Monitor Stand (for EX240N)	
Monitor Base (for EX240N)	
Quick Start Guide	
Safety Instructions	
Regulatory Statements	

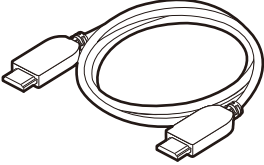
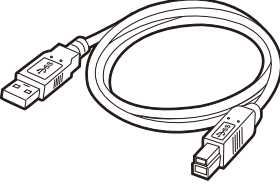
<p>Power Cord (Supplied item may differ by model or region.)</p>	
<p>I/O Cover (for models with height adjustment stand)</p>	
<p>Video Cable: HDMI</p>	
<p>USB Cable (Optional accessory)</p>	



- Available accessories and the pictures shown here may differ from the actual contents and the product supplied for your region. And the package contents may subject to change without prior notice. For cables that are not supplied with your product, you can purchase them separately.
- Consider keeping the box and packaging in storage for use in the future when you may need to transport the monitor. The fitted foam packing is ideal for protecting the monitor during transport.
- Accessories and cables may be included or sold separately depending on the product supplied for your region.



Always keep the product and accessories out of reach of small children.

Getting to know your monitor

Front view

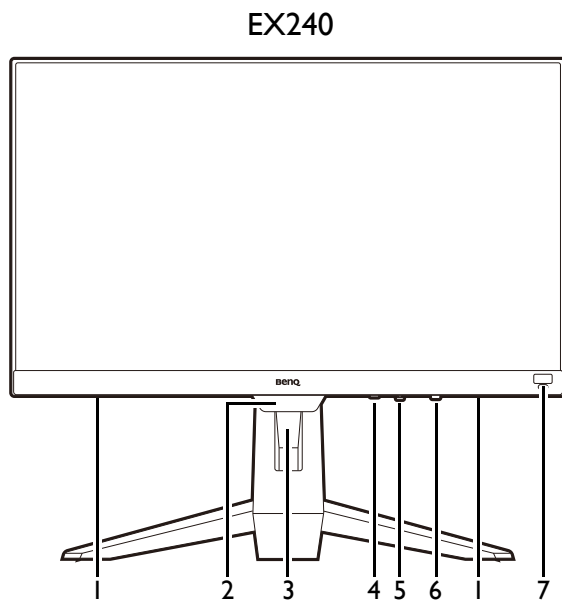

1. Speakers
2. Light sensor
3. Cable management hole
4. Looping key

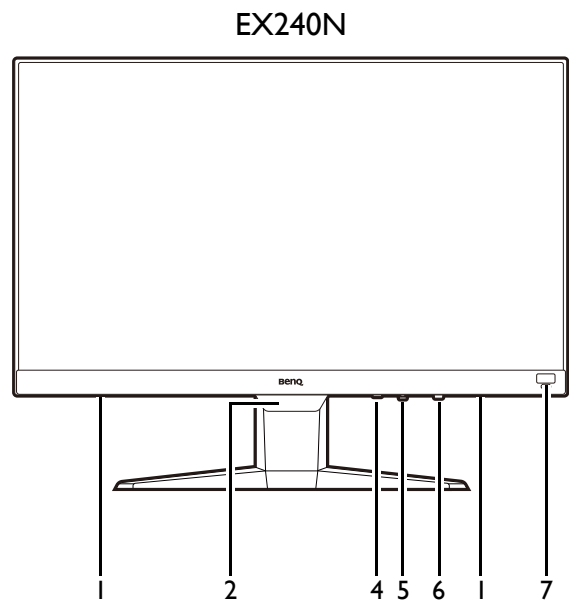

5. 5-way controller
6. Power button and LED indicator
7. HDRi hot key

Back view

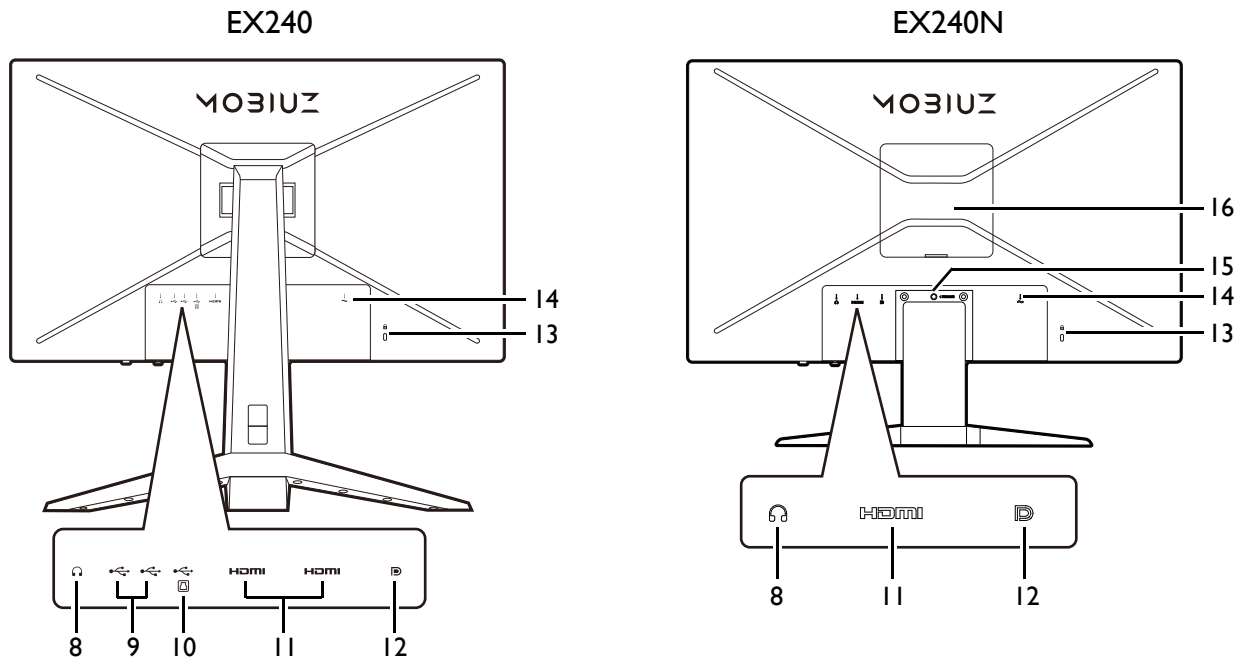

8. Headphone jack
9. USB 3.1 port (downstream; connecting to USB devices)
10. USB 3.1 port (upstream; connecting to PC)
11. HDMI socket
12. DisplayPort socket
13. Kensington lock slot
14. AC power input jack
15. Stand release button
16. VESA cover



- Above diagram may vary depending on the model.
- Picture may differ from product supplied for your region.

Connections

The following connection illustrations are for your reference only. For cables that are not supplied with your product, you can purchase them separately.

For detailed connection methods, see page [20](#).

EX240

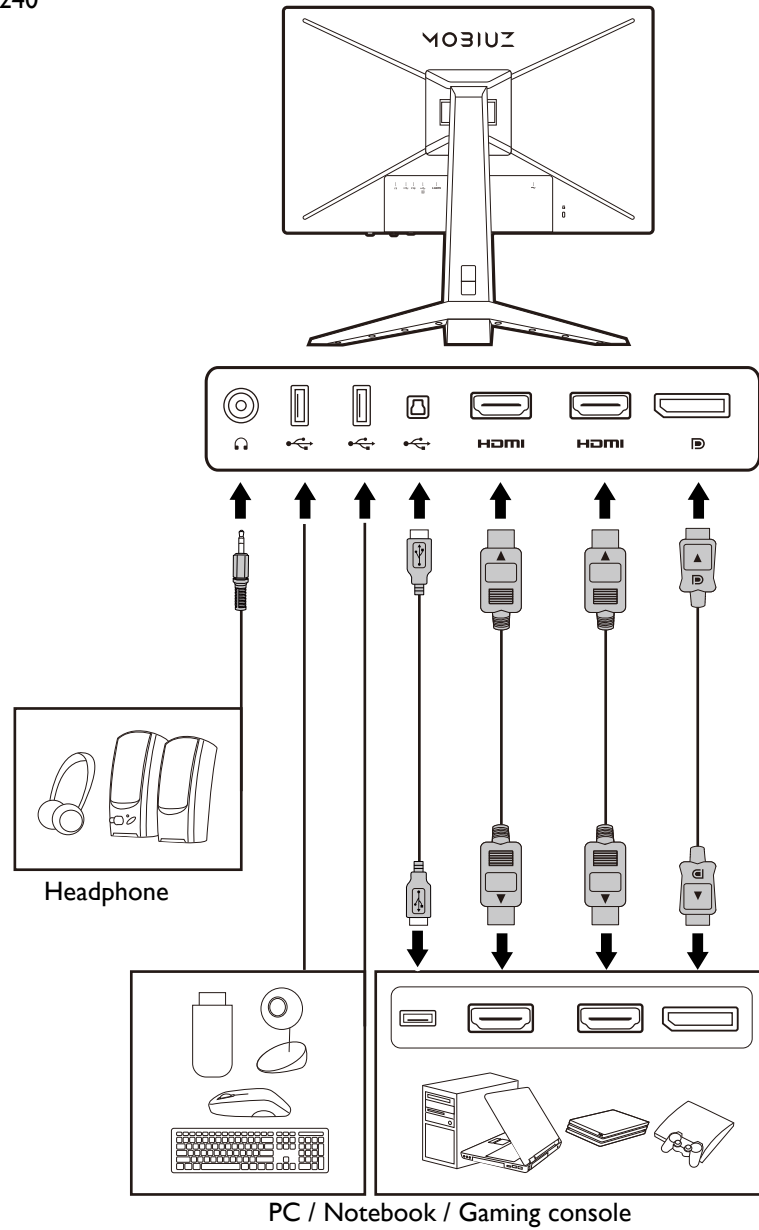

For detailed connection methods, see page 30.

EX240N

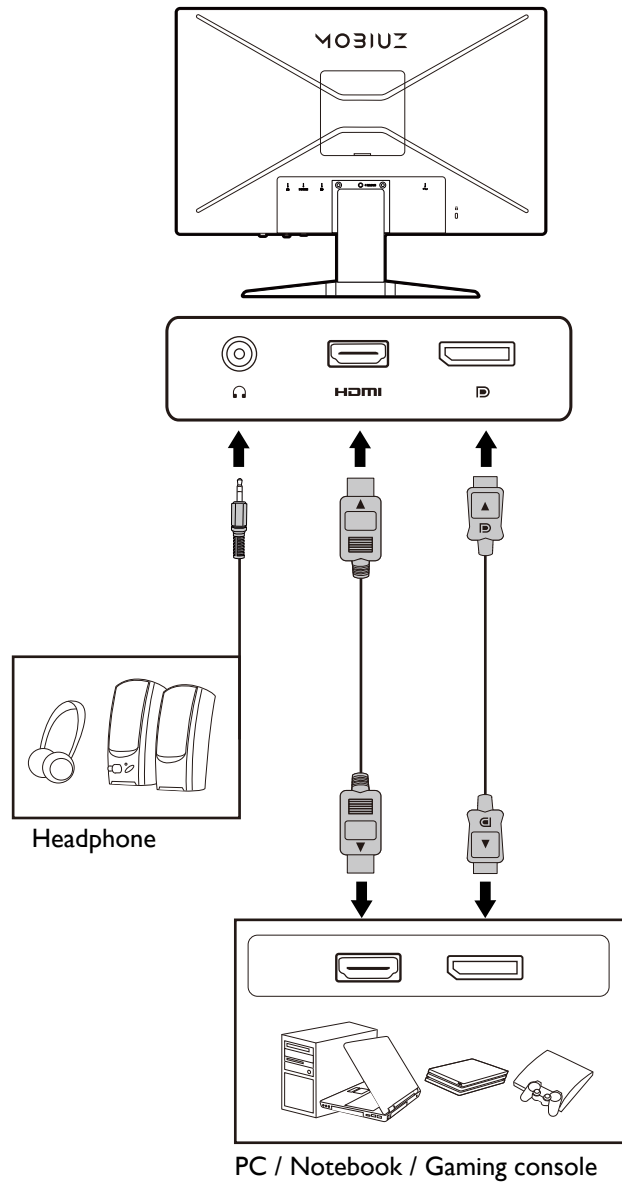

How to assemble your monitor hardware (for monitors with height adjustment stand)



- If the computer is turned on you must turn it off before continuing. Do not plug-in or turn-on the power to the monitor until instructed to do so.
- The following illustrations are for your reference only. Available input and output jacks may vary depending on the purchased model.
- Avoid finger pressure on the screen surface.

I. Attach the monitor base.



Please be careful to prevent damage to the monitor. Placing the screen surface on an object like a stapler or a mouse will crack the glass or damage the LCD substrate voiding your warranty. Sliding or scraping the monitor around on your desk will scratch or damage the monitor surround and controls.

Protect the monitor and screen by clearing a flat open area on your desk and placing a soft item like the monitor packaging bag on the desk for padding.

Gently lay the screen face down on a flat clean padded surface.

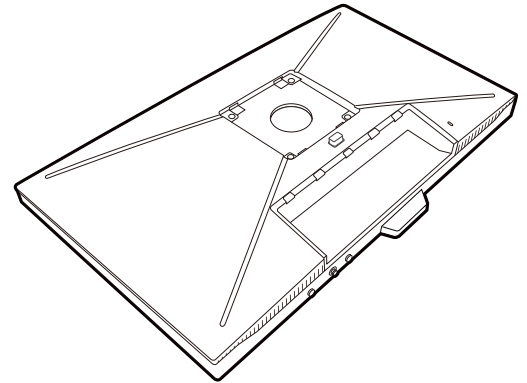

Attach the monitor stand to the monitor base as illustrated until it locks in place. Raise the thumbscrew lid and tighten the thumbscrew as illustrated. Then push the lid back.

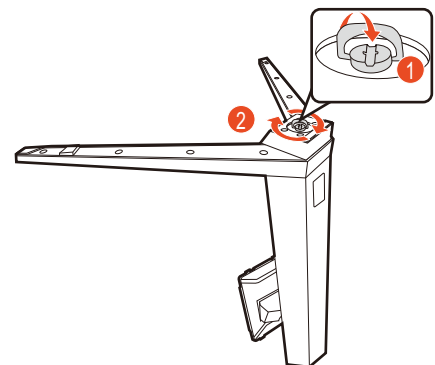

Orient and align the stand arm with the monitor, then push them together until they click and lock into place.

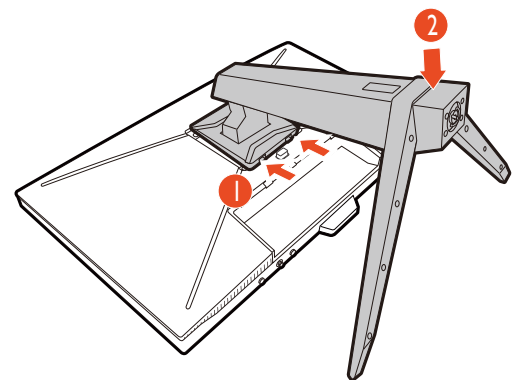

Carefully lift the monitor, turn it over and place it upright on its stand on a flat even surface.

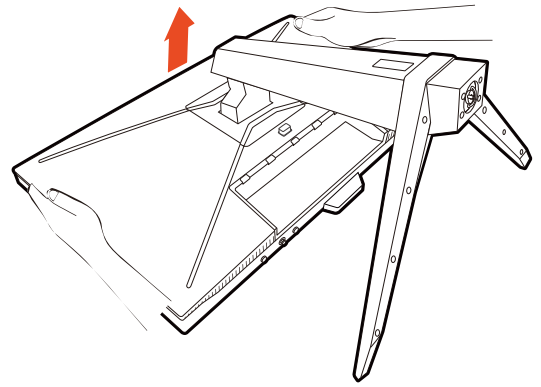

2. Connect the power cable to the monitor.

Pass the cable through the cable management hole on the stand arm first.

Plug one end of the power cord into the socket labelled  on the rear of the monitor. Do not connect the other end to a power outlet just yet.

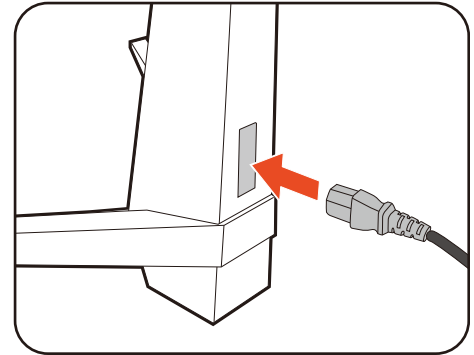

3. Connect the video cable.



The video cables included in your package and the socket illustrations in this document may vary depending on the product supplied for your region.

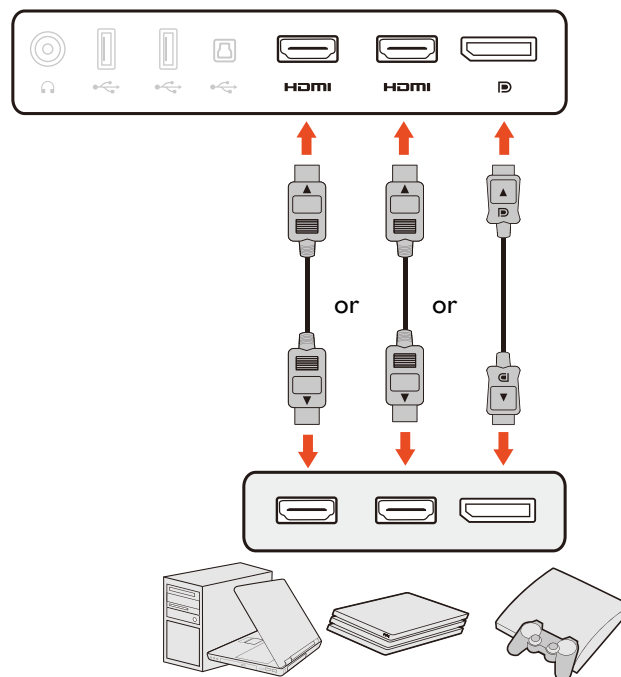

- Connect the plug of the HDMI cable to the HDMI port on the monitor. Connect the other end of the cable to the HDMI port of a digital output device.
- Connect the plug of the DP cable to the monitor video socket. Connect the other end of the cable to the computer video socket.

4. Connect the audio cable.

You may connect headphones to the headphone jack found on the back side of the monitor.

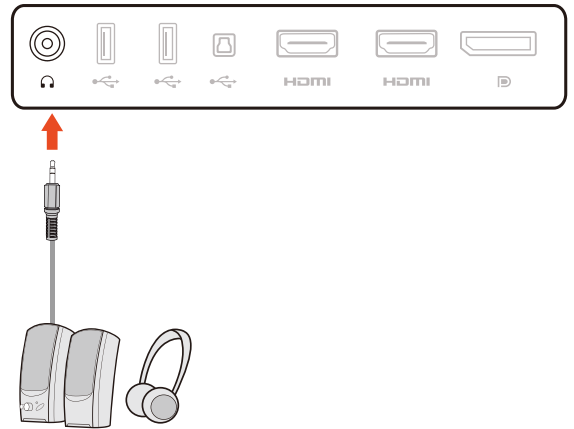

5. Connect USB devices.

Connect the USB cable between the PC and the monitor (via the upstream USB port at the back). This upstream USB port transmits data between the PC and the USB devices connected to the monitor.

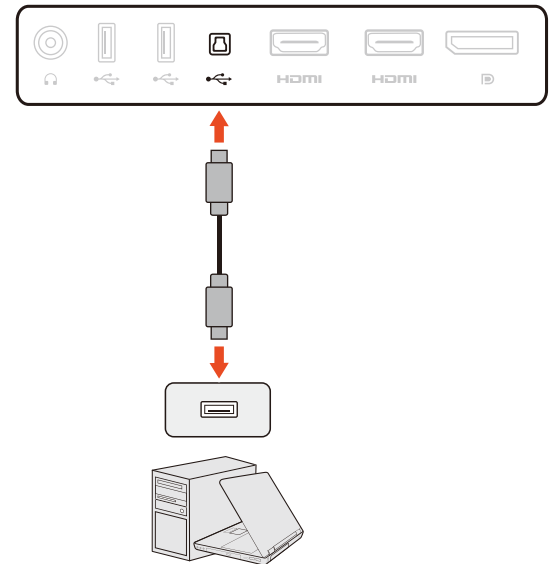

Connect USB devices via other USB ports (downstream) on the monitor. These downstream USB ports transmit data between connected USB devices and the upstream port.

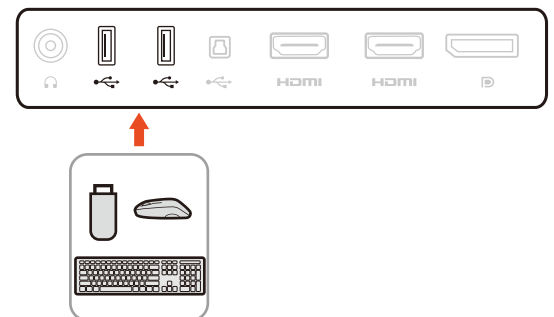

6. Organize the cables.

! Allow enough cable length while cabling to avoid loose connection and to save the pins or socket connectors from being bent or broken.

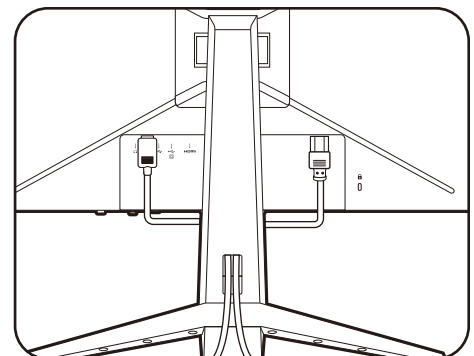

7. Install the I/O cover.

Gently lift the display up and extend it to the maximum extended position. Then tilt the monitor to install/remove the I/O cover easily.

Align the I/O cover with the holes on the back of the monitor, and press the sides and the bottom of the cover against the holes to lock it into place. Push from the bottom of the cover and check if it has been installed properly.

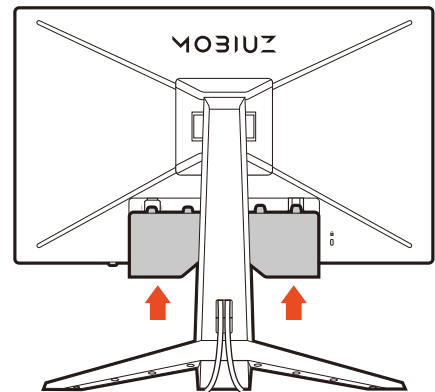
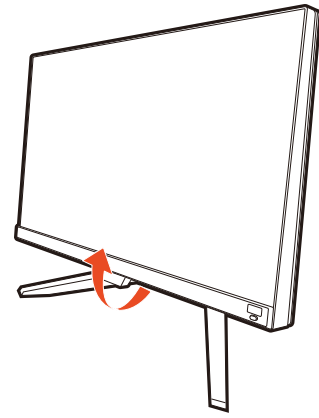

8. Adjust the monitor height.

To adjust the monitor height, hold both the top and the bottom of the monitor to lower the monitor or lift it up to the desired height.



Your monitor is an edge-to-edge monitor and should be handled with care. Avoid finger pressure on the screen surface. Excessive force on the display is prohibited.

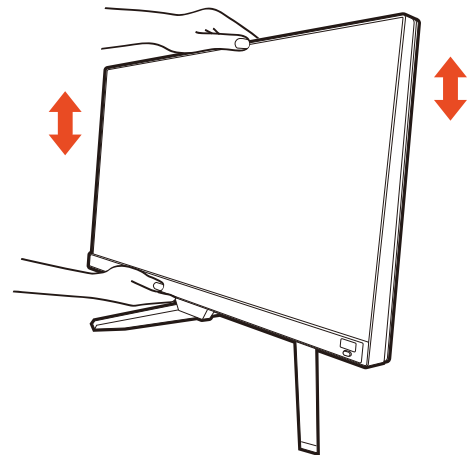

Avoid placing hands on the upper or lower part of the height-adjustable stand or at the bottom of the monitor, as ascending or descending monitor might cause personal injuries. Never place your hand on the stand either when tilting the monitor upward or downward. Keep children out of reach of the monitor while performing this operation.

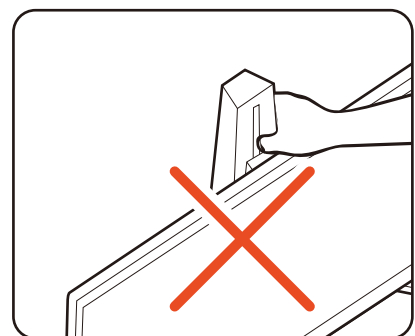

9. Tilt the monitor.

You should position the monitor and angle the screen to minimize unwanted reflections from other light sources.

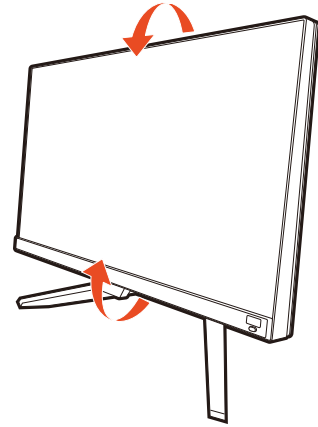

10. Connect-to and turn-on the power.

Plug the other end of the power cord into a power outlet and turn it on.



Picture may differ from product supplied for your region.

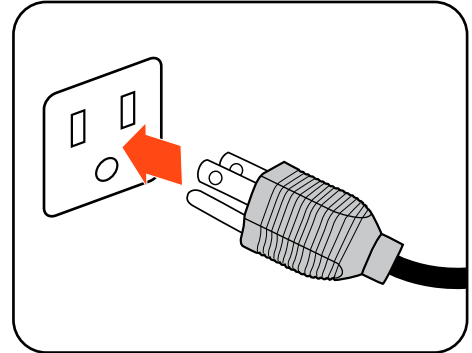

Turn on the monitor by pressing the power button on the monitor.

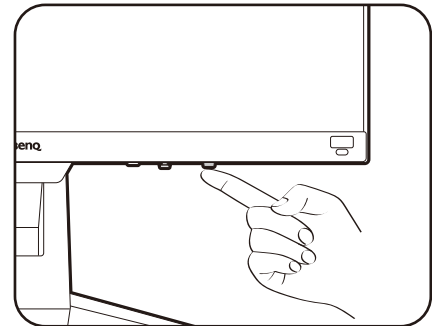

Turn on the computer too. If you have multiple video sources, press the looping key and the 5-way controller to select an input source.



To extend the service life of the product, we recommend that you use your computer's power management function.

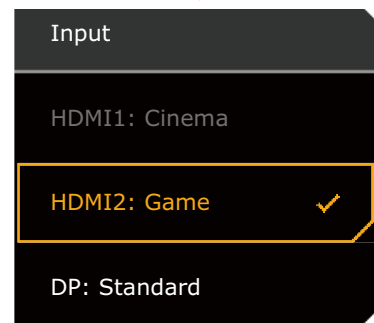
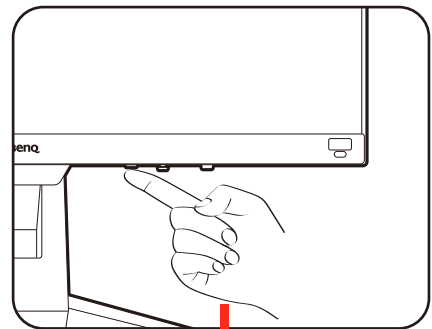

11. Setting up the monitor for certain scenarios.

You are prompted to set the monitor to work in specified scenarios when powering on the monitor for the first time. See [Setting up your monitor for different scenarios on page 38](#) to complete the configuration.

How to detach the stand and the base (for monitors with height adjustment stand)

1. Prepare the monitor and area.

Turn off the monitor and the power before unplugging the power cable. Turn off the computer before unplugging the monitor signal cable.

2. Remove the I/O cover.

Gently lift the display up and extend it to the maximum extended position. Then tilt the monitor to install/remove the I/O cover easily.

Remove the I/O cover from its bottom as illustrated. You might want to tilt the monitor to remove it easily. Unplug all cables carefully.

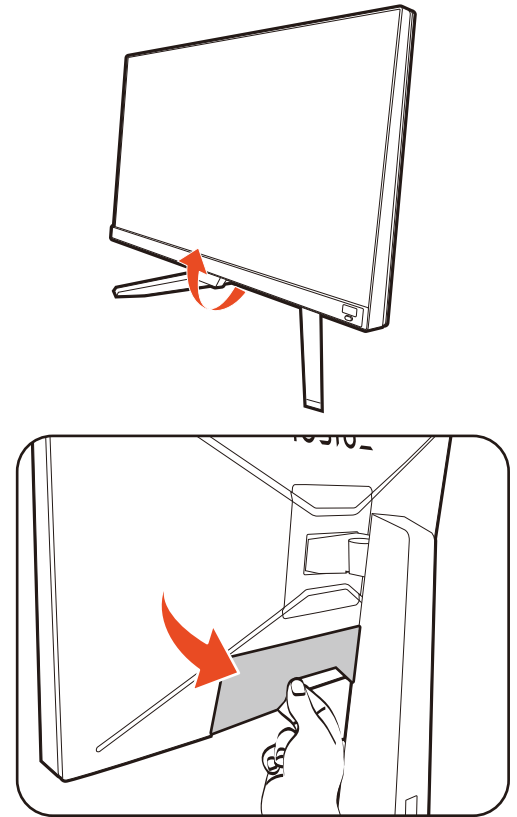

Protect the monitor and screen by clearing a flat open area on your desk and placing a soft item like a towel on the desk for padding, before laying the screen face down on a flat clean padded surface.



Please be careful to prevent damage to the monitor. Placing the screen surface on an object like a stapler or a mouse will crack the glass or damage the LCD substrate voiding your warranty. Sliding or scraping the monitor around on your desk will scratch or damage the monitor surround and controls.

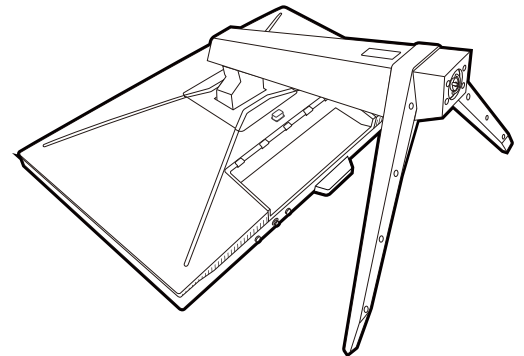

3. Remove the monitor stand.

While pressing and holding the VESA mount release button (1), detach the stand from the monitor (2 and 3).

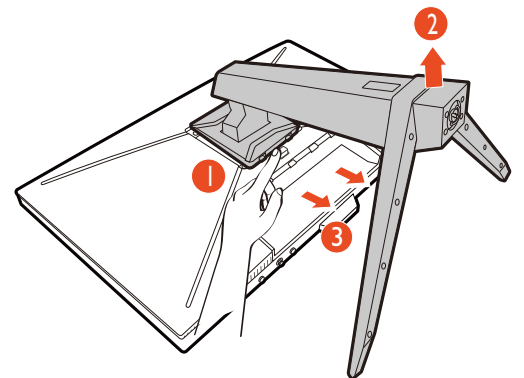

4. Remove the monitor base.

Release the screw on the bottom of the monitor base and detach the monitor base as illustrated.



In case you intend to use your monitor on the stand in the future, please keep the monitor base and monitor stand somewhere safe for future use.

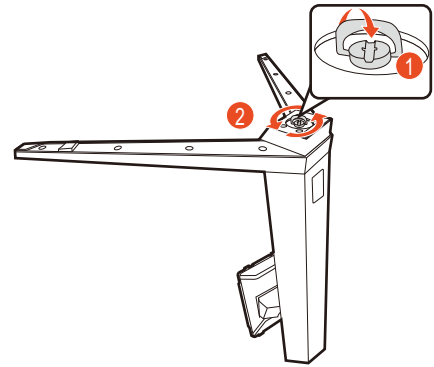

Using the monitor wall mounting kit (purchased separately) (for models with height adjustment stand)

The back of your LCD monitor has a VESA standard mount with 100mm pattern, allowing the installation of a wall mount bracket. Before starting to install a monitor wall mounting kit, please read the precautions carefully.

Precautions

- Install your monitor and monitor mounting kit on a wall with flat surface.
- Ensure that the wall material and the standard wall mount bracket (purchased separately) are stable enough to support the weight of the monitor. Refer to the product specifications on the website for weight information.
- Turn off the monitor and the power before disconnecting the cables from the LCD monitor.

1. Remove the monitor stand.

Lay the screen face down on a clean and well-padded surface. Detach the monitor stand as instructed in step 1~2 in [How to detach the stand and the base \(for monitors with height adjustment stand\) on page 25](#).

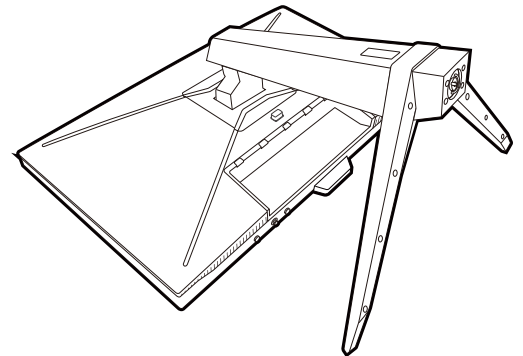

2. Remove the screws on the back cover.

Use a cross-pointed screwdriver to release the screws on the back cover. The use of a magnetic-head screwdriver is recommended to avoid losing the screws.

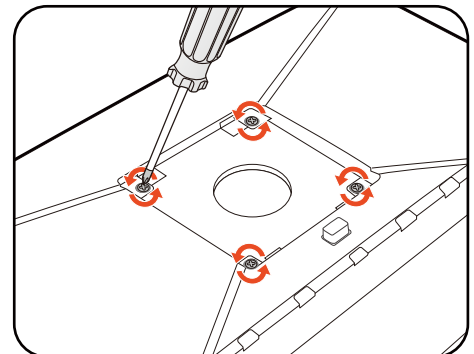

3. Follow the instruction manuals of the wall mount bracket you purchased to complete the installation.



Use four M4 x 10 mm screws to fix a VESA standard wall mount bracket to the monitor. Make sure that all screws are tightened and secured properly. Consult a professional technician or BenQ service for wall mount installation and safety precautions.

How to assemble your monitor hardware (for monitors without height adjustment stand)



- If the computer is turned on you must turn it off before continuing. Do not plug-in or turn-on the power to the monitor until instructed to do so.
- The following illustrations are for your reference only. Available input and output jacks may vary depending on the purchased model.
- Avoid finger pressure on the screen surface.

I. Attach the monitor base.



Please be careful to prevent damage to the monitor. Placing the screen surface on an object like a stapler or a mouse will crack the glass or damage the LCD substrate voiding your warranty. Sliding or scraping the monitor around on your desk will scratch or damage the monitor surround and controls.

Protect the monitor and screen by clearing a flat open area on your desk and placing a soft item like the monitor packaging bag on the desk for padding.

Gently lay the screen face down on a flat clean padded surface.

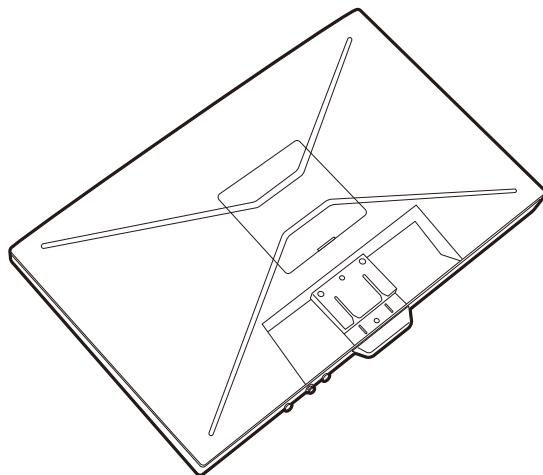

Attach the monitor stand to the monitor base as illustrated until it locks in place.

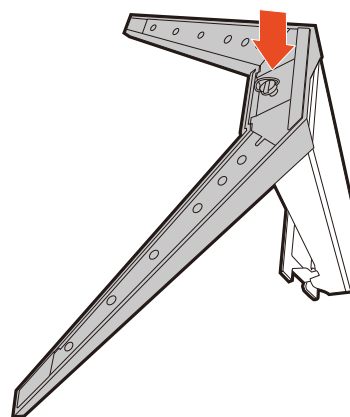

Raise the thumbscrew lid and tighten the thumbscrew as illustrated. Then push the lid back.

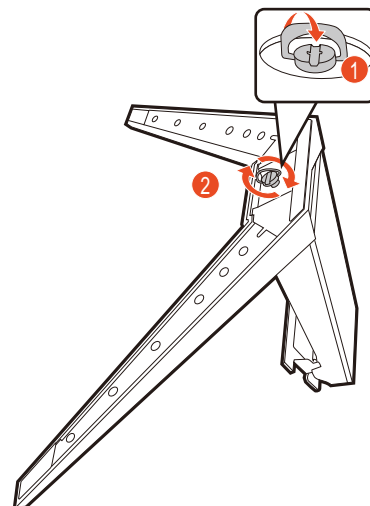

Orient and align the stand arm with the monitor, then push them together until they click and lock into place.

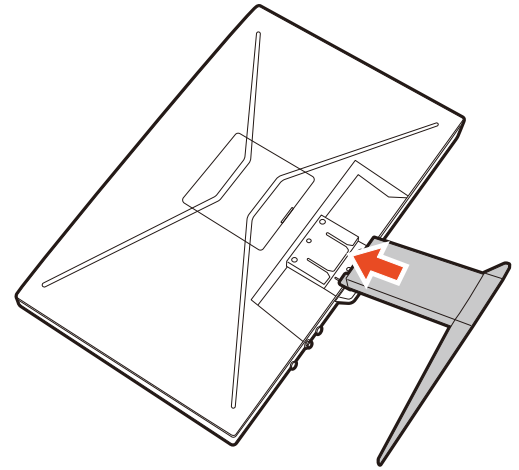

Carefully lift the monitor, turn it over and place it upright on its stand on a flat even surface.

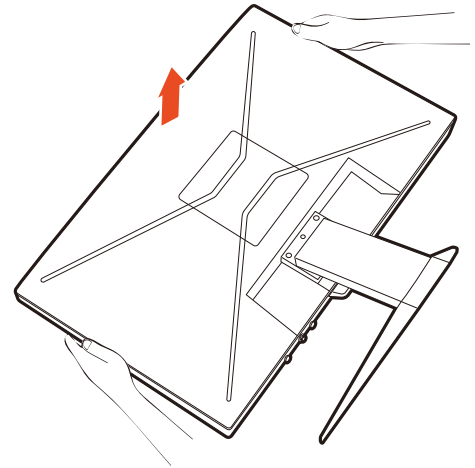

2. Remove the cover of the cable management system.

The stand arm also works as a cable management system that helps keep the cables neat and clean. Slide the cable cover up to align the marking on the cable cover with the unlock icon on the stand arm. Remove the cover as illustrated.

Pass the cable through the cable management hole on the stand arm first while cabling. Start with the ones with bigger connectors.

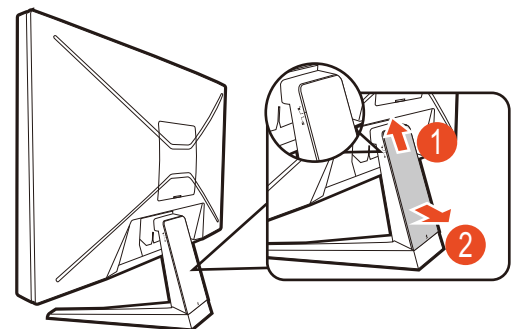

Allow enough cable length while cabling to avoid loose connection and to save the pins or socket connectors from being bent or broken.

3. Connect the power cable to the monitor.

Pass the cable through the cable management hole on the stand arm first.

Plug one end of the power cord into the socket labelled  on the rear of the monitor. Do not connect the other end to a power outlet just yet.

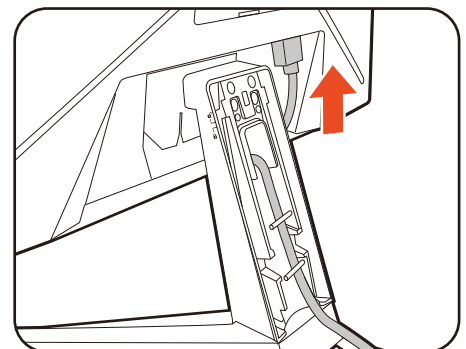

4. Connect the video cable.



The video cables included in your package and the socket illustrations in this document may vary depending on the product supplied for your region.

- Connect the plug of the HDMI cable to the HDMI port on the monitor. Connect the other end of the cable to the HDMI port of a digital output device.
- Connect the plug of the DP cable to the monitor video socket. Connect the other end of the cable to the computer video socket.

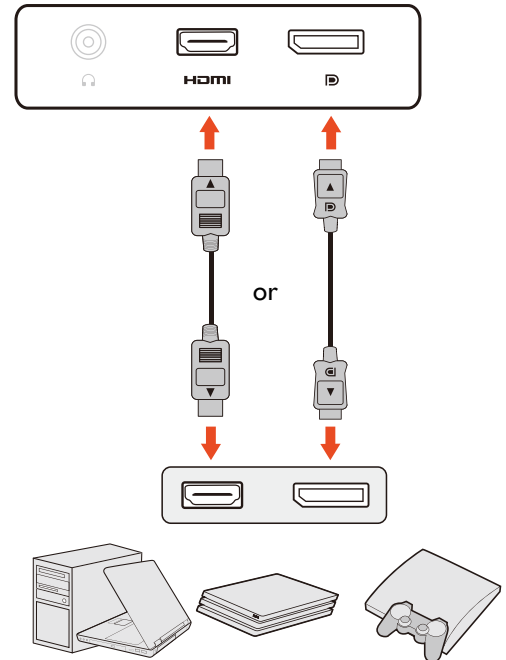

5. Connect the audio cable.

You may connect headphones to the headphone jack found on the back side of the monitor.

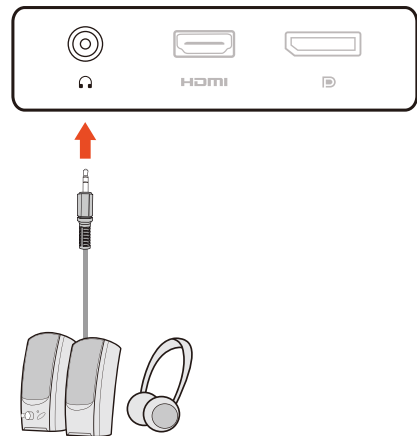

6. Install the cable cover.

After all cables have been connected to the monitor, work with the cable management system to route the cables properly.

Align the marking on the cable cover to the unlock icon on the stand arm. Install the cable cover back to the stand arm, and slide down to lock it into place. The marking on the cable cover should be aligned with the lock icon on the stand arm by now.

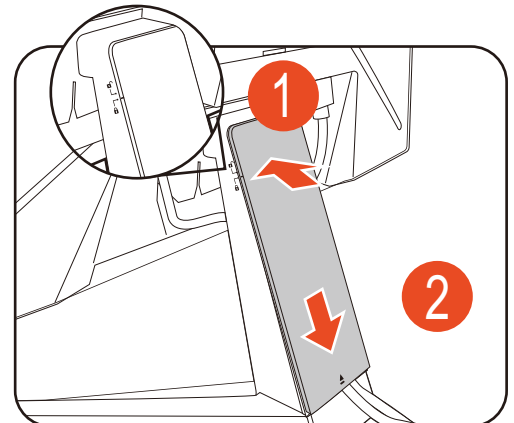

7. Tilt the monitor.

You should position the monitor and angle the screen to minimize unwanted reflections from other light sources.

- ! Your monitor is an edge-to-edge monitor and should be handled with care. Avoid finger pressure on the screen surface. Excessive force on the display is prohibited.

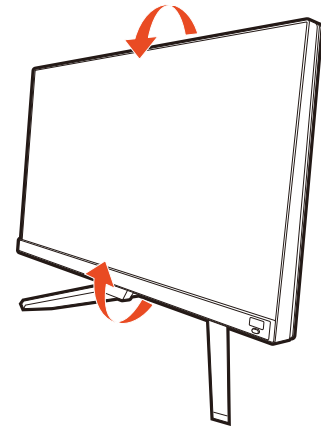

8. Connect-to and turn-on the power.

Plug the other end of the power cord into a power outlet and turn it on.

- 🔧 Picture may differ from product supplied for your region.

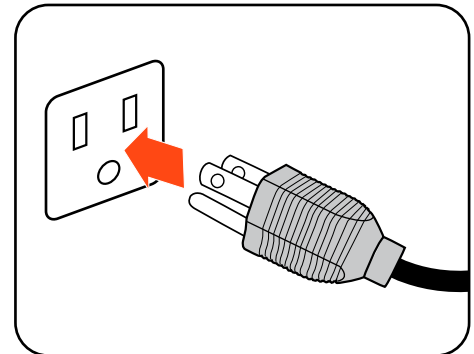

Turn on the monitor by pressing the power button on the monitor.

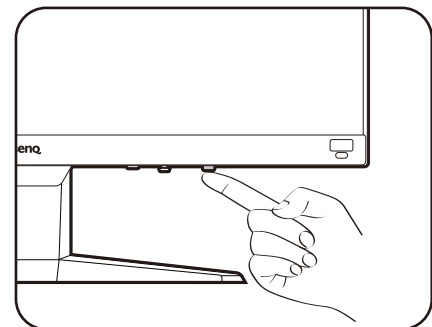

Turn on the computer too. If you have multiple video sources, press the looping key and the 5-way controller to select an input source.

- 💡 To extend the service life of the product, we recommend that you use your computer's power management function.

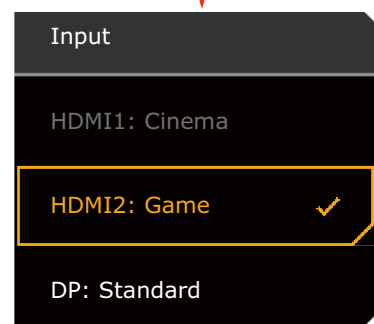
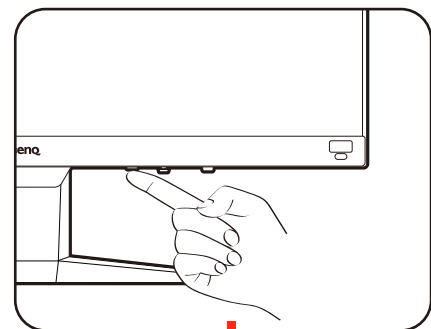

9. Setting up the monitor for certain scenarios.

You are prompted to set the monitor to work in specified scenarios when powering on the monitor for the first time. See [Setting up your monitor for different scenarios on page 38](#) to complete the configuration.

How to detach the stand and the base (for monitors without height adjustment stand)

1. Prepare the monitor and area.

Turn off the monitor and the power before unplugging the power cable. Turn off the computer before unplugging the monitor signal cable.

Protect the monitor and screen by clearing a flat open area on your desk and placing a soft item like a towel on the desk for padding, before laying the screen face down on a flat clean padded surface.



Please be careful to prevent damage to the monitor. Placing the screen surface on an object like a stapler or a mouse will crack the glass or damage the LCD substrate voiding your warranty. Sliding or scraping the monitor around on your desk will scratch or damage the monitor surround and controls.

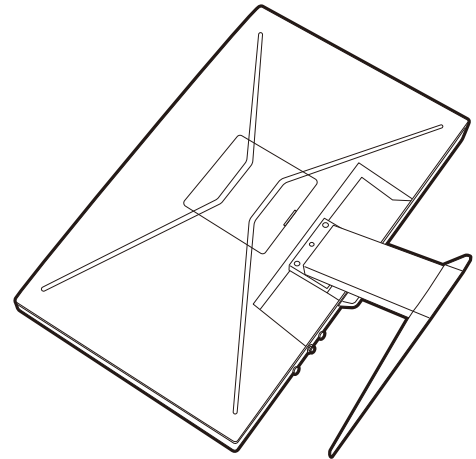

2. Remove the monitor stand.

Push down the stand gently until you cannot go further so you can see the release button clearly.

Insert a pointed object such as a screwdriver to the hole above the monitor stand arm, and then push the screwdriver against the release button inside the hole. Then pull the monitor stand backward away from the monitor.

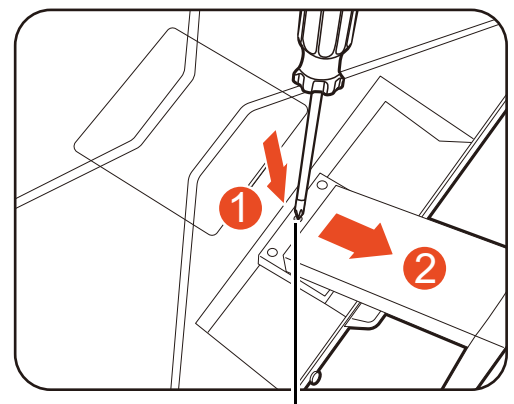

Release button

3. Remove the monitor base.

Release the screw on the bottom of the monitor base and detach the monitor base as illustrated.



In case you intend to use your monitor on the stand in the future, please keep the monitor base and monitor stand somewhere safe for future use.

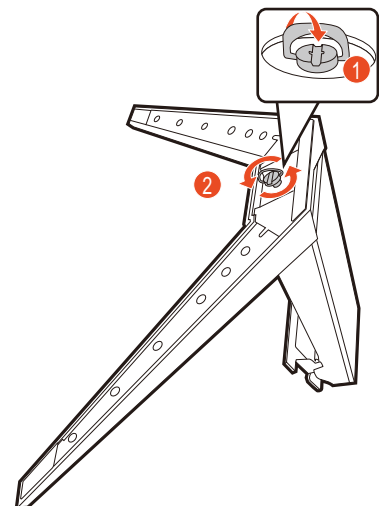

Using the monitor wall mounting kit (purchased separately) (for models without height adjustment stand)

The back of your LCD monitor has a VESA standard mount with 100mm pattern, allowing the installation of a wall mount bracket. Before starting to install a monitor wall mounting kit, please read the precautions carefully.

Precautions

- Install your monitor and monitor mounting kit on a wall with flat surface.
- Ensure that the wall material and the standard wall mount bracket (purchased separately) are stable enough to support the weight of the monitor. Refer to the product specifications on the website for weight information.
- Turn off the monitor and the power before disconnecting the cables from the LCD monitor.

1. Remove the monitor stand.

Lay the screen face down on a clean and well-padded surface. Detach the monitor stand as instructed in step 1~2 in [How to detach the stand and the base \(for monitors without height adjustment stand\)](#) on page 33.

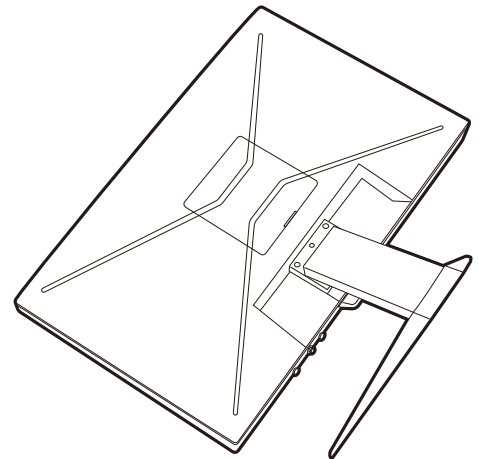

2. Remove the VESA cover and the screws.

Remove the VESA cover as illustrated, and then use a cross-pointed screwdriver to release the screws inside. The use of a magnetic-head screwdriver is recommended to avoid losing the screws.

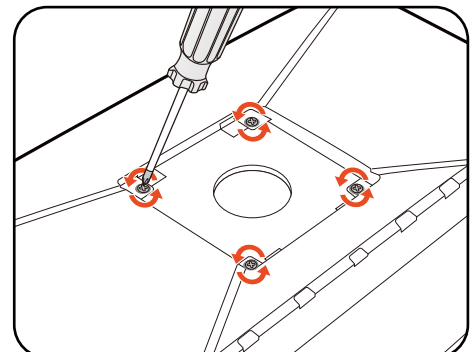
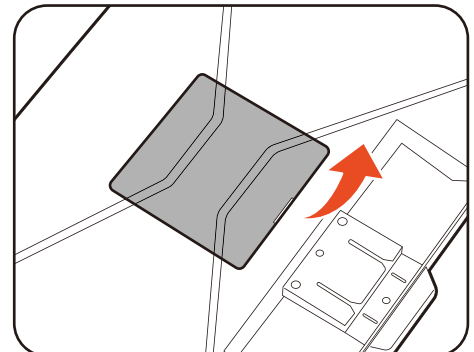

3. Follow the instruction manuals of the wall mount bracket you purchased to complete the installation.



Use four M4 x 10 mm screws to fix a VESA standard wall mount bracket to the monitor. Make sure that all screws are tightened and secured properly. Consult a professional technician or BenQ service for wall mount installation and safety precautions.

How to adjust your monitor

The control panel

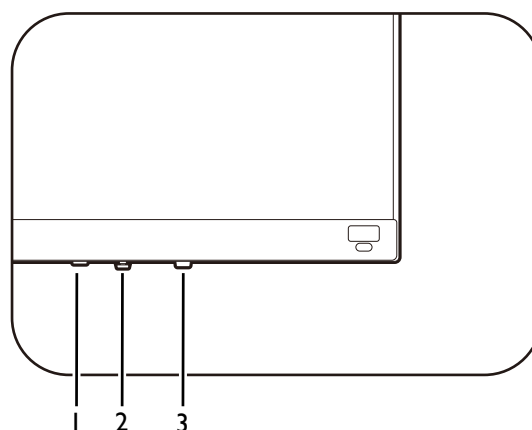



No.	Name	Description
1.	Looping key	Accesses video source selection menu. See Switching the inputs quickly with the looping key on page 39 for more information.
2.	5-way controller	Accesses the functions or menu items as instructed by the on-screen icons. See 5-way controller and basic menu operations on page 37 for more information.
3.	Power key	Turns the power on or off.

5-way controller and basic menu operations

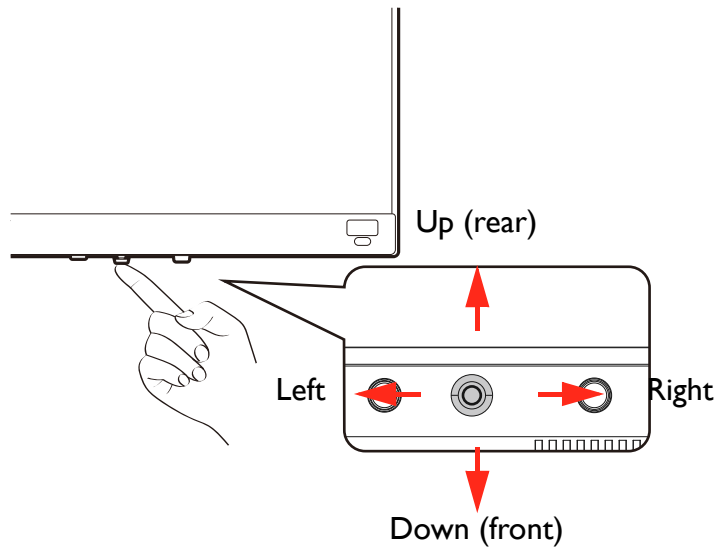
The 5-way controller is located at the rear of the monitor. While sitting in front of the monitor, move the controller to the directions instructed by the on-screen icons for menu navigation and operations.



OSD icon	5-way controller operation	Function
(With an available video input but no menu has been activated)		
N/A	Press center or move to the right / left	Activates the Quick Menu .
N/A	Move up / down	Adjusts volume.
(When the video source selection menu has been activated)		
	Move up / down	Switches to the desired input source.
(When the Quick Menu has been activated)		
	Move up / down	Goes to the previous / next menu setting.
	Move to the right / left	<ul style="list-style-type: none"> Goes to the next / previous menu item. (When Menu is highlighted) Move to the left to close the Quick Menu; move to the right to access the main menu.
	Press center	<ul style="list-style-type: none"> Closes the Quick Menu. (When Menu is highlighted) Accesses the main menu.
(When the main menu has been activated)		
	Press center	Confirms the selection.
	Move to the right	<ul style="list-style-type: none"> Enters sub menus. Confirms the selection.
	Move up	<ul style="list-style-type: none"> Goes to the previous menu item. For up / increase adjustment.

OSD icon	5-way controller operation	Function
	Move down	<ul style="list-style-type: none"> • Goes to the next menu item. • For down / decrease adjustment.
	Move to the left	<ul style="list-style-type: none"> • Returns to the previous menu. • Exits OSD menu.

All OSD (On Screen Display) menus can be accessed by the control keys. You can use the OSD menu to adjust all the settings on your monitor. Available menu options may vary depending on the input sources, functions and settings.

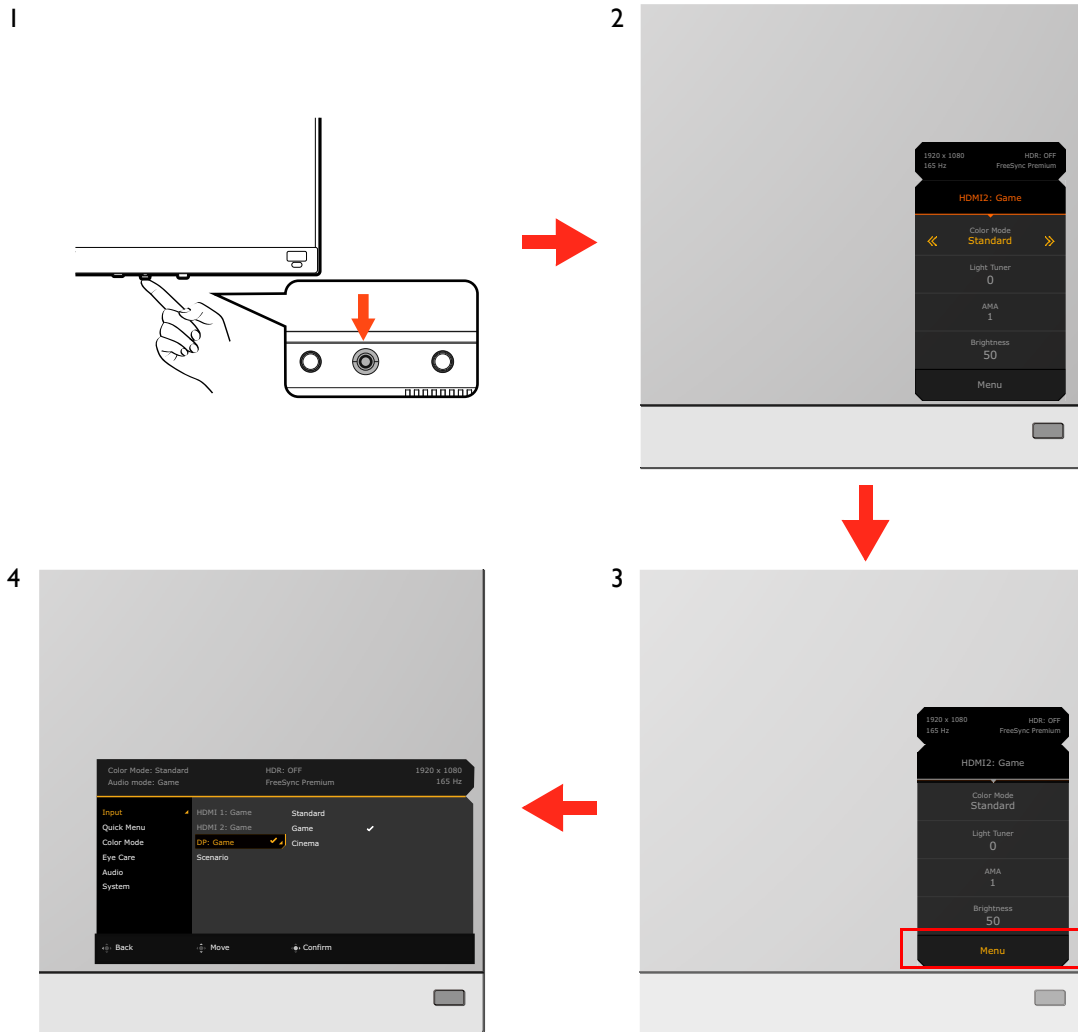

1. Press the 5-way controller.
2. The **Quick Menu** is displayed.
3. Select **Menu** to access the main menu.
4. On the main menu, follow the on-screen icons on the bottom of the menu to make adjustments or selection. See [Navigating the main menu on page 48](#) for details on the menu options.

Setting up your monitor for different scenarios

Depending on the environment the product is used, there are several input ports on your monitor and you can preset a scenario for each input respectively. If possible, complete the connections and

configuration on the first use of the monitor, so you can switch scenarios easily without further hasty setup.

An example of monitor use in different scenarios

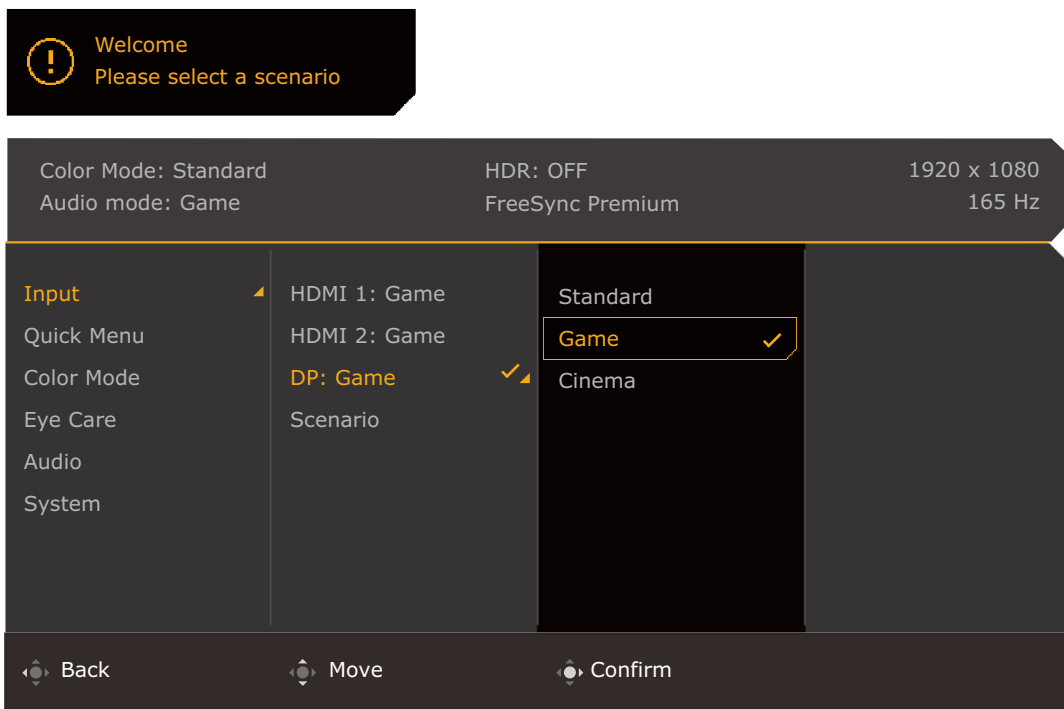
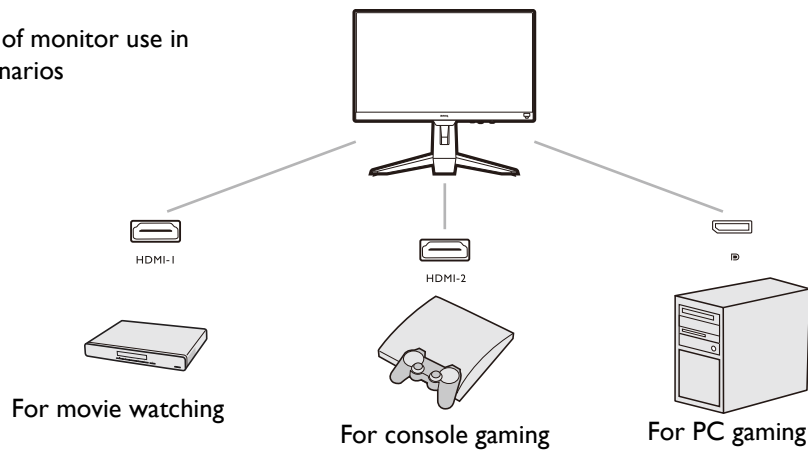

1. Connect the input sources to the monitor properly as instructed in [Connect the video cable. on page 20](#) / [Connect the video cable. on page 30](#).
2. Select a scenario for an available input source. The scenario changes with the input source. If you skip the configuration now, the scenario is preset to be **Game** for each input source. You can change the setting from **Menu > Input** later.
3. To switch an input source / scenario, press the looping key. See [Switching the inputs quickly with the looping key on page 39](#) for more information.



- You are prompted to complete the configuration again after a system reset from **Menu > System > Reset All**.
- If you have switched off the scenario configuration from **Menu > Input > Scenario**, the scenario of each input is set to be **Standard** by default.

Switching the inputs quickly with the looping key





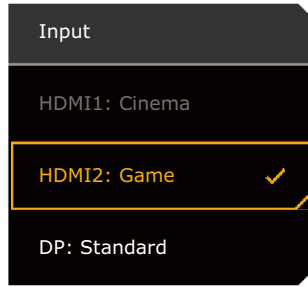

1. Press the looping key to bring up the input source selection menu. Each source is preset for a scenario as described in [Setting up your monitor for different scenarios on page 38](#). The scenario changes with the input source.

2. Press the looping key repeatedly to cycle through the available video sources.





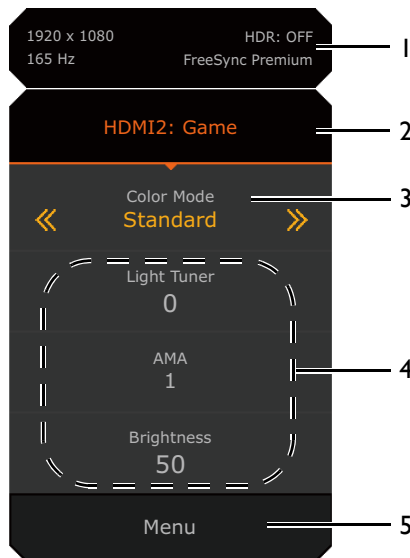

Working with the Quick Menu

The **Quick Menu** is a quick access to change some monitor settings frequently adjusted by scenario. It also provides the access to the main menu.

- Press  /  /  to bring up the **Quick Menu**.
- Press  /  to different settings.
- Go to **Menu** and press  to access the main menu.









No.	Item	Description
1	System information	Displays current system information, including resolution, refresh rate, HDR status, and Adaptive-Sync status.
2	Input source and the preset scenario	Displays the current video source / scenario. To change the scenario that goes with an input, go to Menu > Input . See Setting up your monitor for different scenarios on page 38 for more information.
3	Color mode	Press  /  to cycle through the available color modes. See Color Mode on page 52 for more information.
4	Quick settings	Press  /  to make adjustments. The default setting menus vary by scenario and may not be adjustable on certain color modes. See Available menu options to each Color Mode on page 42 for available options on each color mode. To customize the setting menus that can be accessed from the Quick Menu , see Customizing the Quick Menu on page 41 .

No.	Item	Description
5	Main menu	Accesses the main menu. See Navigating the main menu on page 48 for more information.

Customizing the Quick Menu

By default, there are 3 settings that could be customized to go with each scenario on the **Quick Menu**. Change the settings if desired.

1. Press  /  /  to bring up the **Quick Menu**.
2. Go to **Menu > Quick Menu**.
3. Select a scenario and press  for further selection.
4. The first two items are grayed out and cannot be changed. Select one available item and press  for further selection.
5. Scroll to one item and press  /  for confirmation. A setting menu is grayed out on the **Quick Menu** if the it is not supported by a color mode.

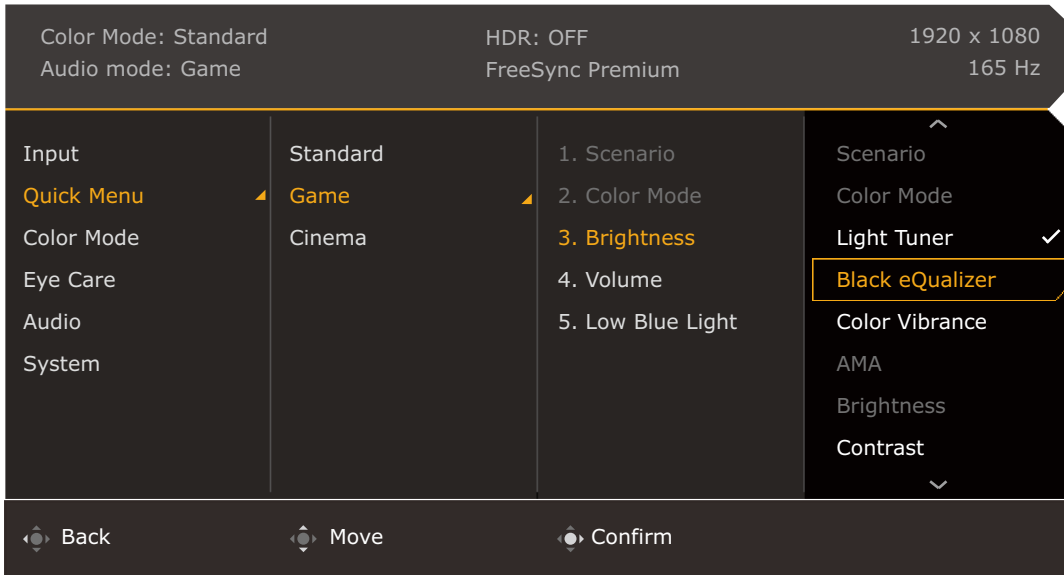

Available menu options to each **Color Mode**

Depending on the **Color Mode** you just set, the available options for color adjustment may vary. The list is for reference only as available options also vary by input. Menu options that are not available will become grayed out.

Color Mode	HDR	Game HDRi	Cinema HDRi	FPS	RPG	Racing Game	Custom	sRGB	M-Book	ePaper
Options										
Black eQualizer	X	X	X	V	X	X	X	X	X	X
Light Tuner	X	V	V	X	V	V	V	X	X	X
Color Vibrance	X	X	X	V	V	V	V	X	X	X
Brightness	V	V ⁽²⁾	V ⁽²⁾	V	V	V	V ⁽²⁾	V	V ⁽²⁾	V ⁽²⁾
Contrast	V	V ⁽²⁾	V ⁽²⁾	V	V	V	V ⁽²⁾	V	X	V ⁽²⁾
Sharpness	V	V	V	V	V	V	V	V	V	V
Gamma	X	X	X	X	X	X	V ⁽²⁾	X	X	X
Color Temperature	X	X	X	X	X	X	V ⁽²⁾	X	X	X
AMA	V	V	V	V	V	V	V	V	V	V
Blur Reduction	X	X	X	V ⁽¹⁾	V ⁽¹⁾	V ⁽¹⁾	V ⁽¹⁾	X	X	X
B.I.+	X	V	V	X	X	X	V ⁽³⁾	X	V ⁽³⁾	V
Low Blue Light	X	X	X	V	V	V	V	X	X	X
Adjust by duration	X	X	X	X	X	X	V ⁽²⁾	X	V ⁽²⁾	X
Color Weakness	X	X	X	V	V	V	V	X	X	X



- V: Available.
- X: Not available.
- ⁽¹⁾: Available only when the refresh rate is above 100 Hz.
- ⁽²⁾: Available only when **B.I.+** is disabled.
- ⁽³⁾: Available only when **Adjust by duration** is disabled.

Adjustable OSD settings

While some settings (e.g., OSD language) are changed and take effect immediately regardless of other monitor settings or input, most OSD settings can be adjusted and saved to go with inputs, color modes, or scenarios. As an input, a color mode, or a scenario is selected, the desired settings are applied.

Items	Description
Scenario	Saved and applied by input switch.
Display Mode	
Overscan	
RGB PC Range	
Color Mode	Saved and applied by input and scenario switch.
Audio mode	
Volume	
Low Blue Light	
Color Weakness	

Items	Description
Black eQualizer	Saved and applied by input and color mode switch.
Light Tuner	
Color Vibrance	
Brightness	
Contrast	
Gamma	
Color Temperature	
AMA	
Blur Reduction	
Sharpness	
B.I.+	
Adjust by duration	

Working with the HDRi hot key

The monitor takes advantage of Bright Intelligence Plus technology to balance screen brightness while playing HDR content to keep all image details. You are provided with a hot key to switch to a preferred HDR setting easily.

1. Make sure HDR content is available. See [Working with HDR technology on page 44](#) for more information. HDR function is enabled automatically once HDR content is available to the monitor.
2. Press the HDRi hot key to bring up a list of HDR options.
3. Press the same key repeatedly to cycle through the options to the desired one. See [Color Mode menu on page 52](#) for more information.

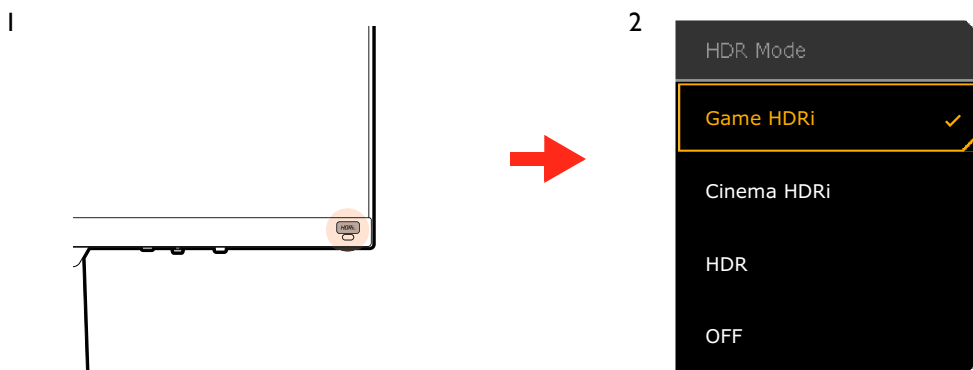

 To enable B.I.+ or HDR respectively, see [Adjusting screen brightness automatically \(Bright Intelligence Plus\) on page 43](#) or [Enabling HDR function on page 44](#).

Adjusting screen brightness automatically (Bright Intelligence Plus)

 The Bright Intelligence Plus function works with certain color modes only. If it is not available, its menu options will become grayed out.

The built-in light sensor works with Bright Intelligence Plus technology to detect the ambient light, image brightness, contrast, and color temperature, and then balance the screen automatically. It helps keep image details as well as to reduce eye strain.

To enable this function, go to **Menu > Color Mode > a mode > B.I.+ (Bright Intelligence Plus) > ON**. It takes a few seconds to complete the adjustment.

If you select **Game HDRi** or **Cinema HDRi**, the Bright Intelligence Plus function is enabled automatically.



The performance of Bright Intelligence Plus may be impacted by the light sources and the monitor tilt angle. You can increase the light sensor sensitivity from **Eye care > B.I.+ (Bright Intelligence Plus) > Sensor Sensitivity** if needed. See [page 55](#) for more information.

Working with HDR technology



The information regarding HDR-compatible devices and content in this document is most up-to-date at the time of publication. For the latest information, contact your device manufacturer and content provider.

To enable HDR function, you need to have a compatible player and content.

1. Make sure a FHD HDR player is ready. Players with the following names and resolutions are supported.

Commonly used names for FHD (may vary by manufacturer)	FHD, 1080p
Commonly used names for HDR10 (may vary by manufacturer)	HDR Premium, High Dynamic Range, HDR

2. Make sure HDR content is available. Content may come from a FHD player.
3. Make sure the player and the monitor have been connected via an appropriate cable:
 - the provided HDMI / DP / DP to mini DP cable / USB-C™ cable (if available)
 - an HDMI cable that is HDMI High Speed or HDMI Premium certified (for models with HDMI inputs)
 - a DP / DP to mini DP cable that is DisplayPort compliance certified (for models with DP inputs)
 - a certified USB-C™ cable with DisplayPort Alternate Mode capability (for models with USB-C™ inputs)

Enabling HDR function

If the instructions in [Working with HDR technology on page 44](#) are followed and the input content is HDR-compatible, the OSD message **HDR: On** is displayed on the screen. This means your content player and content are HDR-compatible and the HDR function is properly enabled. The monitor is following the ST2084 standard to process the HDR content. In this case, the monitor is set to **Game HDRi** by default.

You can press the HDRi hot key to bring up the HDR settings and select another HDR mode from the list. Alternatively, go to **Color Mode** for selection.

Enabling HDR-emulated mode



If the connection is complete and no OSD message is displayed, this means the content player and/or the content are not HDR-compatible. The monitor stays to the color mode recently chosen for non-HDR content. You can manually enable HDR-emulated mode by selecting **HDR**, **Game HDRi**, or **Cinema HDRi** from **Color Mode**.

Content type	Selected color mode	System information on main menu
HDR content	If a non-HDR mode is selected, it is changed to Game HDRi automatically.	HDR: ON
	Game HDRi Cinema HDRi HDR	

Content type	Selected color mode	System information on main menu
Non-HDR content	If a non-HDR color mode is selected.	HDR: OFF
	Game HDRi Cinema HDRi HDR	HDR: Emulated



Choosing an audio scenario

Several audio equalizers are provided for audio playback in different scenarios.

1. Press  /  /  to bring up the **Quick Menu**.
2. Go to **Menu > Audio > Audio mode**.
3. Select one option from the list. See [Audio mode on page 57](#) for more information.



Adjusting display mode

To display images of aspect ratio other than 16:9 and size other than the panel size of your purchased model, you can adjust the display mode on the monitor.

1. Press  /  /  to bring up the **Quick Menu**.
2. Go to **Menu > System > Display > Display Mode**.
3. Select an appropriate display mode. The setting will take effect immediately.



Choosing an appropriate color mode

Your monitor provides various picture modes that are suitable for different types of images. Display settings can be saved by color mode. See [Color Mode on page 52](#) for all the available picture modes.

1. Press  /  /  to bring up the **Quick Menu**.
2. Go to **Menu > Color Mode** for a desired color mode.
3. Under each mode, adjust and save the settings to suit your needs.



Connecting the monitor to your MacBook series product

While the monitor is connected to your MacBook series product, switch to **M-Book** mode which represents MacBook's color matching and visual representation on your monitor.

1. Connect your monitor to the MacBook series product.
2. Press  /  /  to bring up the **Quick Menu**.
3. Go to **Menu > Color Mode**.
4. Select **M-Book**. The setting will take effect immediately.

Enabling color vision accessibility (**Color Weakness**)

Color Weakness is accessibility that helps people with color vision deficiency to distinguish colors. You are provided with **Red Filter** and **Green Filter** on this monitor. Choose one as needed.

1. Press  /  /  to bring up the **Quick Menu**.
2. Go to **Menu > Eye Care > Color Weakness**.
3. Choose either **Red Filter** or **Green Filter**.

4. Adjust the value of the filter. A stronger effect is produced as the value increases.

Activating FreeSync™ Premium

Monitors featuring with the FreeSync will eliminate screen tearing, stuttering, and juddering during gaming.

1. Use a compatible graphics processing units (GPU) with the forthcoming driver. Confirm supported technologies please visit www.AMD.com.
2. Ensure to connect with DisplayPort or HDMI. See [Connect the video cable. on page 20](#) / [Connect the video cable. on page 30](#) for more information.
3. A message prompts on the screen, showing the FreeSync status. Depending on the monitor's FreeSync certification and specification of your graphic card, the FreeSync status displayed may vary.

OSD texts	Description
FreeSync Premium Pro	The FreeSync and HDR functions are activated, with the support of your monitor, the graphic card, and the input of HDR content.
FreeSync Premium	The FreeSync function is activated, with the support of the graphic card.
FreeSync Off	The FreeSync setting on the graphic card is switched off. The FreeSync function is not activated.



For any questions related to FreeSync™ Premium performance please refer to www.AMD.com.

Working with Video Format Support technology

Your monitor supports playback of 24P videos if they were originally produced at this frame rate. With Video Format Support technology the monitor displays such videos at the correct cadence without any pull-downs to distort the source video. This function is enabled automatically if compatible content is available to the monitor.

Initial setup for playing games at 165 Hz

You can optimize the monitor to enhance your gaming experience. You might want to start with the following steps.



Depending on the operating system on your PC, different procedures should be followed to adjust the screen refresh rate. Refer to the Help document of your operating system for details.

1. Set the screen refresh rate to **165 Hertz (165 Hz)**. Right-click the desktop and select **Screen resolution**. Click **Advanced settings**. Under the **Monitor** tab, change the screen refresh rate to **165 Hertz**. And then click **Apply** and **Yes** to confirm the change.

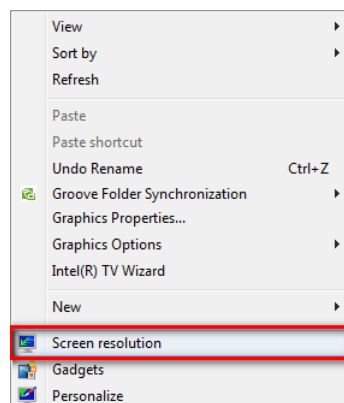

Change the appearance of your display

Display: 1.234567890

Resolution: 1920 x 1080 (recommended)

Orientation: Landscape

[Advanced settings](#)

[Connect to a projector](#) (or press the **Fn** key and tap P)

[Make text and other items larger or smaller](#)

[What display settings should I choose?](#)

OK Cancel Apply

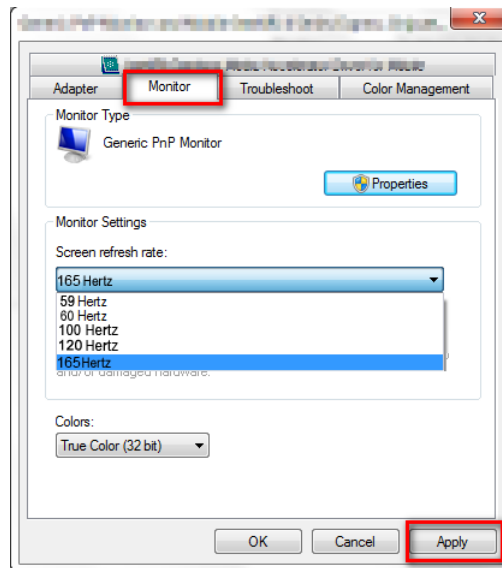

2. Go to the setup menu in your game, and change the frame rate or screen refresh rate to 165 Hz. Refer to the Help document that came with your game for details.
3. To check if the screen refresh rate has been changed, go to the **Quick Menu** on your monitor and check the system information.



If 165 Hz is not available on your menus, check the following:

- make sure the DisplayPort cable is properly connected to your computer and the monitor
- make sure your GPU supports 165 Hz
- make sure your game supports 165 Hz.

Navigating the main menu

You can use the OSD (On Screen Display) menu to adjust all the settings on your monitor.

Press  /  /  to bring up the **Quick Menu** and select **Menu** to access the main menu. See [5-way controller and basic menu operations on page 37](#) for details.

Available menu options may vary depending on the input sources, functions and settings. Menu options that are not available will become grayed out. And keys that are not available will be disabled and the corresponding OSD icons will disappear. For models without certain functions, their settings and related items will not appear on the menu.



The OSD menu languages may differ from the product supplied to your region, see [Language on page 59](#) under **System** and **OSD Settings** for more details.

For more information on each menu, please refer to the following pages:

- [Input menu on page 49](#)
- [Quick Menu on page 50](#)
- [Color Mode menu on page 52](#)
- [Eye care menu on page 55](#)
- [Audio menu on page 57](#)
- [System menu on page 58](#)

Input menu

Available menu options may vary depending on the input sources, functions and settings. Menu options that are not available will become grayed out. And keys that are not available will be disabled and the corresponding OSD icons will disappear. For models without certain functions, their settings and related items will not appear on the menu.

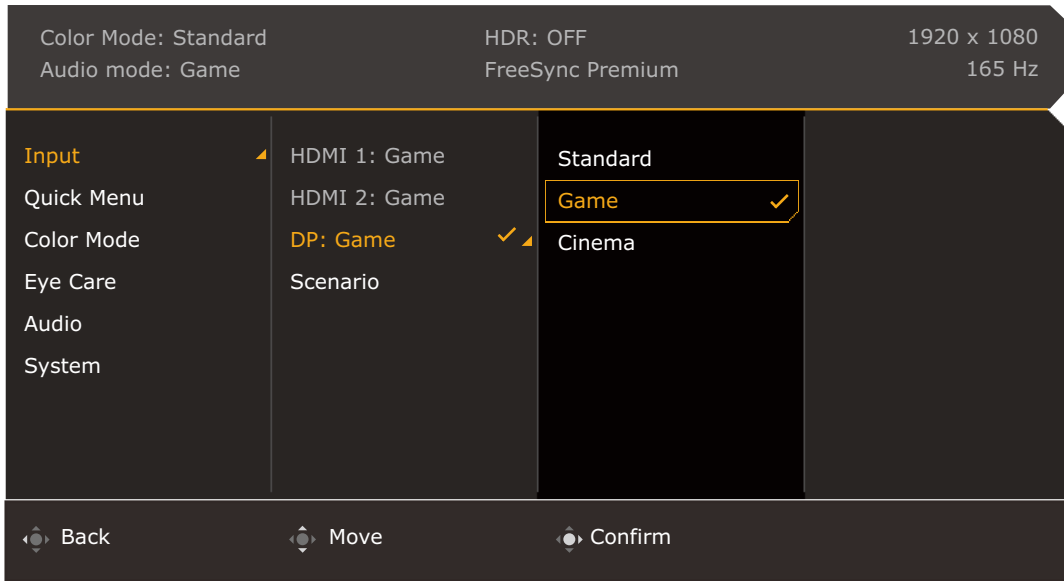









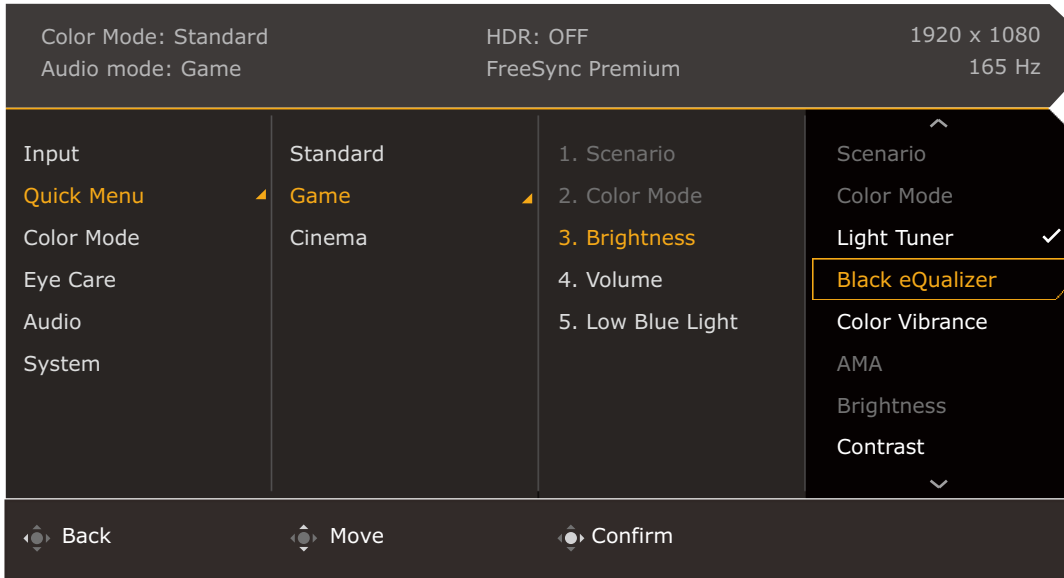





1. Press / / to bring up the **Quick Menu**.
2. Select **Menu** from the **Quick Menu**.
3. Use or to select **Input**.
4. Select to go to a sub menu, and then use or to select a menu item.
5. Use or to make adjustments, or use to make selection.
6. To return to the previous menu, select .
7. To exit the menu, select .

Item	Function	Range
Input	Use this to change the input to that appropriate to your video cable connection type. A scenario could be designated for an input. See Setting up your monitor for different scenarios on page 38 for more information.	(EX240) • HDMI I • HDMI2 • DP • Scenario (EX240N) • HDMI • DP • Scenario

Quick Menu

Available menu options may vary depending on the input sources, functions and settings. Menu options that are not available will become grayed out. And keys that are not available will be disabled and the corresponding OSD icons will disappear. For models without certain functions, their settings and related items will not appear on the menu.



1. Press  /  /  to bring up the **Quick Menu**.
2. Select **Menu** from the **Quick Menu**.
3. Use  or  to select **Quick Menu**.
4. Select  to go to a sub menu, and then use  or  to select a menu item.
5. Use  or  to make adjustments, or use  to make selection.
6. To return to the previous menu, select .
7. To exit the menu, select .

Item	Function	Range
Quick Menu	<p>Sets 3 settings that could be frequently adjusted from the Quick Menu. See Working with the Quick Menu on page 40 and Customizing the Quick Menu on page 41 for more information.</p> <p> If Input > Scenario is disabled, only Standard is available for setup.</p>	

Item	Function		Range
	Standard	For basic PC application.	<ul style="list-style-type: none"> • Scenario (cannot be changed) • Color Mode (cannot be changed) • Light Tuner • Black eQualizer • Color Vibrance • AMA • Brightness • Contrast • Sharpness • Audio mode • Volume • Low Blue Light • Blur Reduction
	Game	For gaming.	
	Cinema	For watching movies.	

Color Mode menu

Available menu options may vary depending on the input sources, functions and settings. Menu options that are not available will become grayed out. And keys that are not available will be disabled and the corresponding OSD icons will disappear. For models without certain functions, their settings and related items will not appear on the menu.

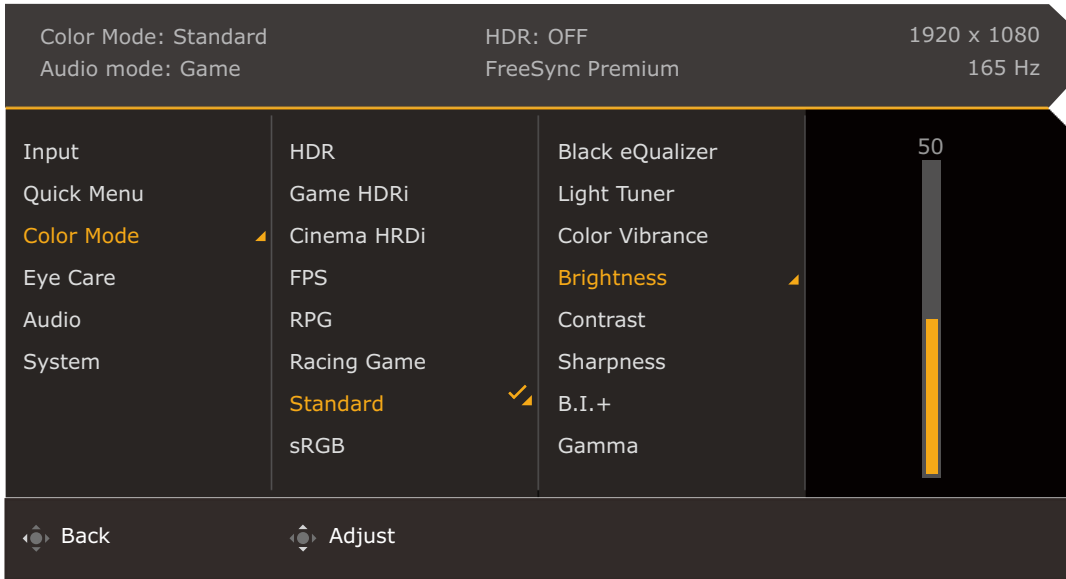



1. Press / / to bring up the **Quick Menu**.
2. Select **Menu** from the **Quick Menu**.
3. Use or to select **Color Mode**.
4. Select to go to a sub menu, and then use or to select a menu item.
5. Use or to make adjustments, or use to make selection.
6. To return to the previous menu, select .
7. To exit the menu, select .

Item	Function	Range
Color Mode	Select a color mode that best suits the type of images shown on the screen.	

Item	Function		Range
	HDR	Enables HDR function.	<ul style="list-style-type: none"> • Black eQualizer • Light Tuner • Color Vibrance • Brightness • Contrast • Sharpness • B.I.+ • Gamma • Color Temperature • AMA • Blur Reduction (Motion Blur Reduction) • Reset Color
	Game HDRi	Enables HDR and B.I.+ functions at the same time while the contrast is enhanced.	
	Cinema HDRi	Enables HDR and B.I.+ functions together.	
	FPS	For playing FPS (First Person Shooting) games.	
	RPG	For playing RPG (Role Playing) games.	
	Racing Game	For playing racing games.	
	sRGB	For better color matching representation with sRGB compatible peripherals.	
	M-Book	Minimizes the visual differences between the monitor and the connected MacBook series product.	
	ePaper	For reading e-books or documents in black and white with suitable on-screen brightness and clear texts.	
	Custom	Applies a combination of color settings defined by users.	

Available menu options may vary depending on the input sources, functions and settings. See [Available menu options to each Color Mode on page 42](#) for more information.

Item	Function	Range
Black eQualizer	Brings out the dark shades by increasing the brightness without changing those of the light shades.  If the image is too bright or barely contains any dark shades, adjusting the value of Black eQualizer may not show much change to the image.	0 ~ 10
Light Tuner	Brings out the dark shades by increasing the brightness, contrast, and saturation all together.	-10 ~ 10
Color Vibrance	Provides different sets of color settings. Once applied, you can adjust some of the color settings in the corresponding menus.	0 ~ 20
Brightness	Adjusts the balance between light and dark shades.	0 ~ 100
Contrast	Adjusts the degree of difference between darkness and lightness.	0 ~ 100
Sharpness	Adjusts the clarity and visibility of the edges of the subjects in the image.	0 ~ 10
B.I.+	Turns the Bright Intelligence Plus function on or off. The built-in light sensor works with Bright Intelligence Plus technology to detect the ambient light, image brightness, contrast, and color temperature, and then balance the screen automatically. See B.I.+ (Bright Intelligence Plus) on page 55 for more adjustments.	<ul style="list-style-type: none"> • ON • OFF
Gamma	Adjusts the tone luminance.	1 ~ 5

Item	Function		Range
Color Temperature	Normal	Allows video and still photographs to be viewed with natural coloring. This is the factory default color.	
	Bluish	Applies a cool tint to the image and is factory pre-set to the PC industry standard white color.	
	Reddish	Applies a warm tint to the image and is factory pre-set to the news print standard white color.	
	User Define	<p>The blend of the Red, Green and Blue primary colors can be altered to change the color tint of the image. Go to the succeeding R (red), G (green), and B (blue) menus to change the settings.</p> <p>Decreasing one or more of the colors will reduce their respective influence on the color tint of the image. (e.g. if you reduce the Blue level the image will gradually take on a yellowish tint. If you reduce Green, the image will become a magenta tint.)</p>	<ul style="list-style-type: none"> • R (0 ~ 100) • G (0 ~ 100) • B (0 ~ 100)
AMA	Improves the gray level response time of the LCD panel.		0 ~ 3
Blur Reduction (Motion Blur Reduction)	<p>Reduces motion blur in games or during video playback.</p>  Note the impacts of the Blur Reduction function once activated. <ul style="list-style-type: none"> - Brightness is decreased. - Flicker-free is disabled. - Available only when the refresh rate is above 100 Hz. 		<ul style="list-style-type: none"> • ON • OFF
Reset Color	Resets the custom color settings to the factory defaults.		<ul style="list-style-type: none"> • YES • NO

Eye care menu

Available menu options may vary depending on the input sources, functions and settings. Menu options that are not available will become grayed out. And keys that are not available will be disabled and the corresponding OSD icons will disappear. For models without certain functions, their settings and related items will not appear on the menu.

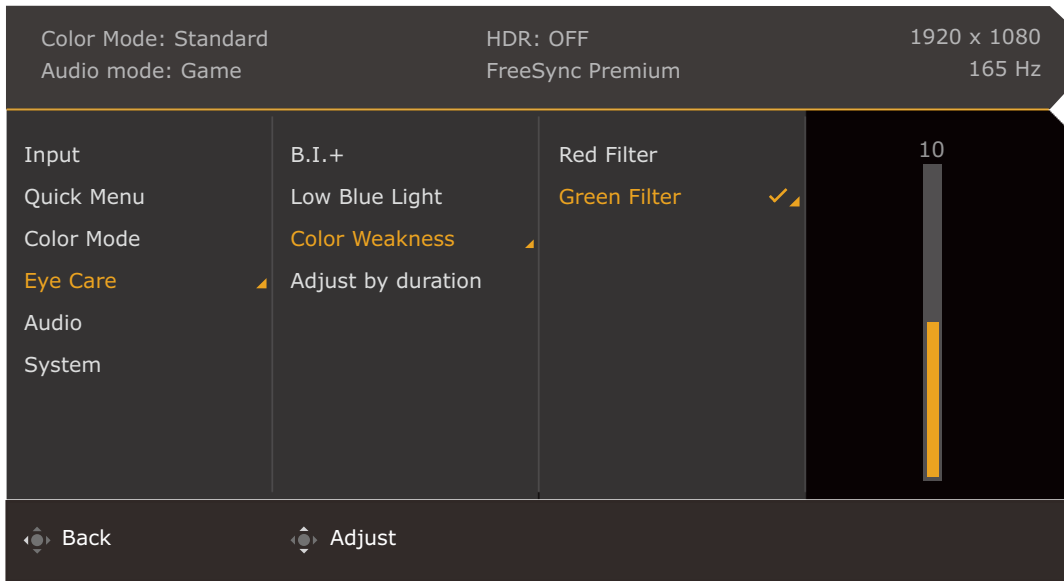

1. Press / / to bring up the **Quick Menu**.
2. Select **Menu** from the **Quick Menu**.
3. Use or to select **Eye Care**.
4. Select to go to a sub menu, and then use or to select a menu item.
5. Use or to make adjustments, or use to make selection.
6. To return to the previous menu, select .
7. To exit the menu, select .









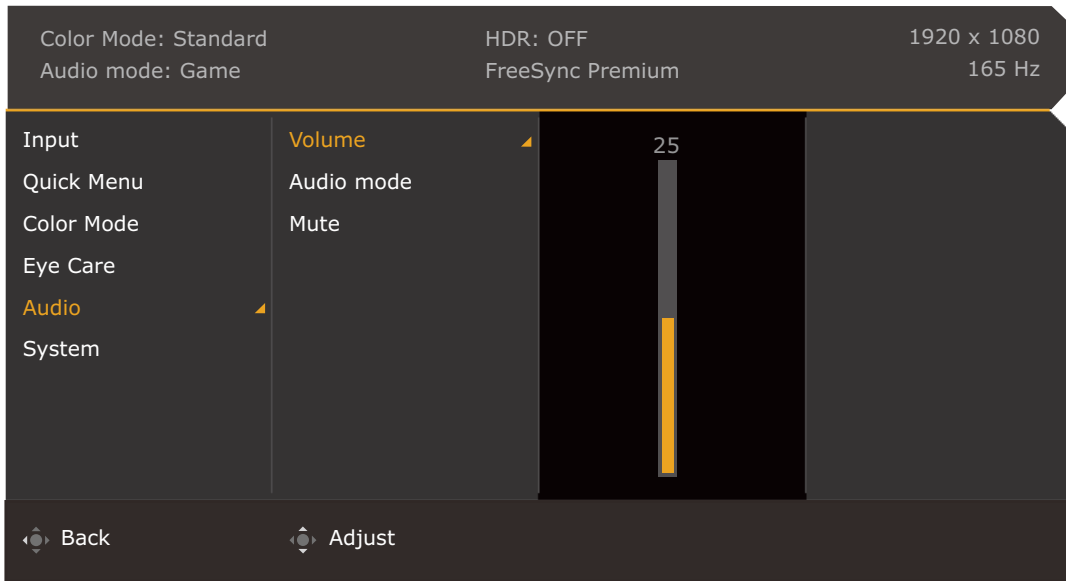



Item	Function	Range
B.I.+ (Bright Intelligence Plus)	If the Bright Intelligence Plus function has been enabled from a mode in the Color Mode menu, related settings are available here.	
	Light Meter	Sets to display the light condition around the monitor on the screen.
	Sensor Sensitivity	Adjusts sensitivity of light sensor to change the brightness range to be detected. This may be helpful to correct uneven lighting in light detection.
Low Blue Light	Decreases the blue light emitted from the display to reduce the risk of blue light exposure to your eyes. The higher the value is, the more blue light has been decreased.	0 ~ 100 0 ~ 20

Item	Function		Range
Color Weakness	Adjusts color matching representation for people with color vision deficiency to distinguish colors easily.		
	Red Filter	Decides the effect produced by the red filter. A stronger effect is produced as the value increases.	0 ~ 20
	Green Filter	Decides the effect produced by the green filter. A stronger effect is produced as the value increases.	0 ~ 20
Adjust by duration	The color temperature of the monitor changes as the usage time increases to reduce possible eye strain.		<ul style="list-style-type: none"> • ON • OFF

Audio menu

Available menu options may vary depending on the input sources, functions and settings. Menu options that are not available will become grayed out. And keys that are not available will be disabled and the corresponding OSD icons will disappear. For models without certain functions, their settings and related items will not appear on the menu.











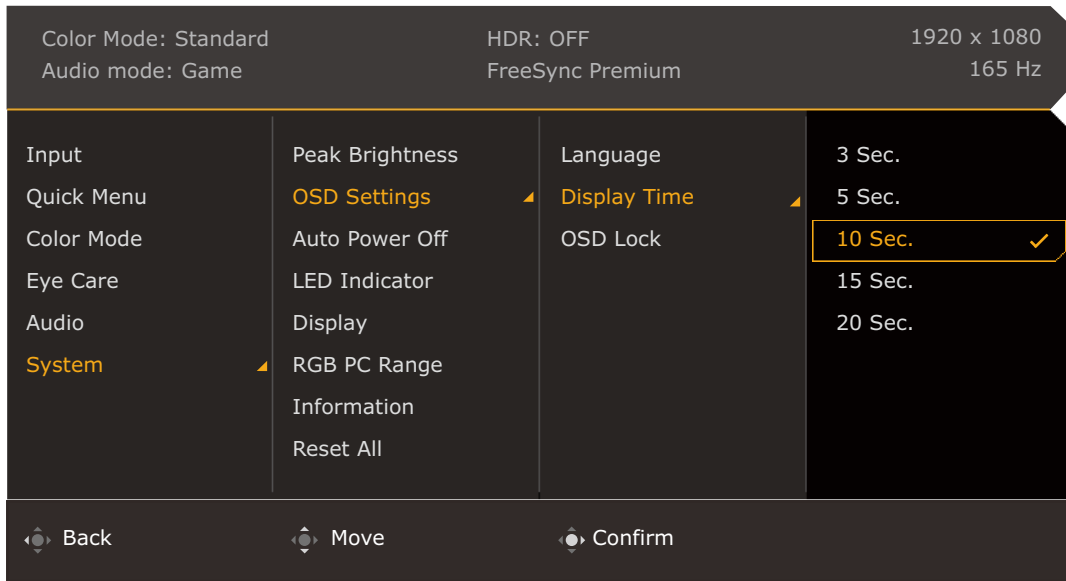





1. Press  /  /  to bring up the **Quick Menu**.
2. Select **Menu** from the **Quick Menu**.
3. Use  or  to select **Audio**.
4. Select  to go to a sub menu, and then use  or  to select a menu item.
5. Use  or  to make adjustments, or use  to make selection.
6. To return to the previous menu, select .
7. To exit the menu, select .

Item	Function	Range
Volume	Adjusts the audio volume.	0 ~ 50
Audio mode	Selects one of the equalizers to obtain the best audio effect in certain scenarios.	
	FPS	Enhances the sound positioning so you can identify the location or origin of detailed sounds, e.g., a flying bullet or an enemy's footsteps.
	Cinema	Enhances the bass while keeps the vocal clear.
	Pop / Live	Keeps the music and the vocal in harmony as if in live.
Mute	Mutes the audio input.	<ul style="list-style-type: none"> • ON • OFF



System menu



Available menu options may vary depending on the input sources, functions and settings. Menu options that are not available will become grayed out. And keys that are not available will be disabled and the corresponding OSD icons will disappear. For models without certain functions, their settings and related items will not appear on the menu.



1. Press  /  /  to bring up the **Quick Menu**.
2. Select **Menu** from the **Quick Menu**.
3. Use  or  to select **System**.
4. Select  to go to a sub menu, and then use  or  to select a menu item.
5. Use  or  to make adjustments, or use  to make selection.
6. To return to the previous menu, select .
7. To exit the menu, select .

Item	Function	Range
Peak Brightness	Provides different ranges of screen brightness. You can adjust the brightness value within the selected range from Brightness of each color mode. See Color Mode menu on page 52 .	
	Normal	The maximum brightness is limited to consume less power.
	Max	The maximum possible brightness is increased while the power consumption is increased as well.













Item	Function		Range
OSD Settings	Language	Sets the OSD menu language.  The language options displayed on your OSD may differ from those shown on the right, depending on the product supplied in your region.	<ul style="list-style-type: none"> • English • Français • Deutsch • Italiano • Español • Polski • Česky • Magyar • Română • Nederlands • Русский • Svenska • Português • العربية • 日本語 • 한국어 • 繁體中文 • 简体中文
	Display Time	Adjusts the display time of the OSD menu.	<ul style="list-style-type: none"> • 3 sec. • 5 sec. • 10 sec. • 15 sec. • 20 sec.
	OSD Lock	Prevents all the monitor settings from being accidentally changed. When this function is activated, the OSD controls and hotkey operations will be disabled.  To unlock the OSD controls, press and hold any key for 10 seconds.	
Auto Power Off	Sets the time to power off the monitor automatically in power saving mode.		<ul style="list-style-type: none"> • OFF • 10 min • 20 min • 30 min
LED Indicator	Switches the power key's LED indicator on or off.		<ul style="list-style-type: none"> • ON • OFF

Item	Function		Range	
Display	Display Mode	This feature is provided to allow aspect ratios other than 16:9 to be displayed without geometric distortion.		
		Full	Scales the input image to fill the screen. Ideal for 16:9 aspect images.	
		Aspect	The input image is displayed without geometric distortion filling as much of the display as possible.	
		1:1	Displays the input image in its native resolution without scaling.	
	Overscan	<p>Slightly enlarges the input image. Use this feature to hide annoying edge noise if present around your image.</p> <p> Available only when the input source is HDMI.</p>	<ul style="list-style-type: none"> • ON • OFF 	
RGB PC Range	Determines the range of color scales. Select an option that matches the RGB range setting on the connected device.		<ul style="list-style-type: none"> • Auto Detect • RGB (0~255) • RGB (16~235) 	
Information	Displays the product information.		<ul style="list-style-type: none"> • Input • Current Resolution • Optimum Resolution • HDR • Model Name 	
Reset All	<p>Resets all mode, color and geometry settings to the factory default values.</p> <p> You are prompted to set scenarios for available inputs after system reset. See Setting up your monitor for different scenarios on page 38 for more information.</p>		<ul style="list-style-type: none"> • YES • NO 	

Troubleshooting

Frequently asked questions (FAQ)

Imaging

-  The image is blurred.
-  Download **Resolution file** from the website (see [Product support on page 3](#)). Refer to "**Adjusting the Screen Resolution**". And then select the correct resolution, refresh rate and make adjustments based on these instructions.
-  Does the blurring only occur at resolutions lower than the native (maximum) resolution?
-  Download **Resolution file** from the website (see [Product support on page 3](#)). Refer to "**Adjusting the Screen Resolution**". Select the native resolution.
-  Pixel errors can be seen.
- One of several pixels is permanently black, one or more pixels are permanently white, one or more pixels are permanently red, green, blue or another color.
- 
 - Clean the LCD screen.
 - Cycle power on-off.
 - These are pixels that are permanently on or off and is a natural defect that occurs in LCD technology.
-  The image has a faulty coloration.
-  It has a yellow, blue or pink appearance.
- Go to the selected color mode from **Color Mode**. Select **Reset Color**, and then choose **YES** to reset the color settings to the factory defaults.
- If the image is still not correct and the OSD also has faulty coloration, this means one of the three primary colors is missing in the signal input. Now check the signal cable connectors. If any pin is bent or broken off, please contact your dealer to get necessary support.
-  The image is distorted, flashes or flickers.
-  Download **Resolution file** from the website (see [Product support on page 3](#)). Refer to "**Adjusting the Screen Resolution**". And then select the correct resolution, refresh rate and make adjustments based on these instructions.
-  You are running the monitor at its native resolution, but the image is still distorted.
-  Images from different input sources may appear distorted or stretched on the monitor running at its native resolution. To have the optimal display performance of each type of input sources, you can use the **Display Mode** function to set a proper aspect ratio for the input sources. See [Display Mode on page 60](#) for details.

- ⓪ The image is displaced in one direction.
- ✔ Download **Resolution file** from the website (see [Product support on page 3](#)). Refer to "**Adjusting the Screen Resolution**". And then select the correct resolution, refresh rate and make adjustments based on these instructions.
- ⓪ Faint shadow from the static image displayed is visible on the screen.
- ✔
 - Activate the power management function to let your computer and monitor go into a low power "sleep" mode when not actively in use.
 - Use a screensaver to prevent the occurrence of image retention.

Power LED indicator

- ⓪ The LED indicator is white or orange.
- ✔
 - If the LED lights up in solid white, the monitor is powered on.
 - If the LED is illuminated in white and there is a message **Out of Range** on the screen, this means you are using a display mode that this monitor does not support, please change the setting to one of the supported mode. Download **Resolution file** from the website (see [Product support on page 3](#)). Refer to "**Adjusting the Screen Resolution**". And then select the correct resolution, refresh rate and make adjustments based on these instructions.
 - If the LED is illuminated in orange, the power management mode is active. Press any button on the computer keyboard or move the mouse. If that does not help, check the signal cable connectors. If any pin is bent or broken off, please contact your dealer to get necessary support.
 - If the LED is off, check the power supply mains socket, the external power supply and the mains switch.

OSD controls

- ⓪ The OSD controls are inaccessible.
- ✔ To unlock the OSD controls when it is preset to be locked, press and hold any key for 10 seconds.

OSD messages

- ⓪ A message **Out of Range** on the screen during computer boot up process.
- ✔ If there is a message **Out of Range** on the screen during computer boot up process, this means computer compatibility caused by operating system or graphic card. The system will adjust the refresh rate automatically. Just wait until the operating system is launched.

Audio

- ❓ No sound can be heard from the built-in speakers.
- ✔
 - Check whether the desired cable to input audio signals is properly connected. See [Connect the audio cable. on page 21](#) for details.
 - Increase the volume (volume may be muted or too low).
 - Remove your headphone and/or external speakers. (If they are connected to the monitor, the built-in speakers are automatically muted.)
- ❓ No sound can be heard from the connected external speakers.
- ✔
 - Remove your headphone (if the headphone is connected to the monitor).
 - Check whether the headphone jack is properly connected.
 - If the external speakers are USB-powered, check whether the USB connection is OK.
 - Increase the volume (volume may be muted or too low) on the external speakers.

Sensors

- ❓ The light sensor of the monitor does not work well.
- ✔ The light sensor is located at the front bottom of the monitor. Please check:
 - If you have removed the sensor protection sticker.
 - If the Bright Intelligence / Bright Intelligence Plus function has been turned on. Check **Color Mode** > a mode > **B.I.+** (Bright Intelligence Plus).
 - If there are any obstacles in front of the sensor that keep the sensor from detecting the light properly.
 - If there are any objects or clothing in bright colors in front of the sensor. Bright colors (especially white and fluorescent colors) reflect light and the sensor cannot detect the main light sources.

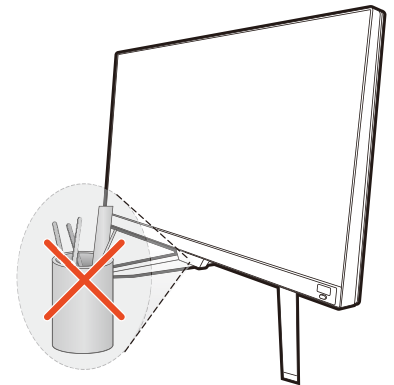

HDR

- ❓ There is a message **HDR: Emulated** showing on the screen.
- ✔ This means the input content is not HDR-compatible and the monitor is in HDR-emulated mode. Refer to [Working with HDR technology on page 44](#) to check if a supported player, content, and the certified cable are used.

Need more help?

If your problems remain after checking this manual, please contact your place of purchase or visit the local website from Support.BenQ.com for more support and local customer service.