



Questo manuale d'istruzione è fornito da trovaprezzi.it. Scopri tutte le offerte per [BenQ PD3420Q](#) o cerca il tuo prodotto tra le [migliori offerte di Monitor](#)



Questo manuale d'istruzione è fornito da trovaprezzi.it. Scopri tutte le offerte per [BenQ PD3420Q](#) o cerca il tuo prodotto tra le [migliori offerte di Monitor](#)



LCD Monitor User Manual

DesignVue Designer Monitor | PD Series



Copyright

Copyright © 2019 by BenQ Corporation. All rights reserved. No part of this publication may be reproduced, transmitted, transcribed, stored in a retrieval system or translated into any language or computer language, in any form or by any means, electronic, mechanical, magnetic, optical, chemical, manual or otherwise, without the prior written permission of BenQ Corporation.

Disclaimer

BenQ Corporation makes no representations or warranties, either expressed or implied, with respect to the contents hereof and specifically disclaims any warranties, merchantability or fitness for any particular purpose. Further, BenQ Corporation reserves the right to revise this publication and to make changes from time to time in the contents hereof without obligation of BenQ Corporation to notify any person of such revision or changes.

The performance of flicker-free may be affected by external factors such as poor cable quality, unstable power supply, signal interference, or poor grounding, and not limited to the above mentioned external factors. (Applicable for flicker-free models only.)

BenQ ecoFACTS

BenQ has been dedicated to the design and development of greener product as part of its aspiration to realize the ideal of the "Bringing Enjoyment 'N Quality to Life" corporate vision with the ultimate goal to achieve a low-carbon society. Besides meeting international regulatory requirement and standards pertaining to environmental management, BenQ has spared no efforts in pushing our initiatives further to incorporate life cycle design in the aspects of material selection, manufacturing, packaging, transportation, using and disposal of the products. BenQ ecoFACTS label lists key eco-friendly design highlights of each product, hoping to ensure that consumers make informed green choices at purchase. Check out BenQ's CSR Website at <http://csr.BenQ.com/> for more details on BenQ's environmental commitments and achievements.



Power Safety



Please follow these safety instructions for best performance, and long life for your monitor.

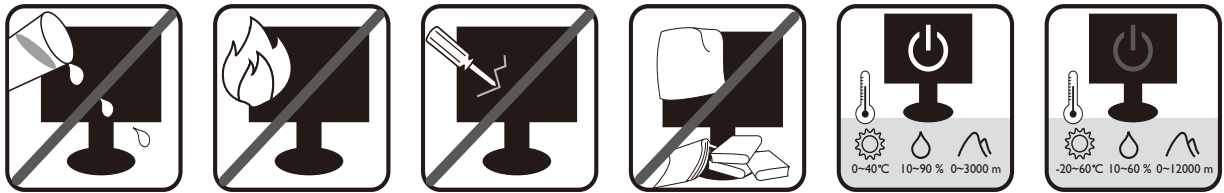

- The AC plug isolates this equipment from the AC supply.
- The power supply cord serves as a power disconnect device for pluggable equipment. The socket outlet should be installed near the equipment and be easily accessible.
- This product should be operated from the type of power indicated on the marked label. If you are not sure of the type of power available, consult your dealer or local power company.
- The Class I pluggable equipment Type A must be connected to protective earth.
- An approved power cord greater or equal to H03VV-F or H05VV-F, 2G or 3G, 0.75mm must be used.

For Germany only:

- (If the weight of the product is less than or equal to 3 kg) An approved power cord greater or equal to H03VV-F, 3G, 0.75mm must be used.
- (If the weight of the product is more than 3 kg) An approved power cord greater or equal to H05VV-F or H05RR-F, 3G, 0.75mm must be used.
- (If a remote control is provided) RISK OF EXPLOSION IF BATTERY IS REPLACED BY AN INCORRECT TYPE. DISPOSE OF USED BATTERIES ACCORDING TO THE INSTRUCTIONS.

For models with adapter:

- Use only the power adapter supplied with your LCD Monitor. Use of another type of power adapter will result in malfunction and/or danger.
- Allow adequate ventilation around the adapter when using it to operate the device or charge the battery. Do not cover the power adapter with paper or other objects that will reduce cooling. Do not use the power adapter while it is inside a carrying case.
- Connect the power adapter to a proper power source.
- Do not attempt to service the power adapter. There are no service parts inside. Replace the unit if it is damaged or exposed to excess moisture.

Care And Cleaning

- Do not place the monitor face down on the floor or a desk surface directly. Otherwise, scratches on the panel surface may occur.

- The equipment is to be secured to the building structure before operation.
- (For models that support wall or ceiling mounting)
 - Install your monitor and monitor mounting kit on a wall with flat surface.
 - Ensure that the wall material and the standard wall mount bracket (purchased separately) are stable enough to support the weight of the monitor.
 - Turn off the monitor and the power before disconnecting the cables from the LCD monitor.
- Always unplug the product from the power outlet before cleaning. Clean the LCD monitor surface with a lint-free, non-abrasive cloth. Avoid using any liquid, aerosol or glass cleaners.
- Slots and openings on the back or top of the cabinet are for ventilation. They must not be blocked or covered. Your monitor should never be placed near or over a radiator or heat sources, or in a built-in installation unless proper ventilation is provided.
- Do not place heavy loads on the monitor to avoid possible personal injury or damage to the monitor.
- Consider keeping the box and packaging in storage for use in the future when you may need to transport the monitor.
- Refer to the product label for information on power rating, manufacture date, and identification markings.



Servicing

- Do not attempt to service this product yourself, as opening or removing covers may expose you to dangerous voltages or other risks. If any of the above mentioned misuse or other accident such as dropping or mishandling occurs, contact qualified service personnel for servicing.
- Contact your place of purchase or visit the local website from www.BenQ.com for more support.

Caution

- The monitor should be 50 ~ 70 cm (20 ~ 28 inches) away from your eyes.
- Looking at the screen for an extended period of time causes eye fatigue and may deteriorate your eyesight. Rest your eyes for 5 ~ 10 minutes for every 1 hour of product use.
- Reduce your eye strain by focusing on objects far way.
- Frequent blinking and eye exercise help keep your eyes from drying out.

Typography

Icon / Symbol	Item	Meaning
	Warning	Information mainly to prevent the damage to components, data, or personal injury caused by misuse and improper operation or behavior.
	Tip	Useful information for completing a task.
	Note	Supplementary information.

In this document, the steps needed to reach a menu may be shown in condensed form, for example: **Menu > System > Information.**

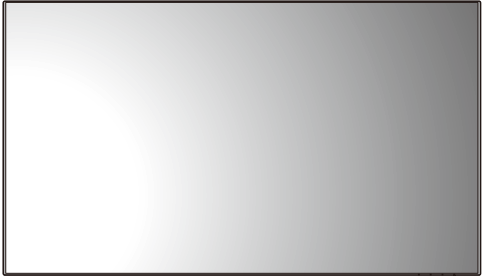

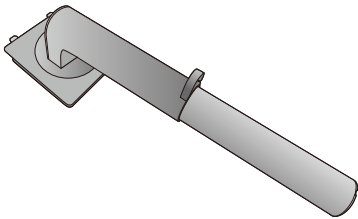

Table of Contents





Copyright	2
Getting started	8
Getting to know your monitor	11
Front view.....	11
Bottom view.....	11
Back view	12
Connections	14
How to assemble your monitor hardware	19
How to detach the stand	27
Adjusting the monitor height	29
Rotating the monitor (PD2720U / PD3220U only)	30
Viewing angle adjustment.....	31
Using the monitor wall mounting kit	32
Getting the most from your BenQ monitor	33
How to install the monitor on a new computer	34
How to upgrade the monitor on an existing computer	35
How to install on Windows 10 system	36
How to install on Windows 8 (8.1) system	37
How to install on Windows 7 system	38
How to adjust your monitor	39
The control panel.....	39
5-way controller and basic menu operations	40
Working with the hot keys.....	42
Hotkey Puck G2 and its basic operations	44
Adjusting Display Mode	46
Choosing an appropriate color mode.....	46
Working with two video sources (KVM Switch).....	46
Video source selection in PIP mode.....	48
Video source selection in PBP mode.....	49
Connecting multiple monitors (Thunderbolt™ 3 daisy chaining)(PD2720U / PD3220U)	49
Working with HDR technology.....	50
Working with two color settings on the same image (DualView)	51
Navigating the main menu	53
Input menu	54
Picture menu	57
Color menu	59
Audio menu	64
KVM Switch menu	65
Custom Key menu	67
System menu	69

Troubleshooting74
 Frequently asked questions (FAQ)..... 74
 Need more help? 76

Getting started

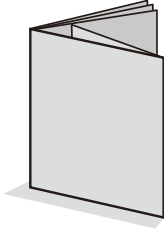
When unpacking please check you have the following items. If any are missing or damaged, please contact the place of purchase for a replacement.

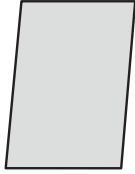
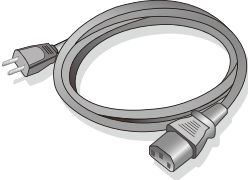
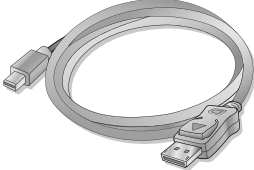
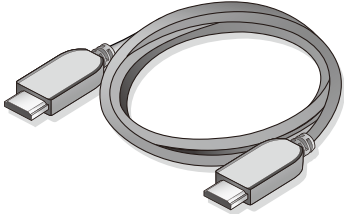
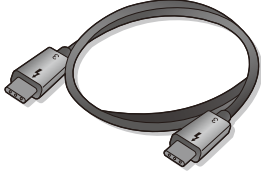
BenQ LCD Monitor	<p>(PD2720U)</p>  <p>(PD3220U)</p>  <p>(PD3420Q)</p> 
Monitor Stand	
Monitor Base	
Back Cover	

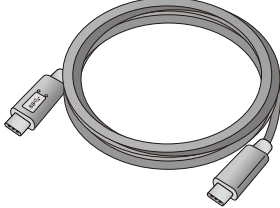
Quick Start Guide	
CD-ROM	
Installation Guide	
Power Cord (Picture may differ from product supplied for your region.)	
Video Cable: DP to mini DP	
Video Cable: HDMI	
Video Cable: Thunderbolt™ 3 (Optional accessory for models with Thunderbolt™ 3 inputs)	
<p>  A Thunderbolt™ 3 passive cable that supports up to 40 Gb/s data transfer. </p> <p> Video Cable: USB-C™ (OPTIONAL ACCESSORY, PURCHASED SEPARATELY) </p> <p>  The length of USB-C™ cable should be less than 1 meter to make the connection easy. </p>	

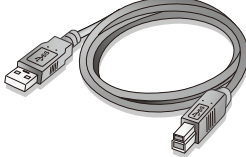
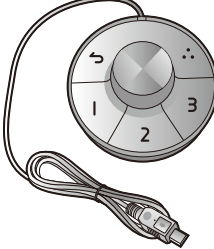
USB Cable	
Hotkey Puck G2	



• Available accessories and the pictures shown here may differ from the actual contents and the product supplied for your region. And the package contents may subject to change without prior notice. For cables that are not supplied with your product, you can purchase them separately.

• Consider keeping the box and packaging in storage for use in the future when you may need to transport the monitor. The fitted foam packing is ideal for protecting the monitor during transport.



Always keep the product and accessories out of reach of small children.

Getting to know your monitor

Front view

(PD2720U)

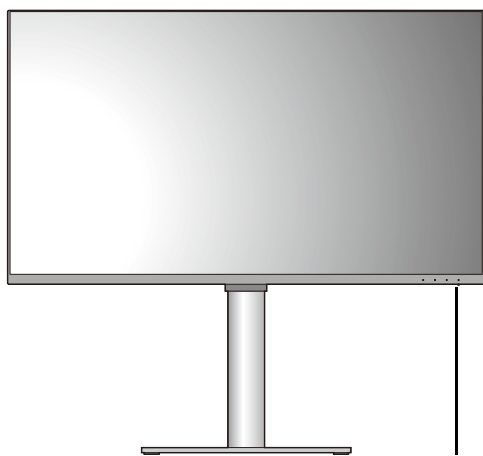

(PD3220U)



(PD3420Q)



1. Power LED indicator

Bottom view

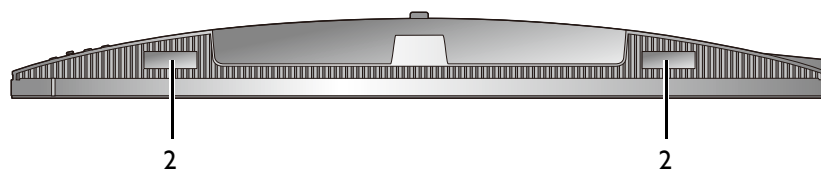

2. Speakers

Back view

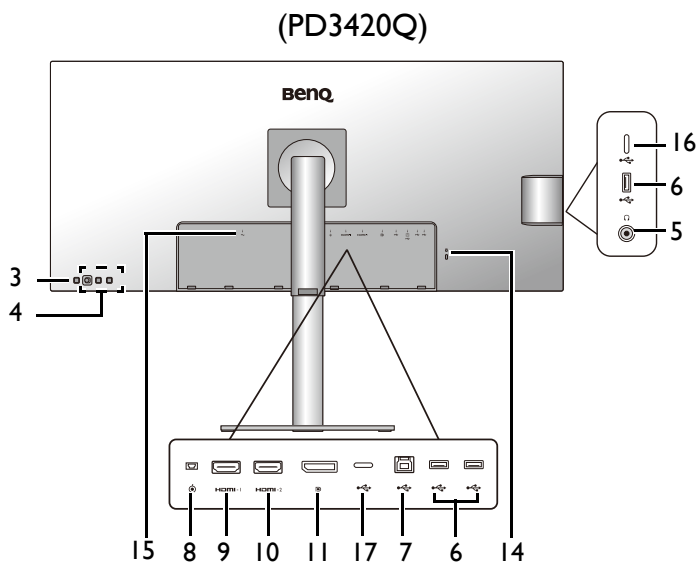
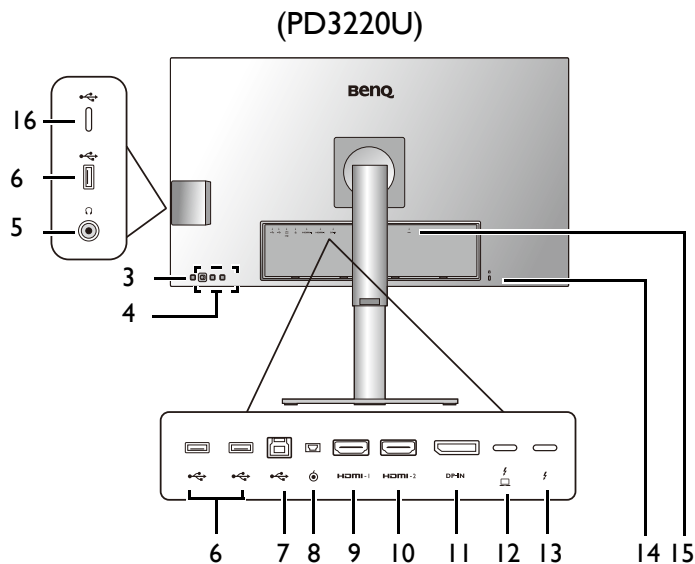
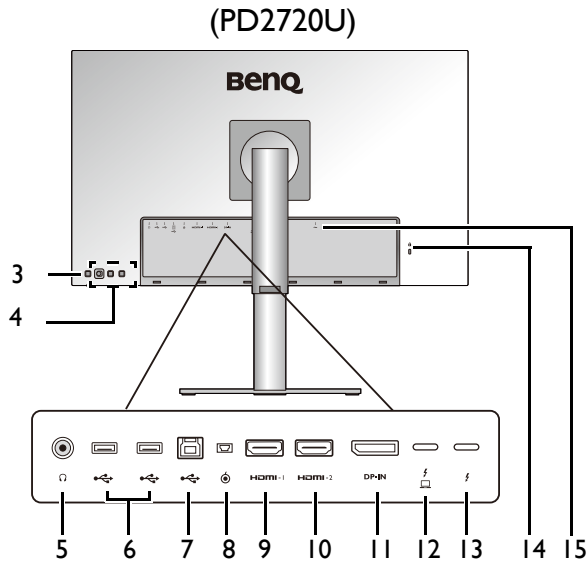

3. Power button
4. Control keys
5. Headphone jack
6. (PD2720U/PD3220U) USB 3.1 Gen 2 ports
(PD3420Q) USB 3.1 Gen 1 ports (downstream; connecting to the USB devices)
7. (PD2720U/PD3220U) USB 3.1 Gen 2 port
(PD3420Q) USB 3.1 Gen 1 ports (upstream; connecting to the PC)
8. Hotkey Puck G2 socket
9. HDMI1 socket
10. HDMI2 socket
11. DisplayPort socket
12. Thunderbolt™ 3 socket 1 (*)
13. Thunderbolt™ 3 socket 2 (**)
14. Kensington lock slot
15. AC power input jack
16. USB-C™ port (for data transfer only)
17. USB-C™ port (for data transfer and power delivery up to 65W)



- *: 1) Thunderbolt™ 3 with up to 40Gbs bandwidth; 2) supports up to two 4K monitors by daisy chain; 3) power delivery up to 85W (PD3220U) or 65W (PD2720U). See [Power delivery of Thunderbolt™ 3 ports on your monitor \(PD2720U / PD3220U only\) on page 17](#) for more information.
 - **: 1) Thunderbolt™ 3 with up to 40Gbs bandwidth; 2) supports up to two 4K monitors by daisy chain; 3) power delivery up to 15W (PD3220U / PD2720U). See [Power delivery of Thunderbolt™ 3 ports on your monitor \(PD2720U / PD3220U only\) on page 17](#) for more information.
 - With Thunderbolt™ 3 video input, the USB data transmission speed is up to USB 3.1 Gen 2. With DP or HDMI video input, the USB data transmission speed is up to USB 3.1 Gen 1.
 - Above diagram may vary depending on the model.
 - Picture may differ from product supplied for your region.
-

Connections

The following connection illustrations are for your reference only. For cables that are not supplied with your product, you can purchase them separately.

For detailed connection methods, see page [23](#) - [24](#).

PD2720U

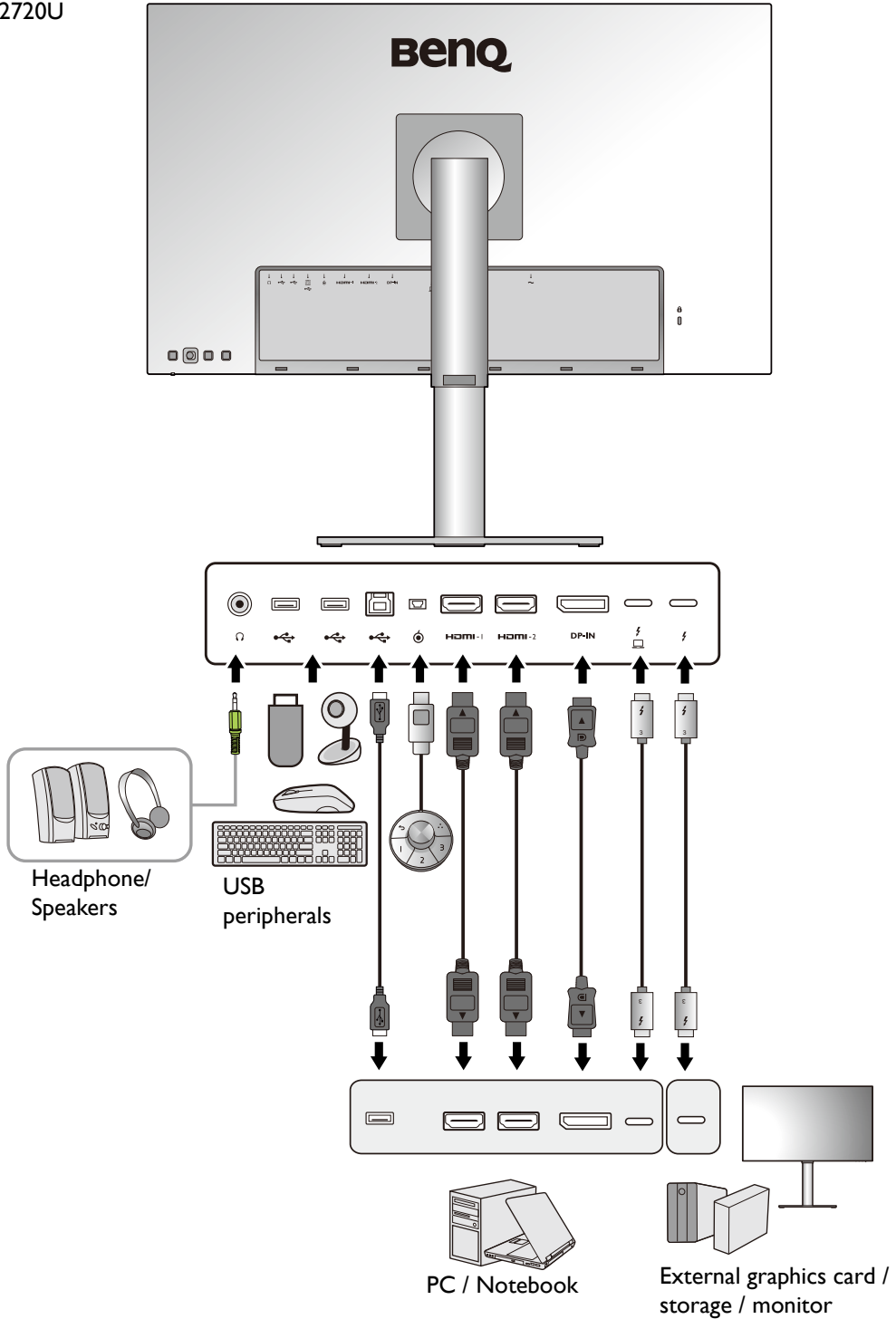

PD3220U

USB
peripherals

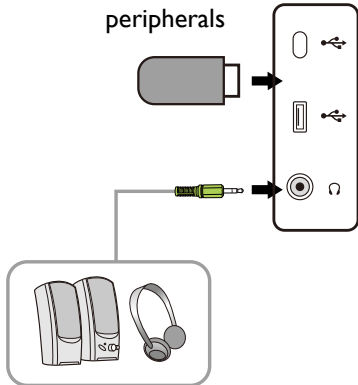

Headphone/
Speakers

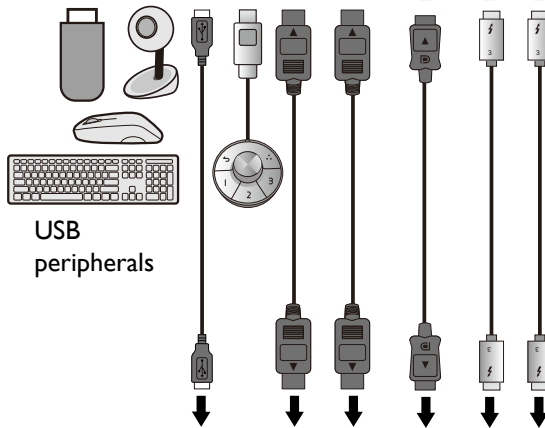
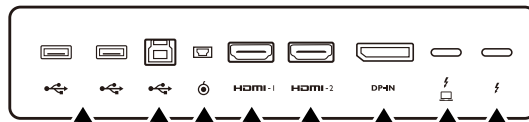
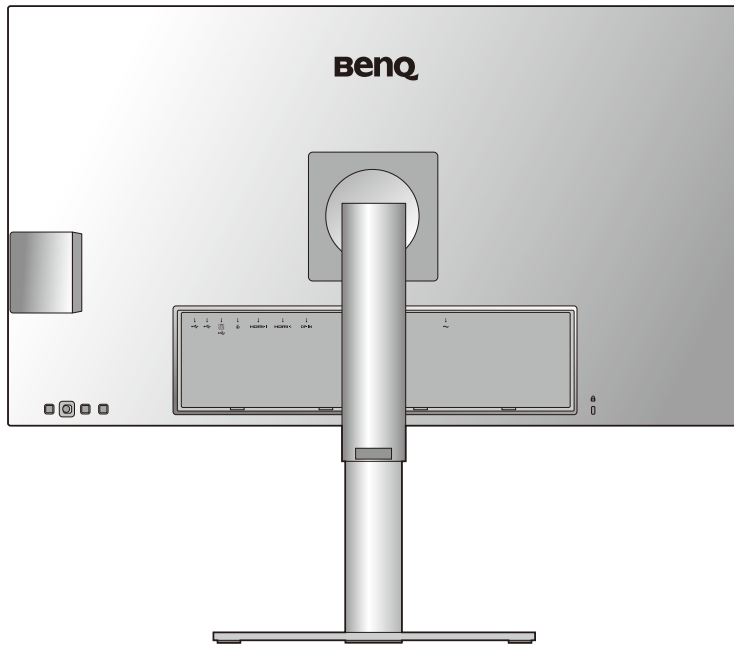

USB
peripherals

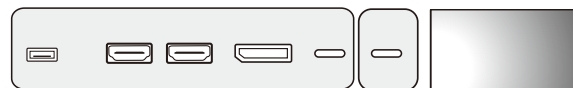

PC / Notebook

External graphics card /
storage / monitor

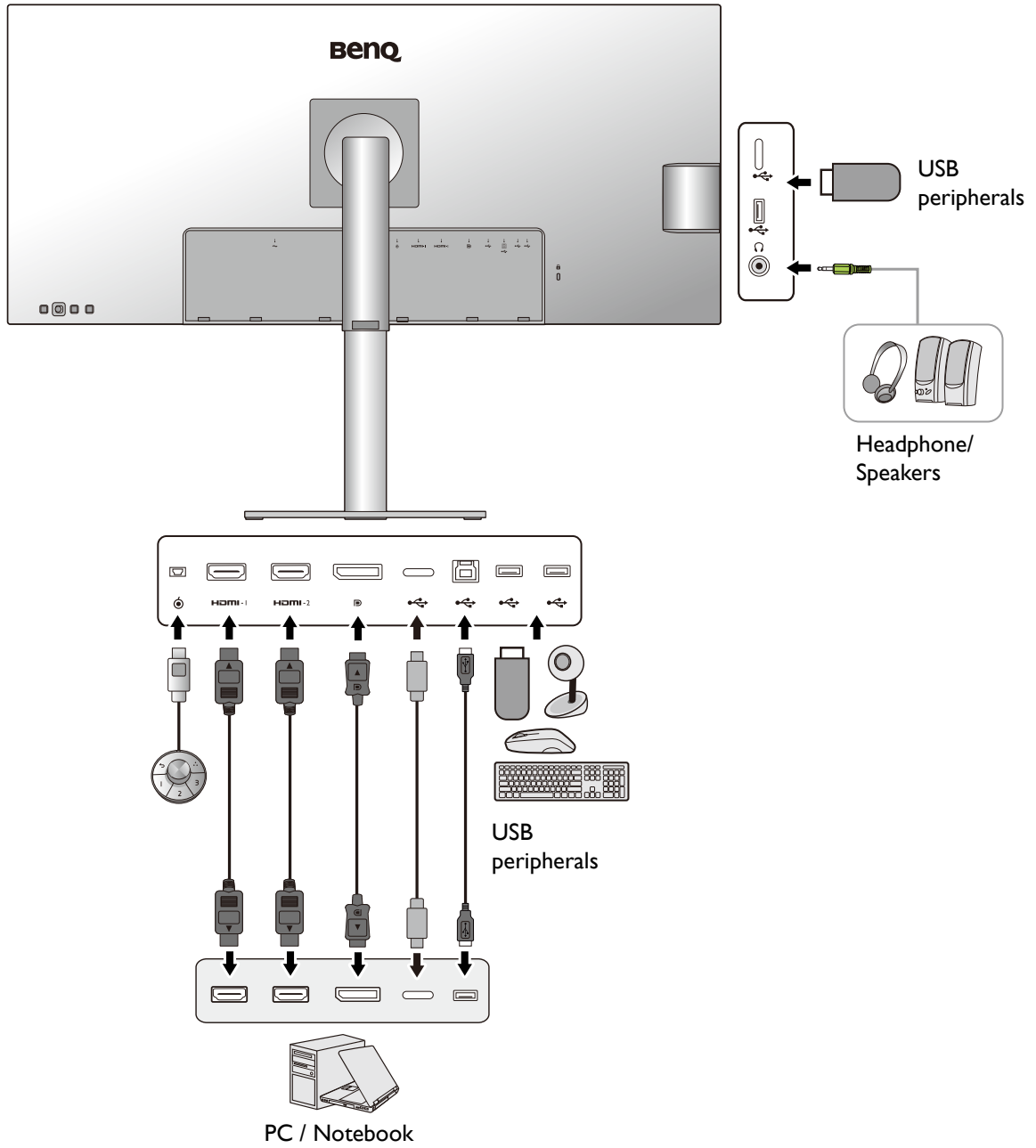

Connectivity of Thunderbolt™ 3 port on your monitor (PD2720U / PD3220U only)

The Thunderbolt™ 3 ports on your product are compatible with Thunderbolt™ 3 and USB-C™ connectors. The connectivity, however, may vary depending on the cable used and the capability of the connected computer.





Computer's port for connection	Cable for connection	Monitor's port for connection	Connectivity
Thunderbolt™ 3 port	<ul style="list-style-type: none"> Passive Thunderbolt™ 3 cable (as provided) USB-C™ cable (purchased separately) 	Thunderbolt™ 3 port	OK
USB-C™ port	Passive Thunderbolt™ 3 cable (as provided)	Thunderbolt™ 3 port	OK
USB-C™ port	Active Thunderbolt™ 3 cable (purchased separately)	Thunderbolt™ 3 port	OK (*)
USB-C™ port	USB-C™ cable (purchased separately)	Thunderbolt™ 3 port	OK



- The length of USB-C™ cable should be less than 1 meter to make the connection easy.
- *: The connectivity is available only when working with compatible Intel IC launched in 2019. Make sure you have a compatible IC before purchasing the cable.

Power delivery of Thunderbolt™ 3 ports on your monitor (PD2720U / PD3220U only)

With the power delivery function, your monitor helps supply power to the connected Thunderbolt™ 3 devices. Available power varies by port. Make sure the devices are connected to the appropriate ports to be activated properly with sufficient power.

PD3220U		PD2720U	
Thunderbolt™ 1 	Thunderbolt™ 2 	Thunderbolt™ 1 	Thunderbolt™ 2 
5V / 3A	5V / 3A	5V / 3A	5V / 3A
9V / 3A	N/A	9V / 3A	N/A
15V / 3A	N/A	15V / 3A	N/A
20V / 4.25A	N/A	20V / 3.25A	N/A

Power delivery of USB-C™ ports on your monitor (PD3420Q only)

With the power delivery function, your monitor helps supply power to the connected USB-C™ devices. Available power varies by port. Make sure the devices are connected to the appropriate ports to be activated properly with sufficient power.

PD3420Q	
USB-C™ 65W (on the rear of the monitor)	USB-C™ (on the left side of the monitor)
5V / 3A	5V / 1.5A
9V / 3A	N/A
12V / 3A	N/A
15V / 3A	N/A
20V / 3.25A	N/A

- A connected device needs to be equipped with a USB-C™ connector that supports charging function via USB power delivery.
- The connected device can be charged via USB-C™ port even when the monitor is in power saving mode. (*)
- The USB power delivery is up to 65W. If the connected device requires more than 65W for operation or for boot up (when the battery is drained), use the original power adapter that came with the device.
- The information is based on the standard testing criteria and is provided for reference. The compatibility is not guaranteed as the user environments vary. If a separately purchased USB-C™ cable is used, make sure the cable is certified by USB-IF and is full-featured, with power delivery and video / audio / data transfer functions.



*: Charging via USB-C™ in monitor power saving mode is available when the **USB-C Awake** function is enabled. Go to **System > USB-C Awake** and select **ON**.

How to assemble your monitor hardware



- If the computer is turned on you must turn it off before continuing.
Do not plug-in or turn-on the power to the monitor until instructed to do so.
- The following illustrations are for your reference only. The location and available input and output jacks may vary depending on the purchased model.



Avoid finger pressure on the screen surface.

I. Attach the monitor base. (PD3420Q)



Please be careful to prevent damage to the monitor. Placing the screen surface on an object like a stapler or a mouse will crack the glass or damage the LCD substrate voiding your warranty. Sliding or scraping the monitor around on your desk will scratch or damage the monitor surround and controls.

While the monitor is still inside the box, remove the cushion that protects the back of the monitor.

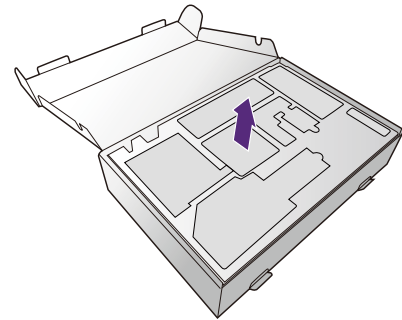

Remove the foam wrap from the monitor stand and base. Attach the monitor stand to the monitor base as illustrated.

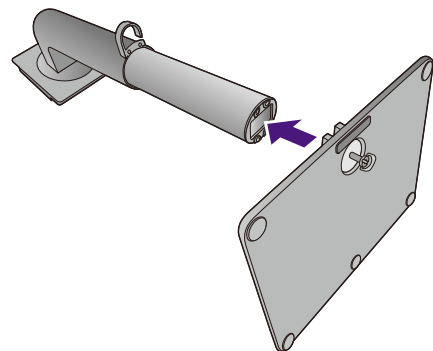

Raise the thumbscrew lid and tighten the thumbscrew as illustrated. Then push the lid back.

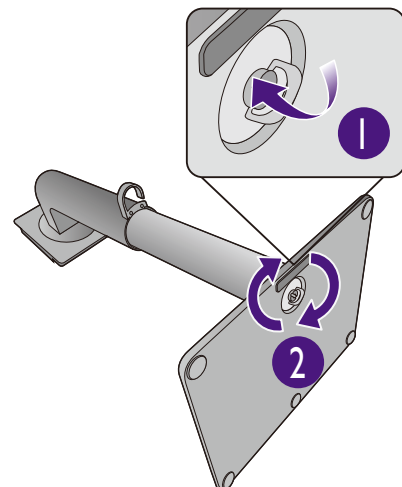

Unfold the front side of the box as illustrated to leave some room for stand and base attachment.

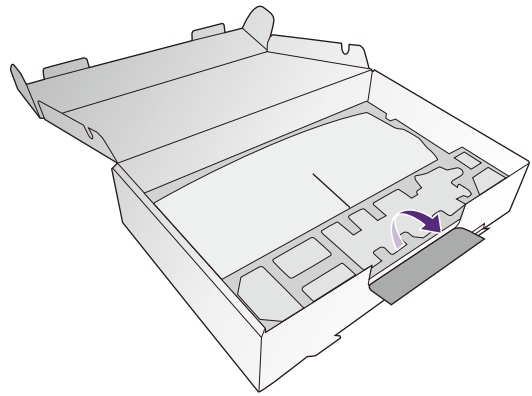

Open the foam wrap that protects the monitor.

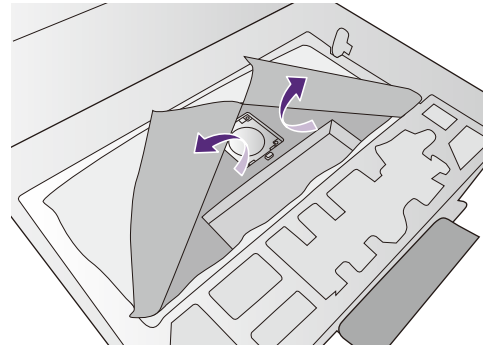

Lift the end of the monitor stand high and orient and align the stand arm with the monitor, then push them together until they click and lock into place.

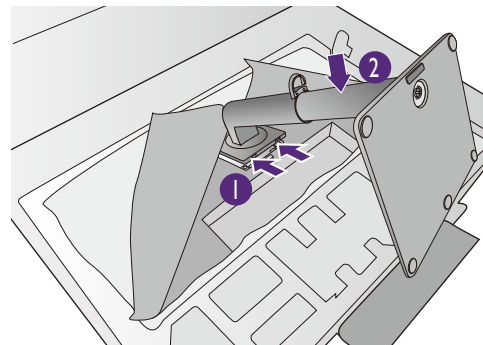

Take the monitor out of the box by holding the stand arm. Carefully lift the monitor, turn it over and place it upright on its stand on a flat even surface.

As the product is heavy, you may need assistance from another person to balance and ensure safety.

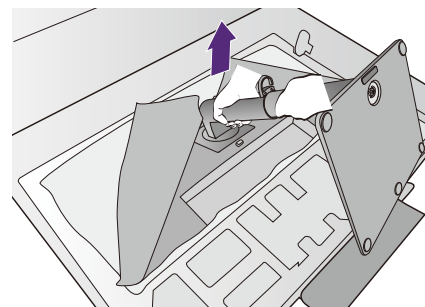

Remove the foam wrap from the monitor. Continue with [Connect the PC video cable. on page 23](#) to complete the hardware assembly.

I. Attach the monitor base. (PD2720U / PD3220U)



Please be careful to prevent damage to the monitor. Placing the screen surface on an object like a stapler or a mouse will crack the glass or damage the LCD substrate voiding your warranty. Sliding or scraping the monitor around on your desk will scratch or damage the monitor surround and controls.

Protect the monitor and screen by clearing a flat open area on your desk and placing a soft item like the monitor packaging bag on the desk for padding.

Gently lay the screen face down on a flat clean padded surface.

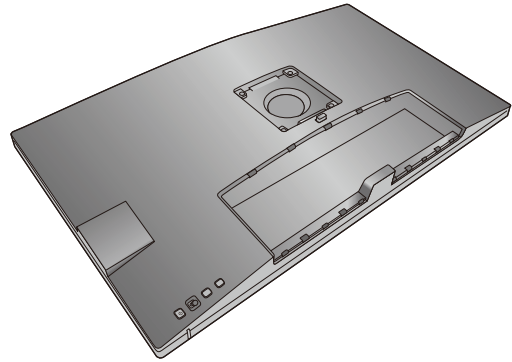

Attach the monitor stand to the monitor base as illustrated.

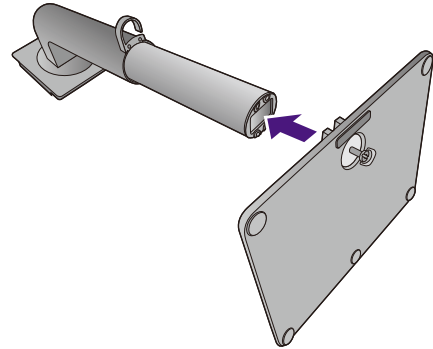

Raise the thumbscrew lid and tighten the thumbscrew as illustrated. Then push the lid back.

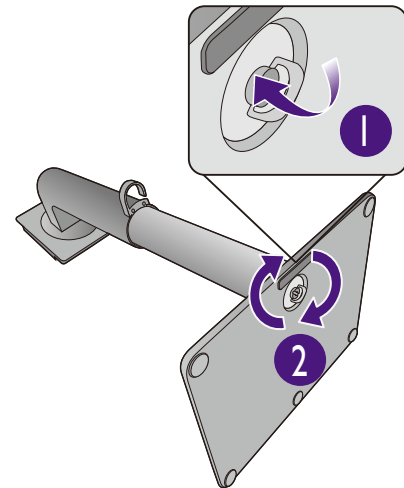

Lift the end of the monitor stand high and orient and align the stand arm with the monitor, then push them together until they click and lock into place.

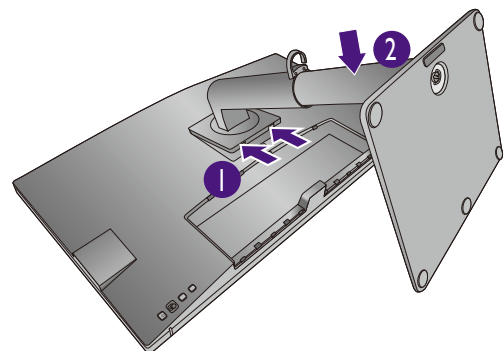

Gently attempt to pull them back apart to check that they have properly engaged.

Carefully lift the monitor, turn it over and place it upright on its stand on a flat even surface.

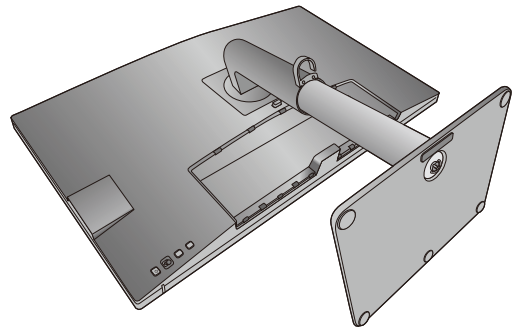

You might want to adjust the monitor stand height. See [Adjusting the monitor height on page 29](#) for more information.

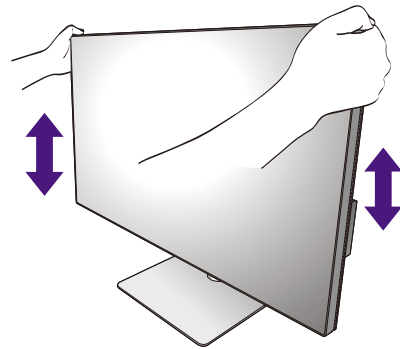

You should position the monitor and angle the screen to minimize unwanted reflections from other light sources.



Your monitor is an edge-to-edge monitor and should be handled with care. Avoid finger pressure on the screen surface. Adjust the screen angle by placing your hands on the top and on the bottom of the monitor as illustrated. Excessive force on the display is prohibited.

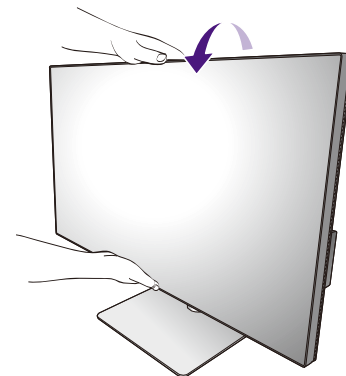

2. Connect the PC video cable.



The video cables included in your package and the socket illustrations in this document may vary depending on the product supplied for your region.

1. Establish a video cable connection.

- Connect the plug of the HDMI cable to the HDMI port on the monitor.
 - Connect the plug of the DP cable to the monitor video socket.
 - (PD2720U / PD3220U) Connect the plug of the Thunderbolt™ 3 cable to the monitor video socket.
- Connect to the  port if power supply to the video source is required.
- (PD3420Q) Connect the plug of the supplied USB-C™ cable to the USB-C™ port on the monitor.

PD2720U / PD3220U

PD3420Q

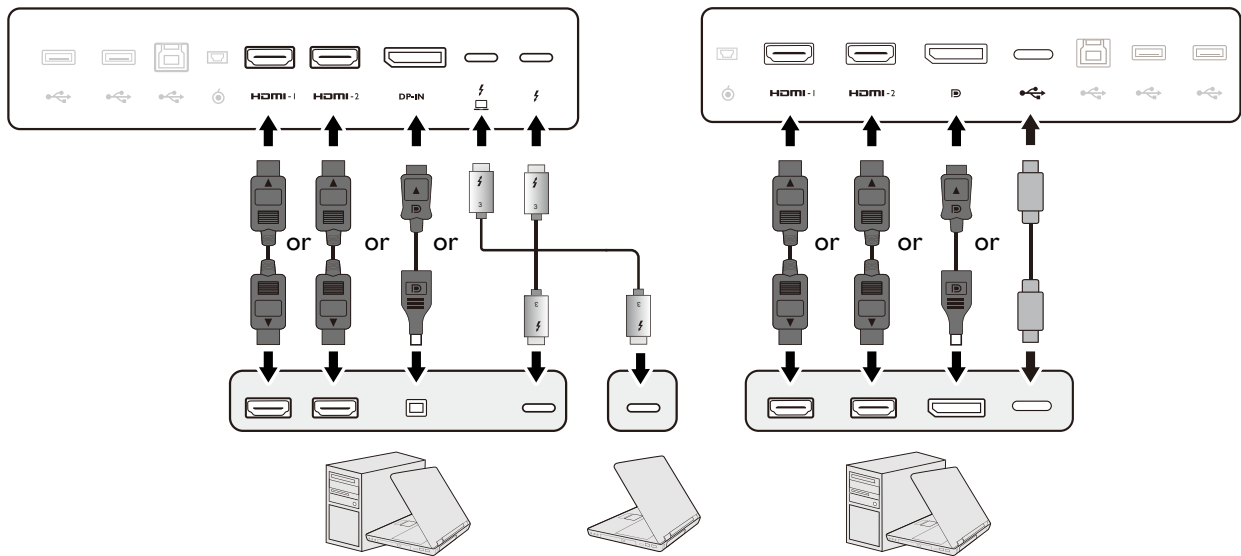

2. Connect the other end of the video cable to an appropriate port of a digital output source (e.g., a computer).
3. Tighten all finger screws to prevent the plugs from accidentally falling out during use.



(DP input only) After the monitor and the computer are powered on, if the image is not displayed, disconnect the DP cable. Connect the monitor to any video source other than DP first. Go to **System > Advanced > DisplayPort** on the OSD menu of the monitor and change the setting from **1.4** to **1.1** or **1.2**. Once the setting is done, unplug the current video cable and re-connect the DP cable. To go to the OSD menu, see [5-way controller and basic menu operations on page 40](#).

3. Connect the headphone.

You may connect the headphones to the headphone jack.

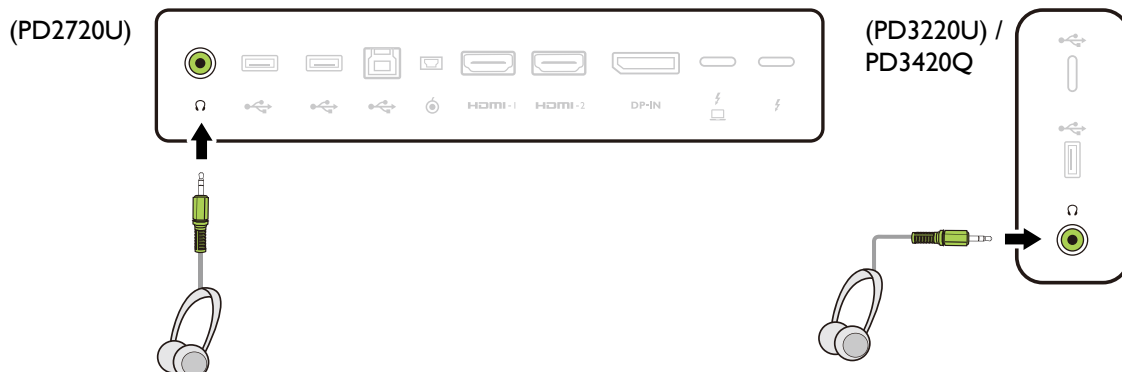

4. Connect the USB devices.

1. Connect the USB cable between the PC and the monitor (via the upstream USB port). This upstream USB port transmits data between the PC and the USB devices connected to the monitor. Note that this step is not required if the video source is from the Thunderbolt™ 3 or USB-C™ inputs.
2. Connect USB devices via other USB ports (downstream) on the monitor. These downstream USB ports transmit data between the connected USB devices and the upstream port.

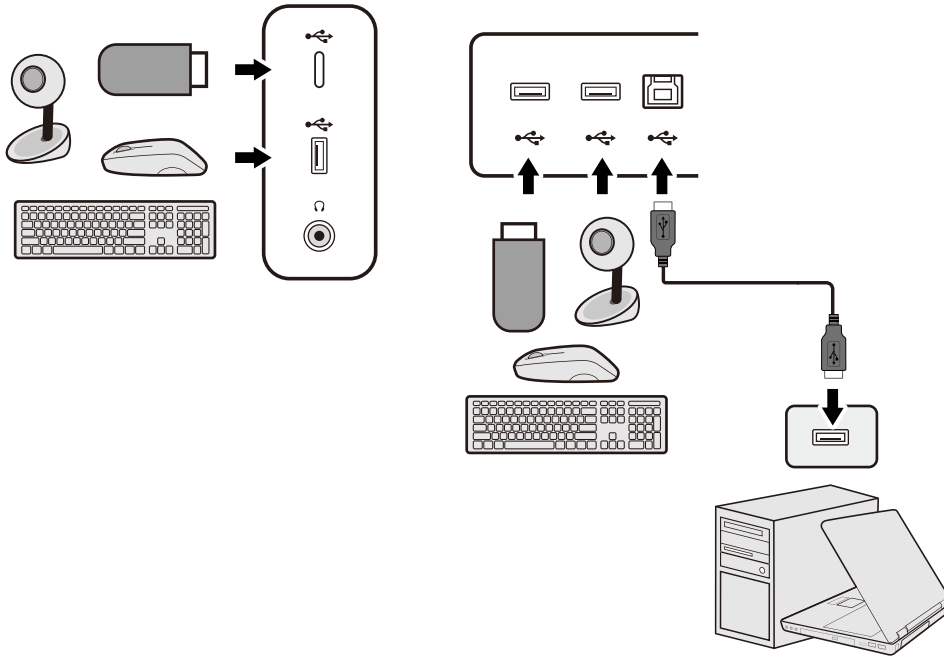

The USB-C™ port on the left or right side works as downstream port and connects with USB devices.

5. Connect the Hotkey Puck G2 to the monitor.

Connect the Hotkey Puck G2 to the mini USB port (exclusively or Hotkey Puck G2 connection) on the rear of the monitor. For more information on Hotkey Puck G2, see [Hotkey Puck G2 and its basic operations on page 44](#).

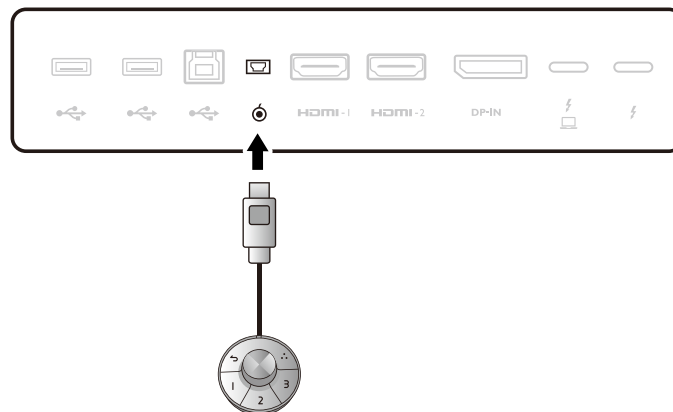

6. Connect the power cable to the monitor.

Plug one end of the power cord into the socket labelled  on the rear of the monitor. Do not connect the other end to a power outlet just yet.

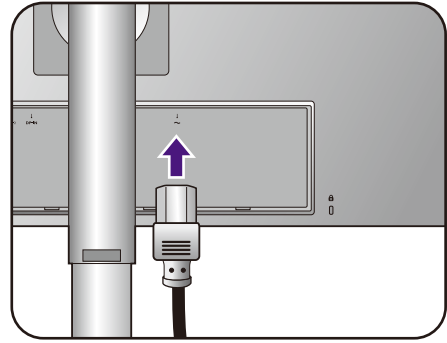

7. Install the back cover.

Align the back cover with the holes on the back of the monitor, and press both sides and the upper part of the cover against the holes to lock it into place as illustrated.

Push the lower part of the back cover toward the monitor to secure it.

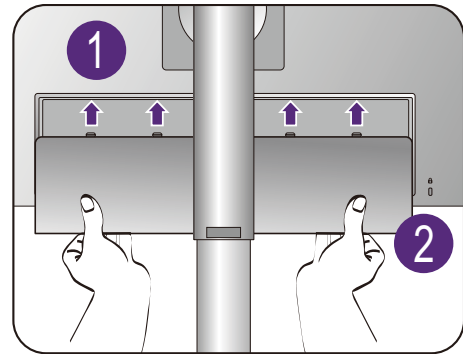

8. Organize the cables.

Route the cables via the cable clip.

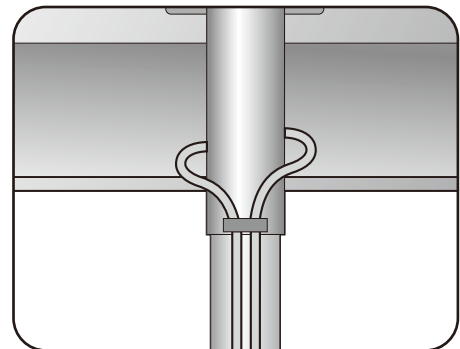

9. Connect-to and turn-on the power.

Plug the other end of the power cord into a power outlet and turn it on.



Picture may differ from product supplied for your region.

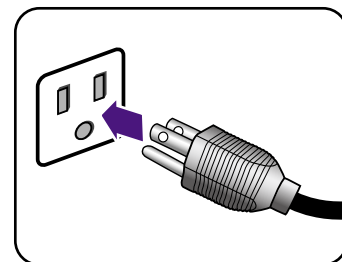

Turn on the monitor by pressing the power button on the monitor.

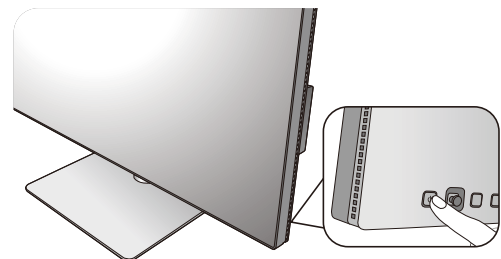

Turn on the computer too, and press the 5-way controller to select an input source.

Follow the instructions in [Getting the most from your BenQ monitor on page 33](#) to install the monitor software.



Available input icons vary by model.



To extend the service life of the product, we recommend that you use your computer's power management function.

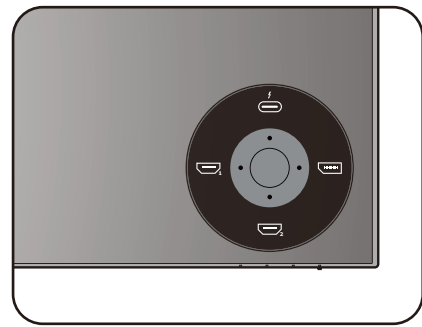
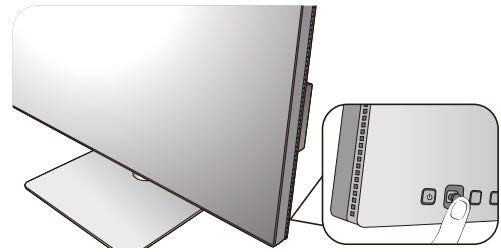

How to detach the stand

1. Prepare the monitor and area.

Turn off the monitor and the power before unplugging the power cable. Turn off the computer before unplugging the monitor signal cable.

2. Remove the back cover.

Remove the back cover from its bottom as illustrated. Unplug all cables carefully.

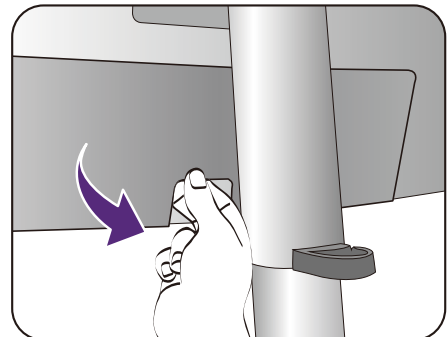

Protect the monitor and screen by clearing a flat open area on your desk and placing a soft item like a towel on the desk for padding, before laying the screen face down on a flat clean padded surface.

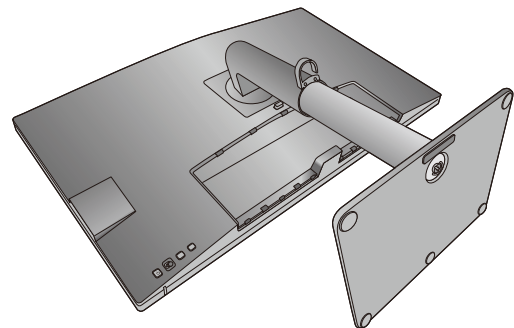

- ⓘ Please be careful to prevent damage to the monitor. Placing the screen surface on an object like a stapler or a mouse will crack the glass or damage the LCD substrate voiding your warranty. Sliding or scraping the monitor around on your desk will scratch or damage the monitor surround and controls.

3. Remove the monitor stand.

While pressing and holding the quick release button, detach the stand from the monitor.

- ⓘ If the monitor stand is removed for wall mounting, see [Using the monitor wall mounting kit on page 32](#) and the instruction manual of your wall mount bracket (purchased separately) for more information.

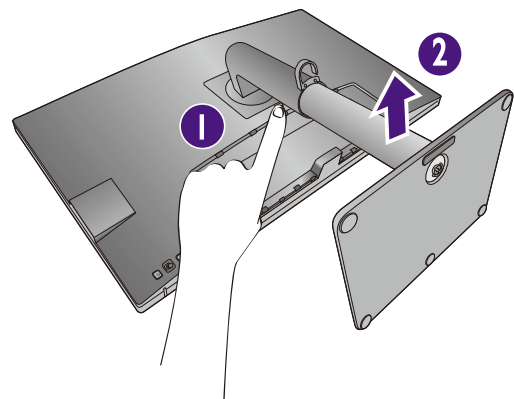

4. Remove the monitor base.

Release the thumbscrew on the bottom of the monitor base.

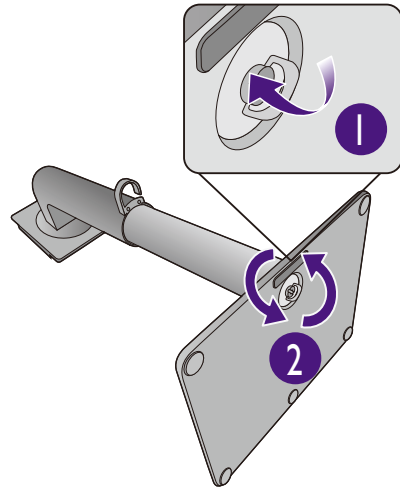

And then detach the base from the stand.

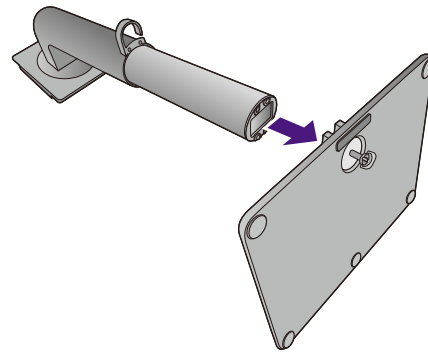

Adjusting the monitor height

To adjust the monitor height, hold both the left and the right sides of the monitor to lower the monitor or lift it up to the desired height.

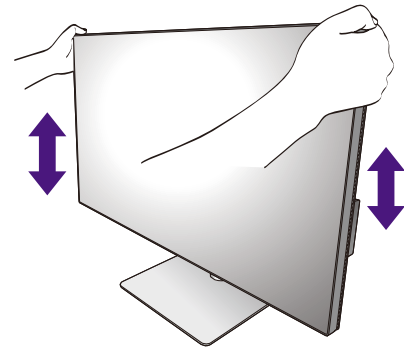

- Avoid placing hands on the upper or lower part of the height-adjustable stand or at the bottom of the monitor, as ascending or descending monitor might cause personal injuries. Keep children out of reach of the monitor while performing this operation.
- If the monitor has been rotated to portrait mode and height adjustment is desired, you should be noted that the wide screen will keep the monitor from being lowered to its minimum height.

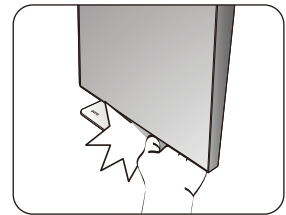
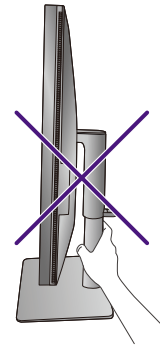

Rotating the monitor (PD2720U / PD3220U only)

1. Pivot the display.

Before rotating the monitor with a portrait viewing orientation, the display has to be rotated 90 degrees.

Right-click the desktop and select **Screen resolution** from the popup menu. Select **Portrait in Orientation**, and apply the setting.



Depending on the operating system on your PC, different procedures should be followed to adjust the screen orientation. Refer to the help document of your operating system for details.

2. Fully extend the monitor and tilt it.

Gently lift the display up and extend it to the maximum extended position. Then tilt the monitor.



The monitor should be vertically extended to allow to rotate from landscape to portrait mode.

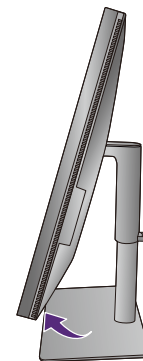
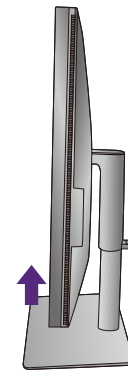

3. Rotate the monitor 90 degrees clockwise as illustrated.

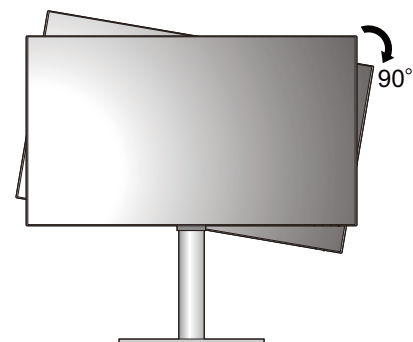



To avoid the edge of the LCD display hitting the monitor base surface while it is being rotated, do tilt and extend the monitor to the highest position before you start to rotate the display. You should also make sure there are no obstacles around the monitor and there is enough room for cables.

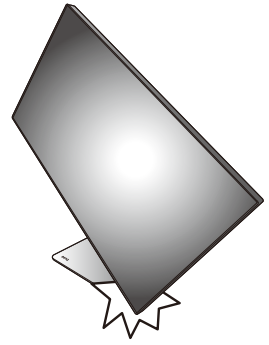

4. Adjust the monitor to the desired viewing angle.



Viewing angle adjustment

You may position the screen to the desired angle with the monitor tilt, swivel, and height adjustment functions. Refer to the product specifications for details.

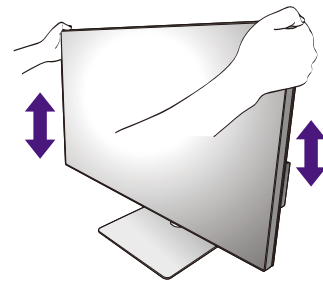
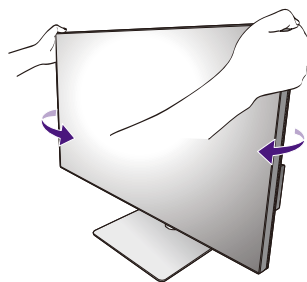
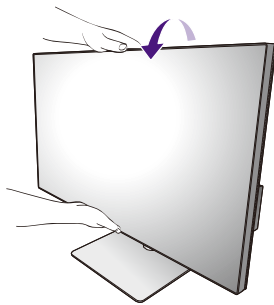

Using the monitor wall mounting kit

The back of your LCD monitor has a VESA standard mount with 100mm pattern, allowing the installation of a wall mount bracket. Before starting to install a monitor wall mounting kit, please read the precautions carefully.

Precautions

- Install your monitor and monitor mounting kit on a wall with flat surface.
- Ensure that the wall material and the standard wall mount bracket (purchased separately) are stable enough to support the weight of the monitor. Refer to the product specifications for weight information.
- Turn off the monitor and the power before disconnecting the cables from the LCD monitor.

1. Remove the monitor stand.

Lay the screen face down on a clean and well-padded surface. Detach the monitor stand as instructed in [How to detach the stand on page 27](#).

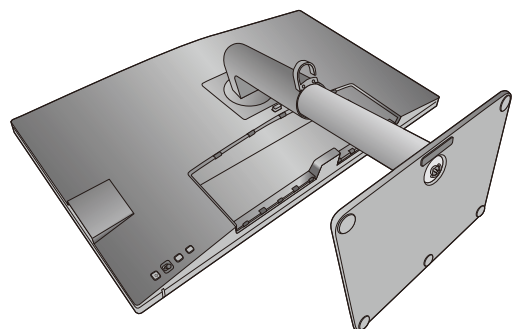

Use a cross-pointed screwdriver to release the screws that fixing the back cover to the monitor. The use of a magnetic-head screwdriver is recommended to avoid of losing the screws.

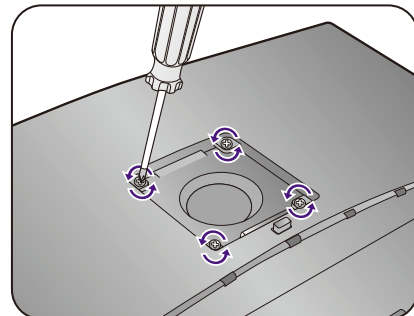

In case you intend to use your monitor on the stand in the future, please keep the monitor base, monitor stand, and screws somewhere safe for future use.

2. Follow the instruction manuals of the wall mount bracket you purchased to complete the installation.



Use four M4 x 10 mm screws to fix a VESA standard wall mount bracket to the monitor. Make sure that all screws are tightened and secured properly. Consult a professional technician or BenQ service for wall mount installation and safety precautions.

Getting the most from your BenQ monitor

To gain the most benefit from your new BenQ LCD monitor, you should install the custom BenQ LCD Monitor driver software as provided on the BenQ LCD Monitor CD-ROM.

The circumstances under which you connect and install your BenQ LCD Monitor will determine which process you need to follow to successfully install the BenQ LCD Monitor driver software. These circumstances relate to which version of Microsoft Windows you are using, and whether you are connecting the monitor and installing the software onto a new computer (without existing monitor driver software), or whether you are upgrading an existing installation (which already has existing monitor driver software) with a newer monitor.

In either case however, the very next time you turn on your computer (after connecting the monitor to your computer), Windows will automatically recognize the new (or different) hardware, and will launch its **Found New Hardware wizard**.

Follow the wizard instructions until it asks you to select a monitor model. At that point, click the **Have Disk** button, insert the BenQ LCD Monitor CD-ROM and select the appropriate monitor model. Further details and step-by-step instructions for either an automatic (new) or upgrade (existing) installation, see:

- [How to install the monitor on a new computer on page 34.](#)
- [How to upgrade the monitor on an existing computer on page 35.](#)



- If you require a User Name and Password to login to your Windows computer, you must be logged on as an Administrator or as a member of the Administrators group in order to install the monitor driver software. Furthermore, if your computer is connected to a network which has security access requirements, network policy settings may prevent you from installing software on your computer.
 - To check the name of the purchased model, refer to the specification label on the back of the monitor.
-

How to install the monitor on a new computer

This instruction details the procedure for selecting and installing the BenQ LCD Monitor driver software on a new computer which has never had a monitor driver installed before. This instruction is only suitable for a computer which has never been used before, and for which the BenQ LCD Monitor is the first ever monitor to be connected to it.



If you are adding the BenQ LCD Monitor to an existing computer that has already had another monitor connected to it (and has monitor driver software installed), you should not be following these instructions. You should instead be following the instructions for [How to upgrade the monitor on an existing computer](#).

1. Follow the instructions in [How to assemble your monitor hardware on page 19](#).
When Windows starts, it will automatically detect the new monitor and launch the **Found New Hardware Wizard**. Follow the prompts until it displays the option to **Install Hardware Device Drivers**.
2. Insert the BenQ LCD Monitor CD-ROM into a CD drive on the computer.
3. Check **Search for a suitable driver for my device** option, and click **Next**.
4. Check the option for CD-ROM drives (uncheck all others) and click **Next**.
5. Look to confirm that the wizard has selected the correct name of your monitor and click **Next**.
6. Click **Finish**.
7. Restart the computer.



To find the suitable driver files for the purchased model, refer to the following table.

Driver files	Suitable models
PD2720U	PD2720U / PD2720UE
PD3220U	PD3220U / PD3220UE
PD3420Q	PD3420Q / PD3420QE

How to upgrade the monitor on an existing computer

This instruction details the procedure for manually updating the existing monitor driver software on your Microsoft Windows computer. It is currently tested as compatible for Windows 10, Windows 8 (8.1), and Windows 7 Operating System (OS).



The BenQ LCD Monitor driver for your model may well function perfectly with other versions of Windows, however, as at the time of writing, BenQ has done no testing of this driver on other versions of Windows and cannot guarantee its operation on those systems.

Installing monitor driver software involves selecting an appropriate information file (.inf) on the BenQ LCD Monitor CD-ROM for the particular model monitor you have connected, and letting Windows install the corresponding driver files from the CD. You need only steer it in the right direction. Windows has an Upgrade Device Driver Wizard to automate the task and guide you through the file selection and installation process.

See:

- [How to install on Windows 10 system on page 36.](#)
- [How to install on Windows 8 \(8.1\) system on page 37.](#)
- [How to install on Windows 7 system on page 38.](#)

How to install on Windows 10 system

1. Open **Display Properties**.

Go to **Start, Settings, Devices, Devices and Printers** and right-click the name of your monitor from the menu.

2. Select **Properties** from the menu.

3. Click the **Hardware** tab.

4. Click **Generic PnP Monitor**, and then the **Properties** button.

5. Click the **Driver** tab and the **Update Driver** button.

6. Insert the BenQ LCD Monitor CD-ROM into a CD drive on the computer.

7. In the **Update Driver Software** window, select the option **Browse my computer for driver software**.

8. Click **Browse** and navigate to the following directory: d:\BenQ_LCD\Driver\ (where d is the drive letter designator for the CD-ROM drive).



The drive letter for your CD drive may differ from the example above depending upon your system - it may be 'D:' or 'E:' or 'F:' etc.

9. Select the correct folder name of your monitor from provided driver list, and click **Next**.

This will copy and install the appropriate monitor driver files to your computer.

10. Click **Close**.

You may be prompted to restart your computer after the driver update is complete.

How to install on Windows 8 (8.1) system

1. Open **Display Properties**.

Move the cursor to the lower-right of the screen or press the **Windows + C** buttons on the keyboard to bring up the **Charm** bar. Go to **Settings, Control Panel, Devices and Printers** and right-click the name of your monitor from the menu.

Alternatively, right-click the desktop and select **Personalize, Display, Devices and Printers**, and right-click the name of your monitor from the menu.

2. Select **Properties** from the menu.

3. Click the **Hardware** tab.

4. Click **Generic PnP Monitor**, and then the **Properties** button.

5. Click the **Driver** tab and the **Update Driver** button.

6. Insert the BenQ LCD Monitor CD-ROM into a CD drive on the computer.

7. In the **Update Driver Software** window, select the option **Browse my computer for driver software**.

8. Click **Browse** and navigate to the following directory: d:\BenQ_LCD\Driver\ (where d is the drive letter designator for the CD-ROM drive).



The drive letter for your CD drive may differ from the example above depending upon your system - it may be 'D:' or 'E:' or 'F:' etc.

9. Select the correct folder name of your monitor from provided driver list, and click **Next**.

This will copy and install the appropriate monitor driver files to your computer.

10. Click **Close**.

You may be prompted to restart your computer after the driver update is complete.

How to install on Windows 7 system

1. Open **Display Properties**.

Go to **Start, Control Panel, Hardware and Sound, Devices and Printers** and right-click the name of your monitor from the menu.

Alternatively, right-click the desktop and select **Personalize, Display, Devices and Printers**, and right-click the name of your monitor from the menu.

2. Select **Properties** from the menu.

3. Click the **Hardware** tab.

4. Click **Generic PnP Monitor**, and then the **Properties** button.

5. Click the **Driver** tab and the **Update Driver** button.

6. Insert the BenQ LCD Monitor CD-ROM into a CD drive on the computer.

7. In the **Update Driver Software** window, select the option **Browse my computer for driver software**.

8. Click **Browse** and navigate to the following directory: d:\BenQ_LCD\Driver\ (where d is the drive letter designator for the CD-ROM drive).



The drive letter for your CD drive may differ from the example above depending upon your system - it may be 'D:' or 'E:' or 'F:' etc.

9. Select the correct folder name of your monitor from provided driver list, and click **Next**.

This will copy and install the appropriate monitor driver files to your computer.

10. Click **Close**.

You may be prompted to restart your computer after the driver update is complete.

How to adjust your monitor

The control panel

All OSD (On Screen Display) menus can be accessed by the control keys. You can use the OSD menu to adjust all the settings on your monitor

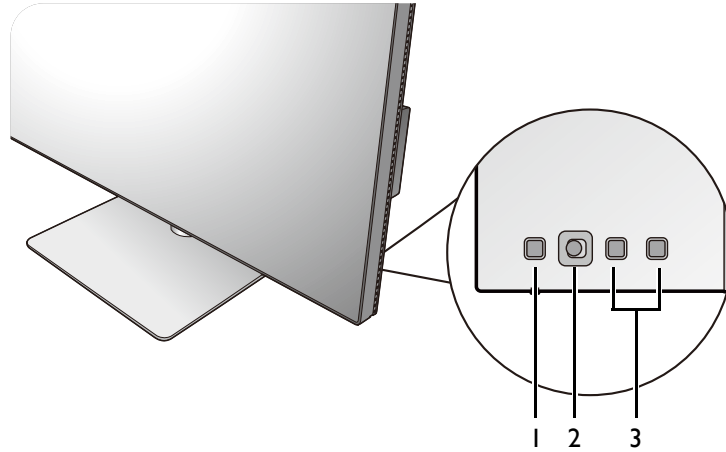





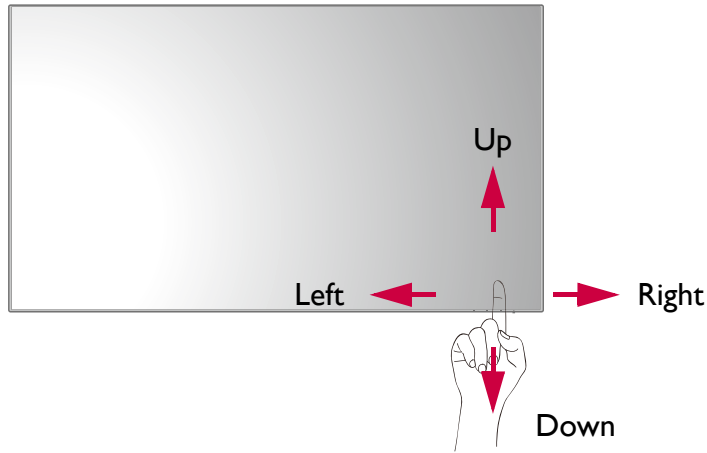

No.	Name	Description
1.	Power key	Turns the power on or off.
2.	5-way controller	Accesses the functions or menu items as instructed by the on-screen icons. See 5-way controller and basic menu operations on page 40 for more information.
3.	Custom keys	Accesses the functions or menu items displayed on the screen, right next to each key. See Working with the hot keys on page 42 for more information.

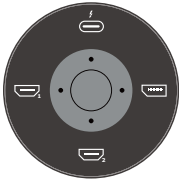
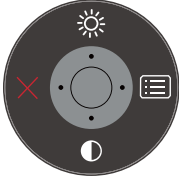
5-way controller and basic menu operations

The 5-way controller is located at the rear of the monitor. While sitting in front of the monitor, move the controller to the directions instructed by the on-screen icons for menu navigation and operations.



OSD icon	5-way controller operation	Function
(When no menu has been activated)		
N/A	Press the 5-way controller	<ul style="list-style-type: none"> • (Without video cable connection) Activates the video source selection menu. • (With video cable connection) Activates the hotkey menu.
(When the video source selection menu has been activated)		
	Move the 5-way controller to the desired direction	Switches to the desired input source. Available input icons vary by model.
(When the hotkey menu has been activated)		
	Move to the right	Activates the main menu.
	Move up	Adjusts brightness.
	Move down	Adjusts contrast.
	Move to the left	Closes the hotkey menu.
(When the main menu has been activated)		
	Press	Confirms the selection.
	Move to the right	<ul style="list-style-type: none"> • Enters sub menus. • Confirms the selection.
	Move up	<ul style="list-style-type: none"> • Goes to the previous menu item. • For up / increase adjustment.

OSD icon	5-way controller operation	Function
	Move down	<ul style="list-style-type: none"> • Goes to the next menu item. • For down / decrease adjustment.
	Move to the left	<ul style="list-style-type: none"> • Returns to the previous menu. • Exits OSD menu.

All OSD (On Screen Display) menus can be accessed by the control keys. You can use the OSD menu to adjust all the settings on your monitor. Available menu options may vary depending on the input sources, functions and settings.

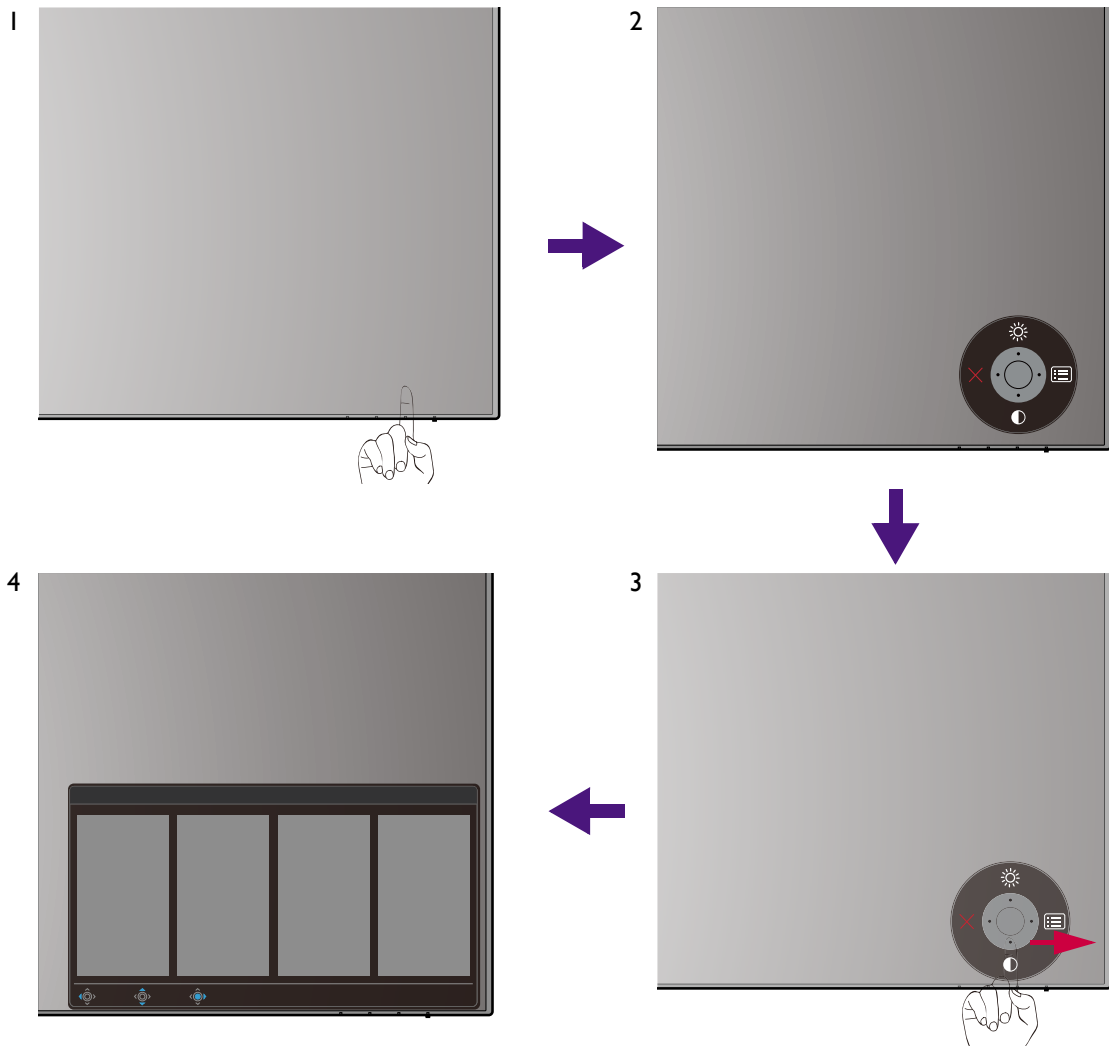

1. Press the 5-way controller.
2. The hot key menu is displayed. The top and down icons are designated for particular functions.
3. Select  (**Menu**) to access the main menu.
4. On the main menu, follow the on-screen icons on the bottom of the menu to make adjustments or selection. See [Navigating the main menu on page 53](#) for details on the menu options.



Working with the hot keys

The custom keys (located next to the 5-way controller) perform as hot keys to provide direct access to pre-defined functions. You can change the default setting and designate different functions for these keys.

Accessing the hot key functions

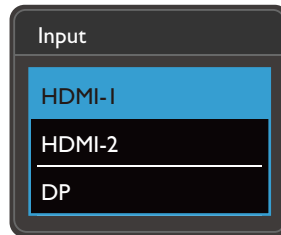
1. Press any of the custom keys on the rear of the monitor.
2. Press the key with the desired function repeatedly to cycle through available options on the list.



OSD icon	Function
	Switches to a list of Color Mode options by default. To change the default settings, see Customizing the hot keys on page 42 .
	Switches to a list of Input options by default. To change the default settings, see Customizing the hot keys on page 42 .

Customizing the hot keys

1. Press the 5-way controller to bring up the hotkey menu.
2. Select  (**Menu**) to access the main menu.
3. Go to **Custom Key**.
4. Select the custom key you want to change. It is either **Custom Key 1** or **Custom Key 2**.
5. On the sub menu, select a category.

6. Under the category, check to select up to 3 items for quick access by this key.

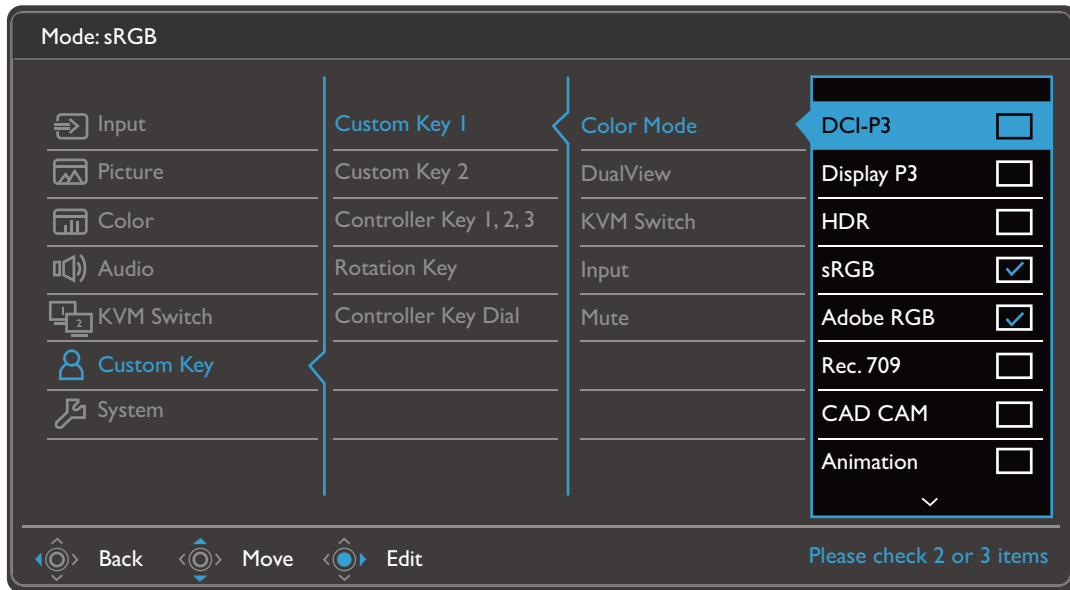

• OSD = On Screen Display.

The hot keys only operate while the main menu is not currently displaying. Hot key displays will disappear after a few seconds of no key activity.

• To unlock the OSD controls, press and hold any key for 10 seconds.

Hotkey Puck G2 and its basic operations

Apart from the control keys, Hotkey Puck G2 also provides a quick way to control and access the OSD menu.



- You need to connect the Hotkey Puck G2 to your monitor prior to use. Follow the instructions in [Connect the Hotkey Puck G2 to the monitor](#) on page 24.
- Hotkey Puck G2 is designed for BenQ LCD Monitor exclusively and is available for compatible models only. Do not connect it to other devices with mini USB ports.

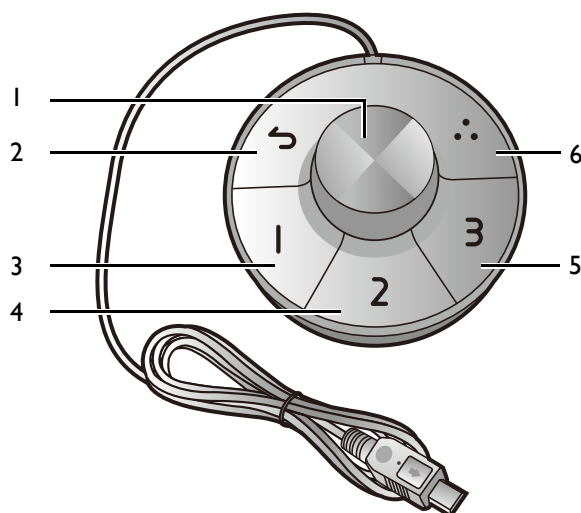

No.	Name	Description
1	Dial key	<p>(If no menu is displayed)</p> <ul style="list-style-type: none"> Turn right or left to adjust Brightness by default. To change the default settings, press and hold for 3 seconds to bring up the setup menu to change the default setting. Alternatively, go to Custom Key > Controller Key Dial on the monitor. Press to bring up the main menu. <p>(On a menu)</p> <ul style="list-style-type: none"> Turn right to scroll down the menu. Turn left to scroll up the menu. Press to confirm the selection. <p>(If a control bar is displayed)</p> <ul style="list-style-type: none"> Turn right to increase the value. Turn left to decrease the value.
2	Return key	<ul style="list-style-type: none"> Returns to the previous menu. Exits OSD menu.
3	Controller Key I	<ul style="list-style-type: none"> Press to switch to M-book (Color Mode) by default. Press and hold for 3 seconds to bring up the setup menu to change the default setting. Alternatively, see Customizing the Controller Keys on Hotkey Puck G2 on page 45.

No.	Name	Description
4	Controller Key 2	<ul style="list-style-type: none"> • Press to switch to sRGB (Color Mode). • Press and hold for 3 seconds to bring up the setup menu to change the default setting. Alternatively, see Customizing the Controller Keys on Hotkey Puck G2 on page 45.
5	Controller Key 3	<ul style="list-style-type: none"> • Press to switch to Display P3 (Color Mode). • Press and hold for 3 seconds to bring up the setup menu to change the default setting. Alternatively, see Customizing the Controller Keys on Hotkey Puck G2 on page 45.
6	Rotation Key	<ul style="list-style-type: none"> • Press repeatedly to cycle through available settings. • Press and hold for 3 seconds to bring up the setup menu to change the default setting. Alternatively, go to Custom Key > Rotation Key on the monitor.

Customizing the Controller Keys on Hotkey Puck G2

Keys on the Hotkey Puck G2 are designated for particular functions. You can change the default settings as desired.

1. Press the 5-way controller to bring up the hotkey menu.
2. Select  (**Menu**) to access the main menu.
3. Go to **Custom Key**.
4. Select **Controller Key 1, 2, 3**.
5. On the sub menu, select a category.
6. Under the category, check to select up to 3 items for quick access by the Controller Keys on Hotkey Puck G2. The numbers displayed by the chosen items refer to the Controller Keys that the options are assigned to.



Alternatively, press and hold a key on the Hotkey Puck G2 for 3 seconds to bring up the setup menu to change the default setting.

Controlling the display with Display Pilot

The **Display Pilot** software is provided as an alternative to control the display. Download and install from www.benq.com.

The main functions include:

- Control of the main functions / configurations of the monitor.
- (PD2720U / PD3220U) Setup of rotating the display with the monitor automatically (see [page 30](#)).
- Additional tools to extend the monitor's functionalities.

For more information, visit www.BenQ.com for **Display Pilot** manual.



Display Pilot is available on Windows 7, Windows 8 (8.1), and Windows 10.

Adjusting Display Mode

To display images of aspect ratios other than your monitor aspect ratio and sizes other than your display size, you can adjust the display mode on the monitor.

1. Press the 5-way controller to bring up the hotkey menu, and select  (**Menu**) to access the main menu.
2. Go to **Picture > Advanced > Display Mode**.
3. Select an appropriate display mode. The setting will take effect immediately.

Choosing an appropriate color mode

Your monitor provides various color modes that are suitable for different types of images. See [Color Mode on page 59](#) for all the available color modes.

Go to **Color > Color Mode** for a desired color mode.



The computer's color profile (ICC profile) may not best suit your monitor. If you want to make sure to obtain the accurate color matching representation, change the computer's ICC profile to ensure the computer works better with the monitor. Visit www.BenQ.com > the purchased model > the **Downloads** or **Support** tab > the **User Manual** tab to access the **ICC Profile Installation Guide** for instructions. Alternatively, enable the **ICC Sync** function from **Display Pilot** ([page 45](#)). Refer to the **Display Pilot** manual for details.

Working with two video sources (KVM Switch)

If you have two computer systems, you might find yourself busy going back and forth between two sets of keyboard and mouse to control each display separately. Now with the KVM feature and sufficient I/O ports on one monitor, you can work with one set of keyboard and mouse only.

To use KVM Switch feature, toggle between **Thunderbolt 3** (PD2720U / PDS3220U) / **USB-C** (PD3420Q) or **USB Upstream** under **KVM Switch**.

- **KVM Switch > Thunderbolt 3** (PD2720U / PDS3220U) / **USB-C** (PD3420Q): Switches to the Thunderbolt™ 3 (PD2720U / PDS3220U) / USB-C™ (PD3420Q) input.
- **KVM Switch > USB Upstream**: Switches to one of the video inputs other than Thunderbolt™ 3 (PD2720U / PDS3220U) / USB-C™ (PD3420Q). With appropriate setting, the display is switched to the set input while the keyboard and mouse control is switched as well. To determine the input, see [Setting up the second video source for KVM Switch before use on page 46](#).

You can designate one of the custom keys to **KVM Switch** to toggle between the options quickly. See [Customizing the hot keys on page 42](#).

Setting up the second video source for KVM Switch before use

One of the video sources is pre-defined to be transmitted via Thunderbolt™ 3 (PD2720U / PDS3220U) / USB-C™ (PD3420Q) and cannot be changed. The other source can come from other available inputs and should be set appropriately in advance.

1. Connect the second video source to one of the video inputs other than Thunderbolt™ 3 (PD2720U / PDS3220U) / USB-C™ (PD3420Q) on the monitor using an appropriate cable.

2. Press the 5-way controller to bring up the hotkey menu, and select  (**Menu**) to access the main menu.
3. Go to **KVM Switch > Video Input**.
4. Change the setting according to your scenario.
 - For [Scenario A: Working with two computers and one monitor on page 47](#), select the video input just connected. When **USB Upstream** under **KVM Switch** is selected, the display and USB control change from Thunderbolt™ 3 (PD2720U / PD3220U) / USB-C™ (PD3420Q) to the other connected video input.
 - For [Scenario B: Working with two computers and two monitors on page 48](#) and [Scenario C: Working in PBP mode on page 48](#), select **None**. This is because two video inputs are displayed simultaneously and require no switch. The **None** option will switch USB control only.



If **None** is selected from **KVM Switch > Video Input** for [Scenario A: Working with two computers and one monitor](#) and **USB Upstream** is selected for KVM Switch, the screen does not display anything from the second source as there is none. You cannot control the current display (from Thunderbolt™ 3 or USB-C™, depending on your purchased model) either as the keyboard and mouse control has been switched away. In this case, select a video input manually from **Input > Signal Input**.



- After the second source has been set properly from **KVM Switch > Video Input**, you can go to **KVM Switch > Auto Switch** and turn on the Auto Switch function. Once enabled, if USB or Thunderbolt™ 3 (PD2720U / PD3220U) / USB-C™ (PD3420Q) cable is disconnected, the USB input source and the control will be switched to the other computer automatically.
- The KVM Auto Switch might not switch video and USB signals simultaneously if **None** is selected from **KVM Switch > Video Input**. In this case, select a video input manually from **Input > Signal Input**.

Scenario A: Working with two computers and one monitor

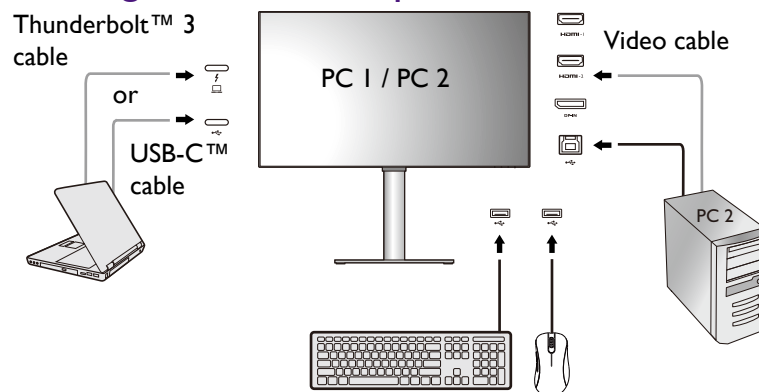

1. Establish cable connection as instructed in [Connect the PC video cable on page 12](#).
2. Go to **System > Power Awake > USB** and select **ON**.
3. Set up the second video source as instructed in [Setting up the second video source for KVM Switch before use on page 46](#).
4. Go to **KVM Switch** and switch between **Thunderbolt 3** (PD2720U / PD3220U) / **USB-C** (PD3420Q) and **USB Upstream**. If one of the custom key is set for **KVM Switch**, press the custom key to switch.

Scenario B: Working with two computers and two monitors

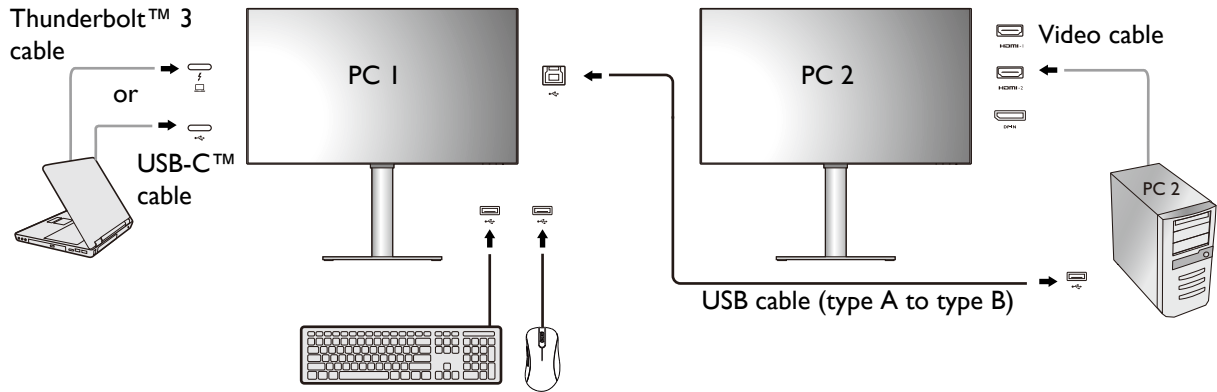

1. Establish cable connection as instructed in [Connect the PC video cable on page 12](#).
2. Go to **System > Power Awake > USB** and select **ON**.
3. Go to **KVM Switch > Video Input** and select **None**.
4. Go to **KVM Switch** and switch between **Thunderbolt 3** (PD2720U / PD3220U) / **USB-C** (PD3420Q) and **USB Upstream**. If one of the custom key is set for **KVM Switch**, press the custom key to switch.

Scenario C: Working in PBP mode

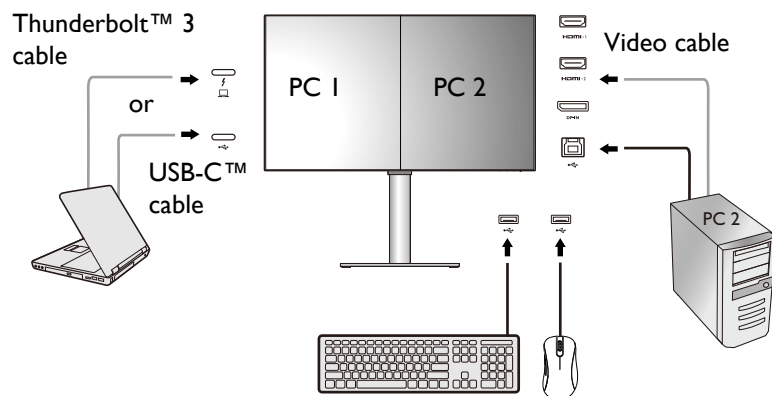

1. Establish cable connection as instructed in [Connect the PC video cable on page 12](#).
2. Go to **System > Power Awake > USB** and select **ON**.
3. Enable PBP function from **Input > PBP**. Select sources properly as instructed in [Video source selection in PBP mode on page 49](#).
4. Go to **KVM Switch > Video Input** and select **None**.
5. Go to **KVM Switch** and switch between **Thunderbolt 3** (PD2720U / PD3220U) / **USB-C** (PD3420Q) and **USB Upstream**. If one of the custom key is set for **KVM Switch**, press the custom key to switch.

Video source selection in PIP mode

For first time use, go to **Input > PIP**, and press the 5-way controller. Your monitor scans for the available video sources in the following order: Thunderbolt™ 3 (PD2720U / PD3220U), USB-C™ (PD3420Q), DP, and HDMI, and displays the first available one as the main source in PIP mode, and the second one as the sub source. If only one input signal is found, connect the desired video source with an appropriate cable, and go to **Input > PIP > Sub** to select the sub source manually. Under **Input > PIP > Main**, the main source can be changed manually as well.

The monitor keeps the setting of two input sources for future use until the setting is manually changed.

Video source selection in PBP mode

1. Go to **Input > PBP, PBPx4 or PBP 5:9**.
2. Select the preferred source for each window.

Connecting multiple monitors (Thunderbolt™ 3 daisy chaining)(PD2720U / PD3220U)

With monitor connection via Thunderbolt™ 3 ports, you can output content to up to 6 devices (including 2 monitors) via daisy chain function.

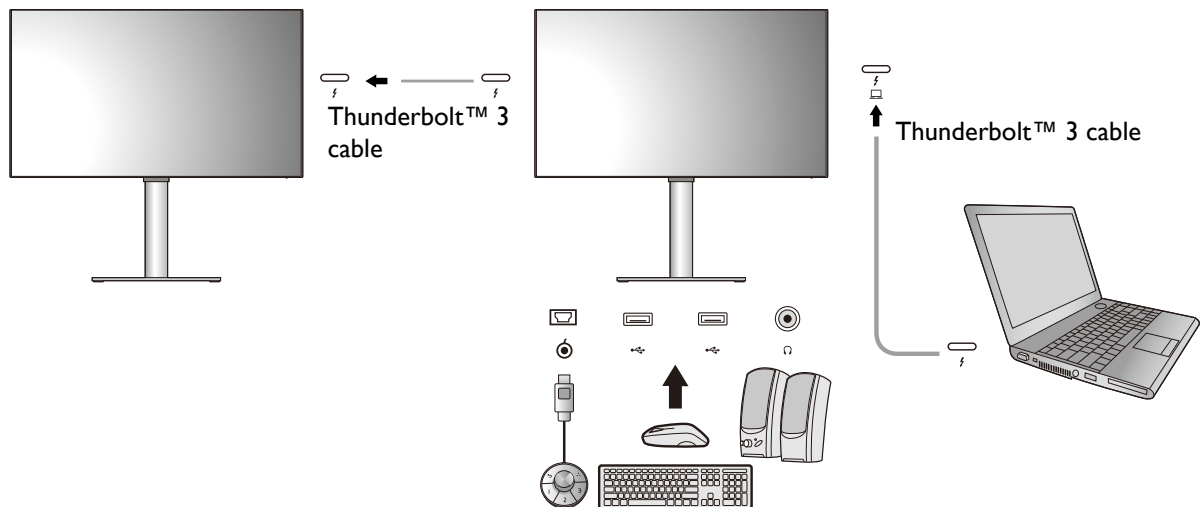

1. Connect your laptop to the Thunderbolt™ 3 port () on the monitor using a Thunderbolt™ 3 cable. This port supplies power to the laptop.
2. Connect the second monitor to the first one using a Thunderbolt™ 3 cable as illustrated.
3. Power on the laptop and the monitors.
4. On your laptop, decide the way you want the content to be displayed on the connected monitors: **Duplicate**, **Extend**, or **Projector only**. Additional software (purchased separately) may be used to manage the display. Refer to the manual of the purchased software for more information.

Supported resolution

To perform Thunderbolt™ 3 daisy chaining, a limited number of connected monitors is required to ensure image quality. The following information shows the image resolution available to each monitor.

	1 st monitor	2 nd monitor
Supported resolution	3840 x 2160 (60Hz)	3840 x 2160 (60Hz)
	3840 x 2160 (60Hz)	2560 x 1440 (60Hz)
	2560 x 1440 (60Hz)	2560 x 1440 (60Hz)
	2560 x 1440 (60Hz)	1920 x 1080 (60 Hz)



The signal output from a laptop to your monitor is always 3840 x 2160. If multiple monitors are connected, you can adjust each monitor's resolution from the operating system of your laptop.



Please also be noted that the supported number of devices for connection may vary by graphic card. To find out the capability of your graphic card, check its specifications or contact its manufacturer.

Working with HDR technology



- Your monitor supports HDR10 technology.
- The information regarding HDR-compatible devices and content in this document is most up-to-date at the time of publication. For the latest information, contact your device manufacturer and content provider.

To enable HDR function, you need to have a compatible player and content.

1. Make sure a FHD/4K HDR player is ready. Players with the following names and resolutions are supported. Note that the 4K content on a FHD monitor get resized and is displayed at 1920 x 1080.

Commonly used names for FHD/4K (may vary by manufacturer)	FHD, 4K, 4K Ultra HD, UHD, UHD 4K, Ultra HD, 2160p
Commonly used names for HDR10 (may vary by manufacturer)	HDR Premium, High Dynamic Range, HDR, Ultra HD Premium

2. Make sure HDR content is available. Content may come from 4K UHD (Blue-Ray) or new HDR games on Xbox One S and PS4 Pro.
3. Make sure the player and the monitor have been connected via an appropriate cable:
 - the provided HDMI / DP / DP to mini DP cable / USB-C™ cable / Thunderbolt™ 3 cable (if available)
 - an HDMI cable that is HDMI High Speed or HDMI Premium certified
 - a DP / DP to mini DP cable that is DisplayPort compliance certified
 - a certified USB-C™ cable

Enabling HDR function

PD2720U / PD3220U

If the instructions in [Working with HDR technology on page 50](#) are followed and the input content is HDR-compatible, the OSD message **HDR: On** is displayed on the screen. This means your content player and content are HDR-compatible and the HDR function is properly enabled. The monitor is following the ST2084 standard to process the HDR content.

If the connection is complete and no OSD message is displayed, follow the instructions to enable HDR-emulated mode.

1. Press the 5-way controller to bring up the hotkey menu, and select  (**Menu**) to access the main menu.
2. Go to **Color** and **Color Mode**.
3. Select **HDR**. An OSD message **HDR: Emulated** is displayed. This means the input content is not HDR-compatible and the monitor is in HDR-emulated mode.



HDR Demo is provided as a comparison between HDR and non-HDR image representation. See [HDR Demo options and HDR function availability \(PD2720U / PD3220U only\) on page 73](#) for more information.

PD3420Q

If the instructions in [Working with HDR technology on page 50](#) are followed and the input content is HDR-compatible, the OSD message **HDR: On** is displayed on the screen. This means your content player and the content are HDR-compatible and the HDR function is properly enabled. The monitor is following the ST2084 standard to process the HDR content.

If the connection is complete and no OSD message is displayed, this means the content player and/or the content are not HDR-compatible. The monitor stays to the color mode recently chosen for non-HDR content.

Working with two color settings on the same image (DualView)

DualView helps improve your image editing efficiency by showing an image of two different color modes side-by-side.

1. Select one color mode from **Color > Color Mode**.
2. Go to **Color > DualView**. The screen is divided into two windows and the selected color mode is applied to the left window.

3. A list of available color modes for the right window is displayed. Select one to apply the setting.

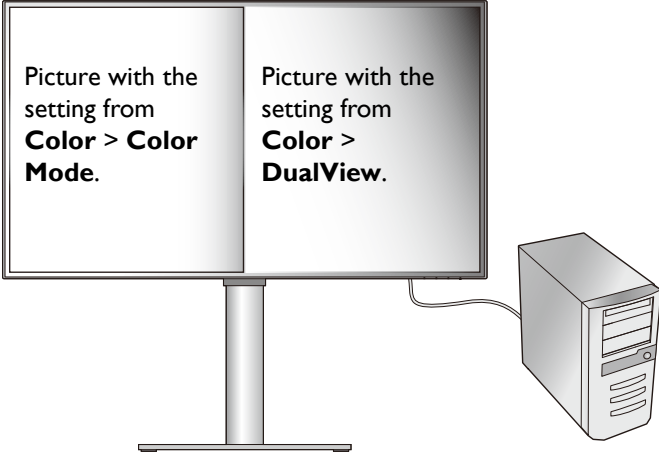

Navigating the main menu

You can use the OSD (On Screen Display) menu to adjust all the settings on your monitor.

Press the 5-way controller to bring up the hot key menu, and press  (**Menu**) to access the main menu. See [5-way controller and basic menu operations on page 40](#) for details.

Available menu options may vary depending on the input sources, functions and settings. Menu options that are not available will become grayed out. And keys that are not available will be disabled and the corresponding OSD icons will disappear. For models without certain functions, their settings and related items will not appear on the menu.



The OSD menu languages may differ from the product supplied to your region, see [Language on page 70](#) under **System** and **OSD Settings** for more details.









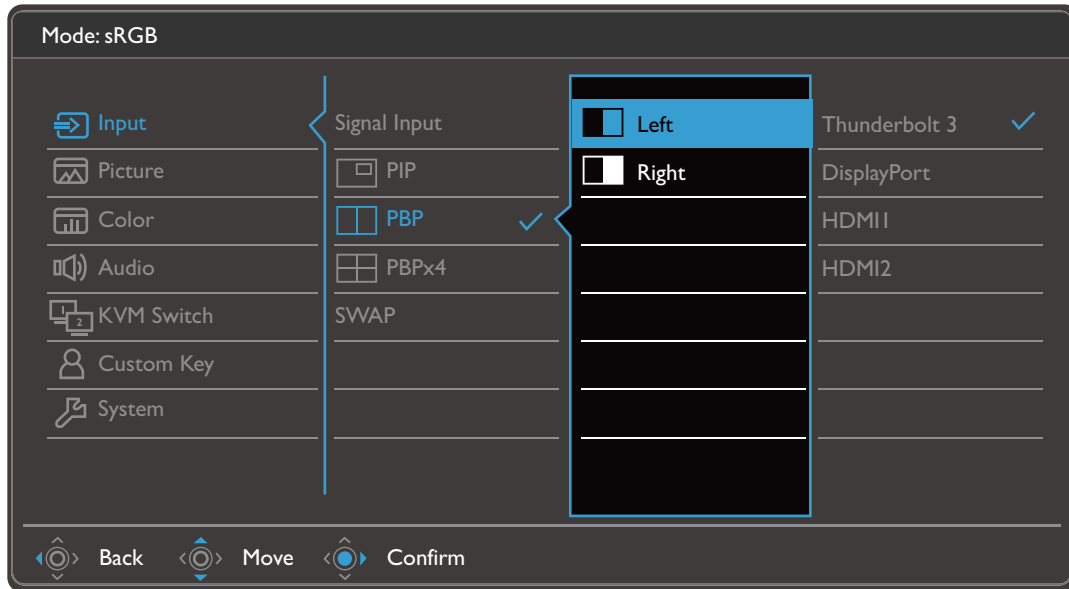

For more information on each menu, please refer to the following pages:

- [Input menu on page 54](#)
- [Picture menu on page 57](#)
- [Color menu on page 59](#)
- [Audio menu on page 64](#)
- [KVM Switch menu on page 65](#)
- [Custom Key menu on page 67](#)
- [System menu on page 69](#)





Input menu

Available menu options may vary depending on the input sources, functions and settings. Menu options that are not available will become grayed out. And keys that are not available will be disabled and the corresponding OSD icons will disappear. For models without certain functions, their settings and related items will not appear on the menu.



1. Select  (**Menu**) from the hot key menu.
2. Use  or  to select **Input**.
3. Select  to go to a sub menu, and then use  or  to select a menu item.
4. Use  or  to make adjustments, or use  to make selection.
5. To return to the previous menu, select .
6. To exit the menu, select .

Item	Function	Range
Signal Input	<p>Use this to change the input to that appropriate to your video cable connection type.</p> <p> Manual selection of signal input will disable the source switch function of KVM Switch. If you prefer to use KVM Switch after manual source selection here, be sure follow the instructions in Setting up the second video source for KVM Switch before use on page 46 again to set properly.</p>	<p>(PD2720U / PD3220U)</p> <ul style="list-style-type: none"> •Thunderbolt 3 •DisplayPort •HDMI1 •HDMI2 <p>(PD3420Q)</p> <ul style="list-style-type: none"> •USB-C •DisplayPort •HDMI1 •HDMI2









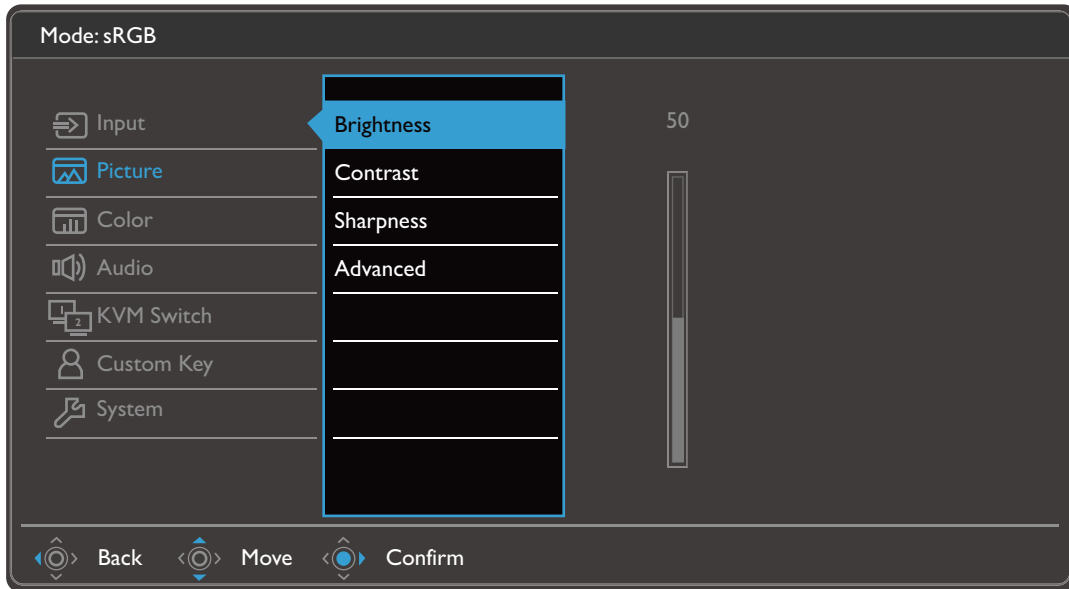

Item	Function	Range
PIP	<p>Sets the PIP mode. Pictures from two independent video sources are displayed on the screen at the same time.</p> <p> The audio input is from the main source if the PIP mode is activated.</p> <p> Not available when HDR function is enabled.</p>	
	<p>Main Determines the main video source.</p>	<ul style="list-style-type: none"> •Thunderbolt 3 •DisplayPort •HDMI1 •HDMI2
	<p>Sub Determines the second video source for PIP mode.</p>	<ul style="list-style-type: none"> •Thunderbolt 3 •DisplayPort •HDMI1 •HDMI2
	<p>PIP Size Determines the size of the inset window in the PIP mode.</p>	<ul style="list-style-type: none"> •Small •Medium •Large
	<p>PIP Position Adjusts the position of the inset window in the PIP mode.</p>	<ul style="list-style-type: none"> •Top Right •Top Left •Bottom Right •Bottom Left
PBP	<p>Sets the PBP mode to have two pictures displayed side-by-side. Determines the video sources for the left and the right windows respectively.</p> <p> Not available when HDR function is enabled.</p>	<ul style="list-style-type: none"> •Left •Right
PBP 5:9 (PD3420Q only)	<p>Sets the PBP mode to have one picture in 16:9 and the other in 5:9 displayed side-by-side. Determines the video sources for the left and the right windows respectively. If you work with one computer only and wish to enable PBP 5:9, make sure your computer supports two independent video outputs.</p> <p> Not available when HDR function is enabled.</p>	<ul style="list-style-type: none"> •Left (16:9) •Right (5:9)

Item	Function	Range
PBPx4	<p>Sets the PBP mode to have four pictures displayed side-by-side. Determines the video sources for four windows respectively.</p> <p> Not available when HDR function is enabled.</p>	<ul style="list-style-type: none"> •Top Left •Top Right •Bottom Left •Bottom Right
SWAP	<p>Swaps the video screens.</p> <ul style="list-style-type: none"> •For PIP / PBP / PBP 5:9 mode: the main and the sub sources will be switched. •For PBPx4 mode: the sources will be switched clockwise. 	



Picture menu

Available menu options may vary depending on the input sources, functions and settings. Menu options that are not available will become grayed out. And keys that are not available will be disabled and the corresponding OSD icons will disappear. For models without certain functions, their settings and related items will not appear on the menu.



1. Select  (**Menu**) from the hot key menu.
2. Use  or  to select **Picture**.
3. Select  to go to a sub menu, and then use  or  to select a menu item.
4. Use  or  to make adjustments, or use  to make selection.
5. To return to the previous menu, select .
6. To exit the menu, select .









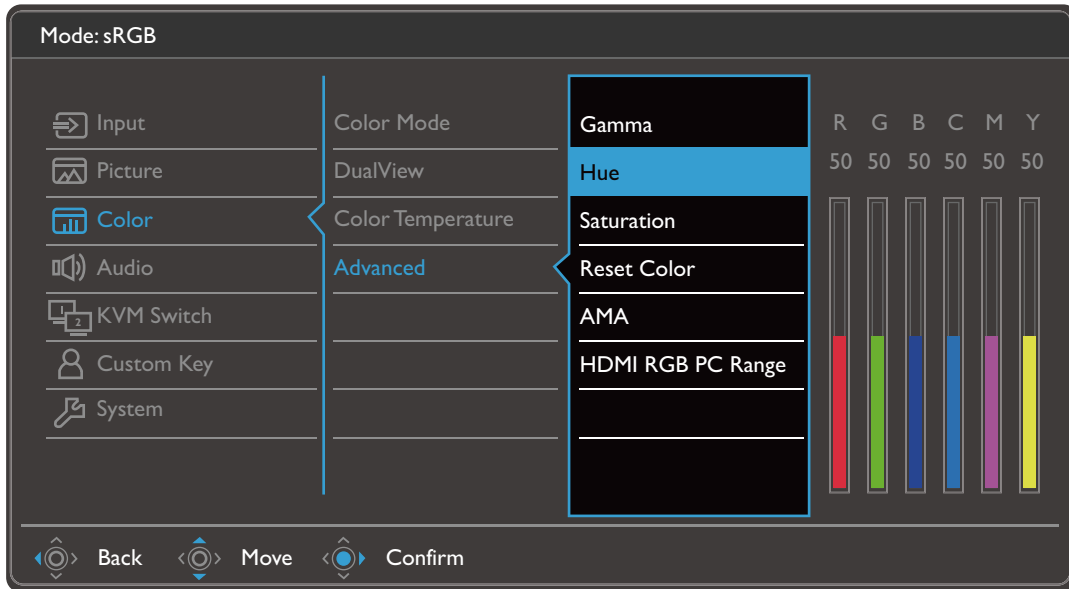

Item	Function		Range
Brightness	Adjusts the balance between light and dark shades.		0 to 100
Contrast	Adjusts the degree of difference between darkness and lightness.		0 to 100
Sharpness	Adjusts the clarity and visibility of the edges of the subjects in the image.		1 to 10
Advanced	Dynamic Contrast	The function is to automatically detect the distribution of an input visual signal, and then to create the optimal contrast.	(PD2720U / PD3220U) 0 to 5 (PD3420Q) • Auto • OFF

Item	Function		Range	
	Display Mode	<p>This feature is provided to allow aspect ratios other than 16:9 or 21:9 (depending on the purchased model) to be displayed without geometric distortion.</p> <p> The options under Display Mode will be different depending on the input signal sources.</p> <p> Depending on your selection of Color Mode, different Display Mode option is pre-set. Change the setting if needed.</p>		
		Full	Ideal for 16:9 or 21:9 (depending on the purchased model) aspect images.	
		I: I	Displays the input image in its native resolution without scaling.	
	Overscan	<p>Slightly enlarges the input image. Use this feature to hide annoying edge noise if present around your image.</p> <p> Available only when the input source is HDMI.</p>	<ul style="list-style-type: none"> • ON • OFF 	



Color menu



Available menu options may vary depending on the input sources, functions and settings. Menu options that are not available will become grayed out. And keys that are not available will be disabled and the corresponding OSD icons will disappear. For models without certain functions, their settings and related items will not appear on the menu.



1. Select  (**Menu**) from the hot key menu.
2. Use  or  to select **Color**.
3. Select  to go to a sub menu, and then use  or  to select a menu item.
4. Use  or  to make adjustments, or use  to make selection.
5. To return to the previous menu, select .
6. To exit the menu, select .

Item	Function		Range
Color Mode	Select a color mode that best suits the type of images shown on the screen.		
	DCI-P3	For better color matching representation with Standard DCI-P3.	
	Display P3	For better color matching representation with Standard Display-P3.	

Item	Function		Range
	HDR	For better color matching representation with High Dynamic Range (HDR) technology.  Not available when PIP / PBP mode is enabled.  (PD3420Q) Available only when the HDR content is detected.	
	sRGB	For better color matching representation with the peripheral devices, such as printers, digital cameras, etc.	
	Adobe RGB (PD2720U only)	For better color matching representation with Adobe® RGB compatible peripherals.	
	Rec. 709	For better color matching representation with Standard Rec. 709.	
	CAD / CAM	Enhances the contrast if a CAD / CAM software is used.	
	Animation	Enhances the contrast of the dark shades so you could work on the details easily when making an animation.	0 ~ 10
	Low Blue Light	Decreases the blue light emitted from the display to reduce the risk of blue light exposure to your eyes.  The value for each Low Blue Light mode indicates how much blue light is decreased compared with the Standard mode.	
	Multimedia	For viewing multimedia files.	
	Web Surfing	For web surfing.	
	Office	For office works or office environment.	
	Reading	For reading e-books or documents.	
	Darkroom	For image editing and viewing in a post-processing environment with a dim light. This mode enhances the sharpness and clarity of shades and shows more details.	
	M-book	Minimizes the visual differences between the monitor and the connected MacBook series product.	

Item	Function		Range
	DICOM	For viewing DICOM images. It is recommended for displaying medical images.  DICOM as the abbreviation of Digital Imaging and Communications in Medicine is a standard for handling, storing, printing, and transmitting medical images.	
	User	Applies a combination of picture settings defined by users.	
DualView	Displays the preview of screen images under the selected modes. Once enabled, the screen will be divided into two windows; the left window demonstrates the image under the mode selected from Color Mode , while the right window presents the image under the mode specified here.  Not available when HDR function is enabled.		<ul style="list-style-type: none"> • OFF • DCI-P3 • Display P3 • sRGB • Adobe RGB (PD2720U only) • Rec. 709 • CAD / CAM • Animation • Low Blue Light • Darkroom • M-book • DICOM • User
Color Temperature	6500K	Allows video and still photographs to be viewed with natural coloring. This is the factory default color.	
	9300K	Applies a cool tint to the image and is factory pre-set to the PC industry standard white color.	
	5000K	Applies a warm tint to the image and is factory pre-set to the news print standard white color.	
	User Define	The blend of the Red, Green and Blue primary colors can be altered to change the color tint of the image. Go to the succeeding R (red), G (green), and B (blue) menus to change the settings. Decreasing one or more of the colors will reduce their respective influence on the color tint of the image. (e.g. if you reduce the Blue level the image will gradually take on a yellowish tint. If you reduce Green, the image will become a magenta tint.)	<ul style="list-style-type: none"> • R (0~100) • G (0~100) • B (0~100)









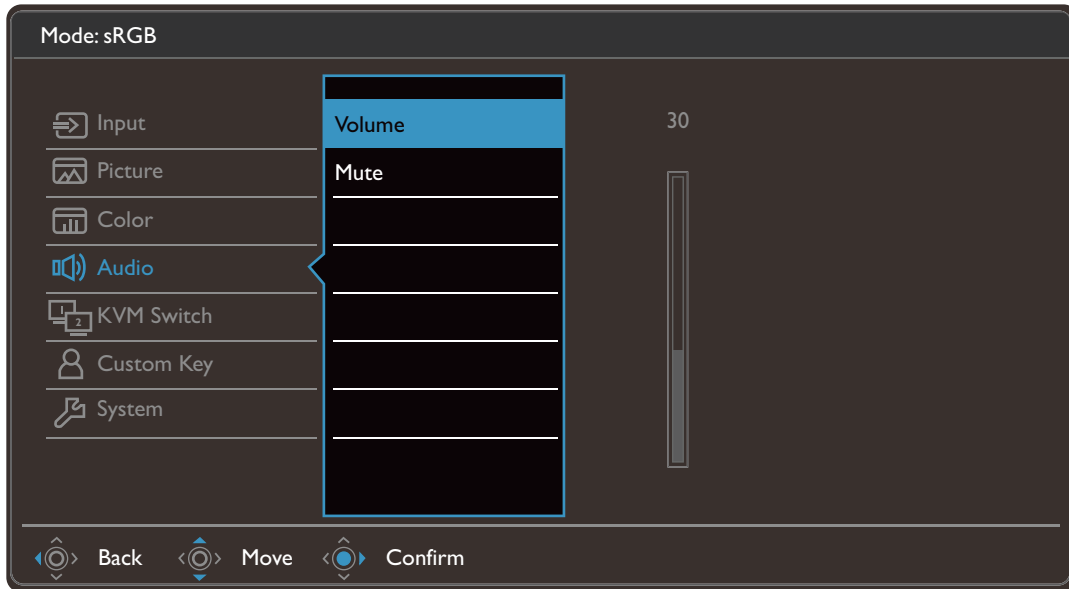

Item	Function		Range	
Advanced	Gamma	Adjusts the tone luminance. The default value is 2.2 (the standard value for Windows).	<ul style="list-style-type: none"> • 1.8 • 2.0 • 2.2 • 2.4 • 2.6 • sRGB (PD3420Q only) 	
	Color Gamut (PD3420Q only)	sRGB	Suitable for sRGB compatible peripherals.	
		DCI-P3	For better color matching representation with Standard DCI-P3.	
		Rec. 709	For better color matching representation with Standard Rec. 709.	
		Native	For better color matching representation with the native color gamut.	
	Hue	Adjusts the degree of how we perceive colors.	<ul style="list-style-type: none"> • R (0~100) • G (0~100) • B (0~100) • C (0~100) • M (0~100) • Y (0~100) 	
	Saturation	Adjusts the purity degree of colors.	<ul style="list-style-type: none"> • R (0~100) • G (0~100) • B (0~100) • C (0~100) • M (0~100) • Y (0~100) 	
Reset Color	Resets the custom color settings to the factory defaults.	<ul style="list-style-type: none"> • YES • NO 		
AMA	Improves the gray level response time of the LCD panel.	<ul style="list-style-type: none"> • OFF • High • Premium 		

Item	Function		Range
	HDMI RGB PC Range (PD2720U / PD3220U only)	Determines the range of color scales. Select an option that matches the RGB range setting on the connected HDMI device.	<ul style="list-style-type: none"> • Auto • Full (0 ~ 255) • Limited (16 ~ 235)
	RGB Range (PD3420Q only)	Determines the range of color scales. Select an option that matches the RGB range setting on the connected device.	<ul style="list-style-type: none"> • Auto • Full • Limited
	Uniformity (PD3420Q only)	If activated, this function compensates the variation in brightness across the display area so the whole display area looks uniform in brightness. However, if high contrast and brightness are desired, please turn off this function.	<ul style="list-style-type: none"> • ON • OFF

Audio menu

Available menu options may vary depending on the input sources, functions and settings. Menu options that are not available will become grayed out. And keys that are not available will be disabled and the corresponding OSD icons will disappear. For models without certain functions, their settings and related items will not appear on the menu.











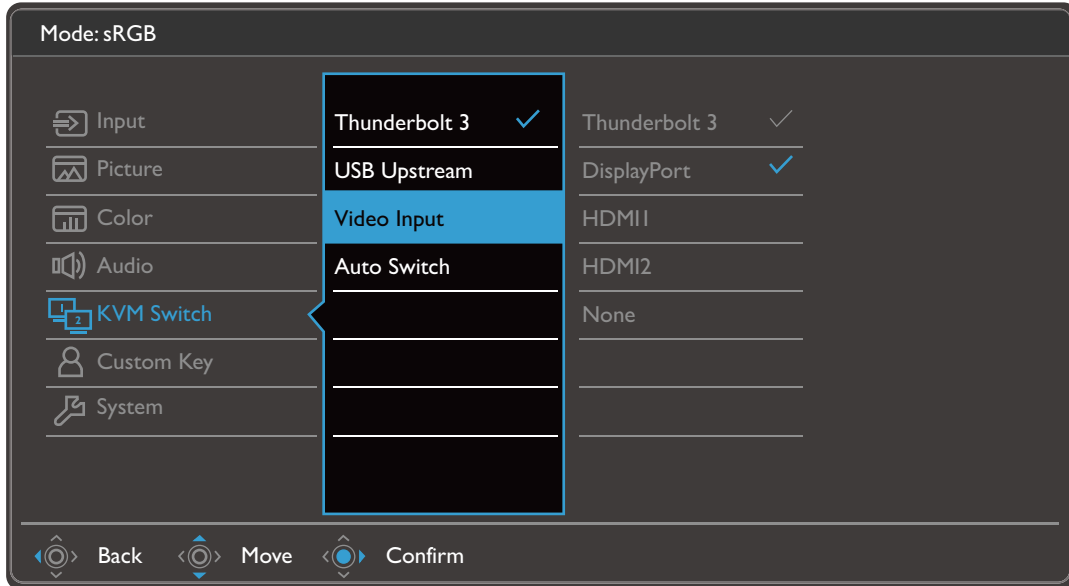



1. Select  (**Menu**) from the hot key menu.
2. Use  or  to select **Audio**.
3. Select  to go to a sub menu, and then use  or  to select a menu item.
4. Use  or  to make adjustments, or use  to make selection.
5. To return to the previous menu, select .
6. To exit the menu, select .

Item	Function	Range
Volume	Adjusts the audio volume.	0 ~ 100
Mute	Mutes the audio input.	<ul style="list-style-type: none"> • ON • OFF

KVM Switch menu

Available menu options may vary depending on the input sources, functions and settings. Menu options that are not available will become grayed out. And keys that are not available will be disabled and the corresponding OSD icons will disappear. For models without certain functions, their settings and related items will not appear on the menu.



1. Select  (**Menu**) from the hot key menu.
2. Use  or  to select **KVM Switch**.
3. Select  to go to a sub menu, and then use  or  to select a menu item.
4. Use  or  to make adjustments, or use  to make selection.
5. To return to the previous menu, select .
6. To exit the menu, select .









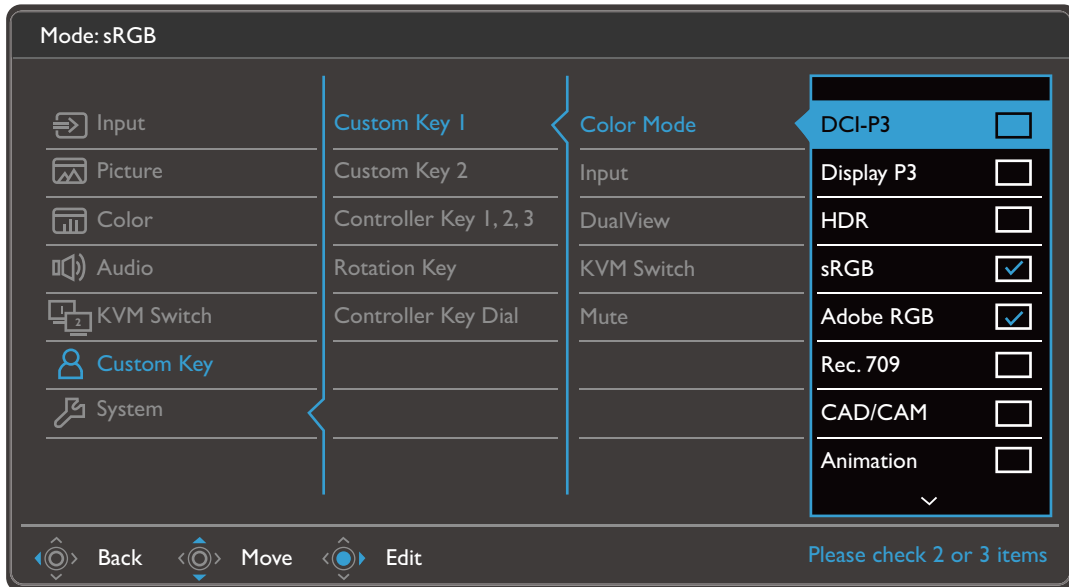

Item	Function	Range
Thunderbolt 3 (PD2720U / PD3220U)	Switches the keyboard and mouse control over the input source / display connected to the Thunderbolt™ 3 port.	
USB-C (PD3420Q only)	Switches the keyboard and mouse control over the input source / display connected to the USB-C™ port.	
USB Upstream	Switches the keyboard and mouse control over the input source / display connected to the USB Upstream port. The video input that goes with this USB Upstream port has to be pre-defined. See Setting up the second video source for KVM Switch before use on page 46 .	

Item	Function	Range
Video Input	<p>Presets a video input to go with the USB Upstream port. See Setting up the second video source for KVM Switch before use on page 46.</p> <p> If None is selected from KVM Switch > Video Input for Scenario A: Working with two computers and one monitor on page 47 and USB Upstream is selected for KVM Switch, the screen does not display anything from the second source as there is none. You cannot control the current display (from Thunderbolt™ 3 or USB-C™, depending on your purchased model) either as the keyboard and mouse control has been switched away. In this case, select a video input manually from Input > Signal Input.</p>	<ul style="list-style-type: none"> • DisplayPort • HDMI I • HDMI2 • None
Auto Switch	<p>Once enabled, if USB or Thunderbolt™ 3 (PD2720U / PD3220U) / USB-C™ (PD3420Q) cable is disconnected, the USB input source and the control will be switched to the other computer automatically.</p>	<ul style="list-style-type: none"> • ON • OFF

Custom Key menu

Available menu options may vary depending on the input sources, functions and settings. Menu options that are not available will become grayed out. And keys that are not available will be disabled and the corresponding OSD icons will disappear. For models without certain functions, their settings and related items will not appear on the menu.



1. Select  (**Menu**) from the hot key menu.
2. Use  or  to select **Custom Key**.
3. Select  to go to a sub menu, and then use  or  to select a menu item.
4. Use  or  to make adjustments, or use  to make selection.
5. To return to the previous menu, select .
6. To exit the menu, select .









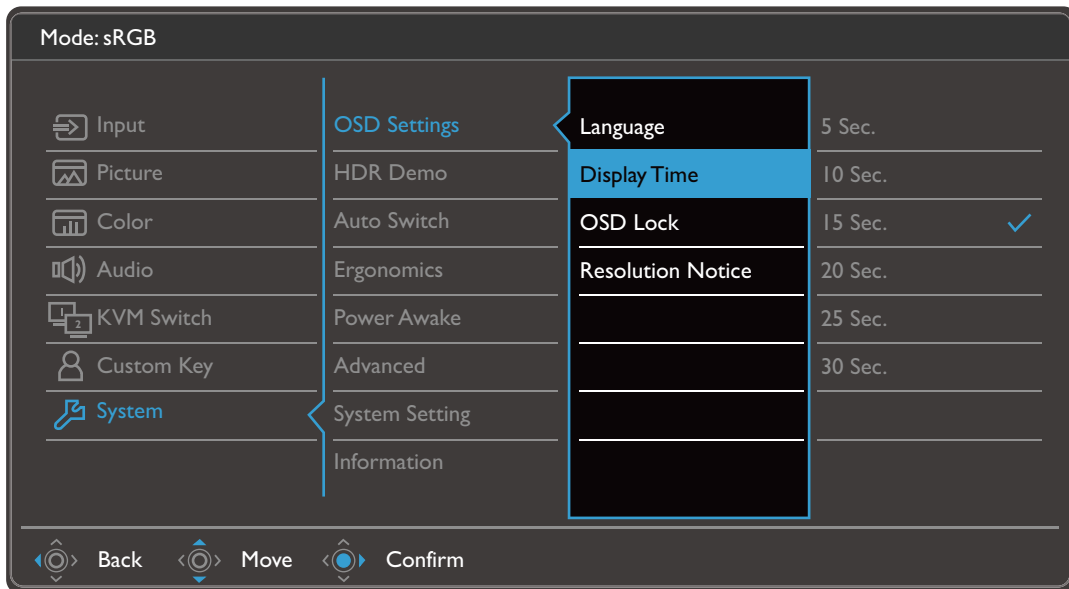

Item	Function	Range
Custom Key 1	Sets the function to be accessed by custom key 1. Select a category first, and choose up to 3 options to be accessed by this key.	<ul style="list-style-type: none"> • Color Mode • Input • DualView • KVM Switch • Mute
Custom Key 2	Sets the function to be accessed by custom key 2. Select a category first, and choose up to 3 options to be accessed by this key.	



Item	Function	Range
Controller Key 1, 2, 3	Sets the function to be accessed by controller key 1 / 2 / 3 on Hotkey Puck G2. See Hotkey Puck G2 and its basic operations on page 44 for the location of the keys. Select a category first, and choose up to 3 options to be accessed by these keys. The numbers displayed next to the selected items are the controller keys that the options are designated to.	<ul style="list-style-type: none"> • Color Mode • Input • DualView • KVM Switch
Rotation Key	Sets the function to be accessed by the Rotation key on Hotkey Puck G2. See Hotkey Puck G2 and its basic operations on page 44 for the location of the key. Select a category first, and choose up to 3 options to be accessed by this key.	<ul style="list-style-type: none"> • Color Mode • Input • DualView • KVM Switch • Mute
Controller Key Dial	Sets the function to be accessed by the Dial key on Hotkey Puck G2. See Hotkey Puck G2 and its basic operations on page 44 for the location of the key.	<ul style="list-style-type: none"> • Brightness • Contrast • Volume



System menu

Available menu options may vary depending on the input sources, functions and settings. Menu options that are not available will become grayed out. And keys that are not available will be disabled and the corresponding OSD icons will disappear. For models without certain functions, their settings and related items will not appear on the menu.





1. Select  (**Menu**) from the hot key menu.
2. Use  or  to select **System**.
3. Select  to go to a sub menu, and then use  or  to select a menu item.
4. Use  or  to make adjustments, or use  to make selection.
5. To return to the previous menu, select .
6. To exit the menu, select .

Item	Function		Range
OSD Settings	Language	Sets the OSD menu language.  The language options displayed on your OSD may differ from those shown on the right, depending on the product supplied in your region.	<ul style="list-style-type: none"> • English • Français • Deutsch • Italiano • Español • Polski • Česky • Magyar • Română • Nederlands • Русский • Svenska • Português • العربية • 日本語 • 한국어 • 繁體中文 • 简体中文
	Display Time	Adjusts the display time of the OSD menu.	<ul style="list-style-type: none"> • 5 sec. • 10 sec. • 15 sec. • 20 sec. • 25 sec. • 30 sec.
	OSD Lock	Prevents all the monitor settings from being accidentally changed. When this function is activated, the OSD controls and hotkey operations will be disabled.  To unlock the OSD controls, press and hold any key for 10 seconds.	
	Resolution Notice	Sets whether to display the resolution notice of the recommended resolution when a new input source is detected by the monitor.	<ul style="list-style-type: none"> • ON • OFF

Item	Function	Range	
HDR Demo (PD2720U / PD3220U only)	(Works only if the input content is HDR-compatible) When the function is activated, all color modes are available for a comparison between HDR and non-HDR image representation. See HDR Demo options and HDR function availability (PD2720U / PD3220U only) on page 73 for more information.  If this function is activated and a non-HDR mode is selected, the input HDR content may be represented inappropriately.	<ul style="list-style-type: none"> • ON • OFF 	
Auto Switch	Once enabled, the specific port will be in the input auto select loop. Otherwise, it can only be selected by input select or by hot key.  Available only when KVM Switch > Video Input is set to None .	<ul style="list-style-type: none"> • DP Auto Switch • HDMI Auto Switch 	
Ergonomics	Smart Reminder	Decides to display the pop-up message that reminds you to rest your eyes.	<ul style="list-style-type: none"> • ON • OFF
	Time Interval (min.)	Sets the interval of the reminder message.	<ul style="list-style-type: none"> • 20 • 40 • 60 • 80 • 100
	Duration (sec.)	Sets the time the reminder message lasts on the screen.	<ul style="list-style-type: none"> • 5 • 10 • 15 • 20 • 25
Power Awake (PD2720U / PD3220U only)	If this function is disabled, the Thunderbolt™ 3 / USB ports are not supplied with power while the monitor is in standby mode. To keep supplying power to the Thunderbolt™ 3 / USB ports in monitor's standby mode, change the setting to ON .	<ul style="list-style-type: none"> • Thunderbolt 3 • USB 	
USB-C Configuration (PD3420Q only)	Sets the refresh rate of the input video via USB-C™ port. The USB transmission speed changes accordingly due to USB-C™ technology limitation. See Options for data transfer via USB-C™ (PD3420Q only) on page 73 for more information.	<ul style="list-style-type: none"> • USB 3.1 Gen I • USB 2.0 	
USB-C Awake (PD3420Q only)	If this function is disabled, the USB-C™ port is not supplied with power while the monitor is in standby mode. To keep supplying power to the USB-C™ port in monitor's standby mode, change the setting to ON .	<ul style="list-style-type: none"> • ON • OFF 	

Item	Function		Range
Advanced	DDC/CI	<p>Allows the monitor settings to be set through the software on the PC.</p>  <p>DDC/CI, short for Display Data Channel/Command Interface, which was developed by Video Electronics Standards Association (VESA). DDC/CI capability allows monitor controls to be sent via the software for remote diagnostics.</p>	<ul style="list-style-type: none"> • ON • OFF
	Auto Power Off	Sets the time to power off the monitor automatically in power saving mode.	<ul style="list-style-type: none"> • OFF • 10 min • 20 min • 30 min
	DisplayPort	Selects an appropriate DP standard for data transmission.	<p>(PD2720U / PD3220U)</p> <ul style="list-style-type: none"> • 1.1 • 1.2 • 1.4 <p>(PD3420Q)</p> <ul style="list-style-type: none"> • 1.1 • 1.4
	OSD Key Bri.	Adjusts the brightness of the power key's LED indicator.	<p>(PD2720U / PD3220U)</p> <ul style="list-style-type: none"> • 1 • 2 • 3 <p>(PD3420Q)</p> <ul style="list-style-type: none"> • ON • OFF
System Setting	Shows the current monitor property settings.		<ul style="list-style-type: none"> • Input • Timing • Brightness • Contrast • Color Gamut • Pixel Encoding • Color Depth • RGB Range

Item	Function	Range
Burn-in Cleaner (PD3420Q)	<p>Screen burn-in or image retention may be found on the screen if a still image is displayed for an extended period of time. Enable this function to help reduce the visible fixed lines or shades on the screen by showing several default patterns.</p> <p> Once enabled, to disable this function, press any of the control keys.</p> <p> Screen burn-in occurs due to panel limitation and should not be considered as a manufacturing defect. To avoid screen burn-in, do not play a still image for an extended period of time in the first place. Use your computer's power management function.</p>	<ul style="list-style-type: none"> • YES • NO
Information	Displays the product information.	<ul style="list-style-type: none"> • Model Name • SN • Version • Usage Time
Reset All	Resets all mode, color and geometry settings to the factory default values.	<ul style="list-style-type: none"> • YES • NO

HDR Demo options and HDR function availability (PD2720U / PD3220U only)

HDR Demo option	Video input	Availability of HDR function	OSD message
OFF	HDR content	Switches to HDR mode automatically. Non-HDR color modes are not available.	HDR: On
OFF (grayed out)	Non-HDR content	Emulated HDR function if HDR mode is selected under Color > Color Mode .	HDR: Emulated
ON	HDR content	Switches to HDR mode automatically. Non-HDR color modes are available.	HDR: On















Options for data transfer via USB-C™ (PD3420Q only)

PD3420Q	3440 × 1440 + USB 2.0	3440 × 1440 + USB 3.1
Refresh rate	60 Hz	60 Hz
Bits	10 bits	8 bits
USB transmission speed	480 Mbps	5 Gbps

Troubleshooting

Frequently asked questions (FAQ)

Imaging

-  The image is blurred.
-  Read the instructions on the link "**Adjusting the Screen Resolution**" on the CD, and then select the correct resolution, refresh rate and make adjustments based on these instructions.
-  Does the blurring only occur at resolutions lower than the native (maximum) resolution?
-  Read the instructions on the link "**Adjusting the Screen Resolution**" on the CD. Select the native resolution.
-  Pixel errors can be seen.
- One of several pixels is permanently black, one or more pixels are permanently white, one or more pixels are permanently red, green, blue or another color.
- 
 - Clean the LCD screen.
 - Cycle power on-off.
 - These are pixels that are permanently on or off and is a natural defect that occurs in LCD technology.
-  The image has a faulty coloration.
-  It has a yellow, blue or pink appearance.
- Go to **Color, Advanced**, and **Reset Color**, and then choose **YES** to reset the color settings to the factory defaults.
- If the image is still not correct and the OSD also has faulty coloration, this means one of the three primary colors is missing in the signal input. Now check the signal cable connectors. If any pin is bent or broken off, please contact your dealer to get necessary support.
-  The image is distorted, flashes or flickers.
-  Read the instructions on the link "**Adjusting the Screen Resolution**" on the CD, and then select the correct resolution, refresh rate and make adjustments based on these instructions.
-  You are running the monitor at its native resolution, but the image is still distorted.
-  Images from different input sources may appear distorted or stretched on the monitor running at its native resolution. To have the optimal display performance of each type of input sources, you can use the **Display Mode** function to set a proper aspect ratio for the input sources. See [Display Mode on page 58](#) for details.
-  The image is displaced in one direction.
-  Read the instructions on the link "**Adjusting the Screen Resolution**" on the CD, and then select the correct resolution, refresh rate and make adjustments based on these instructions.

- ? Faint shadow from the static image displayed is visible on the screen.
- ✓
 - Activate the power management function to let your computer and monitor go into a low power "sleep" mode when not actively in use.
 - Use a screensaver to prevent the occurrence of image retention.

Power LED indicator

- ? The LED indicator is white or orange.
- ✓
 - If the LED lights up in solid white, the monitor is powered on.
 - If the LED is illuminated in white and there is a message **Out of Range** on the screen, this means you are using a display mode that this monitor does not support, please change the setting to one of the supported mode. Please read the "**Preset display modes**" section from the link "**Adjusting the Screen Resolution**".
 - If the LED is illuminated in orange, the power management mode is active. Press any button on the computer keyboard or move the mouse. If that does not help, check the signal cable connectors. If any pin is bent or broken off, please contact your dealer to get necessary support.
 - If the LED is off, check the power supply mains socket, the external power supply and the mains switch.

OSD controls

- ? The OSD controls are inaccessible.
- ✓ To unlock the OSD controls when it is preset to be locked, press and hold any key for 10 seconds.



OSD messages

- ? A message **Out of Range** on the screen during computer boot up process.
- ✓ If there is a message **Out of Range** on the screen during computer boot up process, this means computer compatibility caused by operating system or graphic card. The system will adjust the refresh rate automatically. Just wait until the operating system is launched.



Audio

- ? No sound can be heard from the connected external speakers.
- ✓
 - Remove your headphone (if the headphone is connected to the monitor).
 - Check whether the headphone jack is properly connected.
 - If the external speakers are USB-powered, check whether the USB connection is OK.
 - Increase the volume (volume may be muted or too low) on the external speakers.



Thunderbolt™ 3 connection (models with Thunderbolt™ 3 ports)

-  When single monitor is connected, no video or audio output from the laptop with Thunderbolt™ 3 connection.
-  Check the cable connections and menu settings in the following order.
 - Check if an appropriate cable has been connected to the monitor and the laptop properly. See [Connectivity of Thunderbolt™ 3 port on your monitor \(PD2720U / PD3220U only\) on page 17](#) for more information.
 - Check if the input source has been selected to **Thunderbolt 3** from **Input > Signal Input**.
 - Check if it is either Thunderbolt™ 3 port or USB-C™ port used on the computer for connection. If a USB-C™ port is used, make sure the port supports video signal transmission.

KVM Switch

-  No response after selecting **KVM Switch > USB Upstream**.
-  Check the cable connections and menu settings in the following order.
 - Check if an appropriate cable has been connected to the monitor and the second video source properly. See [Connect the PC video cable. on page 23](#) for more information.
 - Check if the input source has been selected to the second video input from **KVM Switch > Video Input**.

USB-C™ connection (models with USB-C™ ports)

-  No video or audio output from the laptop with USB-C™ connection.
-  Check the cable connections and menu settings in the following order.
 - Check if the USB-C™ cable has been connected to the monitor and the laptop properly. See [Connect the PC video cable. on page 23](#) for more information.
 - Check if the input source has been selected to **USB-C** on **Input > Signal Input**.

Need more help?

If your problems remain after checking this manual, please contact your place of purchase or visit the local website from www.BenQ.com for more support and local customer service.