



Questo manuale d'istruzione è fornito da trovaprezzi.it. Scopri tutte le offerte per [Brother SC-2000USB](#) o cerca il tuo prodotto tra le [migliori offerte di Macchine per Ufficio](#)



Questo manuale d'istruzione è fornito da trovaprezzi.it. Scopri tutte le offerte per [Brother SC-2000USB](#) o cerca il tuo prodotto tra le [migliori offerte di Macchine per Ufficio](#)

Stampcreator PROTM
HIGH QUALITY STAMP SYSTEM

SC-2000USB

STORE OPERATIONS MANUAL

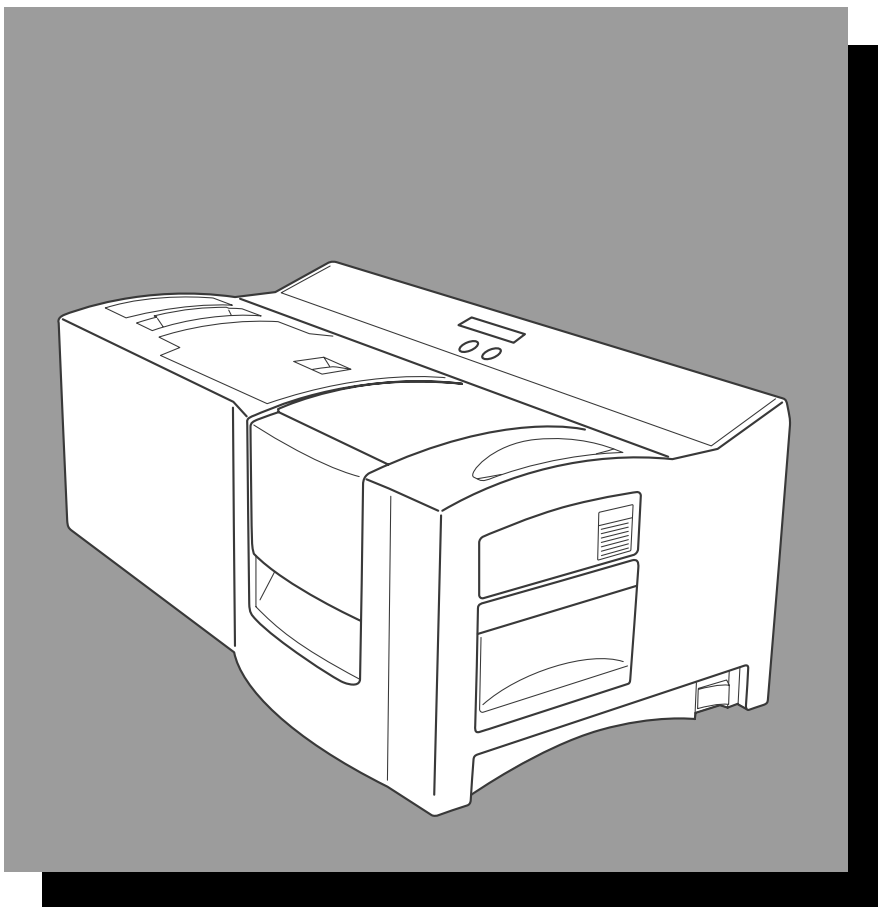

* Be sure to read and understand this guide before using the machine. We recommend that you keep this guide nearby for future reference.

brother[®]

General information

Compilation and Publication Notice

Under the supervision of Brother Industries Ltd., this manual has been compiled and published, covering the latest product's descriptions and specifications.

The contents of this manual and the specifications of this product are subject to change without notice.

Brother reserves the right to make changes without notice in the specifications and materials contained herein and shall not be responsible for any damages (including consequential) caused by reliance on the materials presented, including but not limited to typographical and other errors relating to the publication.

© 2011 Brother Industries Ltd.

Trademarks

The Brother logo is a registered trademark of Brother Industries, Ltd.

Brother is a registered trademark of Brother Industries, Ltd.

© 2011 Brother Industries, Ltd. All rights reserved.

Microsoft, Windows and Windows Vista are registered trademarks of Microsoft Corporation in the United States and other countries.



The names of other software or products used in this document are trademarks or registered trademarks of the respective companies that developed them.

Each company whose software title is mentioned in this manual has a Software License Agreement specific to its proprietary programs.







All other brand and product names mentioned in this manual are registered trademarks of their respective companies.

Safety precautions













Read all of these instructions and save them for later reference. Follow all warnings and instructions marked on the product.

 Warning	Tells you what to do to avoid the risk of injury.
 Caution	Tells you about procedures you must follow to prevent damage to the printer.

The symbols used in this manual are as follows:

	Action NOT allowed to do		DO NOT disassemble the product.
	DO NOT splash the product with or immerse the product in water.		DO NOT touch a given portion of the product.
	Mandatory action		Unplugging
	Alerts to the possibility of electrical shock		









■ To use the machine safely

 Warning	
Follow these guidelines to avoid fire, electric shock, or other damage.	
■ The Printer	
<ul style="list-style-type: none">  Unplug the power cord immediately and stop using the printer during an electrical storm. There may be a remote risk of electric shock from lightning.  Do not touch any metal parts near the print head. The print head becomes very hot during use and remains very hot immediately after use. Do not touch it directly with your hands.  Dispose of plastic bags correctly and keep away from babies and children. Do not wear or play with plastic bags.  Unplug the power cord immediately and stop using the printer if you notice any abnormal odor, heat, discoloration, deformation or anything unusual when the printer is in use or storage.  Do not disassemble the printer. For inspection, adjustment and repair of the printer contact the retail outlet where the printer was purchased or your local authorized service center.  Do not drop, hit or otherwise bang the printer. 	<ul style="list-style-type: none">  Do not allow the printer to get wet in any way.  Do not use the printer with foreign objects in it. If water or any foreign objects should enter the printer, unplug the power cord from the electric outlet and remove the foreign object. If necessary, contact the retail outlet where the printer was purchased or your local authorized service center.  Never look at the flash which may leak from the stamp compartment.  DO NOT put your fingers on the edge of the machine under the ink ribbon compartment cover. Doing this may cause injury.
	

Warning

Follow these guidelines to avoid fire, electric shock, or other damage.

■ Power Cord

-  Use only the authorized power source (120 V AC) for the printer.
-  Use only the power cord included with the printer.
-  Do not handle the power cord or plug if your hands are wet.
-  Do not overload the power outlet socket with too many appliances or insert the power cord into a damaged outlet socket.
-  Do not cut, damage, alter or place heavy objects on the power cord.
-  Do not use the power cord if it is damaged.
-  Ensure the power plug is correctly inserted into the power outlet.
-  If the printer will not be used for an extended period, remove the power supply cord from the electrical outlet.

Caution

Follow these guidelines to avoid fire, electric shock, or other damage.

■ The Printer

-  The standard electrical outlet should be close to the printer and be easily accessible.

■ Power Cord

-  Always hold the power plug when removing the power cord from or inserting it into the outlet. Pulling on the power cord cable could cause problems with the power cord.

■ Installation/Storage

-  Place the printer on a flat, stable surface such as a desk.
-  Do not place any heavy objects on top of the printer.

■ Others



-  Avoid contact of the stamp ink, stamp correction pen, or print head cleaning pen with your mouth, eyes and skin.
-  Keep the stamp correction pen and print head cleaning pen away from flames.

Table of Contents

SET UP

FCC Compliance	2
General Precautions	2
Unpacking	3
Machine Mode Operations	5
Changing the LCD display language	5
Connecting the Interface and Power	
Supply Cables	6
System Requirements	6
Installing the Software	7
Stampcreator P-touch Editor, Stampcreator	
Express and printer driver	7
First Steps	12

DESIGNING A STAMP

Overview	14
Stampcreator P-touch Editor	15
Tools for Formatting	16
Properties Dock	16
Tools	17
Object Dock	18
Formatting a Stamp	19
Selecting the stamp size	19
Typing text	19
Changing the font	19
Changing the character size	20
Changing style effects	20
Changing the font of a text block	20
Changing the character size of a text block	21
Centering text within a block	22
Vertical and horizontal block alignment	22
Drawing lines in a stamp	23
Drawing a frame	24
Changing the frame size	24
Using special design frames	25
Creating stamps with clip art images	26
Creating stamps with pictures	26
Advanced Steps	27
Importing graphics from a scanner, digital	
camera, or other clip art source	27
Making a stamp containing a photo	28
Auto Format	32

Stampcreator Express	33
Formatting a stamp	33
Printing a draft sheet	34
Making an ID label	35
Adding new styles to the Stampcreator	
Express software	36

MAKING A STAMP

Final Steps	38
Getting ready	38
Printing a draft sheet	38
Engraving a stamp	40
Assembling the stamp	42
Making an ID label	43
Applying an ID label	43

CARE & TROUBLESHOOTING

Periodic Maintenance	44
Cleaning the draft sheet rollers	44
Cleaning the ID label rollers	44
Cleaning the Print Heads	45
Replacing the xenon lamp unit	45
Removing a Jam and Correcting a Stamp ...	46
Removing a jammed draft sheet or ID label	
sheet	46
Correcting an imperfect stamp surface	47
Cure time imperfections	47
Refilling the Stamp Ink	48
Easy Reference Trouble Shooting Guide ...	49
Error message list	51

SUPPLIES & ACCESSORIES

Stamp Ordering Information	52
How to order stamps	52
Stamp samples	53
Supply items	55
Maintenance items	56

SUPPORT NUMBERS

FCC Compliance

Federal Communications Commission (FCC) Declaration of Conformity (For USA Only)

Responsible Party: Brother International Corp.
100 Somerset Corporate Blvd.
Bridgewater, NJ 08807-0911
USA
TEL: (908) 704-1700

declares that the product:

Product Name: Brother Stamp Creation System
"Stampcreator Pro"

Model Number: SC-2000USB

complies with Part 15 of the FCC Rules. Operation is subject to the following two conditions: (1) this device may not cause harmful interference, and (2) this device must accept any interference received, including interference that may cause undesired operation.

This equipment has been tested and found to comply with the limits for a Class B digital device, pursuant to Part 15 of the FCC Rules. These limits are designed to provide reasonable protection against harmful interference in a residential installation. This equipment generates, uses, and can radiate radio frequency energy and, if not installed and used in accordance with the instructions, may cause harmful interference to radio communications. However, there is no guarantee that interference will not occur in a particular installation. If this equipment does cause harmful interference to radio or television reception, which can be determined by turning the equipment off and on, the user is encouraged to try to correct the interference by one or more of the following measures.

To correct interference

- Reorient or relocate the receiving antenna.
- Increase the separation between the equipment and receiver.
- Connect the equipment to an outlet on a circuit different from that to which the receiver is connected.
- Consult the dealer or an experienced radio/TV technician for help.
- The enclosed interface cable should be used in order to ensure compliance with the limits for a Class B digital device.
- Changes or modifications not expressly approved by Brother Industries, Ltd. could void the user's authority to operate the equipment.

General Precautions

- Be sure the machine is always placed on a level, stable surface.
- Keep the machine and its accessories out of direct sunlight and extremely dusty places. Dust and dirt can cause distortion to the stamp image.
- Do not expose the machine, or any of its accessories, to extreme temperatures or high humidity.
- Do not try to disassemble the machine or any of its accessories.
- When connecting and disconnecting the cables, always be sure to grab the connectors, not the cords.
- Store the draft sheets, ID labels, and cleaning sheets in their packages.
- Do not use folded or damaged draft sheets, ID labels, or cleaning sheets.
- Do not look directly at the flash from the xenon lamp unit.
- Be careful that the CD ROM is not scratched.
- Do not put heavy objects on the CD ROM.
- Do not touch the printed draft sheet before creating a stamp.
- Do not remove the clear protective film before engraving a stamp.
- Do not reuse the ink pad as ink will have permeated the pad surface.
- Do not stand the stamp upside down immediately after it is assembled.
- Do not place the stamp on its side immediately after it is assembled.
- Do not touch the print heads.
- Do not use cleaning devices other than the print head cleaning pen and cleaning sheets supplied with the Stampcreator Pro.
- Only lift the machine by grabbing the specified areas.
- Make sure that the power requirements specified for this machine are met.
- Do not touch the machine's internal parts since they can become extremely hot after the machine has been used for a long period of time.
- To prevent dust from entering the machine, do not leave the machine for a long period of time with the ink ribbon compartment cover or stamp compartment cover open or the xenon lamp unit or draft sheet magazine tray uninstalled.
- Do not touch any of the machine's internal sensors.

SET UP

Unpacking

SC-2000USB

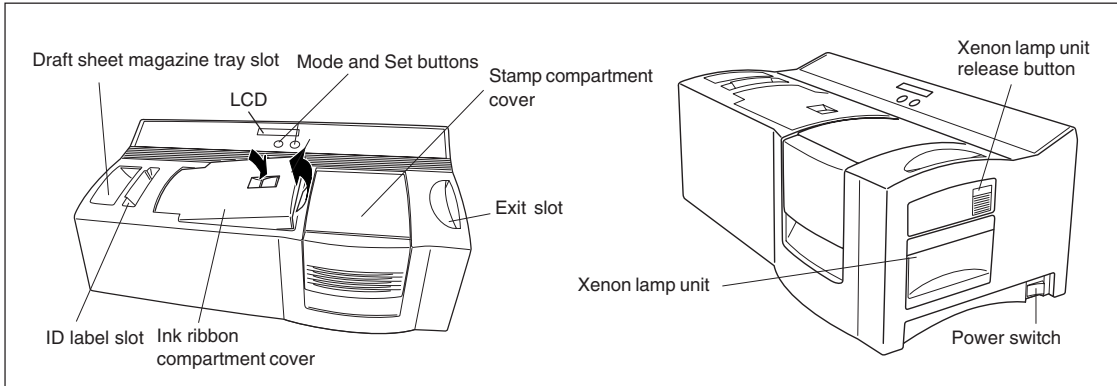

STARTER KIT

Power supply cord (for connecting the SC-2000USB to the AC outlet)

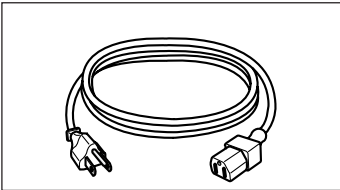

150 draft sheets (for printing the data in order to engrave the stamp)

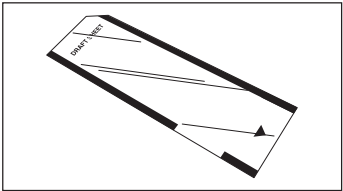

5 stamps with caps
size 1438 (× 2)
size 1850 (× 2)
size 2770 (× 1)

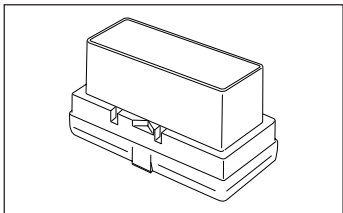

Ink Ribbon Cartridge

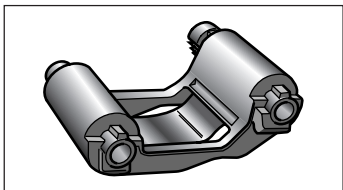

Draft sheet magazine tray (for feeding in the draft sheets)

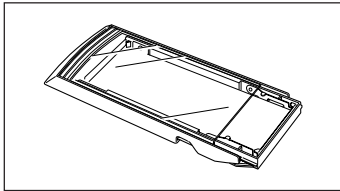

5 stamp skirts

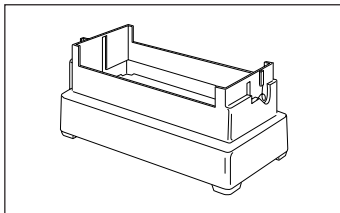

Xenon Lamp Unit

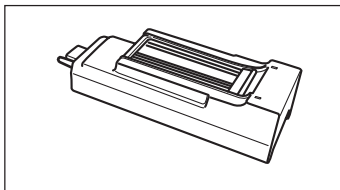

5 ID label sheets (for printing a label that can be attached to each stamp for identification)
size 1438 (× 2)
size 1850 (× 2)
size 2770 (× 1)

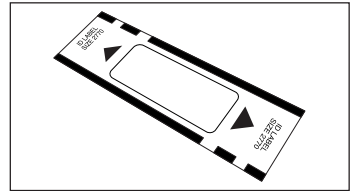

5 grips

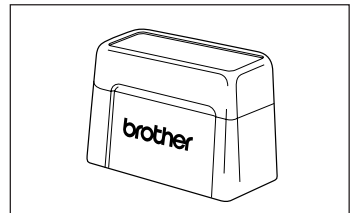

MAINTENANCE KIT

Print head cleaning pen (for cleaning the print head)

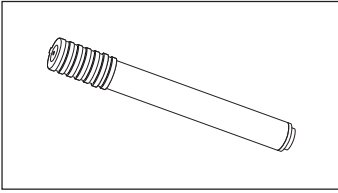

Stamp correction pen (for correcting the engraved stamp)

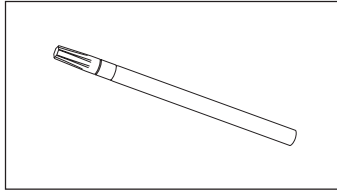

9 cleaning sheets (for cleaning the rollers)

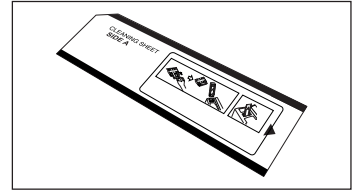

CONNECTING YOUR COMPUTER

CD-ROM containing the computer software and their manuals

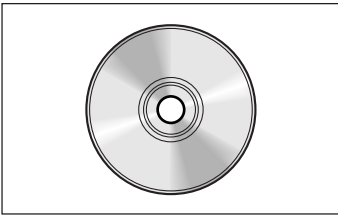

Interface cables (for connecting the SC-2000USB to the computer)

USB interface cable (for the USB port of a computer running Windows® XP/ Windows Vista®/ Windows® 7)

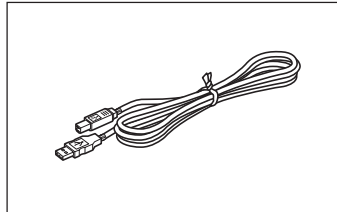

Serial interface cable (for the serial port of a computer running Windows® XP/ Windows Vista®/ Windows® 7)

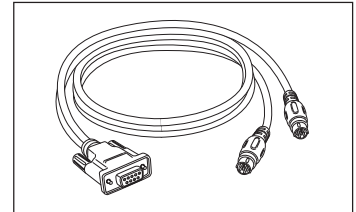

Precautions:

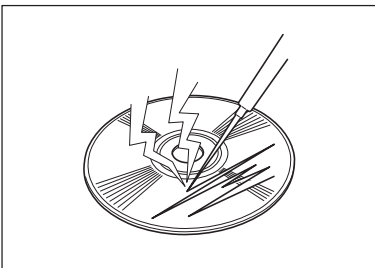

- Be careful that the CD-ROM is not scratched.

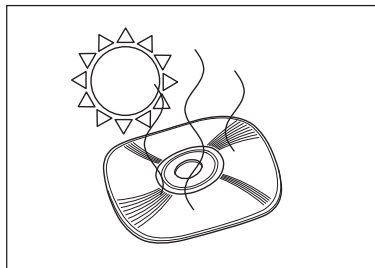

- Do not subject the CD-ROM to extremely high or extremely low temperatures.

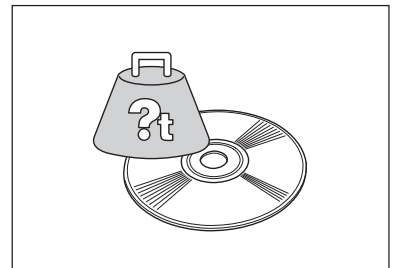

- Do not put heavy objects on the CD-ROM.

Brother Industries, Ltd. and its suppliers possess all rights and copyrights to this software (including, but not limited to, the programming, images, clip art, templates, and text incorporated into the software), the text in the enclosed manuals, and duplicates of the software. This software, either in part or in whole, may not be duplicated, modified, reverse-engineered, disassembled or decompiled without permission.

Machine Mode Operations

The Stampcreator Pro has different modes for performing different operations. Follow the operations described below to select the desired mode.

Initializing the machine

- Turn the machine off, then on again to initialize it. The message “INITIALIZE” appears in the LCD.
- When data has been cleared, the message “READY” appears in the LCD.

Removing the draft sheet and clearing data

- Press the Mode button once until “RESET” appears in the LCD.
- Press the Set button.

Periodic machine cleaning

- Press the Mode button twice until “CLEAN” appears in the LCD, and then insert a cleaning sheet.
- Press the Set button (see page 44).

Resetting the xenon lamp counter

- Reset the counter only after the xenon lamp unit has been replaced with a new one.
- Press the Mode button four times until “RESET COUNTER” appears in the LCD, and then install a new xenon lamp unit.
- Press the Set button (see page 45).

Baud Rate (For serial connection only)

The baud rate of the COM port on the PC must match the baud rate of the Stampcreator machine.

Changing the LCD display language

- 1 While holding down the [Set] button, turn on the SC-2000USB. When “READY” appears in the display, release the [Set] button.

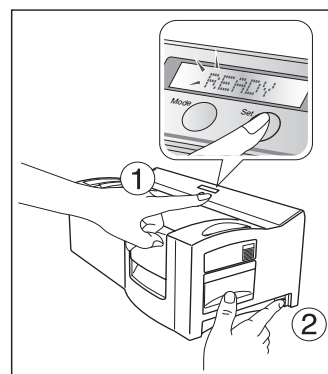

- 2 Press the [MODE] button three times until “LANGUAGE” appears.

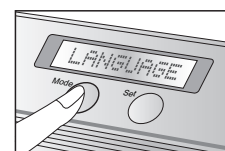

- 3 Press the [Set] button once.
- 4 Press the [MODE] button until the name of the desired language appears.
- 5 Press the [Set] button to apply the setting.
- 6 Turn the SC-2000USB off, then on again.

This completes the setting of the LCD display language.

Connecting the Interface and Power Supply Cables

After connecting the interface and power supply cables to the SC-2000USB, it can be used to create stamps from any layout that you design in the Stampcreator P-touch Editor software or Stampcreator Express software installed on your computer.

- ❶ Be sure both the SC-2000USB and the computer are turned off.
 - ❷ Attach the appropriate interface cable connector to the computer port.
- 🗨 **NOTE: After connecting the 9-pin connector, be sure to tighten the screws to lock it into place.**
- ❸ Connect the other end of the interface cable to the interface jack on the back of the SC-2000USB.
 - ❹ Insert one end of the power supply cord into the power supply jack on the SC-2000USB and the other end of the cord into an AC outlet.

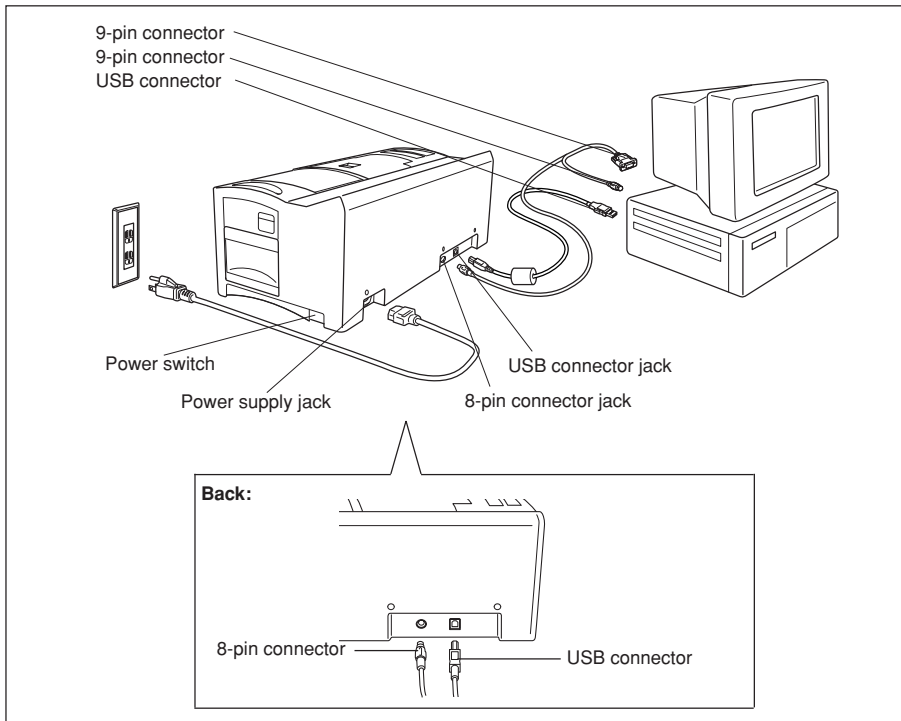

System Requirements

Computer Requirements

Check that your system meets the following requirements.

- OS: Windows® XP / Windows Vista®*1 / Windows® 7*1
 - Interface: USB port (USB Spec 1.1 or 2.0 protocol)
COM port (9-pin RS-232C serial port that supports 115,200 bps)
 - Hard Drive: Over 70MB of available space*2
 - Memory: Windows® XP: 128MB or more*2
Windows Vista®: 512MB or more*2
Windows® 7: 1 GB (32-bit) or 2 GB (64-bit) or more
 - Monitor: SVGA, high color or higher graphics card
 - Others: CD-ROM drive, pointing device
- *1 The computer should meet Microsoft®'s recommendations for the OS installed.
*2 Required available space when installing the software with all of the options.

Installing the Software

Stampcreator P-touch Editor, Stampcreator Express and printer driver

Before stamps can be engraved on the SC-2000USB, the stamp-editing tool Stampcreator P-touch Editor software, Stampcreator Express software and the SC-2000USB printer driver must be installed.

Follow the procedure described below to install the software onto the computer.

NOTE: *You must have administrator privileges in order to install the software on a computer running Windows® XP, Windows Vista® or Windows® 7.*

- 1 Connect the SC-2000USB to the computer's USB or serial port, and then **turn on only the computer.**
- 2 Insert the SC-2000USB Applications & Drivers CD-ROM into the computer's CD-ROM drive. A dialog box appears, allowing you to select which components to install. Click the Standard Installation button.

The InstallShield® Wizard for installing the software starts up.

If the dialog box does not appear automatically, go to "My Computer (Computer)", double-click the CD-ROM icon, and then double-click "Setup.exe".



For Windows Vista® and Windows® 7 users only

When the Auto Play dialog box appears, click "Run Setup.exe".

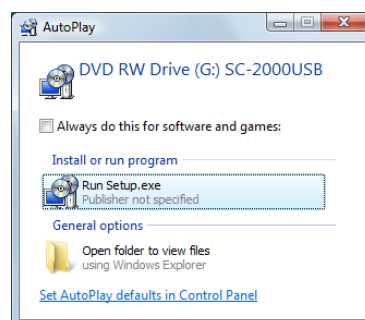

- 3 When the License Agreement dialog box appears, please read the license agreement carefully. If you accept all terms of the preceding license agreement, click the Yes button to continue.
- 4 In the Customer Information dialog box, type the necessary information into the appropriate boxes, and then click the Next button. If the information has already been registered in Windows®, it will appear in the appropriate boxes.
- 5 In the Choose Destination Location dialog box, if it is OK to install the Stampcreator P-touch Editor software into the folder shown in the "Destination Folder" box, click the Next button.

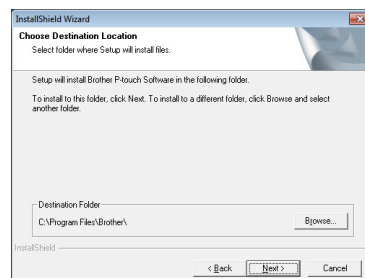

- 6 In the Add shortcut dialog box, specify where to add shortcuts for Stampcreator P-touch Editor, and then click the Next button.

7 If you are satisfied with the settings that appear in the Start Copying Files dialog box, click the Next button to begin copying files.

8 When the Driver Setup dialog box appears, select "USB cable" if the SC-2000USB is connected to a USB port or select "Serial cable" if the SC-2000USB is connected to a serial port, and then click the OK button.

For a USB port connection, continue with step 9.

For a serial port connection, continue with step 16.

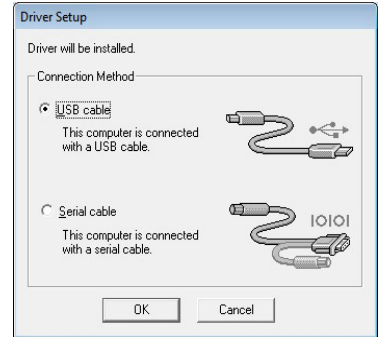

For a USB connection:

9 **For Windows Vista® and Windows® 7 users only**

After checking the files during the installation procedure, when the Windows Security dialog box appears, click the Install button.



For Windows® XP users only

After checking the files during the installation procedure, when the Software Installation dialog box appears, click the Continue Anyway button.



10 When this Driver Setup dialog box appears, connect a USB cable from your computer to the SC-2000USB. Then turn the SC-2000USB on.



For Windows Vista® and Windows® 7 users

- 11 Click the Finish button to exit the wizard.

This completes the installation of Stampcreator P-touch Editor, Stampcreator Express and the printer driver for USB connection.

Restart your computer now.

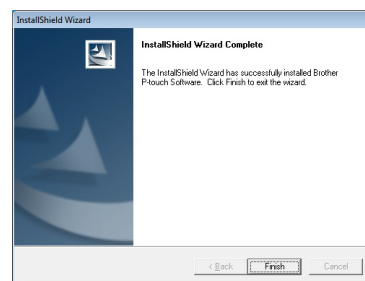

For Windows® XP users

- 11 The Found New Hardware Wizard starts up.

When asked if Windows can connect to Windows Update to search for software, select “No, not this time”, and then click the Next button.

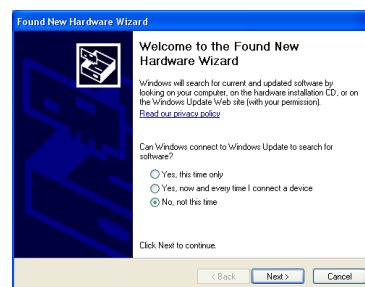

- 12 In the next dialog box, select “Install the software automatically (Recommended)”, and then click the Next button.

- 13 When the hardware Installation dialog box appears, click the Continue Anyway button.



- 14 Click the Finish button to exit the Found New Hardware Wizard.

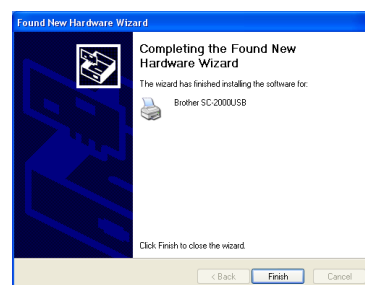

- 15 Click the Finish button to exit the wizard.

This completes the installation of Stampcreator P-touch Editor software, Stampcreator Express software and the printer driver for a USB connection.

Restart your computer now.

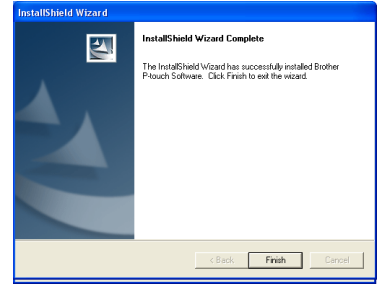

For a serial port connection:

- 16 A Driver Setup dialog box appears, allowing you to select whether to install or uninstall the printer driver. Check that "Brother SC-2000USB" is selected for installation, select "Install", and then click the Next button.

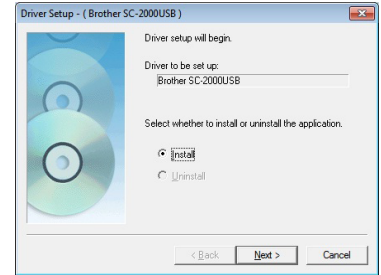

- 17 A dialog box appears, allowing you to select the COM port where the SC-2000USB is connected. Select "COM1:" if the SC-2000USB is connected to the COM1 port, "COM2:" if the SC-2000USB is connected to the COM2 port, and then click the Next button.

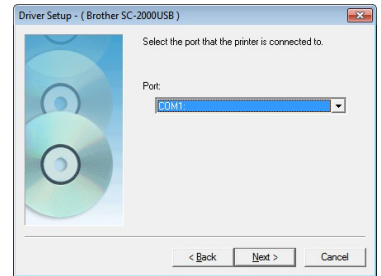

- 18 In the dialog box that appears, allowing you to confirm how the installation will be carried out, check that the installation will be carried out as desired, and then click the Next button.
- 19 A dialog box showing that the printer has been installed appears. Click the Next button.
- 20 Click the Finish button to exit the wizard.

This completes the installation of Stampcreator P-touch Editor software, Stampcreator Express software and the printer driver for a serial connection.

Restart your computer now.

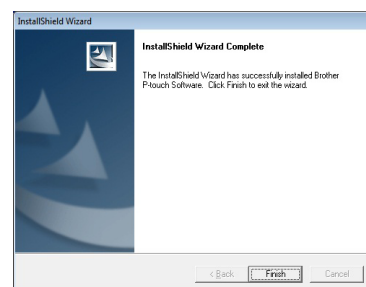

First Steps

After you have designed a stamp layout using the Stampcreator P-touch Editor software or Stampcreator Express software, you can engrave it into a stamp.

Installing the ink ribbon cassette

- 1 Press the ink ribbon compartment cover button to open the cover.

NOTE: *Open and close the ink ribbon compartment cover by pressing only on the position specified.*

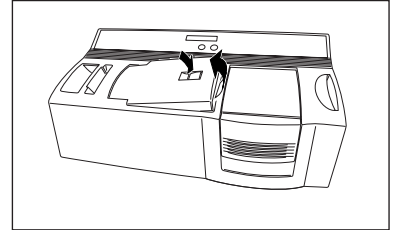

- 2 If the ink ribbon in the cassette is loose, turn it over and use your finger to wind the toothed wheel on the large knob on the right side until there is no slack in the ribbon.

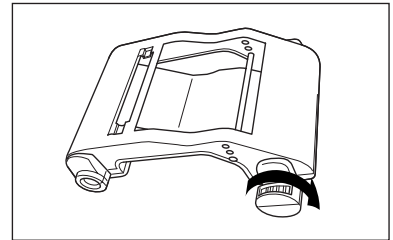

- 3 Insert the knobs on the left end of the cassette into the slots on the left side of the compartment, and then push down on the right end of the cassette so that the knobs on the right side slide into the slots on the right side of the compartment.

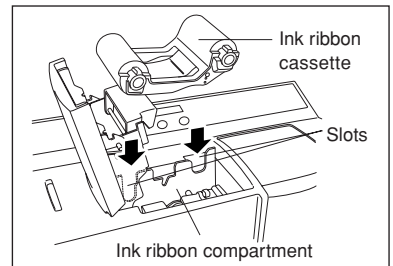

- 4 Slowly close the ink ribbon compartment cover so that it locks into place.

NOTE: *Be careful not to pinch your fingers with the compartment cover while closing it.*

Replacing a used ink ribbon cassette

- 1 Remove the empty cassette by pulling it straight up.
- 2 Follow the instructions described above to insert the new ink ribbon cassette.

NOTE: *One ink ribbon cassette will yield approximately 150 stamps and ID labels. The message "CHECK RIBBON" will appear on the Stampcreator Pro's LCD when the cartridge is empty. To order more ink ribbon cassettes, see page 57.*

Loading draft sheets and installing the draft sheet magazine tray

- ① Slide the magazine tray out from its outer case.
- ② Lift up the magazine tray lid.
- ③ Place the draft sheets (with the words "DRAFT SHEET" facing up) into the magazine tray so that the corners of the sheets fit under the tabs in the front corners of the tray.

NOTE: No more than 50 draft sheets should be loaded into the magazine tray.

Be sure that there is no dust, fingerprints, etc. on the draft sheets.

Do not use a draft sheet that has been folded.

Be sure that a cleaning sheet is not accidentally inserted together with the draft sheets.

Cleaning sheets are to be used to clean the inside of the machine (see page 44). Be sure to separate the cleaning sheets from the draft sheets.

- ④ Close the magazine tray lid.
- ⑤ Slide the magazine tray back into its outer case.
- ⑥ Fully insert the magazine tray straight into the draft sheet magazine tray slot.

NOTE: Be careful not to pinch your fingers while inserting the magazine tray.

To remove the draft sheet magazine tray, grab its outer case, and then pull out the entire magazine tray.

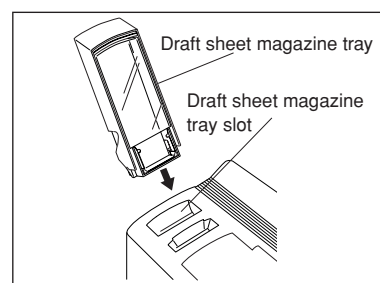
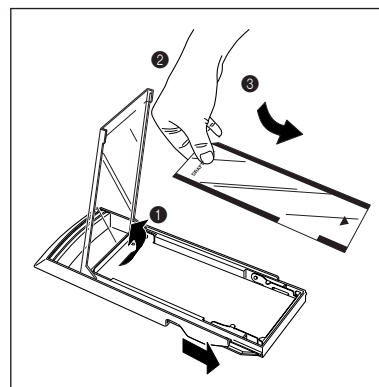

After installing the ink ribbon cassette and the magazine tray loaded with draft sheets, you can use the Stampcreator P-touch Editor software or Stampcreator Express software to create any layout containing graphics and text, and then engrave it into a stamp.

DESIGNING A STAMP

Overview

There are two stamp-editing tools: Stampcreator P-touch Editor and Stampcreator Express. Use the Stampcreator P-touch Editor software to create a stamp design with a wide variety of functions. The Stampcreator Express software is a simple stamp-editing tool. Simply select a style (template), and then change the text.

Stampcreator P-touch Editor

Start up Stampcreator P-touch Editor by following the procedure described below.

- (a) Click the Start button in the taskbar to display the Start menu.
- (b) Select "All Programs".
- (c) Select "Stampcreator P-touch Editor 4.2".
- (d) Click "Stampcreator P-touch Editor 4.2".

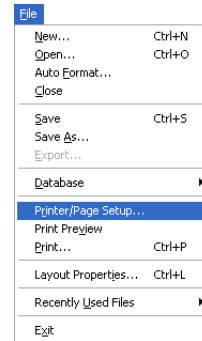

- (e) After starting up Stampcreator P-touch Editor, make sure that "SC-2000USB" is selected as the printer in the Printer Setup dialog box (Printer/Page Setup command in the File menu of the software).

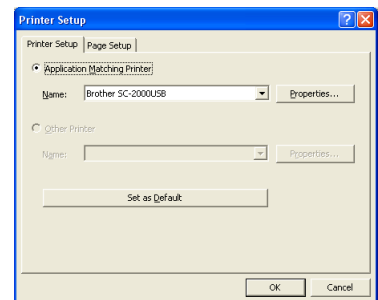

- An electronic user's guide, which can be opened by selecting the How To command in the Help menu in the Stampcreator P-touch Editor software, provides details on using the Stampcreator P-touch Editor software.

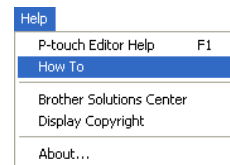

- You can see a brief explanation of each function by selecting the Help tool, then clicking an icon or button.



Tools for Formatting

Properties Dock

Print Properties

Use to select the printer and to specify whether a stamp or an ID label will be printed (see figure 1).

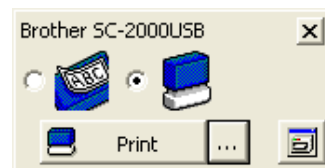

figure 1

Page Properties

Use to specify the size of the page, stamp or ID label. You can also choose the orientation of your layout area. The same settings can be found in the dialog box displayed by selecting the Print Preview command in the File menu (see figure 2).

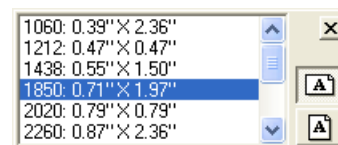

figure 2

Text Properties

Adjust these settings to format the text within selected text objects. You can change the alignment, character and line spacing, and orientation. These same settings can be found in the dialog box displayed by selecting the Text command in the Format menu. Instantly change the font, size, style (bold, italic, etc.) and effects (underline, strike-through, etc.) applied to highlighted text or a selected text block. These same settings can be found in the dialog box displayed by selecting the Font command in the Format menu (see figure 3).

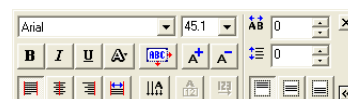

figure 3

Layout Properties

Easily adjust the size, order, alignment and rotation of selected objects. The same settings can be found in the Layout menu (see figure 4).



figure 4

Database Properties

These properties allow you to move to different records in the database and select how merged fields appear in your layout. The same settings can be found in the Display tab of the dialog box displayed by selecting the Options command in the Tool menu (see figure 5).



figure 5

Tools

Select tool (figure 1a)

Select this tool, and then select, move or change the size of an object. Double-click an object to display a dialog box for editing that object.

Text Input tool (figure 1b)

Select this tool, position the pointer in the layout area, and then click to begin typing your text.

Vertical Text tool (figure 1c)

Select this tool, position the pointer in the layout area, and then click to begin typing your text vertically.

Line tool (figure 1d)

Select this tool to draw straight lines either horizontally, vertically, or diagonally in the layout area. Hold down the Shift key while dragging the pointer to keep the line perfectly straight.

Box tool (figure 1e)

Select this tool to draw a box in your layout area. Hold down the Shift key while dragging the pointer to keep the box perfectly square.

Rounded Box tool (figure 1f)

Very similar to the Box tool, this tool allows you to draw boxes with rounded corners. Hold down the Shift key while dragging the pointer to keep the box perfectly square.

Ellipse tool (figure 1g)

Draw ellipses in your layout area in the same way that you would draw a box.

Curve tool (figure 1h)

As simple as using a pencil, this tool allows you to draw curves and pictures in your layout.

Polygon tool (figure 1i)

Use this tool to draw polygons in your layout.

Frame tool (figure 1j)

Use this tool to draw a frame in your layout area like you would a box. The pattern of the frame can be changed in the dialog box displayed either by double-clicking inside the frame with the Select tool or by selecting the Frame command in the Format menu.



Object Dock

Text icon

Add a new text block your layout.

The same dialog box can be displayed by selecting the Text command in the Insert menu.

Arrange Text icon

Add text in different arrangements to your layout. The same dialog box can be displayed by selecting the Arrange Text command in the Insert menu.

Decorative Frame icon

Open the Frame Properties dialog box to specify settings for a frame to be added to your layout. The same dialog box can be displayed by selecting the Frame command in the Insert menu.

Table icon

Insert a table into your layout. The same dialog box can be displayed by selecting the Table command in the Insert menu.

Image icon

Import graphics from a scanner, digital camera or other clip art source to your layout. The same dialog box can be displayed by selecting the From File command in the Picture sub-menu of the Insert menu.

Screen Capture icon

Take a snapshot of the screen and insert it into your layout.

Click the icon to hide the Stampcreator P-touch Editor window and change the shape of the pointer. To select the desired area of the window, draw a rectangle around it by clicking the upper-left corner of the desired area, dragging the pointer to the lower-right corner, then releasing the mouse button to take the snapshot. To perform the same operation, a dialog box can be displayed by selecting the Screen Capture command in the Picture sub-menu of the Insert menu.

Clip Art icon

Selecting this icon displays the Clip Art dialog box. The same dialog box can be displayed by selecting the Clip Art command in the Picture sub-menu of the Insert menu.

Symbol icon

Insert symbols into your layout. The same dialog box can be displayed by selecting the Symbol command in the Picture sub-menu of the Insert menu.

Make Picture icon

Select this icon to insert pictures into your layout. Scroll through numerous categories and pictures to create humorous characters. The same dialog box can be displayed by selecting the Make Picture command in the Insert menu.

Date and Time icon

Select this icon to insert the date and time in a variety of formats. The same dialog box can be displayed by selecting the Date/Time/Calendar command in the Insert menu.

Calendar icon

Insert a calendar into your layout. The same dialog box can be displayed by selecting the Symbol command in the Insert menu.

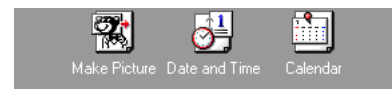

Formatting a Stamp

Selecting the stamp size

- 1 Display the Page Properties.
- 2 From the "Stamp Size" list, select the size of stamp to be made (see figure 1).

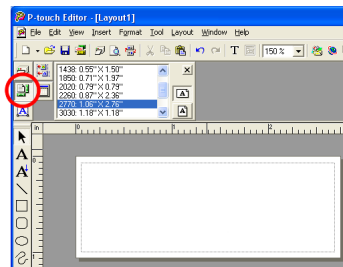

figure 1

Typing text

- 1 Select the Text Input tool.
 - 2 Click in the layout area.
 - 3 Type the first line of stamp text, and then press the Return key. Continue typing, pressing the Return key after each line of text (see figure 2).
- The layout area is within the dotted lines. Anything outside of this area is not included in the stamp image.

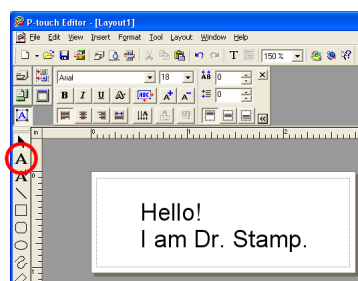

figure 2

Changing the font

- 1 Display the Text Properties.
- 2 Use the Text Input tool to highlight the text to be changed.
 - The current font is shown in the Text Properties.
- 3 From the "Font" drop-down list, select the desired font (see figure 3).
- The highlighted text is changed (see figure 4).

NOTE: Stampcreator P-touch Editor supports all TrueType® fonts but does not support PostScript® fonts.

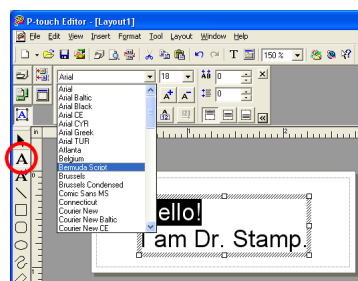

figure 3

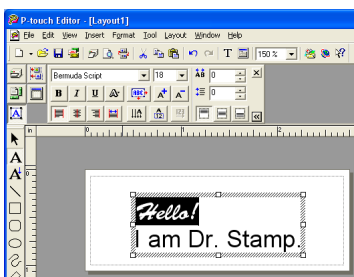

figure 4

Changing the character size

- 1 Display the Text Properties.
- 2 With the Text Input tool, highlight the text to be changed.
 - The current character size is shown in the Text Properties.
- 3 From the “Size” drop-down list, select the desired character size (see figure 5).
 - The highlighted text is changed.

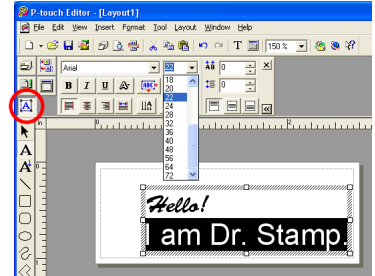

figure 5

Changing style effects

You can apply certain effects to your text (for example, bold, italic, underline, stripes, and outlines) by selecting an effect from the Text Properties.

- 1 With the Text Input tool, highlight the text to be changed.
- 2 Select the desired style effect from the Text Properties (see figure 6).
 - The highlighted text is changed.

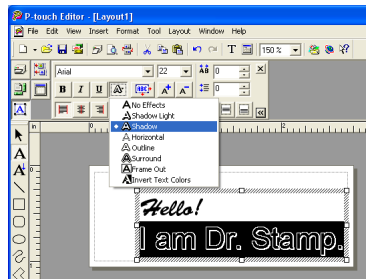

figure 6

Changing the font of a text block

- 1 Display the Text Properties.
- 2 With the Select tool, click the block of text to be changed in the stamp layout. Handles appear around the text block.
 - The current font is shown in the Text Properties.
- 3 From the “Font” drop-down list, select the desired font (see figure 7).
 - The selected text is changed.

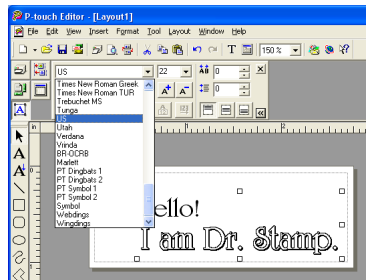

figure 7

Changing the character size of a text block

- 1 Display the Text Properties.
- 2 With the Select tool, click the block of text to be changed in the stamp layout. Handles appear around the text block.
 - The current character size is shown in the Text Properties.
- 3 From the "Size" drop-down list, select the desired character size (see figure 8).
 - The selected text is changed.

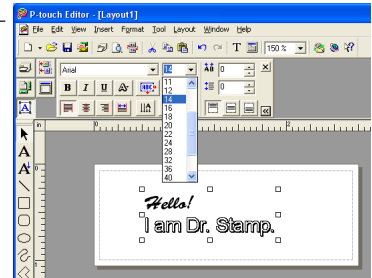

figure 8

Using the Maximum button

- 1 Display the Layout Properties.
- 2 With the Select tool, click the block of text to be changed in the stamp layout. Handles appear around the text block.
- 3 Click the Maximum button in the Layout Properties (see figure 9).
 - The size of the text is automatically adjusted to the maximum layout area of the selected stamp size with the original vertical and horizontal proportions.

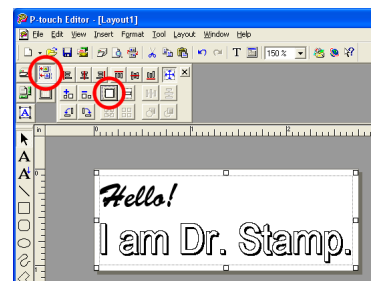

figure 9

Manual adjustment

- 1 With the Select tool, click the block of text to be changed in the stamp layout. Handles appear around the text block.
- 2 Drag a handle to adjust the text block to the desired size (see figure 10).
- To adjust a text block while keeping the original vertical/horizontal proportions, use the Select tool to select a corner handle. Then, while holding down the Shift key, drag the handle.

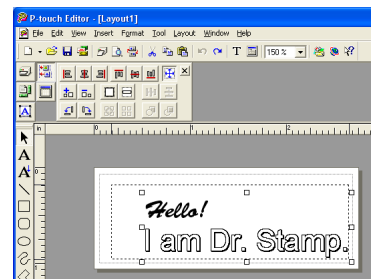

figure 10

Centering text within a block

This section explains how to center text within a text block. To align each block in the layout area, refer to the section “Vertical and horizontal block alignment” below.

- 1 Display the Text Properties, and then click the Enlarge/Reduce button to display the advanced settings.
 - 2 With the Select tool, click the block of text to be changed in the stamp layout. Handles appear around the text block.
 - 3 Click the Center Alignment button (see figure 11).
- The selected text is changed.
 - Use this method to align the text at the right, left, top or bottom within the text block.

NOTE: The setting is in effect until you change it.

Vertical and horizontal block alignment

This section describes how to align the text blocks. To change the alignment of text within the text block, refer to the section “Centering text within a block” above.

- 1 Display the Text Properties.
 - 2 With the Select tool, click the block of text to be changed in the stamp layout. Handles appear around the text block.
 - 3 Click the Align sub-menu in the Layout menu (see figure 12).
 - 4 Select the Align in Relation to Print Area command.
 - 5 Click the Align Horizontal Center or Aligner Vertical Center button in the Layout Properties.
- The selected text is changed (see figure 13).
 - Use this method to align the text blocks at the right, left, top or bottom within the layout area.

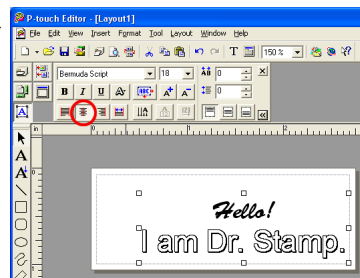

figure 11

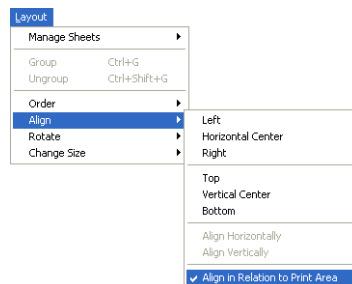

figure 12



figure 13

Drawing lines in a stamp

- 1 Type in the text (refer to the section “Typing text” on page 19).

NOTE: Text can be inserted before or after drawing a line.

- 2 Select the Line tool, and then drag the pointer in the layout area to draw the desired line (see figure 14).

NOTE: To draw a straight line, drag the pointer while holding down the Shift key.

Changing the line length

- 1 With the Select tool, click the line.
 - A box appears on both ends of the line.
- 2 Drag either box to adjust the line length.

Changing the line width and style

- 1 With the Select tool, double-click the line to display the Line Properties dialog box.
- 2 On the Drawing tab, select the line style and/or weight, and then click the OK button (see figure 15).

NOTE: The line width and style can only be applied once to each line.

Deleting a line

- 1 With the Select tool, click the line.
- 2 Press the Delete key on the keyboard.

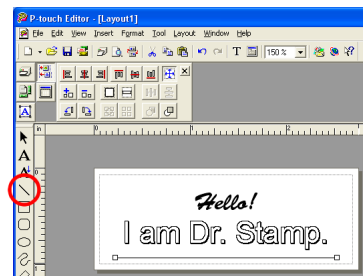

figure 14

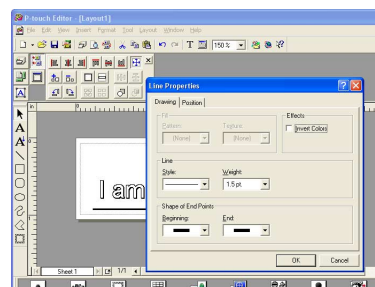

figure 15

Drawing a frame

- 1 Select the Box tool, and then drag the pointer in the layout area to draw the desired frame (see figure 16).
- If the inside of the frame is not translucent, use the Select tool to double-click inside the frame to display the Box Properties dialog box. Select "None" in the "Pattern" and "Texture" drop-down lists in the "Fill" group box.
 - To make frames with rounded corners or to make an ellipse, use the Rounded Box tool or the Ellipse tool in the same manner.

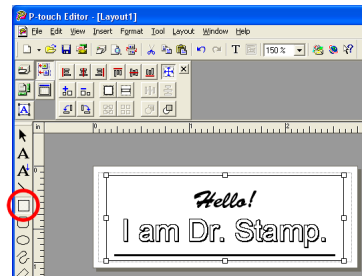

figure 16

Changing the frame size

Using the Maximum button

- 1 Display the Layout Properties.
 - 2 With the Select tool, click the frame. Handles appear around the frame.
 - 3 Click the Maximum button in the Layout Properties (see figure 17).
- The size of the frame is automatically adjusted to the maximum layout area of the selected stamp size.

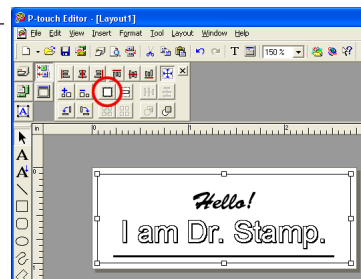

figure 17

Manual Adjustment

- 1 With the Select tool, click the frame. Handles appear around the frame.
 - 2 Drag a handle to adjust the frame to the desired size (see figure 18).
- To adjust a frame while keeping the original vertical/horizontal proportions, use the Select tool to click a corner handle. Then, while holding down the Shift key, drag the handle.

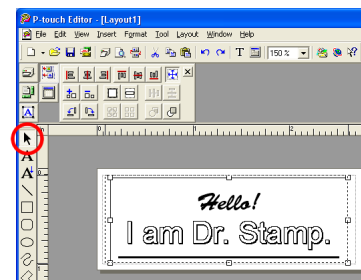

figure 18

Using special design frames

Selecting a frame design

- 1 Type in the text (refer to the section “Typing text” on page 19).

NOTE: Text can be inserted before or after drawing a frame.

- 2 Select the Frame tool.
 - 3 Drag the pointer at the desired location in the layout area to draw the frame.
 - 4 With the Select tool, double-click inside the frame to display the Frame Properties dialog box (see figure 19).
 - 5 Select the desired frame settings from the “Category” drop-down list and “Style” list, and then click the OK button.
- The selected frame design appears in the layout area (see figure 20).

NOTE: To change the frame size, refer to the section “Changing the frame size” on page 24.

Deleting a frame

- 1 With the Select tool, click the frame.
- 2 Press the Delete key on the keyboard.

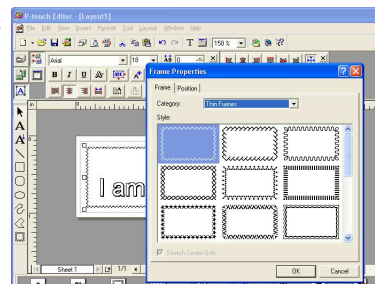

figure 19

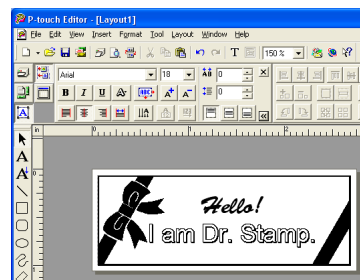

figure 20

Creating stamps with clip art images

Using clip art images

- 1 Type in the text (refer to the section "Typing text" on page 19).

NOTE: Text can be inserted before or after selecting a clip art image.

- 2 There are over 700 clip art images included in the Stampcreator P-touch Editor program.
 - 3 Select a category, choose a clip art image, and then click the OK button.
- The selected clip art appears in the layout area (see figure 21).

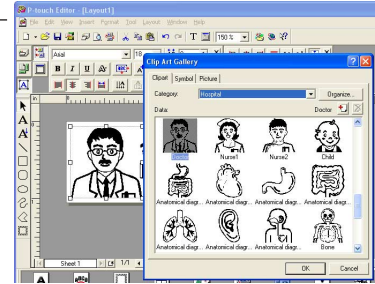

figure 21

Moving clip art images

- 1 With the Select tool, click the clip art image.
- 2 Drag the image to the desired location.

Enlarging/shrinking clip art images

- 1 With the Select tool, click the clip art image. Handles appear around the clip art image.
- 2 Drag a corner handle to adjust the clip art image to the desired size.

NOTE: Clip art images are not distorted when enlarged or shrunk. Excessive shrinking will reduce the image quality.

Deleting clip art images

- 1 With the Select tool, click the clip art image.
- 2 Press the Delete key on the keyboard.

Creating stamps with pictures

Using a picture

- 1 Type in the text (refer to the section "Typing text" on page 19).

NOTE: Text can be inserted before or after selecting a picture.

- 2 Click the Make Picture icon.
 - 3 Select the desired category and picture to create a humorous character, and then click the OK button (see figure 22).
- The selected picture appears in the layout area.

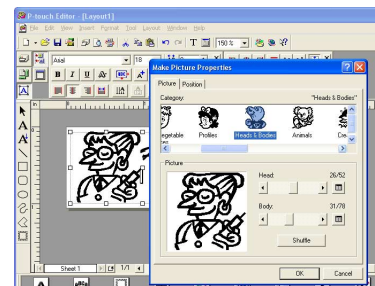

figure 22

Enlarging/shrinking a picture

- 1 With the Select tool, click the picture. Handles appear around the picture.
- 2 Drag a corner handle to adjust the picture to the desired size.

NOTE: Pictures are not distorted when enlarged or shrunk. Excessive shrinking will reduce the image quality.

Deleting a picture

- 1 With the Select tool, click the picture.
- 2 Press the Delete key on the keyboard.

Advanced Steps

Importing graphics from a scanner, digital camera, or other clip art source

- 1 Save the graphic image taken from the scanner, digital camera, etc., as one of the file formats Stampcreator P-touch Editor supports.

Bitmap file (bmp, dib)
JPEG file (jpg, jpeg)
Uncompressed TIFF file (tif)
ICON file (ico)
Windows Meta file (wmf, emf)
PNG file (png)
GIF file (gif)



figure 1

- 2 Click the Image icon.

The same dialog box can be displayed by selecting the From File command in the Picture sub-menu of the Insert menu.

- 3 Select the folder and saved file, and then click the OK button (see figure 1).

- The selected image appears in the layout area (see figure 2).
- Images in supported formats can easily be imported by using the Copy and Paste commands in addition to the method described above.

NOTE: Saving photo images as JPG reduces the file size.

You can import BMP, DIB, JPG, JPEG, TIF, ICO, WMF, EMF, PNG and GIF files directly into the Stampcreator P-touch Editor. For other graphic file formats, use a graphic file conversion software package to change the file format before importing the file into the Stampcreator P-touch Editor.

NOTE: Stampcreator P-touch Editor can not import images saved in unsupported file formats.



figure 2

Enlarging/shrinking imported images

- 1 With the Select tool, click the image. Handles appear around the image.
- 2 Drag a corner handle to adjust the image to the desired size.

NOTE: If the scanned image is unsatisfactory, rescan with a resolution of 600 dpi and import the image again.

Adding imported images to the Stampcreator P-touch Editor clip art list

- 1 After importing graphics and making the necessary corrections, use the Select Tool to double-click the image to display the Image Properties dialog box.
- The image is shown in the preview box of the dialog box.
- 2 Click the Add to Clip Art button.
- 3 Select the category where you would like to add the image, and then click the OK button.
- The selected image is registered in the Stampcreator P-touch Editor clip art list.
- To open an added image, refer to the section "Creating stamps with clip art images" on page 26.

Moving imported images

- 1 With the Select tool, click the image.
- 2 Drag the image to the desired location.

Deleting imported images

- 1 With the Select tool, click the image.
- 2 Press the Delete key on the keyboard.

Making a stamp containing a photo

The procedures for inserting and enhancing photo data are described in this section.

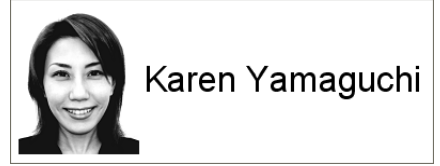

Preparing photo data

First save a photo image to your computer.

Specifying the size of the stamp

MEMO:

Click  to display the Page Properties.
(If they are already displayed, skip this step.)

- From the "Paper Size" box, select desired stamp size.

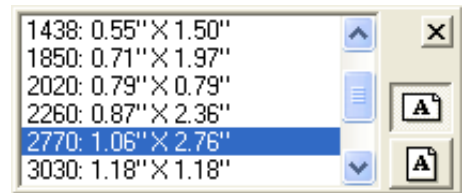

HINT:

When editing small stamp layouts, increase the zoom ratio to edit the text more easily.

The zoom ratio can be changed in the "Zoom" box on the Standard toolbar.

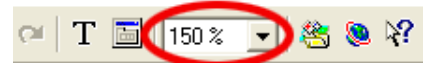

Inserting photo data

Insert the photo data.

- 1 Click the Image icon on the object dock to display the Open dialog box.
- 2 Select the photo data that was saved to your computer.

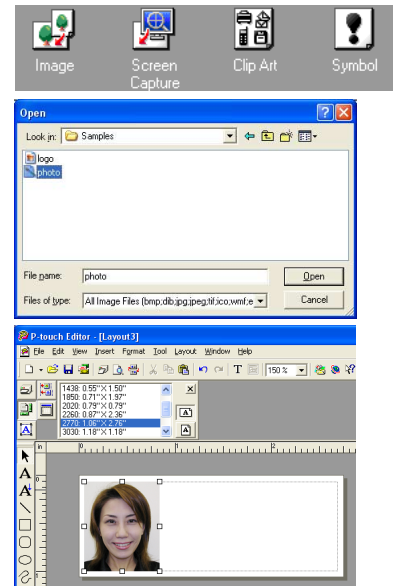

Adjusting photo data

Adjust the photo data to enhance it.

- 1 Use the Select tool to double-click the image to display the Image Properties dialog box.
- 2 Click the Image tab.
- 3 In the box of the "Effects" group box, select "Photo Enhance".
- 4 Click the Details button to display a dialog box showing various effects applied to the photo.

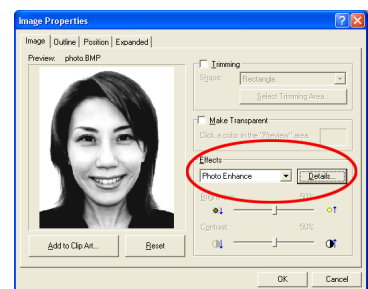

DESIGNING A STAMP (Stampcreator P-touch Editor)

- From the 9 samples, click the sample that looks good, and then click the OK button.

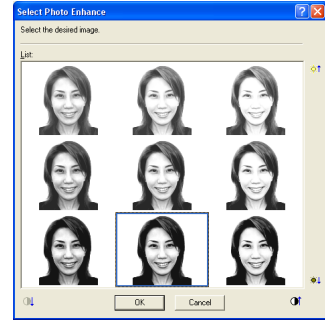

- In the Image Properties dialog box, click the OK button to adjust the photo in the layout.

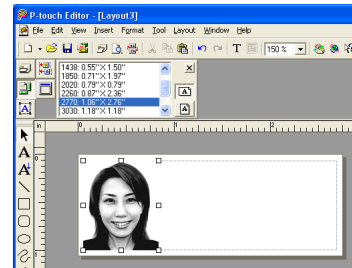

Entering text

- 1 Click the Text Input button on the object dock. A flashing cursor appears.



MEMO:

Before typing in text, make sure that the Align Center button on the Text Properties is clicked.



- 2 Type text.

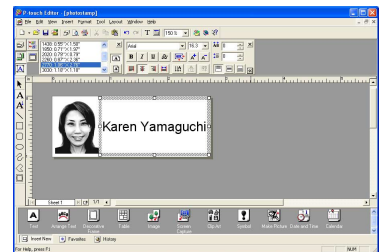

This completes the layout of the stamp containing a photo.

Printing data containing graphics (photos)

Stampcreator P-touch Editor automatically selects the print mode that best suits your design and will produce the best stamp quality. The various print modes are described below.

- 1 Select "Stamp", and then select the appropriate setting in the "Document Type" drop-down list.

Logo: Best for stamps with a logo mark

Text: Good for stamps with text only

Text+Photo: Good for stamps with text and photos (graphics)

Photo: Best for stamps containing photos with the "Photo Enhance" effect applied

- The print mode can be changed using the setting in the Page Properties.

NOTE: *In order for the Stampcreator P-touch Editor to select the correct print mode automatically, the Color palette for the monitor should be set to "High Color".*

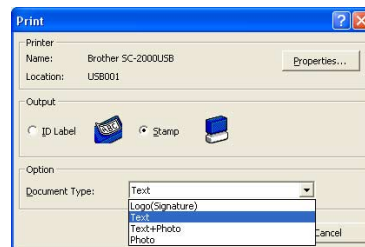

Auto Format

There are more than 150 stamp templates available in the Stampcreator P-touch Editor. All of these designs can be easily produced using the Auto Format function.

Using Auto Formats

- 1 Click the Auto Format button on the Standard toolbar, or select the Auto Format command in the File menu.
 - 2 Select a category, and then click the Next button (see figure 1).
 - 3 Select a desired template, and then click the Next button (see figure 2).
 - 4 Click the text that you would like to change, change the text in the "Input" box, and then click the Next button (see figure 3).
 - 5 Select the desired options, and then click the Finish button or Back button to finish your stamp or revise it.
- The adjusted stamp layout appears in the layout area (see figure 4).

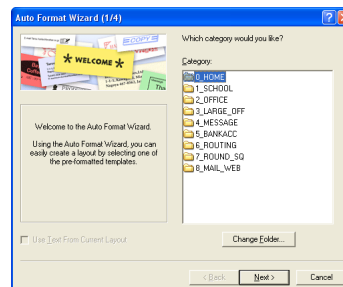

figure 1

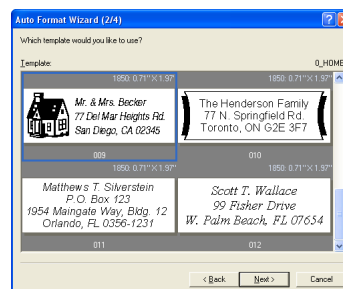

figure 2



figure 3

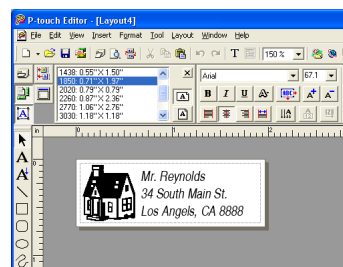

figure 4

Stampcreator Express

Formatting a stamp

- 1 Start up Stampcreator Express by following the procedure described below.
 - (a) Click the Start button in the taskbar to display the Start menu.
 - (b) Select "All Programs".
 - (c) Select "Stampcreator Express".
 - (d) Click "Stampcreator Express".
- 2 After Stampcreator Express is started, the Style Selection window appears. Click the Browse button.



- 3 In the Select a Style dialog box, select the desired category in the "Category" drop-down list.
 - 4 Select a style by double-clicking it or by clicking the style, then clicking the OK button. In this example, select the style "203".

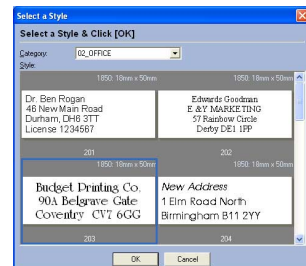
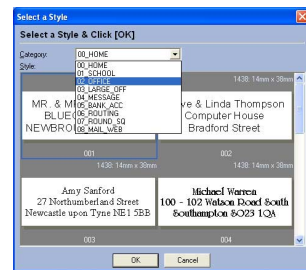

DESIGNING A STAMP (Stampcreator Express)

In this example, select text line 1, and then type in "Brother Industries, Ltd."

Change text lines 2 and 3 as you wish.

If the entered text exceeds the length of the original text, the text size is automatically adjusted so that the text fits within the text field.



- 6 To change the font, character style or spacing of each text line, select the text line, and then click **A** to display the Font dialog box.

Select the font from the "Font" drop-down list, click the appropriate button to select the bold or italic character style, and then specify the character spacing.

Then, click the Close button to return to the Type Text window.

NOTE: The spacing is applied to all text lines.

In this example, select "Arial Black" in the "Font" drop-down list, select the italic character style, and then specify "-2 %" in the "Spacing" box.

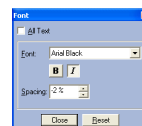
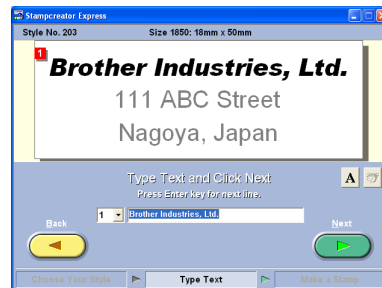

- 7 When you have finished designing the stamp, click the Next button.

Printing a draft sheet

- 8 Below "Print ID Label or Make Stamp?" in the next window that appears, click the Stamp button.

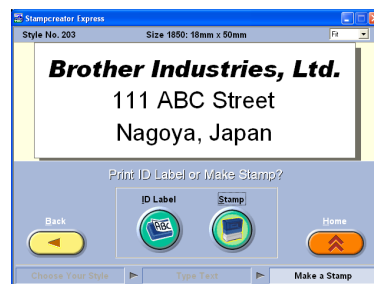

When the Print Stamp dialog box appears, check the stamp size, and then click the OK button.

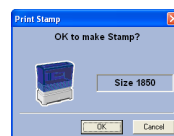

For details on engraving a stamp, refer to the section "Engraving a stamp" on page 40 of this STORE OPERATIONS MANUAL.

Making an ID label

- Below "Print ID Label or Make Stamp?" in the window, click the ID Label button.

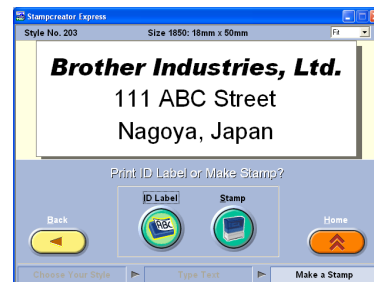

When the Print ID Label dialog box appears, check the stamp size, insert the appropriate ID label into the ID label slot of SC-2000USB, and then click the OK button.

For details on printing an ID label, refer to the section "Making an ID label" on page 43 of this STORE OPERATIONS MANUAL.

For details on assembling a stamp, refer to the section "Assembling the stamp" on page 42 of this STORE OPERATIONS MANUAL.



Adding new styles to the Stampcreator Express software

A style in the Stampcreator Express software is a type of template. A template is created from the same type of file designed using the Stampcreator P-touch Editor software.

For details on using the Stampcreator P-touch Editor software, refer to the P-touch Editor Help, which can be opened by selecting the How To command in the Help menu of the Stampcreator P-touch Editor software.

- 1 When creating a stamp design in the Stampcreator P-touch Editor software, select **“Fixed Frame Size”** in the “Text Layout” drop-down list of the Text Properties dialog box.

To select a Text Layout setting:

Display the Text Properties dialog box by double-clicking the text object, or by clicking the text object and selecting the Text command in the Format menu.

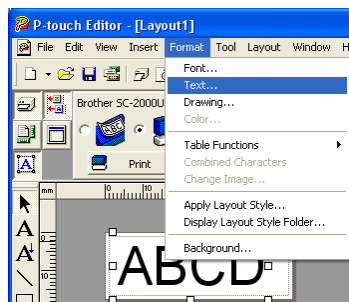

Select **“Fixed Frame Size”** in the “Text Layout” drop-down list, and then click the Details button.

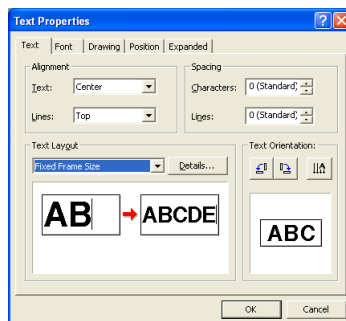

In the Text Options dialog box, select **“Shrink to Fit”**.

If the “Maintain Height-to-Width Proportion” check box is selected, the text size is automatically reduced so that the text fits within the text field when the text exceeds the length of the original text.

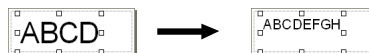
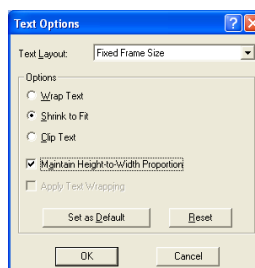

If the “Maintain Height-to-Width Proportion” check box is cleared, the text width is automatically adjusted so that the text fits within the text field when the text exceeds the length of the original text.

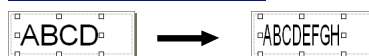

- Save the stamp design as a template file in the LBL file format. Select the Save As command in the File menu.

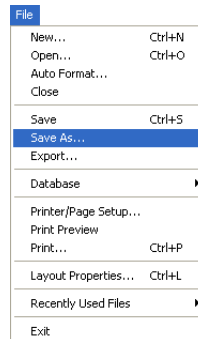

Save the template file in the following folder.
 <Windows_drive>:\Program Files\Brother\SE42\Template\SC2000\



In this example, make a new folder titled "11_Original" in the "SC2000" folder and name the template file "1101". Then, click the Save button.

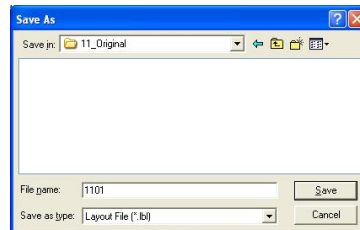

- Start up Stampcreator Express, and then click the Browse button. "11_Original" is available in the "Category" list in the Select a Style dialog box, and the new style "1101" is available in the "11_Original" category.

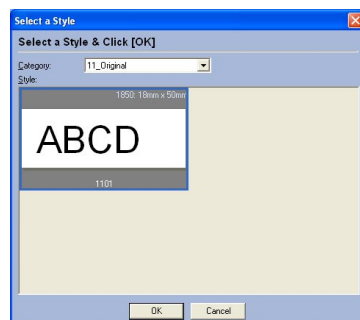
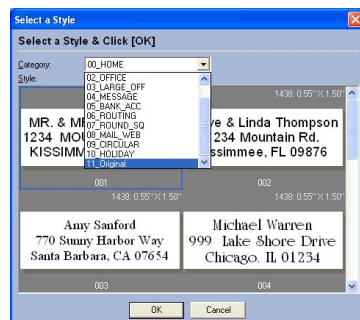

MAKING A STAMP

Final Steps

Getting ready

❶ Start up Stampcreator P-touch Editor.

For details on using the Stampcreator Express software, refer to pages 33 through 34.

❷ Make sure that "SC-2000USB" is selected as the printer in the Printer Setup dialog box (Printer/Page Setup command in the File menu of the software).

❸ Design a stamp.

🗨 **NOTE:** *You cannot reprint or reuse a stamp once it has already been used. Before printing, open the stamp shutter to make sure that you are using the correct draft sheet.*

Dust may cause poor printing and engraving. Make sure that there is no dust on the printing side of the stamp before inserting the stamp into the machine.

Printing a draft sheet

❶ Load a draft sheet into the machine to print a positive image.

Fully insert the draft sheet magazine tray straight into the draft sheet magazine tray slot.

🗨 *Be careful not to pinch your fingers while inserting the draft sheet magazine tray.*

To remove the draft sheet magazine tray, grab its outer case, and then pull out the entire magazine tray.

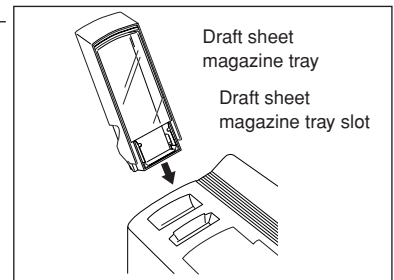

❷ Turn on the machine.

❸ Make sure the message "READY" appears in the LCD.

❹ Click  to display the Print Properties. (If they are already displayed, skip this step.)

Click  in the Print Properties to display the Printer Setup dialog box.

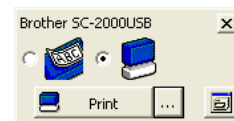

❺ Check that "Brother SC-2000USB" is selected below "Application Matching Printer", and then click the OK button.

Click  in the Print Properties. The Print dialog box appears.

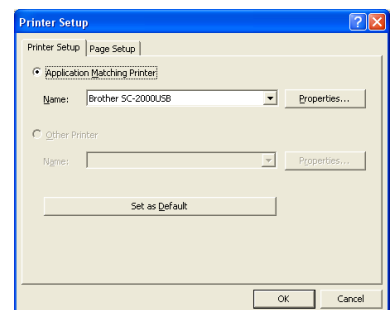

- 6 Select "Stamp", and then select the appropriate setting in the "Document Type" drop-down list.

Logo: Best for stamps with a logo mark

Text: Good for stamps with text only

Text+Photo: Good for stamps with text and photos (graphics)

Photo: Best for stamps containing photos with the "Photo Enhance" effect applied



- 7 Click the Print button to start printing a draft sheet.

For details on printing a draft sheet with Stampcreator Express, refer to page 38.

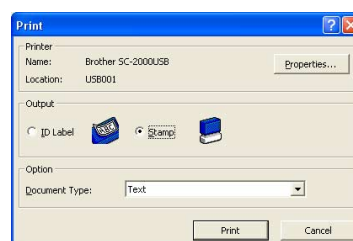

Engraving a stamp

- ❶ After the data is printed onto the draft sheet, which is then fed over the xenon lamp unit, the message "INSTALL STAMP!" appears in the LCD of the SC-2000USB.
- ❷ Lift open the stamp compartment cover, slowly pull the lever toward you to open the doors in the stamp compartment, and then check that the printed draft sheet has stopped over the xenon lamp unit (see figure 1).

🗨 **NOTE:** *Be careful not to touch the draft sheet that has stopped over the xenon lamp unit.*

Do not allow the clear plastic surface of the xenon lamp unit to become dirty or scratched. Use a soft cloth to wipe off any dust on the clear plastic surface.

To cancel engraving, press the Mode button on the SC-2000USB until "CANCEL" appears in the LCD, and then press the Set button to feed out the draft sheet.

- ❸ Select a blank stamp pad in the desired size. Make sure that the stamp size you have selected in the drop-down list matches the size indicated on the stamp holder (see figure 2).

- ❹ Remove the cap from the stamp.

🗨 **NOTE:** *Do not reuse an ink pad after ink has permeated the pad's surface (see figure 3).*

🗨 **NOTE:** *Do not peel off the clear protective film before engraving the stamp (see figure 4).*

IMPORTANT NOTE:

- Do not touch the printed draft sheet.
- Do not remove the stamp's clear protective film before engraving.

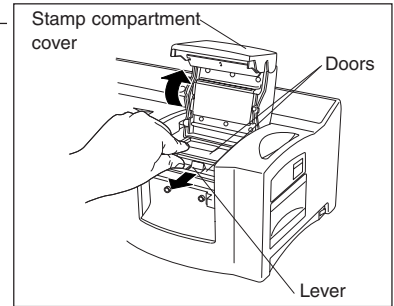

figure 1

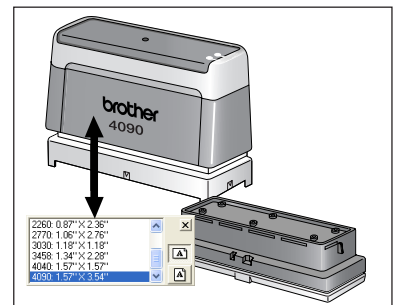

figure 2

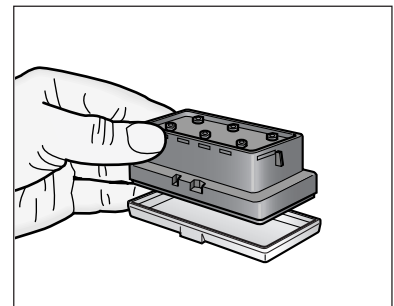

figure 3

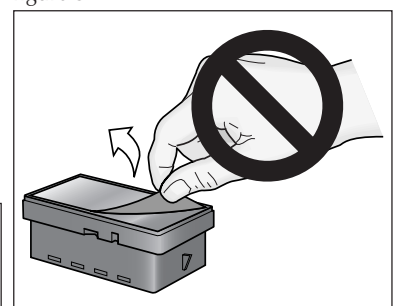

figure 4

- 5 Insert a stamp between the doors so that the teeth in the center of the doors fit into the notches in the center of the stamp (see figure 5). Make sure that the stamp surface lies flat on the printed draft sheet.

NOTE: Do not use a stamp that has the protective film removed from the stamp surface or that has been assembled with the skirt and grip.

Before inserting the stamp, be sure that there is no dust on the protective film covering its surface.

Be sure that the stamp is at the same temperature as the SC-2000USB, otherwise the stamp may not be engraved correctly.

Be careful not to break the ink bag inside the stamp.

- 6 Slowly close the doors. Close the stamp compartment cover to the lock position in order for the xenon lamp to flash (see figure 6).

NOTE: Do not look directly at the light.

- The message “REMOVE STAMP” appears in the LCD. Open the doors in the stamp compartment to remove the stamp (see figure 7).
- The draft sheet will automatically be fed from the slot on the top at the right end of the machine.

NOTE: Bright light! Do not open the stamp compartment cover until the xenon lamp has finished flashing.

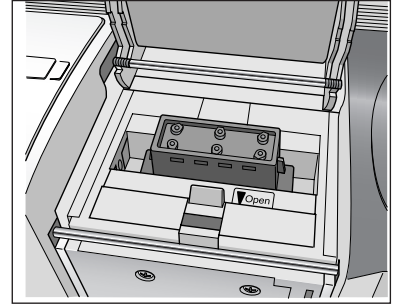

figure 5

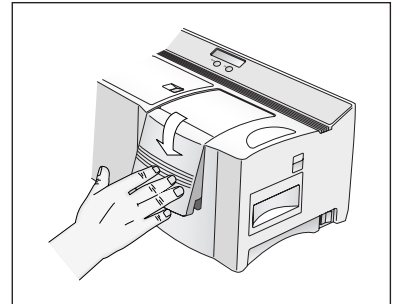

figure 6

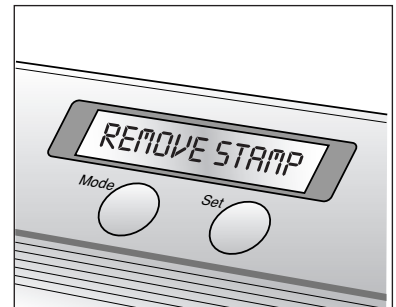

figure 7

Assembling the stamp

- 1 Peel off the protective film from the rubber surface of the stamp (see figure 8).
 - 2 With the protective cap covering the surface of the stamp, place the stamp face down.
 - 3 Place the skirt (middle section) over the top of the stamp (see figure 9), and then push it down firmly until the upper edge of the stamp skirt is below the top of the stamp holder.
 - 4 Make sure that the stamp holder moves smoothly up and down in the stamp skirt.
 - 5 Lay the assembled pad on a flat surface. Place the grip or holder over the skirt and push it down firmly. This action will break the ink container inside the stamp (see figure 10).
- Leave the stamp in an upright position for at least 3 minutes to ensure ink spreads equally over the pad (see figure 11).
 - After assembling the stamp, allow 30 minutes to 4 hours for the ink to absorb fully into the pad surface. Ink cure time varies for each size stamp depending on room temperature. To minimize cure time, keep the ink pad in a warm place and in an upright position.

NOTE: *Flipping the stamp over soon after it has been assembled will prolong the cure time.*

IMPORTANT NOTE:

- Do not flip the stamp upside down soon after it has been assembled.
- Do not place the stamp on its side soon after it has been assembled.

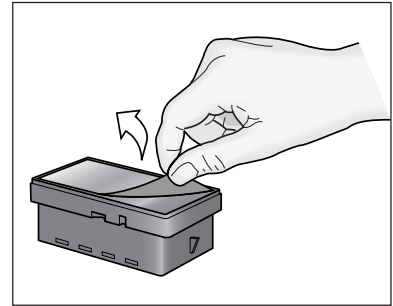

figure 8

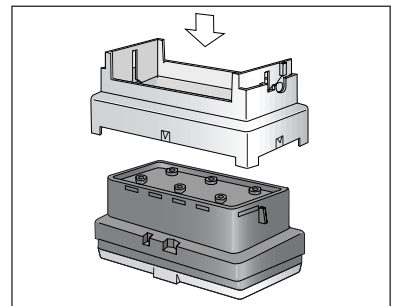

figure 9

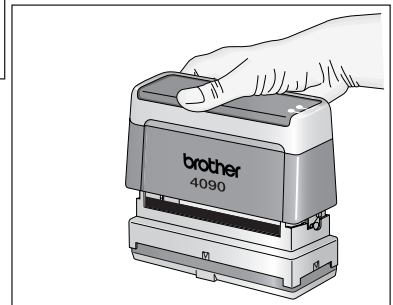

figure 10

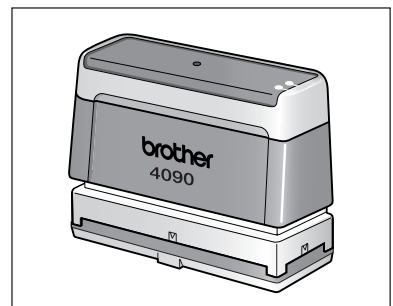

figure 11

Making an ID label

After engraving the stamp, we can print the same layout on a label that can be attached to the stamp for easy identification. In order to see how the stamp will appear when it is engraved, the ID label can be printed before engraving the stamp.

- 1 Insert an ID label sheet, so that the words "ID LABEL" can be read, straight into the narrow ID label slot to the right of the draft tray slot.

NOTE: *Be careful not to touch the print area of the ID label sheet since dust, fingerprints, hand creams, etc. may prevent the characters from being printed correctly.*

Be sure that the ID label is the correct size.

Do not use an ID label that has been folded.

- ID labels for smaller size stamps (1212, 2020, 3030, 4040, 1060, and 1438) have two printing areas on each label. Print labels in the lower portion first, and then save the unused portion for future use. The machine will always print on the lower portion.
- 2 With the layout of the engraved stamp displayed in Stampcreator P-touch Editor, select the Print command in the File menu.
Or click  in the Print Properties. The Print dialog box appears.
 - 3 Select "ID Label", and then select the appropriate setting in the "Document Type" drop-down list.
Insert an ID label sheet into the ID label slot of the SC-2000USB, and then click the Print button to start printing the ID label.

NOTE: *For details on printing an ID label with Stampcreator Express, refer to page 35.*

- The ID label will automatically be fed from the slot on the top at the right end of the machine.

Applying an ID label

After the label has been printed and fed from the exit slot on the top at the right end of the SC-2000USB, remove it, peel off the ID label from its backing paper, and then affix the ID label to the top of the grip.

NOTE: *Some stamps, such as the 4090, 3458, and 4040, have an L-shaped ID label. When attaching this type of ID label, apply the short side first, and then apply the remaining side to the stamp grip.*

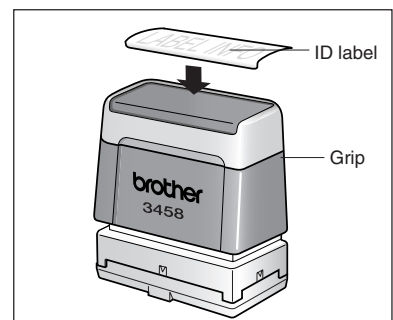
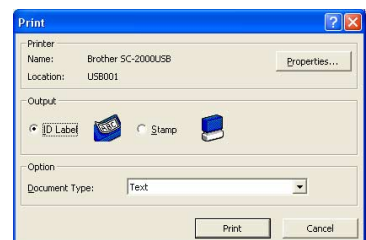
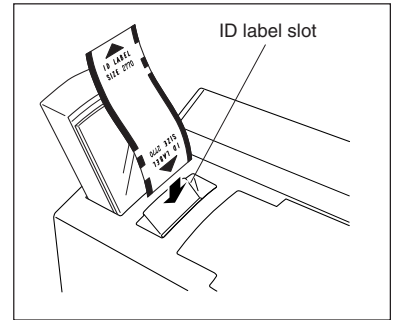

Periodic Maintenance

It is recommended that the Stampcreator Pro be cleaned after 50 stamp engravings have been made. Use three cleaning sheets to clean inside of the machine. Three cleaning sheets are provided for every 50 draft sheets.

Cleaning the draft sheet rollers

Sheet 1

- 1 At the pre-cut line, peel the backing from the cleaning sheet (see figure 1).
- 2 Load the cleaning sheet into the magazine tray so that the cleaning sheet is slid above the front guide pins, but below the back guide pins. The front edge of the paper should stay above the front guides (see figure 2).
- 3 Press the Mode button on the machine until "CLEAN" appears in the LCD (see figure 3).
- 4 Press the Set button to feed the cleaning sheet. The cleaning sheet will automatically be fed out from the exit slot.

Cleaning the ID label rollers

Sheet 2

- 1 Peel off the backing at the pre-cut line.
- 2 Load the cleaning sheet into the ID label slot so that the front side faces up (see figure 4).
- 3 Press the Mode button until "CLEAN" appears in the LCD, and then press the Set button to feed the cleaning sheet.

NOTE: Never reuse a cleaning sheet.

Do not use a cleaning sheet that has been folded or damaged or has had any part of the paper other than the pre-cut section removed.

NOTE: Store unused cleaning sheets in their packages and do not expose them to high temperatures, high humidity or direct sunlight.

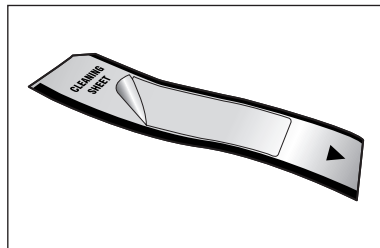

figure 1

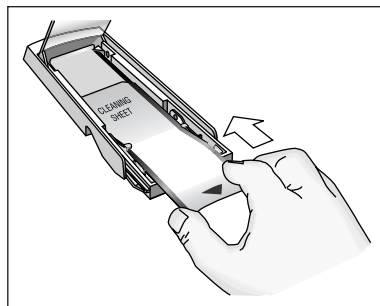

figure 2

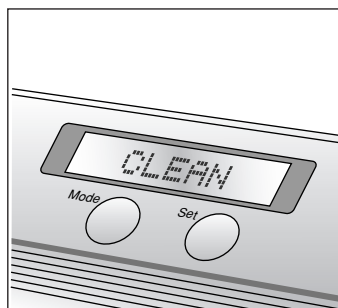

figure 3

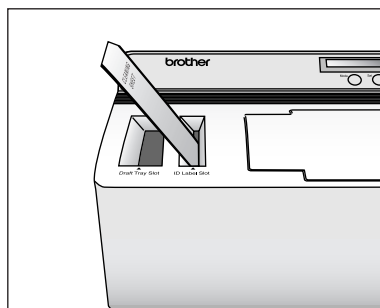

figure 4

Cleaning the Print Heads

The print heads require cleaning whenever you change the ribbon cassette.

- ① Turn off the machine.
 - ② Open the ink ribbon compartment cover.
 - ③ Pull back on the print head cover.
- The print heads are located on the thin gold-colored plate and are not visible to the naked eye.
- ④ Using a back-and-forth motion, use the print head cleaning pen (part no. PRCLPEN) to clean along the print head.

NOTE: Be careful not to touch the print head.

Keep the cap on the print head cleaning pen when it is not being used.

- ⑤ Release the print head cover and close the ink ribbon compartment cover.
- ⑥ Print again.

NOTE: If the characters are still blurred, repeat the above steps.

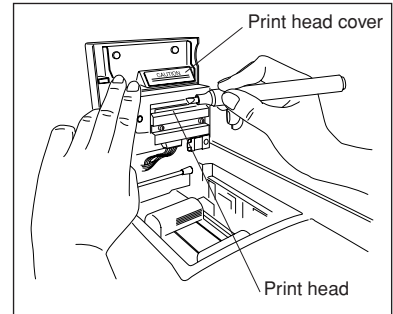

Replacing the xenon lamp unit

The xenon lamp has an approximate life of 2,000 flashes. The Stampcreator Pro will automatically count the flashes. When the message "REPLACE Xe UNIT" appears in the LCD, replace the xenon lamp unit even if the unit can still flash.

- ① Press the Mode button on the machine until the message "RESET COUNTER" appears in the LCD.
- ② Press the Set button to reset the xenon lamp counter.
- ③ Slide the xenon lamp unit release lever up and pull out the xenon lamp (part no. PRLAMP).
- ④ Fully insert the new xenon lamp unit until it locks into place. Check that "N = 0" appears in the LCD of the Stampcreator Pro.
- ⑤ Press the Set button on the Stampcreator Pro.

NOTE: Mark the used xenon lamp unit to identify the old one from the new one.

Do not touch the print heads.

Do not use cleaning devices other than the print head cleaning pen and cleaning sheets supplied with the Stampcreator Pro.

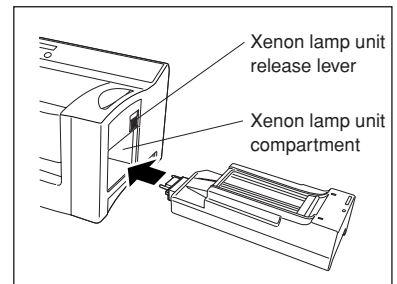

Removing a Jam and Correcting a Stamp

Removing a jammed draft sheet or ID label sheet

For a jam at the draft tray slot ("CHECK TRAY !" or "REMOVE LABEL" appears in the LCD):

- 1 Grab the outer case of the magazine tray, and then pull out the tray.

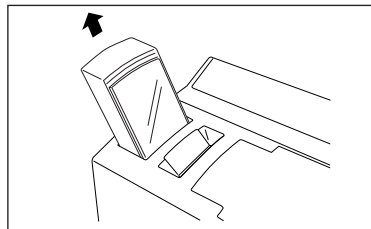

- 2 Pull out the jammed draft sheet.

NOTE: Do not pull too hard.

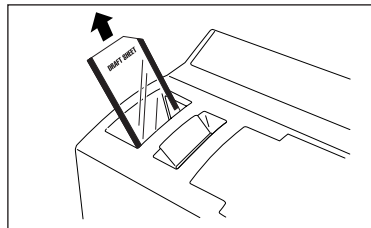

For a jam at the ID label slot ("REMOVE LABEL 1" or "CHANGE LABEL" appears in the LCD):

- 1 Slowly pull out the jammed draft sheet or ID label sheet.

NOTE: Do not pull too hard.

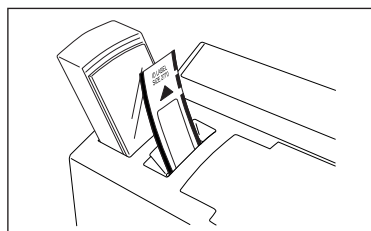

For a jam in the ink ribbon compartment ("REMOVE LABEL 1", "REMOVE LABEL 2" or "REMOVE LABEL 3" appears in the LCD):

- 1 Open the ink ribbon compartment cover and remove the ink ribbon cassette.
- 2 Slowly pull the jammed draft sheet or ID label sheet out of the ink ribbon compartment.

NOTE: Do not pull too hard.

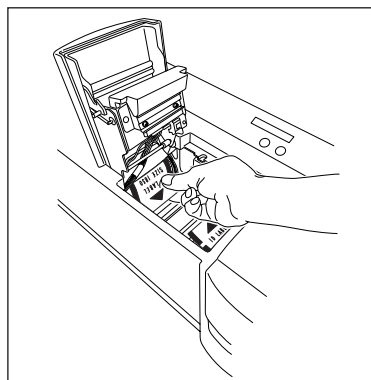
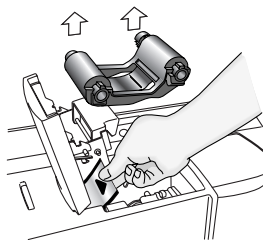

For a jam near the xenon lamp unit ("REMOVE LABEL 3" appears in the LCD):

- 1 Open the ink ribbon compartment cover.
- 2 Slide the xenon lamp unit release lever up and pull out the xenon lamp unit.
- 3 Put your hand into the xenon lamp compartment and slowly pull out the jammed draft sheet or ID label sheet.

NOTE: Do not insert your hand too far into the xenon lamp compartment. Do not pull too hard.

NOTE: Be sure to turn the machine off and let it cool before removing any jams.

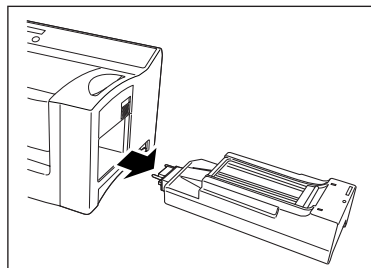

Refer to "Easy Reference Troubleshooting Guide" on pages 49-51.

Correcting an imperfect stamp surface

- Dust accumulating between the xenon lamp and the rubber surface of the stamp will prevent holes in the rubber from being properly filled in.
- The surface of the stamp can be corrected by filling in the holes using the correction pen (part no. PRCORRT).
- Remove the cap of the correction pen.
- On a piece of scrap paper, push the pen point down until liquid begins to flow.
- Apply the pen tip to the portion of the stamp surface that you wish to correct (see figure 1).
- You can also use the correction pen to make corrections if ink has run from the space between the glossy area and the non-glossy area around the printing surface (see figure 2).

NOTE: Do not try stamping until the correction fluid is completely dry.

Be sure to apply plenty of correction fluid to the areas that you wish to fill in. Keep the cap on the stamp correction pen when it is not being used.

NOTE: When applying the correction fluid, make sure that plenty of fluid covers the tip of the pen so that it creates a point in order to prevent the tip of the pen from rubbing off the area that is being corrected.

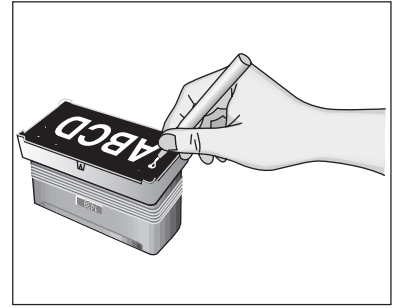

figure 1

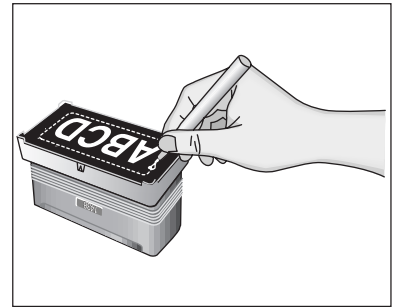

figure 2

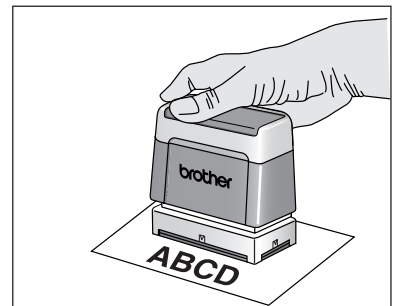

figure 3

Cure time imperfections

- Make sure that the image is correctly engraved in the rubber surface.
- For several hours, keep the ink pad in a warm place and in an upright position to ensure that it cures correctly (see figure 3).

Refilling the Stamp Ink

If the stamp is faint or incomplete, use the ink bottle (sold separately) to refill the ink.

- 1 Remove the holder from the stamp.

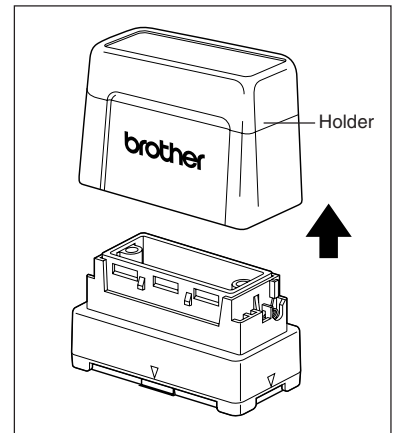

- 2 Use the ink bottle to add five drops of ink to each refill hole in the stamp.

NOTE: *Be extremely careful when adding ink.*

Do not use ink other than that specified, otherwise the stamp may be damaged.

If too much ink is added, it may start leaking from the stamp's surface. In that case, make a test stamp on scrap paper to remove any excess ink.

- 3 Put the holder back on the stamp.

NOTE: *Immediately after refilling the ink, keep the stamp facing down until the ink begins to flow from the stamp.*

After refilling the ink, be sure to put the cap back on the refill ink bottle.

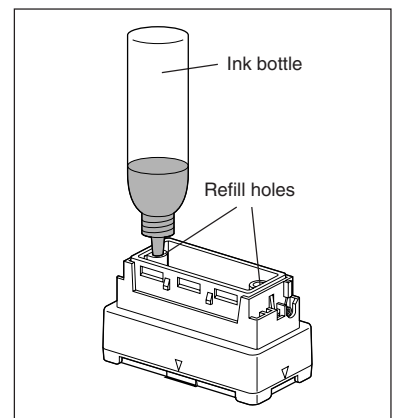

Easy Reference Trouble Shooting Guide

PROBLEM	SOLUTION
<ul style="list-style-type: none"> Nothing happens after the OK button is clicked in the Print dialog box. 	<ul style="list-style-type: none"> Delete the print job and after turning the machine off, then on again, try printing again.
<ul style="list-style-type: none"> The printed characters are blurred. 	<ul style="list-style-type: none"> Clean the print head. (See page 45.)
<ul style="list-style-type: none"> Some of the printed characters are missing. 	<ul style="list-style-type: none"> Clean the print head. (See page 45.) Check that there is no slack or wrinkles in the ink ribbon. (See page 12.) If there is dust, fingerprints, etc. on the draft sheet or ID label sheet, use a cleaning sheet. (See page 44.)
<ul style="list-style-type: none"> The characters are not printed on the ID label or engraved in the stamp in the correct position. 	<ul style="list-style-type: none"> Check that the ID label or stamp is the correct size. If the problem cannot be corrected, contact your service representative.
<ul style="list-style-type: none"> A draft sheet was not fed from the draft sheet magazine tray. 	<ul style="list-style-type: none"> Check that the draft sheet has been correctly loaded into the draft sheet magazine tray. (See page 13.) Check that no more than 50 draft sheets are loaded into the draft sheet magazine tray. Check that the draft sheet magazine tray has been fully inserted into the draft sheet magazine tray slot. (See page 13.) Clean the draft sheet rollers. (See page 44.)
<ul style="list-style-type: none"> The ID label sheet is not fed into the ID label slot. 	<ul style="list-style-type: none"> Check that the ID label sheet has been inserted into the ID label slot as far as possible. Check that the ID label sheet is inserted so that the words "ID LABEL" can be read. (See page 43.) Check that the ID label is the correct size. Clean the ID label rollers. (See page 44.)
<ul style="list-style-type: none"> The stamp cannot be inserted. 	<ul style="list-style-type: none"> Be sure to open the doors within the stamp compartment by pulling the lever toward you. (See page 40.) Check that the cap was removed from the stamp before trying to insert it. Check that the skirt is not attached to the stamp before trying to insert it. Check that the grip is not attached to the stamp before trying to insert it.
<ul style="list-style-type: none"> The draft sheet is fed out before the message "INSTALL STAMP !" is displayed. 	<ul style="list-style-type: none"> Turn off the machine, and wait a while before turning it back on and trying again to engrave a stamp.

PROBLEM	SOLUTION
<ul style="list-style-type: none"> The stamp could not be engraved. 	<ul style="list-style-type: none"> Check that the stamp is inserted correctly. (See page 41.) Check that the stamp is the correct size. (See page 40.) Check that the message "INSTALL STAMP !" appears in the LCD and that the printed draft sheet has stopped over the xenon lamp unit. Check that the stamp compartment cover is closed so that it locks. (See page 41.) If the problem cannot be corrected, contact your service representative.
<ul style="list-style-type: none"> The xenon lamp flashed, but the desired stamp could not be engraved. 	<ul style="list-style-type: none"> Check that the cap was removed from the stamp before it was inserted. (See page 40.) Check that there is no dust on the protective film covering the surface of the stamp. Check that the clear plastic surface of the xenon lamp unit is not dirty. Check that the printed draft sheet stopped over the xenon lamp unit before trying to engrave a stamp. The lines in the layout are too thin, the text is too small, or the fill pattern is too detailed. Replace the xenon lamp unit. (See page 45.)
<ul style="list-style-type: none"> The stamp was engraved too much. 	<ul style="list-style-type: none"> The layout is too detailed.
<ul style="list-style-type: none"> The stamp was not engraved well enough. 	<ul style="list-style-type: none"> Check that the clear plastic surface of the xenon lamp unit is not dirty. Replace the xenon lamp unit. (See page 45.)
<ul style="list-style-type: none"> Half of the stamp was either engraved too much or not enough. 	<ul style="list-style-type: none"> Check that the stamp is inserted so that its surface lies flat on the printed draft sheet before being engraved. (See page 40.)
<ul style="list-style-type: none"> The stamp is attached to the printed draft sheet. 	<ul style="list-style-type: none"> Check that the protective film was not peeled off the surface of the stamp before it was engraved.
<ul style="list-style-type: none"> The draft sheet is not fed out after the stamp is engraved (the xenon lamp flashed). 	<ul style="list-style-type: none"> Check that the draft sheet feeds out automatically the next time that an ID label sheet or another draft sheet is printed.
<ul style="list-style-type: none"> The draft sheet or ID label sheet is jammed within the unit or the error message "REMOVE LABEL 1", "REMOVE LABEL 2", or "REMOVE LABEL 3" appears in the LCD. 	<ul style="list-style-type: none"> Turn off the machine, and then remove the jammed draft sheet or ID label sheet. (See page 46.)

Error message list

MESSAGE	SOLUTION
CLOSE COVER !	<ul style="list-style-type: none"> • Close the ink ribbon compartment cover.
CHECK RIBBON !	<ul style="list-style-type: none"> • Install the ink ribbon cassette. • Replace the ink ribbon cassette.
INSTALL Xe UNIT	<ul style="list-style-type: none"> • Install the xenon lamp unit.
REPLACE Xe UNIT	<ul style="list-style-type: none"> • Replace the xenon lamp unit.
INSERT LABEL !	<ul style="list-style-type: none"> • Insert an ID label sheet into the ID label slot.
CHANGE LABEL !	<ul style="list-style-type: none"> • Correctly insert the specified draft sheet or ID label sheet into the ID label slot.
REMOVE LABEL 1	<ul style="list-style-type: none"> • Remove the draft sheet or ID label sheet from the ID label slot, or pull out the draft sheet magazine tray and remove the draft sheet.
REMOVE LABEL 2	<ul style="list-style-type: none"> • Open the ink ribbon compartment cover, and then remove the draft sheet or ID label sheet.
REMOVE LABEL 3	<ul style="list-style-type: none"> • Open the ink ribbon compartment cover, remove the xenon lamp unit, and then remove the draft sheet or ID label sheet.
CHANGE STAMP !	<ul style="list-style-type: none"> • Insert a stamp that is the correct size.
RESET STAMP !	<ul style="list-style-type: none"> • Re-insert the stamp.
I/F ERROR !	<ul style="list-style-type: none"> • Check the interface cable connections. • For Serial connection only, check the COM port settings on the PC. Bits per second : 115200 Data bits : 8 Parity : None Stop bits : 1 Flow Control : Hardware • Contact your service representative.
CACHE FULL !	<ul style="list-style-type: none"> • Check the interface cable connections. • Contact your service representative.
SRAM DEFECT !	<ul style="list-style-type: none"> • Contact your service representative.
HEAD ERROR !	<ul style="list-style-type: none"> • Contact your service representative.
Xe UNIT ERROR !	<ul style="list-style-type: none"> • Replace the xenon lamp unit. • Contact your service representative.
SIZE PCB ERROR!	<ul style="list-style-type: none"> • Contact your service representative.
CHECK TRAY !	<ul style="list-style-type: none"> • Load draft sheets into the draft sheet magazine tray, and then insert the draft sheet magazine tray into the draft sheet magazine tray slot. • Clean the draft sheet rollers using a cleaning sheet. • Contact your service representative.
CHARGE ERROR !	<ul style="list-style-type: none"> • Turn off the machine, and wait for one minute before turning on the machine and trying to print again.

SUPPLIES & ACCESSORIES

Stamp Ordering Information

How to order stamps

1. Choose the size.



2. Choose the ink color



STAMP NUMBER	SIZE	PART NUMBER			
	inch/mm	COLOR			
		Black	Red	Blue	Green
1438	14 X 38/0.55 X 1.50	PR1438B	PR1438R	PR1438E	PR1438G
1850	18 X 50/0.71 X 1.97	PR1850B	PR1850R	PR1850E	PR1850G
2260	22 X 60/0.87 X 2.36	PR2260B	PR2260R	PR2260E	PR2260G
2770	27 X 70/1.06 X 2.76	PR2770B	PR2770R	PR2770E	PR2770G
4090	40 X 90/1.57 X 3.54	PR4090B	PR4090R	PR4090E	PR4090G
1212	12 X 12/0.47 X 0.47	PR1212B	PR1212R	PR1212E	PR1212G
2020	20 X 20/0.79 X 0.79	PR2020B	PR2020R	PR2020E	PR2020G
3030	30 X 30/1.18 X 1.18	PR3030B	PR3030R	PR3030E	PR3030G
4040	40 X 40/1.57 X 1.57	PR4040B	PR4040R	PR4040E	PR4040G
1060	10 X 60/0.39 X 2.36	PR1060B	PR1060R	PR1060E	PR1060G
3458	34 X 58/1.34 X 2.28	PR3458B	PR3458R	PR3458E	PR3458G

Stamp samples



PR1060

- 0.37" x 2.36"; 10 x 60 mm
- Web & e-mail address stamp
- Short message stamp



PR1212

- 0.47" x 0.47"; 12 x 12 mm
- ID stamp
- Check and inspection stamp
- Mark stamp

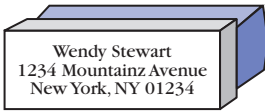

PR1438

- .55" x 1.50"; 14 x 38 mm
- 3-line home address stamp

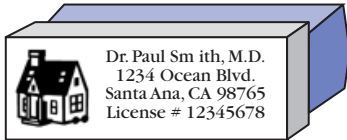

PR1850

- .71" x 1.97"; 18 x 50 mm
- Address stamp with doctor's ID no.
- 3-line address stamp



PR2020

- 0.79" x 0.79"; 20 x 20 mm
- Short message stamp
- Mark stamp

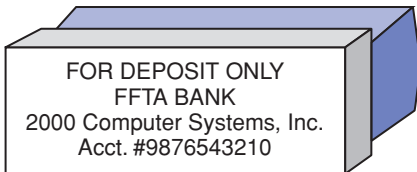

PR2260

- 0.87" x 2.36"; 22 x 60 mm
- 3- to 4-line address stamp
- Check endorsement stamp
- Address stamp with small logo
- Short message (bold) stamp



PR2770

- 1.06" x 2.76"; 27 x 70 mm
- 4- to 6-line business address stamp
- Address stamp with logo
- Signature stamp
- Bank account stamp

PR3030

- 1.18" x 1.18"; 30 x 30 mm
- Photo stamp
- Void stamp
- Recycle mark stamp
- Picture stamp



PR3458

- 1.34"x 2.28"; 34 x 58 mm
- Bank account stamp
- Correction stamp
- Arts and crafts stamp
- Greeting message stamp

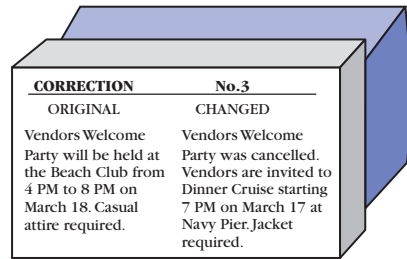

PR4040

- 1.57" x 1.57"; 40 x 40 mm
- Round stamp
- Post bulk rate stamp

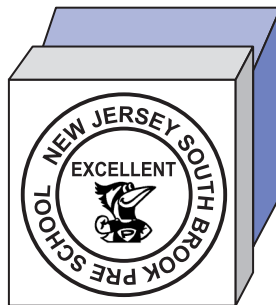

PR4090

- 1.57" x 3.54"; 40 x 90 mm
- 6- to 10-line stamp
- Long message
- Correction stamp
- Routing stamp
- Stamp with frame
- Large and short message stamp
- Business address stamp with logo



Supply items

ID label set

Each stamp box includes an ID label for each of the stamps plus 2 extra. The ID label set includes 12 ID-labels for each of the 11 stamp sizes. (part no. PRIDSET).

Draft set

A draft set contains one ink ribbon cassette and 150 draft sheets (3 bundles). One set will yield 150 stamps including ID labels. We recommend that you always keep at least one set in stock. Draft sheets are specially coated for optimum 600 dpi print quality (part no. PRDRFTN).

NOTE: Do not use any replacement products other than genuine Brother Stampcreator Pro items.

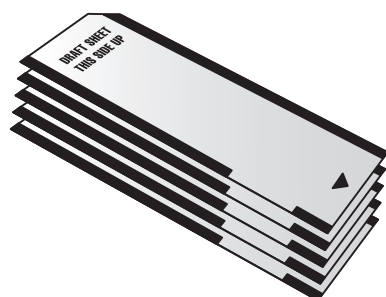
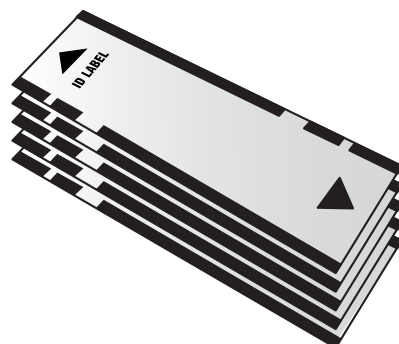

Supply Items

Item	Quantity/Yield	Reorder No.
ID Label Set	132 labels/12 labels for each of the 11 sizes	PRIDSET
Draft Set	1 ink ribbon cassette/150 stamps 150 draft sheets/150 stamps	PRDRFTN

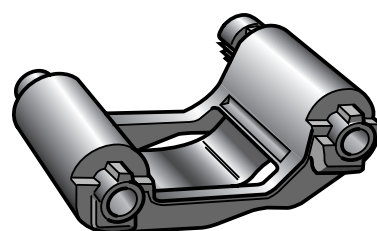

Maintenance items

Cleaning sheets

Use a cleaning sheet to clean the inside of the machine as indicated in this manual. Three cleaning sheets are provided for every 50 draft sheets.

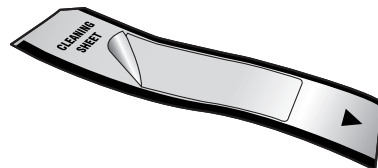

Print head cleaning pen

Use this cleaning pen to clean the inside components (like the print heads) of the machine.

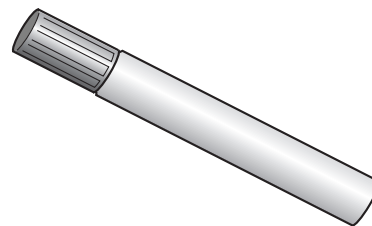

Stamp correction pen

Correct an imperfect stamp surface using this pen.

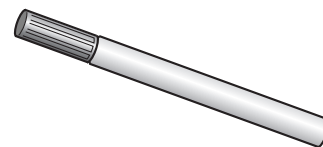

Xenon lamp unit

Used to engrave the stamps, the xenon lamp unit is good for approximately 2,000 stamp exposures.

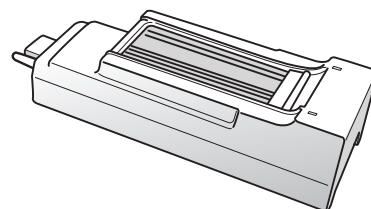

Maintenance Items

Item	Quantity/Pack	Reorder No.
Print head cleaning pen	1 pen	PRCLPEN
Stamp correction pen	1 pen	PRCORRT
Xenon lamp unit	1 lamp	PRLAMP

SUPPORT NUMBERS

For technical support, or service, warranty or repair information, dial our help line at:

877-Brother or 877-276-8437

brother®

FOR MORE INFORMATION PLEASE VISIT OUR WEB SITE AT
<http://www.brother.com>

BROTHER INTERNATIONAL CORPORATION

100 Somerset Corporate Blvd., Bridgewater, NJ 08807-0911

All specifications subject to change without notice.

All registered trademarks referenced herein are the property of their respective companies.

Printed in Japan
LBA907001

