



Questo manuale d'istruzione è fornito da trovaprezzi.it. Scopri tutte le offerte per [Canon imagePROGRAF TM-300 MFP L36ei](#) o cerca il tuo prodotto tra le [migliori offerte di Plotter](#)



Questo manuale d'istruzione è fornito da trovaprezzi.it. Scopri tutte le offerte per [Canon imagePROGRAF TM-300 MFP L36ei](#) o cerca il tuo prodotto tra le [migliori offerte di Plotter](#)



UD56T / UC56T

L24ei / L36ei Large Format Scanner

User Manual

V1.00



Contents

Warnings	5
Declaration of Conformity	6
Scanner Overview	7
Main Features	7
Scanner - Identification of parts	8
Unpacking	9
Box contents.	10
Fitting the scanner to the printer	11
Using the scanner on a desktop.....	13
Connecting the scanner	14
Operation	15
Power	15
LED	15
LCD Touch Screen/Menu navigation.....	15
Sleep mode	17
Information messages.....	17
Configuring the language of the scanner.....	18
Configuring the ScanApp Mode of the scanner.....	19
Configuring the network connection of the scanner.....	21
DHCP	21
Static IP Address.....	22
ScanApp Lei Installation.....	24
ScanApp Lei Operation.....	27
ScanApp Lei Error Messages	31
Configuring the scanner's devices	32
Configuring the Printers.....	32
Configuring the PCs.....	35
Operation	38
Loading documents into the scanner	38
Opening/Closing the scanner.....	39
Scan to USB: TIFF.....	40
Scan to USB (ScanApp Mode = Plus): PDF, JPG, M-PDF.....	42
Scan to PC	45

Copy – ScanApp Mode = Standard.....	49
Copy – ScanApp Mode = Plus.....	52
Copy & Archive.....	56
Operation: Function Settings.....	60
Operation: Saving your preferred Function Settings as power on Defaults.....	66
Application notes.....	67
Tightly curled documents.....	67
Recommended Function Settings.....	67
Document Carrier Sheets.....	68
Eliminating clipped copies.....	69
Scanner Settings.....	70
Saving Scanner Settings.....	72
Maintenance.....	73
Cleaning.....	73
Consumables.....	73
Calibration.....	74
Stitch Adjustment.....	76
Scan Length Adjustment (Automatic).....	78
Scan Length Adjustment.....	78
Loading Firmware.....	80
Troubleshooting.....	82
Error Codes.....	82
Operation errors.....	83
Document does not feed correctly.....	83
Scanner LED is not on.....	83
The scanner LED remains Orange when powered on.....	83
Scan or copy is blank.....	83
Scan to USB does not work.....	83
No Scan to PC output.....	83
No Copy output.....	83
Testing connectivity.....	84
Information for Network Administrators.....	84
Supported Configurations.....	85
Image Quality.....	86
Incorrect Scan or Copy length.....	87
Specifications.....	88

Glossary of Terms.....	90
Icon Guide L24ei / L36ei – Function Settings:.....	91
Icon Guide L24ei / L36ei – Scanner Settings:.....	92

Warnings

	<p>Do not drop the scanner. The scanner contains components that could be damaged by severe shock.</p>
	<p>Beware of trapping fingers when opening or closing the scanner.</p>
	<p>Beware of exposed electrical connectors if the covers are removed. No user serviceable parts inside.</p>
	<p>Keep the scanner out of direct sunlight.</p>
	<p>Do not shock the scanner. Use the supplied power supply only.</p>
	<p>Keep the scanner dry.</p>
	<p>Operating Environment: Relative humidity 10% - 90% Temperature 10C – 35C</p>

Declaration of Conformity

Manufacturer	Global Scanning Suzhou Co. Ltd #39 Dongjing Industrial Zone, #9 Dongfu Road, Suzhou Industrial Park, Suzhou, Jiangsu, 215123
Model: Product name: Function: Rating voltage: Rating current: Power supply:	UD56T, UC56T L24ei, L36ei Large Format Scanner 19V 3.42A FSP065-REBXX (X=0-9, A-Z or Blank)
Declaration of Conformity	Energy Star Argentina/S mark Australia/C-Tick National/CB Canada/ICES-003, CUL China/CCC India/BIS Japan/VCCI Korea/KCC Mexico/NOM-019-SCFI Russia/EAC EU/CE USA/FCC USA/UL
Warning:	This is a Class A product. In a domestic environment, this product may cause radio interference in which case the user may be required to take adequate measures.

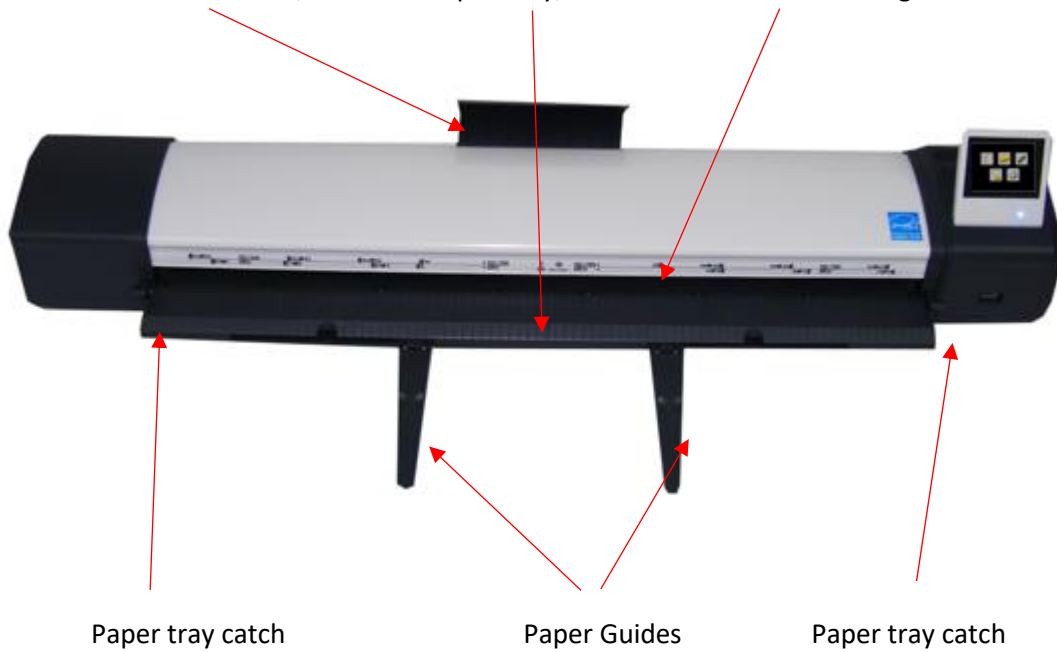
Scanner Overview

Main Features

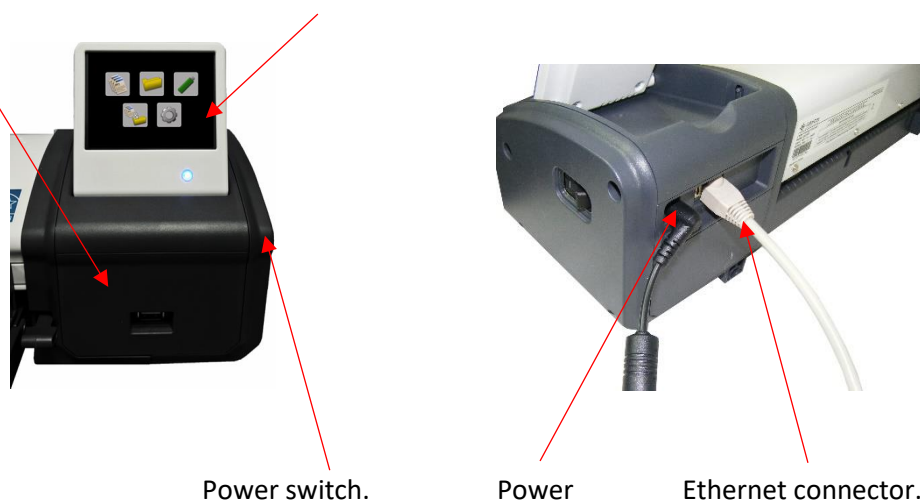
- Functions:
 - Scan to USB memory stick.
 - Scan to network connected PC.
 - Copy.
 - Copy & Archive.
- Touch Screen.
- Optical resolution: 600dpi.
- SingleSensor – patented single in-line image array.
- Dual sided LED illumination of original documents reduces the shadow effect occurring at creases and folds of the drawings.
- Single linear document hold-up flap to help smooth out creases.
- Face-up scanner with imaging width: L24ei = 24" (610mm) or L36ei = 36" (914mm).
- Maximum document width: L24ei = 26" (660mm) or L36ei = 38" (965mm).
- Ultra-light weight scanner.

Scanner - Identification of parts

- Document Return Guides, Paper Tray, Document size guide



- USB stick slot, User Interface (UI) – LCD touch screen.



- A pair of Magnetic Document Edge Guides are supplied and can be positioned on the paper tray to help align and position a document. They are marked as L=Left and R=Right.



Unpacking

- With the scanner box on the floor, or a suitable large table, remove the top of the cardboard box.



- Remove the Calibration target and keep it in a safe place for future use. (It is protected inside a cardboard sleeve inside a sealed plastic bag).



- Remove the packing from the top of the scanner and remove the scanner from its protective plastic bag and place on a suitable table.

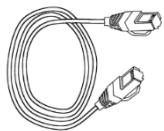






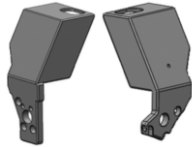


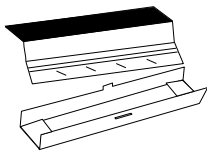






- Remove the transit tape from the scanner. Using the two levers, carefully open the scanner and remove the foam packing strip from inside the scanner. Close the scanner by lifting the paper tray with both hands until the two levers click into the locked position.



Box contents.

- Unpack & check the remaining contents of the box, so as not to throw away important item with the packaging.

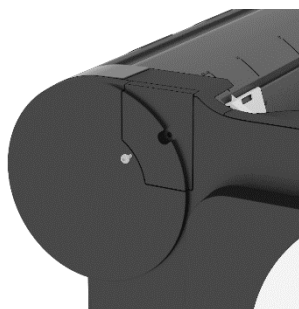
Item	Description	Qty.	Item	Description	Qty.
	Ethernet Cable	1		Screw Hexagon Socket Button Head M4x10	6
	Mains Cable	1		Thumb screw	2
	Power Supply	1		Cable clip	1
	3mm Hex Tool	1		Scanner mounting brackets 1 x Left side 1 x right side	2
	PC Software & Documentation CD	1		L24ei/L36ei Scanner Quick Start Guide	1
	Calibration Target	1		Screw Hexagon Socket Head M4x35	2
Paper Edge Guides (Pair)		1	Desktop Feet (Pair)		1
	Document Return Guide(s)	1 for L24ei 3 for L36ei			

Fitting the scanner to the printer

- Install the scanner mounting brackets on the printer.
(Supported printers: iPF 670/671/770/771, TM-200/300/5200/5300).
Repeat the following steps for both sides of the printer.

- Remove the screw using the 3mm hex tool supplied.

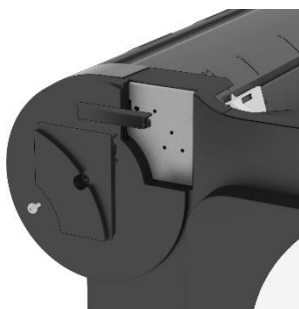
Left side:



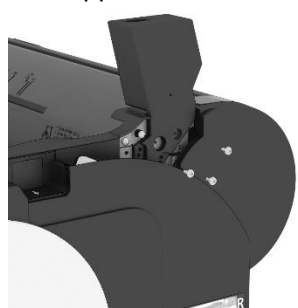
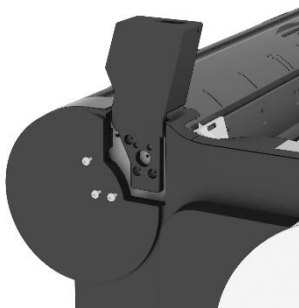
Right side:



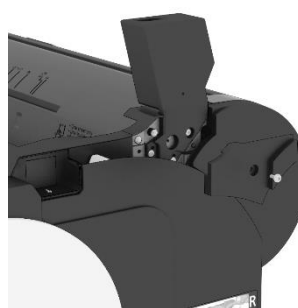
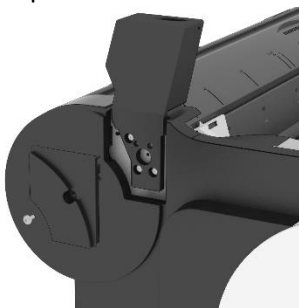
- Remove the 2 covers.



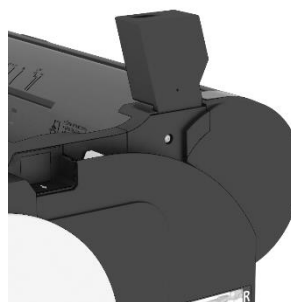
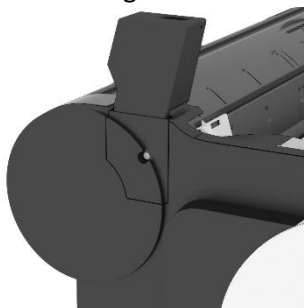
- Fit the scanner mount using 3 screws and 3mm hex tool supplied.



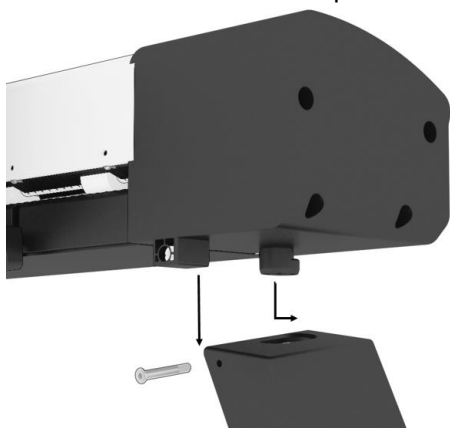
- Replace the lower cover.



- Left and right scanner mount fitment complete.

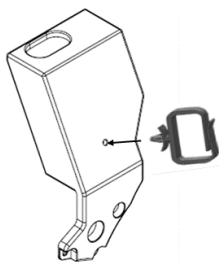


- Fit the scanner to the scanner mounting brackets. Locate the scanner's feet in the holes on top of the scanner mounts and pull the scanner to the front.



IMPORTANT: Secure in place using the 2 thumb screws provided. Failure to do so could result in the scanner falling off the mounts.

- Attach the cable clamp to the right-side scanner mounting bracket.

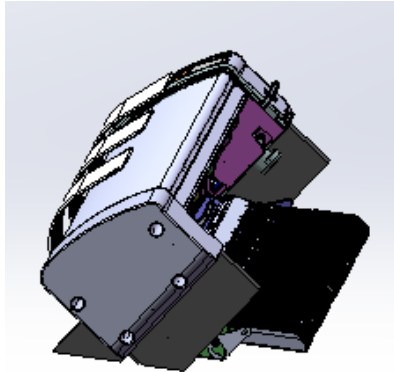


- Fit 1 document return guide to the rear of the scanner in the centre. For the L36ei, fit additional document return guides either side. (The L24ei has 1 document return guides. The L36ei has 3 in total).

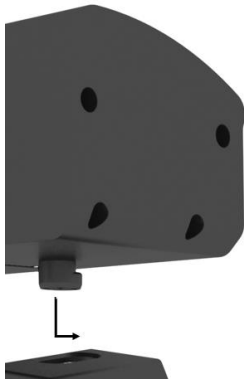


Using the scanner on a desktop

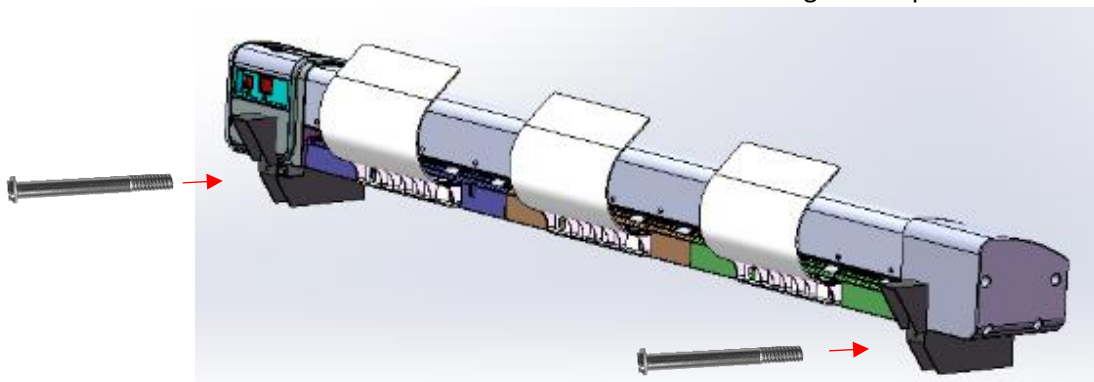
- To use the scanner on a desktop, fit the two feet. These include rubber pads to prevent the scanner sliding and allow the scanner to be tilted back for cleaning, without damaging the Document Return Guides or the cables.



- The feet are in 2 sections. The parts that fits under the scanner are slotted into the scanner's plastic feet. These are identical left & right.



- The rear sections are different left & right. The right side (as viewed from the front of the scanner) has a larger offset to go around the extra plastic housing where the cables connect. These sections are screwed to the lower sections with the 2 long screws provided.

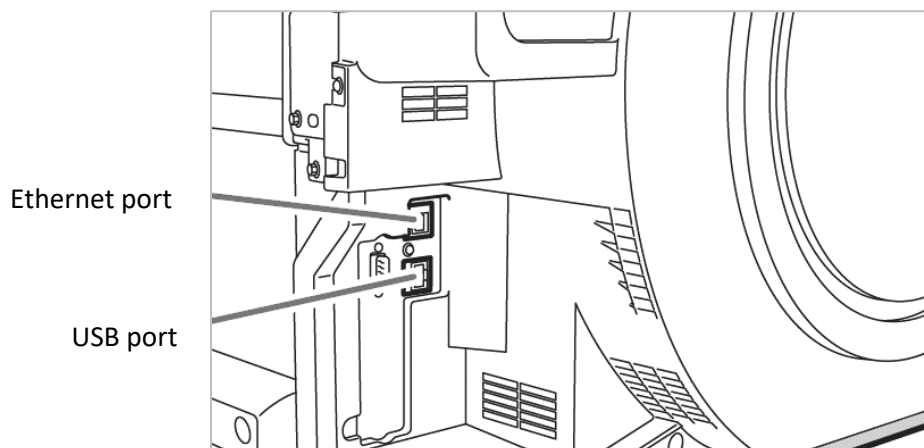


Connecting the scanner

- Connect the Ethernet cable to the rear of the scanner.
 - The scanner controller communicates with the printer over the network. (The printer must be installed on the network, on-line and ready for the system to be able to Copy). If the printer is NOT on the network, use a direct Ethernet cable connection from the scanner to the printer, but this is not the preferred connection as the system will not be able to Scan to PC.



- iPF printer connections



- Connect the power cable to the rear of the scanner and connect the power supply to the mains. Use the supplied power supply only. Pass the cables through the cable clamp on the right-side scanner mounting bracket.

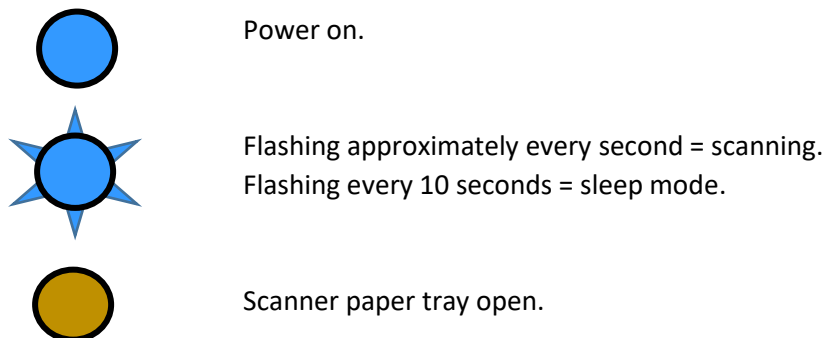


Operation

Power

- The scanner is powered on/off by the power switch on the right-hand end.
- When powered on, the amber LED will illuminate and after a few seconds, it turns blue and the LCD displays various icons. (If the LED remains amber, check the paper tray is closed correctly).

LED



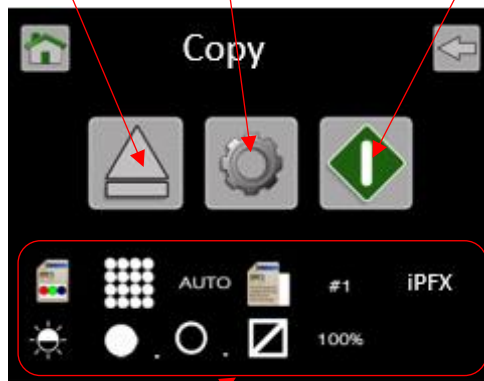
LCD Touch Screen/Menu navigation

Home page shows:



Function Page (Copy)

Eject, Function Settings, Start Function



Function (Copy) Settings

Power on factory default Function Settings:

Colour mode, Standard Quality, Auto-size, Portrait, Brightness=0, Black Point(BP)=1, White Point(WP)=1, Crop off, 100% Copy scale, 1 Copy, File Type, iPFX, PCX.

The defaults can be changed to your preferred Function Settings:

See [Functionality – Saving your preferred Function Settings as power on Defaults](#)

Press an icon to enter a menu (A white box indicates it has been selected).



Use the left & right arrows when available to scroll to more options.



Home = Go to Home page. Cancels any changes if in a Function Settings Menu.



Back = Go back up 1 level.



Tick = Save selection and go back up 1 level.

The Functions Settings Icons at the bottom of the screen are also active and provide a shortcut directly to that menu.

Sleep mode

- The scanner complies with the Energy Star standard, so will enter sleep mode after 15 minutes of no use to save electricity. (The time cannot be changed or the feature disabled).
- When in sleep mode, the scanner consumes very little power. It will flash the Blue LED every 10 seconds.
- To exit sleep mode, press the touch screen.

Information messages



Scanner working



Scanner open: The paper tray is open, close the scanner.



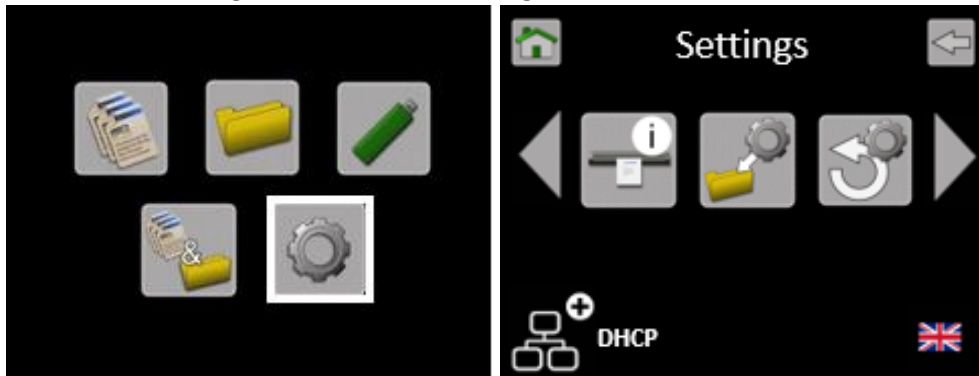
No Document loaded: Load a document



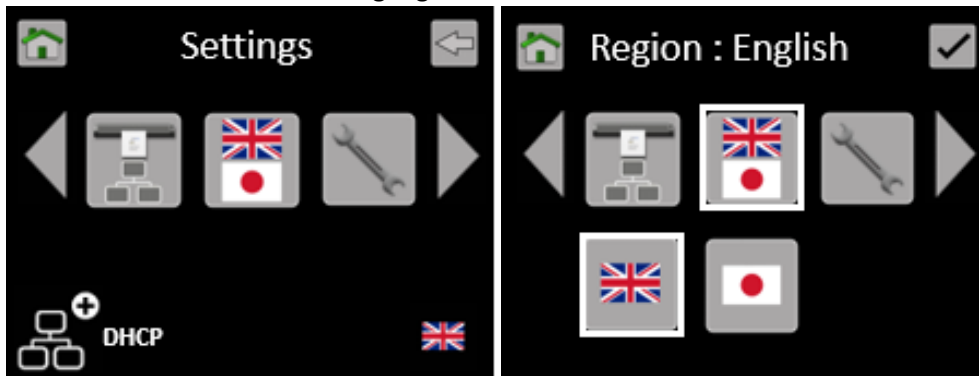
Dirty scanner: Clean scanner.

Configuring the language of the scanner

- Turn on the power switch on the side of the scanner.
- From the Home Page, select Scanner Settings.



Scroll to the left and select Language.



- Select Language.



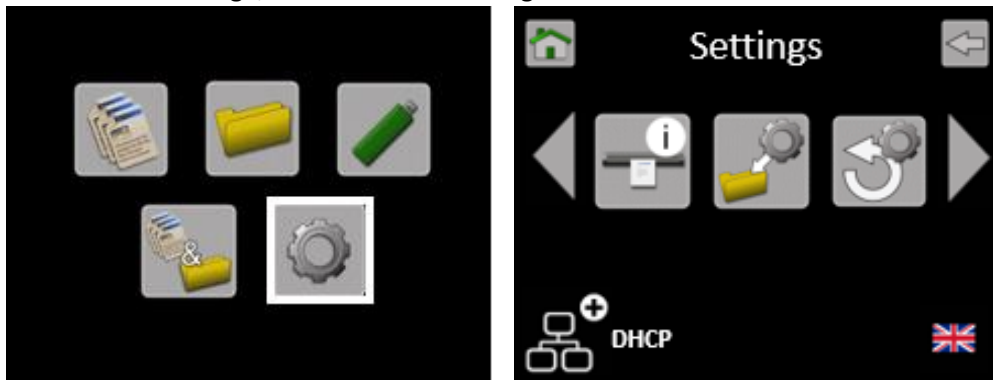
- English Text (Sets ScanApp Mode = Plus)



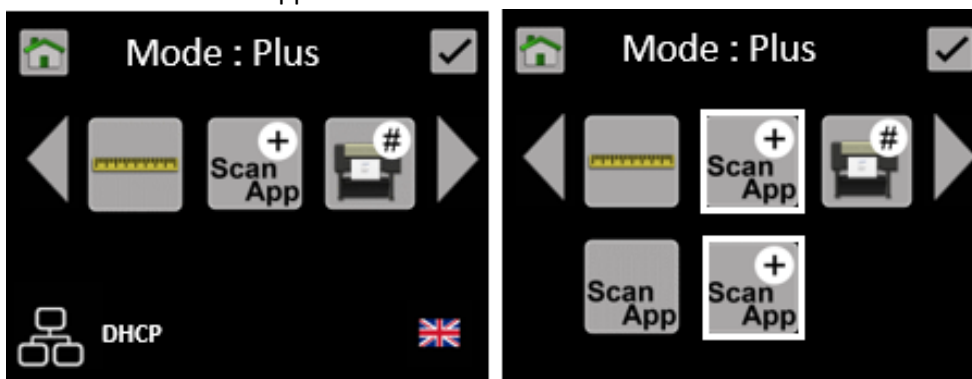
- Japanese Text (Sets ScanApp Mode = Standard)

Configuring the ScanApp Mode of the scanner

- From the Home Page, select Scanner Settings.



Scroll and select ScanApp Mode.



- Select ScanApp Mode.



Plus Mode (Default for English language). The ScanApp Lei is used to add functionality & productivity. If there is more than 1 PC running the ScanApp Lei, the preferred Plus PC can be set.

- (1) Copy – The scan data is transferred to the PC while scanning to make the scanner available for the next job sooner. The ScanApp Lei spools the jobs and sends the print data to the printer.
- (2) Scan to USB – File types: PDF, PDF/A, M-PDF & JPG. The scan data is sent to the PC where the ScanApp Lei compresses and sends the scan file back to the USB in the scanner. Plus mode is used automatically when PDF, PDF/A, M-PDF & JPG are selected



Standard Mode (Default for Japanese language). No PC is required.

- (1) Copy – The scanner will transfer data direct to the printer. The scanner has to wait for the printer to finish before the next job can be started.
- (2) Scan to USB – TIFF ONLY. Scan data is stored internally on the scanner, and then transferred to the USB.

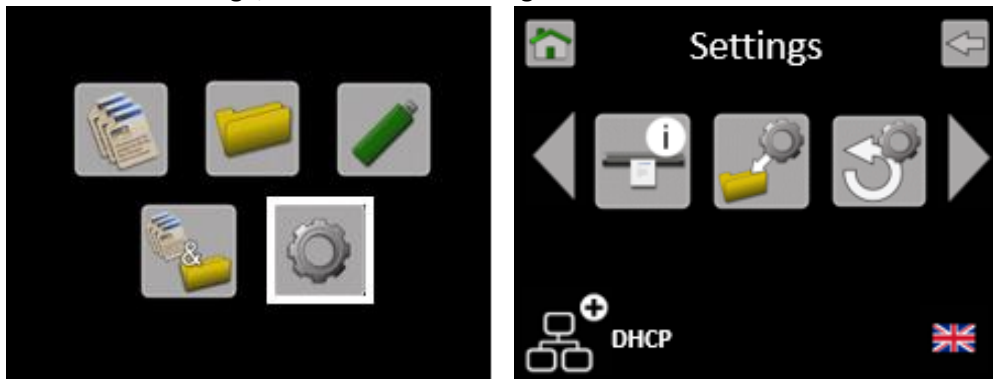
ScanApp Mode Standard/Plus does not affect the following functions:

- (1) Scan to PC – The scan data is sent to the PC. The ScanApp Lei compresses and saves the file.
- (2) Copy & Archive - The scan data is sent to the PC. The ScanApp Lei compresses and saves the file and sends the print data to the printer.

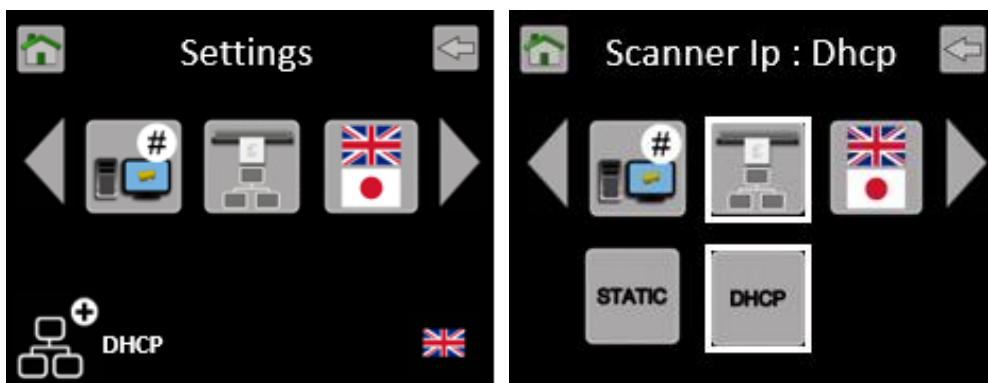
Configuring the network connection of the scanner

DHCP

- From the Home Page, select Scanner Settings.



- Scroll and select the scanner Network Icon, then DHCP.



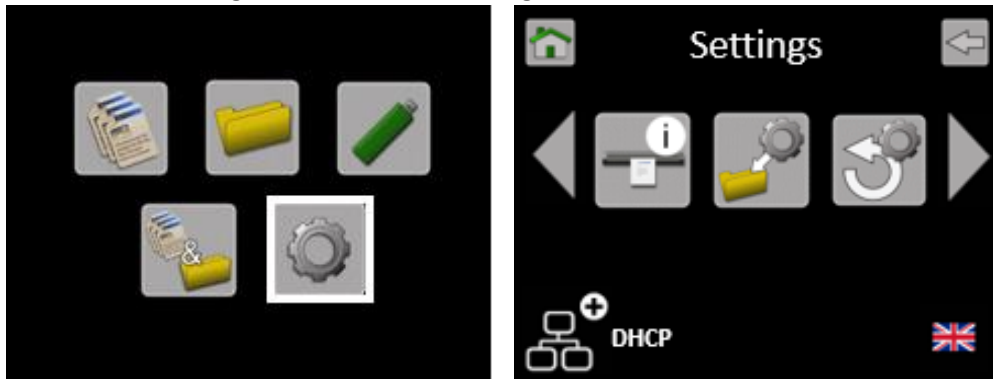
- After selecting DHCP, the scanner will request an IP address from the server and then display it automatically.



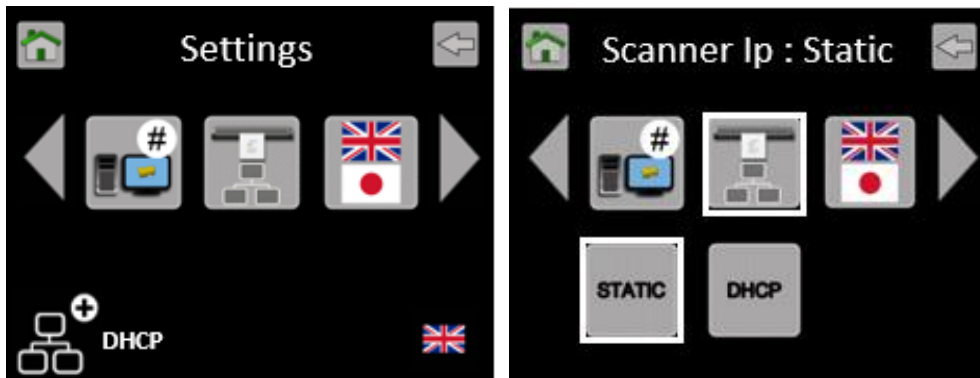
Use the Home button to exit.

Static IP Address

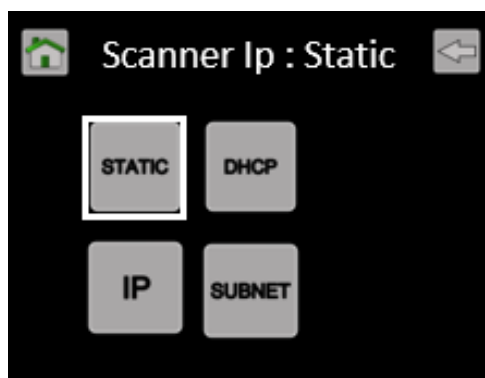
- A static IP address and subnet mask should be entered and configured by your network administrator or IT support provider.
- From the Home Page, select Scanner Settings.



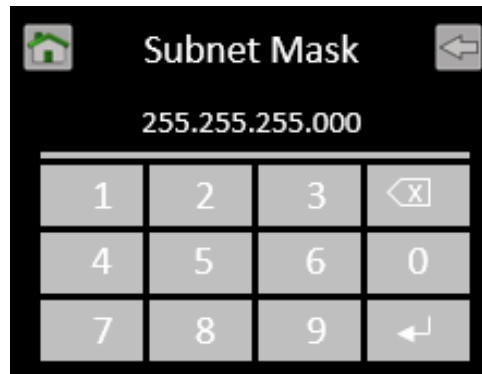
- Scroll and select the scanner Network Icon.



- Select Static.



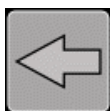
- Select IP or Mask to enter the required values.



Use the Delete Key, to remove the current address, and type in the new address including all "0s".



Press the Enter key to save.



Cancel - Back up 1 level. Cancel number entry and exit this menu.



Home. Back to Home screen. Cancel number entry and exit this menu.

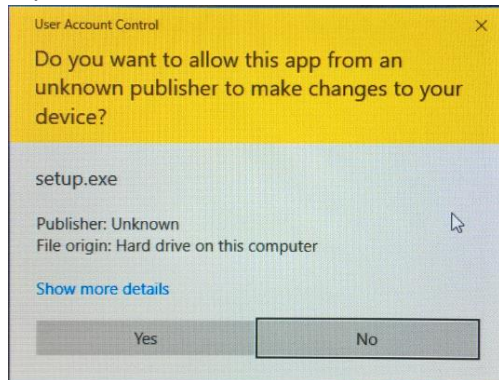
ScanApp Lei Installation

- Identify network connected PCs on which to install the ScanApp Lei. The PC needs to be on and the ScanApp Lei running to allow the scanner to Scan to PC.

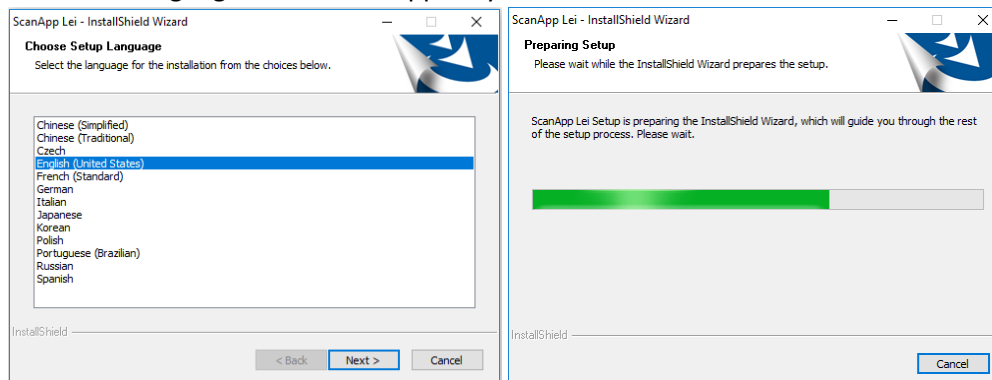
Insert the CD into the selected PC and the installation will automatically start.

Note: You can install the ScanApp Lei on many PCs.

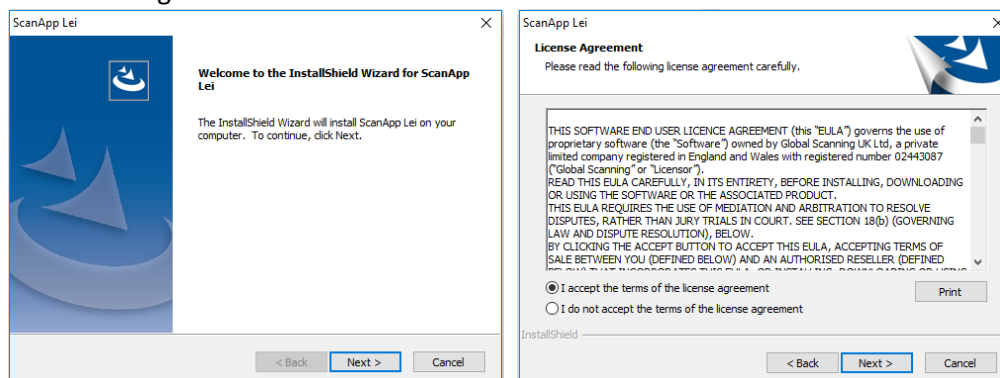
- If your PC shows a User Account Control warning, select Yes to allow the app to run.



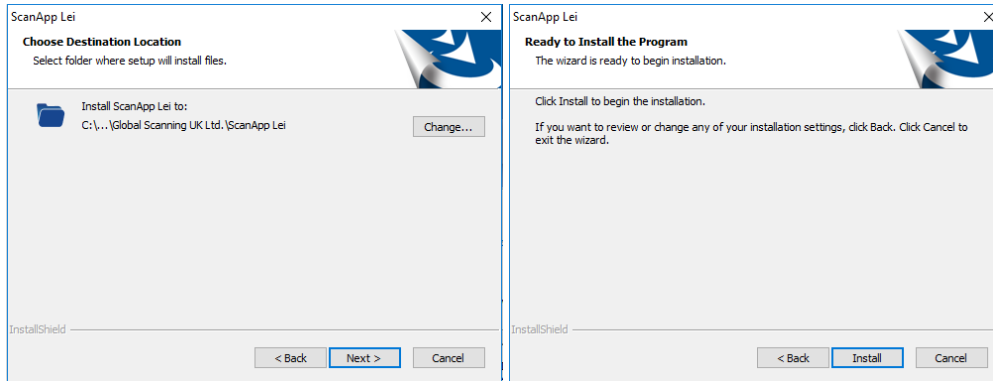
- Select the language for the ScanApp Lei you wish to install. Select Next.



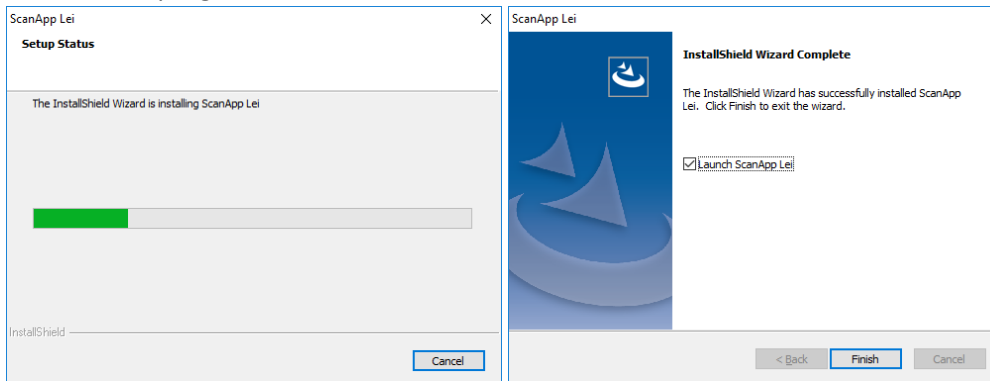
- Select Next. Read the end user license agreement and, if you agree, select “I accept the terms of the license agreement” and select Next.



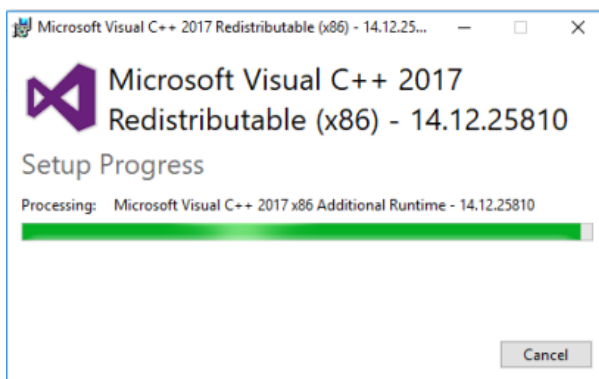
- Select Next. Select Next.



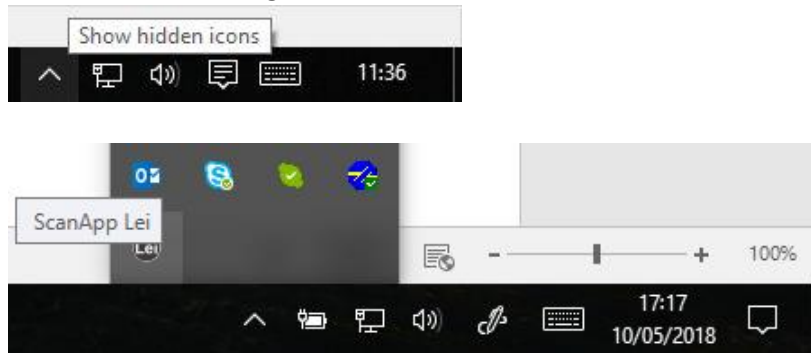
- Wait for the program to install, then select Finish.



- If your PC does not already include Microsoft's® Visual C++ Redistributable files, the following install Windows will appear.
(If you do not see these Windows, it is not a problem. It means the PC has these components installed already).



- Browse to the Documents folder on the CD. This folder contains the L24ei/L36ei User Manuals and software release notes. Please read and / or print the documents.
- The ScanApp Lei will run as a Windows® Tray App and will start automatically every time the PC is started. The ScanApp Lei interface window can be displayed by selecting the Show Hidden Icons in the bottom right hand corner of the PC screen.

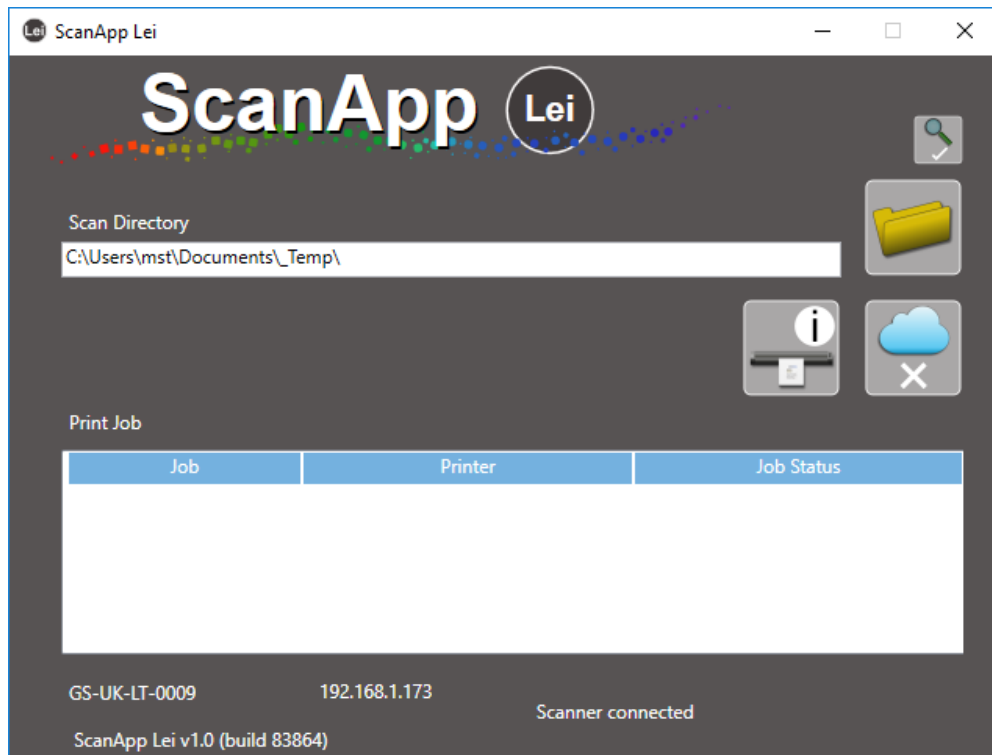


You can right click the icon and click Restore to Open the ScanApp Lei window. Selecting Exit will stop the ScanApp Lei and prevent it from receiving Scan to PC scan files.



ScanApp Lei Operation

- Start the ScanApp Lei.



- The hostname of the PC running the ScanApp Lei is displayed (in this example GS-UK-LT-0009). The hostname is displayed on the L24ei/L36ei scanner when it searches for the PCs running this software.
- The IP address of the PC running the ScanApp Lei is displayed (in this case 192.168.1.173). Note: If the PC has more than 1 network connection it is possible the ScanApp Lei picks up the IP address for the wrong subnet. In this case start the ScanApp Lei with only the required network connection active. Once the ScanApp Lei has connected to the correct subnet, the other network connections can be started.
- The ScanApp Lei can display PDF files on receipt using the default PDF viewer on the PC.



PDF preview On



PDF preview Off



- Browse to select your preferred Scan to PC destination folder.
- Cloud connectivity. Please ensure Direct Print & Share has been installed on the PC.



Cloud connection disabled.

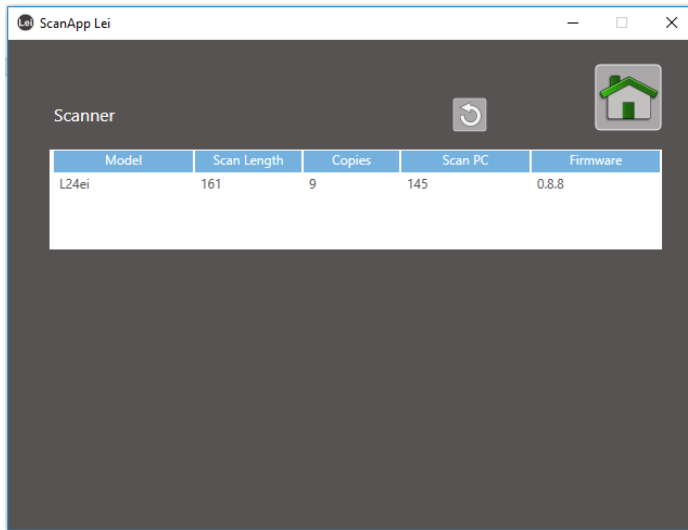


Cloud enabled = scan files sent to Direct Print & Share ready to upload.

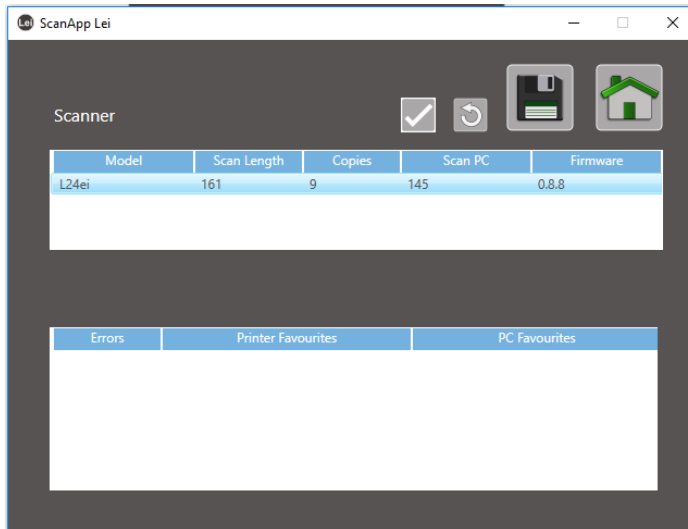
- The Print Job lists the copies being spooled from the scanner when Copying in Network Mode = Plus. (If the ScanApp Lei is not running, then the scanner will do its own print spooling).



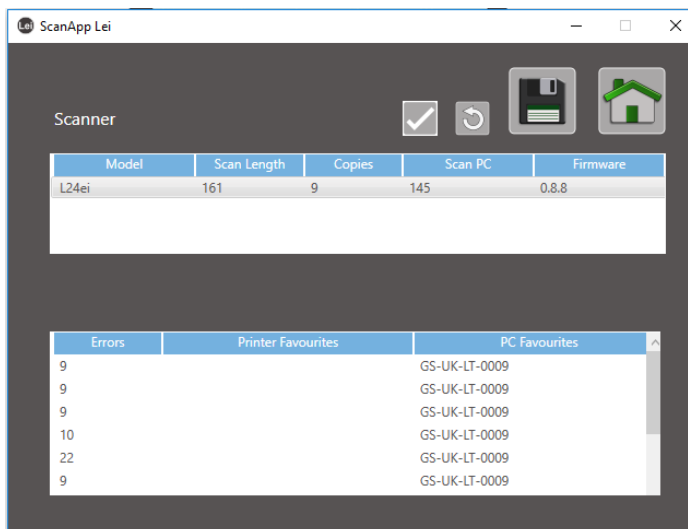
- Scanner Information. Lists all available L24ei / L36ei scanners on the subnet.



Select the scanner you wish to review.



Select it



ScanApp Lei Error Messages

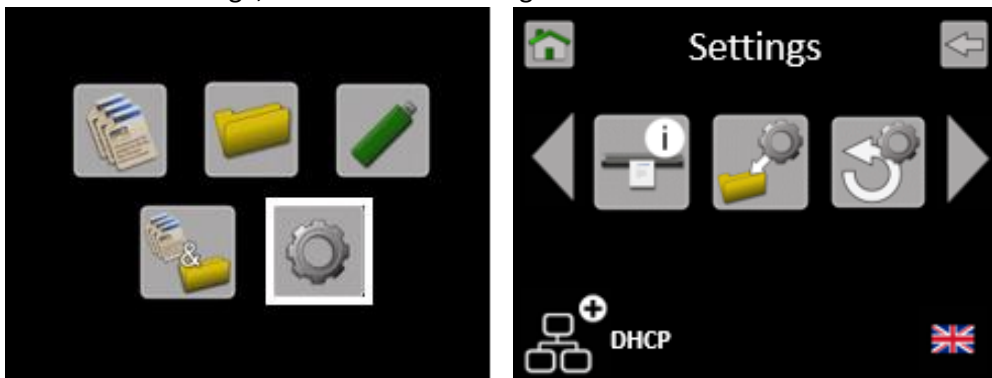
Message	User Action
Please Connect to a Supported Printer.	The ScanApp Lei will needs at least one of the supported printers to be present on the network and checks periodically for the printer. This will not normally affect use of the system, but on occasion you may see this message. To eliminate this message, power on the printer, then press the Refresh button in the ScanApp Lei.
No Scanners Found Error.	The ScanApp Lei is unable to connect to the scanner. See Operational errors .
No Printers Found Error.	The ScanApp Lei is unable to connect to the scanner. See Operational errors .
Internet Connection Error.	Power cycle scanner and restart ScanApp Lei. If problem persists, call service.
Invalid File Error.	Power cycle scanner and restart ScanApp Lei. If problem persists, call service.
PDF File Error.	Power cycle scanner and restart ScanApp Lei. If problem persists, call service.
File Resend Error.	Power cycle scanner and restart ScanApp Lei. If problem persists, call service.

Configuring the scanner's devices

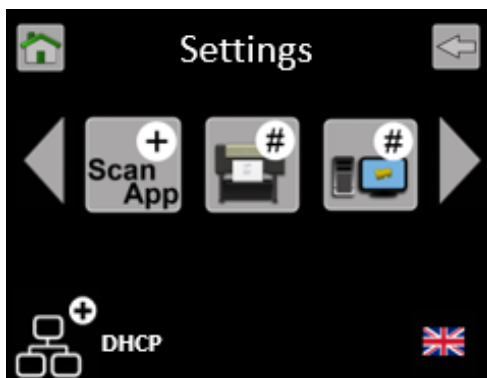
- The scanner can select a different printer for copying, or PC for scanning, for each individual operation. By default, the scanner will auto search for available devices on a per Copy/Scan basis. The scanner can auto search for up to a maximum of 15 printers or 15 PCs on the subnet.
- It is recommended to assign all devices numbers and set a preferred device, to prevent the scanner having to complete an Auto search before each operation. To achieve this, the scanner must first discover the available devices and assign them numbers. A list of discovered devices is stored on the scanner and re-established when the scanner is powered on. This list consists of MAC addresses which means it does not matter if the PC or printer has a new IP address next time around. The scanner can define numbers for a maximum of 9 printers or 9 PCs on the subnet.

Configuring the Printers

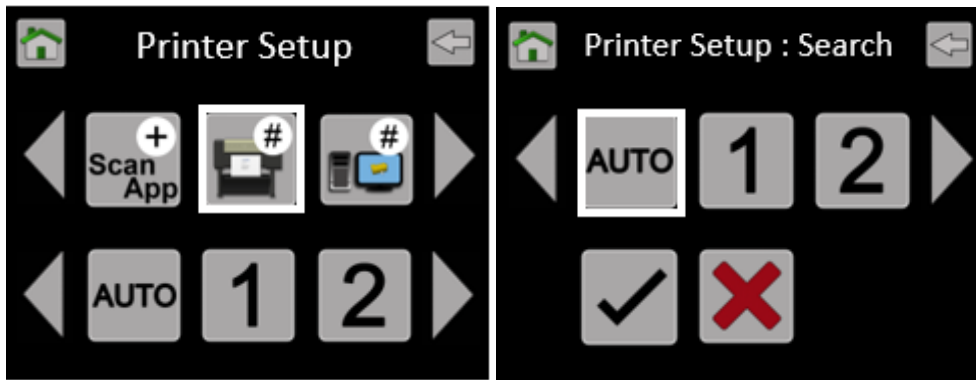
- To define the printers, we must first search for available devices on the network and assign them number. The printer can then be selected by this number.
- From the Home Page, select Scanner Settings.



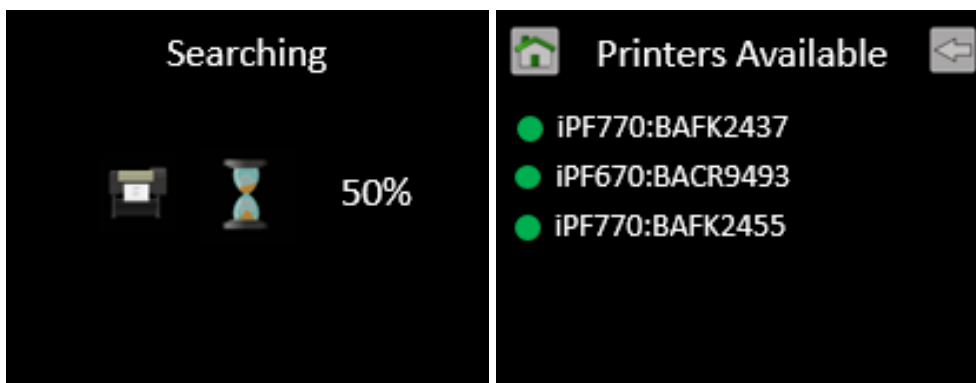
- Scroll and select iPF#.



- Select “Auto” followed by “tick” to start the search for available printers on the network.



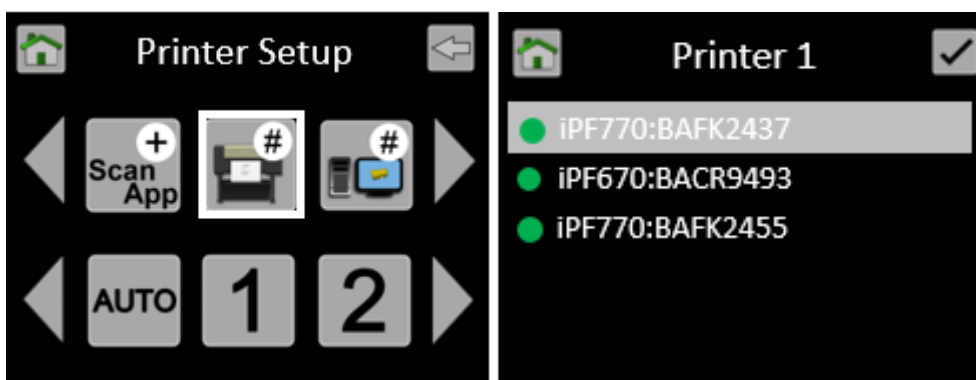
- Wait while the scanner searches for available supported iPF printers. It will then list the available printers by model and their Serial Number.



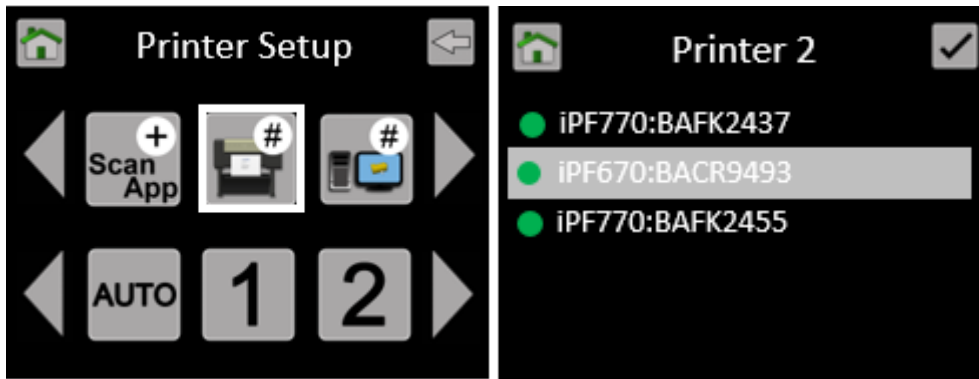
● The Green Dot indicates it is online.

● A red dot indicates it is offline.

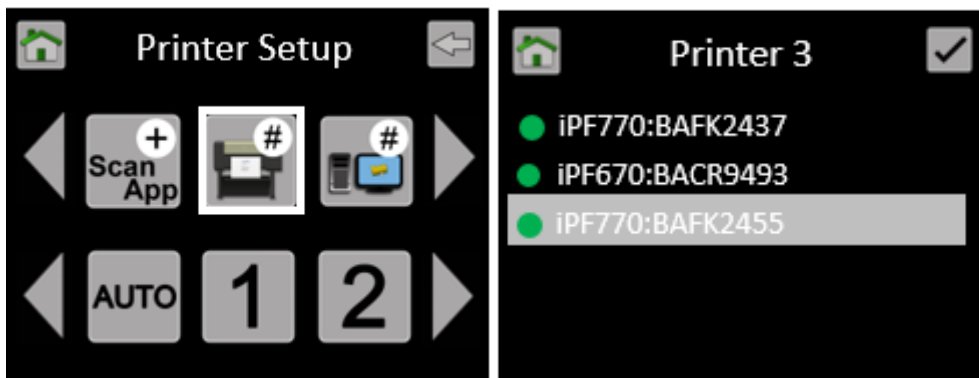
- Go back up to the Printer Setup menu to define printer numbers. Select “1”, then from the list, select the printer you wish to be assigned #1.



- Go back up to the Printer Setup menu to define printer numbers. Select “2”, then from the list, select the printer you wish to be assigned #2.



- Go back up to the Printer Setup menu to define printer numbers. Select “3”, then from the list, select the printer you wish to be assigned #3.

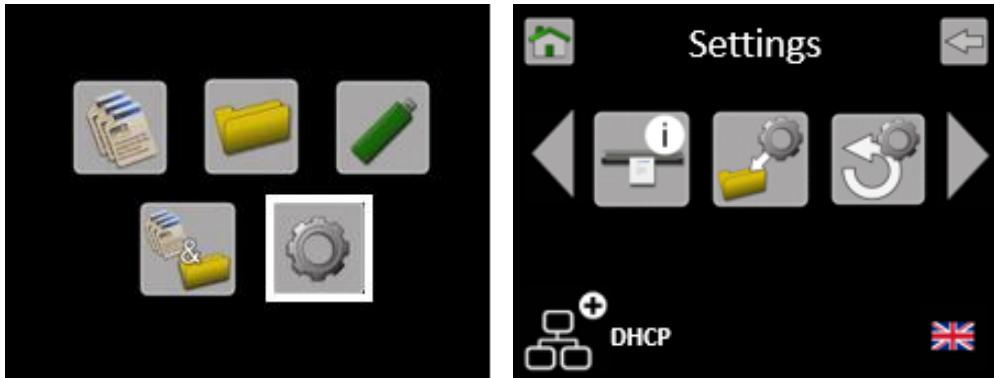


In this example, we have 3 available printers and we have set as follows:

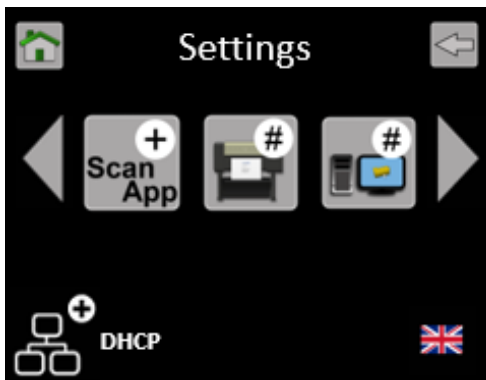
- Printer #1 = iPF670 S/N BAFK2437
- Printer #2 = iPF770 S/N BACR9493
- Printer #3 = iPF770 S/N BAFK2455

Configuring the PCs

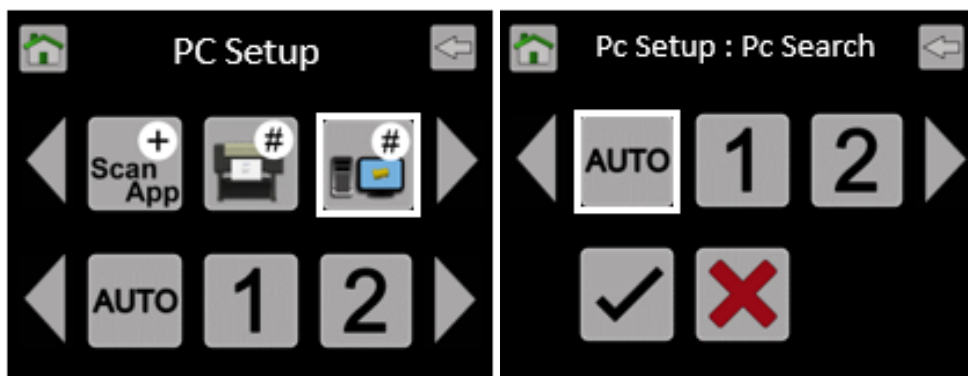
- To define the PCs, we must first search for available devices on the network and assign them number. The PC can then be selected by this number.
- From the Home Page, select Scanner Settings.



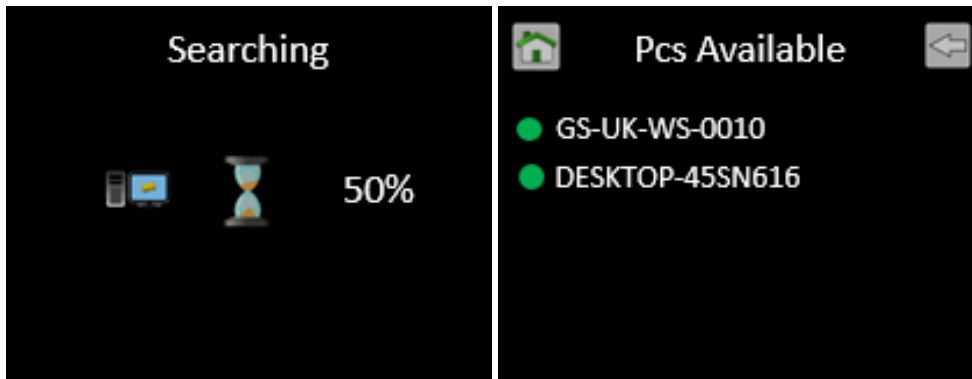
- Scroll and select PC#.



- Select "Auto" followed by "tick" to start the search for available printers on the network.



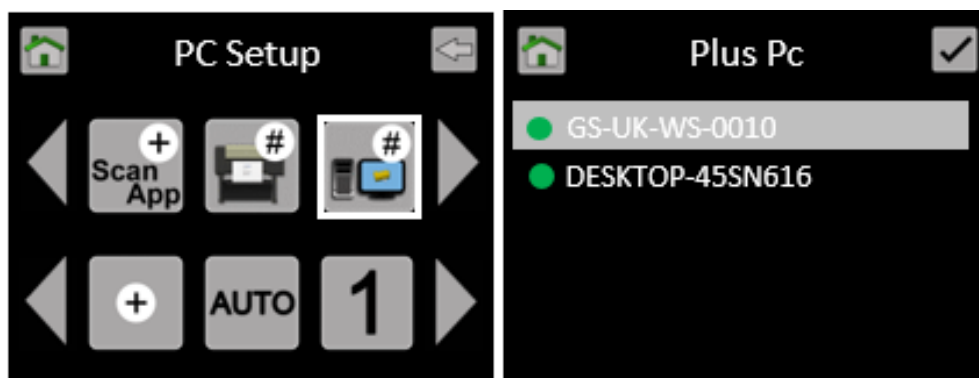
- Please wait while the scanner searches for available PC with the ScanApp Lei running. It will then list the available PCs by their PC name.



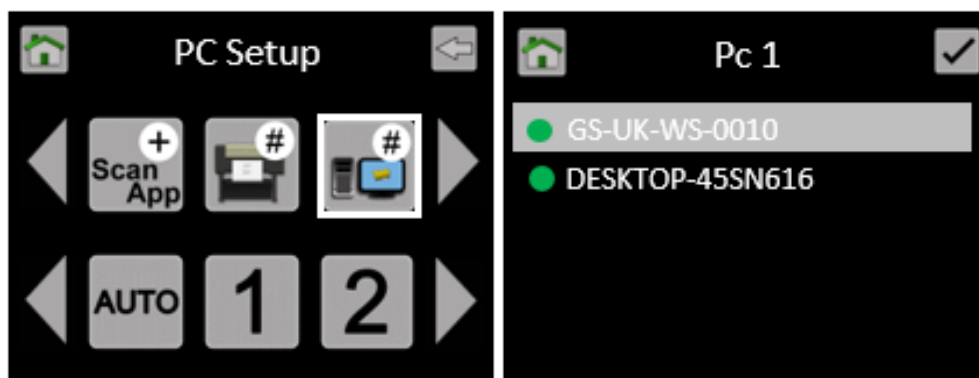
● The Green Dot indicates it is online.

● A red dot indicates it is offline.

- Go back up to the PC Setup menu, scroll and select the Plus PC which is used for the additional functionality when the ScanApp Mode = Plus.



- Go back up to the PC Setup menu to define PC numbers. Select "1", then from the list, select the PC you wish to be assigned #1.



- Go back up to the PC Setup menu to define PC numbers. Select “2”, then from the list, select the PC you wish to be assigned #2.



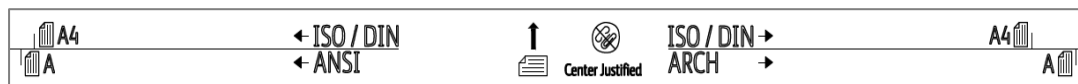
In this example, we have 2 available PCs running the ScanApp Lei and we have set as follows:

- Plus PC = GS-UK-WS-0010
- PC 1 = GS-UK-WS-0010
- PC 2 = DESKTOP-45SN616

Operation

Loading documents into the scanner

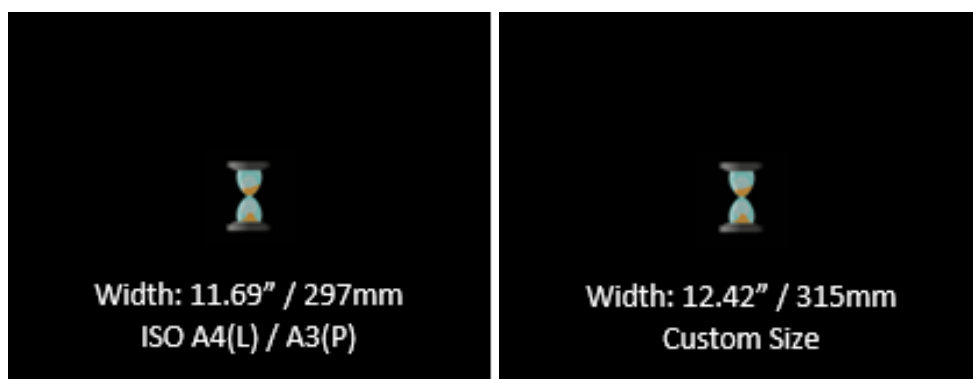
- Caution: The scanner's scan glass will be permanently damaged if you try to scan documents that contain staples, paper clips or other similar objects. Avoid scanning documents with sticky tape or Post-It notes as the glue can adhere to the scan glass resulting in image quality issues.
- To scan thicker documents, such as the calibration target, remove the document return guide(s) to provide a straight paper path.
- The original document will be loaded into the scanner face up in the centre.
If using auto-size, the exact position is not critical.
If using fixed sizes, align to the appropriate mark on the document size strip.
ISO/DIN sizes are shown above the line
ANSI sizes are shown below the line to the left only.
ARCH sizes are shown below the line to the right only.



- Aligning a document can be made easier by fitting either 1 or 2 Paper Edge Guides.
- Using two hands, hold the document at both sides near the lead edge, giving a little outward tension to make the lead edge of the document straight. Present the lead edge to the scanner keeping the lead edge square to the feed rollers. After a delay of approximately 0.5 seconds, the feed rollers will automatically take the document into the scanner and place it in the correct position ready for the Scan or Copy operation.



- The scanner displays the detected paper size. Tolerance is set to +/-1.25%. "Custom Size" is displayed for all other widths.



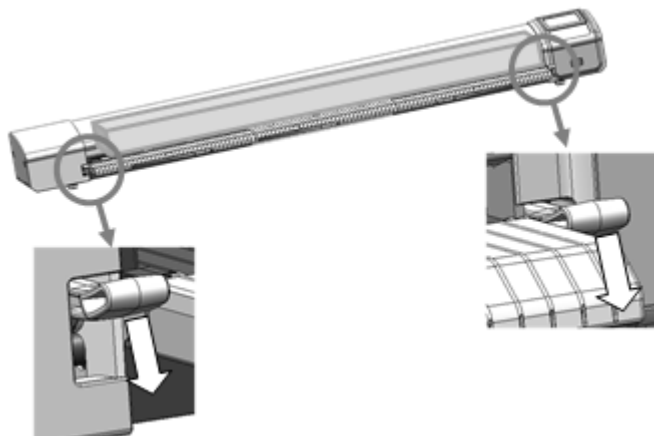
The document can be ejected to the rear of the scanner by pressing the eject button, which is available from the Copy, Scan to USB, Scan to PC or Copy & Archive pages.



- If a document has jammed, open the scanner and remove the document by hand. The jammed document can be removed from the front or back of the scanner as preferred.
- See [Opening/Closing the scanner](#)

Opening/Closing the scanner

- Do not leave the scanner open for long periods of time.
- The scanner is opened by releasing the two levers at the same time.



- Close the scanner by holding both sides of the paper tray and lifting it until both latches click into place.

Scan to USB: TIFF

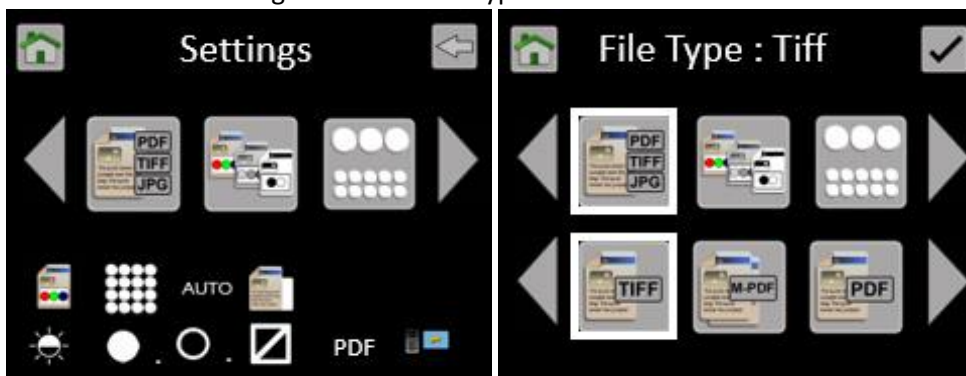
- Scan to USB: File type = TIFF. The scan data is stored internally on the scanner, then sent to the USB. No PC is required.
- Insert a USB memory stick in to the L24ei / L36ei scanner. The USB stick must have been formatted as FAT32 and have a maximum capacity no greater than 128GB. Do not use a USB extension cable.
- Insert a document into the approximate centre of the scanner, face up. The exact position is not critical as we will scan using Auto-Size.



- From the Home page, select the SCAN to USB function.



- Select USB Scan Settings and select file type = TIFF.



- Leave the remaining Scan to USB Settings at default: Colour mode, Standard Resolution, Auto-size. Brightness=0, BP=1, WP=1, Crop off.



- Press the Green button to start the function.



Cancel: Pressing the Red Stop button will stop the scanner immediately.

The document is scanned to internal memory displaying MBs saved and the document will be ejected. The scanner will transfer the scan data to the USB stick displaying the % complete. Wait for the hour glass to disappear, after which and the USB stick can be removed.

WARNING: Removing the USB stick during the data transfer process will corrupt the scanned image.



- Insert the USB stick into any PC and open the Scan000X file using any standard picture viewer. The number of the Scan file on the USB stick will start at 0001 and increment depending on what files are already on the USB stick.
- Note: The date/time stamp of the scan file on the USB stick will be incorrect if the Plus PC is not available at the time of the scan.



Scan to USB (ScanApp Mode = Plus): PDF, JPG, M-PDF

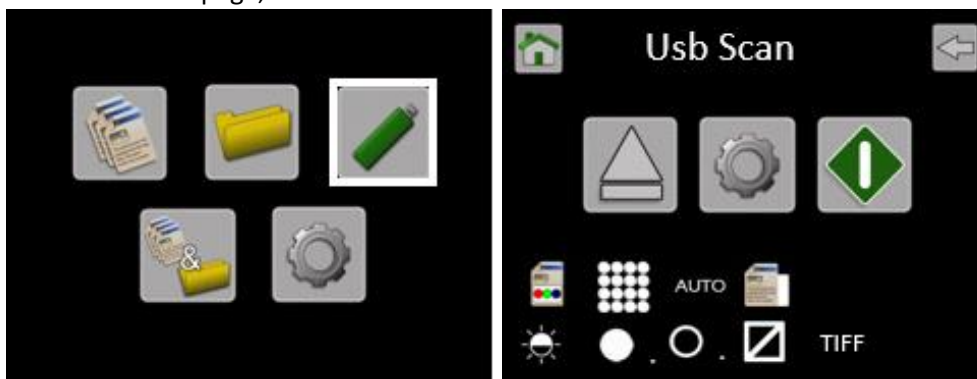
- Scan to USB: File types = PDF, M-PDF & JPG. The scan data is transferred directly to the PC while scanning. The ScanApp Lei compresses and sends the scan file back to the USB in the scanner.
- Ensure the ScanApp Lei is running on the PC assigned for the Plus functionality.
See [Configuring the PCs](#)



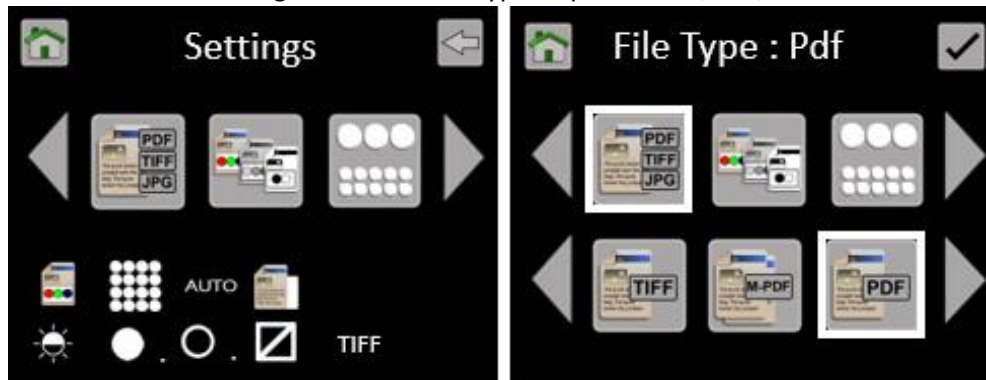
- Ensure the ScanApp Mode = Plus.
See [Configuring the ScanApp Mode of the scanner](#)
- Insert a USB memory stick in to the L24ei / L36ei scanner. The USB stick must have been formatted as FAT32 and have a maximum capacity no greater than 128GB. Do not use a USB extension cable.
- Insert a document into the approximate centre of the scanner, face up. The exact position is not critical as we will scan using Auto-Size.



- From the Home page, select the Scan to USB function.



- Select USB Scan Settings and select file type required: PDF, JPG, M-PDF.



- Leave the remaining Scan to USB Settings at default: Colour mode, Standard Resolution, Auto-size. Brightness=0, BP=1, WP=1, Crop off.



- Press the Green button to start the function.

Note: If a Plus PC has not been assigned, the scanner will search for available PCs running the ScanApp Lei during the Scan to USB process. Once a PC has been selected, start the Scan to USB function again.



Cancel: Pressing the Red Stop button will stop the scanner immediately.

- If the file type =M-PDF (Multi-Page PDF), insert the next page when prompted.



When all the pages have been added, press the red stop button to close the file.



- The document will be scanned directly to the ScanApp Lei via Ethernet displaying MBs transferred and the document will be ejected. The ScanApp Lei compresses and converts the file type, then the data is then written back to the USB stick at the scanner displaying the % complete. Wait for the hour glass to disappear, after which and the USB stick can be removed. **WARNING:** Removing the USB stick during the data transfer process will corrupt the scanned image.



- Insert the USB stick into any PC and open the Scan000X file using any standard picture viewer. The number of the Scan file on the USB stick will start at 0001 and increment depending on what files are already on the USB stick.

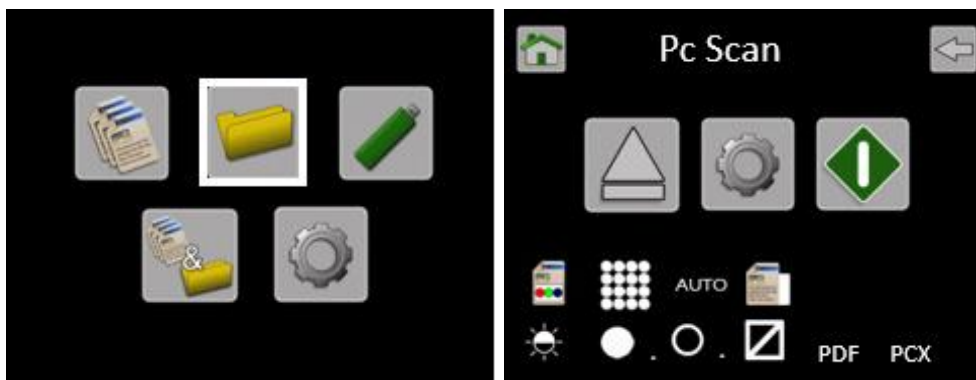


Scan to PC

- Ensure the ScanApp Lei is running on the PC to which you wish to send the scan file.
See [Configuring the PCs](#)
- Ensure ScanApp Lei is has been configured with the scan folder of your choice.
See [ScanApp Lei Operation](#)
- Insert a document into the approximate centre of the scanner, face up. The exact position is not critical as we will scan using Auto-Size.

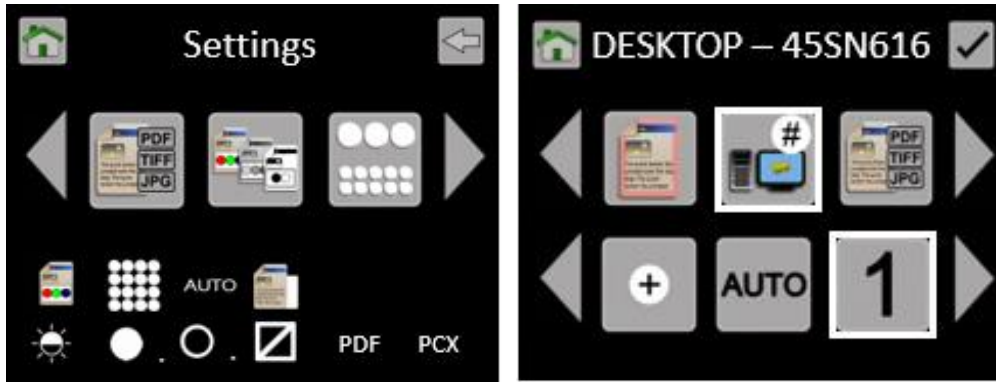


- From the Home page, enter the Scan to PC menu.



The PC to be used for Scanning to PC is shown on the Scan to PC page. This example shows the current PC selected as PCX. This means the scanner will complete an Auto PC search and prompt the user to select the PC before completing each scan.

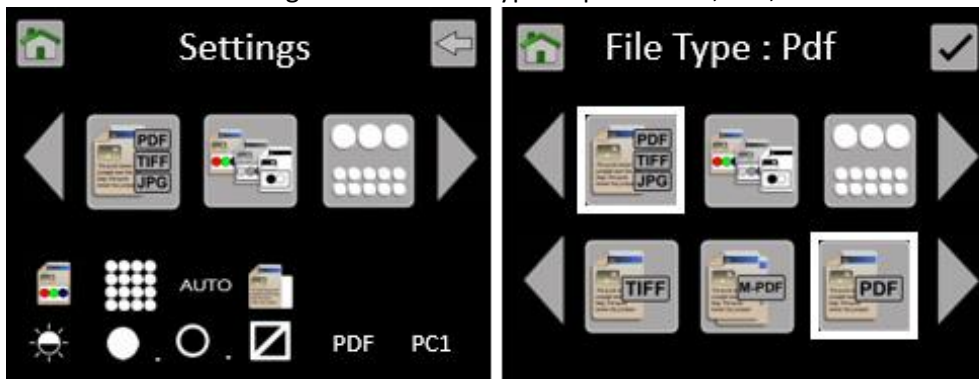
- To change the PC# select the Scan to PC Settings. Scroll and select PC#. Select the PC# you wish to use.



Note: The Hostname of the assigned PC# is displayed at the top of the screen. If the Hostname is displayed in Red, then that PC is not on or the ScanApp Lei is not running. The status of the connection is updated only when you enter the menu.



- Select Scan to PC Settings and select file type required: PDF, JPG, M-PDF



- Leave the remaining Scan to PC Settings at default:
Colour mode, Standard Resolution, Auto-size. Brightness=0, BP=1, WP=1, Crop off.



- Press the Green button to start the function.



Cancel: Pressing the Red Stop button will stop the scanner immediately.

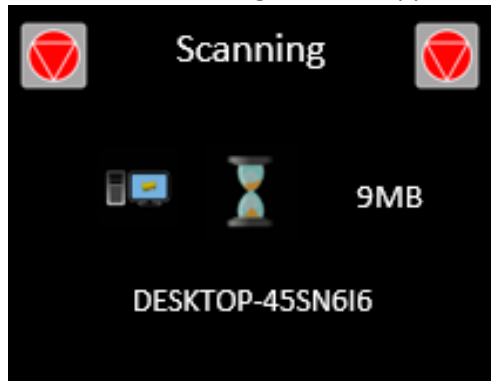
- If the file type =M-PDF (Multi-Page PDF), insert the next page when prompted.



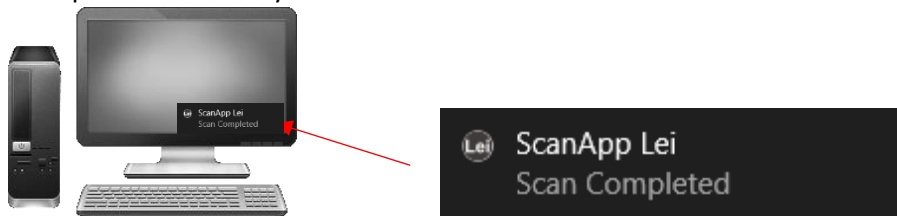
When all the pages have been added, press the red stop button to close the file.



- The document will be scanned directly to the ScanApp Lei via Ethernet displaying MBs transferred and the document will be ejected. Wait for the scan data to complete the transfer to the PC and the hour glass to disappear.



- On the PC, the ScanApp Lei will show Scan Completed. The scan file will be saved in the Scan Directory set in the ScanApp Lei. Open the scan file using any standard picture viewer. PDF files will open automatically in the PC's default PDF viewer.



The Scan file name is date & time as follows:

YYYY-M-D-H-M-S

2016-8-3-15-11-1

Copy – ScanApp Mode = Standard



- Standard mode. The scan data is stored internally on the scanner and sent to the printer. No PC is required.
- See [Configuring the ScanApp Mode of the scanner](#)
- Ensure the printer is on-line and ready to print. Insert a document into the approximate centre of the scanner, face up. The exact position is not critical, as we will scan using Auto-Size.

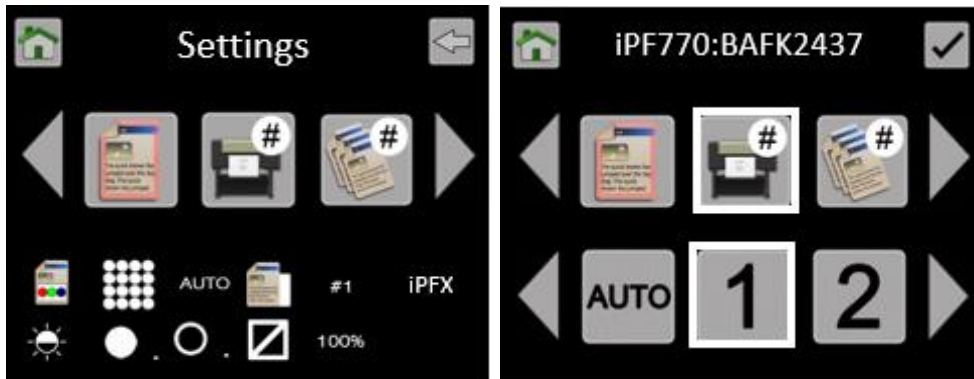


- From the Home page, enter the Copy menu.



The printer to be used for Copying is shown on the Copy page. This photo shows the current printer selected as iPFX, which means the scanner will complete an Auto Printer search and prompt the user to select the Printer before completing each scan.

- To change the iPF# select the Copy Settings. Scroll to iPF#, and press it. Select the iPF# you wish to use and select it.



Note: The Serial Number of the assigned PC# is displayed at the top of the screen. If the Serial Number is displayed in Red, then that Printer is not available. The status of the connection is updated only when you enter the menu.



Save this as your default Function Settings in the Scanner Settings menu.

See [Functionality – Saving your preferred Function Settings as power on Defaults](#)

- Leave the remaining Copy Settings at default: Colour mode, Standard Resolution, Auto-size. Brightness=0, BP=1, WP=1, Crop off, Scale=100%, Copies=1.





- Press the Green button to start the function.



Cancel: Pressing the Red Stop button will stop the scanner immediately.

- The document will be scanned to internal memory displaying MBs transferred and the document will be ejected. The scanner will then transfer the scan data to the printer displaying the % complete. Wait for the scan data to complete the transfer to the printer.



- Collect your copy from the printer.



Copy – ScanApp Mode = Plus



- Plus mode. The scan data is transferred directly to the PC while scanning to make the scanner available for the next job sooner. The ScanApp Lei then sends print data to the printer. See [Configuring the ScanApp Mode of the scanner](#)
- Ensure the printer is on-line and ready to print. Insert a document into the approximate centre of the scanner, face up. The exact position is not critical as we will scan using Auto-Size.

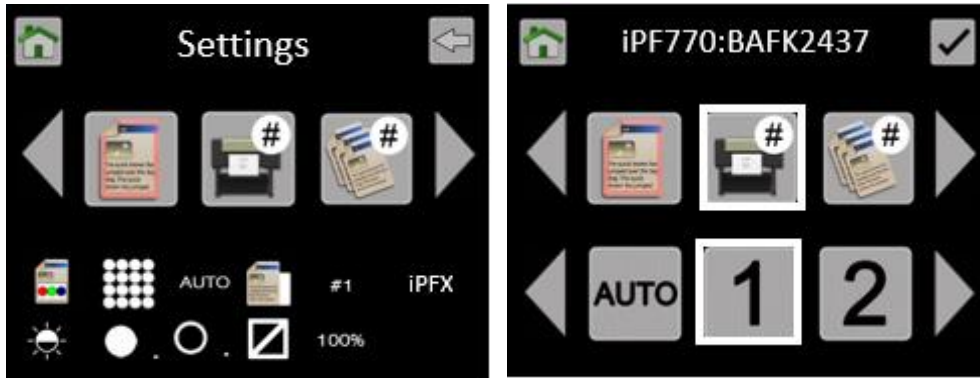


- From the Home page, enter the Copy menu.



The printer to be used for Copying is shown on the Copy page. This photo shows the current printer selected as iPFX, which means the scanner will complete an Auto Printer search and prompt the user to select the Printer before completing each scan.

- To change the iPF# select the Copy Settings. Scroll to iPF#, and press it. Select the iPF# you wish to use and select it.



Note: The Serial Number of the assigned PC# is displayed at the top of the screen. If the Serial Number is displayed in Red, then that Printer is not available. The status of the connection is updated only when you enter the menu.





Save this as your default Function Settings in the Scanner Settings menu.

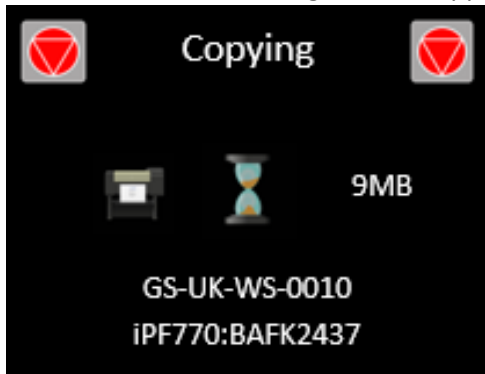
See [Functionality – Saving your preferred Function Settings as power on Defaults](#)

- Leave the remaining Copy Settings at default: Colour mode, Standard Resolution, Auto-size. Brightness=0, BP=1, WP=1, Crop off, Scale=100%, Copies=1.

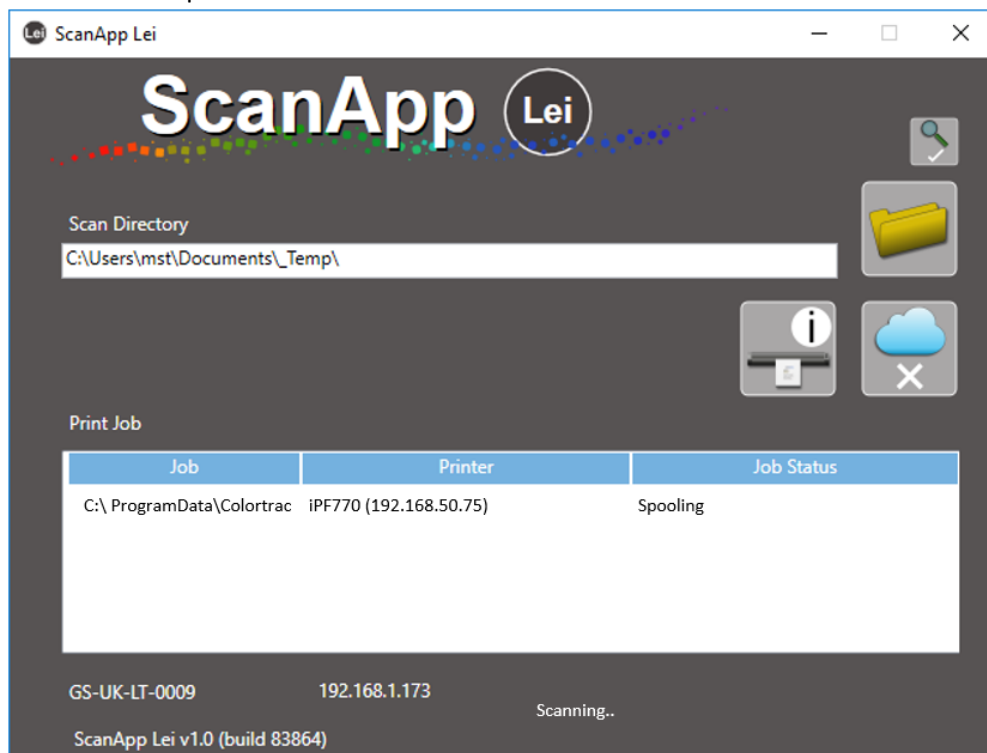


-  Press the Green button to start the function.
-  Cancel: Pressing the Red Stop button will stop the scanner immediately.

- The document will be scanned directly to the ScanApp Lei via Ethernet displaying MBs transferred and the document will be ejected. Wait for the scan data to complete the transfer to the Plus PC and the hour glass to disappear. The scanner is now ready for the next job.



- If the Plus PC has not been configured ([Configuring the PCs](#)), or is offline, the scanner will automatically switch to ScanApp Mode = Standard to complete the Copy operation.
- The ScanApp Lei will spool the scan data to the printer. Wait for the scan data to complete the transfer to the printer.



- Collect your copy from the printer.

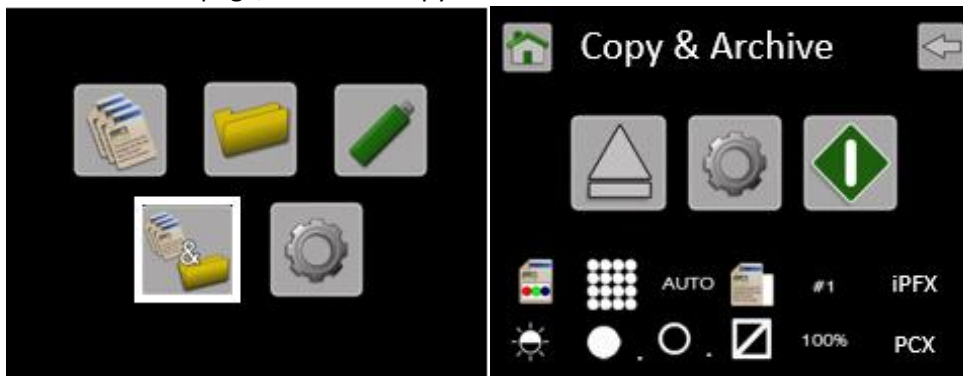


Copy & Archive

- The scan data is transferred directly to the PC while scanning to make the scanner available for the next job sooner. The ScanApp Lei then sends print data to the printer and saves the scan file.
- Ensure ScanApp Lei is running on the PC you wish to send the scan file.
See [ScanApp Lei Operation](#)
- Ensure the printer is on-line and ready to print. Insert a document into the approximate centre of the scanner, face up. The exact position is not critical as we will scan using Auto-Size.



- From the Home page, enter the Copy & Archive menu.



- The printer to be used is shown on the Copy & Archive page. This example shows the current printer selected as iPFX, so the scanner will complete an Auto Printer search and prompt the user to select the Printer before completing each scan. Also, the current PC selected is PCX, so the scanner will complete an Auto PC search and prompt the user to select the PC before completing each scan.
- To change the iPF# select the Copy & Archive Settings. Scroll to iPF#, and press it. Select the iPF# you wish to use and select it.



Note: The Serial Number of the assigned iPF# is displayed at the top of the screen. If the Serial Number is displayed in Red, then that Printer is not available. The status of the connection is updated only when you enter the menu.



- To change the PC# select the Scan to PC Settings. Scroll and select PC#. Select the PC# you wish to use.



Note: The Hostname of the assigned PC# is displayed at the top of the screen. If the Hostname is displayed in Red, then that PC is not on or the ScanApp Lei is running. The status of the connection is updated only when you enter the menu.



- Select Copy & Archive Settings and select file type required: PDF, JPG, M-PDF



Save this as your default Function Settings in the Scanner Settings menu.

See [Functionality – Saving your preferred Function Settings as power on Defaults](#)

- Leave the remaining Copy & Archive Settings at default: Colour mode, Standard Resolution, Auto-size. Brightness=0, BP=1, WP=1, Crop off, Scale=100%, Copies=1.

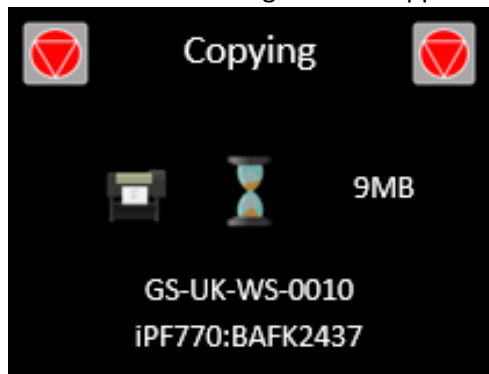


- Press the Green button to start the function.

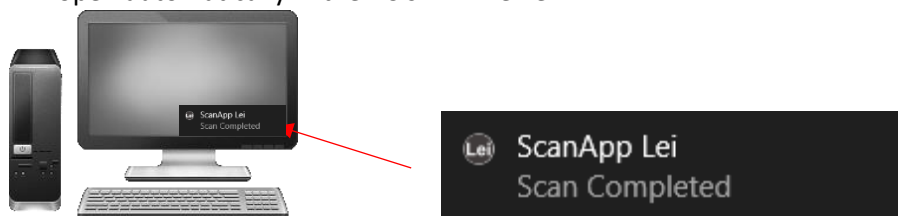


Cancel: Pressing the Red Stop button will stop the scanner immediately.

- The document will be scanned and then ejected. The scan data will be sent to the ScanApp Lei via Ethernet displaying MBs transferred. Wait for the scan data to complete the transfer to the Plus PC and the hour glass to disappear. The scanner is now ready for the next job.



- On the PC, the ScanApp Lei will show Scan Received. The scan file will be saved in the Scan Directory set in the ScanApp Lei. Open the scan file using any standard picture viewer. PDF files will open automatically in the PC's PDF viewer.



The Scan file name is date & time as follows:

YYYY-M-D-H-M-S
2016-8-3-15-11-1

- The ScanApp Lei will also spool the scan data to the printer. Wait for the scan data to complete the transfer to the printer.
- Collect your copy from the printer.



Operation: Function Settings

- On the scanner UI, select the function you wish to use.



Copy



Scan to PC

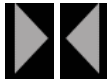


Scan to USB



Copy & Archive (= Copy plus Scan to PC in a single function)

- From the function page, select the Setting to be changed. Select the new value you wish to use (Not all the Function Settings are available for all functions).



- Use the left & right arrows when available to scroll to more options.



- Home = Go to Home page. Cancels any changes if in a Function Settings Menu.



- Tick = Save selection and go back up 1 level.

- The Functions Settings Icons at the bottom of the screen are also active and provide a shortcut directly to that menu.

- Number of copies (Copy, Copy & Archive only)



Default = 1



- Select Scan file type. (Scan to PC, Scan to USB only)



Default = PDF.



M-PDF = Multi-Page PDF:



Keep inserting pages to add to the document.

When all the pages have been added, press the red stop button to close the file.



- Colour mode



Default = Colour



Colour,



Greyscale,



Black and White

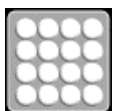
- Quality Mode



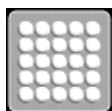
Default = Standard



Standard,



High,



Best

- Original document size



Default = Auto



Auto size. This will detect the size of the document as it is loaded.



Full width of the scanner (24"/36") and auto detect the length.

Alternatively select to scan a Fixed Size independent of what size paper is loaded.



ISO sizes



ANSI sizes



ARCH sizes

ISO	Dimensions	ANSI	Dimensions	ARCH	Dimensions
A0	841mm x 1189mm	E	34in x 44 in	ARCH E	36inx 48in
A1	841mm x 594mm	D	34in x 22 in	ARCH D	36in x 24in
A2	594mm x 420mm	C	22in x 17 in	ARCH C	24in x 18in
A3	297mm x 420mm	B	17in x 11in	ARCH B	18in x 12in
A4	297mm x 210mm	A	11in x 8.5in	ARCH A	12in x 9in

- Orientation (Used with Fixed Sizes only)



(Default = Portrait)



Portrait,



Landscape

- Copy scale factor (Copy, Copy & Archive only)



Default = 100%



Adjust Copy size by percentage

25%

35%

50%

71%

Reduction

100%

No change

141%

200%

283%

287%

400%

432%

Enlargement



Adjust Copy size by selecting input and output standard ISO page sizes.

Input Size =

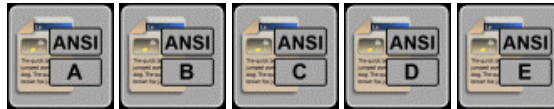


Output Size =



Adjust Copy size by selecting input and output standard ANSI page sizes.

Input Size =



Output Size =



Adjust Copy size by selecting input and output standard ARCH page sizes.

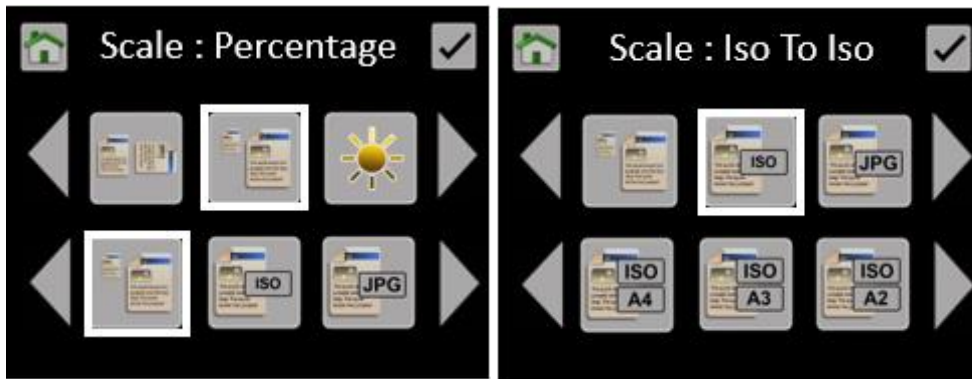
Input Size =



Output Size =



Example of Copy Scale Factor: Select the Paper size system: ISO, ANSI or ARCH



Select the input Paper size, followed by the output paper size. (E.g. From A4 to A3)



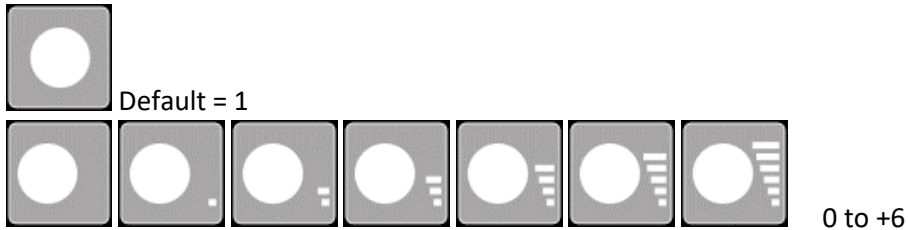
Go back up to Copy page, that will show the % scale factor that will be used based on your choice of "From – To" page sizes selected. (E.g. A4 to A3 shows a scale factor of 141%).



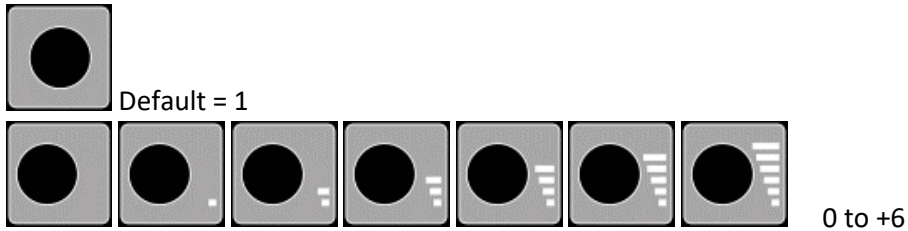
- Brightness. Increase to lighten the image, decrease to darken the image.



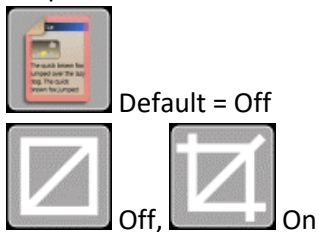
- White Point. Increase to clean up a dirty background. Makes the whites whiter.



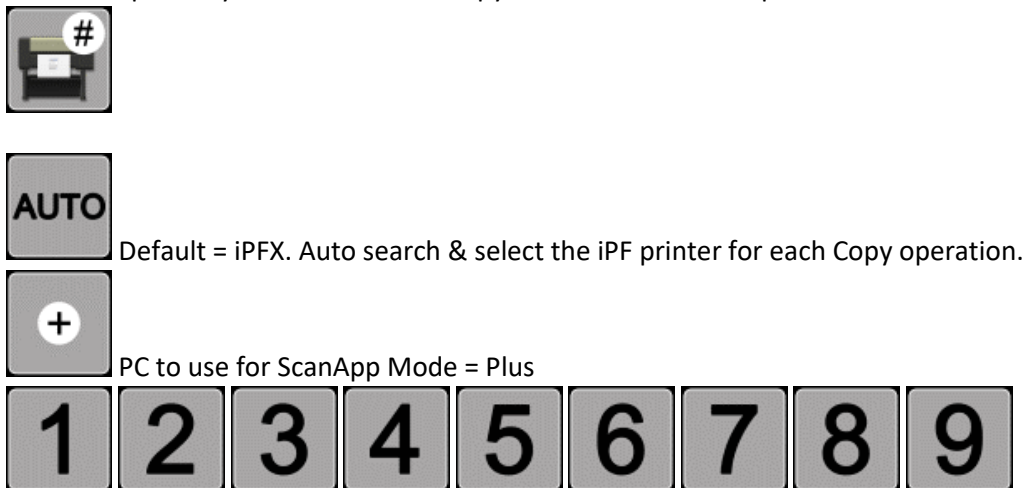
- Black Point. Increase to darken the shadow areas of the image. Makes the blacks blacker.



- Crop. Removes a 3mm border from all sides of the scanned image.



- iPF# (Copy, Copy & Archive only)
Select the printer you would like the Copy function to send the print to.



- PC# (Scan to PC, Copy & Archive only)
Select the PC you would like the Scan to PC function to communicate with.



Default = PCX. Auto search & select the PC for each Scan to PC operation.



Operation: Saving your preferred Function Settings as power on Defaults

- This function saves the current Function Settings as the Default. The following Function Settings are saved:
Number of Copies, File Type, Colour mode, Quality, Document Size, Orientation, Copy scale, Brightness, Black Point, White Point, Crop, iPFX, PCX.

- On the scanner UI, from the Home page, select the Scanner Settings icon.



Select the Save Settings to folder icon and press OK. A tick will be displayed to show it was successfully saved.



Save current Function Settings as Default,



Done

To restore Factory Default Function Settings, select the Reset Settings icon and press OK.



Restore Factory Function Settings as Default,



Done

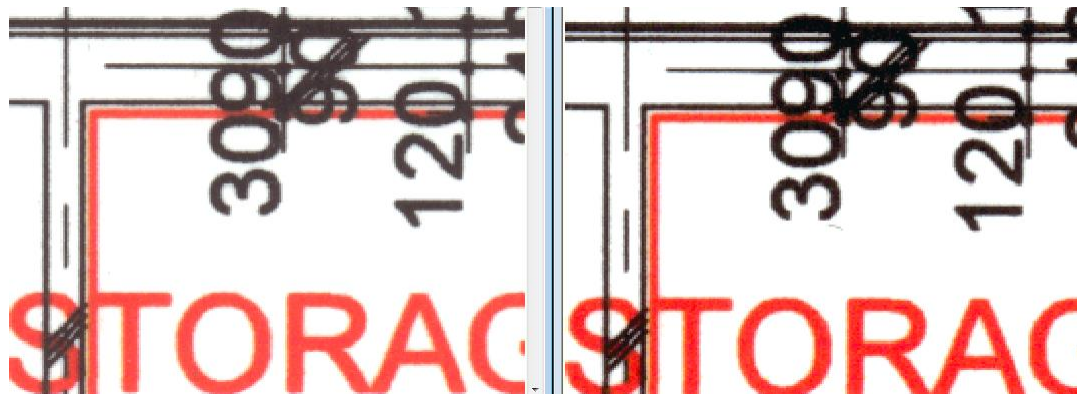
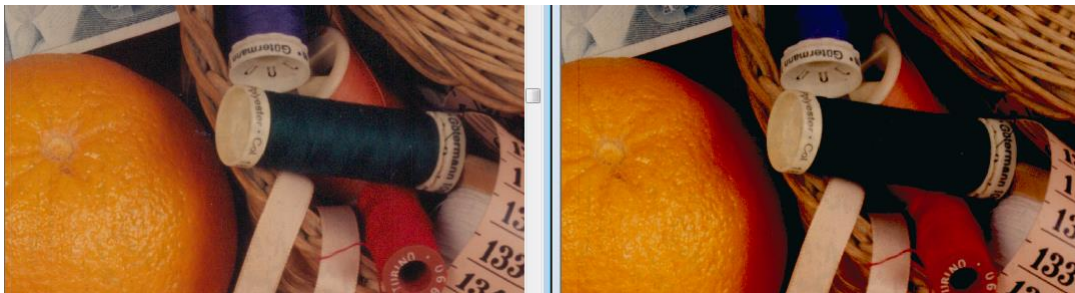
Application notes

Tightly curled documents

- Prior to scanning, flatten the document as best as possible.
- During the scan process, guide the document as it feeds through the scanner to prevent the original re-entering the scanner. If the original is allowed to re-enter the scanner, it will result in a paper jam and possible damage the original document.

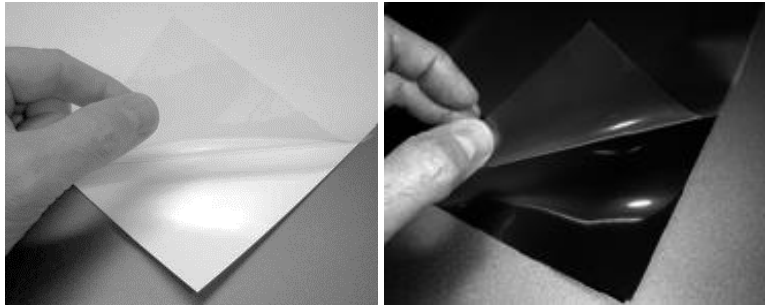
Recommended Function Settings

For Photographic originals where colour accuracy is most important.	For Graphics & Line drawings where sharp distinctive colours are required. (Default)
White Point = 0 and Black Point = 0	White Point = 1 and Black Point = 1



Document Carrier Sheets

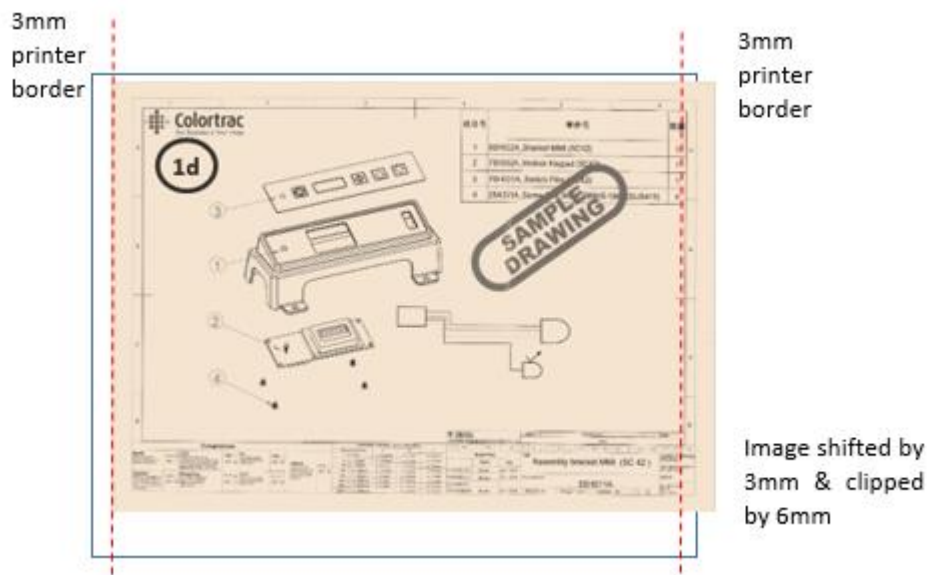
- Delicate documents: Old, fragile documents could be damaged further when feeding through a scanner. To avoid such problems, these delicate documents can be placed inside a document carrier sheet before scanning to provide protection.



- Documents Carrier Sheets can also be useful when scanning
 - Transparent documents to improve light reflection and provide a more even image.
 - Glossy originals to avoid them becoming scratched
 - Irregular shaped or torn documents, or multiple documents pieces to scan as a single file.
 - Dirty documents as the carrier sheet can protect the scan glass from storage dust.
 - Semi-transparent documents that contain print on both sides can result in show through of the text on the reverse side. Scanning such documents in black backed carrier sheets can help reduce the reflected light and hence the amount of show through.
- Contact your reseller for more information, prices and availability of carrier sheets.

Eliminating clipped copies

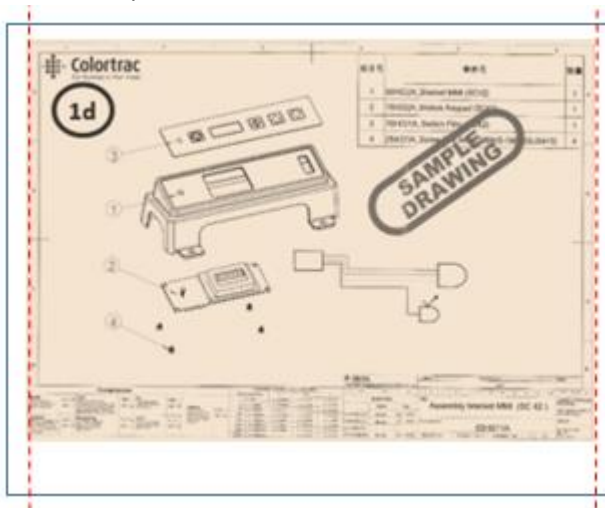
- If you scan a 594mm original as fixed size A1, then the image is 594mm wide.
- The printer has a 3mm margin either side that it cannot print within. That means on a 594mm roll, only 588mm can be printed on. Therefore, copying a 594mm original scan onto the 588mm printable width of the paper will mean the image is shifted 3mm to the side and 6mm (2 x 3mm) is clipped from the far side.



- Enabling the Crop feature means the original image is printed correctly by cropping a 3mm border from all around the scan before printing.

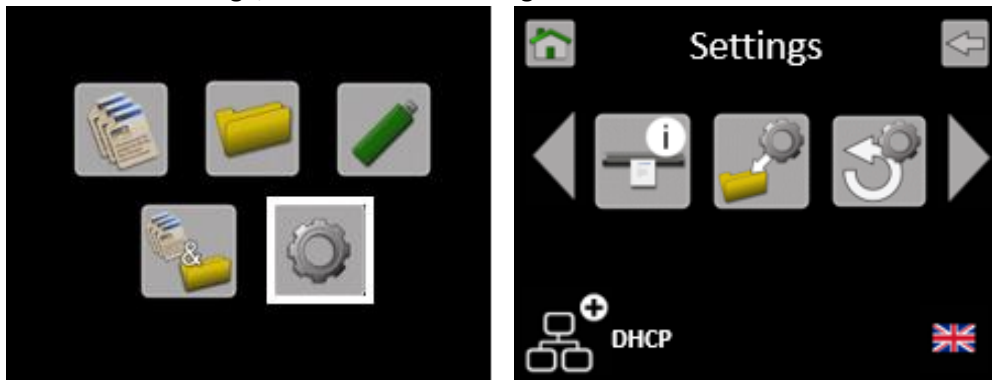


Crop on

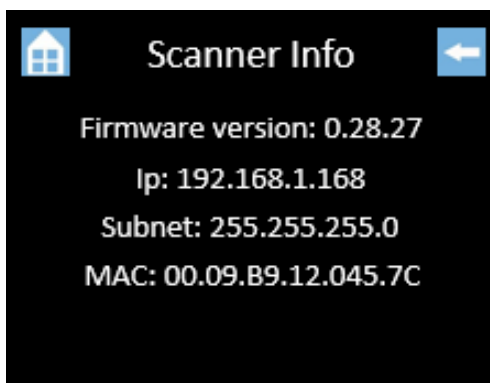


Scanner Settings

- From the Home Page, select Scanner Settings.



- Scroll left or right and select the Setting to be changed, then select the new value to be used.
- Information. There is nothing to adjust.



- Save Current Function Settings as Default.
See [Functionality – Saving your preferred Function Settings as power on Defaults](#)



- Restore Factory Default Function Settings.
See [Functionality – Saving your preferred Function Settings as power on Defaults](#)



- Load Firmware. See [Loading Firmware](#)



- Calibration. See [Calibration](#)





- Stitch adjustment. See [Stitch Adjustment](#)



- Scan Length. See [Scan Length Adjustment](#)



- Standard / Plus ScanApp mode. See [Configuring the ScanApp Mode of the scanner](#)

-  Plus Mode (Default when in English language)
-  Standard Mode (Default when in Japanese language)

- iPF#. Assign numbers to the printers to use you would like the Copy function.



Search for available Printers.



Define the Printer numbers. See [Configuring the Printers](#)

- PC#. Assign numbers to the PCs to use you would like the Scan to PC function.



Search for available PCs.



Define the PC numbers. See [Configuring the PCs](#)

- Network Settings. See [Configuring the network connection of the scanner](#)



- Automatic IP Settings



DHCP

- Manual IP Settings



Static IP Address




IP Address,



Subnet Mask

- Select Language. See [Configuring the language of the scanner](#)



-  English Text (Sets ScanApp Mode = Plus)

-  Japanese Text (Sets ScanApp Mode = Standard)

- Engineer Menu. (For service use only - password required).



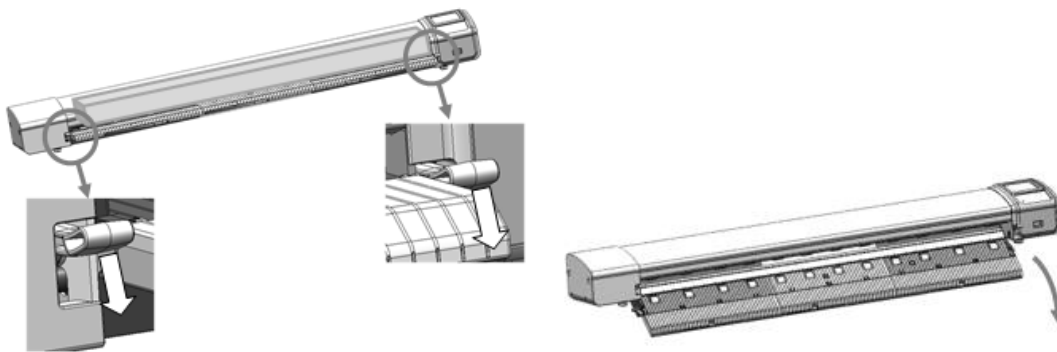
Saving Scanner Settings

- The Scanner Settings are saved automatically through their respective menus: Firmware, Calibration, Stitch adjustment, Scan Length, ScanApp Mode, Assigned printer numbers, Assigned PC numbers, Scanner Network Settings, Language. No. scans/copies, scan length, error log.

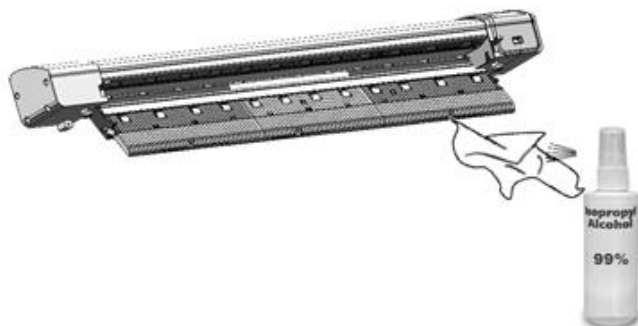
Maintenance

Cleaning

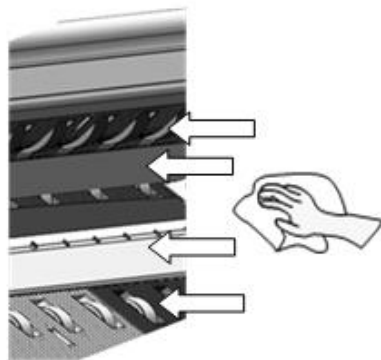
- Open the scanner.



- Spray 99% isopropyl alcohol onto a lint free cloth.



- Using the cloth, clean the following components:



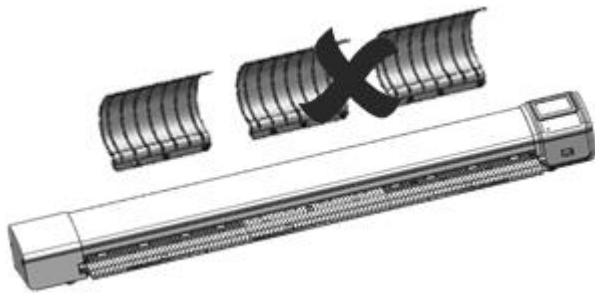
- Top drive rollers
- Scan glass
- Hold up flap
- Bottom rollers (Rotate rollers by hand to clean all round).

Consumables

- Parts that wear according to operator usage are deemed consumables and can be purchased from your supplier. Those L24ei / L36ei scanner parts considered to be consumables are:
 - Scan Glass Sub.
 - Paper Hold Up flap.
 - Calibration/Stitch Target, Paper edge guides, Touch pen and pen holder.

Calibration

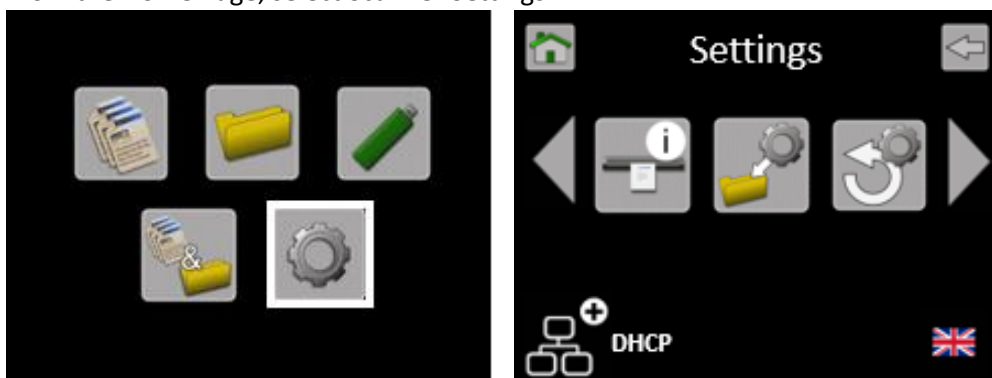
- Remove the document return guides to prevent the calibration target getting stuck during forward/rewind motion required for calibration.



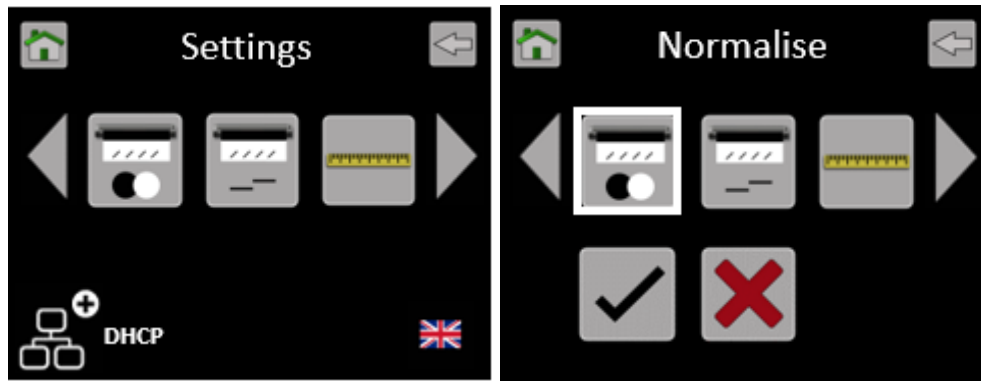
- Clean the scanner.
- Insert the calibration target (it must be clean and in good condition) into the centre of the scanner face up, black end first.



- From the Home Page, select Scanner Settings.



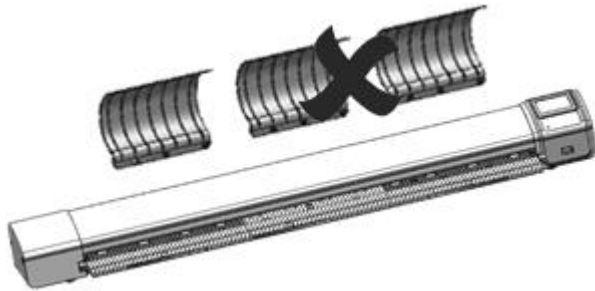
- Scroll and select Calibration (Normalise).



- Select the Tick icon and the calibration target will be scanned back & forth until complete. Please wait until the scanner returns to the Home screen. This process will take a few minutes. Return the calibration target to its protective cover for safe keeping.
- Note: Calibration (Normalisation) will not start until calibration sheet is loaded and in the correct orientation - Face up, black end first.

Stitch Adjustment

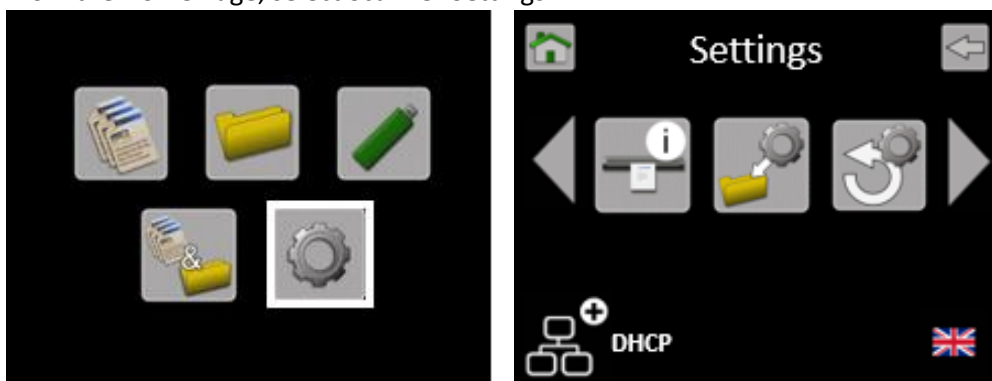
- Remove all the document return guides to prevent the calibration target getting stuck during forward/rewind motion required for calibration.



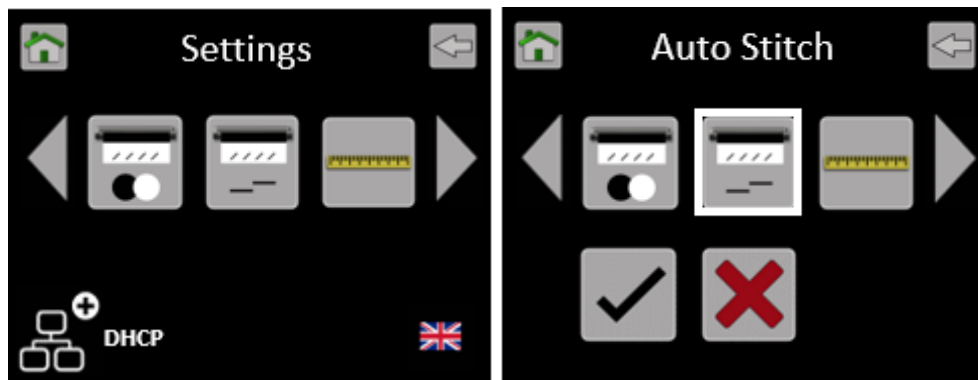
- Clean the scanner.
- Insert the calibration target (it must be clean and in good condition) into the scanner face up, black end first.



- From the Home Page, select Scanner Settings.



- Scroll and select Auto Stitch.



- Select the Tick icon and the calibration target will be scanned back & forth until complete. Please wait until the scanner returns to the Home screen. This process will take a few minutes. Return the calibration target to its protective cover for safe keeping.
- Note: Auto Stitch will not start until calibration sheet is loaded and in the correct orientation - Face up, black end first.

Scan Length Adjustment (Automatic)

- The Scan Length is automatically adjusted when completing the Stitch Adjustment.

Scan Length Adjustment

- To correct the length of scans or copies, Copy a document and measure the length of the drawing on both the original and the copy. The copy should be within 0.2% of the original. So, for a 500mm drawing, the acceptable range is 499mm to 501mm. To adjust the copy length:
 - Insert a document into the approximate centre of the scanner, face up. The exact position is not critical as we will scan using Auto-Size. We will copy a document and measure the length of both the original and the copy.



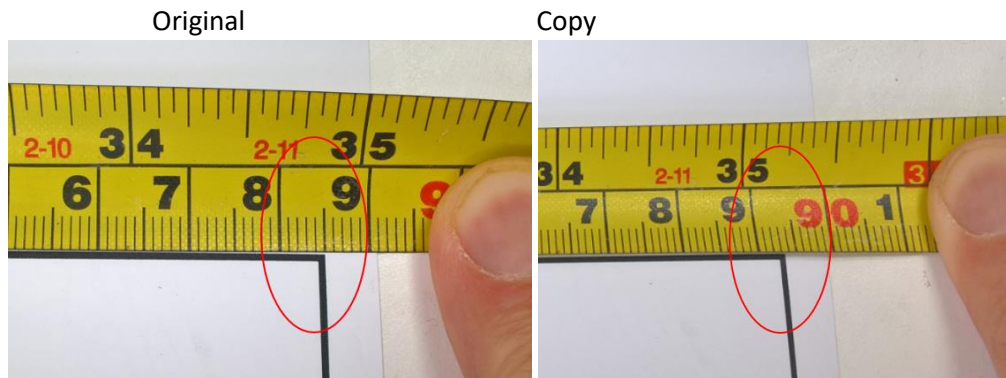
- From the Home Page, select the Copy function.



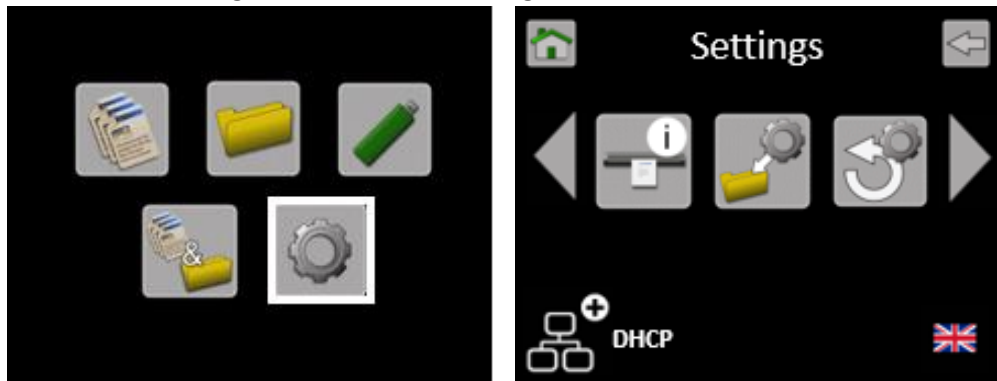
- Use the default Copy Settings: Colour mode, Standard Quality, Auto-size, Brightness=0, BP=1, WP=1, Crop off, Scale=100%, Copies=1
- Start the Copy.
- The scanner will then transfer the scan data to the printer. Wait for the scan data to complete the transfer to the PC when the hourglass will disappear and the original document will be ejected from the scanner. Collect your copy from the printer.

- Measure the length of the drawing on both the original and the copy. Calculate the adjustment figure by dividing the length of the original by the length of the copy.

$$\text{Adjustment figure} = \frac{\text{Original drawing length}}{\text{Copied drawing length}} = \frac{885\text{mm}}{893\text{mm}} = 0.9910$$



- From the Home Page, select Scanner Settings.



- Scroll and select Scan Length Adjustment.



- Use the Delete Key, to remove the current value, and type in the adjustment figure. Press the Enter key to save.

Loading Firmware

- Locate the firmware zipped file and a USB stick, which must have been formatted as FAT32 with a maximum capacity no greater than 128GB.



LFW2-11

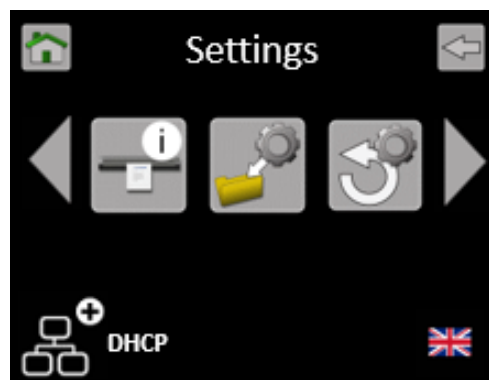
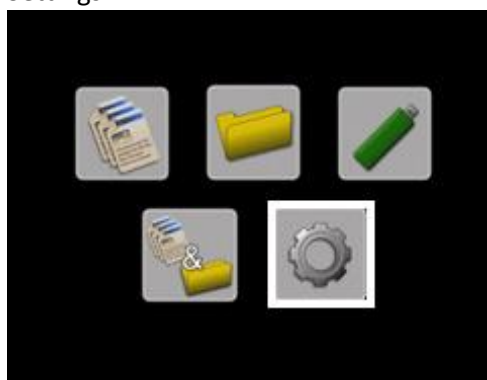
- On a PC, use Windows Explorer® to extract the firmware zipped files to the root of a USB memory stick.

USB STICK (E:)				
Name	Date modified	Type	Size	
PRNT	31/07/2017 10:41	File folder		
LsRGB.tab	05/06/2015 15:09	TAB File	6,145 KB	
LUPDATE	12/07/2017 16:17	Configuration set...	17 KB	
P110.spi	12/07/2017 11:38	SPI File	1,153 KB	
SDB.bin	12/07/2017 16:25	BIN File	2,042 KB	

- Place the USB stick into the scanner.



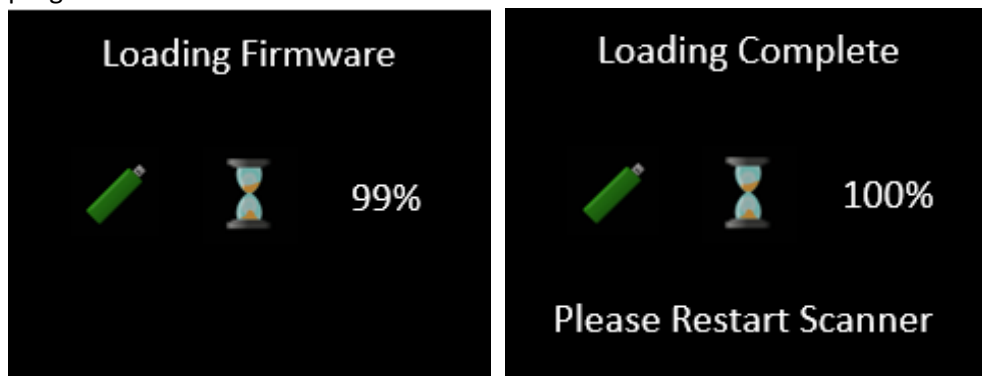
- If the scanner recognises that the USB stick contains scanner firmware, it will automatically open the Load Firmware menu.
- To select the Load Firmware menu manually, from the Home Page, select Scanner Settings.



- Scroll and select Load Firmware.






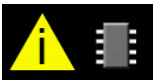






- Select the Tick icon and the scanner will start to load firmware and will indicate progress.



- DO NOT SWITCH OFF the scanner during the firmware loading process as this can cause permanent damage to the scanner. The UI will display the percentage complete while it loads the firmware into the scanner.
- Wait until the firmware has loaded. This will take a few minutes. Power cycle the scanner to complete the process.

Troubleshooting

Error Codes

Error Code	Symbol	Message	User Actions	
		Scanner open	Close the scanner	
		No Document loaded	Load a document	
1		Invalid Model	Power cycle. If problem persists, call service.	
2		Calibration required	Power cycle. If problem persists, Calibrate . If problem persists, Stitch . If problem persists, call service.	
3		Memory: Not Mounted	Power cycle. If problem persists, call service.	
4		Memory: Cannot read		
5		Memory: Cannot write		
6		Memory: Full		
7		Memory: Unformatted		
8		Memory: Not Closed		
9		USB: Not Mounted	Retry USB stick, or try another one. (Format = Fat32, 128GB max).	
10		USB: Cannot read		
11		USB: Cannot write		
12		USB: Full	Delete files, or try another USB stick.	
13		USB: Cannot Delete	Retry USB stick, or try another one. (Format = Fat32, 128GB max).	
14		USB: Not Closed		
15		Printer Not Found	See Troubleshooting: Operational Errors .	
16		Printer Error		
17		PC Not Found		
18		PC Error		
19		Stitch Error		Power cycle. If problem persists, Stitch .
20		Normalise Error		Power cycle. If problem persists, Calibrate .
21		LED Calibration Error	Power cycle. If problem persists, call service.	
22		Firmware Error	Power cycle. If problem persists, load firmware	
23		Mid-scan Stop Error		
24		Plus Pc Not Found	Ensure the ScanApp Lei is running on the Plus PC .	

Operation errors

Document does not feed correctly.

- The document is not fed straight into the scanner. Hold the original document with two hands and feed into the scanner until you feel equal resistance on both sides from the feed rollers. If the document is not straight, open the scanner to remove the original, close the scanner and try again. Load the document into the centre of the scanner.
- Place the Paper Edge Guides either side of the document to help align and guide the document.
- Check that the scanner is closed properly, with both latches clicked into place.
- Document is the wrong size for the scanner. Make sure the document is within the specification allowed for the scanner.

Scanner LED is not on

- There is no power to the scanner. Check the scanner is switched on, the mains power is on, the power cable is connected correctly to the power adapter and the power adapter cable is connected correctly to the scanner.

The scanner LED remains Orange when powered on.

- The scanner lid is open. Close the scanner, so both paper tray latches are clicked into place.

Scan or copy is blank.

- Make sure the original document is fed face up and into the centre of the scanner.

Scan to USB does not work

- Ensure the USB memory stick has been formatted as FAT 32 and has a maximum capacity of 128GB. Ensure it has enough free space for the scan. A lower Scan Quality mode requires less space.
- Set Scan to USB file type to TIFF as this function takes place inside the scanner. If this works and file type PDF or JPG does not, then check Scan to PC functionality.

No Scan to PC output.

- The ScanApp Lei must be running on the PC# that is selected.
 - Try searching for the available PCs with the ScanApp Lei.
 - Check the IP address displayed in the ScanApp Lei is in the same subnet as on the scanner (See Scanner Info page).

No Copy output.

- The printer with the correct iPF# that is selected must be on-line and ready to print.
 - Try searching for the available printers.

Testing connectivity

- If you are still having problems with the Scan to PC or Copy functions, eliminate the scanner and ScanApp Lei as the cause of the issue by testing using a direct Ethernet connection. This is intended as a diagnostic step only and not recommended as the permanent configuration.
- Copy - connect an Ethernet cable between the Scanner and the printer using static IP addresses as below.
- Scan to PC - connect an Ethernet cable between the Scanner and the PC using static IP addresses as below. Ensure the PC is not also connected to another wireless network.



- If this is working, the scanner and ScanApp Lei are working as expected. If the system does not work correctly when connected via the local network using the desired IP addresses (Static or DHCP), then the problem lies with the network configuration. For further information regarding network configurations, please contact your local network administrator.

Information for Network Administrators.

This Information Bulletin should provide an overview and greater understanding of how the Lei series scanners communicates over the network.

Copy - Ports and protocols:

- The scanner searches for the printer by issuing a SNMP broadcast packet on UDP port 161 and expects a response on port 161.
 - Three attempts with a timeout value of 5-10secs will be tried.
 - Error 15 will be displayed if no response is received.
- Given that the scanner received a SNMP response, it will then attempt to communicate directly with the printer via the CPCA protocol on UDP port 47545.
 - The scanner will enquire about sleep and paper status.
 - Any problem with this communication will result in an Error 16.
- When communicating with IVEC printers (TM-200/300/5200/5300), the scanner will also acquire information from the printers built-in HMI database via the HTTP protocol on TCP port 80.
 - Any problems with this communication should result in an Error 16 as well.

- If the printer status and communication is still OK, the scanner will setup a print job via the LPR protocol on TCP port 9100.
 - Any problems with this communication should result in an Error 16 as well.

Scan - Ports and protocols:

- The scanner searches for the PC by issuing a proprietary broadcast packet on UDP port 706.
 - Three attempts with a timeout value of 1sec will be tried.
- Given that the scanner received a response from the PC, it will attempt to open a TCP connection on port 710.
 - There is a timeout value of 1sec for this action.

Scanner Info - Ports and protocols:

- ScanApp Lei searches for the scanner by issuing a proprietary broadcast packet on UDP port 704.

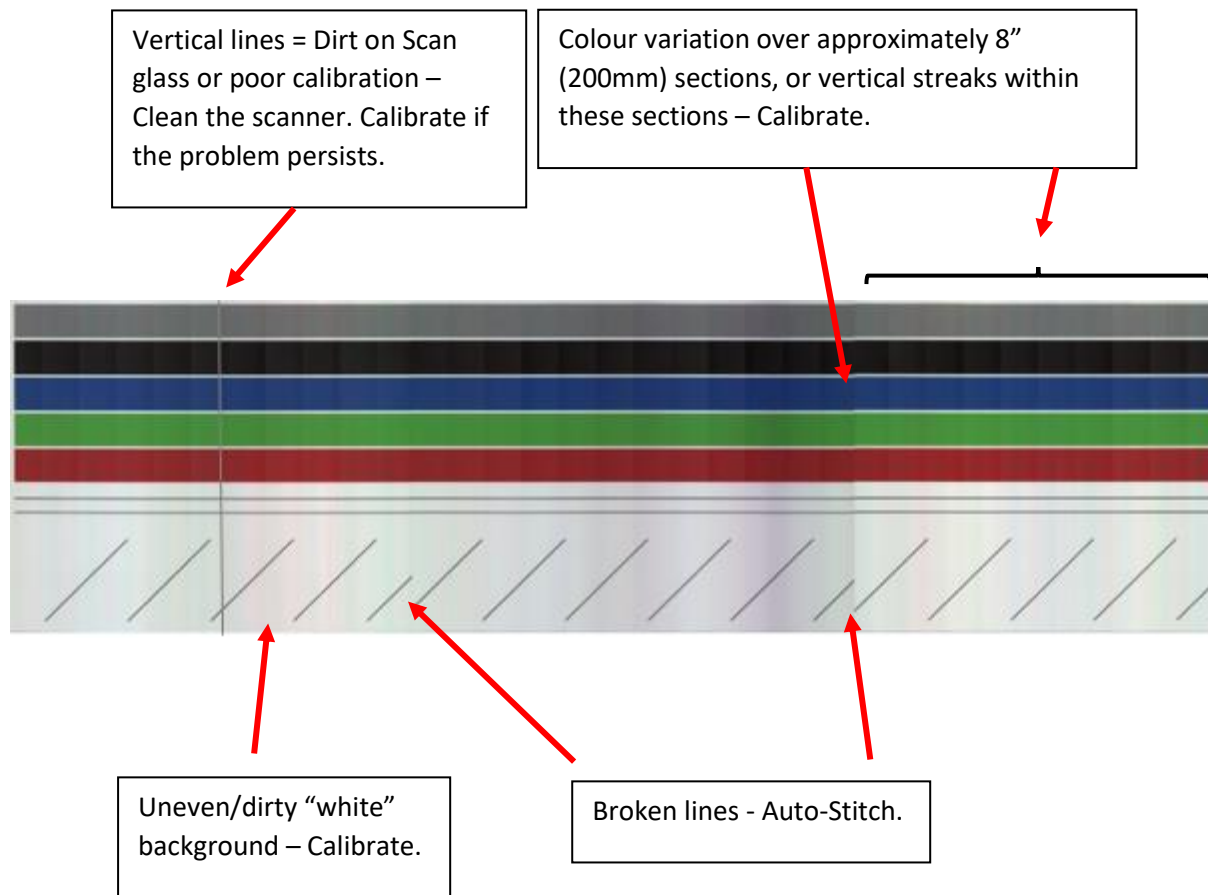
Supported Configurations

- Multiple L24ei or L36ei scanners, PCs running the ScanApp Lei and iPF67x/77x, TM-200/300/5200/5300 printers are supported on a single network.

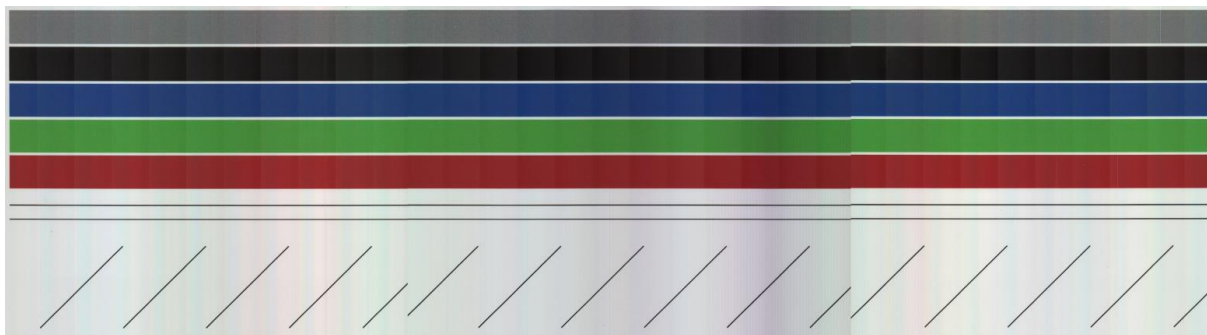


Image Quality

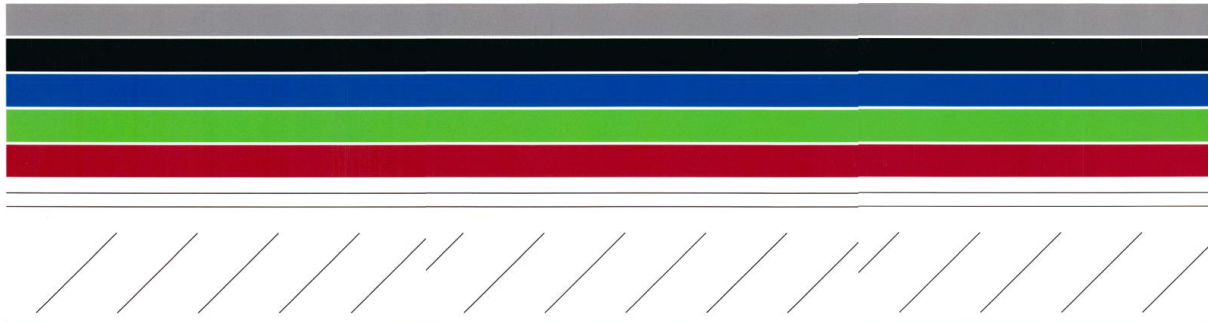
- The following scanned image shows possible image errors and the actions required to resolve them.



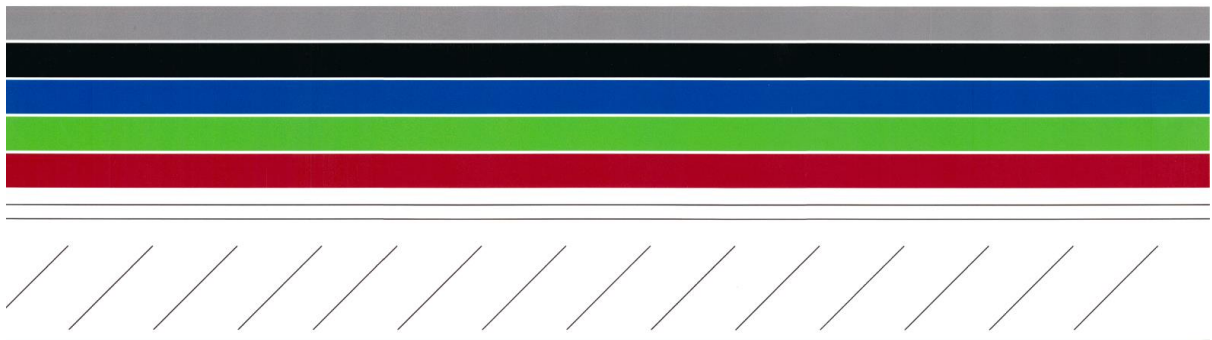
- Cleaning the scanner will remove most vertical lines. See [Cleaning](#)



- Calibrating the scanner will remove the streaking and clean up the white background. Calibration adjusts the optical sensitivity of each pixel in the sensor to give the correct levels of black and white.
See [Calibration](#)

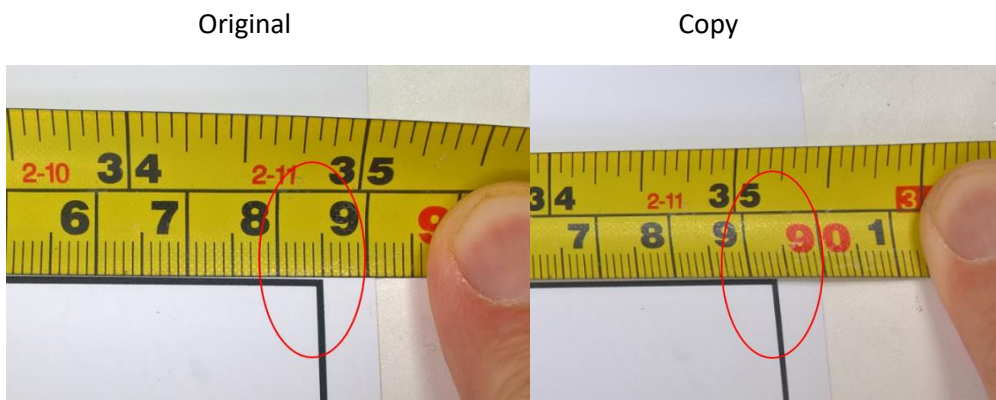


- Auto-stitch the scanner to align broken lines. Auto-stitch adjusts the electronic alignment of each segments of the scan sensor for both front to back and left to right alignment to avoid “stitch errors” at each intersection.
See [Stitch Adjustment](#)



Incorrect Scan or Copy length

- The drawing length on a scan file or a copy is not the same as on the original document. This can be corrected using the Scan Length Adjustment process.
See [Scan Length Adjustment](#)



Specifications

Name	L 24e, L 36e
Models (All regions)	L24ei / L36ei MFP scanner is ONLY able to print to iPF670/671/770/771, TM-200/300/5200/5300
Scan Technology	SingleSensor with multiple dual sided LED illumination
Illumination	L24ei: 64 LEDs, L36ei: 96 LEDs
Optical Resolution (dpi)	600dpi.
Resolutions for SCAN mode	Standard/High/Best = 200/300/600dpi
Resolutions for COPY mode (scan/print)	Standard/High/Best = 300/300, 300/600, 600/600dpi
Paper path	Face up, rear exit. Forward document transport only. Document return guide(s) included.
Scan width (inches)	24" and 36"
Min scan width	6.2" (16cm) for L24ei, 6" (15cm) for L36ei
Document width (inches)	26" and 38"
Max scan length	109" (2768mm)
Weight of scanner	L24ei = 5.28kg (11.6lbs) without Doc return guide L36ei = 6.56kg (14.5lbs) without Doc return guide
Dimensions width	L24ei = 935mm, L36ei = 1238mm
Dimensions height	131mm
Dimensions depth	Without Doc Return Guide - Paper tray folded: 146mm Without Doc Return Guide - Paper Tray flat: 193mm With Doc Return Guide - Paper tray folded: 206mm With Doc Return Guide - Paper Tray flat: 253mm
Max & Min Document thickness	Designed to scan Canon iPF printer CAD paper. Min = 0.07mm Max = 0.5mm
Scan accuracy	Accuracy 0.2% +/-1 pixel
Power Supply	External PSU: Input: 100 - 240V, 50-60Hz Output: 3.42A at 19V.
Max Power consumption	Standby (sleep): 0.6W Idle: 11.7W Scanning: 17.5w
Compliances	Energy Star Argentina/S mark Australia/C-Tick National/CB Canada/ICES-003, CUL China/CCC India/BIS Japan/VCCI Korea/KCC Mexico/NOM-019-SCFI Russia/EAC EU/CE USA/FCC USA/UL



































































































































Max scan speed (inches/sec)	<p>COPY 300/300dpi Standard = 1ips colour, 3ips mono 300/600dpi High = 1ips colour, 3ips mono 600/600dpi Best = 0.5ips colour, 1.5ips mono</p> <p>SCAN 200dpi Standard = 1ips colour, 3ips mono 300dpi High = 0.5ips colour, 1.5ips mono 600dpi Best = 0.33ips colour, 1ips mono</p>
Scan to USB	USB2, 128GB FAT32.
Scan to Network - ScanApp Lei	<p>ScanApp Lei - Sets scan directory.</p> <p>Minimum PC specification: • Windows® 7/8/10 - 32bit. • 100Mbps Ethernet. • Intel® Celeron, Core-Duo, Core-2-Duo or 2.8GHz Hyper-Threading (HT) or AMD® Dual-Core processors • 2GB RAM • High speed 7,200rpm Serial ATA (SATA) HDD with minimum 2GB for applications and 20GB free for images</p> <p>Suggested PC specification: • Windows® 7/8/10 - 64bit. • 100Mbps Ethernet. • Intel® i3, i5 or i7 processors • 4GB RAM • SATA 6.0Gbit/sec USB3 on the motherboard and SATA 6.0Gbit 7,200 rpm HDD controller.</p>
ScanApp Lei Software	Only L24ei and L36ei scanner models are supported by the ScanApp Lei. Scanning cannot be started remotely.
Modes	<p>Scan to USB - RGB/Greyscale/BW, TIFF (No ScanApp Lei) Scan to USB - RGB/Greyscale/BW, JPG, PDF, M-PDF (ScanApp Lei available) Scan to PC - RGB/Greyscale/BW, Tiff, JPEG, PDF, TiffG4, M-PDF Copy - RGB/Greyscale/BW Copy & Archive – (Combination of Copy and Scan to PC above). Cloud connectivity is achieved by using Direct Print & Share.</p>
Languages for L24ei/L36ei	English/Japanese
Languages for ScanApp Lei	English/French/German/Italian/Spanish/Simplified Chinese/Traditional Chinese/Korean/Russian/Portuguese/Japanese/Czech/Polish
Environment	Temp: 10-35C Humidity: 10-90%
Acoustic noise	L36ei - 50.6dB grey scan L24ei - 48.4dB grey scan

Note: Specifications are correct at the time of writing and are subject to change without notice.

Glossary of Terms

128GB	128 Giga Bytes. Size of memory.
ANSI	America National Standards Institute. Standard paper sizes definition.
ARCH	Architectural paper sizes. Standard paper sizes definition.
Auto-stitch	Adjusts the electronic alignment of each segments of the scan sensor for both front to back and left to right alignment to avoid “stitch errors” at each intersection.
Black Point.	Increase to darken the shadow areas of the image. Makes the blacks blacker.
Calibration	Adjusts the optical sensitivity of each pixel in the sensor to give the correct levels of black and white.
DHCP	Dynamic Host Configuration Protocol automatically provides a network device with its IP address.
DPI	Dots per Inch. The number of scan/print pixels per linear inch.
FAT32	File Allocation Table file system. FAT32 defines the structure data is saved in memory.
IP Address	Internet Protocol Address. Each device on a network has a different numerical label to identify it.
ISO	International Organization for Standardization. Standard paper sizes definition.
JPEG	Joint Photographic Experts Group file format is a commonly used method of lossy compression (data is thrown away to provide smaller files) for digital images.
LED illumination	Light Emitting Diode. Long lasting, efficient, bright light source.
LCD display	Liquide Crystal Display. User Interface screen.
PDF	Portable Document Format standard defined by ISO, which is independent of hardware or software. Scan images are usually embedded as JPEG files.
Static IP Address	A fixed Internet Protocol Address assigned at the device that cannot be changed by DHCP.
Subnet Mask	It divides the IP address into network address and host address. Without the subnet mask, the IP address is meaningless.
TIFF	Tagged Image File Format. The scan image is saved a loss-less, uncompressed file format. Results in larger file sizes, but no lost data.
USB	Universal Serial Bus. Memory sticks plug into devices using the USB port.
UI	User Interface.
White Point.	Increase to clean up a dirty background. Makes the whites whiter.
Windows® Tray App.	A small software application that runs in the background and provides messages to the user.

Icon Guide L24ei / L36ei – Function Settings:

-  Colour mode:
  Colour,
  Greyscale,
  Black and White
-  Quality Mode:
  Standard,
  High,
  Best
-  Document size:
  AUTO Auto width x length
  AUTO 24
  AUTO 36 24"/36" x auto length
-  ISO sizes:
  ISO A4
  ISO A3
  ISO A2
  ISO A1
  ISO A0
-  ANSI sizes:
  ANSI A
  ANSI B
  ANSI C
  ANSI D
  ANSI E
-  ARCH sizes:
  ARCH A
  ARCH B
  ARCH C
  ARCH D
  ARCH E
-  Orientation:
  Portrait,
  Landscape
-  Copy scale factor:
  25%
  35%
  50%
  71%
  100%
  141%
  200%
  283%
  287%
  400%
  432%
-  ISO sizes:
  ISO A4
  ISO A3
  ISO A2
  ISO A1
  ISO A0 Input size
-  ANSI sizes:
  ISO A4
  ISO A3
  ISO A2
  ISO A1
  ISO A0 Output size
-  ANSI sizes:
  ANSI A
  ANSI B
  ANSI C
  ANSI D
  ANSI E Input size
-  ANSI sizes:
  ANSI A
  ANSI B
  ANSI C
  ANSI D
  ANSI E Output size
-  ARCH sizes:
  ARCH A
  ARCH B
  ARCH C
  ARCH D
  ARCH E Input Size
-  ARCH sizes:
  ARCH A
  ARCH B
  ARCH C
  ARCH D
  ARCH E Output Size
-  Brightness:
 





 -3 to +3
-  White Point:
 





 0 to +6
-  Black Point:
 





 0 to +6
-  Crop:
  Off,
  On (Removes 3mm border)
-  Select iPF:
  AUTO
  1
  2
  3
  4
  5
  6
  7
  8
  9
-  Select PC:
  AUTO
  1
  2
  3
  4
  5
  6
  7
  8
  9

Icon Guide L24ei / L36ei – Scanner Settings:

- Scanner information.
- Save current Function Settings as default.
- Restore factory default Function Settings.
- Load Firmware.
- Calibration.
- Stitch adjustment.
- Scan length adjustment.
- ScanApp Mode: Standard, Plus.
- Define iPF#:
- Define PC#:
- Network Settings:
- Language: English, Japanese Text
- Engineer use only.

Information Messages:

- Scanner working
- Scanner open: Close the scanner.
- No paper: Load a document
- Dirty scanner: Clean scanner.