



Questo manuale d'istruzione è fornito da trovaprezzi.it. Scopri tutte le offerte per [Cooler Master GM34-CW](#) o cerca il tuo prodotto tra le [migliori offerte di Monitor](#)



Questo manuale d'istruzione è fornito da trovaprezzi.it. Scopri tutte le offerte per [Cooler Master Gaming GM34-CW](#) o cerca il tuo prodotto tra le [migliori offerte di Monitor](#)



GM34-CW COOLER MASTER 34" CURVED GAMING MONITOR

QUICK START GUIDE

CONTENTS

Instructions	1
Package Contents	2
Connect the Monitor to the Support Base	3
Installation of the Wall-mounted Bracket	5
External Control Buttons	6
Requirements and Safety Notice	7
Specifications	8

INSTRUCTIONS

Please read the following instructions carefully.

1. To clean the LCD monitor screen:

Turn off the LCD monitor and unplug the power cord.

Spray a non-solvent cleaning solution onto a rag and clean the screen gently.

2. Do not place the LCD monitor near a window. Exposing the monitor to rain, moisture or sunlight can severely damage it.

3. Do not apply pressure to the LCD screen. Excessive pressure may cause permanent damage to the display.

4. Do not remove the cover or attempt to service this unit yourself. An authorized technician should perform servicing of any nature

5. Store the LCD monitor in a room with a temperature of -20° to 60° C (-4° to 140° F). Storing the LCD monitor outside this range may result in permanent damage.

6. Immediately unplug your monitor and call an authorized technician if any of the following circumstances occur:

- Monitor-to-PC signal cable is frayed or damaged.
- Liquid spills onto the LCD monitor or the monitor is exposed to rain.
- The LCD monitor or case is damaged.

PACKAGE CONTENTS

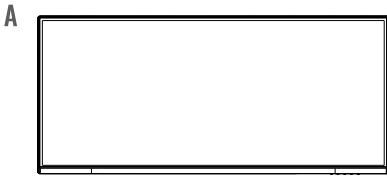

Monitor x 1

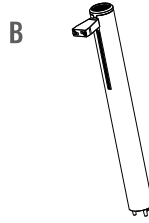

Lift monopod x 1

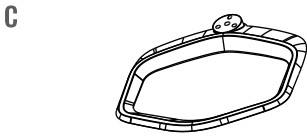

Support base x 1

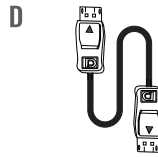

DP 1.4 x 1



AC power cord x 1



Screws x 1

(Used for installation of the wall-mounted adapters and the hinge reinforcing plate)

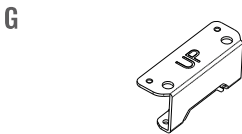

Wall-mounted adapter (up) x 1

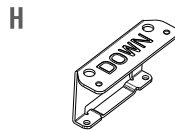

Wall-mounted adapter (down) x 1



Screws x 2

(Used for installation of the hinge cover assembly and support)



Screws x 1

(Used for installation of the support base and support arm)

CONNECT THE MONITOR TO THE SUPPORT BASE

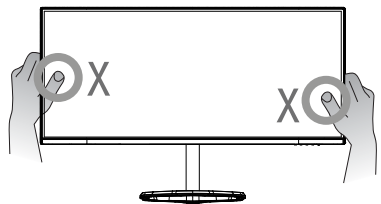
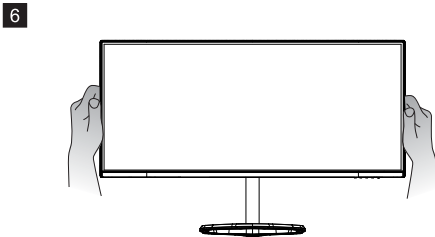
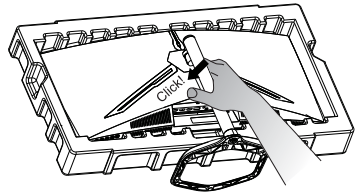
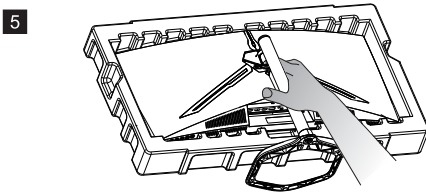
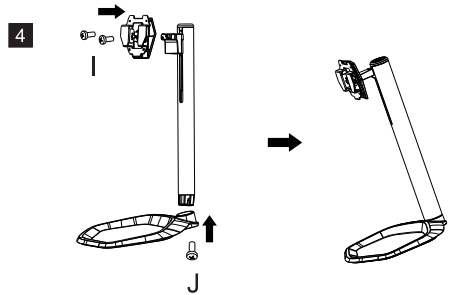
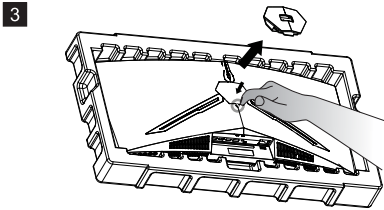
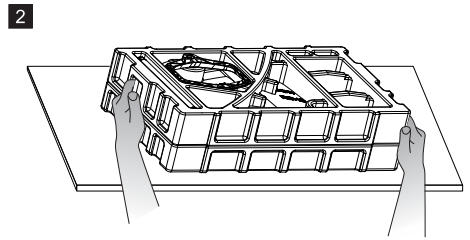
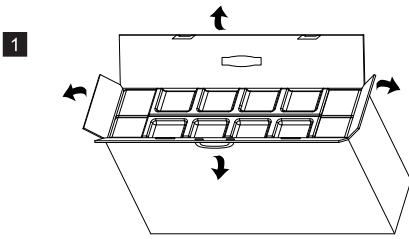

7

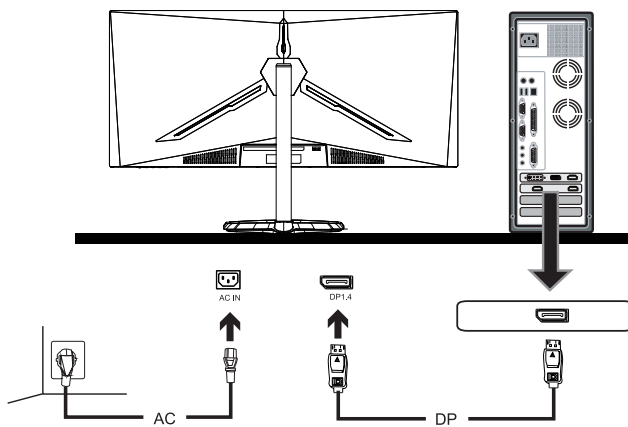

8

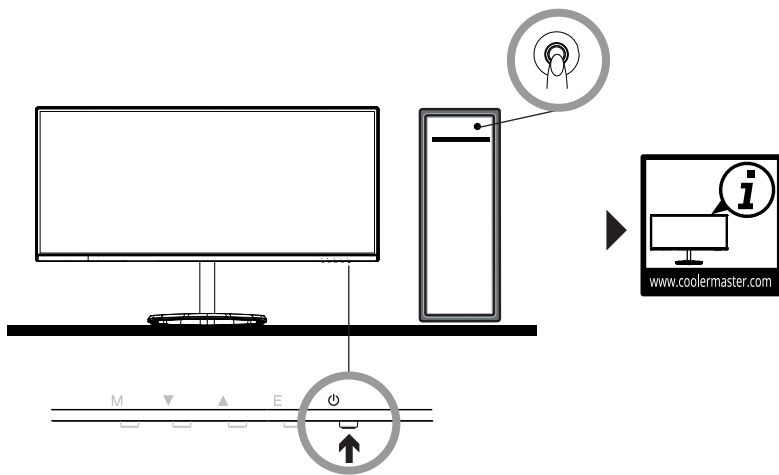



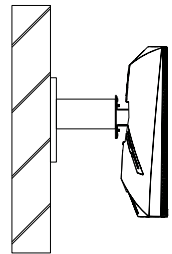
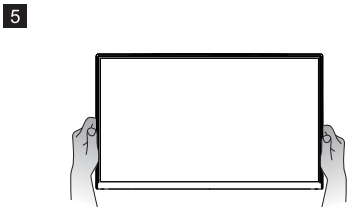
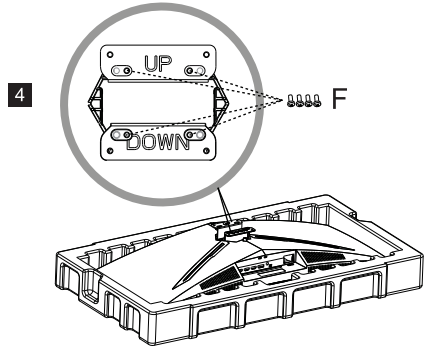
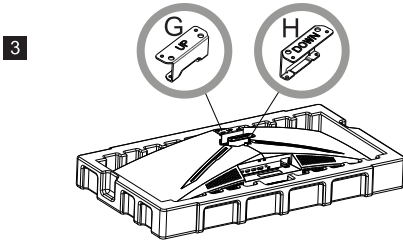
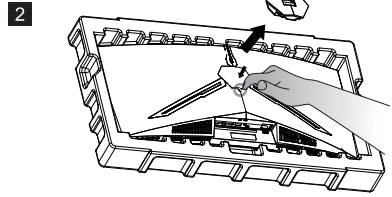
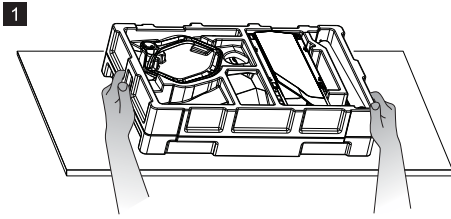

INSTALLATION OF THE WALL-MOUNTED BRACKET

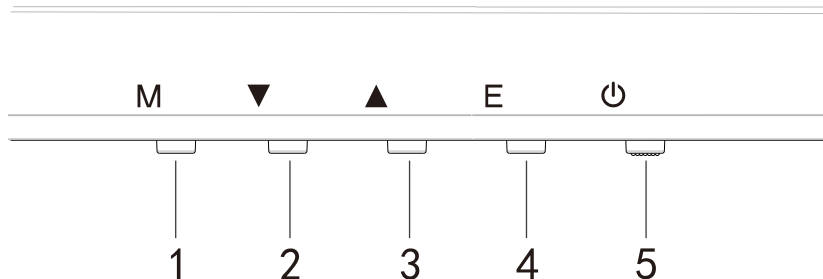

EXTERNAL CONTROL BUTTONS



Press any of the buttons to enter the quick navigation menu, i.e., to activate the Quick Mode

1		OSD menu	<ol style="list-style-type: none"> Press the button to enter the OSD menu to activate the Quick Mode After entering the OSD menu, press the button to enter submenu
2		Quick button for in-game crosshairs	<ol style="list-style-type: none"> Press the button under the Quick Mode to turn on in-game crosshairs When the OSD menu is activated, press the button for Down
3		Quick button for Scene Mode	<ol style="list-style-type: none"> Press the button to quickly switch between the Game and Graphic Scene Mode When the OSD menu is activated, press the button for Up
4		Quick button for HDR	<ol style="list-style-type: none"> Press the button under the Quick Mode to switch to HDR to turn on/off the Signal Mode When the OSD menu is activated, press the button to return to the last menu/exit the OSD menu
5		Power button	<p>Turn on/off the monitor. Blue indicates the power is on.</p> <p>Flashing blue light indicates the monitor is under Standby Mode</p>

FreeSync

Switch to the Game Mode to activate FreeSync+HDR

This function enables the graphic source supporting FreeSync to adjust the screen refresh rate of the monitor in a dynamic manner based on the energy-saving typical content frame rates. It is almost able to totally prevent screen tearing and stuttering display.



Note:

- DP: 3440 x 1440 can support 144Hz, Adaptive Sync
- HDMI: 3440 x 1440 can support 100Hz, Adaptive Sync

REQUIREMENTS AND SAFETY NOTICE

FCC Safety Notice

This product has been tested and determined to be meeting the limits for a Class B digital device and in compliance with Part 15 of the FCC Regulations. These requirements are set to reasonably protect the home installation environment from hazardous interference. This product will generate, use and emit radio frequency energy. Failure to install and use it as instructed may cause hazardous interference to radio communication.

However, we cannot guarantee zero interference for certain installation methods. If this product has caused hazardous interference to radio or TV reception (turn on or turn off this product to for confirmation), the user may try to make adjustment with the following methods:

- Re-adjust the angle and position of the reception antenna.
- Increase the distance between the device and receiver.
- Do not use the power sockets of the device and receiver together.
- If assistance is needed, contact the distributor or a professional radio/TV technician.

CE Compliance Statement

Cooler Master Technology Inc. hereby declares that the monitor conforms to the following key standards and other related provisions:

EMC Directive 2014/30/EU, Low Voltage Directive 2014/35/EU, RoHS Directive 2011/65/EU and Directive 2009/125/EC establishing a framework for the setting of eco-design requirements for energy-related products.

Note:

To prevent damage of the monitor, do not lift the monitor from the support base.

Note: Shielded cable

To comply with the EMC requirements, a shielded cable must be used for connection between this product and any other computer device.

Note:

The monitor is exclusively used in the video and image display of information acquired from electronic devices.

Note: Peripherals

Only a peripheral device (I/O device, terminal, printer, etc.) that has been certified and met the Class B limits can be sold together with this product. If this product is used together with any other uncertified peripheral device, it may cause interference to radio and TV reception.

Warning

Any change or modification not approved by the original manufacturer may lead to the user losing the right to operate this product. Such authorization is given by the Federal Communications Commission.

Requirements for Use

This product meets the limits under Part 15 of the FCC Regulations. When operating this product, please meet the following two requirements: (1) This product may not generate hazardous interference; and (2) This product must accept any interference signal received, including interference that is likely to lead to unexpected operation.

Disposal of Waste Equipment by Home Users in EU



If this symbol appears on a product and its package, it indicates that the product cannot be disposed of together with other household waste. You have to deliver the waste equipment to a designated recycling center for recycling of waste electrical and electronic equipment. Proper sorting and recycling of resources during the disposal of waste equipment is helpful for protecting natural resources and ensuring that resource recycling can protect human health and environment. For detailed information about recycling centers where waste equipment is disposed of, contact the local municipal office, cleaning service or the store where the purchased product is found.

SPECIFICATIONS

LCD panel	Drive system	TFT Color LCD
	Size	34"
	Pixel pitch	0.23175(H) - 0.23175(V)
	Brightness	400nits(Max.)
	Contrast	3000:1
	Viewing angle	178(Horizontal)178(Vertical)
	Response time	1ms (MPRT) , OD 4ms (G to G)
	Panel type	VA
	Horizontal frequency	71.52- 214.56 KHz
Vertical frequency	48- 165 Hz	
Display colors	16.7 million colors	
Max resolution	DP 1.4: 3440 x 1440 144Hz HDMI 2.0: 3440 x 1440 100Hz	
Power consumption	AC input power consumption	54W Typical,80W Max
	Standby power consumption (Max)	Standby≤0.5W
Input connector	DP (only for DP model) HDMI (only for HDMI model)	
Input video signal	DP signal (only for DP input model) HDMI signal (only for HDMI input model)	
Speakers	3W x 2	
Audio effect	Audio output (only for audio output model)	
Input	100-240V AC , 50/60Hz 2A	
Environmental conditions	Operating temperature: 0°C~40°C Storage temperature: -20°C~60°C Operating humidity: 10~85%RH	
Machine size	808.65*520.82*263.9mm	
Weight (Net)	6.2 kg/Unit (Net)	
Machine specifications	Inclination: -5° to 15° Rotation: Left or right rotation by 45° Height adjustable: Lift support base with 100mm travel Removable monopod: Yes	

Compliance



The terms HDMI and HDMI High Definition Multimedia Interface, and the HDMI Logo are trademarks or registered trademarks of HDMI Licensing Administrator, Inc. in the United States and other countries.

If you have any question regarding use of the monitor, please visit:
<https://www.coolermaster.com/warranty>