



Questo manuale d'istruzione è fornito da trovaprezzi.it. Scopri tutte le offerte per [Cooler Master GM27-FQS ARGB](#) o cerca il tuo prodotto tra le [migliori offerte di Monitor](#)

 [trovaprezzi.it](#)

Questo manuale d'istruzione è fornito da trovaprezzi.it. Scopri tutte le offerte per [Cooler Master GM27-FQS ARGB](#) o cerca il tuo prodotto tra le [migliori offerte di Monitor](#)



**GM27-FQS ARGB**  
**Cooler Master 27" Gaming Monitor**

# User Manual



【English】

# Table of Contents

Important Safety Instructions .....	1
Package Contents .....	2
Connect the monitor to the base .....	3
Adjusting the monitor .....	4
Wall Mount Installation Instructions .....	6
External Control Buttons .....	7
OSD Function Introductions.....	9
Main Menu .....	11
Specifications .....	17
Supported DP & HDMI & USB C Resolution.....	18
Video Timing .....	19
Declaration of Restricted Substances .....	20
Product Outline Dimensions .....	21

# Requirements and Safety Notice

## FCC Safety Notice

This product has been tested and determined to be meeting the limits for a Class B digital device and in compliance with Part 15 of the FCC Regulations. These requirements are set to reasonably protect the home installation environment from hazardous interference. This product will generate, use and emit radio frequency energy. Failure to install and use it as instructed may cause hazardous interference to radio communication. However, we cannot guarantee zero interference for certain installation methods. If this product has caused hazardous interference to radio or TV reception (turn on or turn off this product to for confirmation), the user may try to make adjustment with the following methods:

- Re-adjust the angle and position of the reception antenna.
- Increase the distance between the device and receiver.
- Do not use the power sockets of the device and receiver together.
- If assistance is needed, contact the distributor or a professional radio/TV technician.

## CE Compliance Statement

Cooler Master Technology Inc. hereby declares that the monitor conforms to the following key standards and other related provisions:

EMC Directive 2014/30/EU, Low Voltage Directive 2014/35/EU, RoHS Directive 2011/65/EU and Directive 2009/125/EC establishing a framework for the setting of eco-design requirements for energy-related products.

Note:

To prevent damage of the monitor, do not lift the monitor from the support base.

Note: Shielded cable

To comply with the EMC requirements, a shielded cable must be used for connection between this product and any other computer device.

Note:

The monitor is exclusively used in the video and image display of information acquired from electronic devices.

Note: Peripherals

Only a peripheral device (I/O device, terminal, printer, etc.) that has been certified and met the Class B limits can be sold together with this product. If this product is used together with any other uncertified peripheral device, it may cause interference to radio and TV reception.

## Warning

Any change or modification not approved by the original manufacturer may lead to the user losing the right to operate this product. Such authorization is given by the Federal Communications Commission.

## Requirements for Use

This product meets the limits under Part 15 of the FCC Regulations. When operating this product, please meet the following two requirements: (1) This product may not generate hazardous interference; and (2) This product must accept any interference signal received, including interference that is likely to lead to unexpected operation.

## Disposal of Waste Equipment by Home Users in EU



If this symbol appears on a product and its package, it indicates that the product cannot be disposed of together with other household waste. You have to deliver the waste equipment to a designated recycling center for recycling of waste electrical and electronic equipment. Proper sorting and recycling of resources during the disposal of waste equipment is helpful for protecting natural resources and ensuring that resource recycling can protect human health and environment. For detailed information about recycling centers where waste equipment is disposed of, contact the local municipal office, cleaning service or the store where the purchased product is found.

## Canadian Department of Communications Statement

This digital apparatus does not exceed the Class B limits for radio noise emissions from digital apparatus set out in the Radio Interference Regulations of the Canadian Department of Communications.

This class B digital apparatus complies with Canadian ICES-003.

This Class B digital apparatus meets all requirements of the Canadian Interference Causing Equipment Regulations.

Cet appareil numérique de la classe B respecte toutes les exigences du Règlement sur le matériel brouilleur du Canada.

# Important Safety Instructions

Please read the following instructions carefully.

1. To clean the LCD monitor screen:

Turn off the LCD monitor and unplug the power cord.

Spray a non-solvent cleaning solution onto a rag and clean the screen gently.

2. Do not place the LCD monitor near a window. Exposing the monitor to rain, moisture or sunlight can severely damage it.

3. Do not apply pressure to the LCD screen. Excessive pressure may cause permanent damage to the display.

4. Do not remove the cover or attempt to service this unit yourself.

An authorized technician should perform servicing of any nature







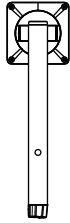
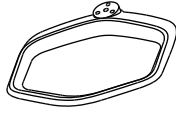
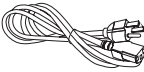
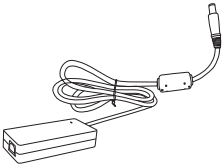

5. Store the LCD monitor in a room with a temperature of -20° to 60° C (- 4° to 140° F). Storing the LCD monitor outside this range may result in permanent damage.

6. Immediately unplug your monitor and call an authorized technician if any of the following circumstances occur:

- Monitor -to-PC signal cable is frayed or damaged.
- Liquid spills onto the LCD monitor or the monitor is exposed to rain.
- The LCD monitor or case is damaged.

# Package Contents

---

<p><b>A</b></p>  <p>Monitor x 1</p>	<p><b>B</b></p>  <p>Support stand x 1</p>	<p><b>C</b></p>  <p>Support base x 1</p>
<p><b>D</b></p>  <p>Power cord x 1</p>	<p><b>E</b></p>  <p>Power adapter x 1</p>	<p><b>F</b></p>  <p>HDMI cable x 1</p>
<p><b>G</b></p>  <p>DP cable x 1</p>	<p><b>H</b></p>  <p>Cable clip x 1 (Used for cable fixed in the back of the support stand)</p>	<p><b>I</b></p>  <p>Screws x 4 Screwdriver x 1 (Used for installation of the Back cover and support stand)</p>
<p><b>J</b></p>  <p>Base screw x 1 (Used for installation of the support base and support stand)</p>	<p><b>K</b></p>  <p>Micro USB to USB cable x1 (optional) (Used to light up ARGB stand)</p>	<p><b>L</b></p>  <p>USB Type A to B cable x 1 (optional) (PC and Monitor data transmission)</p>

---

# Connect the monitor to the base

1

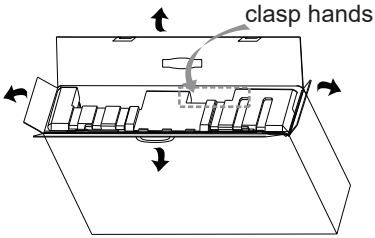

2

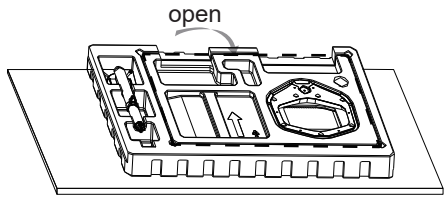

3

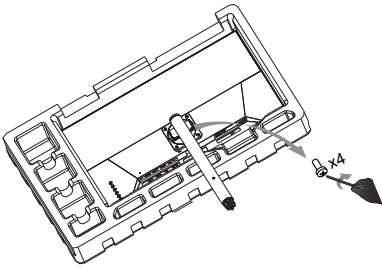

4

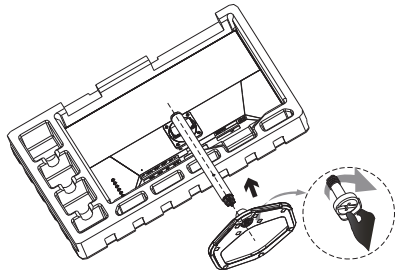

5

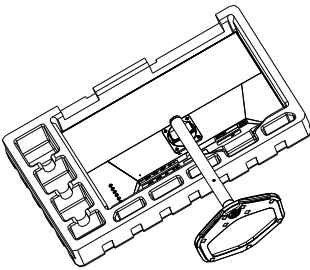

6

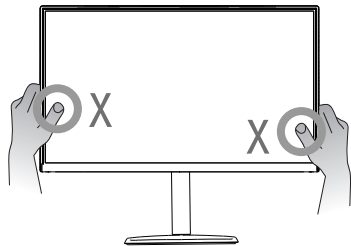
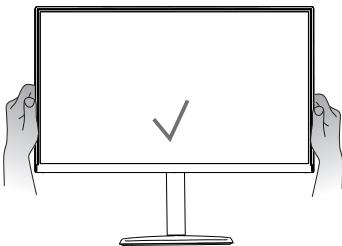

# Adjusting the monitor

- For the best results, it is recommended to look directly at the front of the monitor and make any adjusts as necessary.
- Ensure that the monitor is mounted upright on the stand base.
- When adjusting the monitor viewing angles, avoid touching the screen and hold the stand in order to prevent it from falling over.

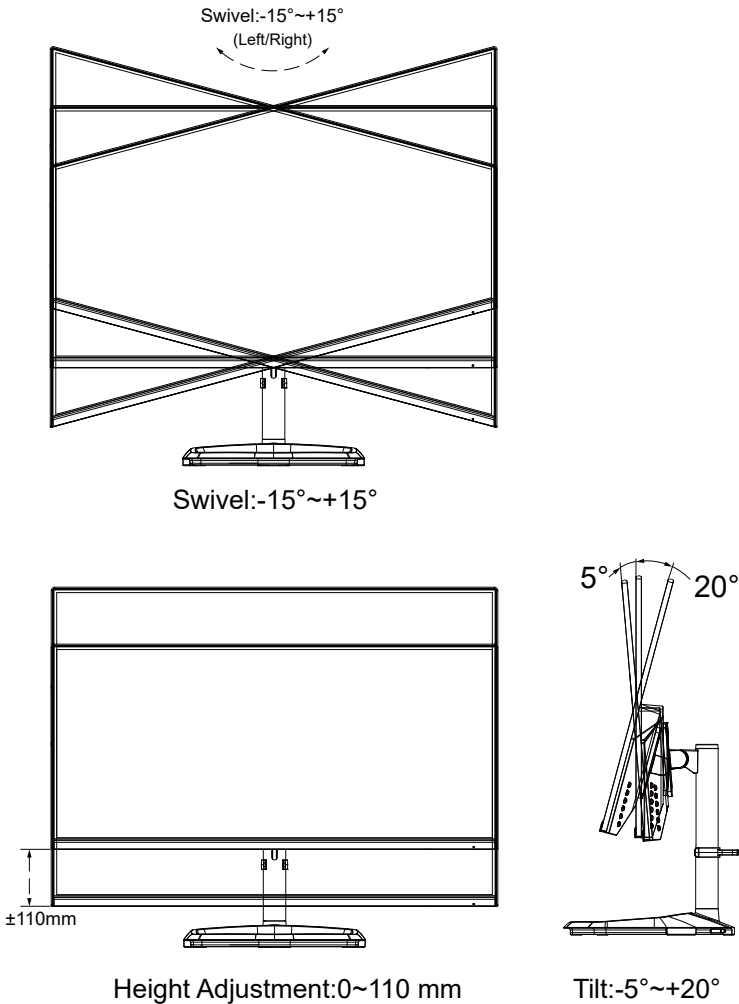

Note:It is normal that the monitor slightly shakes while you adjust the viewing angle.

7

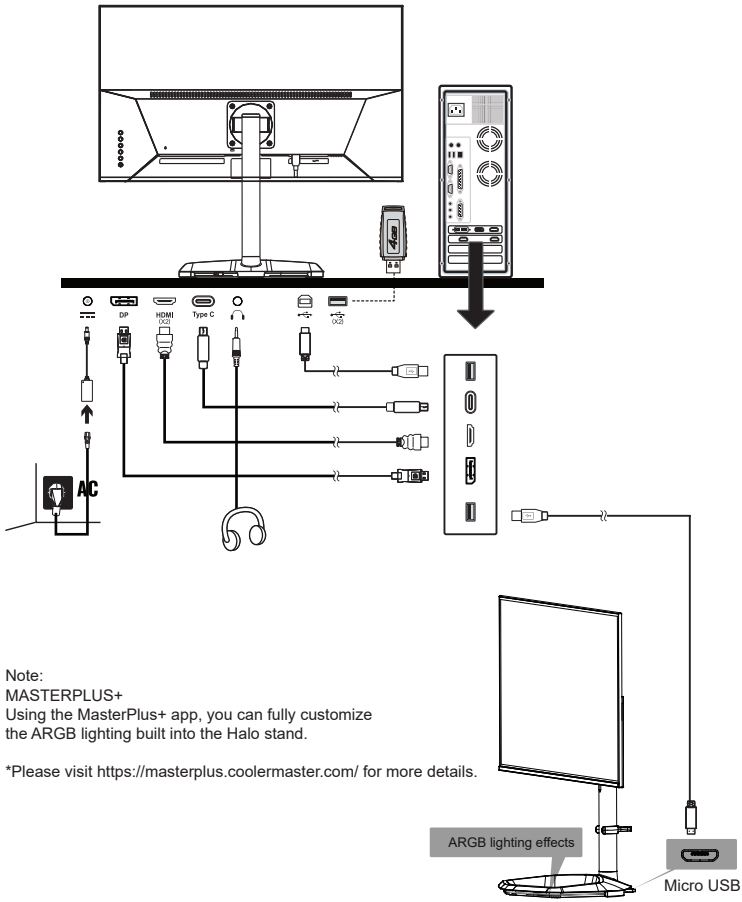

8

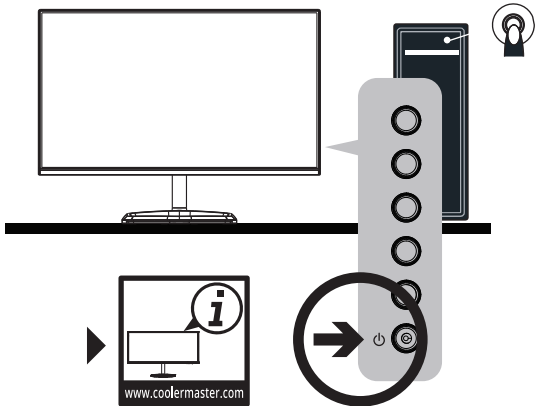

Note :

- 1.Type - C output voltage/current: 5V / 3 A
- 2.USB (x2) output voltage/current: 5V / 0.9A

# Wall Mount Installation Instructions

1

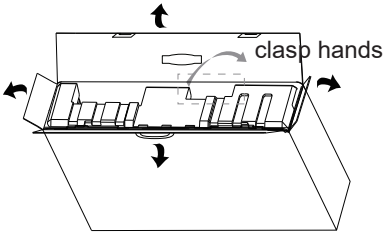

2

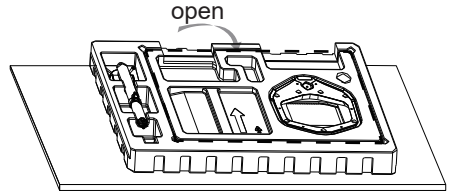

3

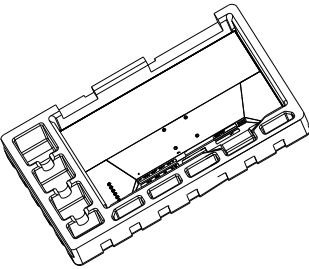

4

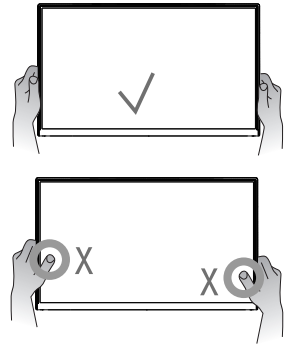

5

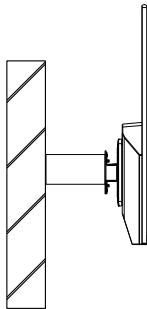

NOTE:

VESA SIZE:75 X75 MM;

Screw specification (back cover only) : M4X12mm

# External Control Buttons

Navigation buttons<①>: Press the navigation button to enter menu .  
<<options: Quick function option / Enter OSD menu options / Close fast navigation menu option >>, Adjust and navigate through the OSD menu based on the on-screen icons.

Power button<②>: Turn on/off the monitor.  
NOTE: Power light;  
Blue = ON;  
Orange = Power Saving.

Shortcut :

- Crosshair: When the screen display normal, gently press the button <③> to toggle the Crosshair function on/off.
- Picture Mode: Change and toggle through picture modes  
<options: Standard/Game/Movie/Web/Text/MAC/sRGB/Color Weakness Mode>
- Contrast/Brightness: Adjust contrast/brightness.
- Input Select: Select and change to different inputs.

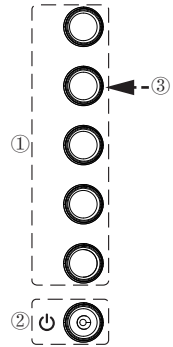

The OSD Menu and OSD Quick-Menu Symbol explanations and their functional uses are stated below.



Menu: Displays the full OSD menu.



Select: Enters the highlighted submenu or edits the selected menu entry.



Exit: Closes the OSD menu. Turns off the on-screen button labels.



Back: Goes back to the previous menu or exits editing an entry.



Up: Moves the highlight up.



Down: Moves the highlight down.



Left/Decrease: Moves the highlight to the left or decreases the displayed value when editing an entry.



Right/increase: Moves the highlight to the right or increases the displayed value when editing an entry.

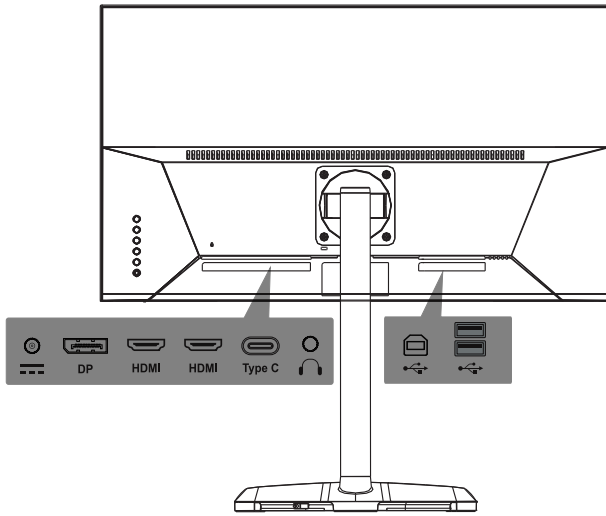

# OSD Function Introductions

Level1	Level2	Level3	Default Value	
Input Select	DisPlayport			
	HDMI1			
	HDMI2			
	TypeC			
Audio Adjust	Volume	0~100	50	
	Mute	On	Off	
Off				
Picture Mode	Standard	Black Stabilization	50	
		Advanced DCR	0	
		Blue Light Filter	0	
		Recall		
	Game	GAMER1	GAMER1	
		GAMER2		
		FPS1		
		FPS2		
		RTS		
	MOBA			
	Movie		Standard	
	Web			
	Text			
	MAC			
SRGB				
Color Weakness	Red Filter	10		
	Green Filter	10		
Color Adjust	Contrast/Brightness	Contrast	70	
		Brightness	100	
	6-axis Color*	Hue	Red	Native
			Green	
			Blue	
			Cyan	
			Magenta	
		Yellow		
		Saturation	Red	
			Green	
			Blue	
			Cyan	
	Magenta			
	Yellow			
	Color Temperature	Bluish	Native	
		Cool		
		Native		
		Warm		
		User Color		
	Gamma	1.8/2.0/2.2/2.4/2.6	2.2	
Color Domain	Auto	Auto		
	RGB Mode			
	YUV Mode			
Color Space	Auto	Auto		
	BT.709			
	DCI-P3			
	BT.2020			
Color Range	Auto	Auto		
	Full Range			
	Limited Range			
HDR				

# OSD Function Introductions

Manual Image Adjust	Sharpness	50		0~100
	Aspect Ratio	Full Aspect Ratio		Full Screen
		Full Screen		
Overscan	On		Off	
	Off			
Setup Menu	Language Select	English		English
		Français		
		Deutsch		
		Español		
		Italiano		
		Suomi		
		РУССКИЙ		
		日本語		
		한국의		
		繁體中文		
		简体中文		
		T i e n g V i e t		
	Adaptive-Sync	On		Off
		Off		
	Over Drive	Off		
		Normal		
		Advanced		
		Ultra Fast		
	Motion clearness	On		Off
		Off		
	Crosshair*	H/V.Position	H.Position	50
			V.Position	50
		Pixel Color		R (100)
				G (0)
				B (0)
		Style	Mode 1	Mode 1
			Mode 2	
			Mode 3	
	Mode 4			
	Frame Rate Notice	On		Off
		Off		
	Information	Resolution: xx H. Frequency: xx V.Frequency: xx Pixel Clock: xx		
	OSD Timeout	0~60		15
OSD Background	On		On	
	Off			
Power Indicator	On		On	
	Off			
Auto Power off	On		Off	
	Off			
Sleep	30 Minutes		Off	
	45 Minutes			
	60 Minutes			
	120 Minutes			
ECO Mode	Standard		Standard	
	Optimize			
	Conserve			
DDC/CI	ON		ON	
	Off			
Memory Recall				

\* When the screen display normal, gently press the button <③> to toggle the Crosshair function on/off

# Main Menu

## Input Select

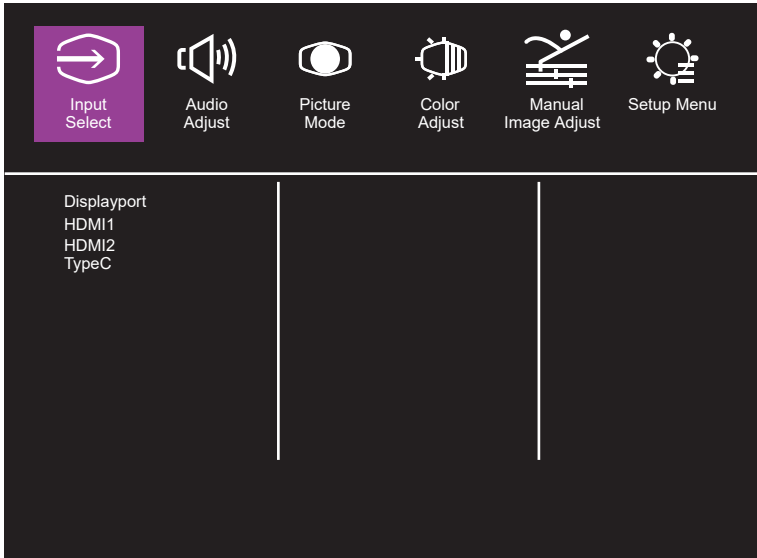

Enter the input menu to switch the input signal.

1.DP : Adaptive Sync supported under 2560x1440

2.HDMI : Adaptive Sync supported under 2560x1440

## Audio Adjust

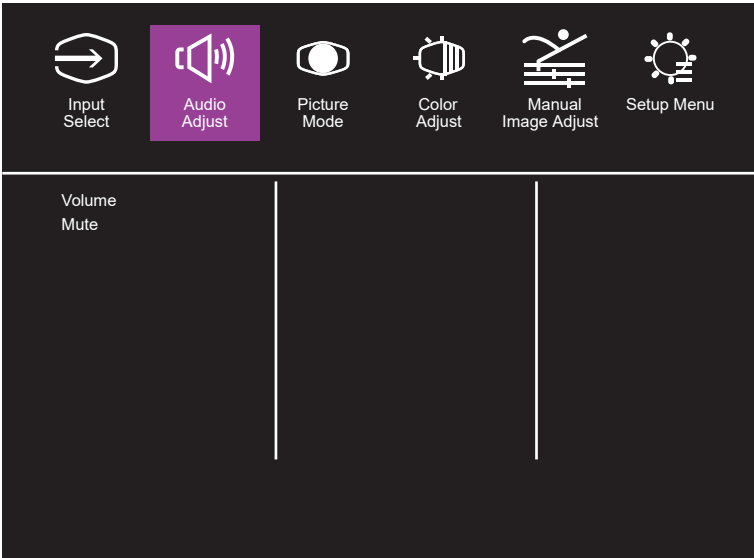

Enter the Audio menu to adjust functions including Mute function, Volume, and Audio Source etc.

1.Mute: Enables or disables the mute function.

2.Volume: Adjust the volume value between 0 and 100.

Audio Source: Select the audio source input port.

# Picture Mode

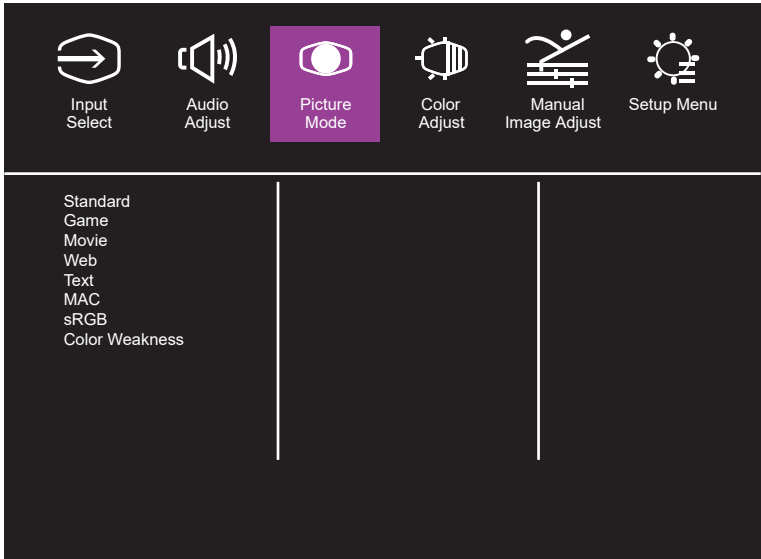





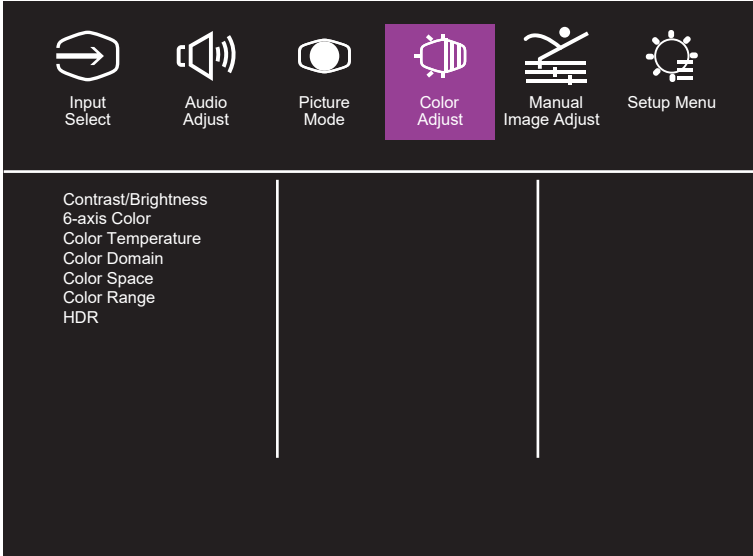

Note: Picture all kinds of choice model

## Color Adjust









## Image color adjustment











# Manual Image Adjust

 Input Select	 Audio Adjust	 Picture Mode	 Color Adjust	 Manual Image Adjust	 Setup Menu
Sharpness Aspect Ratio Overscan					

# Setup Menu

 Input Select	 Audio Adjust	 Picture Mode	 Color Adjust	 Manual Image Adjust	 Setup Menu
Language Select Adaptive-Sync motion clearness Crosshair Resolution Notice Information OSD Timeout OSD Background Power Indicator Auto Power Off Sleep ECO Mode					

# Specifications

LCD panel	Size	27"
	Pixel pitch	0.2331(H) x 0.2331(V)
	Brightness	300nits(Typ.)
	Contrast	1000:1(Typ.)
	Viewing angle	178(Horizontal)/178(Vertical)
	Response time	1ms (MPRT)
Display colors		16.7 million colors
Max. display frequency (Resolution H*V/Fv)		2560*1440@144Hz(HDMI) 2560*1440@165Hz(DP)
Power consumption	Power On	30W** Typical
	Standby	≤0.5W
	Power Off	≤0.3W
Input/output connector		DP x 1, HDMI x 2, USB type C x 1; Earphone jack x 1; Downstream(USB3.0) x 2; Upstream(USB3.0) x 1
Input video signal		DP signal (only for DP input model); HDMI signal (only for HDMI input model); Type C signal (only for Type C input model)
Audio effect		Audio output (only for audio output model)
Adapter		DC12 --- 7A
Environmental conditions		Operating temperature:0°C~40°C; Storage temperature:-20°C~60°C; Operating humidity:10~85%RH
Machine size(L x Wx H)		614X43X357mm(Without stand/Base) 614X274X610mm(Contains Support stand/Base)
Box Dimension(WxHxD)		830X126X500mm
Gross Weight(Esti.)		7.5kg/Unit
Weight (Net)		3.65 kg/Unit (Without stand/Base); 5.1 kg/Unit (Contains Support stand/Base)
Machine specifications		Height Adjustment: 0~110 mm Swivel: -15°~+15° Pivot: Horizontal / Vertical Tilt: -5°~+20°
Compliance		
        		
 <p>HIGH-DEFINITION MULTIMEDIA INTERFACE</p>		
<p>The terms HDMI and HDMI High-Definition Multimedia Interface, and the HDMI Logo are trademarks or registered trademarks of HDMI Licensing Administrator, Inc. in the United States and other countries.</p>		

If you have any question regarding use of the monitor, please visit:

<https://www.coolermaster.com/warranty>

\*Specifications are subject to change without notice.

\*\*Measure a screen brightness of 200 nits without audio/USB/Card reader connection.

# Supported Timing

Mode	Resolution	Horizontal Frequency (KHz)	Vertical Frequency (Hz)	Nominal Pixel Clock (MHz)	Port	
					HDMI IN	DP/Type C IN
VGA	640x480@60Hz	31.469	59.940	25.175	○	○
	640x480@72Hz	37.861	72.809	31.500	○	○
	640x480@75Hz	37.500	75.000	31.500	○	○
MAC	640x480@66.66Hz	35.000	66.667	30.240	○	○
VESA	720x400@70Hz	31.469	70.087	28.322	○	○
SVGA	800x600@56Hz	35.156	56.250	36.000	○	○
	800x600@60Hz	37.879	60.317	40.000	○	○
	800x600@72Hz	48.077	72.188	50.000	○	○
	800x600@75Hz	46.875	75.000	49.500	○	○
MAC	832x624@74.55Hz	49.722	74.550	57.280	○	○
XGA	1024x768@60Hz	48.363	60.004	65.000	○	○
	1024x768@70Hz	56.476	70.069	75.000	○	○
	1024x768@75Hz	60.023	75.029	78.750	○	○
VESA	1152x864@75Hz	67.500	75.000	108.000	○	○
	1280x960@60Hz	60.000	60.000	108.000	○	○
SXGA	1280x1024@60Hz	63.981	60.020	108.000	○	○
	1280x1024@75Hz	79.976	75.025	135.000	○	○
VESA	1280x720@60Hz	45.000	60.000	74.250	○	○
WXGA+	1366x768@60Hz	47.712	59.790	85.500	○	○
WXGA+	1440x900@60Hz	55.935	59.887	106.500	○	○
WSXGA+	1680x1050@60Hz	65.290	59.954	146.250	○	○
FHD	1920x1080@60Hz	67.500	60.000	148.500	○	○
	1920x1080@120Hz	135.000	120.000	297.000	○	○
	1920x1080@165Hz	183.000	165.000	380.950	○	○
QHD	2560x1440@60Hz	88.787	59.951	241.500	○	○
	2560x1440@120Hz	177.000	120.000	483.430	○	○
	2560x1440@144Hz	213.000	144.000	580.000	○	○
	2560x1440@165Hz	244.000	165.000	644.700	○	○

# Video Timing

CEA Video Timing						
Resolution	Field Rate (Hz)	Horizontal (kHz)	Vertical (Hz)	Pixel Clock (MHz)	Port	
					HDMI IN	DP/Type C IN
640x480p	60	31.500	60.00	25.200	○	○
720x480p	60	31.500	60.00	27.027	○	○
720x480p	60	31.500	60.00	27.027	○	○
1280x720p	60	45.000	60.00	74.250	○	○
1920x1080i	60	33.750	60.00	74.250	○	○
1920x1080p	60	67.500	60.00	148.500	○	○
720x576p	50	31.250	50.00	27.000	○	○
720x576p	50	31.250	50.00	27.000	○	○
1280x720p	50	37.500	50.00	74.250	○	○
1920x1080i	50	28.125	50.00	74.250	○	○
1920x1080p	50	56.250	50.00	148.500	○	○
1920x1080p	24	27.000	24	74.250	○	○
1920x1080p	25	28.125	25.00	74.250	○	○
1920x1080p	30	33.750	30	74.250	○	○
3840x2160p	60	135.000	60.00	594.00	○	○
3840x2160p	60	135.000	60.00	594.00	○	

# Declaration of Restricted Substances

Equipment name : LCD Monitor		Type designation (Type): GM27-FQS ARGB				
Unit	Restricted substances and its chemical symbols					
	Lead (Pb)	Mercury (Hg)	Cadmium (Cd)	Hexavalent chromium (Cr <sup>+6</sup> )	Polybrominated biphenyls (PBB)	Polybrominated diphenyl ethers (PBDE)
Internal and external cases (External case, case, support...)	<input type="radio"/>	<input type="radio"/>	<input type="radio"/>	<input type="radio"/>	<input type="radio"/>	<input type="radio"/>
Main Board	—	<input type="radio"/>	<input type="radio"/>	<input type="radio"/>	<input type="radio"/>	<input type="radio"/>
Other Circuit Boards	—	<input type="radio"/>	<input type="radio"/>	<input type="radio"/>	<input type="radio"/>	<input type="radio"/>
LCD Display Panel	<input type="radio"/>	<input type="radio"/>	<input type="radio"/>	<input type="radio"/>	<input type="radio"/>	<input type="radio"/>
Speakers	<input type="radio"/>	<input type="radio"/>	<input type="radio"/>	<input type="radio"/>	<input type="radio"/>	<input type="radio"/>
Base	<input type="radio"/>	<input type="radio"/>	<input type="radio"/>	<input type="radio"/>	<input type="radio"/>	<input type="radio"/>
Power Supply (Switching adapter)	—	<input type="radio"/>	<input type="radio"/>	<input type="radio"/>	<input type="radio"/>	<input type="radio"/>
Accessories (Power cable, HDMI signal cable...)	<input type="radio"/>	<input type="radio"/>	<input type="radio"/>	<input type="radio"/>	<input type="radio"/>	<input type="radio"/>
Other fixed components (Screws, clamps, latches)	<input type="radio"/>	<input type="radio"/>	<input type="radio"/>	<input type="radio"/>	<input type="radio"/>	<input type="radio"/>
<p>Note 1 : “Exceeding 0.1 wt %” and “exceeding 0.01 wt %” indicate that the percentage content of the restricted substance exceeds the reference percentage value of presence condition.</p> <p>Note 2 : “○” indicates that the percentage content of the restricted substance does not exceed the percentage of reference value of presence.</p> <p>Note 3 : The “—” indicates that the restricted substance corresponds to the exemption.</p>						

# Product Outline Dimensions

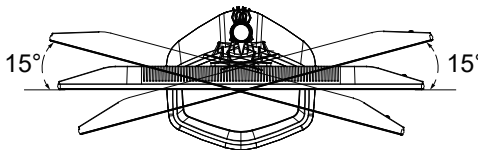
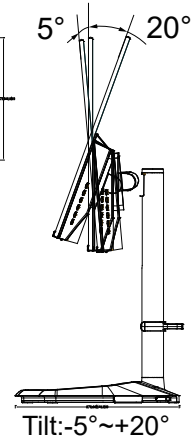
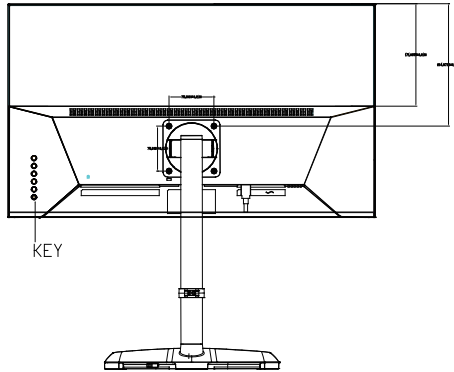
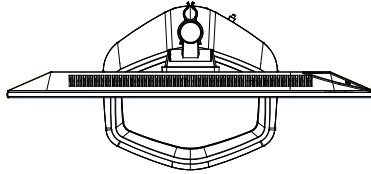
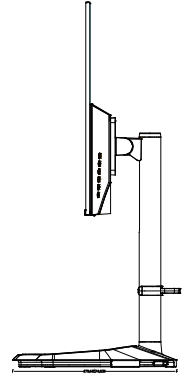
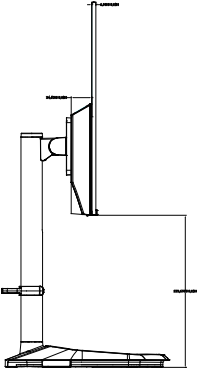
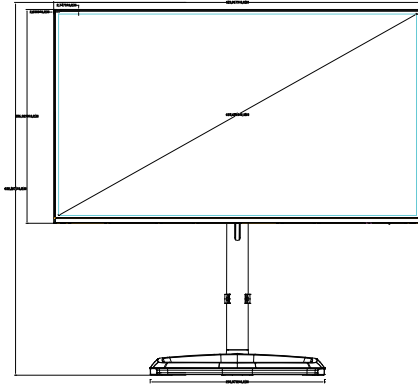
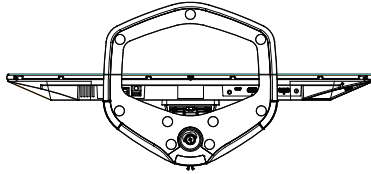

Swivel: -15°~+15°