



Questo manuale d'istruzione è fornito da [trovaprezzi.it](https://trovaprezzi.it). Scopri tutte le offerte per [Cooler Master GM34-CWQ2](#) o cerca il tuo prodotto tra le [migliori offerte di Monitor](#)

 [trovaprezzi.it](https://trovaprezzi.it)

Questo manuale d'istruzione è fornito da [trovaprezzi.it](https://trovaprezzi.it). Scopri tutte le offerte per [Cooler Master GM34-CWQ2](#) o cerca il tuo prodotto tra le [migliori offerte di Monitor](#)



**GM34-CWQ2**  
**GM34-CWQ2 ARGB**  
**Cooler Master 34" Gaming Monitor**

# User Manual



# Table of Contents

- Requirements and Safety Notice** .....1
- Important Safety Instructions** .....3
- Package Contents** ..... 4
- Installing the Monitor Arm/Base** ..... 5
- Adjusting the Monitor** ..... 7
- Wall Mount Installation Instructions** ..... 8
- External Control Buttons** ..... 9
- Main Menu** ..... 10
  - Input ..... 10
  - Picture ..... 10
  - Color Adjustment ..... 12
  - Gaming..... 12
  - Advanced Settings..... 13
  - System ..... 14
- Specifications**..... 15
- Supported Timing**.....16
  - PC Timing..... 16
  - Video Timing ..... 17
- Product Outline Dimensions** .....17

# Requirements and Safety Notice

## FCC Safety Notice

This product has been tested and determined to be meeting the limits for a Class B digital device and in compliance with Part 15 of the FCC Regulations. These requirements are set to reasonably protect the home installation environment from hazardous interference. This product will generate, use and emit radio frequency energy. Failure to install and use it as instructed may cause hazardous interference to radio communication. However, we cannot guarantee zero interference for certain installation methods. If this product has caused hazardous interference to radio or TV reception (turn on or turn off this product to for confirmation), the user may try to make adjustment with the following methods:

- Re-adjust the angle and position of the reception antenna.
- Increase the distance between the device and receiver.
- Do not use the power sockets of the device and receiver together.
- If assistance is needed, contact the distributor or a professional radio/TV technician.

## CE Compliance Statement

Cooler Master Technology Inc. hereby declares that the monitor conforms to the following key standards and other related provisions:

EMC Directive 2014/30/EU, Low Voltage Directive 2014/35/EU, RoHS Directive 2011/65/EU and Directive 2009/125/EC establishing a framework for the setting of eco-design requirements for energy-related products.

### Note:

To prevent damage of the monitor, do not lift the monitor from the support base.

Note: Shielded cable

To comply with the EMC requirements, a shielded cable must be used for connection between this product and any other computer device.

### Note:

The monitor is exclusively used in the video and image display of information acquired from electronic devices.

Note: Peripherals

Only a peripheral device (I/O device, terminal, printer, etc.) that has been certified and met the Class B limits can be sold together with this product. If this product is used together with any other uncertified peripheral device, it may cause interference to radio and TV reception.

## Warning

Any change or modification not approved by the original manufacturer may lead to the user losing the right to operate this product. Such authorization is given by the Federal Communications Commission.

## Requirements for Use

This product meets the limits under Part 15 of the FCC Regulations. When operating this product, please meet the following two requirements: (1) This product may not generate hazardous interference; and (2) This product must accept any interference signal received, including interference that is likely to lead to unexpected operation.

The following local Manufacturer/Importer is responsible for this declaration.

**Product Name:** LCD Monitor  
**Model No:** GM34-CWQ2, GM34-CWQ2 ARGB  
**Company Name:** North America - CMI USA, Inc.  
**Address:** 1 N Indian Hill Blvd Suite 200, Claremont, CA 91711, USA  
**Contact Person:** Cooler Master Representative  
**Phone No:** +1-888-624-5099

## Note: Canadian users

This Class B digital device complies with Canadian ICES-003 specifications.

### Remarque à l'intention des utilisateurs canadiens

Cet appareil numérique de la classe B est conforme à la norme NMB-003 du Canada

## Disposal of Waste Equipment by Home Users in EU



If this symbol appears on a product and its package, it indicates that the product cannot be disposed of together with other household waste. You have to deliver the waste equipment to a designated recycling center for recycling of waste electrical and electronic equipment. Proper sorting and recycling of resources during the disposal of waste equipment is helpful for protecting natural resources and ensuring that resource recycling can protect human health and environment. For detailed information about recycling centers where waste equipment is disposed of, contact the local municipal office, cleaning service or the store where the purchased product is found.

## 电子电气产品有害物质限制使用标识要求

本产品有害物质的名称及含量标识如下表：

部件名称	有害物质					
	铅 (Pb)	汞 (Hg)	镉 (Cd)	六价铬 (Cr (VI))	多溴联苯 (PBB)	多溴联苯醚 (PBDE)
外壳	○	○	○	○	○	○
电路板组件*	×	○	○	○	○	○
电源线/适配器	×	○	○	○	○	○
外部信号连接线	×	○	○	○	○	○
液晶面板	×	○	○	○	○	○

本表格依据 SJ/T 11364 的规定编制。

\*：电路板组件包括印刷电路板及其构成的零部件，如电阻、电容、集成电路、连接器等

○：表示该有害物质在该部件所有均质材料中的含量均在 GB/T26572 规定的限量要求以下。

×：表示该有害物质至少在该部件的某一均质材料中的含量超出 GB/T26572 规定的限量要求。

## 限用物質含有情況標示聲明書

單元 Unit	限用物質及其化學符號 Restricted substances and its chemical symbols					
	鉛Lead (Pb)	汞Mercury (Hg)	鎘Cadmium (Cd)	六價鉻Hexavalent chromium (Cr <sup>+6</sup> )	多溴聯苯Polybrominated biphenyls (PBB)	多溴二苯醚Polybrominated diphenyl ethers (PBDE)
支架/外殼	○	○	○	○	○	○
印刷電路板	—	○	○	○	○	○
玻璃面板	—	○	○	○	○	○
電纜/電線/連接線	—	○	○	○	○	○
電源設備/外接電源供應器	—	○	○	○	○	○

備考1. “超出0.1 wt %”及“超出0.01 wt %”係指限用物質之百分比含量超出百分比含量基準值。

備考2. “○”係指該項限用物質之百分比含量未超出百分比含量基準值。

備考3. “—”係指該項限用物質為排除項目。

# Important Safety Instructions

Please read the following instructions carefully.

1. To clean the LCD monitor screen:

Turn off the LCD monitor and unplug the power cord.

Spray a non-solvent cleaning solution onto a rag and clean the screen gently.

2. Do not place the LCD monitor near a window. Exposing the monitor to rain, moisture or sunlight can severely damage it.

3. Do not apply pressure to the LCD screen. Excessive pressure may cause permanent damage to the display.

4. Do not remove the cover or attempt to service this unit yourself.

An authorized technician should perform servicing of any nature

5. Store the LCD monitor in a room with a temperature of -20° to 60° C (- 4° to 140° F). Storing the LCD monitor outside this range may result in permanent damage.

6. Immediately unplug your monitor and call an authorized technician if any of the following circumstances occur:

- Monitor to PC signal cable is frayed or damaged.
- Liquid spills onto the LCD monitor or the monitor is exposed to rain.
- The LCD monitor or case is damaged.

# Package Contents

---

A

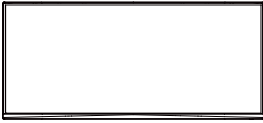

Monitor

B

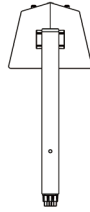

Support stand

C



Support base

---

D



Power cord (Optional)

E



HDMI cable (Optional)

F



DP cable (Optional)

---

G



Cable clip

(Used for cable fixed in the back of the support stand)

H



Base screws

(Used for installation of the support base and support stand)

I



Micro USB to USB Type A cable (Optional)

(Used to light up ARGB stand)

---

J

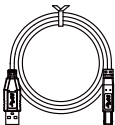

USB Type A to B cable (Optional)

(PC and Monitor data transmission)

---

# Installing the Monitor Arm/Base

1

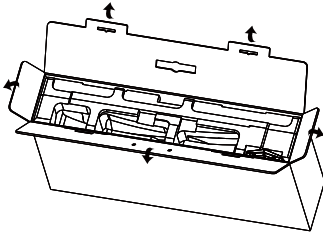

2

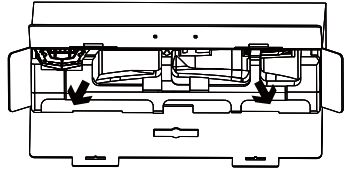

3

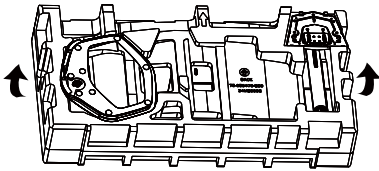

4

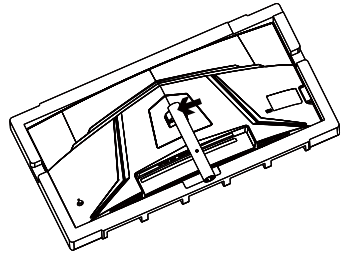

5

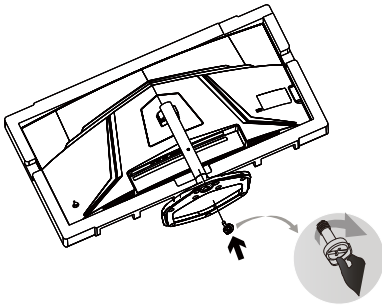

6

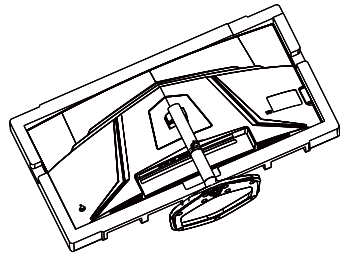

7

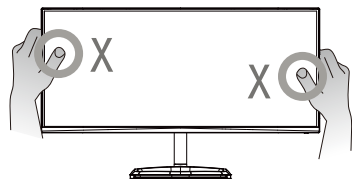
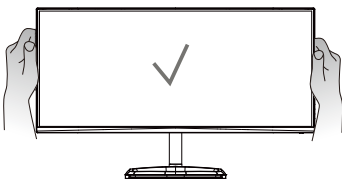

8

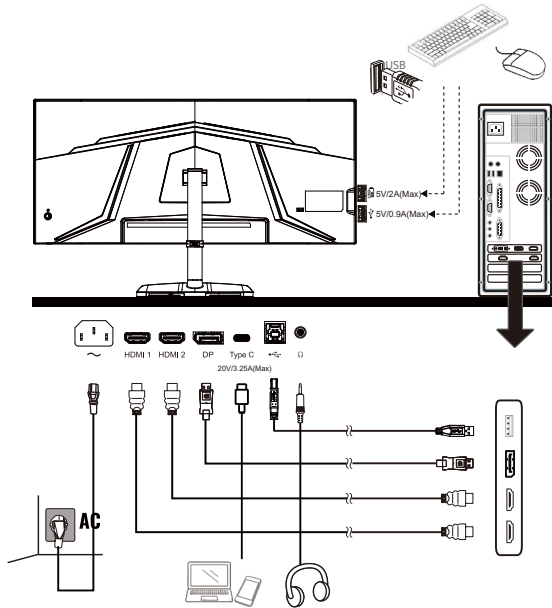

9

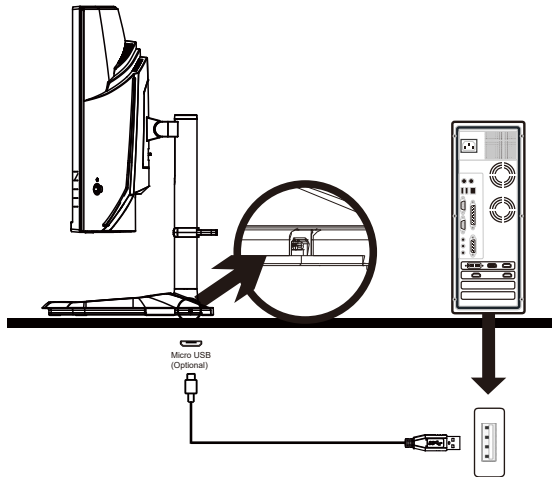

NOTE: The USB port on the base is only available for Model GM34-CWQ2 ARGB.

MASTERPLUS+

Using the MasterPlus+ app, you can fully customize the ARGB lighting built into the Halo stand.

\*Please visit <https://masterplus.cooler-master.com/> for more details.

10

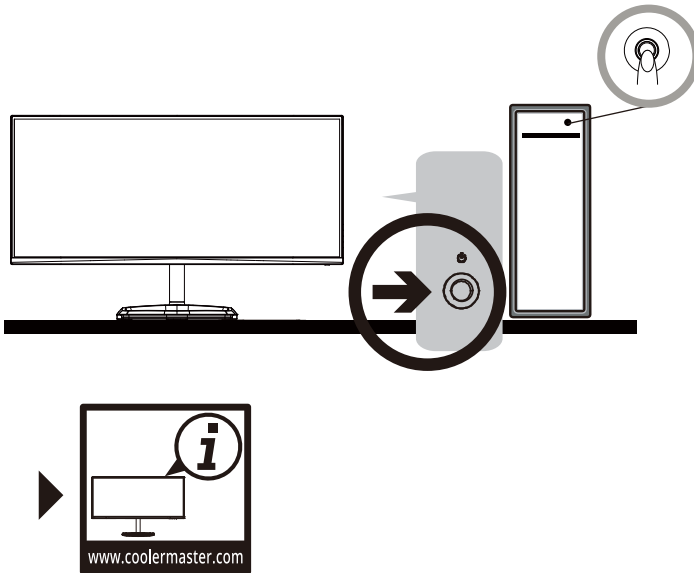

## Adjusting the Monitor

- For the best results, it is recommended to look directly at the front of the monitor and make any adjusts as necessary.
- Ensure that the monitor is mounted upright on the stand base.
- When adjusting the monitor viewing angles, avoid touching the screen and hold the stand in order to prevent it from falling over.

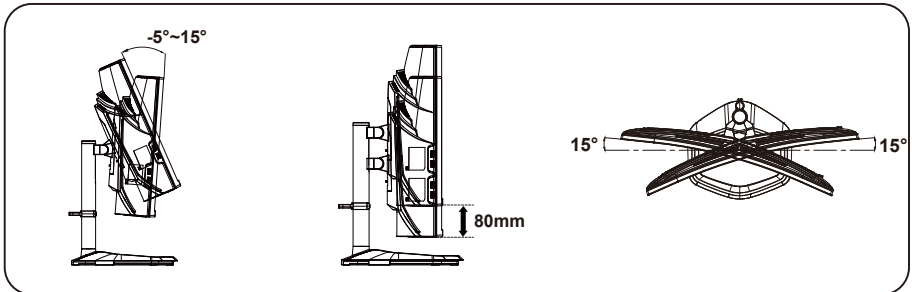

# Wall Mount Installation Instructions

1

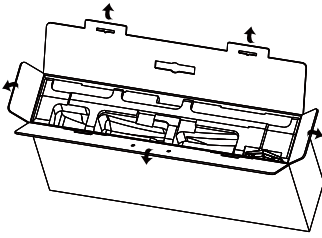

2

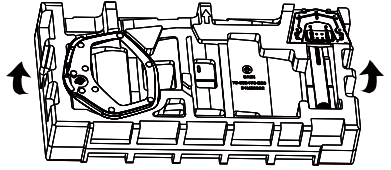

3

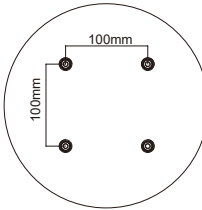
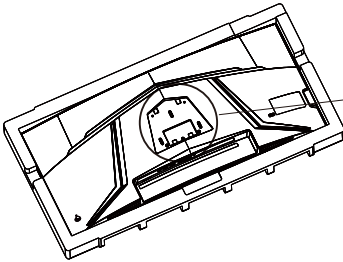

VESA : 100 x 100 mm

Screws : M4 x 10 mm

4

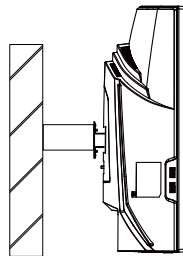
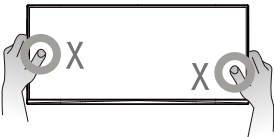

## External Control Buttons

---

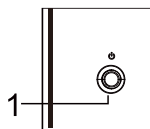

### ① Menu/Nav/OK button

Short press to turn on the monitor and Long press to turn off.

When the OSD menu is activated, pull up/down/left/right the button to adjust the settings you need. When finished, you can pull the Button Back to return to the previous level or use the Button Exit to close the OSD menu.

NOTE: Power light;  
Blue = ON;  
Orange = Power Saving.

# Main Menu

## [Input]

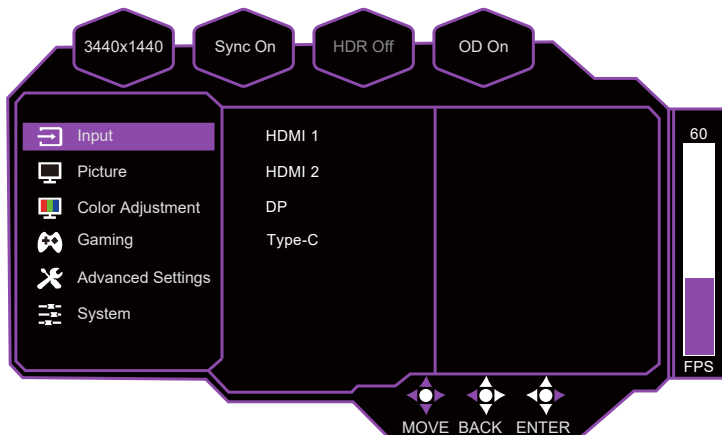

- Enter the input menu to switch the input signal.
  - **HDMI** : 100Hz (MAX) and Adaptive-Sync supported under 3440X1440
  - **DP** : 180Hz (MAX) and Adaptive-Sync supported under 3440X1440
  - **Type C**: 180Hz (MAX) under 3440X1440

## [Picture]

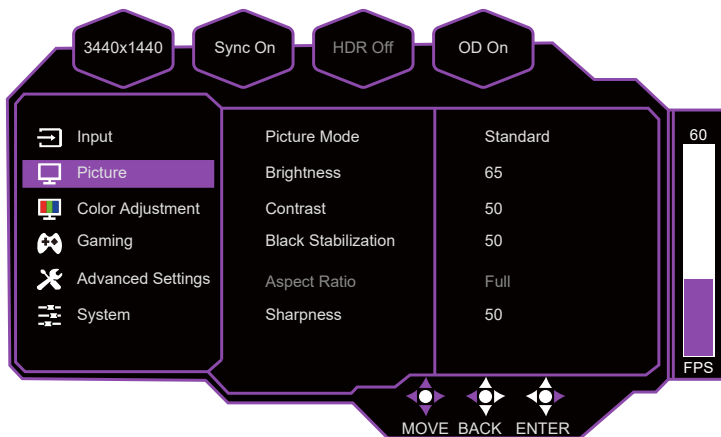

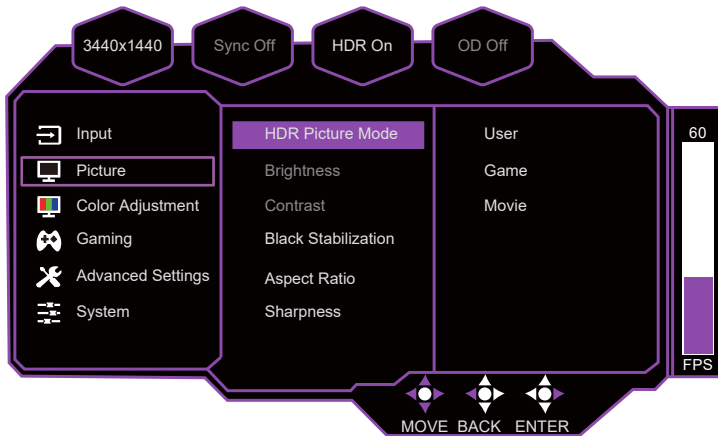

- Enter the Picture menu to configure image setting.
  - **Picture Mode (SDR)** : Enter the SDR Picture Mode menu to configure image setting.
    - a. **Standard**: Enable standard picture mode.
    - b. **User1**: Provide customized option for user experience.
    - c. **User2**: Provide customized option for user experience.
    - d. **Movie**: Provide the optimized setting for movie watching experience.
    - e. **RTS**: Provide the optimized setting for RTS(Real-Time Strategy) games.
    - f. **FPS1**: Provide the optimized setting for FPS(First Person Shooting) games to increase the visibility in dark scenes.
    - g. **FPS2**: Provide the optimized setting for FPS(First Person Shooting) games for normal scenes.
    - h. **MOBA**: Provide the optimized setting for MOBA(Multiplayer Online Battle Arena) games.
    - i. **Graphics**: Provide the optimized setting for graphics processing.
    - j. **Text**: Provide the optimized setting for reading(Native color space: sRGB).
  - **Picture Mode (HDR)** : Enter the HDR Picture Mode menu to configure image setting  
When the HDR function is turned on.
    - a. **User**: Provide customized option for user experience.
    - b. **Game**: Provide the best option for gaming experience.
    - c. **Movie**: Provide the optimized setting for movie watching experience.
  - **Brightness**: Adjust the backlight brightness level between 0 and 100.
  - **Contrast** : Adjust the Contrast level between 0 and 100.
  - **Black Stabilization**: Aim to brighten dark areas without overexposing the brighter areas.  
The setting value is between 0 and 100.
  - **Aspect Ratio**: Full Screen mode, 16:9 and 4:3 mode can be selected.
  - **Sharpness**: Adjust the sharpness between 0 and 100.

## 【Color Adjustment】

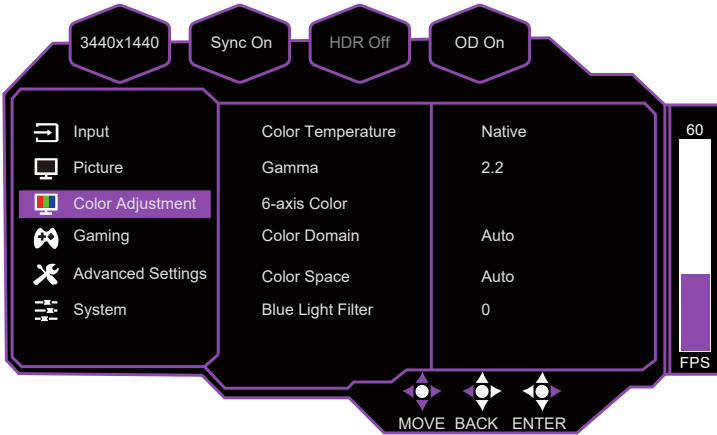

- Enter the Color Adjustment menu to adjust the ideal color mode.
  - **Color Temperature:** Adjust between Bluish, Cool, Native, Warm and User Color settings which can adjust Red, Green and Blue value from 0 to 100.
  - **Gamma:** Adjust gamma curve between Off, 1.8, 2.0, 2.2, 2.4 and 2.6.
  - **6-axis Color:** Adjust Hue and Saturation functions.
    - a. **Hue:** Adjust the tone of one specific color.
    - b. **Saturation:** Adjust the intensity and colorfulness of one specific color.
  - **Color Domain:** Adjust between Auto, RGB Mode and YUV Mode.
  - **Color Space:** Convert the color space between Auto, sRGB, Adobe RGB, DCI-P3 and BT.2020.
  - **Blue Light Filter:** Adjust the Blue Light Filter value from 0 to 100.

## 【Gaming】

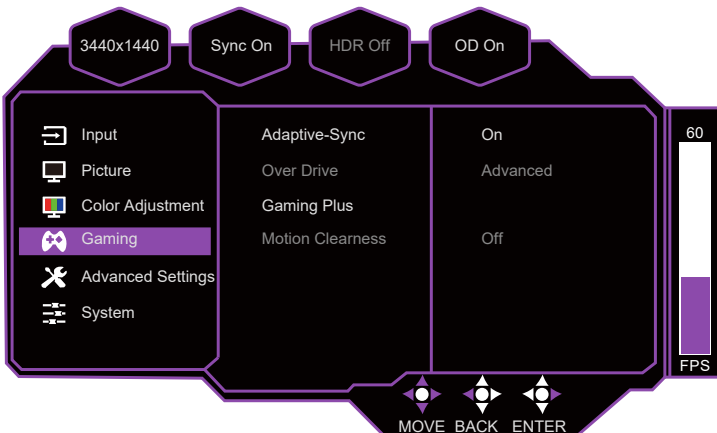

- Go to the Gaming menu to adjust the desired Gaming mode.
  - **Adaptive-Sync/FreeSync Premium:** Turn the Adaptive-Sync/FreeSync Premium function On or Off.
    - \*Enabling Adaptive-Sync/FreeSync Premium may cause side effects like flicker due to the fluctuation of the output frequency from graphics cards.
  - **Over Drive:** Off, Normal, Advanced, UltraFast, Dynamic, User modes are available options for speeding up the response time.
  - **Game Plus:**
    - a. **Timer:** Off, 15 Minutes, 30 Minutes, 45 Minutes, 60 Minutes and 90 Minutes are available options.
    - b. **Crosshair:** Turn the Crosshair function Off or adjust its Style. 6 modes options are available.
    - c. **FPS Counter:** Turn the FPS Counter function Off or adjust its display position between Left Top, Right Top, Left Bottom and Right Bottom.
  - **Motion Clearness :** MPRT setting with: Off, Low, Medium, or High as available options.

## [Advanced Settings]

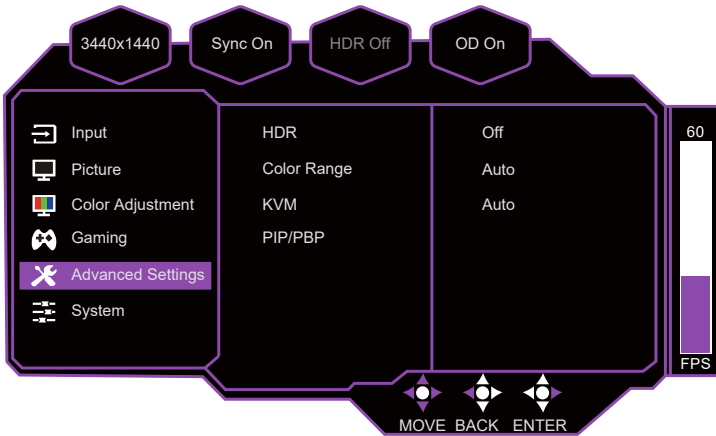





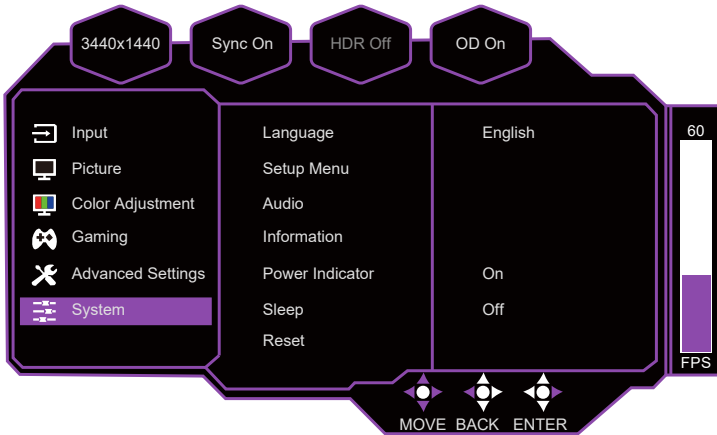



- **HDR:** Turn the HDR function Off or Auto.
- **Color Range:** Adjust the Color Range between Auto, Full Range, and Limited Range.
- **KVM:** Adjust the KVM function between Off, USB UP, Type-C, and Auto.
- **PIP/PBP:**
  - a. **Off:** Turn the PIP/PBP function Off.
  - b. **PIP:** A small floating window can be added on the screen to show other images by using the PiP (Picture in Picture) function. Source, PIP Size, Location, Source Swap are available options.
  - c. **PBP:** Images from different signal sources can be displayed together on the screen by using the PBP (Picture by Picture) function. Source, Source Swap are available options.

## [System]



- **Language:** English, French, German, Spanish, Italian, Finnish, Russian, Japanese, Korean, Traditional Chinese, Simplified Chinese are available options.
- **Setup Menu:**
  - a. **H Position:** Adjust H Position from 0 to 100.
  - b. **V Position:** Adjust V Position from 0 to 100.
  - c. **OSD Timeout:** Adjust the OSD Timeout setting value between 15, 30, 45 and 60.
  - d. **Transparency:** Adjust the Transparency setting value between 0, 20, 40, 60, 80 and 100.
- **Audio:**
  - a. **Mute:** Enable or disable the mute function.
  - b. **Volume:** Adjust the volume value between 0 and 100.  
\*Adjust volume value level properly to avoid damaging hearing.
- **Information:** View the basic information of the model including Resolution, Frame Rate, HDR, FreeSync/Adaptive-Sync, H.Frequency and Pixel Clock setting.
- **Power Indicator:** Turn the Power Indicator function On or Off.
- **Sleep:** 30 Minutes, 45 Minutes, 60 Minutes and Off are available options.
- **Reset:** Restore the Settings back to default values.

# Specifications

LCD panel	Size	34"
	Pixel pitch	0.232(H) x 0.232(V)mm
	Brightness	400nits(Typ.)
	Contrast	4000:1(Typ.)
	Viewing angle	178°(Horizontal)178°(Vertical)
	Response time	0.5ms MPRT ( motion clearness on )**
Display colors		16.7 million colors
Max. display frequency (Resolution H*V/Fv)		3440*1440 @ 180 Hz(DP & Type C) 3440*1440 @ 100 Hz(HDMI)
Power consumption	Power On	30W (Typ.)***
	Standby	≤0.5W
	Power off	≤0.3W
Input/output connector		HDMI x2 DP x1 TYPE-Cx1 (PD 20V/3.25A(Max)) Earphone jackx1 USB-Ax2 USB-Bx1(Optional)(ARGB Models only)
Input video signal		DP signal (DP models only); HDMI signal (HDMI models only); TYPE C signal (TYPE C models only);
Speakers		5Wx2(Optional)
Audio effect		Audio output (only for audio output model)
Power supply		100-240V ~ 50/60Hz
Environmental conditions		Operating temperature:0°C~40°C; Storage temperature:-20°C~60°C; Operating humidity:10~85%RH
Machine size(L x Wx H)		806.5X273.7X(434.6~514.6)mm(with arm/base) 806.5X124.6X361.7mm(without arm/base)
Box dimension(L x Wx H)		890X191X465mm
Weight (Net)		7.6 kg/Unit (with arm/base) 5.9 kg/Unit (without arm/base)
Machine specifications		Tilt: -5° to 15° ; Swivel: -15° to 15° ; Height: 0 to 80mm ;
Compliance		
     		
  		
<p>The terms HDMI and HDMI High-Definition Multimedia Interface, and the HDMI Logo are trademarks or registered trademarks of HDMI Licensing Administrator, Inc. in the United States and other countries.</p>		

\*Specifications are subject to change without notice.

\*\*The screen may flicker and other uncomfortable phenomena when the Motion Clearness function is enabled.

\*\*\*Measure a screen brightness of 200 nits without audio/USB/Card reader connection.

If you have any question regarding use of the monitor, please visit:

<https://www.cooler-master.com/warranty>

# Supported Timing

[PC Timing]

Mode	Resolution	Horizontal Frequency (KHz)	Vertical Frequency (Hz)	Pixel Clock (MHz)	Port		
					HDMI IN	DP IN	Type-C
VGA	640x480@60Hz	31.469	59.940	25.175	○	○	○
	640x480@72Hz	37.861	72.809	31.500	○	○	○
	640x480@75Hz	37.500	75.000	31.500	○	○	○
MAC	640x480@66.66Hz	35.000	66.667	30.240	○	○	○
VESA	720x400@70Hz	31.469	70.087	28.322	○	○	○
SVGA	800x600@56Hz	35.156	56.250	36.000	○	○	○
	800x600@60Hz	37.879	60.317	40.000	○	○	○
	800x600@72Hz	48.077	72.188	50.000	○	○	○
	800x600@75Hz	46.875	75.000	49.500	○	○	○
MAC	832x624@74.55Hz	49.722	74.550	57.280	○	○	○
XGA	1024x768@60Hz	48.363	60.004	65.000	○	○	○
	1024x768@70Hz	56.476	70.069	75.000	○	○	○
	1024x768@75Hz	60.023	75.029	78.750	○	○	○
MAC	1152x870@75Hz	68.681	75.062	100.000	○	○	○
VESA	1152x864@75Hz	67.500	75.000	108.000	○	○	○
	1280x960@60Hz	60.000	60.000	108.000	○	○	○
SXGA	1280x1024@60Hz	63.981	60.020	108.000	○	○	○
	1280x1024@75Hz	79.976	75.025	135.000	○	○	○
VESA	1280x720@60Hz	45.000	60.000	74.250	○	○	○
WXGA	1280x800@60Hz	49.702	59.810	83.500	○	○	○
WXGA+	1440x900@60Hz	55.935	59.887	106.500	○	○	○
WSXGA+	1680x1050@60Hz	65.290	59.954	146.250	○	○	○
FHD	1920x1080@60Hz	67.500	60.000	148.500	○	○	○
	1920x1080@144Hz	166.587	143.981	346.500	×	○	○
Wide HD	2560x1080@60Hz	67.080	60.000	230.755	○	○	○
WQHD (AMD/nVidia)	3440x1440@60Hz	88.770	59.940	312.470	○	○	○
	3440x1440@100Hz	150.849	99.900	530.989	○	○	○
	3440x1440@120Hz	182.817	119.880	643.516	×	○	○
	3440x1440@144Hz	217.320	143.920	799.740	×	○	○
	3440x1440@165Hz	247.500	165.000	910.800	×	○	○
	3440x1440@180Hz	265.680	180.000	950.070	×	○	○

## [Video Timing]

Video ID code	Formats	Aspect Ratio	Field Rate (Hz)	Horizontal (kHz)	Vertical (Hz)	Pixel Clock (MHz)	H-Total	V-Total
1	640x480p	4:3	59.94	31.469	59.94	25.175	800	525
			60	31.500	60.00	25.200	800	525
3	720x480p	16:9	59.94	31.469	59.94	27.000	858	525
			60	31.500	60.00	27.027	858	525
4	1280x720p	16:9	59.94	44.955	59.94	74.176	1650	750
			60	45.000	60.00	74.250	1650	750
16	1920x1080p	16:9	59.94	67.433	59.94	148.352	2200	1125
			60	67.500	60.00	148.500	2200	1125
18	720x576p	16:9	50	31.250	50.00	27.000	864.000	625
19	1280x720p	16:9	50	37.500	50.00	74.250	1980.000	750
31	1920x1080p	16:9	50	56.250	50.00	148.500	2640.000	1125
63	1920x1080p	16:9	120	135	119.88/120	297	2200.000	1125
97	3840x2160p	16:9	60	135	60	594	4400.000	2250

## Product Outline Dimensions

