



Questo manuale d'istruzione è fornito da trovaprezzi.it. Scopri tutte le offerte per [Dell Alienware AW3225DM](#) o cerca il tuo prodotto tra le [migliori offerte di Monitor](#)



Questo manuale d'istruzione è fornito da trovaprezzi.it. Scopri tutte le offerte per [Dell Alienware AW3225DM](#) o cerca il tuo prodotto tra le [migliori offerte di Monitor](#)

# **Alienware 32 Gaming Monitor**

## **AW3225DM**

### Simplified Service Manual

## Notes, cautions, and warnings

- ① **NOTE:** A NOTE indicates important information that helps you make better use of your product.
- △ **CAUTION:** A CAUTION indicates either potential damage to hardware or loss of data and tells you how to avoid the problem.
- ⚠ **WARNING:** A WARNING indicates a potential for property damage, personal injury, or death.

# Contents

<b>Safety instructions</b> .....	<b>4</b>
<b>Before working inside your monitor</b> .....	<b>4</b>
<b>After working inside your monitor</b> .....	<b>4</b>
<b>Views of AW3225DM monitor</b> .....	<b>5</b>
<b>Front view</b> .....	<b>5</b>
<b>Back view</b> .....	<b>6</b>
<b>Side view</b> .....	<b>6</b>
<b>Bottom view</b> .....	<b>7</b>
<b>Major components of AW3225DM monitor</b> .....	<b>8</b>
<b>Wiring connectivity diagram</b> .....	<b>10</b>
<b>Connecting the cables</b> .....	<b>12</b>
<b>Disassembly and reassembly</b> .....	<b>14</b>
<b>Recommended tools</b> .....	<b>14</b>
<b>Screw list</b> .....	<b>14</b>
<b>Stand</b> .....	<b>15</b>
Removing the stand .....	15
Installing the stand .....	15
<b>Back cover</b> .....	<b>16</b>
Removing the back cover .....	16
Installing the back cover .....	17
<b>Metal shield</b> .....	<b>20</b>
Removing the metal shield .....	20
Installing the metal shield .....	23
<b>System board and power board</b> .....	<b>26</b>
Removing the system board and power board .....	26
Installing the system board and power board .....	28
<b>Middle frame</b> .....	<b>29</b>
Removing the middle frame .....	29
Installing the middle frame .....	30
<b>Power-button board</b> .....	<b>32</b>
Removing the power-button board .....	32
Installing the power-button board .....	33
<b>I/O board and joystick-button board</b> .....	<b>34</b>
Removing the I/O board and joystick-button board .....	34
Installing the I/O board and joystick-button board .....	35
<b>Troubleshooting</b> .....	<b>37</b>
<b>Self-test</b> .....	<b>37</b>
<b>Built-in diagnostics</b> .....	<b>38</b>
<b>Common problems</b> .....	<b>39</b>
<b>Universal Serial Bus (USB) specific problems</b> .....	<b>42</b>
<b>Regulatory information</b> .....	<b>43</b>
<b>FCC notices (U.S. Only) and other regulatory information</b> .....	<b>43</b>
<b>EU product database for energy label and product information sheet</b> .....	<b>43</b>
<b>Contacting Dell</b> .....	<b>44</b>

# Safety instructions

Use the following safety guidelines to protect your monitor from potential damage and to ensure your personal safety. Unless otherwise noted, each procedure included in this document assumes that you have read the safety information that is shipped with your monitor.

- ① **NOTE:** Before using the monitor, read the safety information that is shipped with your monitor and is printed on the product. Keep the documentation at a secure location for future reference.
- ⚠ **WARNING: Use of controls, adjustments or procedures other than those specified in this documentation may result in exposure to shock, electrical hazards and/or mechanical hazards.**
- ⚠ **CAUTION: The possible long-term effect of listening to audio at high volume through the headphones (on monitor that support it) may cause damage to your hearing ability.**
- Place the monitor on a solid surface and handle it carefully.
  - The screen is fragile and can be damaged if dropped or hit with a sharp object.
  - Ensure that your monitor is electrically rated to operate with the AC power available in your location.
  - Keep the monitor at room temperature. Excessive cold or hot conditions can have an adverse effect on the liquid crystal of the display.
  - Connect the power cable from the monitor to a wall outlet that is near and accessible.
- Do not place and use the monitor on a wet surface or near water.
- Do not subject the monitor to severe vibration or high impact conditions. For example, do not place the monitor inside a car trunk.
- Unplug the monitor when it is going to be left unused for an extended period.
- To avoid electric shock, do not attempt to remove any cover or touch the inside of the monitor.
- Read these instructions carefully. Keep this document for future reference. Follow all warnings and instructions marked on the product.
- Certain monitors can be wall mounted using the VESA mount that is purchased separately. Ensure to use the correct VESA specifications as mentioned in the wall-mounting section of the User's Guide.

For information on safety instructions, see the Safety, Environmental and Regulatory Information (SERI) document that is shipped with your monitor.

## Before working inside your monitor

### Steps

1. Save and close all open files and exit all open applications.
2. Turn off your monitor.
3. Disconnect your monitor and all attached devices from their electrical outlets.
4. Disconnect all attached network devices and peripherals, such as keyboard, mouse, and dock from your monitor.
  - ⚠ **CAUTION: To disconnect a network cable, first unplug the cable from your monitor and then unplug the cable from the network device.**
5. Remove any media card and optical disc from your monitor, if applicable.

## After working inside your monitor

- ⚠ **CAUTION: Leaving stray or loose screws inside your monitor may severely damage your monitor.**

### Steps

1. Replace all screws and ensure that no stray screws remain inside your monitor.
2. Connect any external devices, peripherals, or cables you removed before working inside your monitor.
3. Replace any media cards, discs, or any other parts that you removed before working inside your monitor.
4. Connect your monitor and all attached devices to the respective electrical outlets.
5. Turn on your monitor.

# Views of AW3225DM monitor

## Front view



**Figure 1. Front view of the monitor**

**Table 1. Components and descriptions.**

Label	Description	Use
1	Power button (with LED indicator)	To turn the monitor on or off. A solid white light indicates that the monitor is turned on and is functioning. Blinking white light indicates that the monitor is in Standby Mode.

## Back view



**Figure 2. Back view of the monitor**

**Table 2. Components and descriptions.**

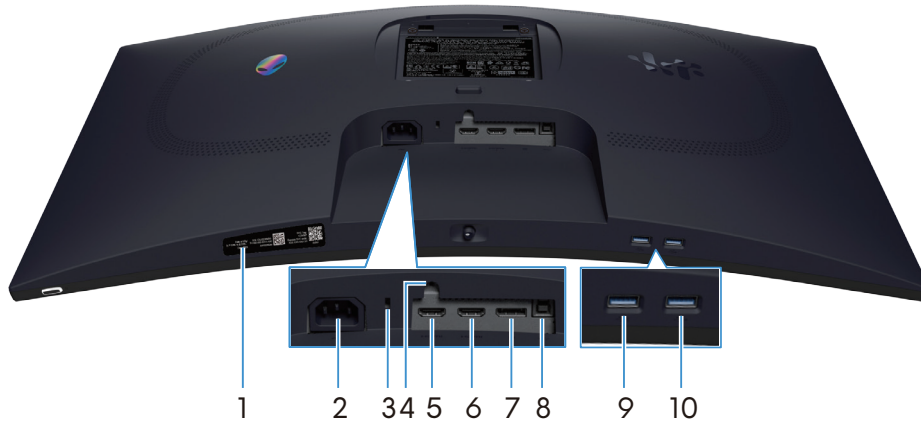
Label	Description	Use
1	VESA mounting holes (4) (100 mm x 100 mm) – behind attached VESA cover	Wall-mount the monitor using VESA-compatible wall mount kit.
2	Regulatory label	Lists the regulatory approvals.
3	Stand release button	Releases the stand from the monitor.
4	Joystick button	Use it to control the On-Screen Display (OSD) menu. For more information, see <i>Operating the monitor</i> in the <i>User's Guide</i> of AW3225DM.
5	Cable-management slot	Use to organize cables by inserting them through the slot.

## Side view










**Figure 3. Side view of the monitor**

## Bottom view



**Figure 4. Bottom view of the monitor**

**Table 3. Components and descriptions.**

Label	Description	Use
1	My Alienware QR code, serial number, and Service Tag label	See this label if you need to contact Dell for technical support. The Service Tag is a unique alphanumeric identifier that enables Dell service technicians to identify the hardware components in your monitor and access warranty information.
2	 Power connector	Connect the power cable (shipped with your monitor).
3	Security-lock slot (based on Kensington Security Slot)	Secure your monitor using a security lock (purchased separately) to prevent unauthorized movement of your monitor.
4	Stand-lock feature	Lock the stand to the monitor using a M3x6 mm screw (screw not included).
5	 HDMI 1 port	Connect your computer with the HDMI cable (shipped with your monitor) to this port.
6	 HDMI 2 port	Connect your computer with the HDMI cable (shipped with your monitor) to this port.
7	 DisplayPort	Connect your computer with the DisplayPort-DisplayPort cable (shipped with your monitor) to this port.
8	 USB Type-B upstream port	Connect the USB cable (shipped with your monitor) to this port and your computer to enable the USB ports on your monitor.
9	 USB Type-A downstream port	Connect to charge your USB device. ⓘ <b>NOTE:</b> To use this port, you must connect the USB cable (shipped with your monitor) to the USB upstream port on the monitor and to your computer. ⓘ <b>NOTE:</b> To prevent signal interference, avoid connecting other USB devices to the adjacent port when using a wireless USB device on a downstream USB port.
10	 USB Type-A downstream port	Connect your USB Type-A device. ⓘ <b>NOTE:</b> To use this port, you must connect the USB cable (shipped with your monitor) to the USB upstream port on the monitor and to your computer. ⓘ <b>NOTE:</b> To prevent signal interference, avoid connecting other USB devices to the adjacent port when using a wireless USB device on a downstream USB port.

# Major components of AW3225DM monitor

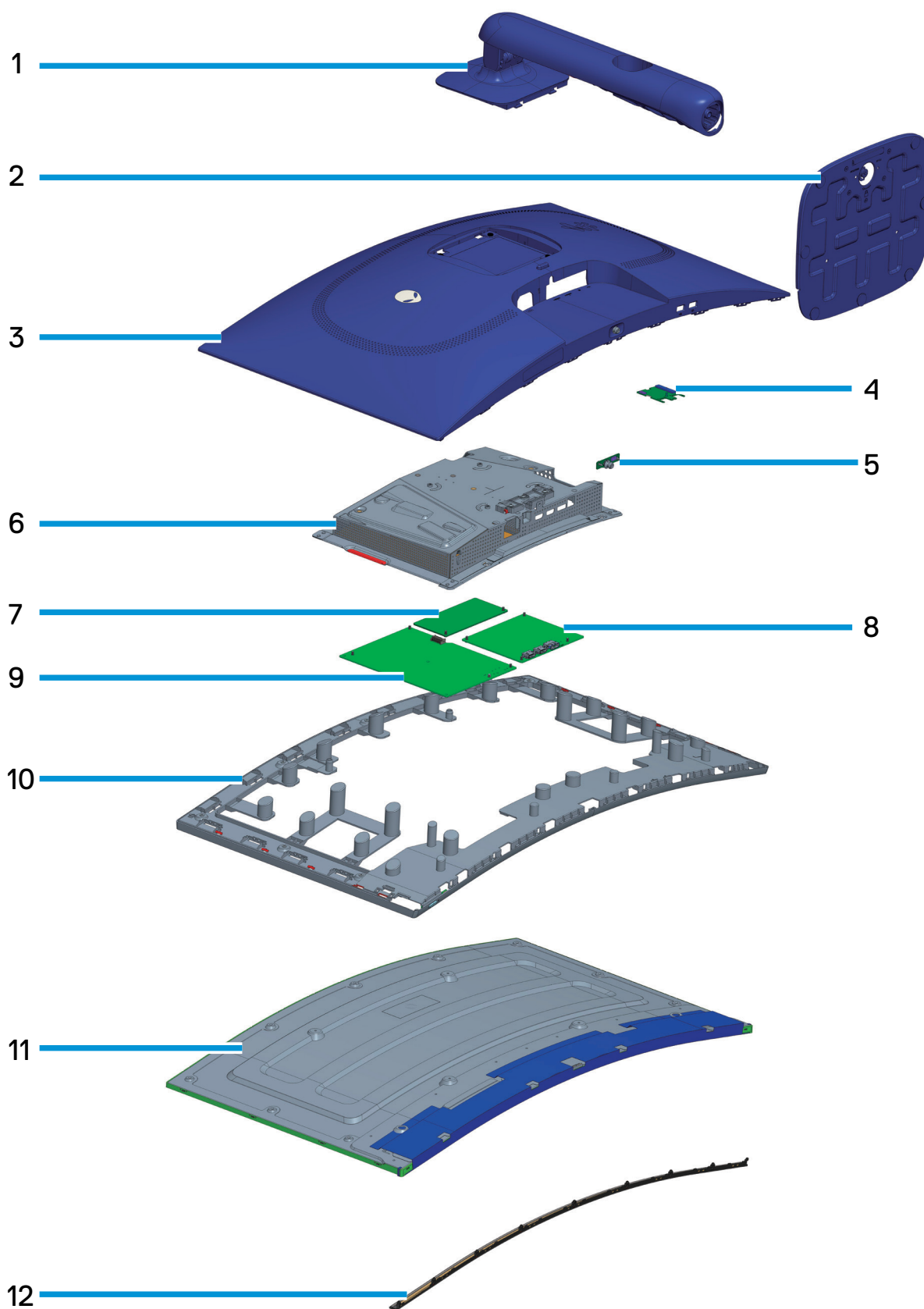


Figure 5. Major components of AW3225DM

**Table 4. Major components of AW3225DM.**

<b>Item</b>	<b>Description</b>
1	Stand riser
2	Stand base
3	Back cover
4	I/O board
5	Joystick-button board
6	Metal shield
7	Converter board
8	System board
9	Power board
10	Middle frame
11	Display panel
12	Front trim

**NOTE:**

For replacement of power cable, connectivity cable and external power supply (if applicable), contact Dell:

1. Go to [Dell Support Site](#).
2. Verify your country or region in the **Choose A Country/Region** drop-down menu at the bottom-right corner of the page.
3. Click **Contact Us** next to the country dropdown.
4. Select the appropriate service or support link based on your need.
5. Choose the method of contacting Dell that is convenient for you.

# Wiring connectivity diagram

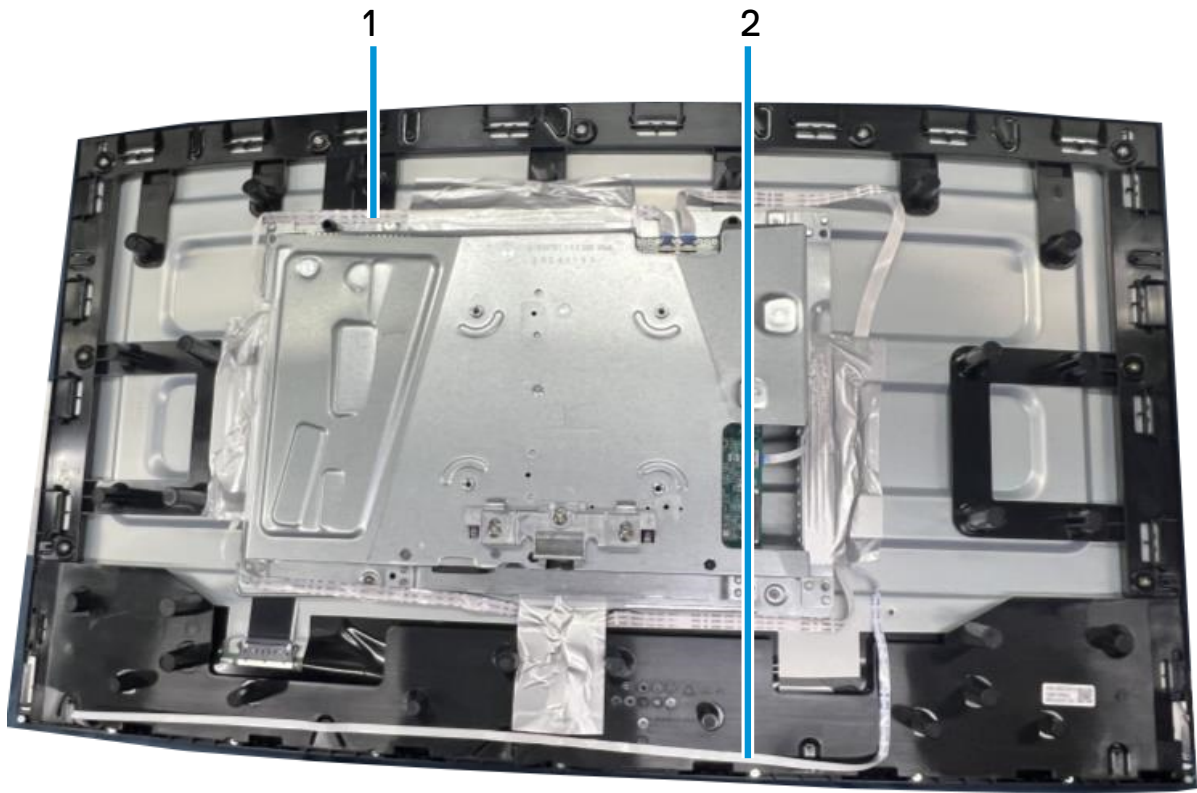


Figure 6. Wiring connectivity diagram

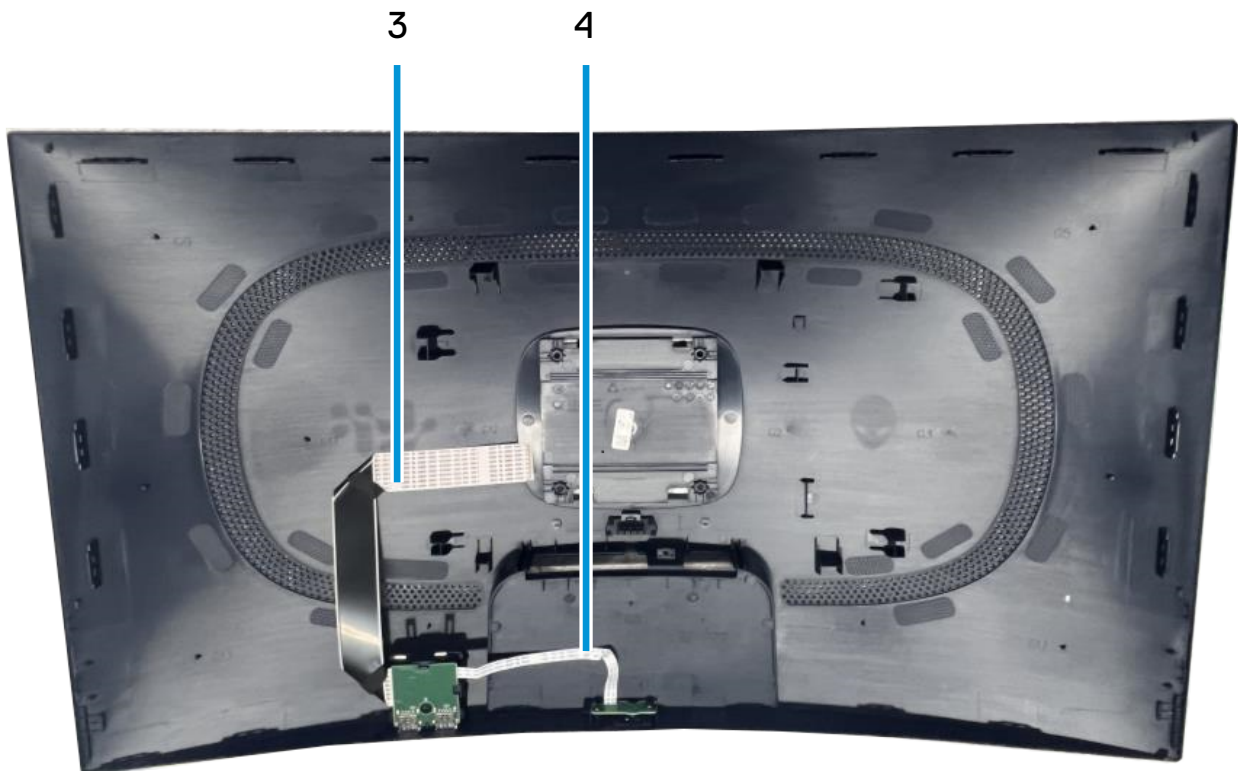


Figure 7. Wiring connectivity diagram

**Table 5. Wiring connectivity description.**

<b>Item</b>	<b>Description</b>
1	Lightbar cable
2	Power-button cable
3	Low-Voltage Differential Signaling (LVDS) cable
4	Joystick-button cable

# Connecting the cables

- ⚠ **WARNING:** Before you begin any of the following procedures, follow the [Safety instructions](#).
- ⚠ **WARNING:** For your safety, ensure that the grounded power outlet you plug the power cable into is accessible to the operator and located as close to the equipment as possible. To disconnect power from the equipment, unplug the power cable from the power outlet by grasping the plug firmly. Never pull on the cord.
- ⚠ **WARNING:** A certified power supply cable has to be used with this equipment. The relevant national installation and/or equipment regulations should be considered. A certified power supply cord not lighter than ordinary polyvinyl chloride flexible cord according to IEC 60227 (designation H05VV-F 3G 0.75 mm<sup>2</sup> or H05VVH2-F2 3G 0.75 mm<sup>2</sup>) should be used.
- ① **NOTE:** Do not connect all cables to the computer simultaneously. It is recommended to route the cables through the cable-management slot before you connect them to the monitor.
- ① **NOTE:** Alienware monitors are designed to work optimally with Alienware-supplied inbox cables. Dell does not guarantee the video quality and performance if non-Alienware cables are used.

## To connect your monitor to the computer:

1. Turn off your computer and disconnect the power cable.
2. Connect the DisplayPort to DisplayPort cable or HDMI cable from your monitor to the computer.
3. Connect the USB Type-B end of the upstream cable to the monitor and the USB Type-A end of the cable to the computer.
4. Connect the USB peripherals to the USB 5Gbps downstream ports on the monitor.
5. Connect the power cables of your computer and monitor into a wall outlet.
6. Turn on the monitor and the computer.
7. If your monitor displays an image, installation is complete. If it does not display an image, see [Common problems](#).

## Connecting the DisplayPort (DP to DP) cable



Figure 8. Connecting the DisplayPort (DP to DP) cable

## Connecting the HDMI cable



Figure 9. Connecting the HDMI cable

## Connecting the USB Type-B (Type-B to Type-A) cable



**Figure 10.** Connecting the USB Type-B (Type-B to Type-A) cable

# Disassembly and reassembly

△ **CAUTION:** The information in this section is intended for authorized service technicians in the EMEA region. Dell prohibits users from disassembling the monitor, and any damage caused by unauthorized servicing will not be covered under the warranty.

## Recommended tools









The procedures in this document may require the following tools:

1. Screwdriver (Phillips-head, Hexagonal head)
2. Plastic scribe

## Screw list

- ① **NOTE:** When removing screws from a component, it is recommended to note the screw type, the quantity of screws, and then place them in a screw storage box. This is to ensure that the correct number of screws and correct screw type is restored when the component is replaced.
- ① **NOTE:** Some computers have magnetic surfaces. Ensure that the screws are not left attached to such surfaces when replacing a component.
- ① **NOTE:** Screw color may vary with the configuration ordered.

**Table 6. Screw list.**

Component	Screw types	Quantity	Screw images
Back cover	M4X10	4	
Metal shield	M3X4	4	
System board and Power board	M3X6	9	
Power board	M4X6	1	
Middle frame	M3X4	9	
Front trim	Q2X3.2	9	
Power-button board	Q2X2	2	
I/O board and joystick-button board	Q3X6	3	

# Stand

## Removing the stand

### Prerequisites

1. Follow the procedure in [Before working inside your monitor.](#)

### Steps

1. Place the monitor on a clean surface on a curved cushion.
2. Press the release button and pull the stand assembly away from the monitor.
3. Open the screw handle at the bottom of the stand base. Turn it anticlockwise to remove the stand riser from the stand base.

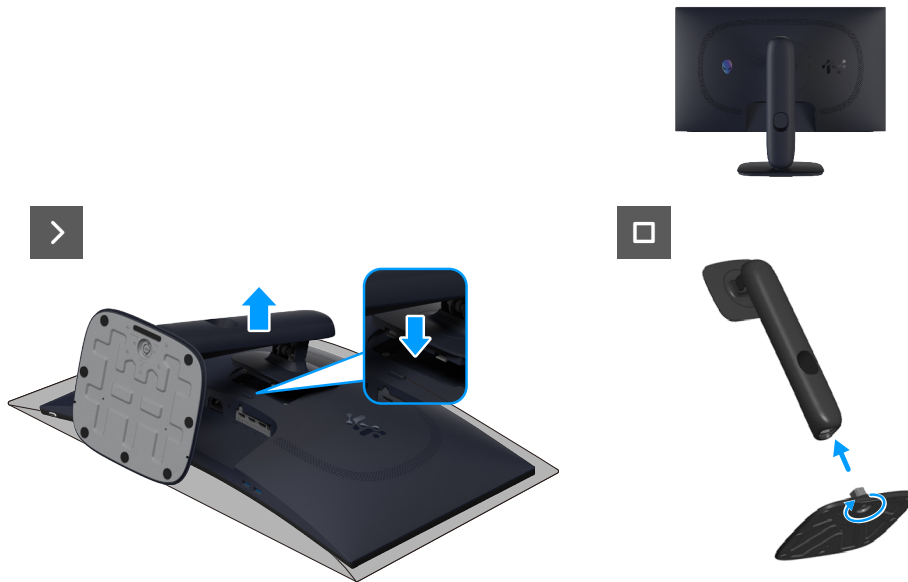


Figure 11. Removing the stand

## Installing the stand

### Steps

1. Align and place the stand riser on the stand base.
2. Open the screw handle at the bottom of the stand base. Turn it clockwise to secure the stand riser to the stand base.
3. Align the stand-riser bracket with the grooves at the back of the monitor.
4. Slide and gently press the stand assembly until it snaps into place.

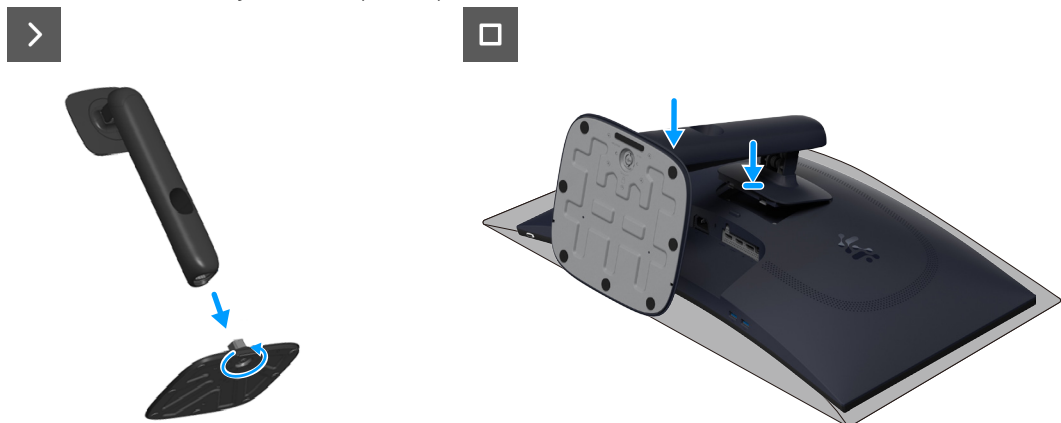


Figure 12. Installing the stand

### Next steps

1. Follow the procedure in [After working inside your monitor.](#)

# Back cover

## Removing the back cover

### Prerequisites

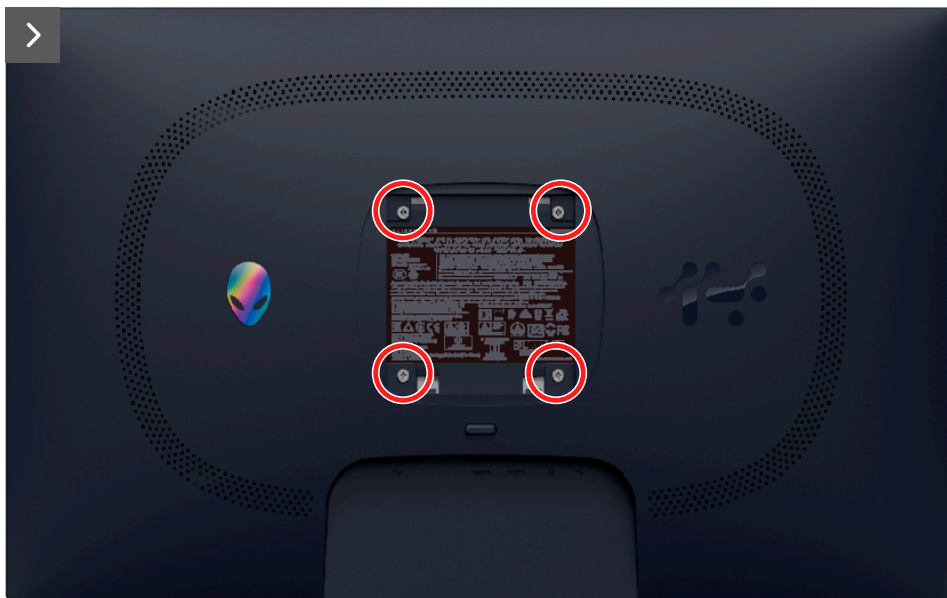
1. Follow the procedure in [Before working inside your monitor](#).
2. Remove the [stand](#).

### Steps

1. Remove the four screws (M4x10) that secure the back cover to the display assembly.



**4x**  
M4x10



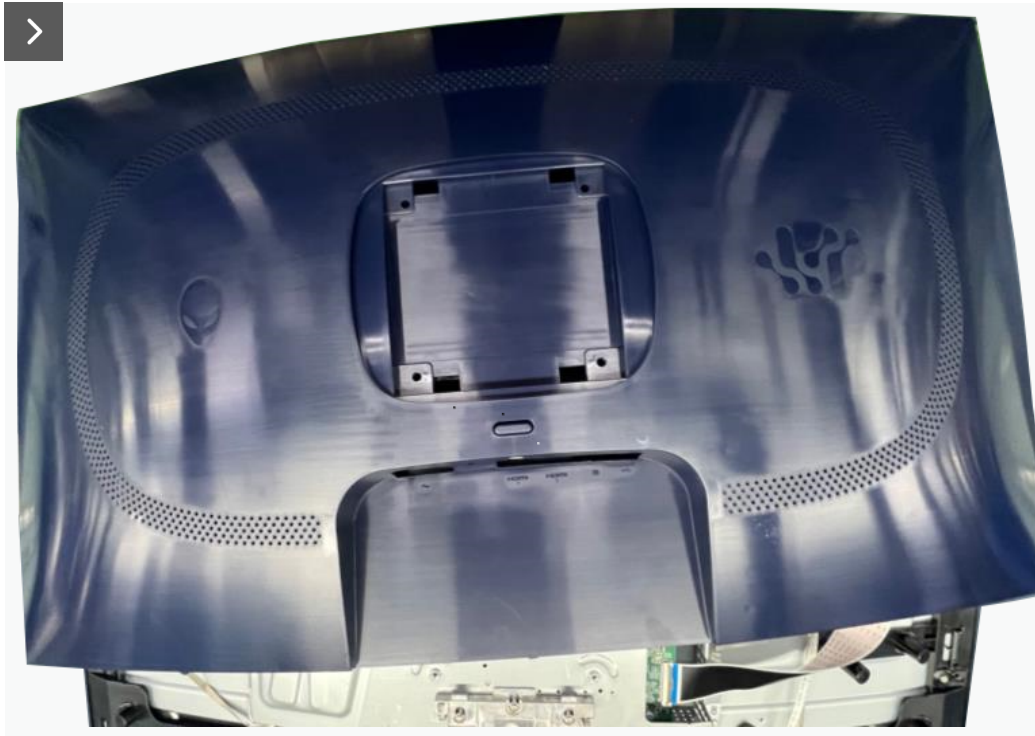
**Figure 13. Removing the back cover**

2. Using a plastic scribe, pry the back cover starting from the bottom edge of the monitor.



**Figure 14. Removing the back cover**

3. Lift the back cover partially from the bottom edge and disconnect the LVDS cable from the connector on the system board.



**Figure 15. Removing the back cover**



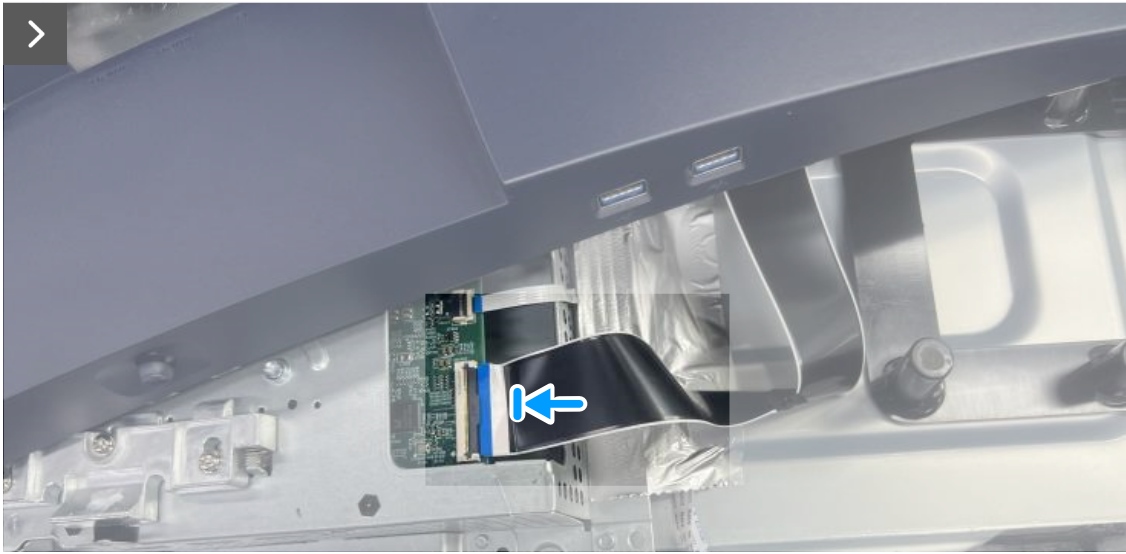
**Figure 16. Removing the back cover**

4. Lift and remove the back cover away from the monitor.

## **Installing the back cover**

### **Steps**

1. Connect the LVDS cable to the connector on the system board.
2. Align the screw holes on the back cover with the screw holes on the monitor, and gently press along the sides to snap the back cover into place.



**Figure 17. Installing the back cover**

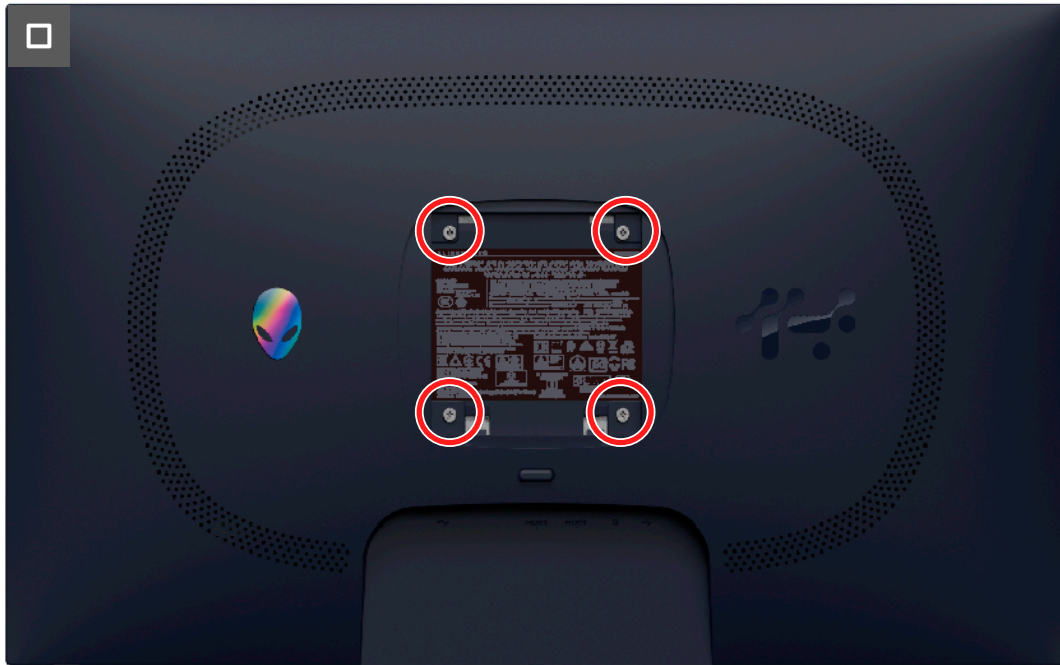


**Figure 18. Installing the back cover**

3. Replace the four screws (M4x10) to secure the back cover to the display assembly.



**4x**  
M4x10



**Figure 19. Installing the back cover**

**Next steps**

1. Install the [stand](#).
2. Follow the procedure in [After working inside your monitor](#).

# Metal shield

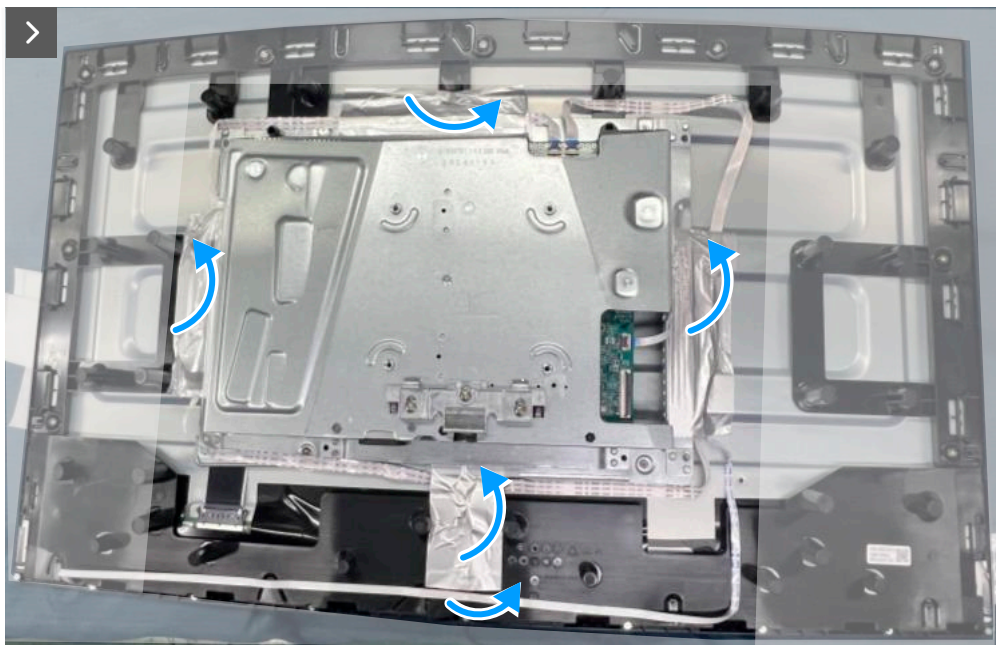
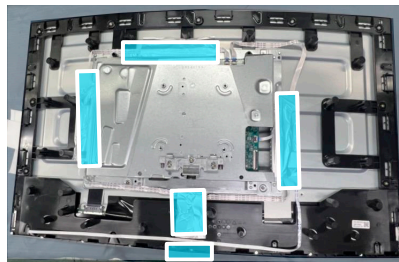
## Removing the metal shield

### Prerequisites

1. Follow the procedure in [Before working inside your monitor](#).
2. Remove the [stand](#).
3. Remove the [back cover](#).

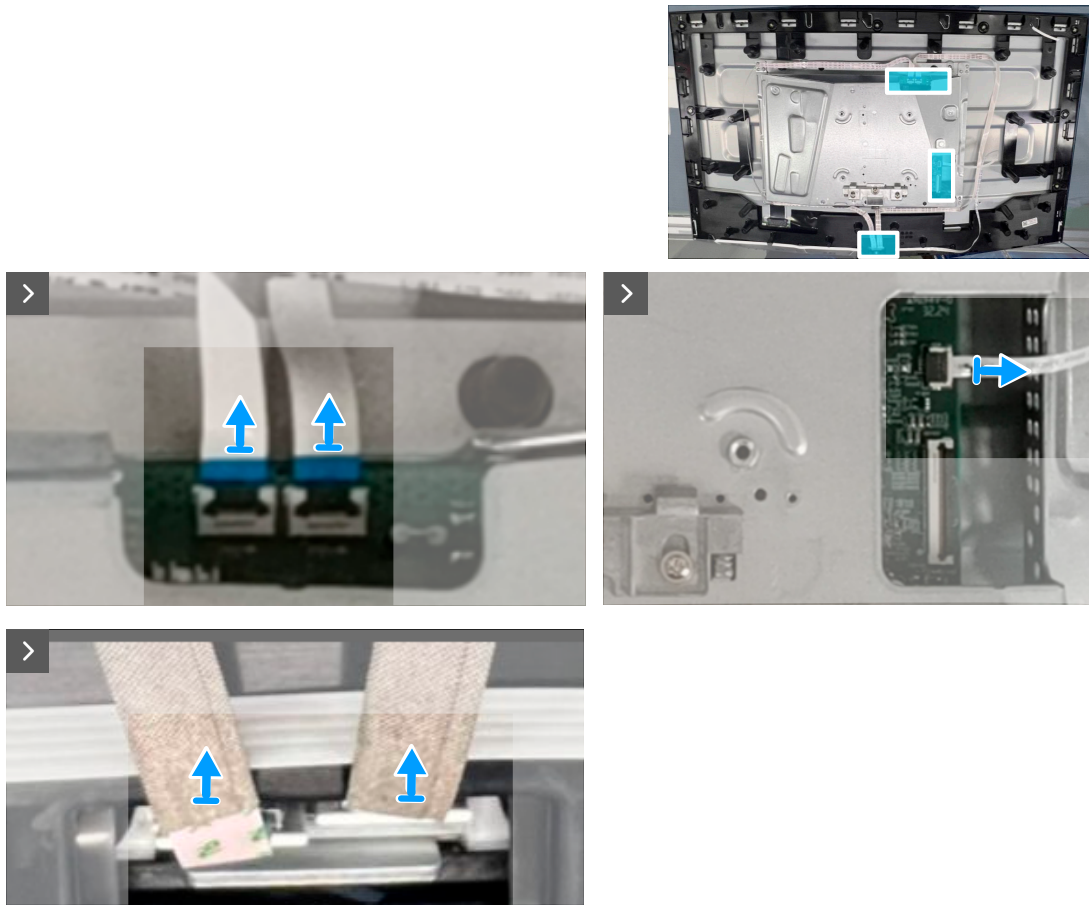
### Steps

1. Peel back the tapes that secure the cables and metal shield to the display panel.



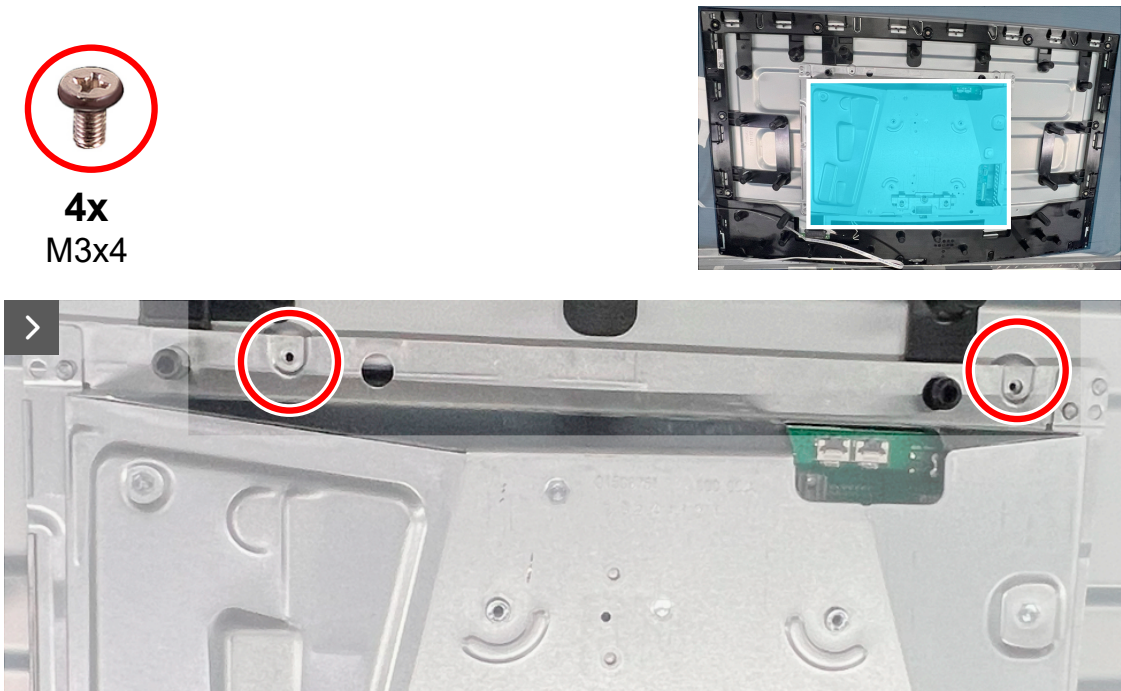
**Figure 20. Removing the metal shield**

2. Disconnect the lightbar cables from the connector on the display panel and the system board.
3. Disconnect the keypad cable from the connector on the display panel and the system board.

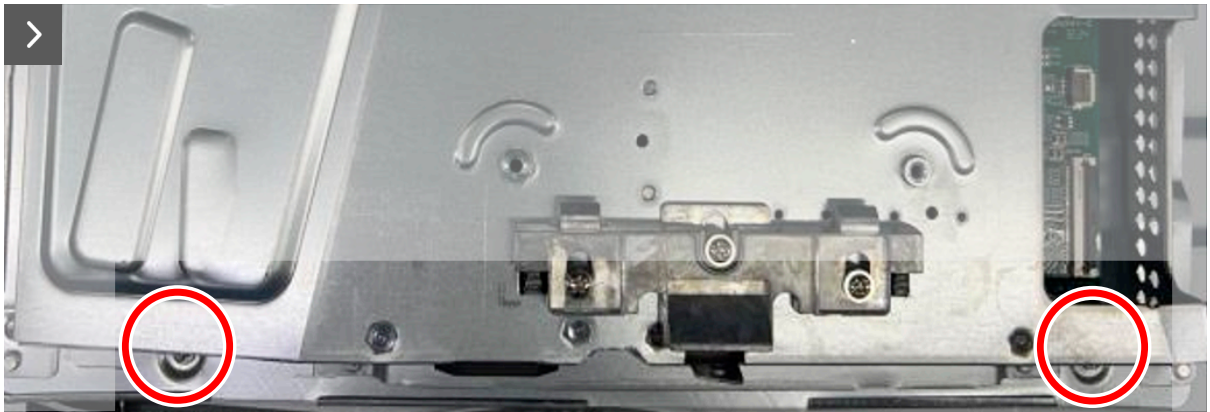


**Figure 21. Removing the metal shield**

4. Remove the four screws (M3X4) that secure the metal shield to the middle frame.

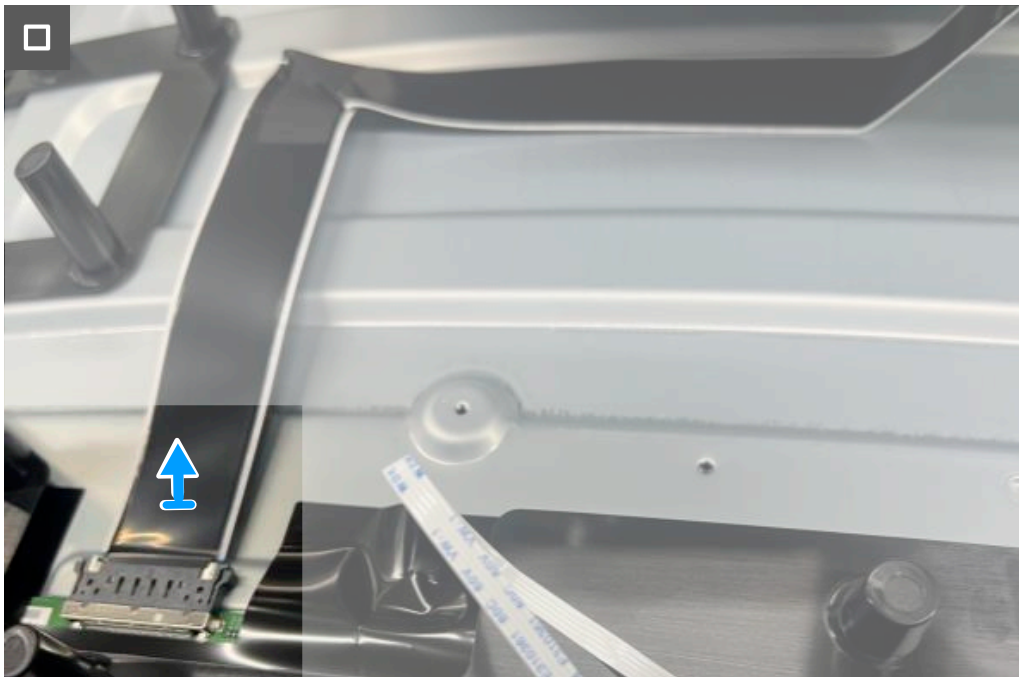


**Figure 22. Removing the metal shield**



**Figure 23. Removing the metal shield**

5. Disconnect the display cable from the connector on the display panel.

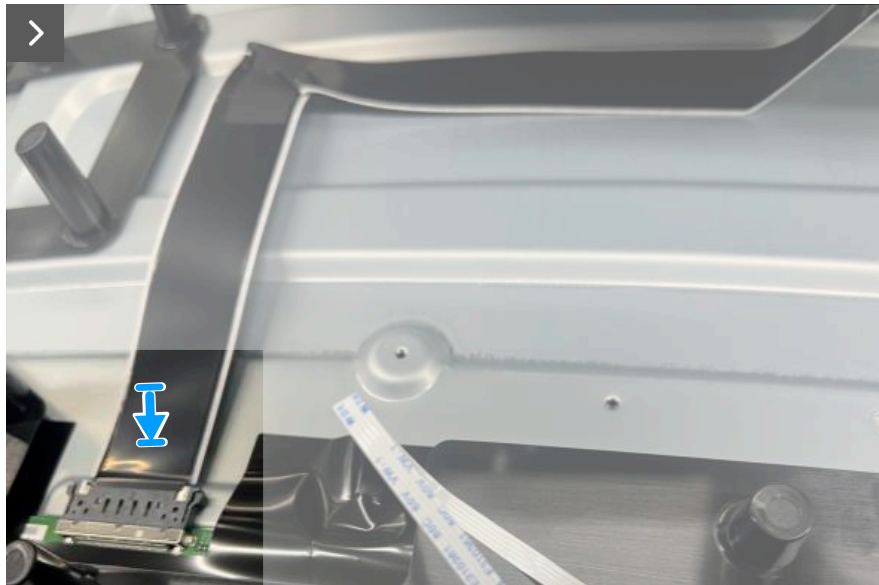


**Figure 24. Removing the metal shield**

## Installing the metal shield

### Steps

1. Connect the display cable to the connector on the display panel.

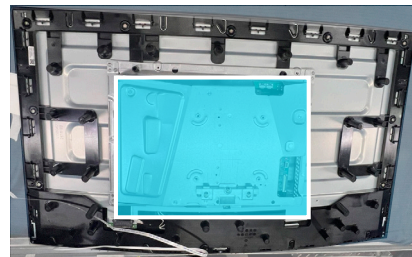


**Figure 25. Installing the metal shield**

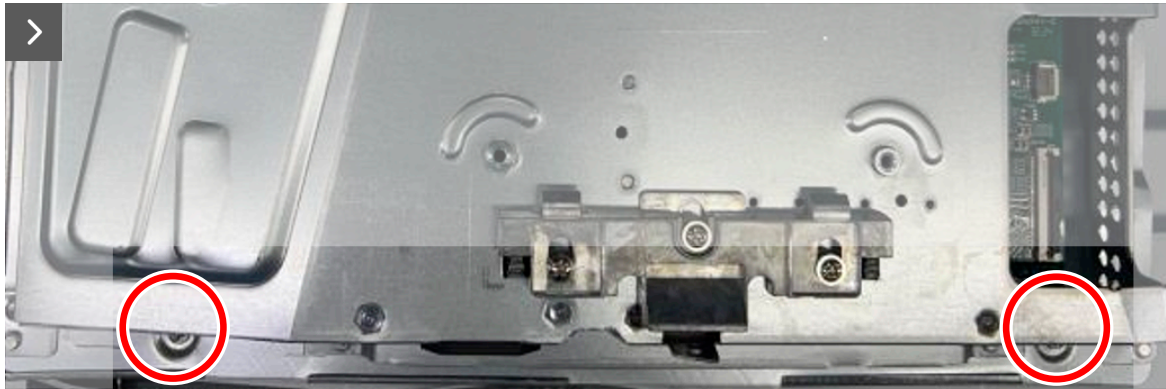
2. Align the screw holes on the metal shield to the screw holes on the middle frame.
3. Replace the four screws (M3x4) to secure the metal shield to the middle frame.



**4x**  
**M3x4**

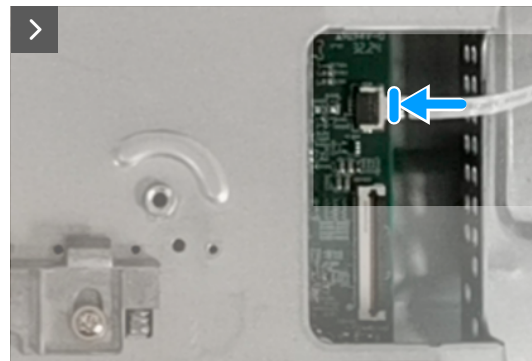
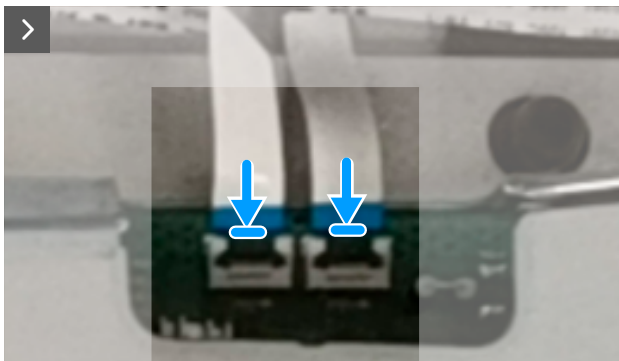
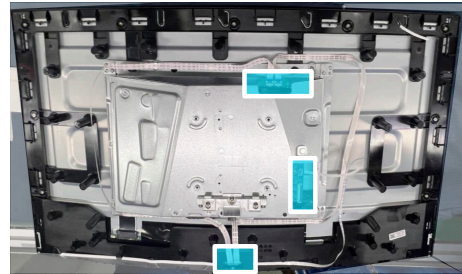


**Figure 26. Installing the metal shield**



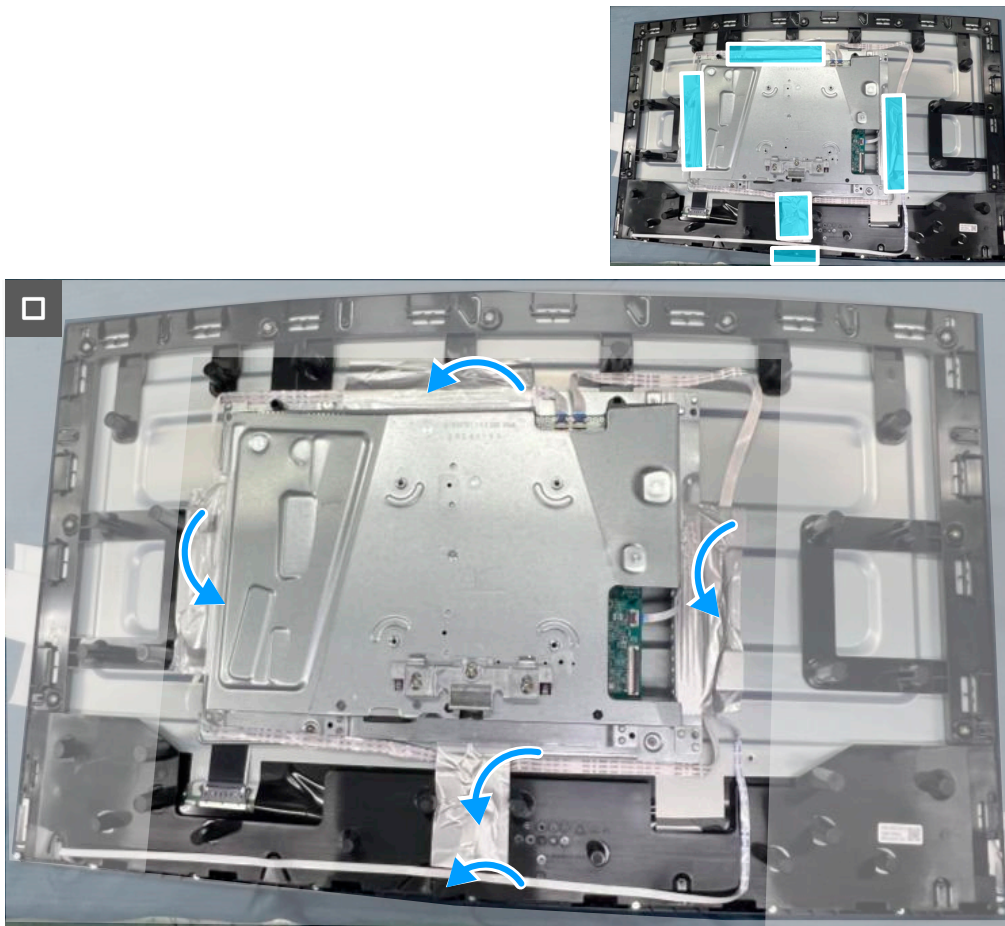
**Figure 27. Installing the metal shield**

4. Connect the lightbar cables to the connector on the display panel and the system board.
5. Connect the keypad cable to the connector on the display panel and the system board.



**Figure 28. Installing the metal shield**

6. Adhere the tapes to secure the cables and metal shield to the display panel.



**Figure 29. Installing the metal shield**

**Next steps**

1. Install the [back cover](#).
2. Install the [stand](#).
3. Follow the procedure in [After working inside your monitor](#).

# System board and power board

## Removing the system board and power board

### Prerequisites

1. Follow the procedure in [Before working inside your monitor](#).
2. Remove the [stand](#).
3. Remove the [back cover](#).
4. Remove the [metal shield](#).

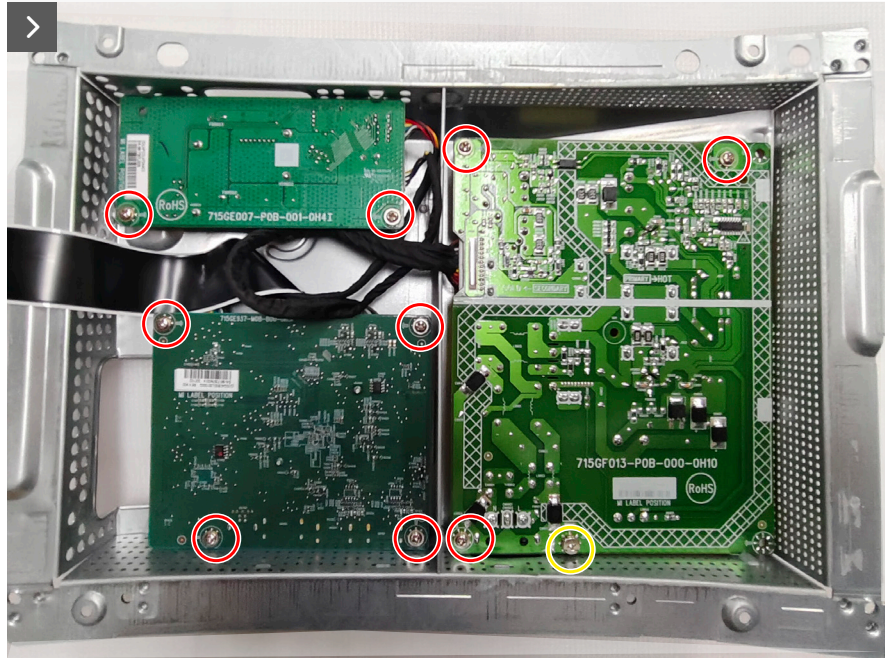
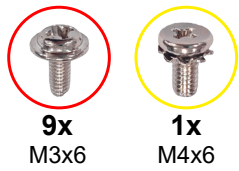
### Steps

1. Remove the Mylar sheet from the power board.



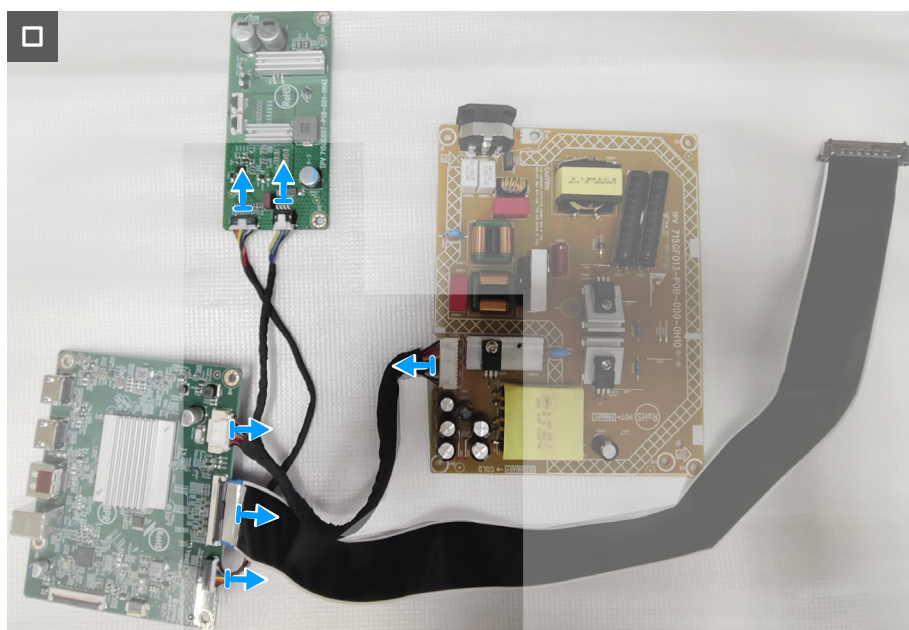
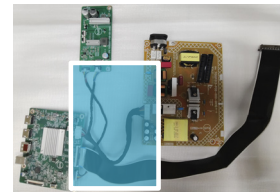
**Figure 30. Removing the system board and power board**

2. Remove the nine screws (M3x6) and the screw (M4X6) that secures the system board, power board and converter board to the metal shield.



**Figure 31. Removing the system board and power board**

3. Disconnect the cables from the connectors on the system board, power board and converter board.

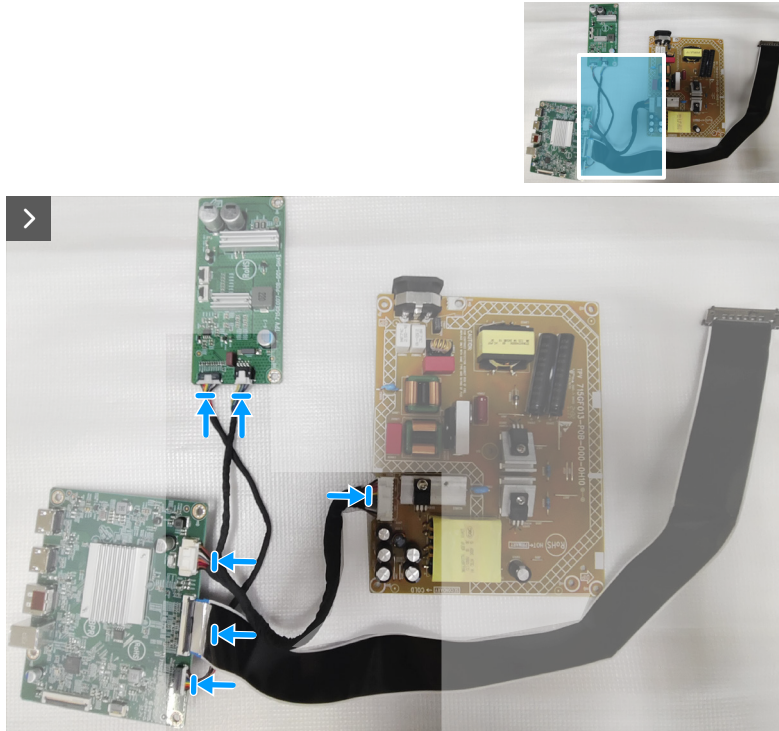


**Figure 32. Removing the system board and power board**

## Installing the system board and power board

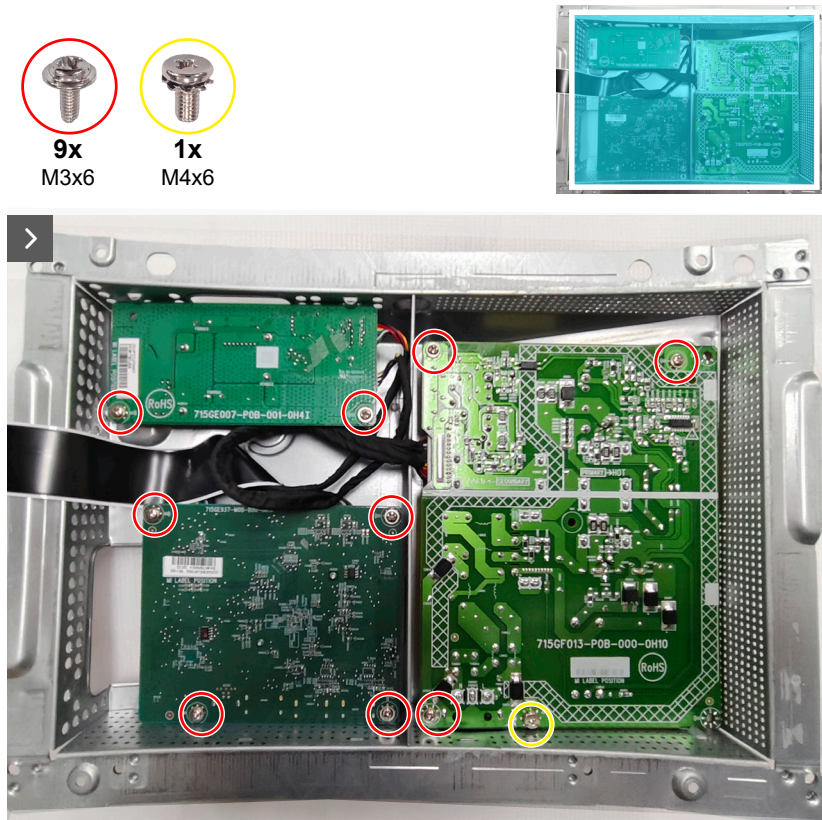
### Steps

1. Connect the cables to the connectors on the system board, power board and converter board.



**Figure 33. Installing the system board and power board**

2. Replace the nine screws (M3x6) and the screw (M4x6) to secure the system board, power board and converter board to the metal shield.



**Figure 34. Installing the system board and power board**

3. Place the Mylar sheet on the power board.



**Figure 35. Installing the system board and power board**

#### **Next steps**

1. Install the [metal shield](#).
2. Install the [back cover](#).
3. Install the [stand](#).
4. Follow the procedure in [After working inside your monitor](#).

## **Middle frame**

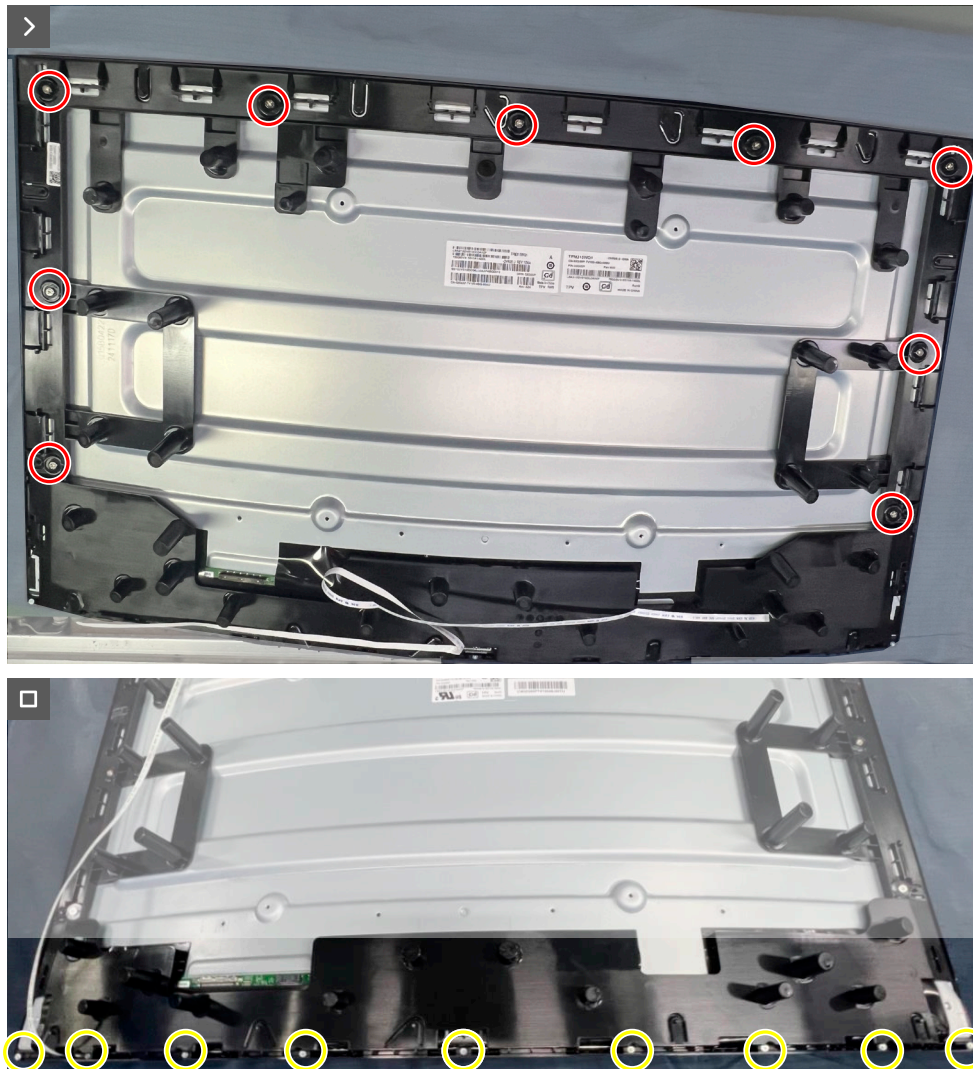
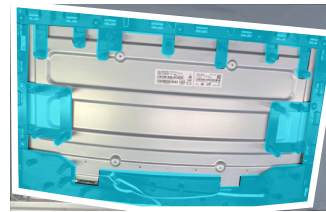
### **Removing the middle frame**

#### **Prerequisites**

1. Follow the procedure in [Before working inside your monitor](#).
2. Remove the [stand](#).
3. Remove the [back cover](#).
4. Remove the [metal shield](#).

#### **Steps**

1. Remove the nine screws (M3X4) and the nine screws (Q2X3.2) that secure the middle frame to the display panel.



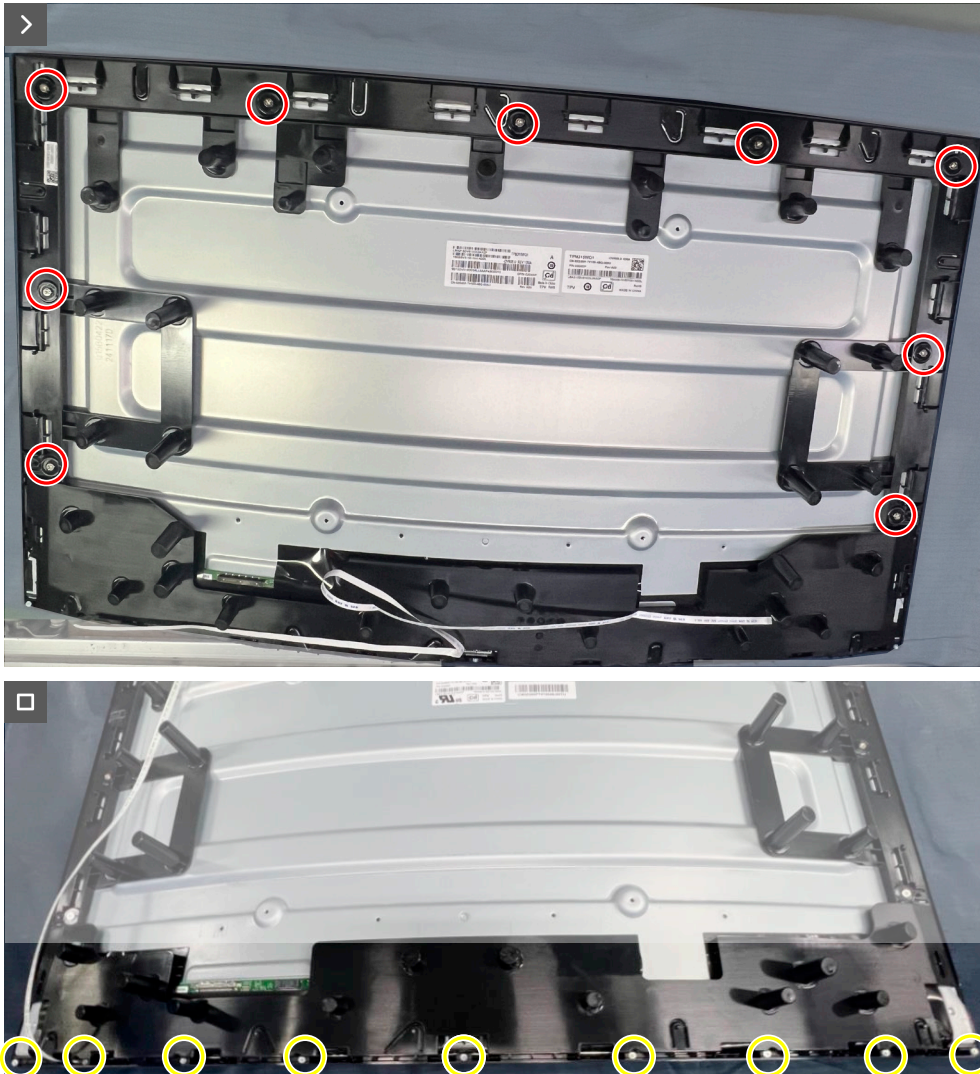
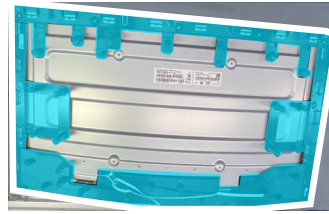
**Figure 36. Removing the middle frame**

2. Lift and remove the middle frame away from the display panel.

## **Installing the middle frame**

### **Steps**

1. Replace the nine screws (M3X4) and the nine screws (Q2X3.2) to secure the middle frame to the display panel.



**Figure 37. Installing the middle frame**

**Next steps**

1. Install the [metal shield](#).
2. Install the [back cover](#).
3. Install the [stand](#).
4. Follow the procedure in [After working inside your monitor](#).

# Power-button board

## Removing the power-button board

### Prerequisites

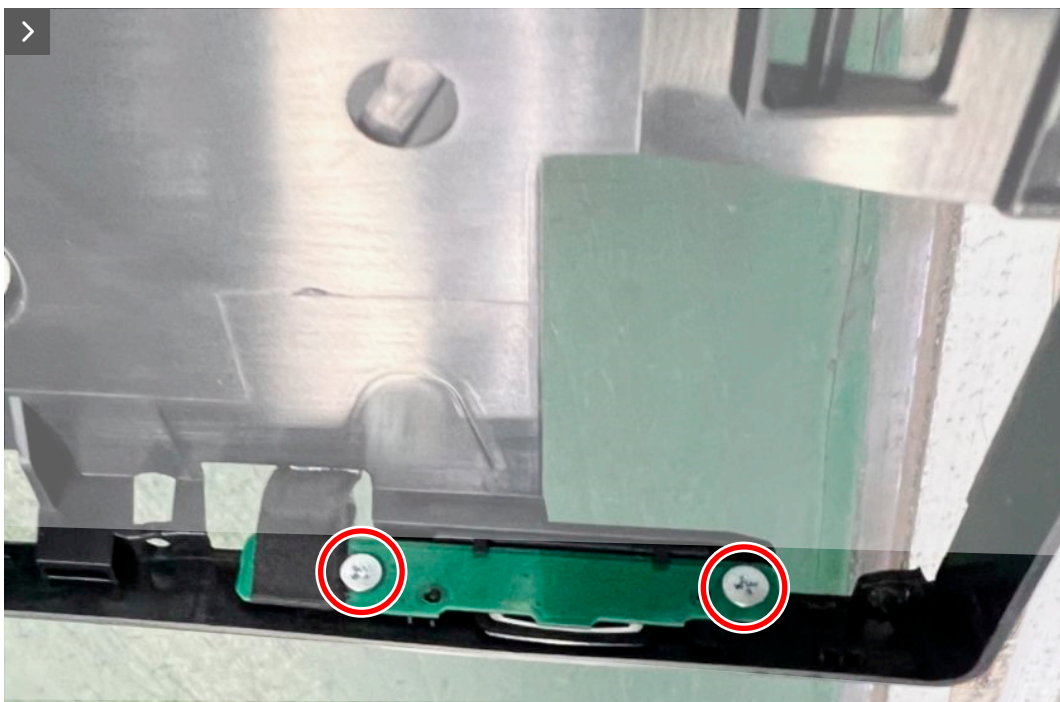
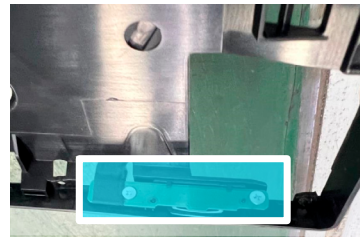
1. Follow the procedure in [Before working inside your monitor](#).
2. Remove the [stand](#).
3. Remove the [back cover](#).
4. Remove the [metal shield](#).
5. Remove the [middle frame](#).

### Steps

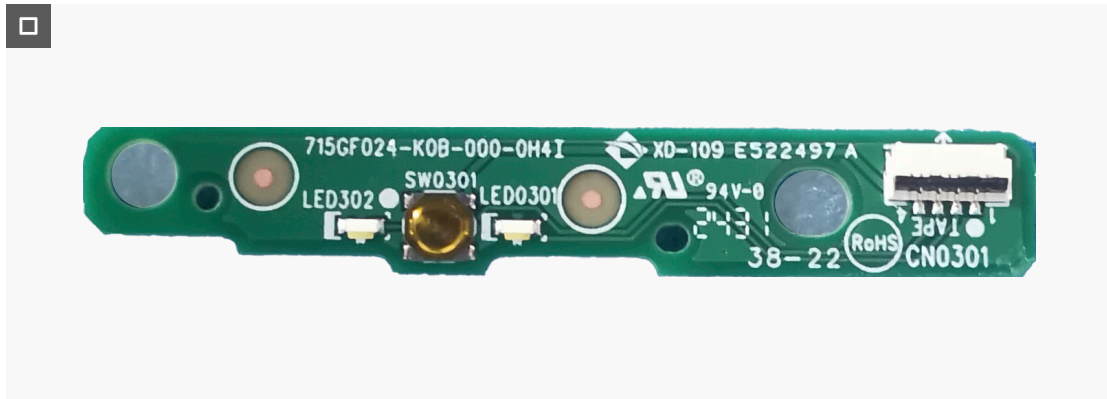
1. Remove the two screws (Q2x2) that secure the power-button board to the middle frame.
2. Lift the power-button board away from the middle frame.



**2x**  
Q2x2



**Figure 38. Removing the power-button board**



**Figure 39. Removing the power-button board**

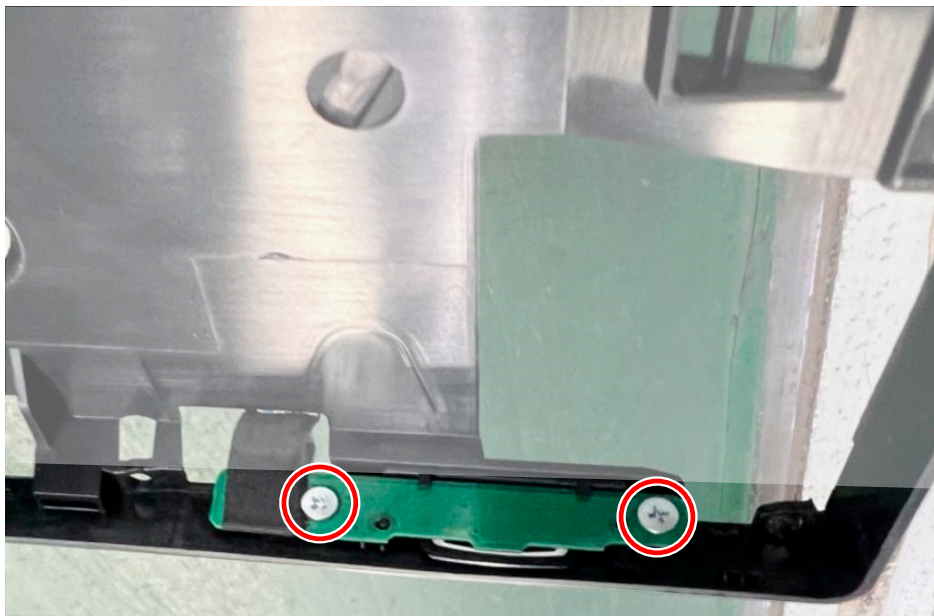
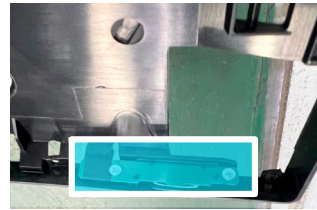
## Installing the power-button board

### Steps

1. Align and place the power-button board in its slot on the middle frame.
2. Replace the two screws (Q2x2) to secure the power-button board to the middle frame.



**2x**  
Q2x2



**Figure 40. Installing the power-button board**

### Next steps

1. Install the [middle frame](#).
2. Install the [metal shield](#).
3. Install the [back cover](#).
4. Install the [stand](#).
5. Follow the procedure in [After working inside your monitor](#).

# I/O board and joystick-button board

## Removing the I/O board and joystick-button board

### Prerequisites

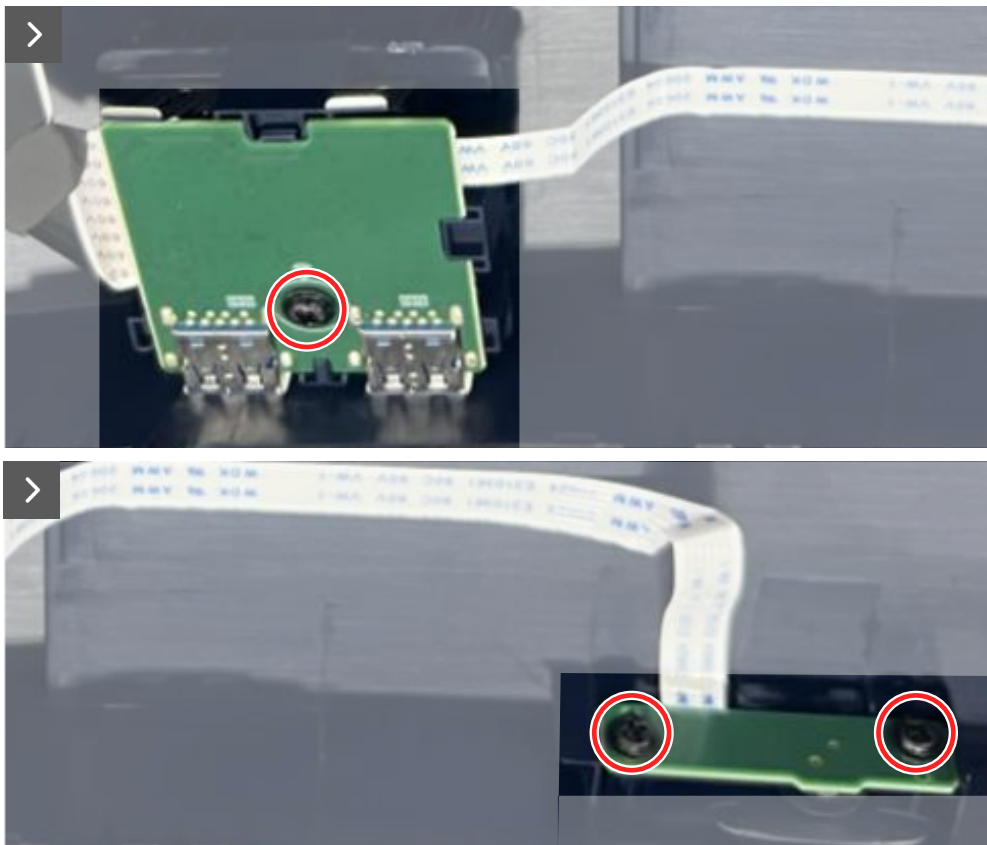
1. Follow the procedure in [Before working inside your monitor](#).
2. Remove the [stand](#).
3. Remove the [back cover](#).

### Steps

1. Remove the screw (Q3x6) that secures the I/O board to the back cover.
2. Remove the two screws (Q3x6) that secure the joystick-button board to the back cover.

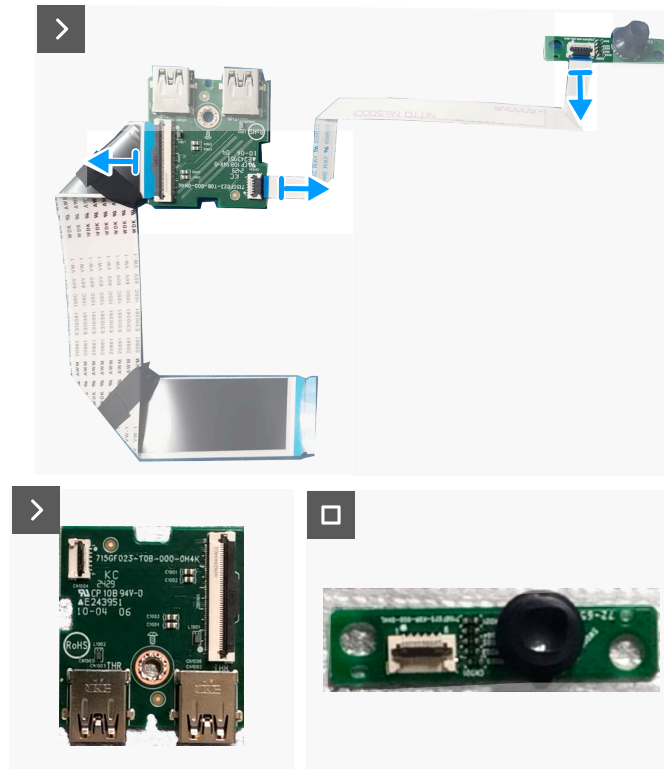


**3x**  
Q3x6



**Figure 41. Removing the I/O board and joystick-button board**

3. Disconnect the cables from the connectors on the I/O board and the joystick-button board.



**Figure 42. Removing the I/O board and joystick-button board**

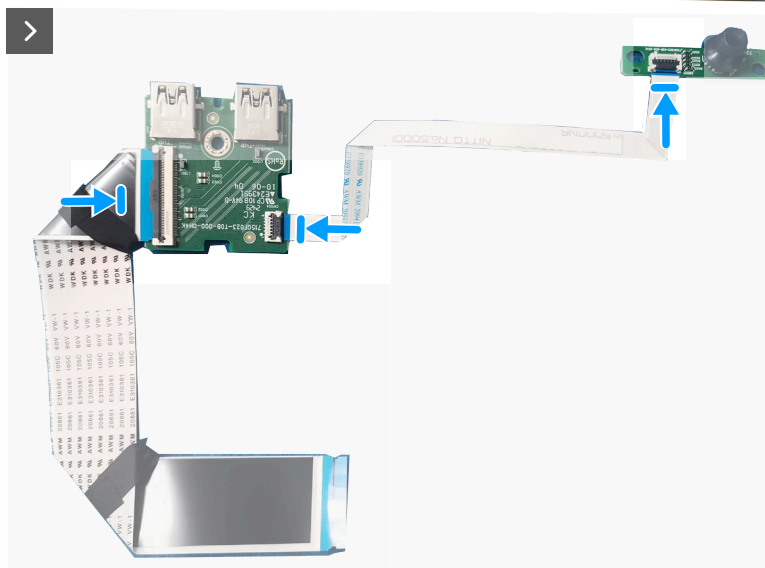
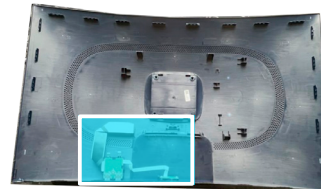
## Installing the I/O board and joystick-button board

### Steps

1. Connect the cables to the connectors on the I/O board and the joystick-button board.

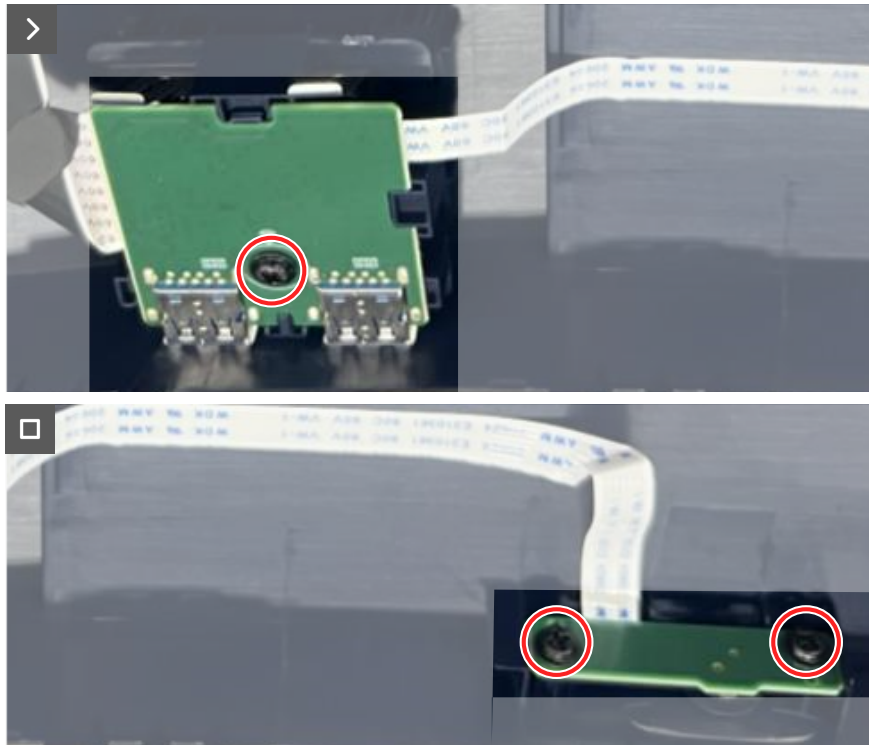


**3x**  
Q3x6



**Figure 43. Installing the I/O board and joystick-button board**

2. Replace the screw (Q3x6) to secure the I/O board to the back cover.
3. Replace the two screws (Q3x6) to secure the joystick-button board to the back cover.



**Figure 44. Installing the I/O board and joystick-button board**

**Next steps**

1. Install the [back cover](#).
2. Install the [stand](#).
3. Follow the procedure in [After working inside your monitor](#).

# Troubleshooting

**⚠ WARNING:** Before you begin any of the procedures in this section, follow the [Safety instructions](#).

## Self-test

Your monitor provides a self-test feature that allows you to check whether your monitor is functioning properly. If your monitor and computer are properly connected but the monitor screen remains dark, run the monitor self-test by performing the following steps:

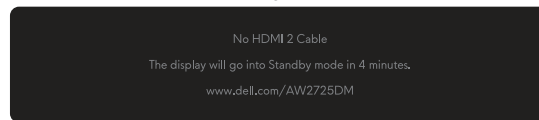
1. Turn off both your computer and the monitor.
2. Unplug the video cable from the computer.
3. To ensure proper self-test operation, remove all digital and the analog cables from your computer.
4. Turn on the monitor.

A dialog box should appear on-screen, indicating that the monitor is working correctly and is not receiving a video signal. While in self-test mode, the power LED remains white (the default color).



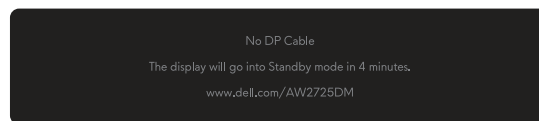
**Figure 45. Warning message for no HDMI 1 cable**

or



**Figure 46. Warning message for no HDMI 2 cable**

or



**Figure 47. Warning message for no DP cable**

**ⓘ NOTE:** The message may vary slightly depending on the connected input signal.

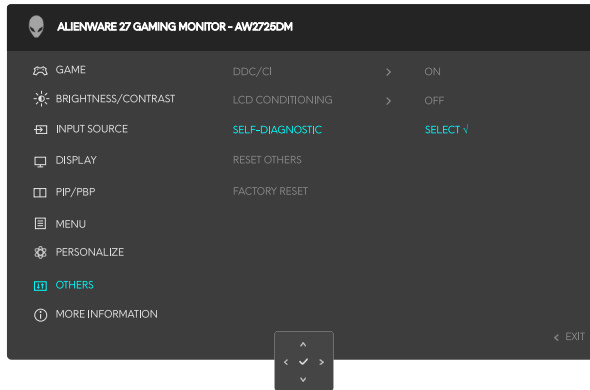
**ⓘ NOTE:** This dialog box also appears during normal operation, if the video cable is disconnected or damaged.

5. Turn off your monitor and reconnect the video cable; then turn on your computer and the monitor.

After performing the above steps, if the monitor displays no video output, then the problem may be with the graphics card or the computer.

# Built-in diagnostics

Your monitor has built-in diagnostic tools that help you determine if the screen abnormality or audible noise you are experiencing is an inherent problem with your monitor.



**Figure 48. The message of Built-in diagnostics**

### To run the built-in diagnostics:

1. Ensure that the screen is clean (there are no dust particles on the surface of the screen).
2. Move or press the joystick button to launch the Menu Launcher.
3. Move the joystick button up to select and open the Main Menu.
4. Move the joystick button to navigate and select **OTHERS > SELF-DIAGNOSTIC** from the OSD menu.
5. Press the joystick button to start the built-in diagnostics. A gray screen is displayed.
6. Observe if the screen has any defects or abnormalities.
7. Toggle the joystick button once again until a red screen is displayed.
8. Observe if the screen has any defects or abnormalities.

Repeat steps 7 and 8 until the screen displays green, blue, black, and white colors. Note any abnormalities or defects.

The test is complete when a text screen is displayed. To exit, toggle the joystick button control again.

If you do not detect any screen abnormalities upon using the built-in diagnostic tool, the monitor is functioning properly. Check the video card and computer.

## Common problems

The following table contains general information about common monitor problems that you might encounter and the possible solutions:

**Table 7. Common problems description.**

Common symptoms	What you experience	Possible solutions
No video/Power LED off	No picture	<ul style="list-style-type: none"> <li>Verify that the power outlet is functioning properly using any other electrical equipment.</li> <li>Ensure that the power button is pressed properly.</li> </ul>
No video/Power LED on	No picture or no brightness	<ul style="list-style-type: none"> <li>Increase brightness and contrast controls. For more information, see <i>BRIGHTNESS/CONTRAST OSD</i> menu in the <i>User's Guide</i> of AW3225DM.</li> <li>Perform monitor <a href="#">Self-test</a> feature check.</li> <li>Check for bent or broken pins in the video cable connector.</li> <li>Run the built-in diagnostics. For more information, see <i>SELF-DIAGNOSTIC OSD</i> menu in the <i>User's Guide</i> of AW3225DM.</li> <li>Ensure that the correct input source is selected. For more information, see <i>INPUT SOURCE OSD</i> menu in the <i>User's Guide</i> of AW3225DM.</li> </ul>
Poor focus	Picture is fuzzy, blurry, or ghosting	<ul style="list-style-type: none"> <li>Disconnect video extension cables.</li> <li>Reset the monitor to factory settings. For more information, see <i>FACTORY RESET OSD</i> menu in the <i>User's Guide</i> of AW3225DM.</li> <li>Change the video resolution to the correct aspect ratio.</li> </ul>
Shaky/jittery video	Wavy picture or fine movement	<ul style="list-style-type: none"> <li>Reset the monitor to factory settings. For more information, see <i>FACTORY RESET OSD</i> menu in the <i>User's Guide</i> of AW3225DM.</li> <li>Check environmental factors.</li> <li>Relocate the monitor and test in another room.</li> </ul>
Missing pixels	LCD screen has spots	<ul style="list-style-type: none"> <li>Cycle power On-Off.</li> <li>Pixel that is permanently off is a natural defect that can occur in LCD technology.</li> <li>For more information about Dell Monitor Quality and Pixel Policy, see <a href="#">Dell Display Pixel Guidelines</a>.</li> </ul>
Stuck-on pixels	LCD screen has bright spots	<ul style="list-style-type: none"> <li>Cycle power On-Off.</li> <li>Pixel that is permanently off is a natural defect that can occur in LCD technology.</li> <li>For more information about Dell Monitor Quality and Pixel Policy, see <a href="#">Dell Display Pixel Guidelines</a>.</li> </ul>
Brightness problems	Picture too dim or too bright	<ul style="list-style-type: none"> <li>Reset the monitor to factory settings. For more information, see <i>FACTORY RESET OSD</i> menu in the <i>User's Guide</i> of AW3225DM.</li> <li>Adjust brightness and contrast controls. For more information, see <i>BRIGHTNESS/CONTRAST OSD</i> menu in the <i>User's Guide</i> of AW3225DM.</li> </ul>
Geometric distortion	Screen not centered correctly	Reset the monitor to factory settings. For more information, see <i>FACTORY RESET OSD</i> menu in the <i>User's Guide</i> of AW3225DM.
Horizontal/vertical lines	Screen has one or more lines	<ul style="list-style-type: none"> <li>Reset the monitor to factory settings. For more information, see <i>FACTORY RESET OSD</i> menu in the <i>User's Guide</i> of AW3225DM.</li> <li>Perform monitor <a href="#">Self-test</a> feature check and determine if these lines also appear in self-test mode.</li> <li>Check for bent or broken pins in the video cable connector.</li> <li>Run the built-in diagnostics. For more information, see <i>SELF-DIAGNOSTIC OSD</i> menu in the <i>User's Guide</i> of AW3225DM.</li> </ul>
Synchronization problems	Screen is scrambled or appears torn	<ul style="list-style-type: none"> <li>Reset the monitor to factory settings. For more information, see <i>FACTORY RESET OSD</i> menu in the <i>User's Guide</i> of AW3225DM.</li> <li>Perform monitor <a href="#">Self-test</a> feature check to determine if the scrambled screen appears in self-test mode.</li> <li>Check for bent or broken pins in the video cable connector.</li> <li>Restart the computer in the safe mode.</li> </ul>

<b>Common symptoms</b>	<b>What you experience</b>	<b>Possible solutions</b>
Safety-related issues	Visible signs of smoke or sparks	<ul style="list-style-type: none"> <li>Do not perform any troubleshooting steps.</li> <li><a href="#">Contacting Dell</a> immediately.</li> </ul>
Intermittent problems	Monitor malfunctions on and off	<ul style="list-style-type: none"> <li>Ensure that the video cable connecting the monitor to the computer is connected properly and is secure.</li> <li>Reset the monitor to factory settings. For more information, see <i>FACTORY RESET OSD</i> menu in the <i>User's Guide</i> of AW3225DM.</li> <li>Perform monitor <a href="#">Self-test</a> feature check to determine if the intermittent problem occurs in self-test mode.</li> </ul>
Missing color	Picture missing color	<ul style="list-style-type: none"> <li>Perform monitor <a href="#">Self-test</a> feature check.</li> <li>Ensure that the video cable connecting the monitor to the computer is connected properly and is secure.</li> <li>Check for bent or broken pins in the video cable connector.</li> </ul>
Wrong color	Picture color not good	<ul style="list-style-type: none"> <li>Reset all settings under the <b>GAME</b> menu to the factory defaults using RESET GAME. For more information, see <i>RESET GAME OSD</i> menu in the <i>User's Guide</i> of AW3225DM</li> <li>Change the <b>INPUT COLOR FORMAT</b> to <b>RGB</b> or <b>YCbCr</b> in the <b>Display</b> settings OSD.</li> <li>Run the built-in diagnostics. For more information, see <i>SELF-DIAGNOSTIC OSD</i> menu in the <i>User's Guide</i> of AW3225DM.</li> </ul>
Wrong color in HDR mode	Color banding in the pictures	Try to reduce the frequency (DP: 2560 x 1440 at 60 Hz, HDMI: 2560 x 1440 at 60 Hz).
Screen image is too small	Image is centered on the screen, but does not fill the entire viewing area	<ul style="list-style-type: none"> <li>Check the <b>ASPECT RATIO</b> settings in the <b>DISPLAY</b> menu OSD.</li> <li>Reset the monitor to factory settings. For more information, see <i>FACTORY RESET OSD</i> menu in the <i>User's Guide</i> of AW3225DM.</li> </ul>
Cannot adjust the monitor with the joystick button	OSD does not appear on the screen	<ul style="list-style-type: none"> <li>Turn off the monitor, unplug the power cable, plug it back, and then turn on the monitor.</li> <li>Check whether the OSD menu is locked. If yes, move and hold the joystick button up/down/left/right for 4 seconds to unlock. For more information, see <i>Locking the control buttons</i> in the <i>User's Guide</i> of AW3225DM.</li> </ul>
No input signal when user controls are pressed	No picture, the LED light is on	<ul style="list-style-type: none"> <li>Check the signal source. Ensure that the computer is not in the power-saving mode by moving the mouse or pressing any key on the keyboard.</li> <li>Check whether the signal cable is plugged in properly. Re-plug the signal cable if necessary.</li> <li>Reset the computer or video player.</li> </ul>
The picture does not fill the entire screen	The picture cannot fill the height or width of the screen	<ul style="list-style-type: none"> <li>Due to different video formats (aspect ratio), the monitor may display in full screen.</li> <li>Run the built-in diagnostics. For more information, see <i>SELF-DIAGNOSTIC OSD</i> menu in the <i>User's Guide</i> of AW3225DM.</li> </ul>
The displayed pictures appear incorrectly when the DP/HDMI cable is connected through a USB-C adapter or dock to your laptop or desktop	Display will freeze, has black screen or will display abnormal screen	Do not use a USB-C adapter or dock. Connect the DP/HDMI cable directly to your laptop or desktop.

Common symptoms	What you experience	Possible solutions
Screen flickering	There is some noticeable flickering in the displayed pictures	<ul style="list-style-type: none"> <li>• Use the native resolution of your monitor (2560 x 1440 at 60 Hz) or a higher refresh rate.</li> <li>• If the variable refresh rate (VRR) of your device is turned on, turn off variable refresh rate (VRR).</li> <li>• If you are using an NVIDIA graphics card and G-Sync is turned on, turn off G-Sync.</li> <li>• If you are using an AMD graphics card and Free-Sync is turned on, turn off Free-Sync.</li> <li>• Update the graphics card driver and firmware to the latest version.</li> <li>• Change the cable connecting the monitor to the computer. A defective cable can cause the signal to break while being transmitted across the wire.</li> <li>• Check the surroundings. Electromagnetic fields can cause screen flickering. If there is another device plugged into the same power strip as the monitor, try to remove it.</li> </ul>
Image retention from a static image left on the monitor for a long period of time	Faint shadow from the static image displayed appears on the screen	<ul style="list-style-type: none"> <li>• Set the screen to turn off after a few minutes of screen idle time. This can be adjusted in the Windows Power Options or Mac Energy Saver setting.</li> <li>• Alternatively, use a dynamically changing screensaver.</li> <li>• For more information, see <i>Maintenance guidelines</i> in the <i>User's Guide</i> of AW3225DM.</li> </ul>
Unevenness in luminance or color of the screen images	Visible spots (bright or dark) or lines or Mura appear on the screen	
Pixel shifting occurs	The image on the screen moves slightly sometimes.	Pixel shift is a function that moves the pixels of the screen to prevent image retention on VA panels. It does not influence your viewing experience.
Cannot select 10-bit color	Unable to select 10-bit color from the connected computer	<ul style="list-style-type: none"> <li>• If your computer is equipped with an NVIDIA graphics card, go to <b>NVIDIA control panel &gt; Resolutions &gt; Output Color Depth</b>, select <b>10 bpc</b> (bits per color) from the <b>Color Depth</b> dropdown menu, and click <b>Apply</b>.</li> <li>• For your computer is equipped with an AMD graphics card, go to <b>AMD RADEON PRO AND AMD FIREPRO SETTINGS &gt; Display &gt; Color Depth</b>, and select <b>10 bpc</b> from the drop-down list.</li> </ul>
Cannot adjust the gaming features using AWCC	No <b>SETTING</b> panel	<ul style="list-style-type: none"> <li>• Check whether the DP/HDMI cable is plugged in properly. Re-plug the DP/HDMI cable as necessary.</li> <li>• Reboot your computer.</li> </ul>

## Universal Serial Bus (USB) specific problems

**Table 8. Universal Serial Bus (USB) specific problems.**

Common symptoms	What you experience	Possible solutions
USB interface is not working	USB peripherals are not working	<ul style="list-style-type: none"> <li>▪ Check that your display is turned ON.</li> <li>▪ Reconnect the upstream cable to your computer.</li> <li>▪ Reconnect the USB peripherals (downstream connector).</li> <li>▪ Turn off your monitor and turn it on again.</li> <li>▪ Restart your computer.</li> <li>▪ Certain USB devices such as portable hard drive require higher power source; connect the drive to the computer directly.</li> </ul>
USB interface is slow	USB peripherals working slowly or not working at all	<ul style="list-style-type: none"> <li>• Check that your computer supports USB 5Gbps.</li> <li>• Some computers have slower USB 2.0 and USB 1.1 ports. Ensure that the correct USB port is used.</li> <li>• Reconnect the upstream cable to your computer.</li> <li>• Reconnect the USB peripherals (downstream connector).</li> <li>• Restart your computer.</li> </ul>
Wireless USB peripherals stop working when a USB device is plugged in	Wireless USB peripherals responding slowly or only working as the distance between itself and its receiver decreases	<ul style="list-style-type: none"> <li>• Increase the distance between the USB peripherals and the wireless USB receiver.</li> <li>• Position your wireless USB receiver as close as possible to the wireless USB peripherals.</li> <li>• Use a USB-extender cable to position the wireless USB receiver as far away as possible from the adjacent USB Type-A port.</li> </ul>

# Regulatory information

## FCC notices (U.S. Only) and other regulatory information

For FCC notices and other regulatory information, see the regulatory compliance website at [Dell Regulatory Compliance Home Page](#).

## EU product database for energy label and product information sheet

AW3225DM: <https://eprel.ec.europa.eu/qr/2167431>

# Contacting Dell

To contact Dell for sales, technical support, or customer service issues, see [Contact Support at Dell Support Site](#).

- ① **NOTE:** Availability varies by country, region, or product, and some services may not be available in your country.
- ① **NOTE:** If you do not have an active Internet connection, you can find contact information in your purchase invoice, packing slip, bill, or Dell product catalog.