

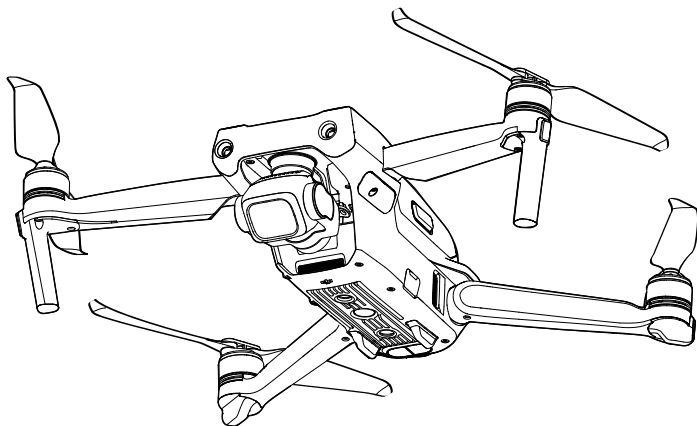

Questo manuale d'istruzione è fornito da trovaprezzi.it. Scopri tutte le offerte per [DJI Air 2S](#) o cerca il tuo prodotto tra le [migliori offerte di Droni](#)

dji AIR 2 S

User Manual v1.2 2022.10



Searching for Keywords

Search for keywords such as “battery” and “install” to find a topic. If you are using Adobe Acrobat Reader to read this document, press Ctrl+F on Windows or Command+F on Mac to begin a search.

Navigating to a Topic

View a complete list of topics in the table of contents. Click on a topic to navigate to that section.

Printing this Document

This document supports high resolution printing.

Revision Log

Version	Date	Revisions
v1.0	2021.06	1. Added flight altitude information for RTH (P15). 2. Optimized descriptions in Profile section (P6). 3. Fixed some minor issues.
v1.2	2022.10	Added FAR Remote ID Compliance Information.

Using this Manual

Legend

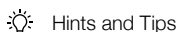

Read Before the First Flight

Read the following documents before using the DJI™ Air 2S:

1. Disclaimer and Safety Guidelines
2. Quick Start Guide
3. User Manual

It is recommend to watch all tutorial videos on the official DJI website and read the disclaimer and safety guidelines before using for the first time. Prepare for your first flight by reviewing the quick start guide and refer to this user manual for more information.

Video Tutorials

Go to the address below or scan the QR code to watch the DJI Air 2S tutorial videos, which demonstrate how to use the DJI Air 2S safely:

<http://www.dji.com/air-2s/video>



Download the DJI Fly App

Make sure to use DJI Fly during flight. Scan the QR code on the right to download the latest version.

The Android version of DJI Fly is compatible with Android v6.0 and later. The iOS version of DJI Fly is compatible with iOS v11.0 and later.



* For increased safety, flight is restricted to a height of 98.4 ft (30 m) and range of 164 ft (50 m) when not connected or logged into the app during flight. This applies to DJI Fly and all apps compatible with DJI aircraft.

Download DJI Assistant 2 (Consumer Drones Series)

Download DJI Assistant 2 (Consumer Drones Series) at <http://www.dji.com/air-2s/downloads>.



- The operating temperature of this product is 0° to 40° C. It does not meet the standard operating temperature for military grade application (-55° to 125° C), which is required to endure greater environmental variability. Operate the product appropriately and only for applications that it meets the operating temperature range requirements of that grade.

Contents

Using this Manual	2
Legend	2
Read Before the First Flight	2
Video Tutorials	2
Download the DJI Fly App	2
Download DJI Assistant 2 (Consumer Drones Series)	2
Product Profile	6
Introduction	6
Preparing the Aircraft	6
Preparing the Remote Controller	7
Aircraft Diagram	8
Remote Controller Diagram	9
Activating DJI Air 2S	9
Aircraft	11
Flight Modes	11
Aircraft Status Indicators	12
Return to Home	13
Vision Systems and Infrared Sensing System	16
Intelligent Flight Mode	19
Advanced Pilot Assistance Systems 4.0	25
Flight Recorder	26
Propellers	26
Intelligent Flight Battery	27
Gimbal and Camera	31
Remote Controller	34
Remote Controller Profile	34
Using the Remote Controller	34
Linking the Remote Controller	37
DJI Fly App	40
Home	40
Camera View	41

Flight	46
Flight Environment Requirements	46
Flight Limits and GEO Zones	46
Pre-Flight Checklist	47
Auto Takeoff/Landing	48
Starting/Stopping the Motors	48
Flight Test	49
Appendix	51
Specifications	51
Firmware Update	54
After-Sales Information	55
FAR RID Compliance Information	56

Product Profile

This section introduces DJI Air 2S and lists the components of the aircraft and remote controller.

Product Profile

Introduction

DJI Air 2S features both an Infrared Sensing System and Forward, Backward, Upward, and Downward Vision Systems, allowing for hovering and flying indoors as well as outdoors and for automatic Return to Home. The aircraft has a maximum flight speed of 42 mph (68.4 kph) and a maximum flight time of 31 minutes.

The remote controller displays the video transmission from the aircraft to DJI Fly on a mobile device and the aircraft and camera are easy to control using the onboard buttons. The maximum runtime of the remote controller is six hours.

Feature Highlights

Intelligent Flight Modes: With ActiveTrack 4.0, Spotlight 2.0, and Point of Interest 3.0, the aircraft follows or flies around a subject automatically while sensing obstacles in its path. The user can focus on operating the aircraft while the Advanced Pilot Assistance System 4.0 enables the aircraft to avoid obstacles.

Advanced Shooting Modes: Capture complicated shots effortlessly with features such as MasterShots, Hyperlapse, and QuickShots. With just a few taps, the aircraft will take off to record according to the preset path and generate a professional standard video automatically.

Gimbal and Camera: DJI Air 2S uses a 1-inch CMOS sensor camera, which can shoot 20MP photos and 5.4K 30 fps, 4K 60fps, and 1080p120 fps video. 10 bit D-Log M video is also supported, making it easier for users to adjust colors during editing.

Video Transmission: DJI Air 2S boasts four built-in antennas and DJI's long-range transmission O3 (OCUSYNC™ 3.0) technology, offering a maximum transmission range of 12 km and video quality of up to 1080p from the aircraft to the DJI Fly app on a mobile device. The remote controller works at both 2.4 and 5.8 GHz, and is capable of selecting the best transmission channel automatically without latency.



- Maximum flight time was tested in an environment with no wind while flying at a consistent 12 mph (19.4 kph) and the maximum flight speed was tested at sea level altitude with no wind. These values are for reference only.
 - The remote controller reaches its maximum transmission distance (FCC) in a wide-open area with no electromagnetic interference at an altitude of about 400 ft (120 m). The maximum transmission distance refers to the maximum distance that the aircraft can still send and receive transmissions. It does not refer to the maximum distance the aircraft can fly in a single flight. The maximum runtime was tested in a laboratory environment and without charging the mobile device. This value is for reference only.
 - 5.8 GHz is not supported in some regions. Observe the local laws and regulations.
-

Preparing the Aircraft

All aircraft arms are folded before the aircraft is packaged. Follow the steps below to unfold the aircraft.

1. Remove the gimbal protector from the camera.
2. Unfold the front arms, and then unfold the rear arms.

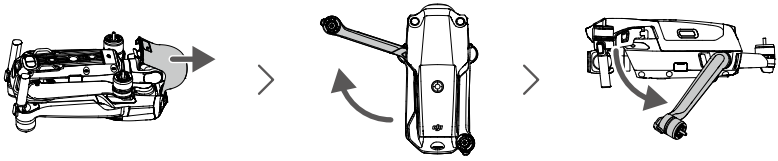

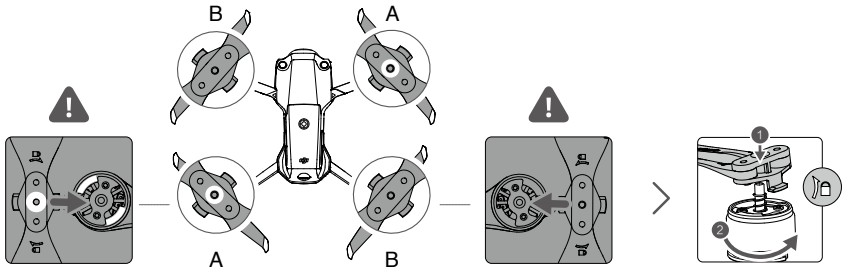

-  • Attach the gimbal protector when not in use.

3. Attach the propellers with marks to the motors with marks. Press the propeller down onto the motors and turn until it is secure. Attach the other propellers to the unmarked motors. Unfold all the propeller blades.

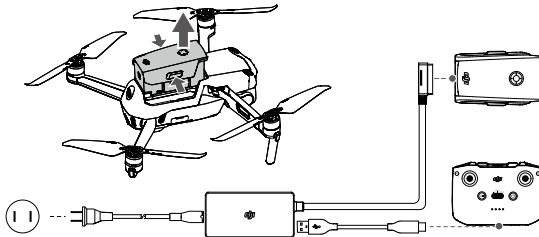

4. All Intelligent Flight Batteries are in hibernation mode before delivery to ensure safety. Use the provided charger to charge and activate the Intelligent Flight Batteries for the first time. It takes approximately 1 hour and 35 minutes to fully charge an Intelligent Flight Battery.



-  • Unfold the front arms before unfolding the rear arms.
• Make sure the gimbal protector is removed and all arms are unfolded before powering on the aircraft. Otherwise, it may affect the aircraft self-diagnostics.

Preparing the Remote Controller

1. Remove the control sticks from their storage slots on the remote controller and screw them into place.
2. Pull out the mobile device holder. Choose an appropriate remote controller cable based on the type of mobile device. A Lightning connector cable, Micro USB cable, and USB-C cable are included in the packaging. Connect the end of the cable with the phone icon to your mobile device. Make sure the mobile device is secured.

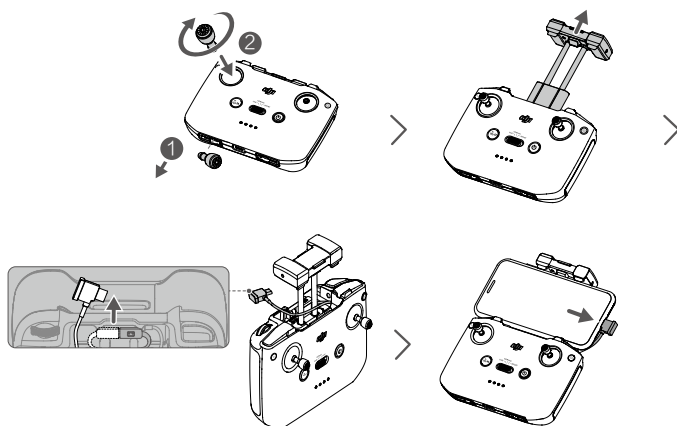

- ⚠ • If a USB connection prompt appears when using an Android mobile device, select the option to charge only. Otherwise, it may fail to connect.

Aircraft Diagram

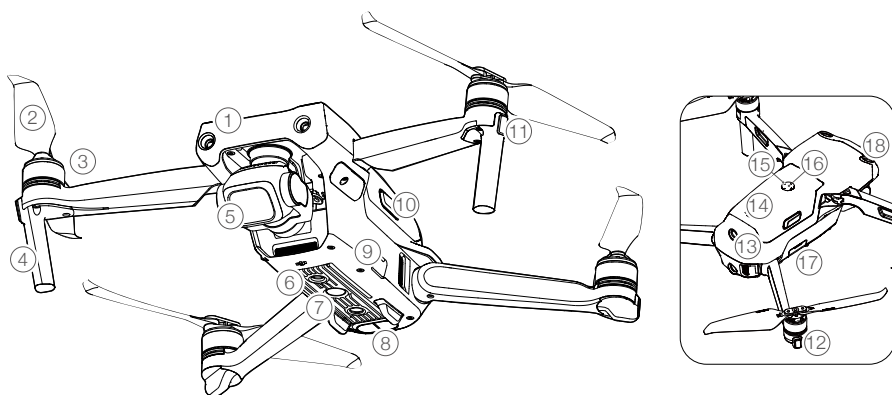

- | | |
|--------------------------------------|--------------------------------|
| 1. Forward Vision System | 10. Battery Buckles |
| 2. Propellers | 11. Front LEDs |
| 3. Motors | 12. Aircraft Status Indicators |
| 4. Landing Gears (Built-in antennas) | 13. Backward Vision System |
| 5. Gimbal and Camera | 14. Intelligent Flight Battery |
| 6. Downward Vision System | 15. Battery Level LEDs |
| 7. Auxiliary Bottom Light | 16. Power Button |
| 8. Infrared Sensing System | 17. microSD Card Slot |
| 9. USB-C Port | 18. Upward Vision System |

Remote Controller Diagram

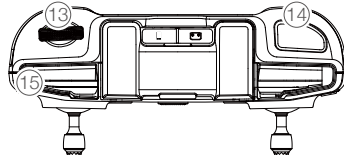
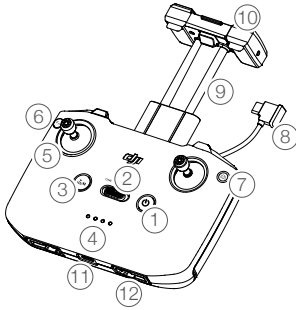

- 1. Power Button**
Press once to check the current battery level. Press once, then again, and hold to power the remote controller on or off.
- 2. Flight Mode Switch**
Switch between Sport mode, Normal mode, and Cine mode.
- 3. Flight Pause/Return to Home (RTH) Button**
Press once to make the aircraft brake and hover in place (only when GNSS or Vision Systems are available). Press and hold the button to initiate RTH. The aircraft returns to the last recorded Home Point. Press again to cancel RTH.
- 4. Battery Level LEDs**
Displays the current battery level of the remote controller.
- 5. Control Sticks**
Use the control sticks to control the aircraft movements. Set the flight control mode in DJI Fly. The control sticks are removable and easy to store.
- 6. Customizable Button**
Press once to turn the Auxiliary Bottom Light on or off. Press twice to recenter the gimbal or tilt the gimbal downward (default settings). The button can be set in DJI Fly.
- 7. Photo/Video Toggle**
Press once to switch between photo and video mode.
- 8. Remote Controller Cable**
Connect to a mobile device for video linking via the remote controller cable. Select the cable according to the mobile device.
- 9. Mobile Device Holder**
Used to securely mount the mobile device to the remote controller.
- 10. Antennas**
Relay aircraft control and video wireless signals.
- 11. USB-C Port**
For charging and connecting the remote controller to the computer.
- 12. Control Sticks Storage Slot**
For storing the control sticks.
- 13. Gimbal Dial**
Controls the tilt of the camera. Press and hold the customizable button to use the gimbal dial to adjust the zoom in video mode.
- 14. Shutter/Record Button**
Press once to take photos or start or stop recording.
- 15. Mobile Device Slot**
Used to secure the mobile device.

Activating DJI Air 2S

DJI Air 2S requires activation before using for the first time. After powering on the aircraft and remote controller, follow the on-screen instructions to activate DJI Air 2S using DJI Fly. An internet connection is required for activation.

Aircraft

DJI Air 2S contains a flight controller, video downlink system, vision systems, infrared sensing system, propulsion system, and an Intelligent Flight Battery.

Aircraft

DJI Air 2S contains a flight controller, video downlink system, vision systems, infrared sensing system, propulsion system, and an Intelligent Flight Battery.

Flight Modes

DJI Air 2S has three flight modes, plus a fourth flight mode that the aircraft switches to in certain scenarios. Flight modes can be switched via the Flight Mode switch on the remote controller.

Normal Mode: The aircraft utilizes GNSS and the Forward, Backward, Upward and Downward Vision Systems and Infrared Sensing System to locate itself and stabilize. When the GNSS signal is strong, the aircraft uses GNSS to locate itself and stabilize. When the GNSS is weak but the lighting and other environment conditions are sufficient, the aircraft uses the vision systems to locate itself and stabilize. When the Forward, Backward, Upward and Downward Vision Systems are enabled and lighting and other environment conditions are sufficient, the maximum flight altitude angle is 35° and the maximum flight speed is 15 m/s.

Sport Mode: In Sport Mode, the aircraft uses GNSS for positioning and the aircraft responses are optimized for agility and speed making it more responsive to control stick movements. The maximum flight speed is 19 m/s. Obstacle sensing is disabled in Sport mode.

Cine Mode: Cine mode is based on Normal mode and the flight speed is limited, making the aircraft more stable during shooting.

The aircraft automatically changes to Attitude (ATTI) mode when the Vision Systems are unavailable or disabled and when the GNSS signal is weak or the compass experiences interference. In ATTI mode, the aircraft may be more easily affected by its surroundings. Environmental factors such as wind can result in horizontal shifting, which may present hazards, especially when flying in confined spaces.



- The Forward, Backward and Upward Vision Systems are disabled in Sport mode, which means the aircraft cannot sense obstacles on its route automatically.
 - The maximum speed and braking distance of the aircraft significantly increase in Sport mode. A minimum braking distance of 30 m is required in windless conditions.
 - A minimum braking distance of 10 m is required in windless conditions while the aircraft is ascending and descending.
 - The responsiveness of the aircraft significantly increases in Sport mode, which means a small control stick movement on the remote controller translates into the aircraft moving a large distance. Make sure to maintain adequate maneuvering space during flight.
-

Aircraft Status Indicators



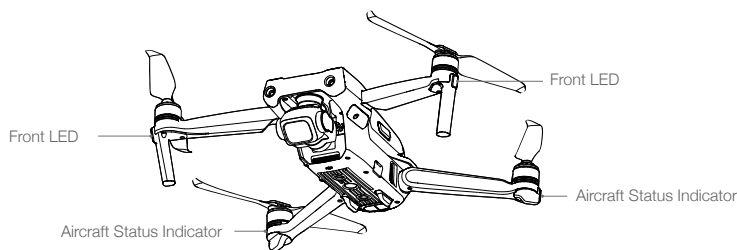







DJI Air 2S has front LEDs and aircraft status indicators.



When the aircraft is powered on but the motors are not running, the front LEDs glow solid green to display the orientation of the aircraft. When the aircraft is powered on but the motors are not running, the aircraft status indicators display the status of the flight control system. Refer to the table below for more information about the aircraft status indicators.



After the motor starts, the front LEDs blink green and the aircraft status indicators blink red and green alternately.

Aircraft Status Indicator States



	Color	Action	Aircraft Status
Normal States			
	Alternating red, green, and yellow	Blinks	Turning on and performing self-diagnostic tests
 x4	Yellow	Blinks four times	Warming up
	Green	Blinks slowly	GNSS enabled
 x2	Green	Periodically blinks twice	Vision Systems enabled
	Yellow	Blinks slowly	NO GNSS or Vision Systems
Warning States			
	Yellow	Blinks quickly	Remote controller signal lost
	Red	Blinks slowly	Low battery
	Red	Blinks quickly	Critically low battery
	Red	Blinks	IMU error
 —	Red	Solid	Critical error
	Alternating red and yellow	Blinks quickly	Compass calibration required

Return to Home

Return to Home (RTH) returns the aircraft to the last recorded Home Point when the positioning system is functioning normally. There are three types of RTH: Smart RTH, Low Battery RTH, and Failsafe RTH. The aircraft automatically flies back to the Home Point and lands when Smart RTH is initiated, the aircraft enters Low Battery RTH, or the video link signal is lost during flight.

	GNSS	Description
Home Point	 10	The default Home Point is the first location where the aircraft received a strong to moderately strong GNSS signal where the icon is white. The Home Point can be updated before takeoff as long as the aircraft receives a strong to moderately strong GNSS. If the GNSS signal is weak then the Home Point cannot be updated.

Smart RTH

If the GNSS signal is sufficient, Smart RTH can be used to bring the aircraft back to the Home Point. Smart RTH is initiated either by tapping  in DJI Fly or by pressing and holding the RTH button on the remote controller until it beeps. Exit Smart RTH by tapping  in DJI Fly or by pressing the RTH button on the remote controller.

Smart RTH includes Straight Line RTH and Power Saving RTH.

Straight Line RTH Procedure:

1. The Home Point is recorded.
2. Smart RTH is triggered.
3.
 - a. If the aircraft is farther than 50 m from the Home Point when the RTH procedure begins, the aircraft adjusts its orientation and ascends to the preset RTH altitude and flies to the Home Point. If the current altitude is higher than the RTH altitude, the aircraft flies to the Home Point at the current altitude.
 - b. If the aircraft is at a distance of 5 to 50 m from the Home Point when the RTH procedure begins, the aircraft adjusts its orientation and flies to the Home Point at the current altitude.
 - c. If the aircraft is less than 5 m from the Home Point when the RTH procedure begins, it lands immediately.
4. After reaching the Home Point, the aircraft lands and the motors stop.



- If the RTH is triggered through DJI Fly and the aircraft is farther than 5 m from the Home Point, a prompt will appear in the app for users to select a landing option.

Power Saving RTH Procedure:

During Straight Line RTH, if the distance is farther than 480 m and the altitude is more than 90 m above the RTH altitude as well as more than 290 m above the takeoff altitude, a prompt appears in DJI Fly asking the user if they wish to enter Power Saving RTH. After entering Power Saving RTH, the aircraft adjusts to an angle of 14° and flies to the Home Point. The aircraft lands when it is above the Home Point and the motors stop.

The aircraft exits from power saving RTH and enter Straight Line RTH in the following scenarios:

1. If the pitch stick is pulled down.
2. If the remote controller signal is lost.
3. If the Vision Systems become unavailable.

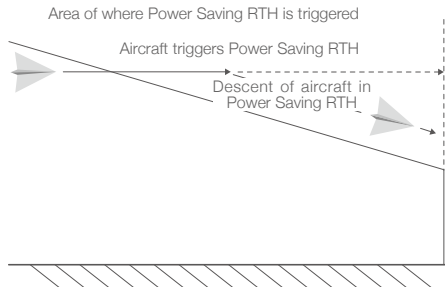

Low Battery RTH

Low Battery RTH is triggered when the Intelligent Flight Battery is depleted to the point that the safe return of the aircraft may be affected. Return home or land the aircraft immediately when prompted.

DJI Fly displays a warning when the battery level is low. The aircraft will automatically return to the Home Point if no action is taken after a 10 second countdown.

The user can cancel RTH by pressing the RTH button or Flight Pause button on the remote controller. If RTH is cancelled following a low battery level warning, the Intelligent Flight Battery may not have enough power for the aircraft to land safely, which may lead to the aircraft crashing or being lost.

The aircraft will land automatically if the current battery level can only support the aircraft long enough to descend from its current altitude. Auto landing cannot be canceled but the remote controller can be used to alter the direction of the aircraft during the landing process.

Failsafe RTH

If the Home Point was successfully recorded and the compass is functioning normally, Failsafe RTH automatically activates after the remote controller signal is lost for more than 6 seconds. The aircraft will fly backwards for 50 m on its original flight route, and then enter Straight Line RTH. If the aircraft is less than 50 m from the Home Point when the video signal is lost, it flies to the Home Point at the current altitude.

After flying for 50 m:

1. If the aircraft is less than 50 m from the Home Point, it flies back to the Home Point at the current altitude.
2. If the aircraft is farther than 50 m from the Home Point and the current altitude is higher than the preset RTH altitude, it flies back to the Home Point at the current altitude.
3. If the aircraft is farther than 50 m from the Home Point and the current altitude is lower than the preset RTH altitude, it ascends to the preset RTH altitude and then flies back to the Home Point.

Obstacle Avoidance During RTH

When aircraft is ascending:

1. The aircraft brakes when an obstacle is sensed from in front and flies backward until a safe distance is reached before continuing to ascend.

2. The aircraft brakes when an obstacle is sensed from behind and flies forward until a safe distance is reached before continuing to ascend.
3. The aircraft brakes when an obstacle is sensed from above and flies forward until a safe distance is reached before continuing to ascend.
4. No operation will occur when an obstacle is sensed below the aircraft.

When aircraft is flying forward:

1. The aircraft brakes when an obstacle is sensed from in front and files backward to a safe distance. It ascends until no obstacle is sensed and continues to ascend another 5 m and then continues to fly forward.
2. No operation will occur when an obstacle is sensed from behind.
3. No operation will occur when an obstacle is sensed from above.
4. The aircraft brakes when an obstacle is sensed from below and ascends until no obstacle is sensed before flying forward.



- During RTH, obstacles on either side of the aircraft cannot be detected or avoided.
 - When ascending in RTH, the aircraft will stop ascending and exit from RTH if the throttle stick is pulled all the way down. The aircraft can be controlled after the throttle stick is released.
 - When flying forward in RTH, the aircraft will brake and hover in place and exit from RTH if the pitch stick is pulled all the way down. The aircraft can be controlled after the pitch stick is released.
 - If the aircraft reaches the max altitude while it is ascending during RTH, the aircrafts stops and returns to home at the current altitude. If the aircraft reaches the max altitude while it is ascending after detecting obstacles in front, the aircraft will hover in place.
 - The aircraft may not be able to return to the Home Point normally if the GNSS signal is weak or unavailable. The aircraft may enter ATTI mode if the GNSS signal becomes weak or unavailable after entering Failsafe RTH. The aircraft will hover in place for a while before landing.
 - It is important to set a suitable RTH altitude before each flight. Launch DJI Fly and set the RTH altitude. The default RTH altitude is 100 m.
 - The aircraft cannot avoid obstacles during Failsafe RTH if the Forward, Backward, and Upward Vision Systems are unavailable.
 - During RTH, the speed and altitude of the aircraft can be controlled using the remote controller or DJI Fly if the remote controller signal is normal. The orientation of the aircraft and the direction of flight, however, cannot be controlled. The aircraft cannot avoid obstacles if the pitch stick is used to accelerate and the flight speed exceeds 15 m/s.
 - If the aircraft flies into a GEO zone during RTH it will hover in place.
 - The aircraft may not be able to return to a Home Point when the wind speed is too high. Fly with caution.
-

Landing Protection

Landing Protection will activate during Smart RTH.

1. During Landing Protection, the aircraft will automatically detect and carefully land on suitable ground.
2. If the ground is determined unsuitable for landing, DJI Air 2S will hover and wait for pilot confirmation.
3. If Landing Protection is not operational, DJI Fly will display a landing prompt when the aircraft descends below 0.5 m. Pull down on the throttle stick or use the auto landing slider to land.

Landing Protection activates during Low Battery RTH and Failsafe RTH. The aircraft performs as follows:

During Low Battery RTH and Failsafe RTH, the aircraft hovers at 0.5 m above the ground and waits for the pilot to confirm it is suitable to land. Pull down on the throttle for one second or use the auto landing slider in the app to land. Landing Protection activates and the aircraft performs the steps listed above.

Precision Landing

The aircraft automatically scans and attempts to match the terrain features below during RTH. When the current terrain matches the Home Point terrain, the aircraft will land. A prompt will appear in DJI Fly if the terrain match fails.



- Landing Protection is activated during Precision Landing.
- The Precision Landing performance is subject to the following conditions:
 - a. The Home Point must be recorded upon takeoff and must not be changed during flight. Otherwise, the aircraft will have no record of the Home Point terrain features.
 - b. During takeoff, the aircraft must ascend at least 7 m before flying horizontally.
 - c. The Home Point terrain features must remain largely unchanged.
 - d. The terrain features of the Home Point must be sufficiently distinctive. Terrain such as snow-covered areas are not suitable.
 - e. The lighting conditions must not be too light or too dark.
- The following actions are available during Precision Landing:
 - a. Press the throttle stick down to accelerate landing.
 - b. Move the control sticks in any direction to stop Precision Landing. The aircraft will descend vertically after the control sticks are released.

Vision Systems and Infrared Sensing System

DJI Air 2S is equipped with both an Infrared Sensing System and Forward, Backward, Upward, and Downward Vision Systems.

The Forward, Backward, Upward, and Downward Vision Systems consist of two cameras each and the Infrared Sensing System consists of two 3D infrared modules.

The Downward Vision System and Infrared Sensing System helps the aircraft maintain its current position, hover in place more precisely, and to fly indoors or in other environments where GNSS is unavailable.

In addition, the Auxiliary Bottom Light located on the underside of the aircraft improves visibility for the Downward Vision System in weak light conditions.

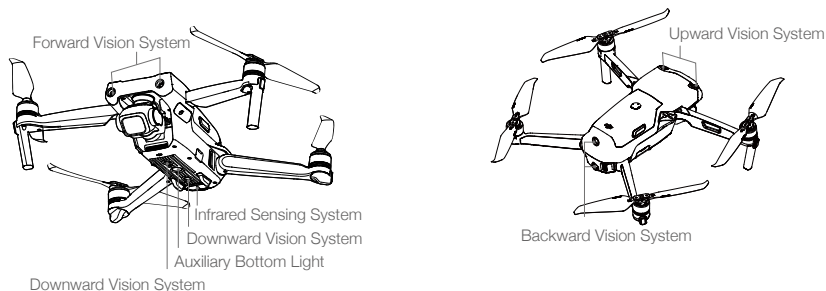

Detection Range

Forward Vision System

Detection Range: 0.38-23.8 m; FOV: 72° (horizontal), 58° (vertical)

Backward Vision System

Detection Range: 0.37-23.4 m; FOV: 57° (horizontal), 44° (vertical)

Upward Vision System

Detection Range: 0.34-28.6 m; FOV: 63° (horizontal), 78° (vertical)

Downward Vision System

The Downward Vision System works best when the aircraft is at an altitude of 0.5 to 30 m, and its operating range is 0.5 to 60 m.

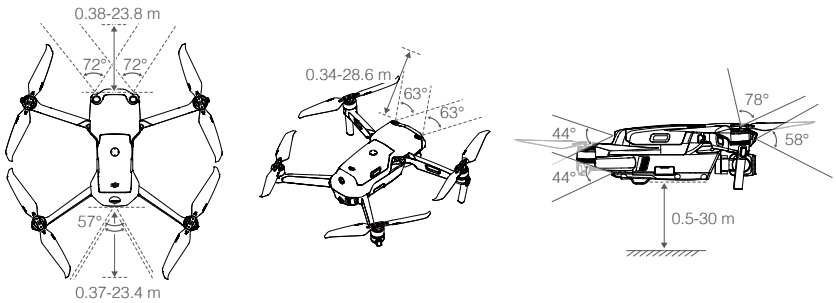

Calibrating Vision System Cameras

Auto Calibration

The Vision System cameras installed on the aircraft are factory calibrated. If any abnormality is detected with a vision system camera, the aircraft will automatically perform calibration and a prompt will appear in DJI Fly. No further operation is required.

Advanced Calibration

If the abnormality persists after auto calibration, a prompt appears in the app that advanced calibration is required. The advanced calibration must be used with DJI Assistant 2 (Consumer Drones Series). Follow the steps below to calibrate the Forward Vision System camera and repeat the steps to calibrate other Vision System cameras.

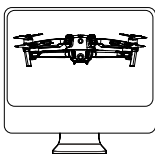

1

Point the aircraft toward the screen.

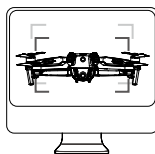

2

Align the boxes.

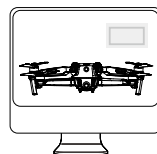

3

Pan and tilt the aircraft.

Using the Vision Systems

When GNSS is unavailable, the Downward Vision System is enabled if the surface has a clear texture and sufficient light. The Downward Vision System works best when the aircraft is at an altitude of 0.5 to 30 m.

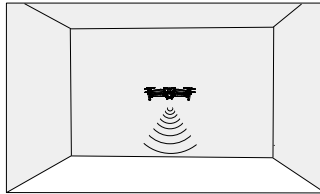

The Forward, Backward, and Upward Vision Systems will activate automatically when the aircraft is powered on if the aircraft is in Normal or Cine mode and Obstacle Avoidance is set to Bypass or Brake in DJI Fly. Using the Forward, Backward, and Upward Vision Systems, the aircraft can actively brake when detecting obstacles. The Forward, Backward, and Upward Vision Systems work best with adequate lighting and clearly marked or textured obstacles.



- Vision Systems have limited ability to sense and avoid obstacles, and the performance may be affected by the surrounding environment. Make sure to maintain visual line of sight with the aircraft and pay attention to prompts in DJI Fly.
- The max hover altitude of the aircraft is 60 m if there is no GNSS available. The Downward Vision Systems work best when the aircraft is at an altitude from 0.5 to 30 m. Extra caution is required if the altitude of the aircraft is above 30 m as the Vision Systems may be affected.
- The Auxiliary Bottom Light can be set in DJI Fly. If set to Auto, it is automatically enabled when the environment light is too weak. Note that the Vision System cameras performance may be affected when the Auxiliary Bottom Light is enabled. Fly with caution if the GNSS signal is weak.
- The Vision Systems may not function properly when the aircraft is flying over water or snow-covered areas.
- The Vision Systems cannot work properly over surfaces that do not have clear pattern variations. The Vision Systems cannot work properly in any of the following situations. Operate the aircraft cautiously.
 - a. Flying over monochrome surfaces (e.g., pure black, pure white, pure green).
 - b. Flying over highly reflective surfaces.
 - c. Flying over water or transparent surfaces.
 - d. Flying over moving surfaces or objects.
 - e. Flying in an area where the lighting changes frequently or drastically.
 - f. Flying over extremely dark (< 10 lux) or bright (> 40,000 lux) surfaces.
 - g. Flying over surfaces that strongly reflect or absorb infrared waves (e.g., mirrors).
 - h. Flying over surfaces without clear patterns or texture.
 - i. Flying over surfaces with repeating identical patterns or textures (e.g., tiles with the same design).
 - j. Flying over obstacles with small surface areas (e.g., tree branches).
- Keep the sensors clean at all times. DO NOT tamper with the sensors. DO NOT use the aircraft in dusty or humid environments.



- Calibrate the camera if the aircraft is involved in a collision or if prompted to do so in DJI Fly.
- DO NOT fly when it is raining, foggy, or if there is no clear sight.
- Check the following before each takeoff:
 - a. Make sure there are no stickers or any other obstructions over the Infrared Sensing and Vision Systems.
 - b. If there is any dirt, dust, or water on the Infrared Sensing and Vision Systems, clean it with a soft cloth. Do not use any cleanser that contains alcohol.
 - c. Contact DJI Support if there is any damage to the glass of the Infrared Sensing and Vision Systems.
- DO NOT obstruct the Infrared Sensing System.

Intelligent Flight Mode

FocusTrack

FocusTrack includes Spotlight 2.0, ActiveTrack 4.0, and Point of Interest 3.0.

Spotlight 2.0: Control the aircraft manually while the camera remains locked on the subject with this convenient mode. Move the roll stick to circle the subject, move the pitch stick to alter the distance from the subject, move the throttle stick to change the altitude, and move the pan stick to adjust the frame.

ActiveTrack 4.0: ActiveTrack 4.0 has two modes. Move the roll stick to circle the subject, move the pitch stick to alter the distance from the subject, move the throttle stick to change the altitude, and move the pan stick to adjust the frame.

1. Trace: The aircraft tracks the subject at a constant distance. In Normal and Cine mode, the maximum flight speed is 12 m/s. The aircraft can sense obstacles in this mode when there are pitch stick movements, but cannot sense obstacles when there are roll stick movements. In Sport mode, the maximum flight speed is 19 m/s and the aircraft cannot sense obstacles.
2. Parallel: The aircraft tracks the subject at a constant angle and distance from the side. In Normal and Cine mode, the maximum flight speed is 12 m/s. In Sport mode, the maximum flight speed is 19 m/s. The aircraft cannot sense obstacles in Parallel.

Point of Interest 3.0 (POI 3.0): The aircraft tracks the subject in a circle based on the radius and flight speed that is set. The mode supports both static and moving subjects such as vehicles, boats, and people. Note that the altitude of the aircraft will not change if the altitude of a subject changes and subjects that move too fast may be lost.

Using FocusTrack

1. Take off and hover at least 1 m above the ground.

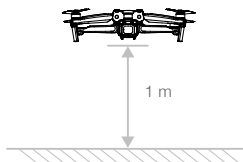

2. Drag a box around the subject in the camera view to enable FocusTrack.



3. FocusTrack begins. The default mode is Spotlight. Tap the icon to switch between Spotlight , ActiveTrack , and POI . Once subjects can be recognized, ActiveTrack will begin when a wave gesture is detected. Users can wave with a single hand and their elbow above their shoulder.
4. Tap the shutter/record button to take photos or start recording. View the footage in Playback.

Exiting FocusTrack

Tap Stop in DJI Fly or press the Flight Pause button once on the remote controller to exit FocusTrack.



- DO NOT use FocusTrack in areas with people, animals, small or fine objects (e.g., tree branches or power lines), or transparent objects (e.g., water or glass).
- Pay attention to objects around the aircraft and use the remote controller to avoid collisions with the aircraft.
- Operate the aircraft manually. Press the Flight Pause button or tap stop in DJI Fly in an emergency.
- Be extra vigilant when using FocusTrack in any of the following situations:
 - a. The tracked subject is not moving on a level plane.
 - b. The tracked subject changes shape drastically while moving.
 - c. The tracked subject is out of sight for an extended period.
 - d. The tracked subject is moving on a snowy surface.
 - e. The tracked subject has a similar color or pattern to its surrounding environment.
 - f. The lighting is extremely low (<300 lux) or high (>10,000 lux).
- Make sure to follow local privacy laws and regulations when using FocusTrack.
- It is recommended to only track vehicles, boats, and people (but not children). Fly with caution when tracking other subjects.
- Do not track a remote control model car or boat.
- The tracking subject may inadvertently swap to another subject if they pass nearby to each other.
- When using a gesture to activate ActiveTrack, the aircraft only tracks the people who perform the first detected gesture. The distance between the people and aircraft should be 5 to 10 m and the tilt angle of the aircraft should not exceed 60°.
- FocusTrack is disabled when recording at a high resolution such as 2.7K 48/50/60 fps, 1080p 48/50/60/120 fps, 4K 48/50/60 fps, and 5.4K 24/25/30 fps.

MasterShots

MasterShots keeps the subject in the center of the frame while executing different maneuvers in sequence to generate a short cinematic video.

Using MasterShots

1. Take off and hover at least 2 m above the ground.

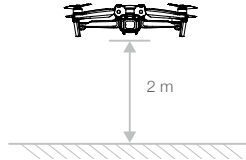

2. In DJI Fly, tap the shooting mode icon to select MasterShots and follow the prompts. Make sure that you understand how to use the shooting mode and that there are no obstacles in the surrounding area.
3. Select your target subject in the camera view by tapping the circle on the subject or dragging a box around the subject. Tap Start to begin recording. The aircraft flies back to its original position once shooting is finished.



4. Tap  to access the video.

Exiting MasterShots

Press the Flight Pause button once or tap  in DJI Fly to exit MasterShots. The aircraft will hover in place.



- Use MasterShots at locations that are clear of buildings and other obstacles. Make sure that there are no humans, animals, or other obstacles on the flight path. The aircraft will brake and hover in place if there is an obstacle detected. Note that obstacles cannot be detected on either side of the aircraft.
- Pay attention to objects around the aircraft and use the remote controller to avoid collisions with the aircraft.



- DO NOT use MasterShots in any of the following situations:
 - a. When the subject is blocked for an extended period or outside the line of sight.
 - b. When the subject is similar in color or pattern with the surroundings.
 - c. When the subject is in the air.
 - d. When the subject moves fast.
 - e. The lighting is extremely low (<300 lux) or high (>10,000 lux).
 - DO NOT use MasterShots in places that are close to buildings or where the GNSS signal is weak. Otherwise, the flight path will be unstable.
 - Make sure to follow local privacy laws and regulations when using MasterShots.
-

QuickShots

QuickShots shooting modes include Dronie, Rocket, Circle, Helix, Boomerang, and Asteroid. DJI Air 2S records according to the selected shooting mode and automatically generates a short video. The video can be viewed, edited, or shared to social media from playback.



Dronie: The aircraft flies backward and ascends, with the camera locked on the subject.



Rocket: The aircraft ascends with the camera pointing downward.



Circle: The aircraft circles around the subject.



Helix: The aircraft ascends and spirals around the subject.



Boomerang: The aircraft flies around the subject in an oval path, ascending as it flies away from its starting point and descending as it flies back. The starting point of the aircraft forms one end of the long axis of the oval while the other end of the long axis is at the opposite side of the subject from the starting point. Make sure there is sufficient space when using Boomerang. Allow a radius of at least 30 m around the aircraft and allow at least 10 m above the aircraft.



Asteroid: The aircraft flies backward and upward, takes several photos, and then flies back to the starting point. The video generated starts with a panorama of the highest position and then shows the descent. Make sure there is sufficient space when using Asteroid. Allow at least 40 m behind and 50 m above the aircraft.

Using QuickShots

1. Take off and hover at least 2 m above the ground.

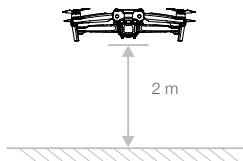

- In DJI Fly, tap the shooting mode icon to select QuickShots and follow the prompts. Make sure that you understand how to use the shooting mode and that there are no obstacles in the surrounding area.
- Select your target subject in the camera view by tapping the circle on the subject or dragging a box around the subject. Choose a shooting mode and tap Start to begin recording. QuickShots can also be triggered with a wave gesture. Users can wave with a single hand and their elbow above their shoulder. The aircraft flies back to its original position once shooting is finished.



- Tap  to access the video.

Exiting QuickShots

Press the Flight Pause button once or tap  in DJI Fly to exit QuickShots. The aircraft will hover in place.



- Use QuickShots at locations that are clear of buildings and other obstacles. Make sure that there are no humans, animals, or other obstacles on the flight path. The aircraft will brake and hover in place if there is an obstacle detected. Note that obstacles cannot be detected on either side of the aircraft.
- Pay attention to objects around the aircraft and use the remote controller to avoid collisions with the aircraft.
- DO NOT use QuickShots in any of the following situations:
 - When the subject is blocked for an extended period or outside the line of sight.
 - When the subject is more than 50 m away from the aircraft.
 - When the subject is similar in color or pattern with the surroundings.
 - When the subject is in the air.
 - When the subject moves fast.
 - The lighting is extremely low (<300 lux) or high (>10,000 lux).
- DO NOT use QuickShots in places that are close to buildings or where the GNSS signal is weak. Otherwise, the flight path will be unstable.
- Make sure to follow local privacy laws and regulations when using QuickShots.
- When using a gesture to activate QuickShots, the aircraft will only track the people who perform the first detected gesture. The distance between the people and aircraft should be 5 to 10 m and tilt angle of the aircraft should not exceed 60°.

Hyperlapse

Hyperlapse shooting modes include Free, Circle, Course Lock, and Waypoint.



Free

The aircraft automatically takes photos and generates a timelapse video. Free mode can be used while the aircraft is on the ground. After takeoff, control the movement and gimbal angle of the aircraft using the remote controller. Follow the steps below to use Free:

1. Set the interval time, video duration, and max speed. The screen displays the number of photos that will be taken and how long the shooting time will be.
2. Tap the shutter/record button to begin.

Cruise Control: Set the function of the Customizable button to Cruise Control and press the Customizable button and control stick at the same time to enter Cruise Control. The aircraft will continue to fly at the same speed.

Circle

The aircraft automatically takes photos while flying around the selected subject to generate a timelapse video. Follow the steps below to use Circle:

1. Set the interval time, video duration, and max speed. Circle can be selected to travel in either a clockwise or counter-clockwise direction. The screen displays the number of photos that will be taken and how long the shooting time will be.
2. Select a subject on the screen.
3. Tap the shutter/record button to begin.
4. Move the pan stick and gimbal dial to adjust the frame, move the tilt stick to alter the distance from the subject, move the roll stick to control the circled speed, and move the throttle stick to control the vertical flight speed.

Course Lock

Course Lock can be used in two ways. In the first way, the orientation of the aircraft is fixed, but a subject cannot be selected. In the second way, the orientation of the aircraft is fixed and the aircraft flies around a selected object. Follow the steps below to use Course Lock:

1. Set the interval time, video duration, and max speed. The screen displays the number of photos that will be taken and how long the shooting time will be.
2. Set a flight direction.
3. If applicable, select a subject. Use the gimbal dial and pan stick to adjust the frame.

4. Tap the shutter/record button to begin. Move the tilt stick and roll stick to control the horizontal flight speed and move the aircraft parallel. Move the throttle stick to control the vertical flight speed.

Waypoints

The aircraft automatically takes photos on a flight path of two to five waypoints and generates a timelapse video. The aircraft can fly in order from waypoint 1 to 5 or 5 to 1. Follow the steps below to use Waypoints.

1. Set the desired waypoints and the lens direction.
2. Set the interval time, video duration, and max speed. The screen displays the number of photos that will be taken and how long the shooting time will be.
3. Tap the shutter button to begin.

The aircraft will generate a timelapse video automatically, which is viewable in playback. In the camera settings, users can select to save the footage in JPEG or RAW format and to store the footage in the built-in storage or the microSD card.



- For optimal performance, it is recommended to use Hyperlapse at an altitude higher than 50 m and to set a difference of at least two seconds between the interval time and shutter.
 - It is recommended to select a static subject (e.g., high-rise buildings, mountainous terrain) at a safe distance from the aircraft (farther than 15 m). Do not select a subject that is too near the aircraft.
 - The aircraft brakes and hovers in place if an obstacle is detected during Hyperlapse. Note that obstacles cannot be detected on either side of the aircraft.
 - The aircraft only generates a video if it has taken at least 25 photos, which is the amount required to generate a one second video. The video is generated when a user command is received from the remote controller or if the mode is exited unexpectedly such as when Low Battery RTH is triggered.
-

Advanced Pilot Assistance Systems 4.0

The Advanced Pilot Assistance Systems 4.0 (APAS 4.0) feature is available in Normal mode. When APAS is enabled, the aircraft continues to respond to user commands and plans its path according to both control stick inputs and the flight environment. APAS makes it easier to avoid obstacles, obtain smoother footage, and gives a better flying experience.

Keep moving the pitch stick forward or backward. The aircraft will avoid the obstacles by flying above, below, or to the left or right of the obstacle.

When APAS is enabled, the aircraft can be brought to a stop by pressing the Flight Pause button on the remote controller or tapping Stop on the screen in DJI Fly. The aircraft hovers for three seconds and awaits further pilot commands.

To enable APAS, open DJI Fly, enter System Settings, then Safety, and enable APAS.



- ⚠️ • APAS is disabled when using Intelligent Flight modes and recording at high resolution such as 2.7K 48/50/60 fps, 1080p 120 fps, 4K 48/50/60 fps, and 5.4K 24/25/30 fps.
- APAS is only available when flying forward, backward, upward, and downward. APAS is disabled if the aircraft flies left or right.
- Make sure you use APAS when the Forward and Backward Vision Systems are available. Be sure there are no people, animals, objects with small surface areas (e.g., tree branches), or transparent objects (e.g., glass or water) along the desired flight path.
- Make sure you use APAS when the Downward Vision System is available or the GNSS signal is strong. APAS may not function properly when the aircraft is flying over water or snow-covered areas.
- Be extra cautious when flying in extremely dark (<300 lux) or bright (>10,000 lux) environments.
- Pay attention to DJI Fly and make sure the aircraft is working normally in APAS mode.
- APAS may not function properly when the aircraft is flying near flight limits or in a GEO zone.

Flight Recorder

Flight data including flight telemetry, aircraft status information, and other parameters are automatically saved to the internal data recorder of the aircraft. The data can be accessed using DJI Assistant 2 (Consumer Drones Series).

Propellers

There are two types of DJI Air 2S Low-Noise Quick Release Propellers, which are designed to spin in different directions. Marks are used to indicate which propellers should be attached to which motors. Make sure to match the propeller and motor following the instructions.

Propellers	Marked	Unmarked
Illustration		
Position	Attach on motors with marks	Attach on motors without marks
Description	 Turn the propellers in the indicated direction to mount and tighten.	

Attaching the Propellers

Attach the propellers with marks to the motors with marks and the unmarked propellers to the motors without marks. Press each propeller down onto the motor and turn until it is secure.

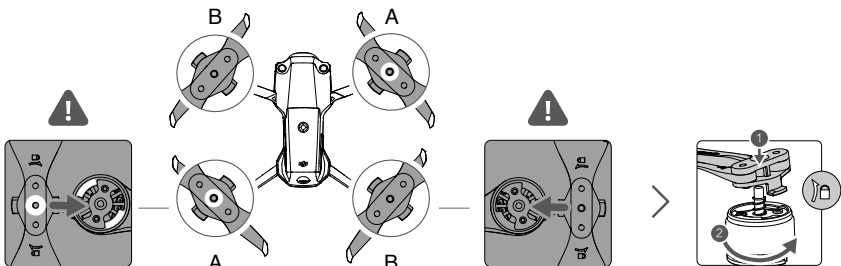

Detaching the Propellers

Press the propellers down onto the motors and rotate them in the unlock direction.



- Propeller blades are sharp. Handle with care.
- Only use official DJI propellers. DO NOT mix propeller types.
- Purchase the propellers separately if necessary.
- Make sure that the propellers are installed securely before each flight.
- Make sure all propellers are in good condition before each flight. DO NOT use aged, chipped, or broken propellers.
- Stay away from the rotating propellers and motors to avoid injuries.
- Do not squeeze or bend the propellers during transportation or storage.
- Make sure the motors are mounted securely and rotating smoothly. Land the aircraft immediately if a motor is stuck and unable to rotate freely.
- DO NOT attempt to modify the structure of the motors.
- DO NOT touch or let your hands or body come in contact with the motors after flight as they may be hot.
- DO NOT block any of the ventilation holes on the motors or the body of the aircraft.
- Make sure the ESCs sound normal when powered on.

Intelligent Flight Battery

The DJI Air 2S Intelligent Flight Battery is a 11.55 V, 3500 mAh battery with smart charging and discharging functionality.

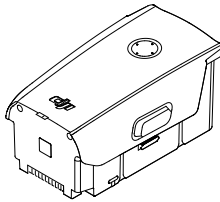

Battery Features

1. **Battery Level Display:** The LED indicators display the current battery level.
2. **Auto-Discharging Function:** To prevent swelling, the battery automatically discharges to 96% of the battery level when it is idle for one day, and automatically discharges to 60% of the battery level when it is idle for five days. It is normal to feel moderate heat being emitted from the battery during the discharging process.
3. **Balanced Charging:** During charging, the voltages of the battery cells are automatically balanced.
4. **Overcharge Protection:** The battery stops charging automatically once fully charged.
5. **Temperature Detection:** In order to protect itself, the battery only charges when the temperature is between 41° and 104° F (5° and 40° C).
6. **Overcurrent Protection:** The battery stops charging if an excess current is detected.
7. **Over-Discharge Protection:** Discharging stops automatically to prevent excess discharge when the battery is not in use. Over-discharge protection is not enabled when the battery is in use.

8. Short Circuit Protection: The power supply is automatically cut if a short circuit is detected.
9. Battery Cell Damage Protection: DJI Fly displays a warning prompt when a damaged battery cell is detected.
10. Hibernation Mode: The battery switches off after 20 minutes of inactivity to save power. If the battery level is less than 5%, the battery enters Hibernation mode to prevent over-discharge after being idle for six hours. In Hibernation mode, the battery level indicators do not illuminate. Charge the battery to wake it from hibernation.
11. Communication: Information about the voltage, capacity, and current of the battery is transmitted to the aircraft.

 • Refer to the DJI Air 2S Disclaimer and Safety Guidelines and the battery sticker before use. Users take full responsibility for all operations and usage.

Using the Battery



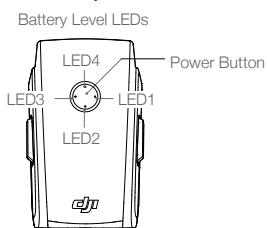

Checking Battery Level

Press the power button once to check the battery level.



Battery Level LEDs

○ : LED is on  : LED is flashing ○ : LED is off

LED1	LED2	LED3	LED4	Battery Level
○	○	○	○	Battery Level ≥ 88%
○	○	○		75% ≤ Battery Level < 88%
○	○	○	○	63% ≤ Battery Level < 75%
○	○		○	50% ≤ Battery Level < 63%
○	○	○	○	38% ≤ Battery Level < 50%
○		○	○	25% ≤ Battery Level < 38%
○	○	○	○	13% ≤ Battery Level < 25%
	○	○	○	0% ≤ Battery Level < 13%

Powering On/Off

Press the power button once, then press again, and hold for two seconds to power the battery on or off. The battery level LEDs display the battery level when the aircraft is powered on.

Low Temperature Notice

1. Battery capacity is significantly reduced when flying in low-temperature environments of 32° to 41° F (0° to 5° C). It is recommended to hover the aircraft in place for a while to heat the battery. Make sure to

fully charge the battery before takeoff.

2. Batteries cannot be used in extremely low-temperature environments of lower than 14° F (-10° C).
3. When in low-temperature environments, end the flight as soon as DJI Fly displays the low battery level warning.
4. To ensure the optimal performance of the battery, keep the battery temperature above 68° F (20° C).
5. The reduced battery capacity in low-temperature environments reduces the wind speed resistance performance of the aircraft. Fly with caution.
6. Fly with extra caution at high sea levels.

Charging the Battery

Fully charge the Intelligent Flight Battery before every flight using the provided DJI charger.

1. Connect the AC power adapter to an AC power supply (100-240 V, 50/60 Hz).
2. Attach the Intelligent Flight Battery to the AC power adapter using the battery charging cable with the battery powered off.
3. The battery level LEDs display the current battery level during charging.
4. The Intelligent Flight Battery is fully charged when all the battery level LEDs are off. Detach the charger when the battery is fully charged.



- ⚠ • DO NOT charge an Intelligent Flight Battery immediately after flight as the temperature may be too high. Wait until it cools down to room temperature before charging again.
- The charger stops charging the battery if the battery cell temperature is not within the operating range of 41° to 104° F (5° to 40° C). The ideal charging temperature is 71.6° to 82.4° F (22° to 28° C).
- The Battery Charging Hub (not included) can charge up to three batteries. Visit the official DJI Online Store for more information.
- Fully charge the battery at least once every three months to maintain battery health.
- DJI does not take any responsibility for damage caused by third-party chargers.

- ☀ • It is recommended to discharge the Intelligent Flight Batteries to 30% or lower before transportation. This can be done by flying the aircraft outdoors until there is less than 30% charge left.

The table below shows the battery level during charging.

LED1	LED2	LED3	LED4	Battery Level
☀	☀	○	○	0% < Battery Level ≤ 50%
☀	☀	☀	○	50% < Battery Level ≤ 75%
☀	☀	☀	☀	75% < Battery Level < 100%
○	○	○	○	Fully Charged

Battery Protection Mechanisms

The battery LED indicator can display battery protection indications triggered by abnormal charging conditions.

Battery Protection Mechanisms					
LED1	LED2	LED3	LED4	Blinking Pattern	Status
○	☀	○	○	LED2 blinks twice per second	Overcurrent detected
○	☀	○	○	LED2 blinks three times per second	Short circuit detected
○	○	☀	○	LED3 blinks twice per second	Overcharge detected
○	○	☀	○	LED3 blinks three times per second	Over-voltage charger detected
○	○	○	☀	LED4 blinks twice per second	Charging temperature is too low
○	○	○	☀	LED4 blinks three times per second	Charging temperature is too high

If the battery protection mechanisms activate, in order to resume charging it is necessary to unplug the battery from the charger and plug it in again. If the charging temperature is abnormal, wait for the charging temperature to return to normal, and the battery will automatically resume charging without requiring to unplug and plug in the charger again.

Inserting the Intelligent Flight Battery

Insert the Intelligent Flight Battery into the battery compartment of the aircraft. Make sure it is mounted securely and that the battery buckles click into place.

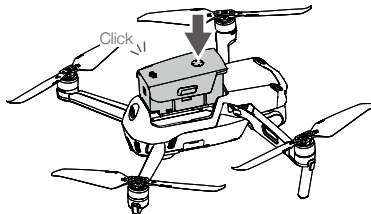

Removing the Intelligent Flight Battery

Press the battery buckles on the sides of the Intelligent Flight Battery to remove it from the compartment.



- DO NOT detach the battery when the aircraft is powering on.
- Make sure that the battery is mounted firmly.

Gimbal and Camera

Gimbal Profile

The 3-axis gimbal of DJI Air 2S provides stabilization for the camera, allowing you to capture clear and stable images and video. The control tilt range is -90° to $+24^{\circ}$. The default control tilt range is -90° to 0° , and the tilt range can be extended to -90° to $+24^{\circ}$ by enabling "Allow Upward Gimbal Rotation" in DJI Fly.

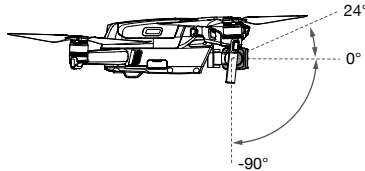

Use the gimbal dial on the remote controller to control the tilt of the camera. Alternatively, enter the camera view in DJI Fly. Press the screen until an adjustment bar appears and drag up and down to control the tilt of the camera.

Gimbal Operation Modes

Two gimbal operation modes are available. Switch between the different operation modes in DJI Fly.

Follow Mode: The angle between the gimbal's orientation and aircraft front remains constant at all times.

FPV Mode: The gimbal synchronizes with the movement of the aircraft to provide a first-person flying experience.



- Do not tap or knock the gimbal when the aircraft is powered on. To protect the gimbal during takeoff, take off from open and flat ground.
 - Precision elements in the gimbal may be damaged in a collision or impact, which may cause the gimbal to function abnormally.
 - Avoid getting dust or sand on the gimbal, especially in the gimbal motors.
 - A gimbal motor may enter protection mode in the following situations:
 - a. The aircraft is on uneven ground or the gimbal is obstructed.
 - b. The gimbal experiences excessive external force, such as during a collision.
 - DO NOT apply external force to the gimbal after the gimbal is powered on. DO NOT add any extra payload to the gimbal as this may cause the gimbal to function abnormally or even lead to permanent motor damage.
 - Make sure to remove the gimbal protector before powering on the aircraft. Also, make sure to mount the gimbal protector when the aircraft is not in use.
 - Flying in heavy fog or clouds may make the gimbal wet, leading to temporary failure. The gimbal recovers full functionality once it is dry.
-

Camera Profile

DJI Air 2S uses a 1-inch CMOS sensor camera, which can shoot 5.4K 30 fps, 4K 60fps, and 1080p 120 fps video and 20MP photos. It also supports shooting modes such as SmartPhoto, Slow Motion, MasterShots, QuickShots, Hyperlapse, and Panorama. The aperture of the camera is f2.8 and can shoot at 0.6 m to infinity.



- Make sure the temperature and humidity is suitable for the camera during usage and storage.
 - Use a lens cleanser to clean the lens to avoid damage.
 - DO NOT block any ventilation holes on the camera as the heat generated may damage the device and hurt the user.
-

Storing Photos and Videos

DJI Air 2S supports the use of a microSD card to store photos and videos. A UHS-I Speed Grade 3 rating microSD card is required due to the fast read and write speeds necessary for high-resolution video data. Refer to the Specifications section for more information about recommended microSD cards.



- Do not remove the microSD card from the aircraft while it is powered on. Otherwise, the microSD card may be damaged.
 - To ensure the stability of the camera system, single video recordings are limited to 30 minutes.
 - Check camera settings before use to ensure they are configured as desired.
 - Before shooting important photos or videos, shoot a few images to test the camera is operating correctly.
 - Photos or videos cannot be transmitted or copied from the camera if the aircraft is powered off.
 - Make sure to power off the aircraft correctly. Otherwise, your camera parameters will not be saved and any recorded videos may be damaged. DJI is not responsible for any failure of an image or video to be recorded or having been recorded in a way that is not machine-readable.
-

Remote Controller

This section describes the features of the remote controller and includes instructions for controlling the aircraft and the camera.

Remote Controller

Remote Controller Profile

Built into the remote controller is DJI's long-range transmission technology OcuSync 2.0, offering a maximum transmission range of 12 km and displaying video from the aircraft to DJI Fly on a mobile device at up to 1080p. The aircraft and camera are easy to control using the onboard buttons and the detachable control sticks make the remote controller easier to store.

In a wide-open area with no electromagnetic interference, the aircraft uses O3 and the remote controller uses OcuSync 2.0 to smoothly transmit video links at up to 1080p, no matter the change in flight attitude. The remote controller works at both 2.4 GHz and 5.8 GHz, automatically selecting the best transmission channel. Transmission system reduces the latency to 120-130 ms by improving the camera performance through its video decoding algorithm and the wireless link.

The built-in battery has a capacity of 5200 mAh and a maximum run time of 6 hours. The remote controller charges the mobile device with a charging ability of 500 mA@5V. The remote controller automatically charges Android devices. For iOS devices, first make sure that charging is enabled in DJI Fly. Charging for iOS devices is disabled by default and needs to be enabled each time the remote controller is powered on.



- Compliance Version: The remote controller is compliant with local regulations.
- Control Stick Mode: The control stick mode determines the function of each control stick movement. Three pre-programmed modes (Mode 1, Mode 2, and Mode 3) are available and custom modes can be configured in DJI Fly. The default mode is Mode 2.

Using the Remote Controller

Powering On/Off

Press the power button once to check the current battery level. Press once, then again, and hold to power the remote controller on or off. If the battery level is too low, recharge before use.

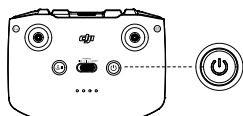

Charging the Battery

Use a USB-C cable to connect an AC power charger to the USB-C port of the remote controller.

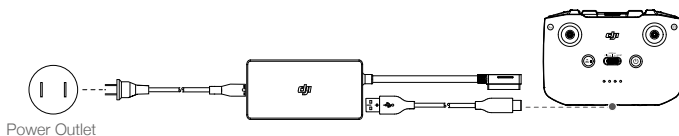

Controlling the Gimbal and Camera

1. Shutter/Record Button: Press once take a photo or to start or stop recording.
2. Photo/Video Toggle: Press once to switch between photo and video mode.
3. Gimbal Dial: Use to control the tilt of the gimbal.
4. Press and hold the customizable button in order to be able to use the gimbal dial to adjust the zoom in video mode.

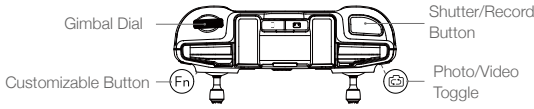

Controlling the Aircraft

The control sticks control the aircraft's orientation (pan), forward/backward movement (pitch), altitude (throttle), and left/right movement (roll). The control stick mode determines the function of each control stick movement. Three preprogrammed modes (Mode 1, Mode 2, and Mode 3) are available and custom modes can be configured in DJI Fly. The default mode is Mode 2.

Mode 1

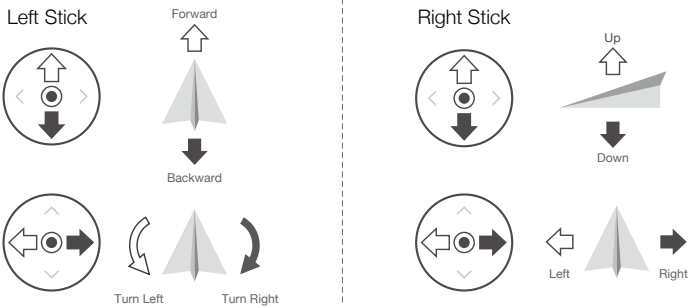



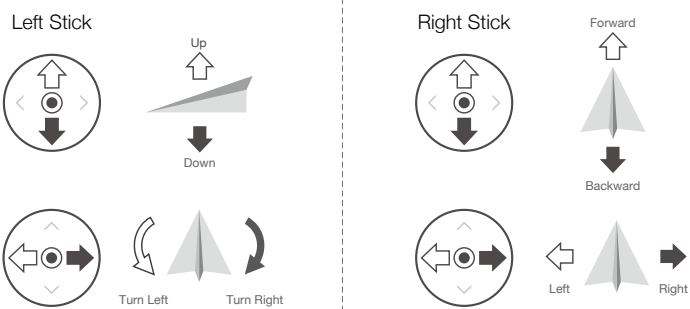

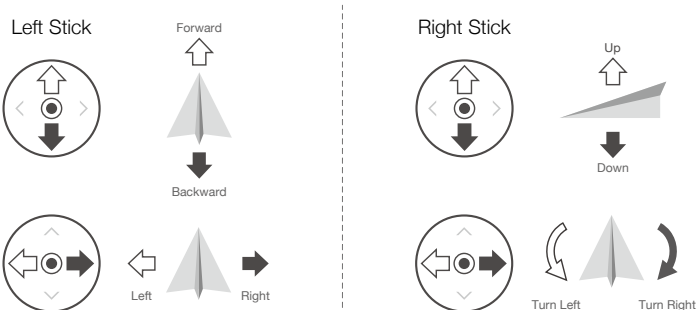

Mode 2

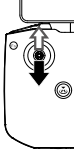

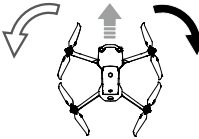
Mode 3



Remote Controller (Mode 2)	Aircraft (← Indicates Nose Direction)	Remarks
		Moving the left stick up or down changes the aircraft's altitude. Push the stick up to ascend and down to descend. The more the stick is pushed away from the center position, the faster the aircraft will change altitude. Push the stick gently to prevent sudden and unexpected changes in altitude.
		Moving the left stick to the left or right controls the orientation of the aircraft. Push the stick left to rotate the aircraft counter-clockwise and right to rotate the aircraft clockwise. The more the stick is pushed away from the center position, the faster the aircraft will rotate.
		Moving the right stick up and down changes the aircraft's pitch. Push the stick up to fly forward and down to fly backward. The more the stick is pushed away from the center position, the faster the aircraft will move.
		Moving the right stick to the left or right changes the aircraft's roll. Push the stick left to fly left and right to fly right. The more the stick is pushed away from the center position, the faster the aircraft will move.

Flight Mode Switch

Toggle the switch to select the flight mode.

Position	Flight Mode
Sport	Sport Mode
Normal	Normal Mode
Cine	Cine Mode

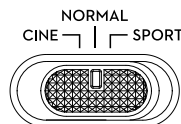

Flight Pause/RTH Button

Press once to make the aircraft brake and hover in place. If the aircraft is performing MasterShots, QuickShots, Smart RTH, or auto landing, press once to exit the procedure and then brake.

Press and hold the RTH button until the remote controller beeps to start RTH. Press this button again to cancel RTH and regain control of the aircraft. Refer to the Return to Home section for more information about RTH.

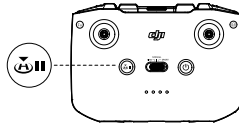

Customizable Button

Go to System Settings in DJI Fly and select Control to customize the function of the button. Functions include recentering the gimbal, switching the auxiliary LED, and toggling the map and live view.

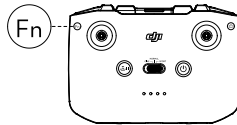

Remote Controller Alert

The remote controller sounds an alert during RTH or when the battery level is low (6% to 15%). The low battery alert level can be cancelled by pressing the power button. The critical battery level alert (less than 5%), however, cannot be cancelled.

Optimal Transmission Zone

The signal between the aircraft and the remote controller is most reliable when the antennas are positioned in relation to the aircraft as depicted below.

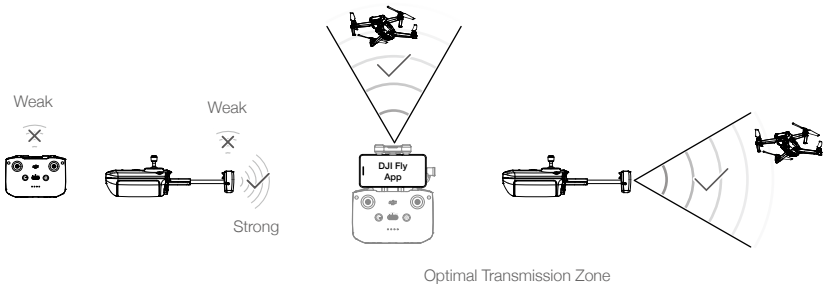

Linking the Remote Controller

The aircraft and remote controller must be linked before using. Follow these steps to link a new remote controller:

1. Power on the remote controller and the aircraft.
2. Launch DJI Fly.
3. In camera view, tap ●●● and select Control and Pair to Aircraft (Link).
4. Press and hold the power button of the aircraft for more than four seconds. The aircraft beeps once indicating it is ready to link. The aircraft beeps twice indicating linking is successful. The battery level LEDs of the remote controller will glow solid.



- Make sure the remote controller is within 0.5 m of the aircraft during linking.
 - The remote controller will automatically unlink from an aircraft if a new remote controller is linked to the same aircraft.
-



- Fully charge the remote controller before each flight. The remote controller sounds an alert when the battery level is low.
 - If the remote controller is powered on and not in use for five minutes, an alert will sound. After 6 minutes, the aircraft automatically powers off. Move the control sticks or press any button to cancel the alert.
 - Adjust the mobile device holder to ensure the mobile device is secure.
 - Fully charge the battery at least once every three months to maintain battery health.
-

DJI Fly App

This section introduces the main functions of the DJI Fly app.

DJI Fly App

Home

Launch DJI Fly and enter the home screen.

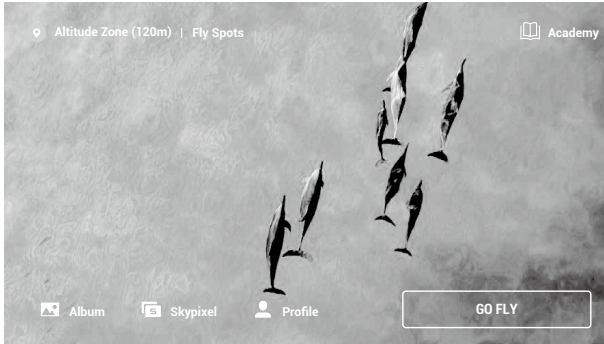

Fly Spots

View or share nearby suitable flight and shooting locations, learn more about GEO zones, and preview aerial photos of different locations taken by other users.

Academy

Tap the icon in the top right corner to enter Academy. Product tutorials, flight tips, flight safety, and manual documents can be viewed here.

Album

Allows you to view photos and videos from DJI Fly and mobile device. Create contains Templates and Pro. Templates provides auto edit feature for imported footage. Pro allows you to edit the footage manually.

SkyPixel

Enter SkyPixel to view videos and photos shared by users.

Profile

View the account information, flight records, DJI forum, online store, Find My Drone feature, and other settings.

Camera View

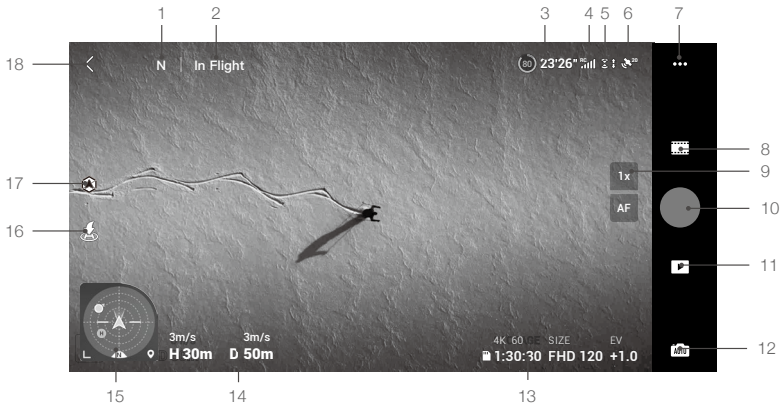

1. Flight Mode

N : Displays the current flight mode.

2. System Status Bar

In Flight : Indicates aircraft flight status and displays various warning messages.

3. Battery Information

(80) 24'26" : Displays the current battery level and remaining flight time. Tap to view more information about the battery.

4. Video Downlink Signal Strength

BC : Displays the video downlink strength between the aircraft and remote controller.

5. Vision Systems Status

: The left side of the icon indicates the status of the Forward and Backward Vision Systems and the right side of the icon indicates the status of the Upward and Downward Vision Systems. The icon is white when the vision system is working normally and red when the vision system is unavailable.

6. GNSS Status

²⁰ : Displays the current GNSS signal strength. Tap to check the GNSS signal status. The Home Point can be updated when the icon is white, which indicates the GNSS signal is strong.

7. System Settings

: Tap to view information about safety, control, and transmission.

Safety

Flight Assistance: The icon appears in the camera view after setting Obstacle Avoidance to Bypass or Brake. The aircraft cannot sense obstacles if Obstacle Avoidance is disabled. The aircraft cannot fly left or right if Sideways Flight is disabled.

Flight Protection: Tap to set the max altitude, max distance, Auto RTH altitude, and to update the Home Point.

Sensors: Tap to view the IMU and compass status and start to calibrate if necessary. Users can also check the auxiliary bottom light and unlock GEO zone settings.

Battery: Tap to view the battery information such as battery cell status, serial number, times charged, and production date.

Auxiliary LED: Tap to set the auxiliary LED to auto, on, or off.

Unlock GEO Zone: Tap to view the information about unlocking GEO zones.

The Find My Drone feature helps to find the location of the aircraft on the ground.

Advanced Safety Settings include the behavior settings of the aircraft when the remote controller signal is lost, when the propellers can be stopped during flight, and the AirSense switch.

The behavior of the aircraft when the remote controller signal is lost can be set to Return to Home, Descend, and Hover.

“Emergency Only” indicates that the motors can only be stopped mid-flight in an emergency situation such as if there is a collision, a motor has stalled, the aircraft is rolling in the air, or the aircraft is out of control and is ascending or descending very quickly. “Anytime” indicates that the motors can be stopped mid-flight anytime once user performs a combination stick command (CSC). Stopping the motors in mid-flight will cause the aircraft to crash.

An alert will appear in DJI Fly when a manned aircraft is detected if AirSense is enabled. AirSense cannot be used while in ActiveTrack or recording at 4K 30p. Read the disclaimer in the DJI Fly prompt before using AirSense.

Control

Aircraft Settings: Units Settings.

Gimbal Settings: Tap to set the gimbal mode, advanced settings, allow gimbal rotation, and perform gimbal calibration.

Remote Controller Settings: Tap to set the function of the customizable button, to calibrate the remote controller, to enable phone charging for the iOS device connected, and to switch stick modes. Make sure to understand the operations of a stick mode before changing stick mode.

Beginner Flight Tutorial: View the flight tutorial.

Connect to Aircraft: Tap to start linking when the aircraft is not linked to the remote controller.

Camera

Camera Parameter Settings: Displays different settings according to the shooting mode.

Shooting Modes	Settings
Photo	Photo Format, Size, and Anti-Flicker
Video	Video Format, Coding Format, Anti-Flicker, and Video Subtitles
MasterShots	Video Format, Coding Format, Shooting Priority, Anti-Flicker, and Video Subtitles
QuickShots	Video Format, Coding Format, Color, Anti-Flicker, and Video Subtitles
Hyperlapse	Video Format, Photo Type, Anti-Flicker, and Shot Frame
Pano	Photo Type and Anti-Flicker

General Settings: Tap to view and set histogram, overexposure warning, gridlines, peaking level, white balance, auto sync HD photos, and cache when recording.

Storage Location: Footage can be stored in the aircraft or on a microSD card. Internal storage and microSD cards can be formatted. The max video cache capacity settings and camera reset settings can also be adjusted.

Transmission

Definition, frequency, and channel mode settings.

About

View device information, firmware information, app version, battery version, and more.

8. Shooting Modes

 **Photo:** Single, SmartPhoto, AEB, Burst, and Timed Shot. SmartPhoto integrates scene recognition, Hyperlight, and HDR into one mode for optimal results. Hyperlight optimizes photos taken at night or in low-light situations while scene recognition optimizes different camera parameters for scenes that feature

sunsets, blue skies, grass, snow, and green trees. HDR uses an adaptive dynamic expansion algorithm that determines optimal parameters to select the best image from multiple layers.

Video: Normal (5.4K 24/25/30fps, 4K 24/25/30/48/50/60fps, 2.7K 24/25/30/48/50/60fps, 1080p 24/25/30/48/50/60/120fps), Slow Motion (1080p 120 fps).

MasterShots: Select a subject. The aircraft will record while executing different maneuvers in sequence and keeping the subject in the center of the frame. A short cinematic video will be generated afterward.

QuickShots: Choose from Dronie, Circle, Helix, Rocket, Boomerang, and Asteroid.

Hyperlapse: Choose from Free, Circle, Course Lock, and Waypoints.

Pano: Choose from Sphere, 180°, Wide Angle, and Vertical. The aircraft automatically takes several photos according to the selected type of Pano and generates a panoramic shot.

9. Zoom/Focus Button

1x : Zoom can be used in video mode. The icon shows the zoom ratio. Press or hold the icon to adjust the zoom ratio.

AF / MF : Press or hold the focus icon to switch the focus mode.

10. Shutter/Record Button

● : Tap to take a photo or to start or stop recording a video.

11. Playback

▶ : Tap to enter playback and preview photos and videos as soon as they are captured.

12. Camera Modes Switch

AUTO : Choose between Auto and Pro mode when in photo mode. Different parameters can be set in different modes.

13. microSD Card Information

4K 30
1:30:26 : Displays the remaining number of photos or video recording time of the current microSD card. Tap to view the available capacity of the microSD card.

14. Flight Telemetry

D 50m H 30m 3m/s 3m/s : Displays the distance between the aircraft and the Home Point, height from the Home Point, aircraft horizontal speed, and aircraft vertical speed.

15. Attitude Indicator

Displays information such as the orientation and tilt angle of the aircraft, position of the remote controller, and position of the Home Point.

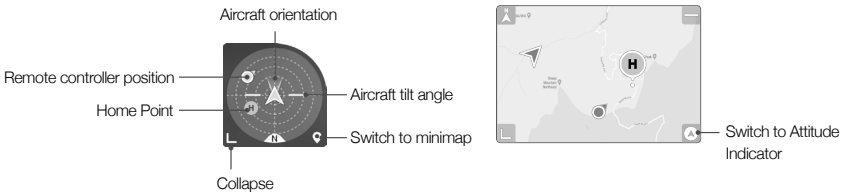

16. Auto Takeoff/Landing/RTH

↑ / ↓ : Tap the icon. When the prompt appears, press and hold the button to initiate auto takeoff or landing.

↻ : Tap to initiate Smart RTH and have the aircraft return to the last recorded Home Point.

17. APAS Status

⬆ : Displays the current APAS status.

18. Back

< : Tap to return to the home screen.

Drag a box around a subject in the camera view to enable FocusTrack. Press and hold on the screen to bring up the gimbal adjustment bar to adjust the gimbal angle.

Tap on the screen to enable focus or spot metering. Focus or spot metering will display differently depending on the focus mode, exposure mode, and spot metering mode. After using spot metering, press and hold on the screen to lock the exposure. To unlock the exposure, press and hold on the screen again.



- Make sure to fully charge your mobile device before launching DJI Fly.
 - Mobile cellular data is required when using DJI Fly. Contact your wireless carrier for data charges.
 - If you are using a mobile phone as your display device, DO NOT accept phone calls or use texting features during flight.
 - Read all safety tips, warning messages, and disclaimers carefully. Familiarize yourself with the related regulations in your area. You are solely responsible for being aware of all relevant regulations and flying in a way that is compliant.
 - a. Read and understand the warning messages before using the auto-take off and auto-landing.
 - b. Read and understand the warning messages and disclaimer before setting the altitude beyond the default limit.
 - c. Read and understand the warning messages and disclaimer before switching between flight modes.
 - d. Read and understand the warning messages and disclaimer prompts near or in GEO zones.
 - e. Read and understand the warning messages before using the Intelligent Flight modes.
 - Land the aircraft immediately in a safe location if prompted to do so in the app.
 - Review all warning messages on the checklist displayed in the app before each flight.
 - Use the in-app tutorial to practice your flight skills if you have never operated the aircraft or if you do not have sufficient experience to operate the aircraft with confidence.
 - Cache the map data of the area where you intend to fly the aircraft by connecting to the internet before each flight.
 - The app is designed to assist your operation. Use your sound discretion and DO NOT rely on the app to control your aircraft. Your use of the app is subject to DJI Fly Terms of Use and DJI Privacy Policy. Read them carefully in the app.
-

Flight

This section describes safe flight practices and flight restrictions.

Flight

Once pre-flight preparation is complete, it is recommended to hone your flight skills and practice flying safely. Make sure that all flights are carried out in an open area. Refer to the Remote Controller and DJI Fly sections for information about using the remote controller and the app to control the aircraft.

Flight Environment Requirements

1. Do not use the aircraft in severe weather conditions including wind speeds exceeding 10.7 m/s, snow, rain, and fog.
2. Only fly in open areas. Tall structures and large metal structures may affect the accuracy of the onboard compass and GNSS system. It is recommended to keep the aircraft at least 5 m away from structures.
3. Avoid obstacles, crowds, high voltage power lines, trees, and bodies of water. It is recommended to keep the aircraft at least 3 m above water.
4. Minimize interference by avoiding areas with high levels of electromagnetism such as locations near power lines, base stations, electrical substations, and broadcasting towers.
5. Aircraft and battery performance is subject to environmental factors such as air density and temperature. Be careful when flying 10,464 ft (5,000 m) or more above sea level, since battery and aircraft performance may be reduced.
6. Aircraft cannot use GNSS within the polar regions. Use the Downward Vision System when flying in such locations.
7. If taking off from a moving surface, such as a moving boat or vehicle, fly with caution.

Flight Limits and GEO Zones

Unmanned aerial vehicle (UAV) operators should abide by the regulations from self-regulatory organizations such as the International Civil Aviation Organization, the Federal Aviation Administration, and local aviation authorities. For safety reasons, flight limits are enabled by default to help users operate this aircraft safely and legally. Users can set flight limits on height and distance.

Altitude limits, distance limits, and GEO zones function concurrently to manage flight safety when GNSS is available. Only altitude can be limited when GNSS is unavailable.

Flight Altitude and Distance Limits

The flight altitude and distance limits can be changed in DJI Fly. Based on these settings, the aircraft will fly in a restricted cylinder, as shown below:

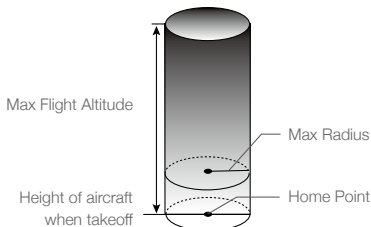

When GNSS is available

	Flight Limits	DJI Fly App
Max Altitude	Aircraft's altitude cannot exceed the specified value	Warning: Height limit reached
Max Radius	Flight distance must be within the max radius	Warning: Distance limit reached

Only Downward Vision System is available

	Flight Limits	DJI Fly App
Max Altitude	Height is restricted to 30 m when the GNSS signal is weak. Height is restricted to 3 m when the GNSS signal is weak and light conditions is not sufficient.	Warning: Height limit reached.
Max Radius	The restrictions on the radius are disabled and warning prompts cannot be received in the app.	



- The altitude limit when the GNSS is weak will not be restricted if there was a strong GNSS signal when the aircraft was powered on.
- If the aircraft reaches a limit, you can still control the aircraft, but you cannot fly it any further. If the aircraft flies out of the max radius, it will automatically fly back within range when the GNSS signal is strong.
- For safety reasons, do not fly close to airports, highways, railway stations, railway lines, city centers, or other sensitive areas. Fly the aircraft only within your line of sight.

GEO Zones

All GEO zones are listed on the DJI official website at <http://www.dji.com/flysafe>. GEO zones are divided into different categories and include locations such as airports, flying fields where manned aircraft operate at low altitudes, borders between countries, and sensitive locations such as power plants.

There will be prompts in the DJI Fly app to fly in GEO zones.

Pre-Flight Checklist

1. Make sure the remote controller, mobile device, and Intelligent Flight Battery are fully charged.
2. Make sure the Intelligent Flight Battery and the propellers are mounted securely.
3. Make sure the aircraft arms are unfolded.
4. Make sure the gimbal and camera are functioning normally.
5. Make sure that there is nothing obstructing the motors and that they are functioning normally.
6. Make sure that DJI Fly is successfully connected to the aircraft.
7. Make sure that the camera lens and Vision System sensors are clean.
8. Use only genuine DJI parts or parts certified by DJI. Unauthorized parts or parts from non-DJI certified manufacturers may cause system malfunctions and compromise safety.

Auto Takeoff/Landing



Auto Takeoff

Use auto takeoff when the aircraft status indicator blinks green.

1. Launch DJI Fly and enter the camera view.
2. Complete all steps in the pre-flight checklist.
3. Tap . If conditions are safe for takeoff, press and hold the button to confirm.
4. The aircraft will take off and hover 1.2 m above the ground.

Auto Landing

Use auto landing:

1. Tap . If conditions are safe to land, press and hold the button to confirm.
2. Auto landing can be cancelled by tapping .
3. If the Vision System is working normally, Landing Protection will be enabled.
4. Motors stops after landing.

Starting/Stopping the Motors

Starting the Motors

A Combination Stick Command (CSC) is used to start the motors. Push both sticks to the bottom inner or outer corners to start the motors. Once the motors have started spinning, release both sticks simultaneously.



Stopping the Motors

There are two methods to stop the motors.

1. Method 1: When the aircraft has landed, push and hold the left stick down. The motors will stop after three seconds.
2. Method 2: When the aircraft has landed, push the left stick down and perform the same CSC that was used to start the motors. The motors will stop immediately. Release both sticks once the motors have stopped.

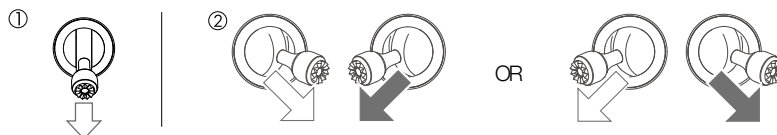

Method 1

Method 2

Stopping the Motors Mid-Flight

Stopping motors mid-flight will cause the aircraft to crash. The motors should only be stopped mid-flight in an emergency situation such as if a collision has occurred or if the aircraft is out of control and is ascending or descending very quickly, rolling in the air, or if a motor has stalled. To stop the motors mid-flight use the same CSC that was used to start the motors. The default setting can be changed in DJI Fly.

Flight Test

Takeoff/Landing Procedures

1. Place the aircraft in an open, flat area with the aircraft status indicator facing towards you.
2. Turn on the aircraft and the remote controller.
3. Launch DJI Fly and enter the camera view.
4. Wait until the aircraft status indicators blink green indicating that the Home Point has been recorded and it is now safe to fly.
5. Gently push the throttle stick to take off or use auto-takeoff.
6. Pull the throttle stick or use auto-landing to land the aircraft.
7. After landing, push the throttle stick down and hold. The motors stop after three seconds.
8. Turn off the aircraft and remote controller.

Video Suggestions and Tips

1. The pre-flight checklist is designed to help you fly safely and to ensure that you can shoot video during flight. Go through the full pre-flight checklist before each flight.
2. Select the desired gimbal operation mode in DJI Fly.
3. Use Normal or Cine mode to record video.
4. DO NOT fly in bad weather conditions such as when it is raining or windy.
5. Choose the camera settings that best suit your needs.
6. Perform flight tests to establish flight routes and to preview scenes.



- Make sure to place the aircraft on a flat and steady surface before takeoff. DO NOT takeoff from your palm or while holding the aircraft with your hand.



It is important to understand the basic flight guidelines for the safety of both you and those around you.

DO NOT forget to read the disclaimer and safety guidelines.

Appendix

Appendix

Specifications

Aircraft	
Takeoff Weight	595 g
Dimensions (LxWxH)	Folded: 180x97x77 mm Unfolded: 183x253x77 mm
Diagonal Distance	302 mm
Max Ascent Speed	6 m/s (S Mode) 6 m/s (N Mode)
Max Descent Speed	6 m/s (S Mode) 6 m/s (N Mode)
Max Speed (near sea level, no wind)	19 m/s (S Mode) 15 m/s (N Mode) 5 m/s (C Mode)
Max Service Ceiling Above Sea Level	5,000 m
Max Flight Time	31 min (measured while flying at 19.4 kph in windless conditions)
Max Hover Time (without wind)	30 min
Max Flight Distance	18.5 km
Max Wind Speed Resistance	10.7 m/s (Scale 5)
Max Tilt Angle	35° (S Mode) Front: 30°, Back: 20°, Left: 35°, Right: 35° (N Mode)
Max Angular Velocity	250°/s (S Mode) 90°/s (N Mode) 60°/s (C Mode)
Operating Temperature	32° to 104° F (0° to 40° C)
GNSS	GPS+GLONASS+GALILEO
Operating Frequency	2.400-2.4835 GHz, 5.725-5.850 GHz
Transmitter Power (EIRP)	2.400-2.4835 GHz: < 30 dBm (FCC), < 20 dBm (CE/SRRC/MIC) 5.725-5.850 GHz: < 30 dBm (FCC), < 14 dBm (CE), < 29 dBm (SRRC)
Hovering Accuracy Range	Vertical: ±0.1 m (with Vision Positioning), ±0.5 m (with GNSS Positioning) Horizontal: ±0.1 m (with Vision Positioning), ±1.5 m (with GNSS Positioning)
Internal Storage	8 GB (7.2 GB of available storage)
Gimbal	
Mechanical Range	Tilt: -135° to +45° Roll: -45° to +45° Pan: -100° to +100°
Controllable Range	Tilt: -90° to 0° (default setting), -90° to +24° (extended setting)
Stabilization	3-axis (tilt, roll, pan)
Max Control Speed (tilt)	100°/s
Angular Vibration Range	±0.01°

Sensing System	
Forward	Precision Measurement Range: 0.38-23.8 m Effective Sensing Speed: ≤ 15 m/s FOV: 72° (horizontal), 58° (vertical)
Backward	Precision Measurement Range: 0.37-23.4 m Effective Sensing Speed: ≤ 12 m/s FOV: 57° (horizontal), 44° (vertical)
Upward	Precision Measurement Range: 0.34-28.6 m Effective Sensing Speed: ≤ 12 m/s FOV: 63° (horizontal), 78° (vertical)
Downward	Infrared Sensor Measurement Range: 0.1-8 m Hovering Range: 0.5-30 m Vision Sensor Hovering Range: 0.5-60 m
Operating Environment	Non-reflective, discernible surfaces with diffuse reflectivity of $>20\%$; Adequate lighting of lux >15
Camera	
Sensor	1-inch CMOS Effective Pixels: 20MP
Lens	FOV: 88° 35 mm Format Equivalent: 22 mm Aperture: f/2.8 Shooting Range: 0.6 m to ∞
ISO	Video: 100-3200 (Auto), 100-6400 (Manual) Video-10bit: 100-800 (Auto), 100-1600 (Manual) Photo: 100-3200 (Auto), 100-12800 (Manual)
Electronic Shutter Speed	1/8000-8 s
Max Image Size	20MP (5472×3648, 3:2; 5472×3078, 16:9)
Still Photography Modes	Single: 20MP Burst: 20MP Automatic Exposure Bracketing (AEB): 20MP, 3/5 Frames at 0.7EV Step Timed: 20MP 2/3/5/7/10/15/20/30/60 seconds SmartPhoto: 20MP HDR Panorama: Vertical (3×1): approx. 3328×8000 pixels (W×H) Wide (3×3): approx. 8000×6144 pixels (W×H) 180° Panorama (3×7): approx. 8192×3500 pixels (W×H) Sphere (3×8+1): approx. 8192×4096 pixels (W×H)
Video Resolution	5.4K: 5472×3078 24/25/30fps 4K Ultra HD: 3840×2160 24/25/30/48/50/60fps 2.7K: 2688×1512 24/25/30/48/50/60fps FHD: 1920×1080 24/25/30/48/50/60/120fps
Max Video Bitrate	150 Mbps
Supported File System	FAT32 exFAT (recommend)
Photo Format	JPEG/DNG (RAW)
Video Format	MP4/MOV (H.264/MPEG-4 AVC, H.265/HEVC)

Digital Zoom	4K 24/25/30fps – 4x 2.7K 24/25/30fps – 6x 1080p 24/25/30fps – 8x 2.7K 48/50/60fps – 4x 1080p 48/50/60fps – 6x Note: Digital zoom is not available when recording in D-Log M, HLG, or slow motion at 120fps.
--------------	--

Remote Controller

Operating Frequency	2.400-2.4835 GHz, 5.725-5.850 GHz
Remote Controller Transmission System	OcuSync 2.0
Max Transmission Distance (unobstructed, free of interference)	12 km (FCC) 8 km (CE/SRRC/MIC)
Operating Temperature	32° to 104° F (0° to 40° C)
Transmitter Power (EIRP)	2.400-2.4835 GHz: < 26 dBm (FCC), < 20 dBm (CE/SRRC/MIC) 5.725-5.850 GHz: < 26 dBm (FCC/SRRC), < 14 dBm (CE)
Battery Capacity	5200 mAh
Operating Current/Voltage	1200 mA@3.6 V (with Android device) 700 mA@3.6 V (with iOS device)

Max Supported Mobile Device Size (H×W×T)	180×86×10 mm
Supported USB Port Types	Lightning, Micro USB (Type-B), USB-C

Video Transmission System

Video Transmission System	O3
Live View Quality	1080p@30fps
Max Transmission Distance (unobstructed, free of interference)	12 km (FCC) 8 km (CE/SRRC/MIC)
Video Coding Format	H.265/H.264
Max Bitrate	16 Mbps
Latency (depending on environmental conditions and mobile device)	120-130 ms

Charger

Input	100-240V, 50/60 Hz, 1.3 A
Output	Battery: 13.2 V = 2.82 A USB: 5V/2A
Rated Power	38 W

Intelligent Flight Battery

Battery Capacity	3500 mAh
Voltage	11.55 V
Max Charging Voltage	13.2 V
Battery Type	LiPo 3S
Energy	40.42 Wh
Weight	198 g

Charging Temperature	41° to 104° F (5° to 40° C)
Max Charging Power	38 W
App	
App	DJI Fly
Required Operating System	iOS v11.0 or later; Android v6.0 or later
SD Cards	
Supported SD Cards	UHS-I Speed Grade 3 rating microSD card
Recommended microSD Cards	SanDisk Extreme PRO 64GB V30 A2 microSDXC SanDisk High Endurance 64GB V30 microSDXC SanDisk Extreme 64GB V30 A2 microSDXC SanDisk Extreme 128GB V30 A2 microSDXC SanDisk Extreme 256GB V30 A2 microSDXC Lexar 667x 64GB V30 A2 microSDXC Lexar High-Endurance 64GB V30 microSDXC Samsung EVO 64GB microSDXC Samsung EVO Plus 64GB microSDXC Samsung EVO Plus 256GB microSDXC Kingston 128GB V30 microSDXC Netac 256GB A1 microSDXC

Firmware Update

Use DJI Fly or DJI Assistant 2 (Consumer Drones Series) to update the aircraft firmware.

Using DJI Fly

When you connect the aircraft or remote controller to DJI Fly, you will be notified if a new firmware update is available. To start updating, connect your mobile device to the internet and follow the on-screen instructions. Note that you cannot update the firmware if the remote controller is not linked to the aircraft. Internet is required.

Using DJI Assistant 2 (Consumer Drones Series)

Update the aircraft and remote controller firmware separately using DJI Assistant 2 (Consumer Drones Series). Follow the instructions below to update the aircraft firmware through DJI Assistant 2 (Consumer Drones Series):

1. Launch DJI Assistant 2 (Consumer Drones Series) and log in with your DJI account.
2. Power on the aircraft and connect the aircraft to a computer via the USB-C port.

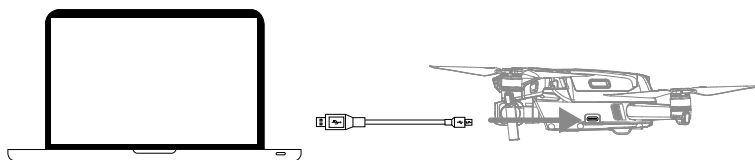

3. Select DJI Air 2S and click on Firmware Updates on the left panel.
4. Select the firmware version that you wish to update to.

5. Wait for the firmware to download. The firmware update will start automatically.
6. The aircraft will reboot automatically after the firmware update is complete.

Follow the instructions below to update the remote controller firmware through DJI Assistant 2 (Consumer Drones Series):

1. Launch DJI Assistant 2 (Consumer Drones Series) and log in with your DJI account.
2. Power on the remote controller and connect to a computer via the USB-C port using a Micro USB cable.

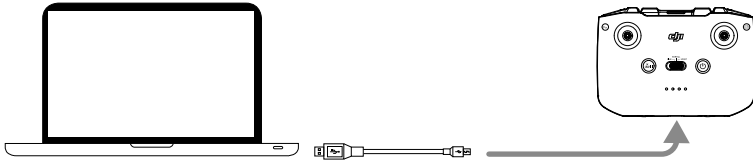

3. Select DJI Air 2S Remote Controller and click on Firmware Updates on the left panel.
4. Select the firmware version that you wish to update to.
5. Wait for the firmware to download. The firmware update will start automatically.
6. Wait for the firmware update to be completed.



- Make sure follow all the steps to update firmware. Otherwise, the update may fail.
- The firmware update will take approximately 10 minutes. It is normal that the gimbal goes limp, aircraft status indicators blink, and the aircraft reboots. Wait patiently until the update is complete.
- Make sure the computer has access to the internet.
- Before performing an update, make sure the Intelligent Flight Battery is at least 40% charged and the remote controller is at least 30% charged.
- Do not disconnect the aircraft from the computer during an update.

After-Sales Information

Visit <https://www.dji.com/support> to learn more about after-sales service policies, repair services, and support.

FAR Remote ID Compliance Information

The aircraft complies with the requirements of 14 CFR Part 89:

- The aircraft automatically broadcasts Remote ID messages from takeoff to shut down. An external device such as a cell phone or tablet is required to be connected as a location source to DJI mobile devices without an integrated GNSS system ^[1], and must run the DJI flight control app such as DJI Fly in the foreground and always allow the DJI flight control app to obtain its accurate location information. The connected external device must minimally be one of the following:
 - 1) FCC Certified personal wireless device that uses GPS with SBAS (WAAS) for location services; or
 - 2) FCC Certified personal wireless device with integrated GNSS.Also, the external device must be operated in a way that does not interfere with the location reported and its correlation to the operator location.
- The aircraft automatically initiates a pre-flight self-test (PFST) of the Remote ID system before takeoff and cannot take off if it does not pass the PFST ^[2]. The results of the PFST of the Remote ID system can be viewed in either a DJI flight control app such as DJI Fly or DJI goggles.
- The aircraft monitors the Remote ID system functionality from pre-flight to shut down. If the Remote ID system malfunctions or has a failure, an alarm will be displayed in either a DJI flight control app such as DJI Fly or DJI goggles.

Footnotes

1. DJI mobile devices without an integrated GNSS system such as DJI RC-N1, DJI FPV Goggles V2, and DJI Goggles 2.
2. The pass criterion for PFST is that the hardware and software of the Remote ID required-data source and transmitter radio in the Remote ID system are functioning properly.

DJI Support
<http://www.dji.com/support>

This content is subject to change.

Download the latest version from
<http://www.dji.com/air-2s>

If you have any questions about this document, please contact
DJI by sending a message to **DocSupport@dji.com**.

DJI is a trademark of DJI.

Copyright © 2022 DJI All Rights Reserved.