



Questo manuale d'istruzione è fornito da trovaprezzi.it. Scopri tutte le offerte per [Epson WorkForce WF-2960DWF](#) o cerca il tuo prodotto tra le [migliori offerte di Stampanti e scanner](#)



Questo manuale d'istruzione è fornito da trovaprezzi.it. Scopri tutte le offerte per [Epson WorkForce WF-2960DWF](#) o cerca il tuo prodotto tra le [migliori offerte di Stampanti](#)

EPSON[®]
EXCEED YOUR VISION

WF-2960 User's Guide

Contents

WF-2960 User's Guide	13
Product Basics	14
Product Parts Locations	14
Product Parts - Front and Top	15
Product Parts - Inside	17
Product Parts - Back.....	18
Using the Control Panel	18
Control Panel Buttons and Lights	19
The LCD Screen.....	20
Status Icon Information.....	20
Navigating the LCD Screen	21
Entering Characters on the LCD Screen	22
Viewing Animations	23
Changing LCD Screen Language.....	23
Selecting the Date and Time	23
Adjusting Control Panel Sounds	25
Turning Off the Operation Time Out Setting	25
Preventing PC Connection via USB	25
Using Power Saving Settings	26
Changing the Sleep Timer Settings.....	26
Changing the Power Off Timer Settings	26
Using the Epson Smart Panel Mobile App.....	26
Voice-activated Printing	27
Epson Connect Solutions for Smartphones, Tablets, and More	28
Setting Up Epson Connect Services.....	28
Using Epson Email Print	29
Using Epson Remote Print	29
Using Epson Scan to Cloud.....	30
Using AirPrint	31
Setting Up Printing on a Chromebook	32

Android Printing Using the Epson Print Enabler	32
Using Epson Print and Scan App with Windows Tablets	32
Using the Mopria Print Service	33
Wi-Fi or Wired Networking.....	34
Network Security Recommendations	34
Wi-Fi Infrastructure Mode Setup.....	35
Selecting Wireless Network Settings from the Control Panel	36
Wi-Fi Direct Mode Setup	38
Enabling Wi-Fi Direct (Simple AP) Mode	39
Wi-Fi Protected Setup (WPS).....	40
Using WPS to Connect to a Network	40
Printing a Network Status Sheet.....	41
Printing a Network Connection Report	41
Network Connection Report Codes and Messages	43
Changing or Updating Network Connections	48
Accessing the Web Config Utility	48
Changing a USB Connection to a Wi-Fi Connection.....	49
Changing a Wi-Fi Connection to a Wired Network Connection.....	49
Connecting to a New Wi-Fi Router	50
Disabling Wi-Fi Features	51
Disabling Wi-Fi Direct (Simple AP) Mode	51
Loading Paper	53
Loading Paper in the Cassette	53
Paper Loading Capacity	60
Double-sided Printing Capacity	61
Borderless Paper Type Compatibility	63
Compatible Epson Papers.....	64
Paper or Media Type Settings - Printing Software.....	66
Selecting the Paper Settings - Control Panel	67
Paper Type Settings - Control Panel	67
Selecting the Default Paper Source Settings.....	68
Paper Source Settings Options	68
Selecting the Universal Print Settings	69

Universal Print Settings Options	70
Placing Originals on the Product	71
Placing Originals on the Scanner Glass	71
Placing Originals in the Automatic Document Feeder	73
ADF Original Document Specifications.....	76
Copying	78
Copying Documents or Photos.....	78
Copying ID Cards or Borderless Photos.....	79
Copying Options.....	79
Printing from a Computer	82
Printing with Windows	82
Selecting Basic Print Settings - Windows	83
Print Quality Options - Windows	85
Multi-Page Printing Options - Windows.....	85
Selecting Double-sided Printing Settings - Windows	86
Double-sided Printing Options - Windows.....	88
Print Density Adjustments - Windows	88
Selecting Additional Layout and Print Options - Windows	89
Custom Color Correction Options - Windows.....	91
Image Options and Additional Settings - Windows.....	92
Header/Footer Settings - Windows	93
Selecting a Printing Preset - Windows.....	94
Selecting Extended Settings - Windows	95
Extended Settings - Windows	97
Printing Your Document or Photo - Windows.....	98
Checking Print Status - Windows.....	100
Locking Printer Settings - Windows	100
Locked Setting Options.....	102
Selecting Default Print Settings - Windows.....	103
Changing the Language of the Printer Software Screens	104
Changing Automatic Update Options	105
Printing with the Built-in Epson Driver - Windows 10 S.....	106
Selecting Print Settings - Windows 10 S.....	107

Printing on a Mac	110
Selecting Basic Print Settings - Mac	111
Print Quality Options - Mac	115
Print Options - Mac	115
Selecting Page Setup Settings - Mac	116
Selecting Print Layout Options - Mac.....	117
Selecting Double-sided Printing Settings - Mac.....	117
Double-sided Printing Options and Adjustments - Mac.....	119
Managing Color - Mac	119
Color Matching and Color Options - Mac	120
Selecting Printing Preferences - Mac	121
Printing Preferences - Mac.....	122
Printing Your Document or Photo - Mac	123
Checking Print Status - Mac.....	124
Printing from a Smartphone or Tablet.....	125
Printing with Epson Photo+	125
Cancelling Printing Using a Product Button.....	125
Scanning	126
Starting a Scan.....	126
Starting a Scan Using the Product Control Panel	126
Scanning to a Connected Computer	127
Scanning to the Cloud.....	128
Setting Up a WSD Port (Windows 7/Windows Vista)	129
Control Panel Scanning Options	130
Starting a Scan Using Epson ScanSmart	131
Starting a Scan Using the Epson Scan 2 Icon	132
Starting a Scan from a Scanning Program.....	135
Starting a Scan from a Smartphone or Tablet.....	137
Scanning a Document in Epson ScanSmart.....	137
Saving a Scan	140
Attaching a Scan to Email.....	141
Sending a Scan to a Cloud Service	142
Printing a Scan	143

Selecting Epson ScanSmart Settings.....	145
Changing the Epson Product.....	145
Changing the Scan Settings	146
Changing the File Name Settings	148
Changing the Save Settings	149
Save Settings.....	151
Customizing Action Icons	153
Scanning in Epson Scan 2	154
Additional Scanning Settings - Main Settings Tab	157
Additional Scanning Settings - Advanced Settings Tab	158
Saving Scanned Documents as a Searchable PDF Using Epson Scan 2	159
Image Format Options	160
Scan Resolution Guidelines	161
Faxing.....	163
Connecting a Telephone or Answering Machine	163
Setting Up Fax Features	166
Setting Up Basic Fax Features	167
Using the Fax Setup Wizard	167
Selecting the Line Type.....	169
Setting the Number of Rings to Answer	169
Selecting Advanced Fax Settings	170
Basic Settings - Fax	171
Receive Settings - Fax	173
Report Settings - Fax	174
Security Settings - Fax	175
Setting Up the Fax Utility - Windows.....	175
Setting Up Fax Features Using the Fax Utility - Mac	177
Setting Up Contacts and Contact Groups.....	178
Setting Up Contacts Using the Product Control Panel	179
Creating a Contact or Group	179
Editing or Deleting a Contact or Group.....	179
Sending Faxes	180
Sending Faxes from the Product Control Panel.....	180

Sending a Fax Using the Keypad, Contact List, or History	181
Fax Sending Options	183
Sending a Fax at a Specified Time	184
Dialing Fax Numbers from a Connected Telephone	185
Sending Faxes Using the Fax Utility - Windows	186
Sending Faxes Using the Fax Utility - Mac	188
Receiving Faxes.....	191
Fax Reception	191
Receiving Faxes Automatically	192
Receiving Faxes Manually.....	192
Receiving a Fax by Polling	193
Saving and Viewing Received Faxes	193
Checking Fax Status	194
Printing Fax Reports.....	195
Fax Report Options	195
Replacing Ink Cartridges and Maintenance Boxes.....	196
Ink Safety Precautions	196
Check Cartridge and Maintenance Box Status.....	198
Checking Cartridge and Maintenance Box Status on the LCD Screen	199
Checking Cartridge and Maintenance Box Status - Windows.....	199
Checking Cartridge and Maintenance Box Status - Mac	202
Purchase Epson Ink Cartridges and Maintenance Box	204
Ink Cartridge and Maintenance Box Part Numbers.....	204
Removing and Installing Ink Cartridges.....	205
Printing with Black Ink and Expended Color Cartridges	211
Printing with Expended Color Cartridges - Control Panel	211
Printing with Expended Color Cartridges - Windows	211
Printing with Expended Color Cartridges - Mac	212
Conserving Low Black Ink with Windows	214
Maintenance Box Replacement	214
Adjusting Print Quality.....	216
Print Head Maintenance.....	216
Print Head Nozzle Check.....	217

Checking the Nozzles Using the Product Control Panel	217
Checking the Nozzles Using a Computer Utility	218
Print Head Cleaning	221
Cleaning the Print Head Using the Product Control Panel	221
Cleaning the Print Head Using a Computer Utility	223
Power Cleaning	227
Power Cleaning Using the Product Control Panel	227
Power Cleaning Using a Computer Utility	228
Print Head Alignment	230
Aligning the Print Head Using the Product Control Panel	230
Cleaning the Paper Guide	231
Cleaning and Transporting Your Product	234
Cleaning Your Product	234
Cleaning the Paper Rollers	238
Cleaning the Print Head Path	240
Transporting Your Product	243
Solving Problems	247
Checking for Software Updates	247
Product Status Messages	248
Running a Product Check	251
Resetting Control Panel Defaults	252
Solving Setup Problems	252
Product Does Not Turn On or Off	252
Noise After Ink Installation	253
Software Installation Problems	253
Solving Network Problems	254
Product Cannot Connect to a Wireless Router or Access Point	254
Network Software Cannot Find Product on a Network	256
Product Does Not Appear in Mac Printer Window	257
Wireless Network Connection is Unstable on a Mac	258
Cannot Print Over a Network	258
Cannot Scan Over a Network	259
Solving Copying Problems	260

Product Makes Noise, But Nothing Copies	260
Product Makes Noise When It Sits for a While.....	261
Originals Do Not Feed From the Automatic Document Feeder.....	261
Copies Have Incorrect or Faint Colors.....	261
Position, Size, or Margins of Copies are Incorrect	262
Solving Paper Problems	262
Paper Feeding Problems	263
Paper Jam Problems Inside the Product	263
Paper Jam Problems in the Rear Cover	266
Document Jams in the Automatic Document Feeder	268
Paper Ejection Problems	272
Solving Problems Printing from a Computer.....	272
Nothing Prints	273
Product Icon Does Not Appear in Windows Taskbar	274
Printing is Slow	275
Solving Page Layout and Content Problems	277
Inverted Image.....	277
Too Many Copies Print	278
Blank Pages Print	278
Incorrect Margins on Printout.....	279
Border Appears on Borderless Prints	279
Incorrect Characters Print.....	280
Incorrect Image Size or Position	281
Slanted Printout.....	281
Solving Print Quality Problems	282
White or Dark Lines in Printout	282
Blurry or Smearred Printout	283
Faint Printout or Printout Has Gaps	285
Grainy Printout.....	286
Incorrect Colors	287
Solving Scanning Problems	288
Scanning Software Does Not Operate Correctly	288
Cannot Start Epson Scan 2	289

Scanning is Slow	290
Cannot Save a Scan to a Shared Folder Over a Network	291
Solving Scanned Image Quality Problems	292
Scanned Image Quality Problems	293
Image Consists of a Few Dots Only	294
Line of Dots Appears in All Scanned Images	295
Straight Lines in an Image Appear Crooked	295
Characters are Not Recognized During Conversion to Editable Text (OCR)	295
Image Colors are Patchy at the Edges	296
Ripple Patterns Appear in an Image	296
Scanned Image Edges are Cropped	297
Resetting the Epson Scan 2 Settings	297
Solving Faxing Problems	297
Cannot Send or Receive Faxes	298
Cannot Receive Faxes with a Telephone Connected to Your Product	301
Fax Memory Full Error Appears	301
Fax Quality is Poor	302
Sent Fax is Received in an Incorrect Size	302
Received Fax is Not Printed	303
Uninstall Your Product Software	303
Uninstalling Product Software - Windows	303
Uninstalling Product Software - Mac	305
Where to Get Help	305
Technical Specifications	307
Windows System Requirements	307
Mac System Requirements	308
Paper Specifications	309
Printable Area Specifications	310
Automatic Document Feeder (ADF) Specifications	312
Scanning Specifications	312
Fax Specifications	313
Ink Cartridge Specifications	314
Dimension Specifications	315

Electrical Specifications	315
Environmental Specifications	316
Interface Specifications	316
Network Interface Specifications	316
Safety and Approvals Specifications	318
Notices	320
Important Safety Instructions.....	320
General Product Safety Instructions	320
LCD Screen Safety Instructions.....	322
Wireless Connection Safety Instructions	323
Telephone Equipment Safety Instructions	323
Important Privacy Notice (Printer Serial Number).....	323
FCC Compliance Statement.....	324
Binding Arbitration and Class Waiver	326
Trademarks	330
Copyright Notice.....	330
libTIFF Software Acknowledgment.....	331
A Note Concerning Responsible Use of Copyrighted Materials.....	331
Default Delay Times for Power Management for Epson Products	332
Copyright Attribution	332

WF-2960 User's Guide

Welcome to the *WF-2960 User's Guide*.

For a printable PDF copy of this guide, click [here](#).

Product Basics

See these sections to learn about the basic features of your product.

[Product Parts Locations](#)

[Using the Control Panel](#)

[Using Power Saving Settings](#)

[Using the Epson Smart Panel Mobile App](#)

[Voice-activated Printing](#)

[Epson Connect Solutions for Smartphones, Tablets, and More](#)

[Using AirPrint](#)

[Setting Up Printing on a Chromebook](#)

[Android Printing Using the Epson Print Enabler](#)

[Using Epson Print and Scan App with Windows Tablets](#)

[Using the Mopria Print Service](#)

Product Parts Locations

See these sections to identify the parts on your product.

[Product Parts - Front and Top](#)

[Product Parts - Inside](#)

[Product Parts - Back](#)

Parent topic: [Product Basics](#)

Product Parts - Front and Top

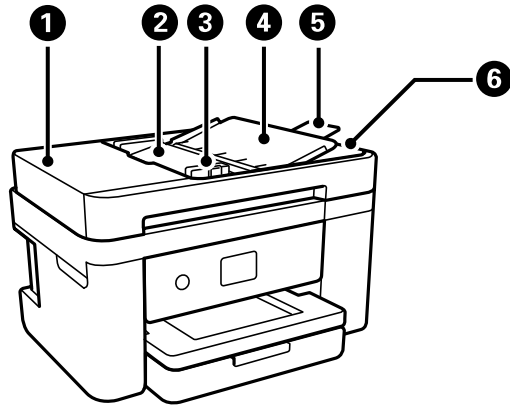

- 1 Automatic Document Feeder (ADF) cover
- 2 ADF input tray
- 3 ADF edge guide
- 4 ADF document support
- 5 ADF output tray extension

6 ADF output tray

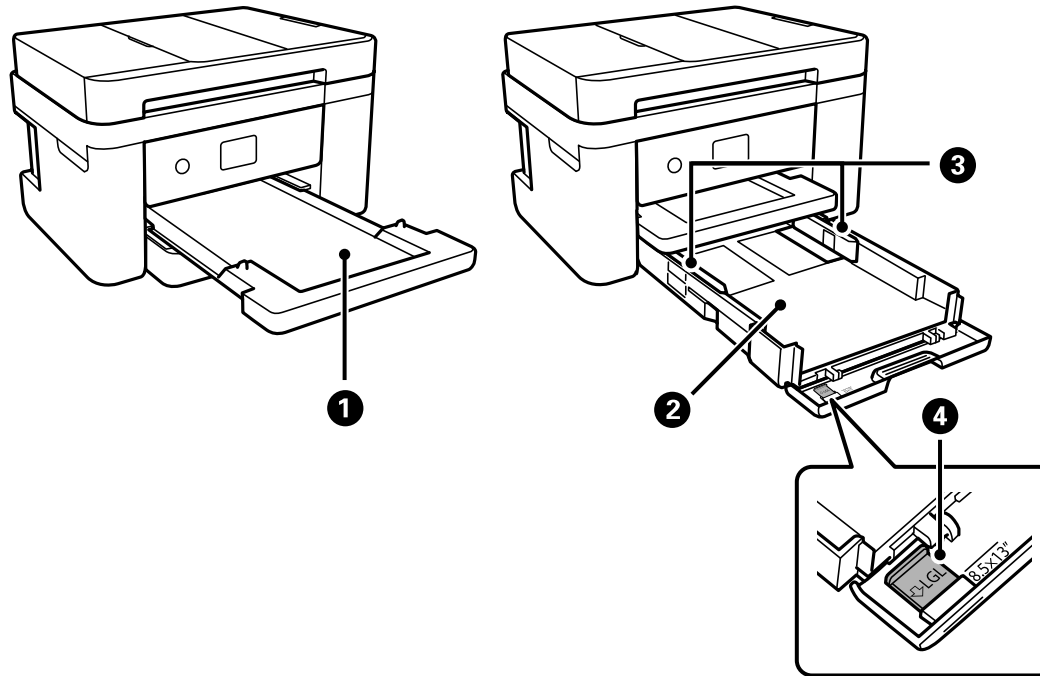

- 1 Output tray
- 2 Paper cassette
- 3 Paper cassette edge guides
- 4 Legal-size paper guide

Parent topic: [Product Parts Locations](#)

Product Parts - Inside

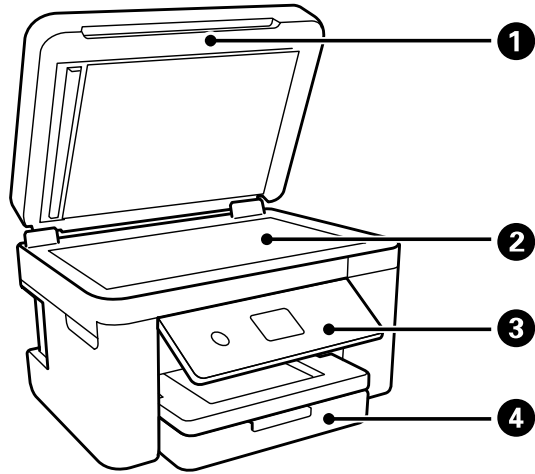

- 1 Document cover
- 2 Scanner glass
- 3 Control panel
- 4 Front cover

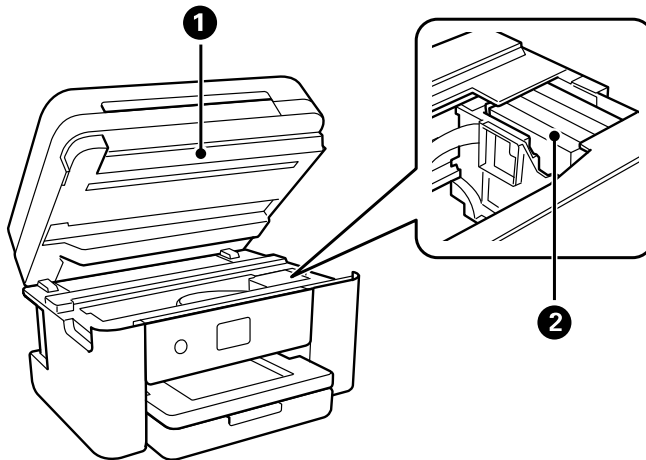

- 1 Scanner unit
- 2 Ink cartridge holder

Parent topic: [Product Parts Locations](#)

Product Parts - Back

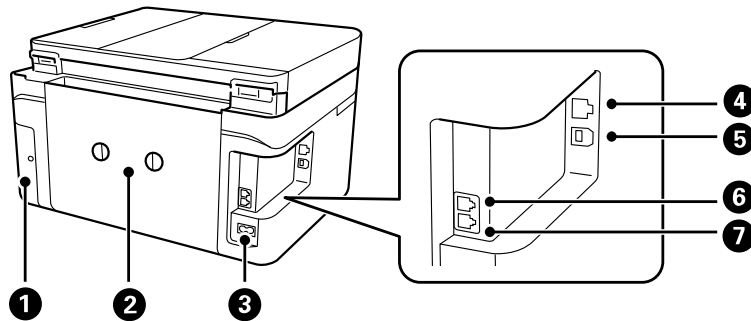

- 1 Maintenance box cover
- 2 Rear cover (duplexer)
- 3 AC inlet
- 4 **LAN** port
- 5 **USB** port
- 6 **EXT** port
- 7 **LINE** port

Parent topic: [Product Parts Locations](#)

Using the Control Panel

See these sections to learn about the control panel and select control panel settings.

[Control Panel Buttons and Lights](#)

[The LCD Screen](#)





[Status Icon Information](#)

[Navigating the LCD Screen](#)
[Entering Characters on the LCD Screen](#)
[Viewing Animations](#)
[Changing LCD Screen Language](#)
[Selecting the Date and Time](#)
[Adjusting Control Panel Sounds](#)
[Turning Off the Operation Time Out Setting](#)
[Preventing PC Connection via USB](#)

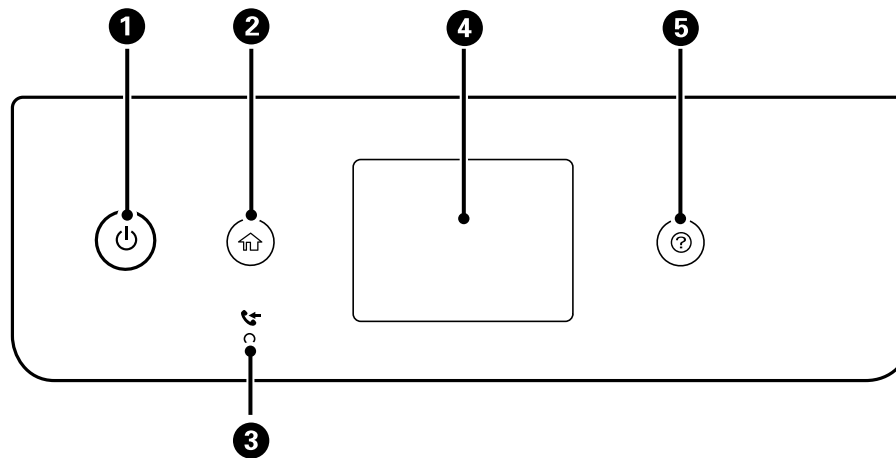
Parent topic: [Product Basics](#)

Control Panel Buttons and Lights



- 1 The  power button and light
- 2 The  home button
- 3 The  received fax light
- 4 The LCD screen
- 5 The  help button

Parent topic: [Using the Control Panel](#)

The LCD Screen













- 1 Displays the supply status information
- 2 Displays the network connection status
- 3 Displays the **Device Sound Settings** screen
- 4 Displays fax data information
- 5 Menu options
- 6 Scrolls to show more menu options

Parent topic: [Using the Control Panel](#)

Status Icon Information



Your product displays status icons on the LCD screen for certain product status conditions.

Icons	Description
	Ink and maintenance box status; select the icon to view the ink and maintenance box levels

Icons	Description
	<p>Network connection status; select the icon to set up or change your network connection</p> <ul style="list-style-type: none"> •  The product is not connected to a wired (Ethernet) network •  The product is connected to a wired (Ethernet) network •  The product is not connected to a wireless network •  The product is searching for an SSID or experiencing a wireless network connection issue •  The product is connected to a wireless network; the number of bars indicates the connection's signal strength •  Wi-Fi Direct is disabled •  Wi-Fi Direct is enabled
	<p>Indicates whether the Mute and Quiet Mode settings are enabled or disabled. Select the icon to change the settings. When Quiet Mode is enabled and depending on the selected paper type and print quality, noise is reduced during printing at the cost of print speed. When Mute is enabled, sounds from the product (such as button presses) are muted.</p>
	<p>Displays the Fax Data Information screen</p>

Parent topic: [Using the Control Panel](#)

Navigating the LCD Screen

-  Tap or press the screen to select an item or icon
-  Flick the screen to scroll swiftly
-  Slide your finger across the screen to move items

 Close or open your fingers across the screen to zoom in or zoom out on a preview image



To change a setting, tap anywhere on the setting.

To enter a value in a field, tap the field to display the on-screen keyboard.

Parent topic: [Using the Control Panel](#)

Entering Characters on the LCD Screen

Follow these guidelines to enter characters for passwords and other settings.



- To move the cursor, select the left or right arrows.

- To change the case of letters, select .

- To delete the previous character, select .

- To enter numbers or symbols, select .

- To enter a commonly used domain name, select .

- To enter a space, select .

Parent topic: [Using the Control Panel](#)

Viewing Animations

You can view animations on the LCD screen to help guide you through a procedure or troubleshoot a problem.

1. Press the  help button.
2. Select **Troubleshooting** if you experience a problem or **How To** to view instructions on common procedures.
3. Select a topic from the list of available topics and follow the on-screen instructions.

Parent topic: [Using the Control Panel](#)

Changing LCD Screen Language

You can change the language used on the LCD screen.

1. Press the  home button, if necessary.
2. Select **Settings > General Settings > Basic Settings > Language**.
3. Select a language.

Parent topic: [Using the Control Panel](#)

Selecting the Date and Time

Before faxing, select the current date, time, and daylight saving phase in your area, and choose your preferred date and time format.

1. Press the  home button, if necessary.
2. Select **Settings > General Settings > Basic Settings > Date/Time Settings**.

You see a screen like this:

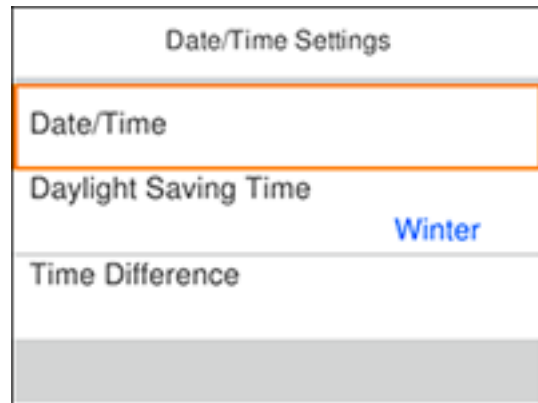

3. Select **Daylight Saving Time**.
4. Select the setting that applies to your area:
 - **Winter**: it is winter or your region does not use Daylight Saving Time (DST)
 - **Summer**: it is spring or summer and your region uses Daylight Saving Time (DST)

Note: If your region uses Daylight Saving Time (DST), you must change this setting to match the season. When you change from **Winter** to **Summer**, your product automatically sets its clock ahead one hour. When you change from **Summer** to **Winter**, it sets its clock back one hour.

5. Select **Date/Time**.
6. Select the date format you want to use.
7. Use the displayed keypad to enter the current date, then select **OK**.
8. Select the time format you want to use, then select **OK**.
9. Use the displayed keypad to enter the current time.
10. Select **Time Difference**.
11. Use the **-** or **+** icons to enter the time difference between your time zone and UTC (Coordinated Universal Time), then select **OK**.

Parent topic: [Using the Control Panel](#)

Adjusting Control Panel Sounds

You can adjust the sound level heard when you press buttons on the control panel.

1. Press the  home button, if necessary.
2. Select **Settings > General Settings > Basic Settings > Sound**.
3. Select **Mute, Normal Mode** or **Quiet Mode**.

Note: Select the  icon on the home screen to switch between Normal Mode and Quiet Mode.

4. If you selected **Normal Mode** or **Quiet Mode**, do the following:
 - Select **Button Press**.
 - Select the – or + icon to decrease or increase the sound.
 - Select **OK** to exit.

Parent topic: [Using the Control Panel](#)

Turning Off the Operation Time Out Setting

The Operation Time Out setting causes the LCD screen to return to the Home screen after a few minutes of inactivity. This feature is enabled by default, but you can turn it off.

1. Press the  home button, if necessary.
2. Select **Settings > General Settings > Basic Settings**.
3. Scroll down and set **Operation Time Out** to **Off**.

Parent topic: [Using the Control Panel](#)

Preventing PC Connection via USB

You can disable access from a USB-connected computer. This restricts non-network access to the product and protects the security of confidential scanned documents.

1. Press the  home button, if necessary.
2. Select **Settings > General Settings > Printer Settings**.
3. Scroll down and select **PC Connection via USB**.
4. Select **Disable**.

5. Select **Yes** to restart the printer.

Parent topic: [Using the Control Panel](#)

Using Power Saving Settings

Your product enters sleep mode automatically and turns off the LCD screen if it is not used for a period of time. You can make the time period shorter and select other options to save energy and resources.

[Changing the Sleep Timer Settings](#)

[Changing the Power Off Timer Settings](#)

Parent topic: [Product Basics](#)

Changing the Sleep Timer Settings

You can adjust the time period before your product enters sleep mode and turns off the LCD screen.

1. Press the  home button, if necessary.
2. Select **Settings** > **General Settings** > **Basic Settings** > **Sleep Timer**.
3. Do one of the following:
 - Select the **+** or **-** icons to increase or decrease the number of minutes.
 - Select the minutes field and use the displayed numeric keypad to enter the number of minutes.
4. Select **OK** when you are finished.

Parent topic: [Using Power Saving Settings](#)

Changing the Power Off Timer Settings

You can have the product turn off automatically if it is not used for a specified period of time.

1. Press the  home button, if necessary.
2. Select **Settings** > **General Settings** > **Basic Settings** > **Power Off Timer**.
3. Select a time period, or select **Off**.

Parent topic: [Using Power Saving Settings](#)

Using the Epson Smart Panel Mobile App

Use this free Apple and Android app to set up and control your Epson product. Epson Smart Panel also lets you check product status.

Note: App features may vary depending on your Epson product.

1. Visit epson.com/connect (U.S.) or epson.ca/connect (Canada) to learn more about Epson Smart Panel and check the compatibility of your mobile device.
2. Download Epson Smart Panel from the Apple App Store or Google Play.
3. Do one of the following:
 - If your Epson product is already connected to a wireless network, connect your mobile device to the same network. Then open Epson Smart Panel and select your Epson product, if necessary.
 - If your Epson product is not connected to a wireless network, connect your mobile device to the network you want to use, then open Epson Smart Panel and follow the instructions to set up your Epson product.

Now you are ready to control your Epson product with your mobile device.

Parent topic: [Product Basics](#)

Related topics

[Wi-Fi or Wired Networking](#)

Voice-activated Printing

Take advantage of voice-activated, hands-free printing from your Epson product with Alexa, Siri, and Google Assistant. Depending on which voice assistant you use, you can ask your product to print photos, calendars, recipes, photo props, and more. [Click here](#) for more information.

1. Connect your product to your network. See the link below.
2. Set up your product's email address for use with Epson Connect. See the link below to activate it from the product control panel.
3. [Click here](#) for instructions on how to set up your product and voice assistant to use the voice-activated printing feature.

Now you are ready to print with your voice and your Epson product.

Parent topic: [Product Basics](#)

Related tasks

[Setting Up Epson Connect Services](#)

[Using the Epson Smart Panel Mobile App](#)

Related topics

[Wi-Fi or Wired Networking](#)

Epson Connect Solutions for Smartphones, Tablets, and More

Use your smartphone, tablet, or computer to print and scan documents, photos, emails, and web pages from your home, office, or even across the globe.

Note: If you are using your Epson product with the Windows 10 S operating system, you cannot use the software described in this section. You also cannot download and install any Epson product software from the Epson website for use with Windows 10 S; you must obtain software only from the Windows Store.

Print from anywhere with these Epson Connect solutions:

- Epson Email Print
- Epson Remote Print

Scan and send a file as an email or upload it to an online service directly from your Epson product with Epson Scan to Cloud.

[Setting Up Epson Connect Services](#)

[Using Epson Email Print](#)

[Using Epson Remote Print](#)

[Using Epson Scan to Cloud](#)

Parent topic: [Product Basics](#)

Related tasks

[Using AirPrint](#)

[Android Printing Using the Epson Print Enabler](#)

[Setting Up Printing on a Chromebook](#)

[Using Epson Print and Scan App with Windows Tablets](#)

[Using the Mopria Print Service](#)

Setting Up Epson Connect Services

If you did not activate your product's email address for use with Epson Connect when you set up your product, you can activate it using the product control panel.

1. Press the  home button, if necessary.
2. Select **Settings**.
3. Select **General Settings**.

4. Select **Web Service Settings**.
5. Select **Epson Connect Services**.
6. Select **Register**.
7. Follow the instructions on the screen to activate your product's email address.

Parent topic: [Epson Connect Solutions for Smartphones, Tablets, and More](#)

Related topics

[Wi-Fi or Wired Networking](#)

Using Epson Email Print

With Epson Email Print, you can print from any device that can send email, such as your smartphone, tablet, or laptop. Just activate your product's unique email address. When you want to print, attach a PDF, Microsoft Office document, or photo to an email and send it to your product. Both the email and the attachments will print automatically.

1. Connect your product to your network. See the link below.
2. If you did not already set up Email Print when you installed your product software, see the link below to use your product control panel to activate your unique email address. Or visit epson.com/connect (U.S.) or epson.ca/connect (Canada) to learn more about Email Print, create your Epson Connect account, and register your product to the Epson Connect service.
3. Now you are ready to send and print emails to your product's Email Print address.

Note: Go to epsonconnect.com and log into your Epson Connect account to personalize your product's email, adjust print settings, and set up other Epson Connect services.

Parent topic: [Epson Connect Solutions for Smartphones, Tablets, and More](#)

Related tasks

[Setting Up Epson Connect Services](#)

Related topics

[Wi-Fi or Wired Networking](#)

Using Epson Remote Print

With Epson Remote Print software, you can print from your laptop or desktop computer to an Epson Email-enabled product anywhere in the world.

1. Connect your Epson product to your wireless network. See the link below.

2. If you did not already set up an Epson Connect account when you installed your product software, visit epsonconnect.com to create your account and register your product to the Epson Connect service.

Note: Make a note of your product's email address.

3. Visit epsonconnect.com to learn more about Remote Print and how to download the Remote Print Driver software.
4. Download and install the Remote Print software.
5. Enter the email address and optional access key of your Epson product during Remote Print setup.
6. Now you are ready to print remotely. Select the print command in your laptop or desktop computer application and choose the Remote Print option for your Epson product.

Parent topic: [Epson Connect Solutions for Smartphones, Tablets, and More](#)

Related tasks

[Setting Up Epson Connect Services](#)

Related topics

[Wi-Fi or Wired Networking](#)

Using Epson Scan to Cloud

The Epson Scan to Cloud service allows you to scan and send a file as an email or upload it to an online service directly from your Epson product. Register an email address or online services such as Box, DropBox, Evernote, or Google Drive with your Epson Connect account.

1. Connect your Epson product to your network. See the link below.
2. If you did not already set up an Epson Connect account when you installed your product software, visit epsonconnect.com to create your account and register your product to the Epson Connect service.

Note: Make a note of your product's email address and password.

3. Visit epsonconnect.com to sign into your account with the email address and password you selected.
4. Select your product, select **Scan to Cloud**, and select **Destination List**.
5. Click **Add**, then follow the instructions on the screen to create your destination list.

6. Now you are ready to use Scan to Cloud. Select the setting for scanning to Scan to Cloud on your Epson product control panel.

Parent topic: [Epson Connect Solutions for Smartphones, Tablets, and More](#)

Related tasks

[Setting Up Epson Connect Services](#)

[Scanning to the Cloud](#)

Related topics

[Wi-Fi or Wired Networking](#)

Using AirPrint

AirPrint enables instant wireless printing from iPhone, iPad, iPod touch, and Mac without the need to install drivers or download software.



Note: If you disabled paper configuration messages on your product control panel, you cannot use AirPrint. See the link below to enable the messages, if necessary.

1. Load paper in your product.
2. Set up your product for wireless printing. See the link below.
3. Connect your Apple device to the same wireless network that your product is using.
4. Print from your device to your product.

Note: For details, see the AirPrint page on the Apple website.

Parent topic: [Product Basics](#)

Related references

[Paper Source Settings Options](#)

Related topics

[Wi-Fi or Wired Networking](#)

[Loading Paper](#)

Setting Up Printing on a Chromebook

Your Epson printer supports native printing on Chromebook, allowing you to print from a Chromebook without drivers or cables.

For directions on setting up your printer, visit [Setting Up Your Epson Printer on Your Chromebook](#) (U.S.) or [Setting Up Your Epson Printer on Your Chromebook](#) (Canada).

Parent topic: [Product Basics](#)

Android Printing Using the Epson Print Enabler

You can wirelessly print your documents, emails, photos, and web pages right from your Android phone or tablet (Android v4.4 or later). With a few taps, your Android device will discover your nearby Epson product and print.

1. Connect your Epson product to your wireless network. See the link below.
2. On your Android device, download the Epson Print Enabler plug-in from Google Play.
3. Go to **Settings** on your Android device, select **Printing**, and enable the Epson plug-in, if necessary.
4. Connect your Android device to the same wireless network as your product.
5. Now you are ready to print. From an Android application such as Chrome or Gmail, tap the menu icon and print whatever is on the screen.

Note: If you do not see your product, tap **All Printers** and select your product.

Parent topic: [Product Basics](#)

Related topics

[Wi-Fi or Wired Networking](#)

Using Epson Print and Scan App with Windows Tablets

You can use this free app to print photos and scan from your Windows (Windows 8 or higher) Surface RT or Pro tablet with networked Epson products. The Epson Print and Scan app allows you to scan and capture images right to your tablet or to Microsoft OneDrive.

Note: The Epson Print and Scan app does not support Windows 10 Mobile printing and does not supply scanning functions for products without scanners.

1. Connect your Epson product to your wireless network. See the link below.
2. Download the Epson Print and Scan app from the Microsoft Windows Store.
3. Connect your Windows tablet to the same wireless network as your product.
4. Open the Epson Print and Scan app and select your Epson product.

Now you are ready to print photos or scan.

Parent topic: [Product Basics](#)

Related topics

[Wi-Fi or Wired Networking](#)

Using the Mopria Print Service

You can use the Mopria Print Service to print from your Android phone or tablet (Android v4.4 or later) to your Epson product or any Mopria-certified product from other manufacturers. You can download the Mopria Print Service from Google Play.

Note: For details on the Mopria Print Service, [click here](#) (U.S.) or [click here](#) (Canada). Some Amazon Fire tablets also use the Mopria Print Service.

1. Connect your Epson product to your wireless network. See the link below.
2. On your Android device, download the Mopria Print Service app from Google Play.

Note: On some Samsung Galaxy devices, Mopria may come preinstalled.

3. Go to **Settings** on your Android device, select **Printing**, and enable the Mopria Print Service, if necessary.
4. Connect your Android device to the same wireless network as your product.
5. Now you are ready to print. From an Android application such as Chrome or Gmail, tap the menu icon and select **Print**. Then select **All printers**, select your Epson product, adjust your print settings, and print.

Parent topic: [Product Basics](#)

Related topics

[Wi-Fi or Wired Networking](#)

Wi-Fi or Wired Networking

See these sections to use your product on a Wi-Fi or wired network.

[Network Security Recommendations](#)

[Wi-Fi Infrastructure Mode Setup](#)

[Wi-Fi Direct Mode Setup](#)

[Wi-Fi Protected Setup \(WPS\)](#)

[Printing a Network Status Sheet](#)

[Printing a Network Connection Report](#)

[Changing or Updating Network Connections](#)

Network Security Recommendations

To help deter unauthorized access to your product over a network, you should protect your network environment using appropriate security measures.

Security measures such as these can help deter threats such as loss of user data, use of telephone and fax lines, and other intrusions:

- **Enable security on your wireless LAN**

Enable the appropriate security on the wireless LAN you plan to use with your product. Network security such as a network password can deter interception of traffic over the wireless LAN. Your router may already have a default password enabled by your Internet service provider (ISP). See your ISP and router documentation for instructions on how to change the default password and better secure your network.

- **Connect your product only to a network protected by a firewall**

Connecting your product directly to the Internet may leave it vulnerable to security threats. Instead, connect it to a router or other network connection protected by a firewall. Your router may already have a firewall set up by your Internet service provider; check with your ISP for confirmation. For best results, set up and use a private IP address for your network connection.

- **Change the default administrator password on your product**

If your product has an option to set an administrator password, change the default administrator password to deter access by unauthorized users to personal data stored on your product, such as IDs, passwords, and contact lists.

Parent topic: [Wi-Fi or Wired Networking](#)

Wi-Fi Infrastructure Mode Setup

You can set up your product to communicate with your computer using a wireless router or access point. The wireless router or access point can be connected to your computer over a wireless or wired network.

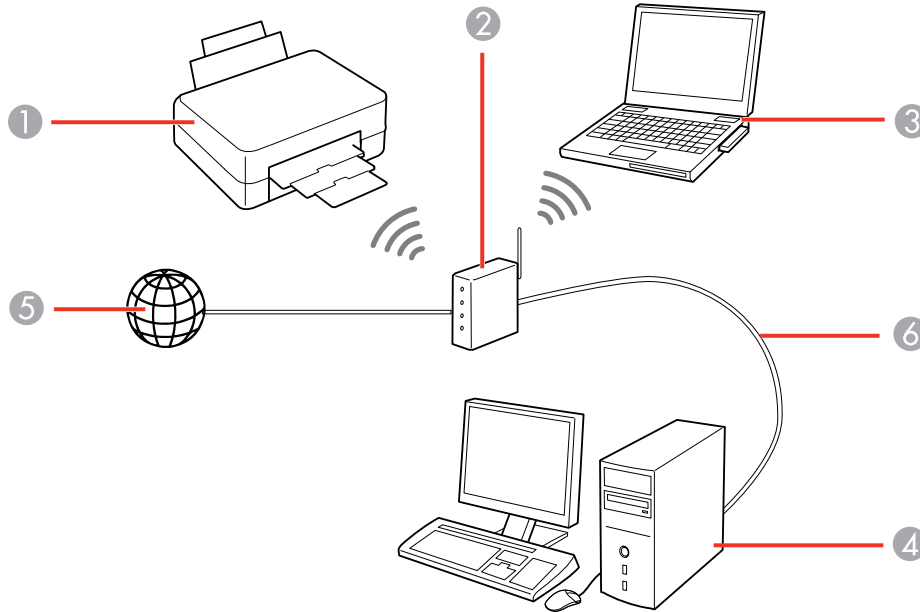

- 1 Epson product
- 2 Wireless router or access point
- 3 Computer with a wireless interface
- 4 Computer
- 5 Internet
- 6 Ethernet cable (used only for wired connection to the wireless router or access point)

[Selecting Wireless Network Settings from the Control Panel](#)

Parent topic: [Wi-Fi or Wired Networking](#)

Selecting Wireless Network Settings from the Control Panel

You can select or change wireless network settings using your product control panel.

To install your product on a wireless network, follow the instructions on the *Start Here* sheet and install the necessary software by downloading it from the Epson website. The installer program guides you through network setup.

Note: Breakdown or repair of this product may cause loss of network data and settings. Epson is not responsible for backing up or recovering data and settings during or after the warranty period. We recommend that you make your own backup or print out your network data and settings.

1. Press the  home button, if necessary.

2. Select the  icon.

You see a screen like this:



3. Select **Wi-Fi (Recommended)**.





4. Select **Start Setup** or **Change Settings**.

5. Select **Wi-Fi Setup Wizard**.

6. Select the name of your wireless network or select **Enter Manually** to enter the name manually. If you are entering the name manually, use the displayed keyboard to enter your network name.



Note: The network name and password are case sensitive. Be sure to correctly enter uppercase and lowercase letters, and numeric or special characters.

- To move the cursor, press the left or right arrows.
 - To change the case of letters, select .
 - To delete the previous character, select .
 - To enter numbers and symbols, select .
 - To enter a space, select .
 - To finish entering your network name or password, select **OK**.
7. Select the **Enter Password** field and use the displayed keyboard to enter your network password.
 8. When you are finished, confirm the displayed network settings and select **Start Setup** to begin setup.
 9. Do one of the following:
 - If setup was successful, select **Close** to exit.
 - If setup was unsuccessful, select **Print Check Report** to print a network setup report or **Re-enter** to re-enter your network name and password again.
 10. Press the  home button to return to the Home screen.

The  Wi-Fi icon is displayed on the LCD screen and indicates your wireless connection status. If the product is not connected to the network, you may have selected the wrong network name or entered the password incorrectly. Repeat these steps to try again.

If you are printing from a computer, make sure you installed the network software as described on the *Start Here* sheet.

Parent topic: [Wi-Fi Infrastructure Mode Setup](#)

Related references

[Status Icon Information](#)

Related tasks

[Entering Characters on the LCD Screen](#)

Wi-Fi Direct Mode Setup

You can set up your product to communicate directly with your computer or another device without requiring a wireless router or access point. In Wi-Fi Direct Mode, the product itself acts as a network access point for up to 8 devices.

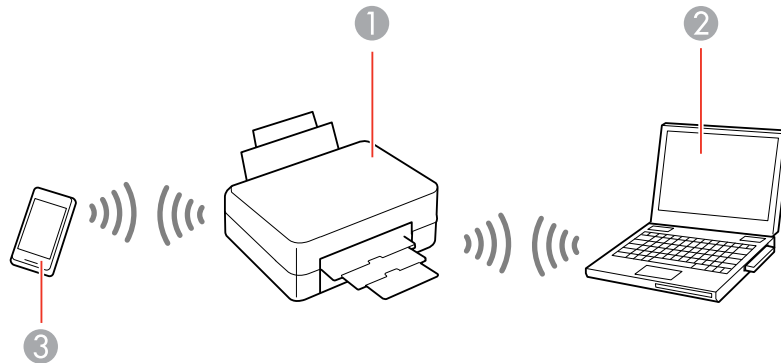

- 1 Epson product
- 2 Computer with a wireless interface
- 3 Other wireless device

[Enabling Wi-Fi Direct \(Simple AP\) Mode](#)

Parent topic: [Wi-Fi or Wired Networking](#)

Enabling Wi-Fi Direct (Simple AP) Mode

You can enable Wi-Fi Direct mode to allow direct communication between your product and computer, mobile devices, or other devices (up to 8) without a wireless router or access point.

Note: Make sure the Epson Smart Panel app or another compatible Epson printing app is installed on your mobile device before connecting to the product.

1. Press the  home button, if necessary.

2. Select the  icon.

You see a screen like this:

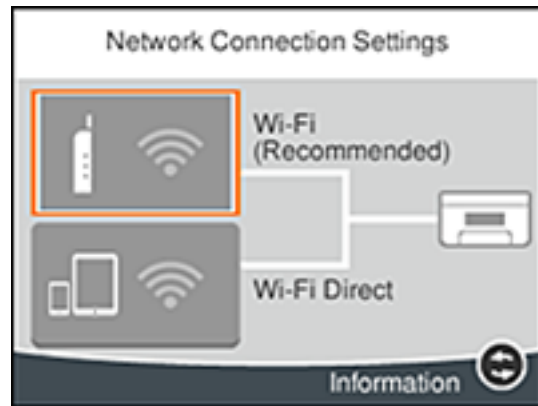

3. Select **Wi-Fi Direct > Start Setup**.

The product information is displayed on the screen.

4. Do one of the following:

- Open the Epson Smart Panel app on your device and use the information on the LCD screen to select your product. Skip to step 7.
- To connect without using the Epson Smart Panel app, select **Other Methods** and go to the next step.

5. Do one of the following:
 - For iOS devices, select **iOS**. Scan the QR code with the camera app on your device and follow the instructions on your device.
 - For other types of devices, select **Other OS Devices**. Press the down arrow button to display the product information, then use your device to select the Wi-Fi network name (SSID) displayed on the LCD screen and enter the password shown.
6. Select **Complete** on the LCD screen.

The blue  Wi-Fi Direct icon is displayed on the LCD screen and indicates if Wi-Fi Direct is enabled on the product.

Parent topic: [Wi-Fi Direct Mode Setup](#)

Related references

[Status Icon Information](#)

Related tasks

[Using the Epson Smart Panel Mobile App](#)

Wi-Fi Protected Setup (WPS)

If your network uses a WPS-enabled wireless router or access point, you can quickly connect your product to the network using Wi-Fi Protected Setup (WPS).



Note: To check if your router is WPS-enabled, look for a button labeled **WPS** on your router or access point. If there is no hardware button, there may be a virtual WPS button in the software for the device. Check your network product documentation for details.

[Using WPS to Connect to a Network](#)

Parent topic: [Wi-Fi or Wired Networking](#)

Using WPS to Connect to a Network

If you have a WPS-enabled wireless router or access point, you can use Wi-Fi Protected Setup (WPS) to connect your product to the network.

1. Press the  home button, if necessary.
2. Select the  icon.
3. Select **Wi-Fi (Recommended)**.

4. Select **Start Setup** or **Change Settings**.
5. Select **Push Button Setup (WPS)**.
6. Follow the instructions on the LCD screen to complete WPS setup.

Note: Make sure you select **Start Setup** within two minutes of activating WPS on your router.

7. Press the  home button to return to the Home screen.

The  Wi-Fi icon is displayed on the LCD screen and indicates your wireless connection status. If the product is not connected to the network, repeat these steps to try again.

If you are printing from a computer, make sure you installed the network software as described on the *Start Here* sheet.

Parent topic: [Wi-Fi Protected Setup \(WPS\)](#)

Related references

[Status Icon Information](#)

Printing a Network Status Sheet

You can print a network status sheet to help you determine the causes of any problems you may have using your product on a network.

1. Make sure a few sheets of plain paper are loaded in the product.
2. Press the  home button, if necessary.
3. Select **Settings** > **General Settings** > **Network Settings** > **Network Status** > **Print Status Sheet**.
4. Select **Print** to print the status sheet.

Examine the settings shown on the network status sheet to diagnose any problems you have.

Parent topic: [Wi-Fi or Wired Networking](#)

Related topics

[Loading Paper](#)

Printing a Network Connection Report

You can print a network connection report to view solutions to any problems you may have using your product on a network.

1. Make sure a few sheets of plain paper are loaded in the product.

2. Press the  home button, if necessary.
3. Select **Settings** > **General Settings** > **Network Settings** > **Connection Check**.

After the network connection is checked, you see a screen like this:

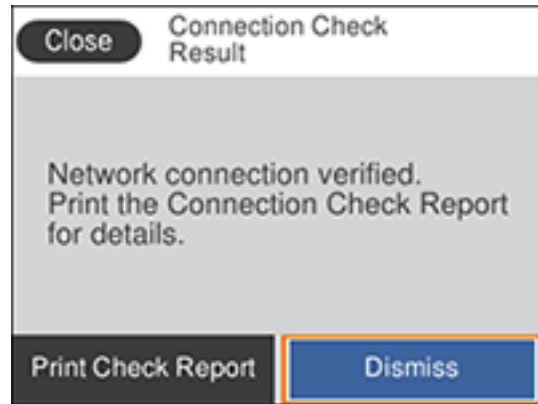

4. Select **Print Check Report** to print the network connection report.
Examine the error codes and solutions shown on the network connection report.
[Network Connection Report Codes and Messages](#)

Parent topic: [Wi-Fi or Wired Networking](#)

Related topics

[Loading Paper](#)

Network Connection Report Codes and Messages

Check the error codes and messages on the network connection report to solve problems you may encounter with network connections. The tables here list solutions to problems based on the error codes and messages that may appear on the top of the report.

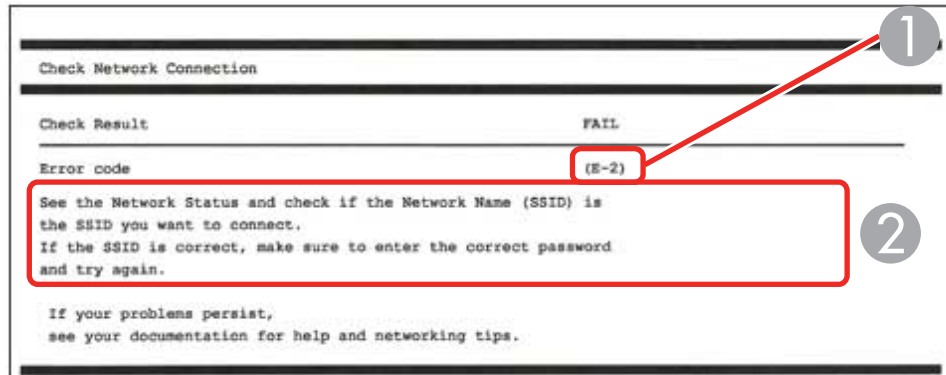

- 1 Error code
- 2 Message

Note: Error codes and messages listed here may not all apply to your product.

Error Codes and Messages

Error code and message	Solution
E-1 Confirm that the network cable is connected and network devices such as hub, router, or access point are turned on.	Make sure your router, access point, and/or hub are turned on, and the network cable is securely connected to your device and to your product. If you are trying to set up Wi-Fi, remove the network cable and set up Wi-Fi again. Ethernet and Wi-Fi cannot be connected at the same time.

Error code and message	Solution
<p>E-2, E-3, or E-7</p> <p>No wireless network names (SSID) found. Confirm that the router/access point is turned on and the wireless network (SSID) is set up correctly. Contact your network administrator for assistance.</p> <p>No wireless network names (SSID) found. Confirm that the wireless network name (SSID) of the PC you wish to connect is set up correctly. Contact your network administrator for assistance.</p> <p>Entered security key/password does not match the one set for your router/access point. Confirm security key/password. Contact your network administrator for assistance.</p>	<p>Check the following:</p> <ul style="list-style-type: none"> • Make sure your router or access point is turned on, and is correctly connected to your computer or network device. • Turn off the router or access point, wait about 10 seconds, and turn it on again. • Move your product closer to your router or access point, and remove any obstacles between them. Also move your product away from devices such as wireless phones or microwaves. • Confirm that the SSID shown on the network connection report matches the label on your router or access point. Also make sure your SSID uses only ASCII characters and symbols, or your product cannot display the SSID correctly. • If you are trying to connect using the WPS push button method, make sure your router or access point supports it. • If you are using a network password, check the label on your router or access point to confirm that you are using the correct password, or check with your network administrator or router/access point documentation. • If you are connecting to a smart device that generates an SSID, check the device documentation for the SSID and password you should use. • If your wireless connection suddenly disconnects, and another smart device was added to the network using a WPS push button method or your network was set up using a non-WPS push button method, try downloading and installing your product software again.

Error code and message	Solution
<p>E-5 Security mode (e.g. WEP, WPA) does not match the current setting of the printer. Confirm security mode. Contact your network administrator for assistance.</p>	<p>If the security on your router or access point is not one of the following types, change the type of security on your router or access point and reset your product's network settings.</p> <ul style="list-style-type: none"> • WEP-64 bit (40 bit) • WEP-128 bit (104 bit) • WPA PSK (TKIP/AES); also known as WPA Personal • WPA2 PSK (TKIP/AES); also known as WPA2 Personal • WPA (TKIP/AES) • WPA2 (TKIP/AES) • WPA3-SAE (AES)
<p>E-6 MAC address of your printer may be filtered. Check whether your router/access point has restrictions such as MAC address filtering. See the documentation of the router/access point or contact your network administrator for assistance.</p>	<p>If your router or access point has MAC address filtering enabled, register your product's MAC address so it is not filtered. Locate the MAC address on the network connection report and check your router or access point documentation for instructions.</p> <p>If your router or access point is using shared authentication with WEP security, confirm that you are using the correct authentication key and index.</p> <p>If your router or access point limits the number of connected devices, raise the connection limit. See your router or access point documentation for instructions.</p>
<p>E-8 Incorrect IP address is assigned to the printer. Confirm IP address setup of the network device (hub, router, or access point). Contact your network administrator for assistance.</p>	<p>If your product's Obtain IP Address setting is set to Auto, enable DHCP on your router or access point. If it is set to Manual, the IP address may be out of range or on a different network segment; set a valid IP address using your product control panel or the Web Config utility.</p> <p>You can also try turning off your product and the router or access point, waiting about 10 seconds, and turning them on again.</p>

Error code and message	Solution
<p>E-9 Confirm the connection and network setup of the PC or other device. Connection using the EpsonNet Setup is available. Contact your network administrator for assistance.</p>	<p>Make sure your computer or network device are turned on. Also make sure that you can access the Internet and other devices on the same network from the devices you are trying to connect to your product.</p> <p>If you still cannot connect to your product, turn off your router or access point, wait about 10 seconds, and turn it on again. Download and install your product software again to reset your network settings.</p>
<p>E-10 Confirm IP address, subnet mask, and default gateway setup. Connection using the EpsonNet Setup is available. Contact your network administrator for assistance.</p>	<p>Make sure other devices on the network are turned on and do the following:</p> <ul style="list-style-type: none"> • If your product's Obtain IP Address setting is set to Manual, check the IP address, subnet mask, and default gateway addresses on the network connection report to see if they are correct. If not, correct the settings. • If DHCP is enabled, set your product's Obtain IP Address setting to Auto. If you want to use the DHCP-assigned address as a static address, set the Obtain IP Address setting to Manual, enter the product's IP address as listed on the network connection report, and set the subnet mask to 255.255.255.0. <p>If you still cannot connect to your product, turn off your router or access point, wait about 10 seconds, and turn it on again.</p>
<p>E-11 Setup is incomplete. Confirm default gateway setup. Connection using the EpsonNet Setup is available. Contact your network administrator for assistance.</p>	<p>If you set your product's TCP/IP Setup setting to Manual, check that the default gateway address listed on the network connection report is correct. Also turn on the device that is set as the default gateway.</p>

Error code and message	Solution
<p>E-12</p> <p>Confirm the following:</p> <ul style="list-style-type: none"> -Entered security key/password is correct -Index of the security key/password is set to the first number -IP address, subnet mask, or default gateway setup is correct <p>Contact your network administrator for assistance.</p>	<p>Make sure other devices on the network are turned on and do the following:</p> <ul style="list-style-type: none"> • Make sure the IP address, subnet mask, and default gateway addresses are correct, if you are entering them manually. • Confirm that the subnet mask and default gateway addresses for other devices are the same. • Make sure the IP address does not conflict with other devices. <p>If you still cannot connect to your product, do the following:</p> <ul style="list-style-type: none"> • Turn off your router or access point, wait about 10 seconds, and turn it on again. • Download and install your product software again to reset your network settings. • If your router or access point uses WEP security with several registered passwords, make sure that the first registered password is set on your product.
<p>E-13</p> <p>Confirm the following:</p> <ul style="list-style-type: none"> -Entered security key/password is correct -Index of the security key/password is set to the first number -Connection and network setup of the PC or other device is correct <p>Contact your network administrator for assistance.</p>	<p>Make sure your router, access point, and/or hub are turned on. Also make sure the TCP/IP setup on your router, access point, and/or hub is not set manually; this may cause your product's network settings to differ from the manually set up devices.</p> <p>If you still cannot connect to your product, do the following:</p> <ul style="list-style-type: none"> • Turn off your router or access point, wait about 10 seconds, and turn it on again. • Download and install your product software again to reset your network settings. • If your router or access point uses WEP security with several registered passwords, make sure that the first registered password is set on your product.

Network Environment Messages

Message	Solution
The Wi-Fi environment needs to be improved. Turn the wireless router off and then turn it on. If the connection does not improve, see the documentation for the wireless router.	Move your product closer to your router or access point, and remove any obstacles between them. Then turn off your router or access point, wait about 10 seconds, and turn it back on again. If you still cannot connect to your product, check the documentation that came with your router or access point for solutions.
*No more devices can be connected. Disconnect one of the connected devices if you want to add another one.	You can connect up to 8 computers or other devices to your product using a Wi-Fi Direct (Simple AP) connection. If you want to add another device, disconnect an existing connected device first.
The same SSID as Wi-Fi Direct exists in the environment. Change the Wi-Fi Direct SSID if you cannot connect a smart device to the printer.	Change the Wi-Fi Direct SSID. You can change the network name after "DIRECT-XX-". The custom name must be 22 characters or less.

Parent topic: [Printing a Network Connection Report](#)

Changing or Updating Network Connections

See these sections to change or update how your product connects to a network.

[Accessing the Web Config Utility](#)

[Changing a USB Connection to a Wi-Fi Connection](#)

[Changing a Wi-Fi Connection to a Wired Network Connection](#)

[Connecting to a New Wi-Fi Router](#)

[Disabling Wi-Fi Features](#)

[Disabling Wi-Fi Direct \(Simple AP\) Mode](#)

Parent topic: [Wi-Fi or Wired Networking](#)

Accessing the Web Config Utility

You can select your product's network settings and confirm its operating status using a web browser. You do this by accessing your product's built-in Web Config utility from a computer or other device that is connected to the same network as your product.

Note: You can also access the Web Config utility from the product information area in the Epson Smart Panel app.

1. Print a network status sheet.
2. Locate the IP address for your product that is listed on the network status sheet.
3. On a computer or other device connected to the same network as your product, open a web browser.
4. Enter your product's IP address into the address bar.

You see the available Web Config utility options.

Note: The administrator password is required to access the full capabilities of the Web Config utility. The default password is the product's serial number. Check the label on your product to locate the serial number.

Parent topic: [Changing or Updating Network Connections](#)

Related tasks

[Printing a Network Status Sheet](#)

Changing a USB Connection to a Wi-Fi Connection

If you have already connected your product to your computer using a USB connection, you can change to a Wi-Fi connection.

1. Disconnect the USB cable from your product.
2. Uninstall your product software.
3. Download and install your product software from the Epson website using the instructions on the *Start Here* sheet.

Parent topic: [Changing or Updating Network Connections](#)

Related concepts

[Uninstall Your Product Software](#)

Changing a Wi-Fi Connection to a Wired Network Connection

If you have already connected your product to your computer wirelessly, you can change to a wired network connection if necessary.

1. Disable your product's Wi-Fi features.

2. Connect one end of an Ethernet network cable to the product's **LAN** port.
3. Connect the other end to any available LAN port on your router or access point.
4. Uninstall your product software.
5. Download and install your product software from the Epson website.
6. Follow the on-screen instructions to install the software.
7. When you see the Select Your Connection screen, select **Wired network connection**.
8. If you see a Select Setup Option screen, select **Set up printer for the first time**.
9. Continue following the rest of the on-screen instructions.

Parent topic: [Changing or Updating Network Connections](#)

Related concepts

[Uninstall Your Product Software](#)

Related tasks

[Disabling Wi-Fi Features](#)

Connecting to a New Wi-Fi Router

If you change the wireless router you have been using on your network, you need to update your product's Wi-Fi connection to the new router.

Note: If you switch to a 5 GHz wireless router, set the router to operate in dual band (2.4 GHz and 5 GHz) mode. If your router uses a single network name (SSID) for both the 2.4 GHz and 5 GHz band, give each band its own network name (SSID) instead, such as Home Network 2.4 GHz and Home Network 5 GHz. See your router documentation for instructions.

1. Do one of the following:
 - **Windows:** Uninstall your product software.
 - **Mac:** Go to the next step.
2. Download and install your product software from the Epson website using the instructions on the *Start Here* sheet.

Parent topic: [Changing or Updating Network Connections](#)



Related concepts

[Uninstall Your Product Software](#)

Disabling Wi-Fi Features

You may need to disable your product's Wi-Fi features if you change your network connection type or need to solve a problem with your network connection.

Note: Before disabling Wi-Fi features, make a note of your product's SSID (network name) and password, and any network settings selected for the Epson Connect services you may use.



1. Press the  home button, if necessary.
2. Select the  icon.
3. Select **Wi-Fi (Recommended) > Change Settings > Others > Disable Wi-Fi > Start Setup** to disable Wi-Fi.

Parent topic: [Changing or Updating Network Connections](#)

Disabling Wi-Fi Direct (Simple AP) Mode

You may need to disable your product's Wi-Fi Direct connection if you change your network connection type or need to solve a problem with your network connection.

Note: When the Wi-Fi Direct (Simple AP) connection is disabled, all computers and smart devices connected to the product in Wi-Fi Direct (Simple AP) mode are disconnected. If you want to disconnect a specific device, disconnect from the device instead of the product.

1. Press the  home button, if necessary.
2. Select the  icon.
3. Select **Wi-Fi Direct > Start Setup**.
4. Select the  menu icon.
5. Select **Disable Wi-Fi Direct**.
6. Select **Disable the settings**.
7. Follow the instructions on the LCD screen to disable Wi-Fi Direct mode.

The  Wi-Fi Direct icon is displayed on the LCD screen and indicates Wi-Fi Direct is disabled on the product.

Parent topic: [Changing or Updating Network Connections](#)

Related references

[Status Icon Information](#)

Loading Paper

Before you print, load paper for the type of printing you will do.

[Loading Paper in the Cassette](#)

[Compatible Epson Papers](#)

[Paper or Media Type Settings - Printing Software](#)

[Selecting the Paper Settings - Control Panel](#)

[Selecting the Default Paper Source Settings](#)

[Selecting the Universal Print Settings](#)

Loading Paper in the Cassette

You can press the  help button and select **How To** > **Load Paper** to view paper loading instructions on the LCD screen.

Note: Before loading paper, make sure your product is not currently printing, scanning, or copying.

1. Open the front cover.

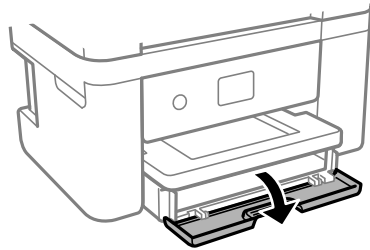

2. Pull out the paper cassette until it stops.

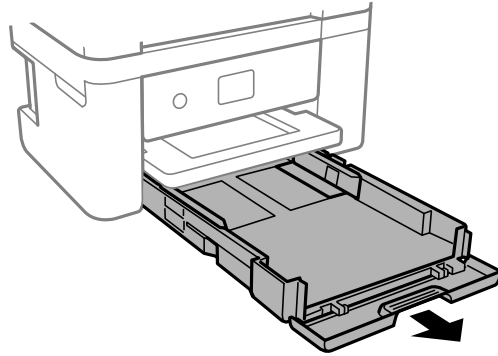

3. Squeeze the tab on the right edge guide and slide the edge guides outward.

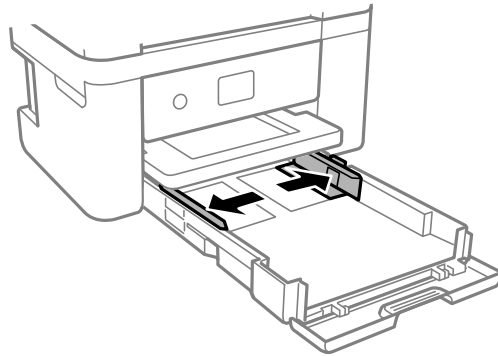

4. If you are inserting a stack of paper, fan the sheets first and tap the stack on a flat surface to even the edges.

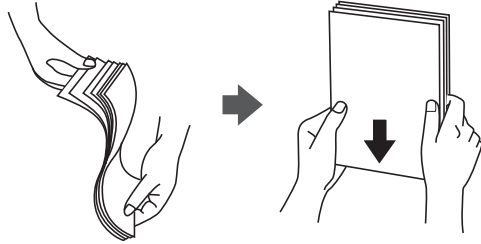

Note: Do not fan or curl photo paper.

5. Do one of the following:
 - Insert paper into the cassette with the glossy or printable side down and slide it in until it stops.

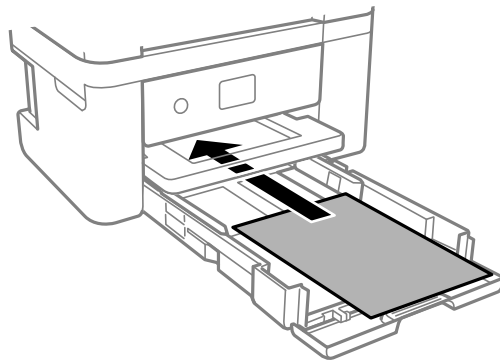

Note: Make sure the paper is loaded against the rear of the cassette.

- For legal-size paper, extend the legal paper guide and load paper using the guide line as shown.

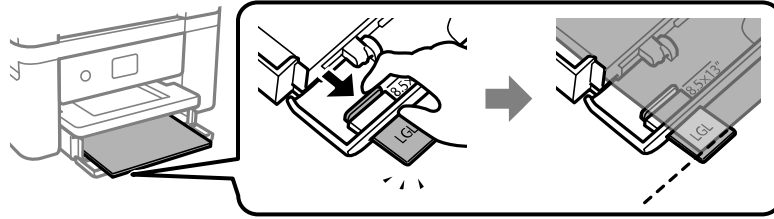

- Load up to 10 envelopes with the printable side down and flap facing right, as shown.

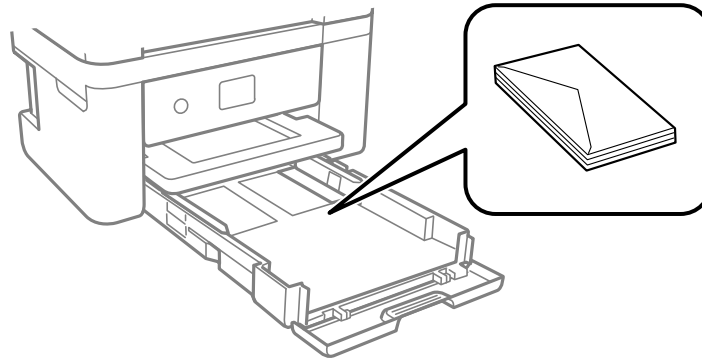

- Load a single sheet of loose-leaf or other paper with holes facing as shown. Load paper printable side up and slide it in until it stops. Select **Letterhead** as the paper type setting.

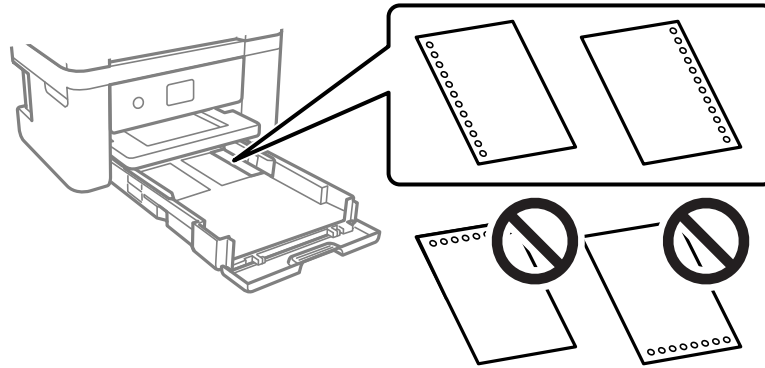

- To load a sheet of paper longer than legal size, open the paper support and insert the paper as shown. Select **User-Defined** as the paper size setting.

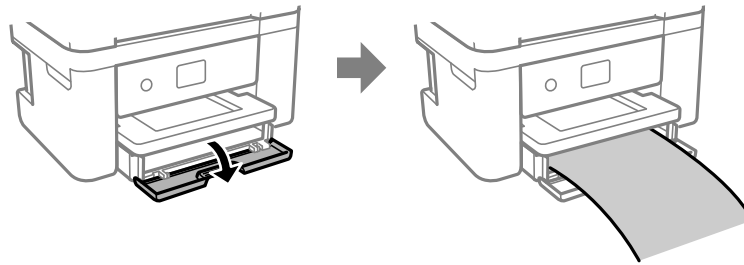

6. Slide the edge guides against the paper, but not too tightly.

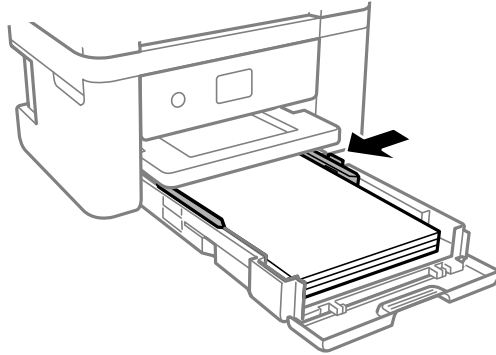

Note: Make sure the paper fits under the tabs on the edge guides.

7. Slide the cassette back into the product until it stops.
8. If prompted by the product, select the size and type of the paper you loaded.

Note: If you are printing on letterhead, make sure you select **Letterhead** as the paper type setting. Make sure you select the correct paper size setting. For letterhead paper, if you print on paper that is smaller than the setting in the printer driver, the printer may print beyond the edges of the paper which can lead to ink smears on your printouts and excess ink building up inside the printer. Borderless printing and 2-sided printing are not available for letterhead paper. Printing on letterhead may be slower.

9. Extend the output tray.

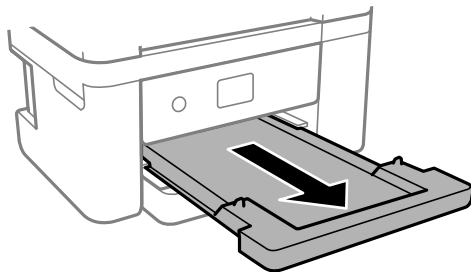

Note: Do not remove or insert the paper cassette during printing.

Always follow these paper loading guidelines:

- Load only the recommended number of sheets.
- Load paper short edge first and printable side down.
- Load letterhead or pre-printed paper top edge first.
- Make sure the paper is under the tabs on the edge guides and not sticking out from the rear end of the cassette.
- If the paper is curled, flatten it or curl it slightly in the opposite direction before loading. Printing on curled paper may cause paper jams and smears on the printout.
- Do not use papers that are wavy, torn or cut, folded, damp, have stickers, or are too thick or too thin.
- Fan and align the edges of envelopes before loading.
- If you have trouble loading a stack of envelopes, press each envelope flat before loading it or load one envelope at a time.
- Do not load envelopes that are curled, folded, or too thin, or that have plastic windows or exposed adhesive flaps.
- Paper feed problems may occur frequently for manual 2-sided printing when printing on one side of pre-printed paper. Reduce the number of sheets to half or less, or load one sheet of paper at a time if paper jams continue.
- For pre-punched paper, load a single sheet of defined-size plain paper with holes at the left or right. Adjust the print position of your file to avoid printing over the holes. Automatic 2-sided printing is not available for pre-punched paper
- For paper longer than Legal size, make sure the end of the paper is cut perpendicularly. A diagonal cut may cause paper feed problems. Long paper cannot be held in the output tray. Prepare a box or tray to make sure that paper does not fall on the floor. Do not touch paper that is being fed or ejected. It could injure your hand or cause print quality to decline.
- Check the paper package for any additional loading instructions.
- To achieve high-quality printouts with genuine Epson paper, use the paper in the environment stated on the instructions supplied with the paper.
- If you use paper with binder holes, load only one sheet at a time in only these sizes: Letter (8.5 × 11 inches [216 × 279 mm]), A4 (8.3 × 11.7 inches [210 × 297 mm]), A5 (5.8 × 8.2 inches [148 × 210 mm]), A6 (4.1 × 5.8 inches [105 × 148 mm]), B5 (7.2 × 10.1 inches [182 × 257 mm]), or Legal (8.5 × 14 inches [216 × 356 mm]).

[Paper Loading Capacity](#)
[Double-sided Printing Capacity](#)
[Borderless Paper Type Compatibility](#)

Parent topic: [Loading Paper](#)

Related references

[Paper Loading Capacity](#)
[Paper Specifications](#)
[Printable Area Specifications](#)

Related tasks

[Selecting the Default Paper Source Settings](#)

Paper Loading Capacity

See the table here for the loading capacity of the paper cassette.

Paper type	Loading capacity
Plain paper Letterhead	Letter (8.5 × 11 inches [216 × 279 mm]) or A4 (8.3 × 11.7 inches [210 × 297 mm]): 150 sheets
	Legal (8.5 × 14 inches [216 × 356 mm]), Mexico-Oficio (8.5 × 13.4 inches [216 × 340 mm]), Oficio 9 (8.46 × 12.4 inches [215 × 315 mm]), Executive (7.25 × 10.5 inches [184 × 267 mm]), Half Letter (5.5 × 8.5 inches [140 × 216 mm]), A6 (4.1 × 5.8 inches [105 × 148 mm]), or 8.5 × 13 inches (216 × 330 mm): 50 sheets
	User-defined (3.5 × 5 inches to 8.5 × 47.24 inches [89 × 127 mm to 215.9 × 1200 mm]):* 1 sheet
Epson Bright White Pro Paper Epson Bright White Premium Paper Epson Multipurpose Plus Paper	120 sheets
Epson Presentation Paper Matte Epson High Quality Ink Jet Paper	100 sheets

Paper type	Loading capacity
Epson Premium Presentation Paper Matte	20 sheets If paper feeds incorrectly, or printing is uneven or smeared, load 1 sheet at a time.
Epson Ultra Premium Presentation Paper Matte	
Epson Photo Paper Glossy	
Epson Premium Photo Paper Glossy	
Epson Ultra Premium Photo Paper Glossy	
Epson Premium Photo Paper Semi-gloss	
Epson Premium Presentation Paper Matte Double-sided	1 sheet
Epson Brochure & Flyer Paper Matte Double-sided	
Epson Photo Quality Self-adhesive Sheets	
Envelopes	10 envelopes

* Printing from computer only.

Parent topic: [Loading Paper in the Cassette](#)

Related references

[Paper Specifications](#)

Double-sided Printing Capacity

You can print double-sided using Auto or Manual mode on the paper types and sizes listed here.

Paper type	Size	Double-sided printing capacity	
		Auto	Manual
Plain paper Letterhead	Letter (8.5 × 11 inches [216 × 279 mm]), A4 (8.3 × 11.7 inches [210 × 297 mm]), Executive (7.25 × 10.5 inches [184 × 267 mm]), Half Letter (5.5 × 8.5 inches [140 × 216 mm]), or A6 (4.1 × 5.8 inches [105 × 148 mm])	150 sheets	30 sheets
	Legal (8.5 × 14 inches [216 × 356 mm]), Mexico-Oficio (8.5 × 13.4 inches [216 × 340 mm]), Oficio 9 (8.46 × 12.4 inches [215 × 315 mm]), 8.5 × 13 inches (216 × 330 mm), or user-defined (3.5 × 5 inches to 8.5 × 47.24 inches [89 × 127 mm to 215.9 × 1200 mm])*	—	1 sheet
Epson Bright White Pro Paper Epson Bright White Premium Paper Epson Multipurpose Plus Paper	Letter (8.5 × 11 inches [216 × 279 mm])	120 sheets	30 sheets
Epson Premium Presentation Paper Matte Double-sided** Epson Brochure & Flyer Paper Matte Double-sided**	Letter (8.5 × 11 inches [216 × 279 mm])	—	1 sheet

* Printing from computer only.

** Manual 2-sided printing only.

You cannot print double-sided on the following paper types:

- Epson Presentation Paper Matte
- Epson Premium Presentation Paper Matte
- Epson Ultra Premium Presentation Paper Matte
- Epson Photo Paper Glossy
- Epson Premium Photo Paper Glossy
- Epson Premium Photo Paper Semi-gloss
- Epson Ultra Premium Photo Paper Glossy
- Epson High Quality Ink Jet Paper
- Epson Photo Quality Self-adhesive Sheets
- Envelopes

Parent topic: [Loading Paper in the Cassette](#)

Borderless Paper Type Compatibility

You can print borderless photos on compatible paper types in compatible sizes:

Borderless Paper Types

- Epson Bright White Pro Paper
- Epson Multipurpose Plus Paper
- Epson Photo Paper Glossy
- Epson Premium Photo Paper Glossy
- Epson Ultra Premium Photo Paper Glossy
- Epson Premium Photo Paper Semi-gloss
- Epson Presentation Paper Matte
- Epson Premium Presentation Paper Matte
- Epson Ultra Premium Presentation Paper Matte
- Epson Premium Presentation Paper Matte Double-sided
- Epson High Quality Ink Jet Paper

- Epson Brochure & Flyer Paper Matte Double-sided

Borderless Paper Sizes

- 3.5 × 5 inches (89 × 127 mm)
- 4 × 6 inches (102 × 152 mm)
- 5 × 7 inches (127 × 178 mm)
- 8 × 10 inches (203 × 254 mm)
- Letter (8.5 × 11 inches [216 × 279 mm])
- A4 (8.3 × 11.7 inches [210 × 297 mm])

Parent topic: [Loading Paper in the Cassette](#)

Compatible Epson Papers

You can purchase genuine Epson ink, maintenance boxes, and paper at epson.com (U.S. sales) or epson.ca (Canadian sales). You can also purchase supplies from an Epson authorized reseller. To find the nearest one, call 800-GO-EPSON (800-463-7766) in the U.S. or 800-807-7766 in Canada.

Paper Type	Size	Part number	Sheet count
Epson Bright White Pro Paper	Letter (8.5 × 11 inches [216 × 279 mm])	S041586	500
Epson Bright White Premium Paper	Letter (8.5 × 11 inches [216 × 279 mm])	S450218-4	500
Epson Multipurpose Plus Paper	Letter (8.5 × 11 inches [216 × 279 mm])	S450217-4	500
Epson Presentation Paper Matte	Letter (8.5 × 11 inches [216 × 279 mm])	S041062	100
	Legal (8.5 × 14 inches [216 × 356 mm])	S041067	100
Epson Premium Presentation Paper Matte	8 × 10 inches (203 × 254 mm)	S041467	50
	Letter (8.5 × 11 inches [216 × 279 mm])	S041257 S042180	50 100
Epson Premium Presentation Paper Matte Double-sided	Letter (8.5 × 11 inches [216 × 279 mm])	S041568	50

Paper Type	Size	Part number	Sheet count
Epson Ultra Premium Presentation Paper Matte	Letter (8.5 × 11 inches [216 × 279 mm])	S041341	50
Epson Photo Paper Glossy	4 × 6 inches (102 × 152 mm)	S041809	50
		S042038	100
	Letter (8.5 × 11 inches [216 × 279 mm])	S041141	20
		S041649	50
		S041271	100
	A4 (8.3 × 11.7 inches [210 × 297 mm])	S041140	20
Epson Premium Photo Paper Glossy	4 × 6 inches (102 × 152 mm)	S041727	100
	5 × 7 inches (127 × 178 mm)	S041464	20
	8 × 10 inches (203 × 254 mm)	S041465	20
	Letter (8.5 × 11 inches [216 × 279 mm])	S042183	25
		S041667	50
Epson Ultra Premium Photo Paper Glossy	4 × 6 inches (102 × 152 mm)	S042181	60
		S042174	100
	5 × 7 inches (127 × 178 mm)	S041945	20
	8 × 10 inches (203 × 254 mm)	S041946	20
	Letter (8.5 × 11 inches [216 × 279 mm])	S042182	25
		S042175	50
Epson Premium Photo Paper Semi-gloss	4 × 6 inches (102 × 152 mm)	S041982	40
	Letter (8.5 × 11 inches [216 × 279 mm])	S041331	20
Epson High Quality Ink Jet Paper	A4 (8.3 × 11.7 inches [210 × 297 mm])	S041117	100
	Letter (8.5 × 11 inches [216 × 279 mm])	S041111	100

Paper Type	Size	Part number	Sheet count
Epson Photo Quality Self-adhesive Sheets	Letter (8.5 × 11 inches [216 × 279 mm])	S041106	10
Epson Brochure & Flyer Paper Matte Double-sided	Letter (8.5 × 11 inches [216 × 279 mm])	S042384	150

Parent topic: [Loading Paper](#)

Paper or Media Type Settings - Printing Software

For this paper	Select this paper Type or Media Type setting
Plain paper Epson Bright White Pro Paper Epson Bright White Premium Paper Epson Multipurpose Plus Paper Epson Photo Quality Self-adhesive Sheets	Plain Paper / Bright White Paper
Letterhead paper	Letterhead
Envelopes	Envelope
Epson Ultra Premium Photo Paper Glossy	Ultra Premium Photo Paper Glossy
Epson Premium Photo Paper Glossy	Premium Photo Paper Glossy
Epson Photo Paper Glossy	Photo Paper Glossy
Epson Premium Photo Paper Semi-gloss	Premium Photo Paper Semi-Gloss
Epson Presentation Paper Matte	Presentation Paper Matte
Epson Premium Presentation Paper Matte Epson Premium Presentation Paper Matte Double-sided Epson Ultra Premium Presentation Paper Matte	Premium Presentation Paper Matte

Note: The settings listed here are available only when printing from your computer; they do not apply to your product's control panel settings.

Parent topic: [Loading Paper](#)

Selecting the Paper Settings - Control Panel

You can change the default paper size and paper type using the control panel on the product.

1. Press the  home button, if necessary.
2. Select **Settings** > **General Settings** > **Printer Settings** > **Paper Source Settings**.
3. Make sure the **Paper Setup Auto Display** setting is set to **On**.

Note: Disabling this feature turns off the automatic display of the paper settings selection screen after you load paper in the product. If this setting is disabled, you cannot use AirPrint.

4. Select **Paper Setting**.
5. Do one of the following to select your paper settings:
 - Select a **Paper Size** and **Paper Type** setting.
 - Select **Favorite Paper Settings** to select from a list of saved presets.
6. When you are finished, press the  home button to exit.

[Paper Type Settings - Control Panel](#)

Parent topic: [Loading Paper](#)

Paper Type Settings - Control Panel

Select a **Paper Type** setting that matches the paper you loaded.



Paper type loaded	Paper Type setting
Plain paper	Plain Paper
Epson Bright White Pro Paper	
Epson Bright White Premium Paper	
Epson Multipurpose Plus Paper	
Epson Photo Quality Self-adhesive Sheets	
Letterhead paper	Letterhead
Envelopes	Envelope

Paper type loaded	Paper Type setting
Epson Ultra Premium Photo Paper Glossy	Ultra Glossy
Epson Premium Photo Paper Glossy	Prem. Glossy
Epson Photo Paper Glossy	Glossy
Epson Premium Photo Paper Semi-gloss	Prem. Semi-Gloss
Epson Presentation Paper Matte	Presentation Matte
Epson Premium Presentation Paper Matte	Prem. Matte
Epson Premium Presentation Paper Matte Double-sided	

Parent topic: [Selecting the Paper Settings - Control Panel](#)

Selecting the Default Paper Source Settings

You can change default paper source settings using the control panel on the product.

1. Press the  home button, if necessary.
2. Select **Settings** > **General Settings** > **Printer Settings**.
3. Select one of these **Auto Error Solver** options:
 - Turn on this setting to display a warning and print single-sided when a 2-sided printing error occurs, or to print only what the printer could process when a memory full error occurs.
 - Turn off this setting to display an error message and stop printing if an error occurs.
4. Select the **Paper Source Settings** options you want to use.
5. When you are finished, press the  home button to exit.

[Paper Source Settings Options](#)

Parent topic: [Loading Paper](#)

Paper Source Settings Options

Select the paper source options you want to use for your print jobs.

Paper Source Settings option	Available settings	Description
Paper Setting	Various	Select the paper size and type for each paper source
A4/Letter Auto Switching	On	Select On to switch the selected paper size to match the loaded paper (Letter or A4) if the wrong size is selected
	Off	
Error Notice	Paper Size Notice	Select On for either of these settings to display an error message when the selected paper type or size does not match the loaded paper
	Paper Type Notice	
Paper Setup Auto Display	On	Select On to automatically display a menu that lets you select the paper size and type when you load paper in the product
	Off	
		Note: If you disable this setting, you cannot use AirPrint.

Parent topic: [Selecting the Default Paper Source Settings](#)

Selecting the Universal Print Settings

You can change the default universal print settings using the control panel on the product.

1. Press the  home button, if necessary.
2. Select **Settings** > **General Settings** > **Printer Settings** > **Universal Print Settings**.

You see this screen:



3. Adjust the settings as necessary.
4. When you are finished, press the  home button to exit.

[Universal Print Settings Options](#)

Parent topic: [Loading Paper](#)

Universal Print Settings Options

Select the universal print setting options you want to use for your print jobs.

Universal Print Settings option	Available settings	Description
Top Offset	—	Adjust the top or left margin
Left Offset		
Top Offset in Back	—	Adjust the top or left margin of the back page when printing double-sided.
Left Offset in Back		
Check Paper Width	On	Select On to check the paper width before printing. This prevents printing beyond the edges of the paper when the paper size settings are incorrect, but may reduce the printing speed.
	Off	
Skip Blank Page	On	Select On to skip printing of blank pages automatically
	Off	

Parent topic: [Selecting the Universal Print Settings](#)

Placing Originals on the Product

Follow the instructions here to place your original documents or photos on the product.

Caution: Do not place anything on top of your product or use its cover as a writing surface to avoid damaging it.

[Placing Originals on the Scanner Glass](#)

[Placing Originals in the Automatic Document Feeder](#)

Placing Originals on the Scanner Glass

You can place originals up to this size on the scanner glass: Letter (8.5 × 11 inches [216 × 279 mm]) or A4 (8.3 × 11.7 inches [210 × 297 mm]).

Note: To view animated instructions on how to place originals on the scanner glass, press the  help button and select **How To > Place Originals > Scanner Glass**.

Note: When originals are placed in the ADF and on the scanner glass, priority is given to the originals in the ADF.

1. Open the document cover.

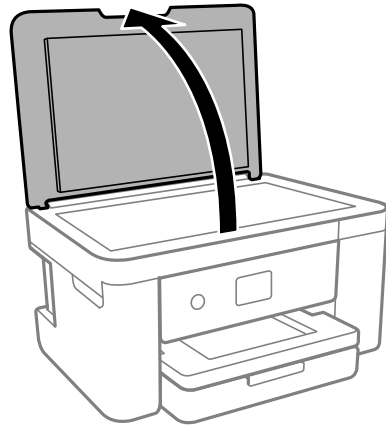

Caution: Be careful not to trap your hand or fingers when opening or closing the document cover.

Note: If there is any dust or dirt on the scanner glass, the scanning range may expand to include it, so the image of the original may be displaced or reduced. Remove any dust and dirt on the scanner glass before scanning.

2. Place your original facedown on the scanner glass with the top facing into the corner. Slide the original to the edges of the indicated corner.

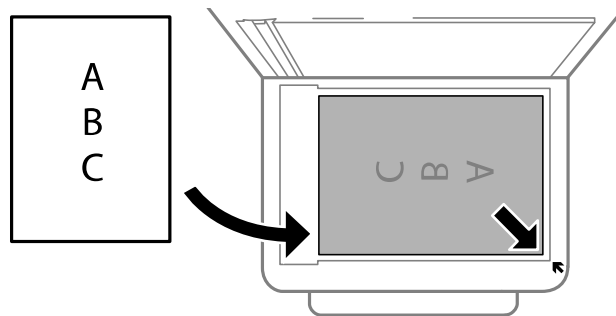

Note: If you are using Epson ScanSmart to scan multiple photos at once, just make sure they are at least 0.2 inch (4.5 mm) away from the edge of the scanner glass and at least 0.8 inch (20 mm) away from each other.

Note: If you are placing an ID card on the scanner glass, position the card 0.19 inch (5 mm) from the corner of the scanner glass.

Note: When placing bulky originals such as books, prevent exterior light from shining directly onto the scanner glass.

3. Close the document cover gently to keep your original in place.

Caution: Do not push down on the document cover or scanner glass or you may damage the product.

Warning: Be careful not to trap your fingers when closing the document cover or you may be injured.

Remove your originals after scanning. If you leave the originals on the scanner glass for a long time, they may stick to the glass surface.

Parent topic: [Placing Originals on the Product](#)

Related topics

[Copying](#)

[Scanning](#)

[Faxing](#)

Placing Originals in the Automatic Document Feeder

You can place single- or multi-page original documents in the Automatic Document Feeder (ADF). Make sure the originals meet the Automatic Document Feeder specifications before loading them.

Caution: Make sure your originals are not creased or folded, and do not contain holes, staples, tape, or other materials that could obstruct the feeder.

Caution: Do not place photographs or valuable artwork in the ADF. Place fragile or valuable originals on the scanner glass to avoid wrinkling or damaging them.

Note: To view animated instructions on how to place originals on the scanner glass, press the ? help button and select **How To > Place Originals > ADF**.

Note: When originals are placed in the ADF and on the scanner glass, priority is given to the originals in the ADF.

1. Open the ADF document support and slide out the ADF output tray extension.

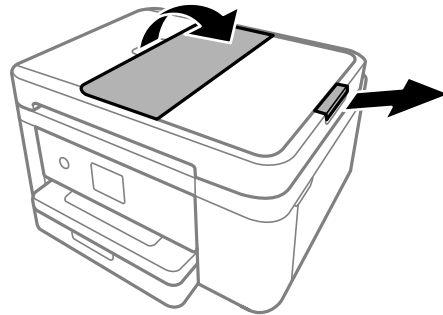

2. Slide the ADF edge guide outward.

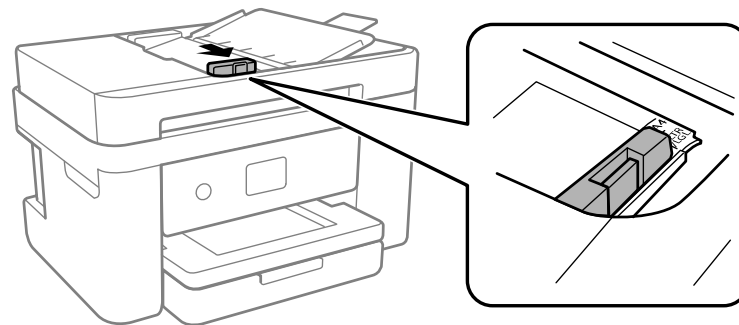

3. Fan your stack of originals and tap them gently on a flat surface to even the edges.

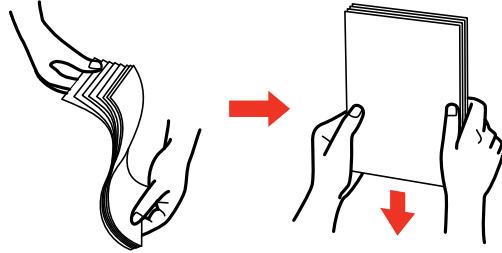

4. Insert the originals into the ADF faceup and short edge first.

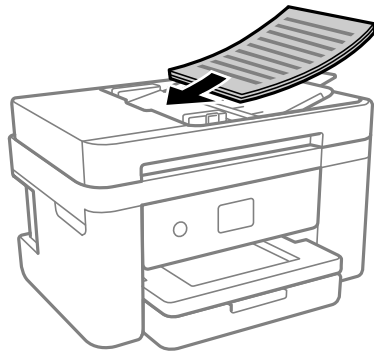

Note: Do not load originals above the arrow mark on the ADF edge guide.

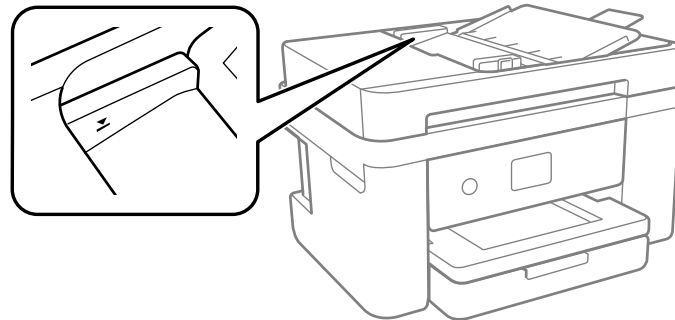

The **ADF** icon on the Copy, Scan, and Fax screens lights up.

- Slide the ADF edge guide against the originals, but not too tightly.

Note: Do not add originals while scanning.

[ADF Original Document Specifications](#)

Parent topic: [Placing Originals on the Product](#)

Related topics

[Copying](#)

[Scanning](#)

[Faxing](#)

ADF Original Document Specifications

You can load original documents that meet these specifications in the ADF.

Paper type	Paper size	Paper weight	Loading capacity
Plain paper	Letter (8.5 × 11 inches [216 × 279 mm])	17 to 24 lb (64 to 95 g/m ²)	Approximately 30 sheets or 0.13 inches (3.3 mm)
	A4 (8.3 × 11.7 inches [210 × 297 mm])		
	Legal (8.5 × 14 inches [216 × 356 mm])		10 sheets
	8.5 × 13 inches (216 × 330 mm)		

Caution: Do not load the following types of originals in the ADF, or they may be damaged or may damage the scanner. Use the scanner glass for these types:

- Photos or valuable original artwork
- Thermal paper
- Originals that are cut irregularly or not right angled
- Originals containing tape, staples, or paper clips
- Originals with carbon paper backing

- Originals that are bound
- Originals with labels, stickers, or sticky notes
- Ripped, curled, folded, deteriorated, or wrinkled originals
- Originals with holes
- Transparencies

Parent topic: [Placing Originals in the Automatic Document Feeder](#)

Related topics

[Copying](#)

[Scanning](#)

[Faxing](#)

Copying

See the information here to copy documents or photos using your product.

Note: Copies may not be exactly the same size as your originals.

[Copying Documents or Photos](#)

[Copying ID Cards or Borderless Photos](#)

[Copying Options](#)

Copying Documents or Photos

You can copy documents or photos onto various sizes and types of paper, including Epson special papers.

1. Place your original document or photo on the scanner glass, or place multi-page documents in the ADF.
2. Load the paper you want to print on.
3. Press the  home button, if necessary.
4. Select **Copy**.
5. Select **B&W** or **Color**.
6. To print more than one copy, select the **+** or **-** icons to increase or decrease the number of copies.

Note: You can also select **Copies** and use the displayed numeric keypad to select the number of copies (up to 99).

7. Change any of the displayed settings as necessary.
8. Select **Advanced Settings** to view and change additional copy settings, if necessary.
9. When you are ready to copy, select the  icon.

Note: The color, size, and border of the scanned image will not be exactly the same as the original. To cancel copying, select .

Parent topic: [Copying](#)

Related references

[Compatible Epson Papers](#)

[Copying Options](#)

[Paper Loading Capacity](#)



Related topics

[Loading Paper](#)

[Placing Originals on the Product](#)

Copying ID Cards or Borderless Photos

You can copy two pages of a book or both sides of an ID card onto a single sheet of paper. You can also copy a photo and print it without any borders.

1. Load the paper you want to print on.
2. Place your original on the scanner glass.
3. Press the  home button, if necessary.
4. Select **Copy**.
5. Select the **Advanced Settings** tab.
6. Enable one of these options:
 - **ID Card Copy**: Scan and copy both sides of an ID card onto one side of the paper.
 - **Borderless Copy**: Copy a photo without margins around the edges.
7. To print more than one copy, select **Copies** and use the displayed numeric keypad to select the number of copies (up to 99).
8. Change any of the displayed settings as necessary.
9. When you are ready to copy, select the  icon.

Note: To cancel copying, select .



Parent topic: [Copying](#)

Copying Options

Select the copying options you want to use for your copies.

Note: Not all options or settings may be available, depending on other copying settings.

Copy

Copying option	Available settings	Description
B&W	—	Copies the document in black and white
Color	—	Copies the document in color
 (2-Sided)	1>1-Sided 1>2-Sided	Select to make 2-sided copies. When you select 1>2-Sided , select the orientation and binding edge for your originals or copies.
 (Density selector)	Varying levels	Adjusts the lightness or darkness of copies

Advanced Settings

Copying option	Available settings	Description
Paper Setting	Various sources	Select the paper source that you want to use. If you select Auto , paper is fed automatically depending on the paper settings you selected for the paper sources.
Reduce/Enlarge	Actual Size	Copies the original at its full size or 100% magnification
	Auto Fit Page	Automatically sizes the image to fit the paper size you selected
	A4->A5 and other conversions	Automatically converts from one size to another
Original Size	Various sizes	Select the document size of your original. When copying non-standard size originals, select the size closest to your original.
Multi-Page	Single Page	Copies each page of the original onto an individual sheet
	2-up	Copies two single-sided originals onto one sheet. Scroll down and select the document orientation and layout order settings as necessary.
Quality	Draft	Adjusts the quality of your copies
	Standard	
	High	

Copying option	Available settings	Description
Original Orientation	Portrait	Specifies the orientation of your originals
	Landscape	
Remove Shadow	Off	Select On to remove the shadows in the background of the original or in the center of booklet copies
	On	
Remove Punch Holes	Off	Select On to remove the binding holes on an original
	On	
ID Card Copy	Off	Select On to copy both sides of an ID card onto one side of a sheet of paper
	On	
Borderless Copy	Off	Copies the original without margins around the edges. The image is enlarged a little to remove margins from the edges of the paper. Select Expansion to adjust the amount to expand the original when printing borderless copies.
	On	
	Standard	
	Medium	
	Minimum	
Clear All Settings	Yes	Restores all copy settings to their defaults
	No	

Parent topic: [Copying](#)

Printing from a Computer

Before printing from your computer, make sure you have set up your product and installed its software as described on the *Start Here* sheet.

Note: If you have an Internet connection, it is a good idea to check for updates to your product software on Epson's support website. If you see a Software Update screen, select **Enable automatic checking** and click **OK**. The update scans your system to see if you have the latest product software. Follow the on-screen instructions. You can also check for updates using Epson Software Updater in the Epson software folder on your computer.

[Printing with Windows](#)

[Printing with the Built-in Epson Driver - Windows 10 S](#)

[Printing on a Mac](#)

[Printing from a Smartphone or Tablet](#)

[Printing with Epson Photo+](#)

[Cancelling Printing Using a Product Button](#)

Printing with Windows

You can print with your product using any Windows application, as described in these sections.

Note: If you are using your Epson product with the Windows 10 S operating system, you cannot use the software described in this section. You also cannot download and install any Epson product software from the Epson website for use with Windows 10 S; you must obtain software only from the Windows Store.

[Selecting Basic Print Settings - Windows](#)

[Selecting Double-sided Printing Settings - Windows](#)

[Selecting Additional Layout and Print Options - Windows](#)

[Selecting a Printing Preset - Windows](#)

[Selecting Extended Settings - Windows](#)

[Printing Your Document or Photo - Windows](#)

[Locking Printer Settings - Windows](#)

[Selecting Default Print Settings - Windows](#)

[Changing Automatic Update Options](#)

Parent topic: [Printing from a Computer](#)

Selecting Basic Print Settings - Windows

Select the basic settings for the document or photo you want to print.

1. Open a photo or document for printing.
2. Select the print command in your application.

Note: You may need to select a print icon on your screen, the **Print** option in the File menu, or another command. See your application's help utility for details.

3. If necessary, select your product name as the printer you want to use.

Note: You may also need to select **Properties** or **Preferences** to view your print settings.

You see the Main tab of your printer settings window:

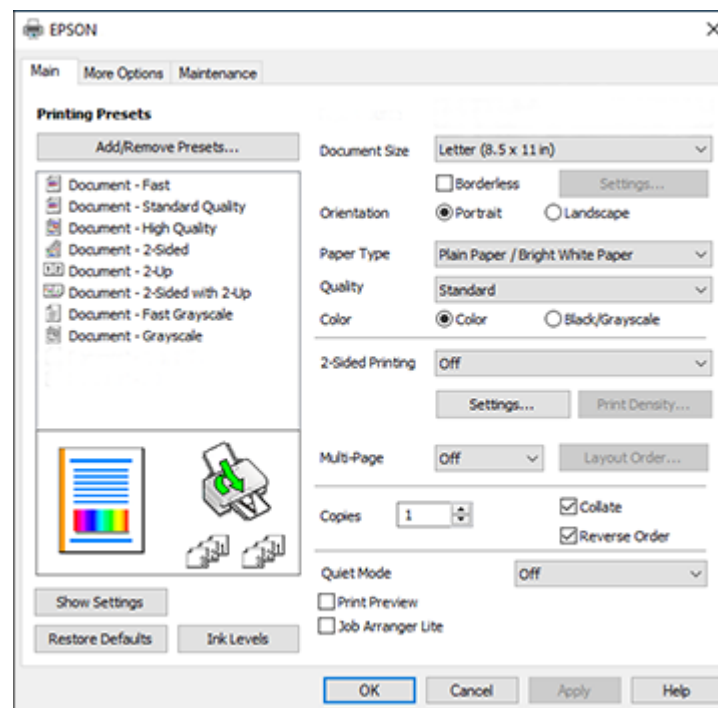

4. Select the size of the paper you loaded as the Document Size setting.

Note: You can also select the **User-Defined** setting to create a custom paper size.

5. If you are printing a borderless photo, select **Borderless**. You can click **Settings** to access additional options for borderless printing.

Note: You must select a compatible borderless paper type and size to print without borders. Check the borderless paper compatibility list for details.

6. Select the orientation of your document.

Note: If you are printing an envelope, select **Landscape**.

7. Select the type of paper you loaded as the Paper Type setting.

Note: The setting may not exactly match the name of your paper. Check the paper type settings list for details.

8. Select the **Quality** setting that matches the print quality you want to use.

9. Select a Color option:

- To print a color document or photo, select the **Color** setting.
- To print text and graphics in black or shades of gray, select the **Black/Grayscale** setting.

10. To print on both sides of the paper, select the **2-Sided Printing** setting and select the options you want.

11. To print multiple pages on one sheet of paper, or print one image on multiple sheets of paper, select one of the settings in the Multi-Page menu and select the printing options you want.

12. To print multiple copies and arrange their print order, select the **Copies** options.

13. To preview your job before printing, select **Print Preview**.

14. To save your print job as a project that can be modified and combined with other print jobs, select **Job Arranger Lite**.

15. To reduce noise during printing when you select **Plain Paper/Bright White Paper**, select **On** in the Quiet Mode menu.

Note: Enabling **Quiet Mode** may reduce printing speed.

[Print Quality Options - Windows](#)

[Multi-Page Printing Options - Windows](#)

Parent topic: [Printing with Windows](#)

Related references

[Paper or Media Type Settings - Printing Software](#)

[Borderless Paper Type Compatibility](#)

Related tasks

[Selecting Double-sided Printing Settings - Windows](#)

[Printing Your Document or Photo - Windows](#)

[Selecting Additional Layout and Print Options - Windows](#)

Print Quality Options - Windows

You can select any of the available Quality options to fine-tune the quality of your print. Some settings may be unavailable, depending on the paper type and border setting you have chosen.

Draft

For draft printing on plain paper.

Standard

For everyday text and image printing.

Standard - Vivid

For text and graphics with good quality and print speed.

High

For photos and graphics with high print quality.

More Settings

Opens a window that lets you choose among levels of speed and quality.

Parent topic: [Selecting Basic Print Settings - Windows](#)

Multi-Page Printing Options - Windows

You can select any of the available options in the Multi-Page menu to set up your multi-page print job.

2-Up, 4-Up, 6-Up, 8-Up, 9-Up, and 16-Up

Prints several pages on one sheet of paper. Click the **Layout Order** button to select page layout and border options.

2×1 Poster, 2×2 Poster, 3×3 Poster, 4×4 Poster

Prints one image on multiple sheets of paper to create a larger poster. Click the **Settings** button to select image layout and guideline options.

Parent topic: [Selecting Basic Print Settings - Windows](#)

Selecting Double-sided Printing Settings - Windows

You can print on both sides of the paper by selecting one of the 2-Sided Printing options on the Main tab.

Note: Some options may be pre-selected or unavailable, depending on other settings you have chosen or if you are accessing the product over a network.

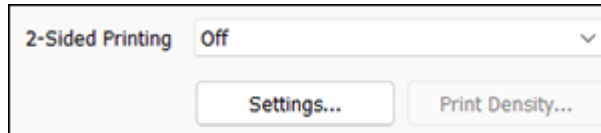

1. Select one of the following options for **2-Sided Printing**:
 - **Auto (Long-edge binding)** to print your double-sided print job by automatically flipping the paper on the long edge.
 - **Auto (Short-edge binding)** to print your double-sided print job by automatically flipping the paper on the short edge.
 - **Manual (Long-edge binding)** to print your double-sided print job by printing one side and prompting you to flip the paper over on the long edge to print the other side (recommended for paper types that do not support automatic duplexing).
 - **Manual (Short-edge binding)** to print your double-sided print job by printing one side and prompting you to flip the paper over on the short edge to print the other side (recommended for paper types that do not support automatic duplexing).
2. Click the **Settings** button.

You see this window:

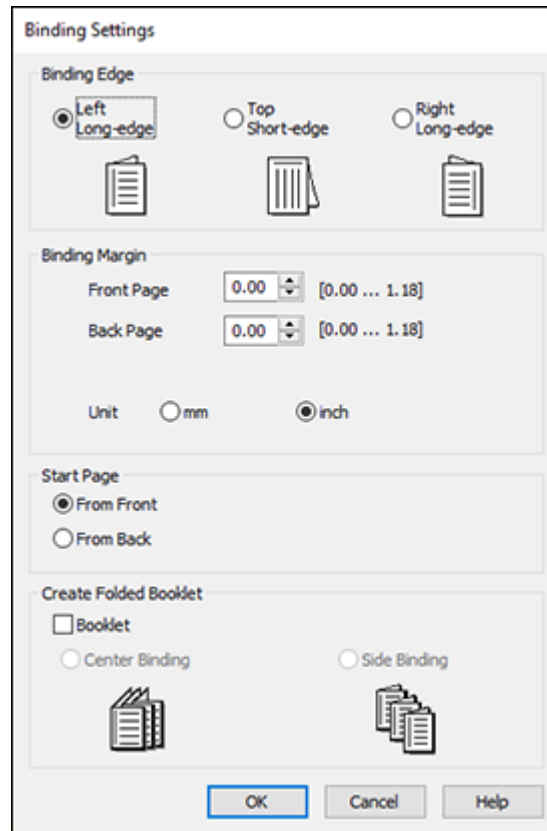

3. Select the double-sided printing options you want to use.
4. Click **OK** to return to the Main tab.
5. Select the type of document you are printing as the Document Type setting. The software automatically sets the Adjustments options for that document type.
6. If necessary, select the Adjustments options you want to use.
7. Click **OK** to return to the Main tab.
8. Print a test copy of your double-sided document to test the selected settings.
9. Follow any instructions displayed on the screen during printing.

[Double-sided Printing Options - Windows](#)

[Print Density Adjustments - Windows](#)

Parent topic: [Printing with Windows](#)

Related references

[Double-sided Printing Capacity](#)

Related tasks

[Selecting Basic Print Settings - Windows](#)

Double-sided Printing Options - Windows

You can select any of the available options on the Binding Settings window to set up your double-sided print job.

Binding Edge Options

Select a setting that orients double-sided print binding in the desired direction.

Binding Margin Options

Select options that define a wider margin to allow for binding.

Start Page

Selects whether printing starts on the front or back page.

Create Folded Booklet Options

Select the **Booklet** checkbox and a binding option to print double-sided pages as a booklet.

Parent topic: [Selecting Double-sided Printing Settings - Windows](#)

Print Density Adjustments - Windows

You can select any of the available options on the Print Density Adjustment window to adjust the print quality of your double-sided print job.

Print Density

Sets the level of ink coverage for double-sided printing.

Increase Ink Drying Time

Sets the amount of time required for drying ink after printing on one side of the paper before printing the other side in double-sided printing to prevent ink smearing.

Parent topic: [Selecting Double-sided Printing Settings - Windows](#)

Selecting Additional Layout and Print Options - Windows

You can select a variety of additional layout and printing options for your document or photo on the **More Options** tab.

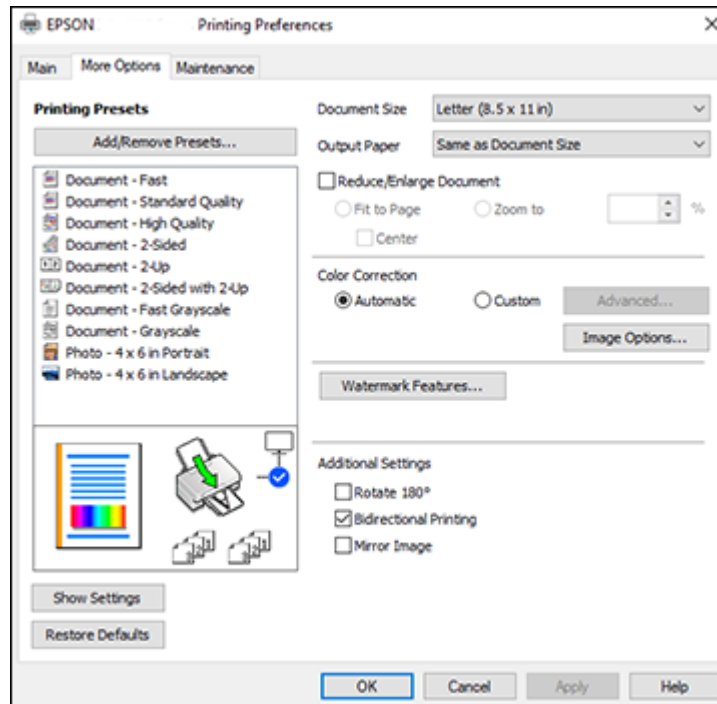

1. To change the size of your printed document or photo, select the **Reduce/Enlarge Document** checkbox and select one of these sizing options:
 - Select the **Fit to Page** option to size your image to fit the paper you loaded. Select the size of your document or photo as the Document Size setting, and the size of your paper as the Output Paper setting. If you want to center your image on the paper, select the **Center** option.
 - Select the **Zoom to** option to reduce or enlarge your document or photo by a specific percentage. Select the percentage in the % menu.
2. Select one of the following Color Correction options:
 - Select **Automatic** to automatically adjust the sharpness, brightness, contrast, and color saturation for your image.

- Select **Custom** and click the **Advanced** button to manually adjust the color correction settings or turn off color management in your printer software.
 - Select **Image Options** to access additional settings for improving printed images.
3. To add the following features, click the **Watermark Features** button:
- **Watermark**: adds a visible watermark to your printout
 - **Header/Footer**: adds information such as the date and time to the top or bottom of your printout

Note: Click the **Settings** button to customize the text and location of the header or footer.

4. Select any of the Additional Settings options to customize your print.

[Custom Color Correction Options - Windows](#)

[Image Options and Additional Settings - Windows](#)

[Header/Footer Settings - Windows](#)

Parent topic: [Printing with Windows](#)

Related tasks

[Printing Your Document or Photo - Windows](#)

Custom Color Correction Options - Windows

You can select any of the available options in the Color Correction window to customize the image colors for your print job.

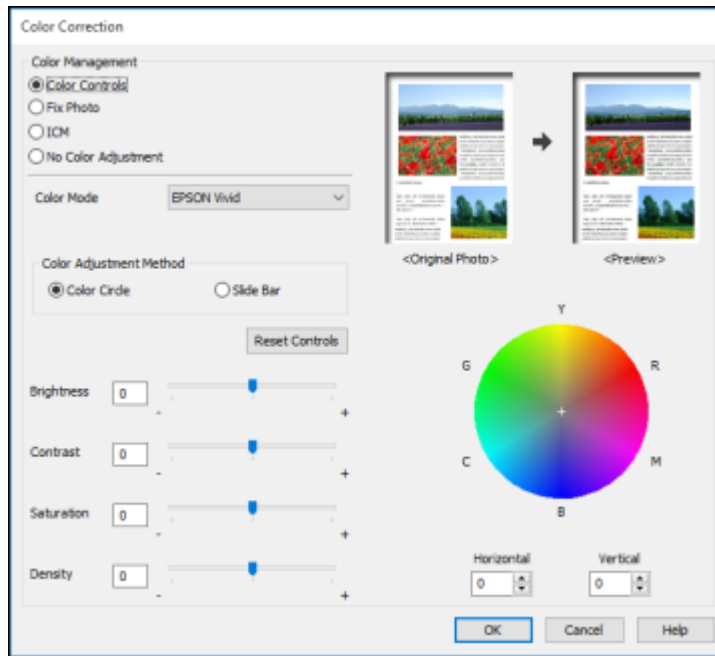

Color Controls

Lets you select a **Color Mode** setting, individual settings for **Brightness**, **Contrast**, **Saturation**, and **Density**, and individual color tones. Depending on the selected color mode, you can also adjust the midtone density using the **Gamma** setting.

Fix Photo

Improves the color, contrast, and sharpness of flawed photos.

Note: Fix Photo uses a sophisticated face recognition technology to optimize photos that include faces. For this to work, both eyes and the nose must be visible in the subject's face. If your photo includes a face with an intentional color cast, such as a statue, you may want to turn off **Fix Photo** to retain the special color effects.

ICM

Lets you manage color using installed color printing profiles.

No Color Adjustment

Turns off color management in your printer software so you can manage color using only your application software.

Parent topic: [Selecting Additional Layout and Print Options - Windows](#)

Image Options and Additional Settings - Windows

You can select any of the Image Options and Additional Settings to customize your print. Some options may be pre-selected or unavailable, depending on other settings you have chosen.

Image Options**Emphasize Text**

Adjusts the weight of printed text to increase readability.

Emphasize Thin Lines

Adjusts the weight of printed lines to increase visibility.

Edge Smoothing

Smooths jagged edges in low-resolution images such as screen captures or images from the Web.

Fix Red-Eye

Reduces or removes red-eye in photos.

Print Text in Black

Prints colored text in black.

For Color Text

Prints colored text on a background pattern or underlined.

For Color Graphs and Images

Prints colored graphics and images with overlay patterns.

For Color Text, Graphs, and Images

Prints colored text, graphics, and images with overlay patterns.

Enhancement Options

Specifies Color Universal Print enhancement settings for text, graphics, and images.

Additional Settings Options**Rotate 180°**

Prints the image rotated 180° from its original orientation.

Bidirectional Printing

Prints in both directions (right-to-left and left-to-right), speeding up printing, but may reduce print quality.

Mirror Image

Flips the printed image left to right.

Parent topic: [Selecting Additional Layout and Print Options - Windows](#)

Header/Footer Settings - Windows

You can select any of the Header/Footer Settings options to add headers or footers when you print. The items are available to print at the top or bottom of your pages, in either the left, right, or center of the page.

Note: These settings are not saved with your document.

Header/Footer Settings

Top Left	Top Center	Top Right
User Name	None	Date/Time
Bottom Left	Bottom Center	Bottom Right
None	None	None

Starting number: 1

Start printing on page: 1

Text:

Color: Black

Font: Arial

Size: 11 pt [6 ... 72]

Style: Bold, Italic

Reset Defaults OK Cancel Help

You can select to print the following information:

- User Name
- Computer Name
- Date
- Date/Time
- Document Name
- Collate Number
- Page Number
- Text

You can also adjust the text settings for the printed information.

Note: The user name, computer name, date, and time come from the Windows Control Panel on your computer.

Parent topic: [Selecting Additional Layout and Print Options - Windows](#)

Selecting a Printing Preset - Windows

For quick access to common groups of print settings, you can select a printing preset on the **Main** or **More Options** tab.

Note: You can create your own preset by clicking the **Add/Remove Presets** button.

1. Click the **Main** or **More Options** tab.

You see the available **Printing Presets** on the left:

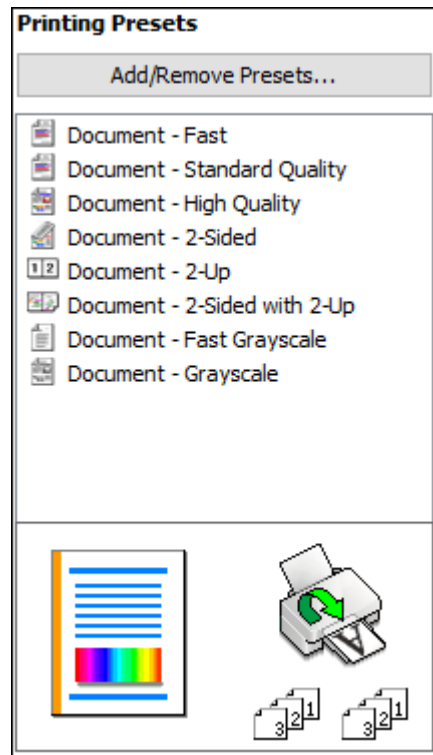



2. Place your cursor over one of the **Printing Presets** to view its list of settings.
3. Click on a preset to change its settings or delete it, or use any of the available options on the screen to control your printing presets.
4. To choose a preset for printing, select it.
5. Click **OK**.

Parent topic: [Printing with Windows](#)

Selecting Extended Settings - Windows

You can select additional settings that apply to all the print jobs you send to your product.

1. Access the Windows Desktop and right-click the  icon for your product in the right side of the Windows taskbar, or click the up arrow and right-click .
2. Select **Printer Settings**.
3. Click the **Maintenance** tab.

You see the maintenance options:

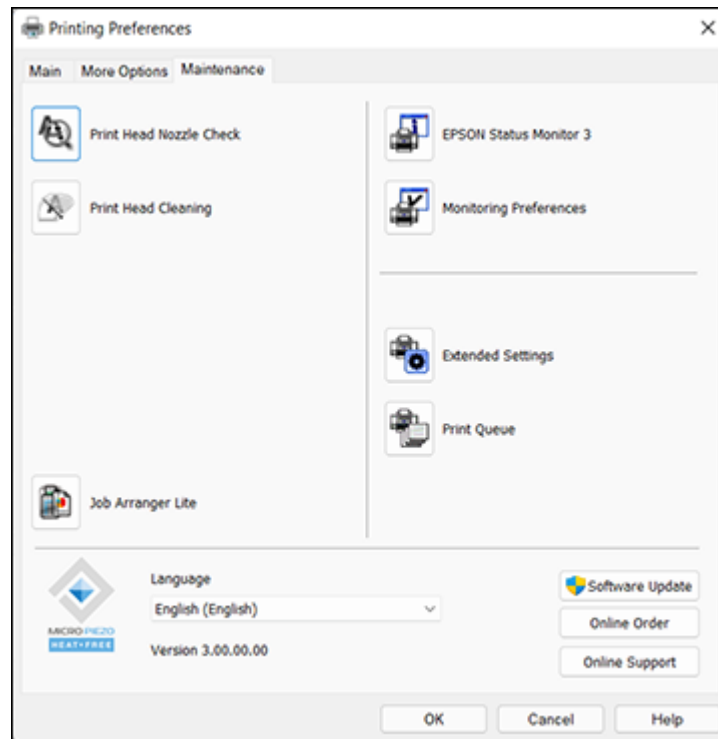

4. Click the **Extended Settings** button.

You see this window:

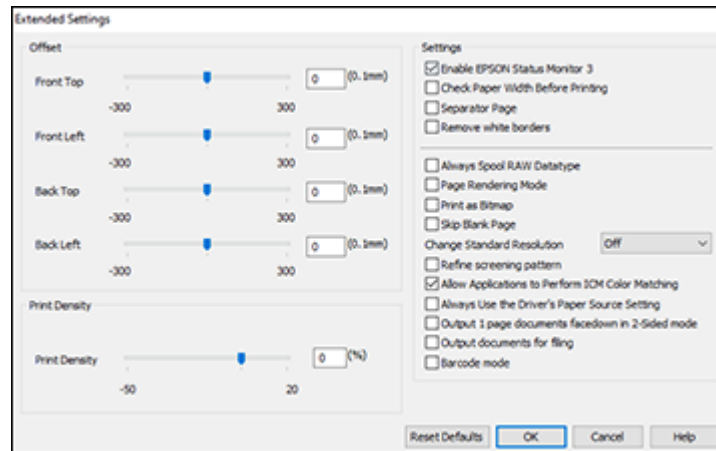

5. Select any of the extended settings to customize your print.
6. Click **OK** to close the Extended Settings window.
7. Click **OK** to close the printer software window.

[Extended Settings - Windows](#)

Parent topic: [Printing with Windows](#)

Extended Settings - Windows

You can select these settings on the Extended Settings window.

Enable EPSON Status Monitor 3

Enables product monitoring for ink and paper supplies and other issues.

Check Paper Width Before Printing

Prevents printing beyond the edges of the paper if the paper size setting is incorrect; may reduce print speed.

Separator Page

Before each document, prints a separator page containing the title, user, date, and time.

Remove white borders

Removes white margins that may appear when you print borderless photos.

Always Spool RAW Datatype

Increases print speed and may solve other printing problems.

Page Rendering Mode

Increases print speed when printing is extremely slow or the print head stops during printing.

Print as Bitmap

Increases print speed when printing is extremely slow or the print head stops during printing, and other settings do not help.

Skip Blank Page

Ensures that your product does not print pages that contain no text or images.

Change Standard Resolution

Reduces the resolution of print data to correct printing problems.

Refine screening pattern

Prints graphics with a finer screening pattern.

Allow Applications to Perform ICM Color Matching

Allows applications to perform ICM color matching.

Always Use the Driver's Paper Source Setting

Prints using the paper source setting in the printer driver, rather than the setting in your application.

Output 1 page documents facedown in 2-Sided mode

Outputs single-sided pages in a 2-sided print job facedown instead of faceup.

Output documents for filing

Outputs all landscape, portrait, 1-sided, and 2-sided documents in the same orientation for easier filing.

Barcode mode

Reduces bleeding when printing barcodes on plain paper, letterhead paper, recycled paper, preprinted paper, envelopes, and thick paper.

Parent topic: [Selecting Extended Settings - Windows](#)

Printing Your Document or Photo - Windows

Once you have selected your print settings, you are ready to save your settings and print.

1. Click **OK** to save your settings.

You see your application's Print window, such as this one:

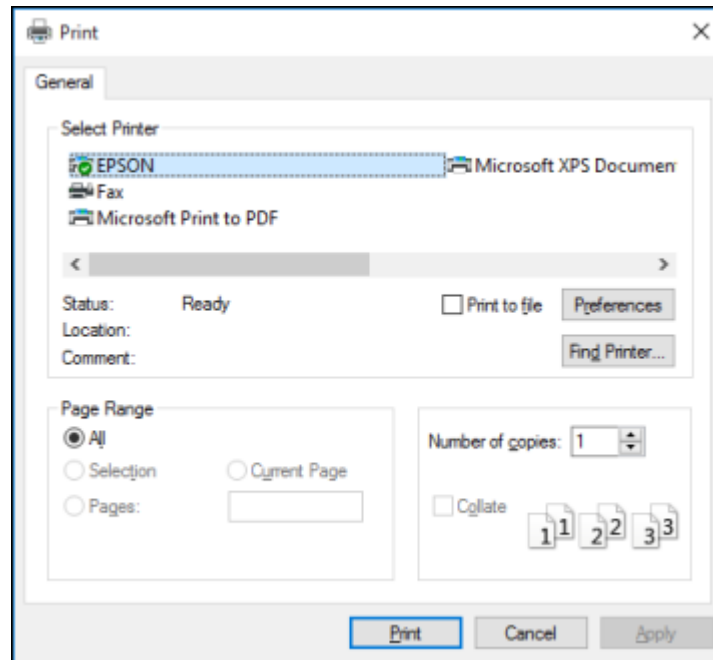

2. Click **OK** or **Print** to start printing.

[Checking Print Status - Windows](#)

Parent topic: [Printing with Windows](#)

Related tasks

[Selecting Basic Print Settings - Windows](#)

Checking Print Status - Windows

During printing, you see this window showing the progress of your print job. It allows you to control printing and check ink cartridge status.

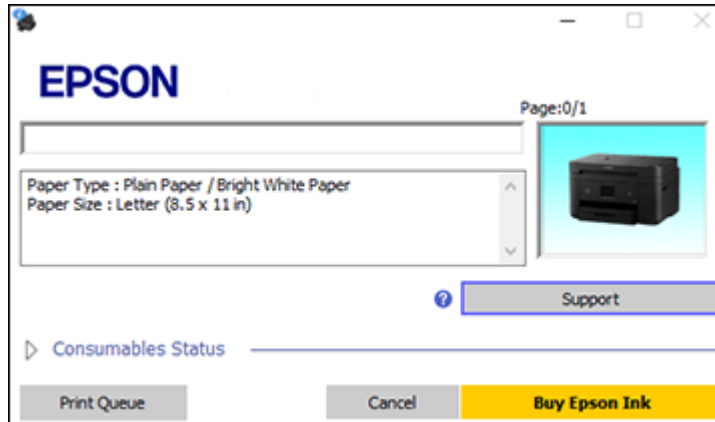





- To cancel printing, click **Cancel**.
- To see print jobs waiting to print, click **Print Queue**.
- To check ink status, click **Consumables Status**.

Parent topic: [Printing Your Document or Photo - Windows](#)

Locking Printer Settings - Windows

Windows administrators can lock access to some printer settings to prevent unauthorized changes.

1. Do one of the following:

- **Windows 11:** Click , search for **Settings** and select it. Select **Bluetooth & devices > Printers & scanners**. Select your product name and select **Printer properties**.
- **Windows 10:** Click , and select  (Settings) > **Devices > Printers & scanners**. Select your product name and select **Manage > Printer properties**.
- **Windows 8.x:** Navigate to the **Apps** screen and select **Control Panel > Hardware and Sound > Devices and Printers**. Right-click your product and select **Printer properties**.
- **Windows 7:** Click  and select **Devices and Printers**. Right-click your product and select **Printer properties**.

- **Windows Vista:** Click  and select **Control Panel**. Click **Printer** under **Hardware and Sound**, then right-click your product and select **Properties**.
2. Click the **Optional Settings** tab.

Note: You can prevent access to the **Optional Settings** tab by changing the user or group permissions in the **Security** tab.

3. Click **Driver Settings**.

You see this window:

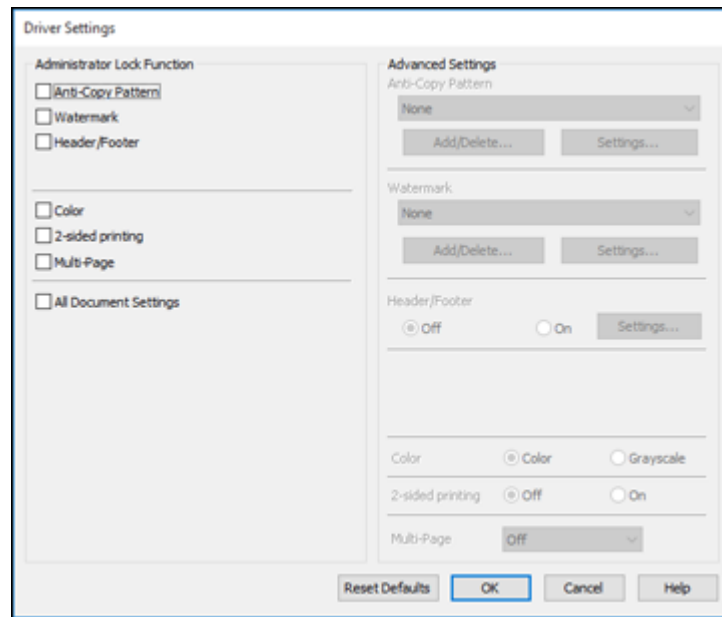

4. Select the checkbox for each setting you want to lock. To lock all print settings, select **All Document Settings**.
5. Under **Advanced Settings**, select the setting option you want to use for each locked setting.
6. Click **OK**.

[Locked Setting Options](#)

Parent topic: [Printing with Windows](#)

Locked Setting Options

Select the options you want to use for any locked print settings.



Setting	Options	Description
Anti-Copy Pattern	Various data items	Lets you select the data to use for the pattern or prohibit anti-copy patterns
	Add/Delete	Lets you add or delete a customized anti-copy pattern
	Settings	Lets you select the arrangement, size, and other settings for the custom anti-copy pattern
Watermark	Various text watermarks	Lets you select the text for the watermark or prohibit watermarks
	Add/Delete	Lets you add or delete a customized text or image-based watermark
	Settings	Lets you select the size, position, and other watermark settings
Header/Footer	Off	Prohibits headers or footers
	On	Allows headers and footers
	Settings	Lets you select the text and position for printing headers and footers
Color	Color	Allows color printing
	Grayscale	Allows printing in black or shades of gray only
2-sided printing	Off	Allows printing on one side of the paper only
	On	Allows printing on both sides of the paper
Multi-Page	Off	Prohibits multi-page settings
	2-Up	Allows printing of 2 pages on one sheet of paper
	4-Up	Allows printing of 4 pages on one sheet of paper
	6-Up	Allows printing of 6 pages on one sheet of paper
	8-Up	Allows printing of 8 pages on one sheet of paper
	9-Up	Allows printing of 9 pages on one sheet of paper
	16-Up	Allows printing of 16 pages on one sheet of paper

Setting	Options	Description
All Document Settings	—	Lets you lock all print settings

Parent topic: [Locking Printer Settings - Windows](#)

Selecting Default Print Settings - Windows

When you change your print settings in a program, the changes apply only while you are printing in that program session. If you want to change the print settings you use in all your Windows programs, you can select new default print settings.

1. Access the Windows Desktop and right-click the  icon for your product in the right side of the Windows taskbar, or click the up arrow and right-click .
2. Select **Printer Settings**.

You see the printer settings window:

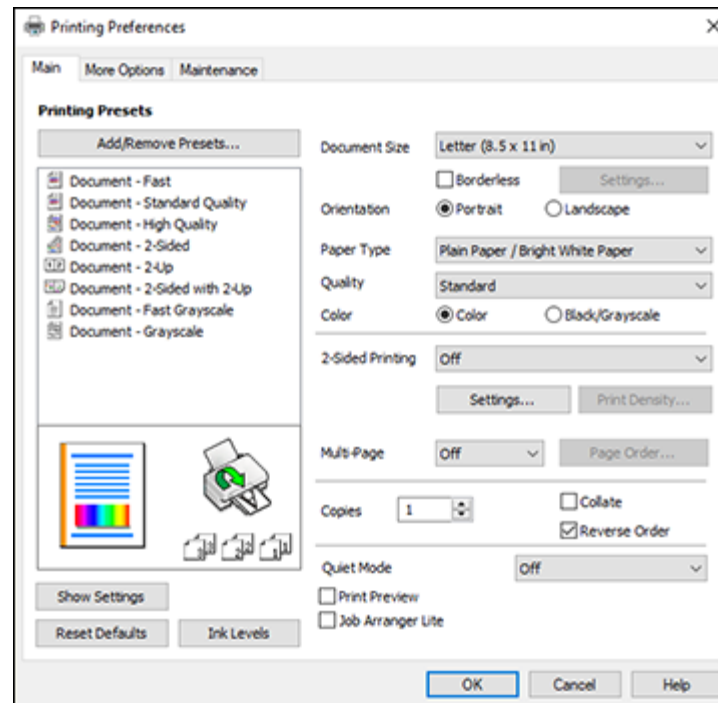

3. Select the print settings you want to use as defaults in all your Windows programs.
4. Click **OK**.



These settings are now the defaults selected for printing. You can still change them as needed for printing in any program session.

[Changing the Language of the Printer Software Screens](#)

Parent topic: [Printing with Windows](#)

Changing the Language of the Printer Software Screens

You can change the language used on the Windows printer software screens.

1. Access the Windows Desktop and right-click the  icon for your product in the right side of the Windows taskbar, or click the up arrow and right-click .
2. Select **Printer Settings**.
You see the printer settings window.
3. Click the **Maintenance** tab.

You see the maintenance options:

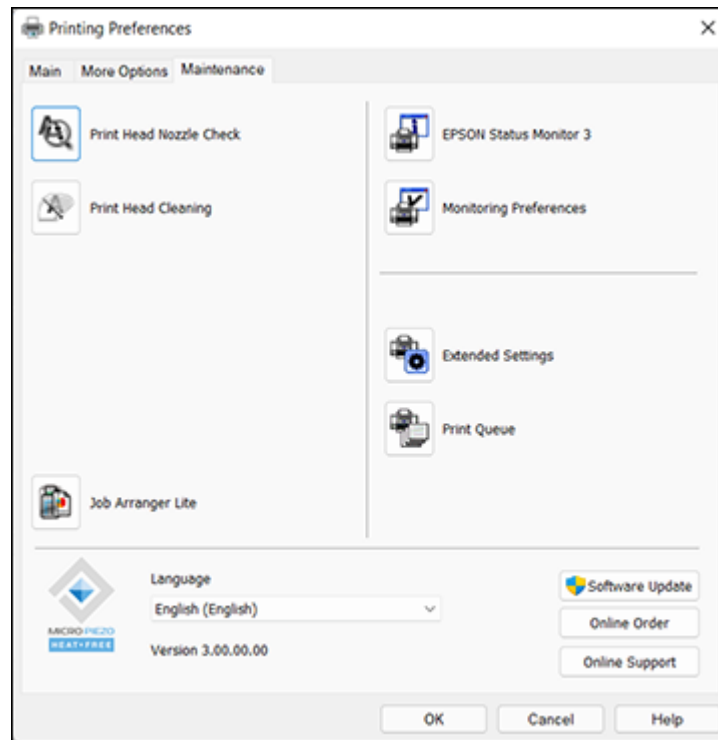



4. Select the language you want to use as the **Language** setting.
5. Click **OK** to close the printer software window.

The printer software screens appear in the language you selected the next time you access them.

Parent topic: [Selecting Default Print Settings - Windows](#)

Changing Automatic Update Options

Your printer software for Windows automatically checks for updates to the product software. You can change how often the software checks for updates or disable this feature.

1. Access the Windows Desktop and right-click the  icon for your product in the right side of the Windows taskbar, or click the up arrow and right-click .

2. Select **Software Update Settings**.

You see this window:

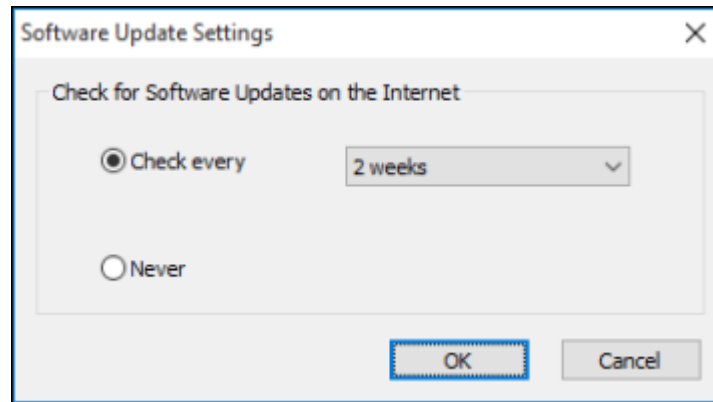

3. Do one of the following:
 - To change how often the software checks for updates, select a setting in the **Check every** menu.
 - To disable the automatic update feature, select the **Never** option.
4. Click **OK** to exit.

Note: If you choose to disable the automatic update feature, you can check for updates manually.

Parent topic: [Printing with Windows](#)

Related tasks

[Checking for Software Updates](#)

Printing with the Built-in Epson Driver - Windows 10 S

You can print with the built-in Epson printer driver using any printing program on Windows 10 S, as described in these sections.

Note: The built-in Epson driver in Windows 10 S does not include all the available print settings for your product. To print with additional settings, download and install the Epson Print and Scan utility from the Windows Store. You cannot download and install any Epson product software from the Epson website for use with Windows 10 S; you must obtain software only from the Windows Store.

Selecting Print Settings - Windows 10 S

Parent topic: [Printing from a Computer](#)

Selecting Print Settings - Windows 10 S

Select the settings for your print job in your Windows 10 S application.

1. Open a photo or document for printing.
2. Select the print command in your application.

Note: You may need to select a print icon on your screen, the **Print** option in the **File** menu, or another command. See your application's help utility for details.

3. If necessary, select your product name as the printer you want to use.

Note: You may also need to select **Properties** or **Preferences** to view your print settings.

You see a window like this:

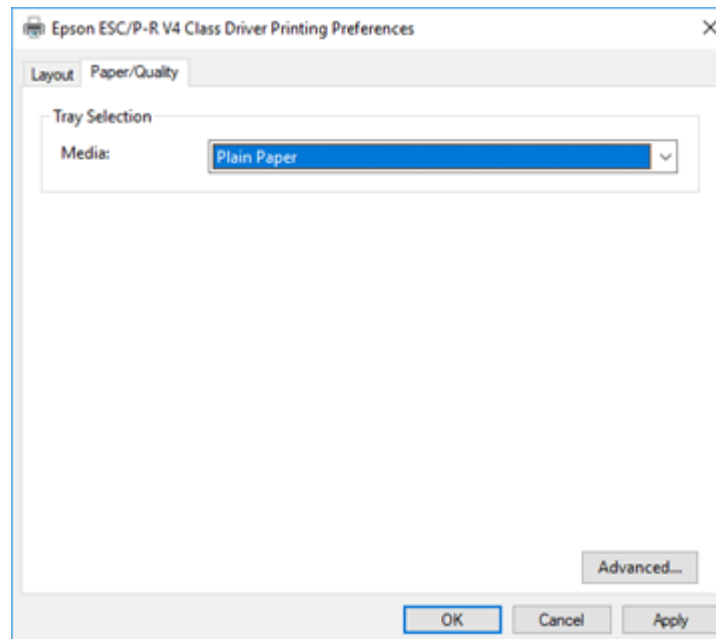

4. Select the type of paper you loaded as the **Media** setting.

Note: The setting may not exactly match the name of your paper. Check the paper type settings list for details.

5. Click the **Advanced** button.

You see a window like this:

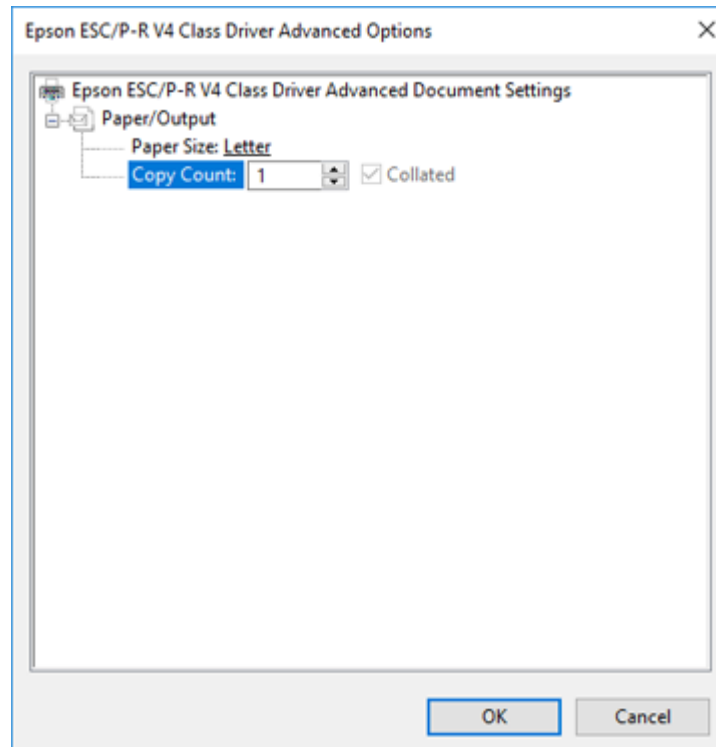

6. Select the size of the paper you loaded as the **Paper Size** setting.
7. To print multiple copies, select or enter the number as the **Copy Count** setting.
8. To print multiple copies of multi-page documents in sets, select the **Collated** checkbox.
9. Click **OK**.

You return to the printing preferences window.

10. Select the **Layout** tab.

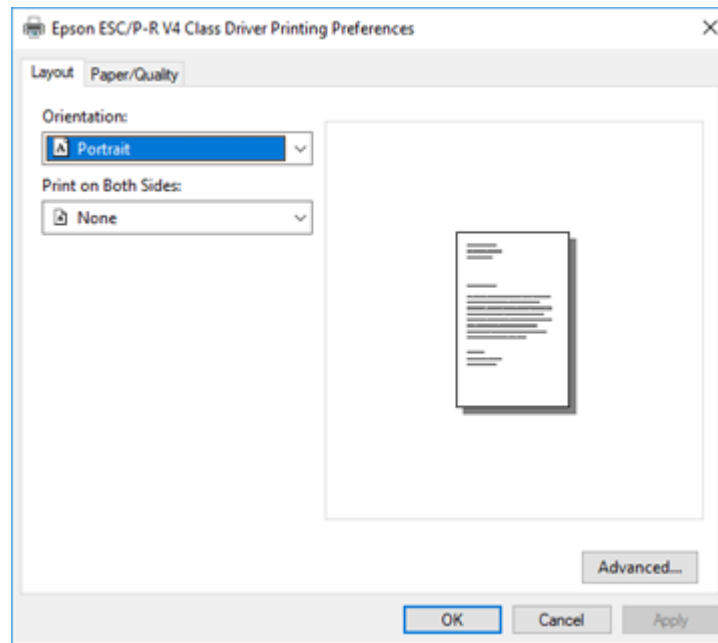

11. Select the orientation of your document as the **Orientation** setting.

- To print double-sided, select one of the **Print on Both Sides** options, depending on how you want to orient the page layout. The icon next to each option shows the layout.

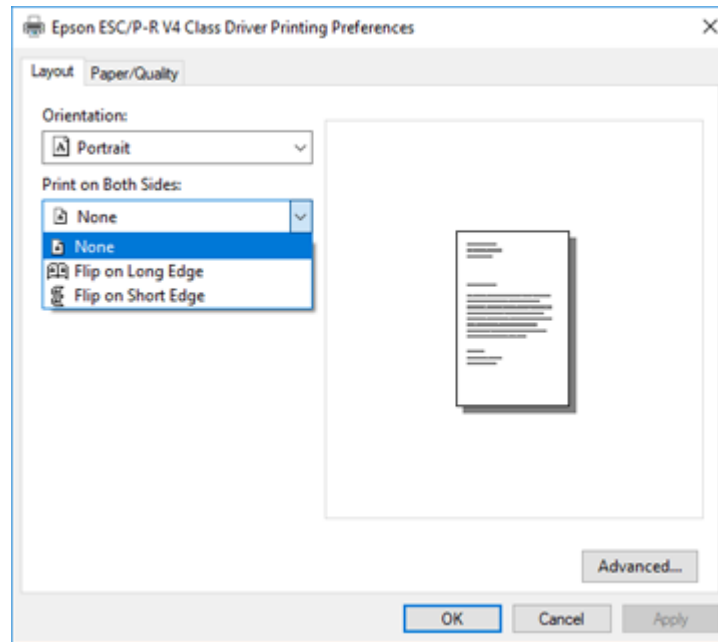

- Click **OK** to save your settings.

You see your application's **Print** window.

- Click **OK** or **Print** to start printing.

Parent topic: [Printing with the Built-in Epson Driver - Windows 10 S](#)

Printing on a Mac

You can print with your product using any Mac printing program, as described in these sections.

Note: If you have an Internet connection, it is a good idea to check for updates to your product software on Epson's support website or using Epson Software Updater.

[Selecting Basic Print Settings - Mac](#)

[Selecting Page Setup Settings - Mac](#)

- [Selecting Print Layout Options - Mac](#)
- [Selecting Double-sided Printing Settings - Mac](#)
- [Managing Color - Mac](#)
- [Selecting Printing Preferences - Mac](#)
- [Printing Your Document or Photo - Mac](#)

Parent topic: [Printing from a Computer](#)

Related tasks

- [Checking for Software Updates](#)

Selecting Basic Print Settings - Mac

Select the basic settings for the document or photo you want to print.

1. Open a photo or document for printing.
2. Select the print command in your application.

Note: You may need to select a print icon on your screen, the **Print** option in the File menu, or another command. See your application's help utility for details.

3. Select your product as the **Printer** setting.



4. If necessary, click the **Show Details** button to expand the print window.

You see the expanded printer settings window for your product:

Printer: EPSON

Presets: Default Settings

Copies: 1

Pages: All
 From: 1 to: 1

Paper Size: US Letter 8.50 by 11.00 inches

Orientation: Portrait Landscape

Preview

Auto Rotate

Scale: 46%

Scale to Fit: Print Entire Image
 Fill Entire Paper

Copies per page: 1

PDF Cancel Print

Note: The print window may look different, depending on the Mac OS version and the application you are using.

5. Select the **Copies** and **Pages** settings as necessary.

Note: If you do not see these settings in the print window, check for them in your application before printing.

6. Select the page setup options: **Paper Size** and **Orientation**.

Note: If you do not see these settings in the print window, check for them in your application before printing. They may be accessible by selecting **Page Setup** from the File menu.

Note: Paper sizes may include additional options such as **Borderless**.

7. Select any application-specific settings that appear on the screen, such as those shown in the image above for the Preview application.
8. Select **Print Settings** or **Printer Features** from the pop-up menu.

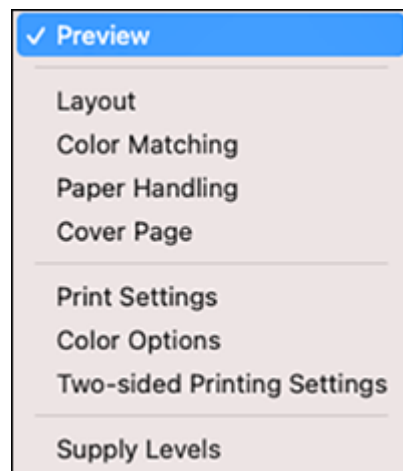

You see these settings:

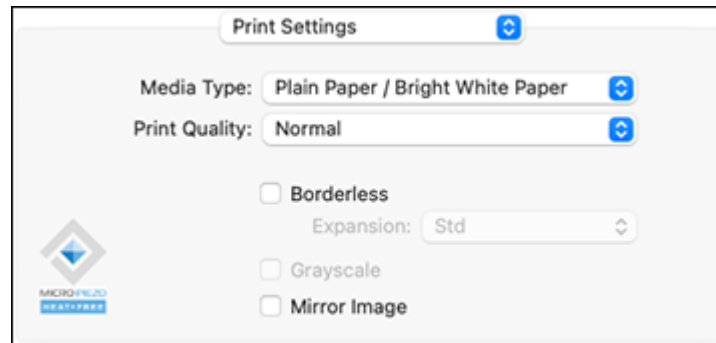

Note: The available print settings and appearance of the print window may be different than those covered here, depending on the Mac OS version and the application you are using.

9. Select the type of paper you loaded as the **Media Type** setting.

Note: The setting may not exactly match the name of your paper. Check the paper type settings list for details.

10. Select the **Print Quality** setting you want to use.
11. Select the **Borderless** checkbox if you want to print a borderless photo. If the option is grayed out, change the **Media Type** setting to a paper type that supports borderless printing.
12. Select any of the available print options.

[Print Quality Options - Mac](#)

[Print Options - Mac](#)

Parent topic: [Printing on a Mac](#)

Related references

[Paper or Media Type Settings - Printing Software](#)

Related tasks

[Selecting Print Layout Options - Mac](#)

[Selecting Page Setup Settings - Mac](#)

[Selecting Double-sided Printing Settings - Mac](#)

[Managing Color - Mac](#)

[Printing Your Document or Photo - Mac](#)

Print Quality Options - Mac

You can select any of the available Print Quality options to fine-tune the quality of your print. Some settings may be unavailable, depending on the paper type setting you have chosen.

Draft

For draft printing on plain paper.

Normal

For everyday text and image printing.

Normal - Vivid

For everyday text and image printing with good quality and print speed.

Fine

For text and graphics with good quality and print speed.

Quality

For text and graphics with increased quality and print speed.

Parent topic: [Selecting Basic Print Settings - Mac](#)

Print Options - Mac

You can select any of the print options to customize your print. Some options may be unavailable, depending on other settings you have chosen.

Expansion

If you selected a borderless paper size setting, this option adjusts the image expansion settings to control printing at the edges of borderless prints.

Grayscale

Prints text and graphics in black or shades of gray.

Mirror Image

Lets you flip the printed image horizontally.

Note: If you select the **Min** option for the Expansion setting, you may see white borders on your printed photo.

Parent topic: [Selecting Basic Print Settings - Mac](#)

Selecting Page Setup Settings - Mac

Depending on your application, you may be able to select the paper size and orientation settings from the print window.

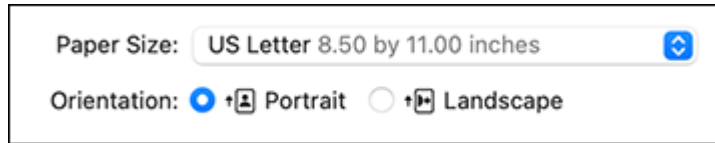

Note: If you do not see these settings in the print window, check for them in your application before printing. They may be accessible by selecting **Page Setup** from the File menu.

1. Select the size of the paper you loaded as the **Paper Size** setting. If you are printing a borderless photo, select the **Borderless** checkbox or a paper size with a **Borderless** option. You can also select a custom setting to create a custom paper size, but the Quality setting will be limited to **Normal**.

Note: You must select a compatible borderless paper type and size to print without borders. Check the borderless paper compatibility list for details.

2. Select the orientation of your document or photo as shown in the print window.

Note: If you are printing an envelope, select the  icon.

Note: You can reduce or enlarge the size of the printed image by selecting **Paper Handling** from the pop-up menu and selecting a scaling option.

Parent topic: [Printing on a Mac](#)

Selecting Print Layout Options - Mac

You can select a variety of layout options for your document or photo by selecting **Layout** from the pop-up menu on the print window.

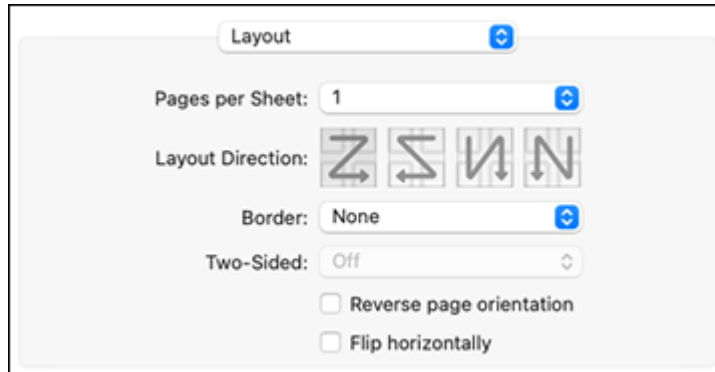

- To print multiple pages on one sheet of paper, select the number of pages in the **Pages per Sheet** pop-up menu. To arrange the print order of the pages, select a **Layout Direction** setting.
- To print borders around each page on the sheet, select a line setting from the **Border** pop-up menu.
- To print on both sides of each page, select a setting from the **Two-Sided** pop-up menu.
- To invert or flip the printed image, select the **Reverse page orientation** or **Flip horizontally** settings.

Parent topic: [Printing on a Mac](#)

Selecting Double-sided Printing Settings - Mac

You can print on both sides of the paper by selecting **Two-sided Printing Settings** from the pop-up menu on the print window.

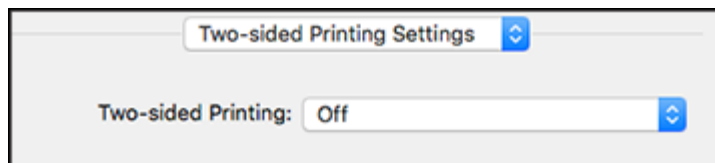

Note: Some options may be pre-selected or unavailable, depending on other settings you have chosen or if you are accessing the product over a network. This screen may be different, depending on the Mac OS version you are using.

1. Select one of the **Two-sided Printing** options.
2. Select the type of document you are printing as the **Document Type** setting. The software automatically sets the Adjustments options for that document type.

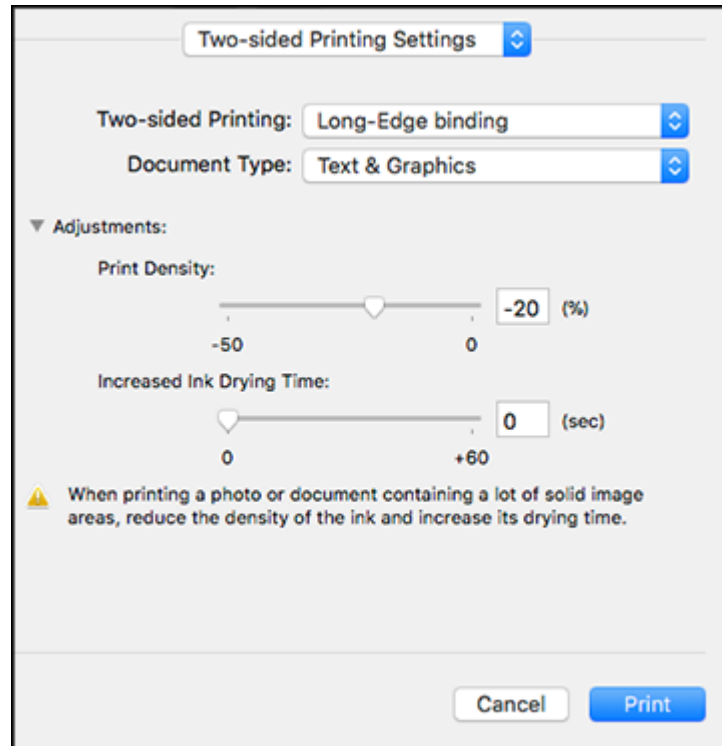

3. If necessary, customize the Adjustments settings as instructed on the screen.
4. Print a test copy of your double-sided document to test the selected settings.
5. Follow any instructions displayed on the screen during printing.

[Double-sided Printing Options and Adjustments - Mac](#)

Parent topic: [Printing on a Mac](#)

Double-sided Printing Options and Adjustments - Mac

You can select any of the available options in the **Two-sided Printing Settings** pop-up menu to set up your double-sided print job.

Long-Edge binding

Orients double-sided printed pages to be bound on the long edge of the paper.

Short-Edge binding

Orients double-sided printed pages to be bound on the short edge of the paper.

Print Density

Sets the level of ink coverage for double-sided printing.

Increased Ink Drying Time

Sets the amount of time required for drying ink after printing on one side of the paper before printing the other side in double-sided printing.

Parent topic: [Selecting Double-sided Printing Settings - Mac](#)

Managing Color - Mac

You can adjust the Color Matching and Color Options settings to fine-tune the colors in your printout or turn off color management in your printer software.

1. Select **Color Matching** from the pop-up menu in the print window.

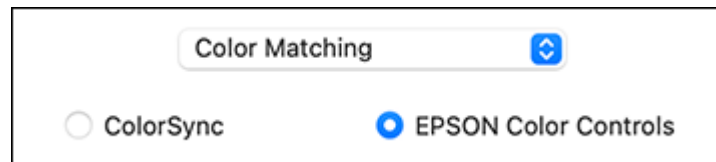

2. Select one of the available options.

3. Select **Color Options** from the pop-up menu in the print window.

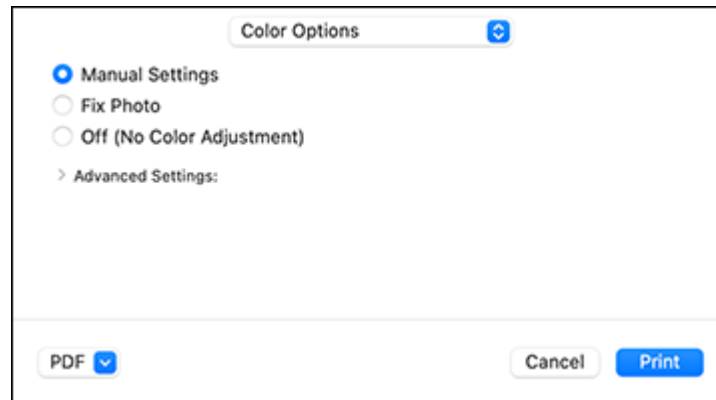

Note: The available settings on the Color Options menu depend on the option you selected on the Color Matching menu.

4. Select one of the available options.

[Color Matching and Color Options - Mac](#)

Parent topic: [Printing on a Mac](#)

Color Matching and Color Options - Mac

You can select these settings on the **Color Matching** and **Color Options** menus.

Color Matching Settings

EPSON Color Controls

Lets you manage color using controls in your printer driver or turn off color management.

ColorSync

Prints using standard color profiles for your product and paper to help match image colors. You can customize the conversion method and filter settings on the ColorSync pop-up menu in the print window.

Color Options Settings

Manual Settings

Lets you select manual color adjustments. Click the arrow next to **Advanced Settings** and select settings for **Brightness**, **Contrast**, **Saturation**, and individual color tones. You can also select a color

Mode setting for printing photos and graphics and the **Fix Red-Eye** setting to reduce or remove red-eye in photos. Depending on the selected color mode, you can also adjust the midtone density using the **Gamma** setting.

Fix Photo

Improves the color, contrast, and sharpness of flawed photos. Click the arrow next to **Advanced Settings** and select the **Fix Red-Eye** setting to reduce or remove red-eye in photos.

Note: Fix Photo uses a sophisticated face recognition technology to optimize photos that include faces. For this to work, both eyes and the nose must be visible in the subject's face. If your photo includes a face with an intentional color cast, such as a statue, you may want to turn off **Fix Photo** to retain the special color effects.

Off (No Color Adjustment)

Turns off color management in your printer software so you can manage color using only your application software.

Note: An ICC profile is required if color management is turned off.

Parent topic: [Managing Color - Mac](#)

Selecting Printing Preferences - Mac

You can select printing preferences that apply to all the print jobs you send to your product.

1. In the Apple menu or the Dock, select **System Preferences**.
2. Select **Print & Fax**, **Print & Scan**, or **Printers & Scanners**, select your product, and select **Options & Supplies**.
3. Select **Driver** or **Options**.

You see a screen like this:

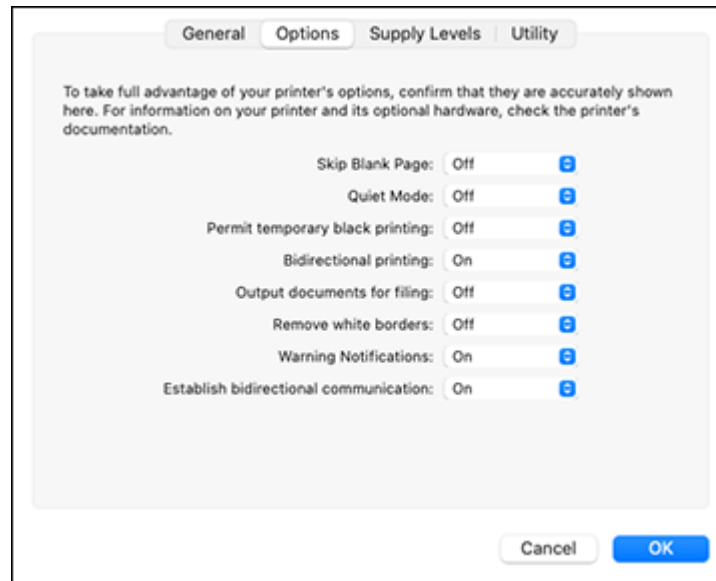

Note: The available settings and appearance of the options window may be different than those covered here, depending on the Mac OS version and the application you are using.

4. Select any of the available printing preferences.
5. Click **OK**.

[Printing Preferences - Mac](#)

Parent topic: [Printing on a Mac](#)

Printing Preferences - Mac

You can select these settings on the **Options** or **Driver** tab.

Skip Blank Page

Ensures that your product does not print pages that contain no text or images.

Quiet Mode

Lessens noise during printing but may decrease print speed.

Permit temporary black printing

Allows you to print using black ink when color ink is expended.

Bidirectional printing

Prints in both directions (right-to-left and left-to-right), speeding up printing, but may reduce print quality.

Output documents for filing

Outputs all landscape, portrait, 1-sided, and 2-sided documents in the same orientation for easier filing.

Remove white borders

Removes white margins that may appear when you print borderless photos.

Warning Notifications

Lets you choose whether or not to receive warning notifications from the printer software for various operating conditions.

Establish bidirectional communication

Allows the product to communicate with the computer. Do not change the default setting unless you experience issues when using a shared printing pool.

Parent topic: [Selecting Printing Preferences - Mac](#)

Printing Your Document or Photo - Mac

Once you have selected your print settings, you are ready to print.

Click **Print** at the bottom of the print window.

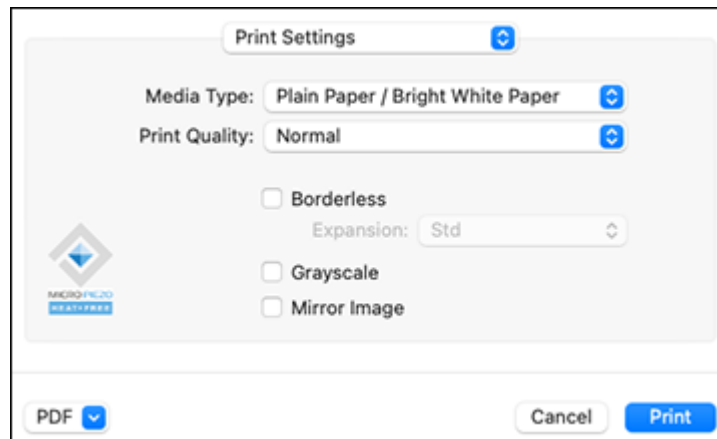

[Checking Print Status - Mac](#)

Parent topic: [Printing on a Mac](#)

Related tasks

[Selecting Basic Print Settings - Mac](#)

[Selecting Page Setup Settings - Mac](#)

[Selecting Print Layout Options - Mac](#)

[Selecting Printing Preferences - Mac](#)

Checking Print Status - Mac



During printing, you can view the progress of your print job, control printing, and check ink status.

1. Click the printer icon when it appears in the Dock.

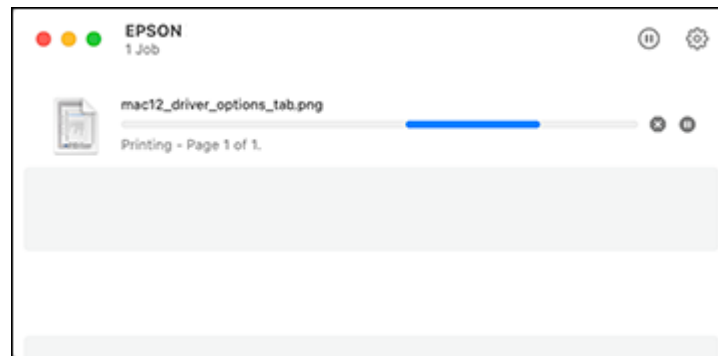
You see the print status window:



2. Select the following options as necessary for your Mac OS version:

- To cancel printing, click the print job and click  or **Delete**.
- To pause a print job, click the print job and click  or **Hold**. To resume a print job, click the paused print job and click  or **Resume**.
- To pause printing for all queued print jobs, click **Pause** or **Pause Printer**.
- To display other printer information, click **Settings** or **Supply Levels**.

Parent topic: [Printing Your Document or Photo - Mac](#)

Printing from a Smartphone or Tablet

You can print from a smartphone or tablet running iOS or Android using the Epson Smart Panel app.

Note: Your device must be connected to the same wireless network as your Epson product, and Epson Smart Panel must be configured for use with your product.

1. Download the Epson Smart Panel app from your device's app store or from Epson's website. See the link below.
2. Open the Epson Smart Panel app and select a print menu on the home screen.
3. Follow the on-screen instructions to begin printing.

Parent topic: [Printing from a Computer](#)

Related tasks

[Using the Epson Smart Panel Mobile App](#)

Related topics

[Wi-Fi or Wired Networking](#)

Printing with Epson Photo+

You can print photos, CD/DVD labels, and more using a variety of layouts and templates with Epson Photo+. Features include image corrections and adjustments, and adding text and stamps to photos. We recommend printing on genuine Epson photo paper for the best results. Make sure you have set up your product as described on the *Start Here* sheet and installed the Epson Photo+ software. See the Epson Photo+ help utility for more information.

Note: If you are using your Epson product with the Windows 10 S operating system, you cannot use Epson Photo+. You also cannot download and install any Epson product software from the Epson website for use with Windows 10 S; you must obtain software only from the Windows Store.

Parent topic: [Printing from a Computer](#)

Cancelling Printing Using a Product Button

If you need to cancel printing, select the  cancel icon on the LCD screen.

Parent topic: [Printing from a Computer](#)

Scanning

You can scan your originals and save them as digital files.

[Starting a Scan](#)

[Scanning a Document in Epson ScanSmart](#)

[Selecting Epson ScanSmart Settings](#)

[Scanning in Epson Scan 2](#)

Starting a Scan

After placing your originals on your product for scanning, start scanning using one of these methods.

[Starting a Scan Using the Product Control Panel](#)

[Starting a Scan Using Epson ScanSmart](#)

[Starting a Scan Using the Epson Scan 2 Icon](#)

[Starting a Scan from a Scanning Program](#)

[Starting a Scan from a Smartphone or Tablet](#)

Parent topic: [Scanning](#)

Related topics

[Placing Originals on the Product](#)

Starting a Scan Using the Product Control Panel

You can scan an image to a variety of destinations using your product's control panel.

1. Make sure you installed the product software and connected the product to your computer or network.

Note: Restart your computer after installing the product software to enable scanning from the control panel.

2. Place your original on the product for scanning.
3. Press the  home button, if necessary.
4. Select **Scan**.
5. Select one of the following options:
 - **Computer** lets you scan to a connected computer using your saved scan settings.

- **Cloud** sends your scanned files to a destination that you have registered with Epson Connect.
 - **WSD** lets you manage network scanning in Windows 11, Windows 10, Windows 8.x, Windows 7, or Windows Vista (English only). To use this feature, you must first set up a WSD (Web Services for Devices) port on your Windows 7 or Windows Vista computer (the port is set up automatically on Windows 11, Windows 10, and Windows 8.x).
6. Follow the instructions in the links below to complete your scan.

Note: The color, size, and border of the scanned image will not be exactly the same as the original.

[Scanning to a Connected Computer](#)

[Scanning to the Cloud](#)

[Setting Up a WSD Port \(Windows 7/Windows Vista\)](#)

[Control Panel Scanning Options](#)

Parent topic: [Starting a Scan](#)

Related tasks

[Using Epson Scan to Cloud](#)

Related topics

[Placing Originals on the Product](#)

[Wi-Fi or Wired Networking](#)

Scanning to a Connected Computer

You can scan an original and save it to a connected computer using your product's control panel. The computer must be connected using a USB cable or connected to the same network as your product.

You can save the scanned file as a JPEG or PDF file. You can also set up custom scan settings using Event Manager and automatically scan using those settings on your product control panel.

Note: Be sure you have installed Epson ScanSmart, Epson Scan 2, and Event Manager on your computer before scanning to your computer.

1. Place your original on the product for scanning.

Note: To scan a multi-page document, place all of the pages in the ADF.



2. Press the  home button, if necessary.
3. Select **Scan**.

4. Select **Computer**.

Note: Select **Dismiss** on the information screen, if necessary.

5. Do one of the following:
 - If a list of available computers is displayed, select the computer you want to scan to.
 - If the **Scan to Computer** screen is displayed and the computer is already selected, confirm the computer is correct. If you want to change the selected computer, select  and select the computer from the list.

Note: If your computer is connected to your product using a USB cable, select **USB Connection**.

6. Select  and choose one of the following options:
 - **Preview on Computer** to preview the scanned image on a computer before saving. (Windows 7 or later or OS X 10.11.x or later)
 - **Save as JPEG** to save the scanned scanned image as a JPEG file.
 - **Save as PDF** to save the scanned document or image as a PDF file.
7. Select the  icon to start scanning.

Your product scans your original and saves the scanned file to your computer.

Note: The color, size, and border of the scanned image will not be exactly the same as the original.

Parent topic: [Starting a Scan Using the Product Control Panel](#)

Related references

[Control Panel Scanning Options](#)

Related topics

[Placing Originals on the Product](#)



Scanning to the Cloud

You can use the control panel to send your scanned files to a destination that you have registered with Epson Connect.

Note: Make sure to set up your product using Epson Connect before using this feature.

1. Place your original on the product for scanning.
2. Press the  home button, if necessary.
3. Select **Scan**.
4. Select **Cloud**.

Note: You must register your product with Epson Connect to select a destination.

5. Select  to select a destination.
6. Change any of the displayed settings on the **Scan** tab as necessary.
7. Select the **Advanced Settings** tab to view and change additional scan settings, if necessary.
8. On the **Scan** tab, select the  icon to start scanning.

Your product scans your original and saves the scanned file to the selected destination.

Note: The color, size, and border of the scanned image will not be exactly the same as the original.

Parent topic: [Starting a Scan Using the Product Control Panel](#)

Related references

[Control Panel Scanning Options](#)

Related tasks

[Setting Up Epson Connect Services](#)

[Using Epson Scan to Cloud](#)

Related topics

[Placing Originals on the Product](#)

Setting Up a WSD Port (Windows 7/Windows Vista)

You can scan to a networked Windows computer using WSD (Web Services for Devices). You must first set up a WSD port on your Windows 7 or Windows Vista system (the port is set up automatically on Windows 11, Windows 10 and Windows 8.x).

Before you set up a WSD port, make sure you installed your product software, and connected your product and computer to the same network.

1. Turn on your product.
2. Print a network status sheet so you can identify the network name and model name for your product on the network.

3. Click  or **Start** and select **Computer**.
4. On the left side of the window, select **Network**.
5. Locate your product on the Network screen, right-click it, and select **Install**.
6. When you see the User Account Control screen, click **Continue**.

Note: If you see an Uninstall screen, click **Uninstall** and repeat these steps as necessary.

7. When you see the message **Your device is ready to use** in the Windows taskbar, click the message.
8. On the Driver Software Installation screen, make sure your product is listed as **Ready to use**. Then click **Close**.
9. Do one of the following:
 - **Windows 7:** Click  and select **Devices and Printers**.
 - **Windows Vista:** Click **Start** and select **Control Panel > Hardware and Sound > Printers**.
10. Make sure that an icon appears for your product's name on the network.

When you use WSD, select your product name to scan over the network.

Parent topic: [Starting a Scan Using the Product Control Panel](#)

Related tasks

[Printing a Network Status Sheet](#)

Related topics

[Wi-Fi or Wired Networking](#)

Control Panel Scanning Options

Select the options you want to use for scanning.

Note: Not all options or settings may be available, depending on the **Scan to** option selected.



Scan to setting	Available options	Description
Color mode	B&W	Select whether to scan images in color or black and white
	Color	

Scan to setting	Available options	Description
File format	JPEG	Select for photos
	PDF	Select for documents
Scan Area	Various sizes	Select the page size for your original
	Auto Cropping	Crops the white margin around your scanned original
	Max Area	Scan at the maximum area of the scanner glass
	Portrait	Select the orientation of your original
	Landscape	
Original Type	Text	Specifies the type of original you are scanning
	Text & Image	
	Photo	
Density	Varying levels	Adjusts the lightness or darkness of scanned images
Remove Shadow	Surround	Erases the shadows that appear around the edges of a document
	Center	Erases the shadows that appear in the center of a document when copying a book
Remove Punch Holes	Erasing Position	Erases the binding holes on a document
	Original Orientation	Select the orientation of your original
Clear All Settings	Yes	Select Yes to restore all scan settings to their defaults
	No	

Parent topic: [Starting a Scan Using the Product Control Panel](#)

Starting a Scan Using Epson ScanSmart

You can start the Epson ScanSmart program to scan originals and easily review and edit scanned images. After that, you can save, print, or share them.

- **Windows 11:** Click , then search for **Epson ScanSmart** and select it.
- **Windows 10:** Click  > **Epson Software** > **Epson ScanSmart**.

- **Windows 8.x:** Navigate to the **Apps** screen and select **Epson ScanSmart**.
- **Windows (other versions):** Click  or **Start**, and select **All Programs** or **Programs**. Select **Epson Software** > **Epson ScanSmart**.
- **Mac:** Open the **Applications** folder, open the **Epson Software** folder, and select **Epson ScanSmart**.

You see a screen like this:

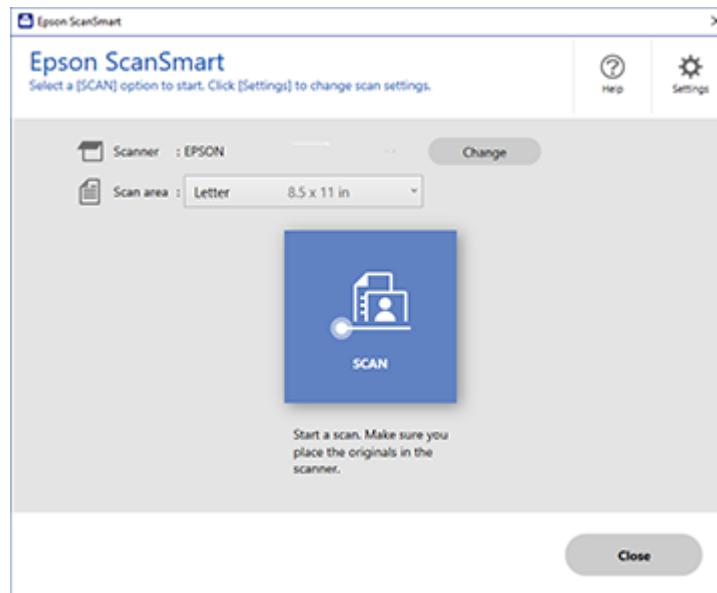



Parent topic: [Starting a Scan](#)

Starting a Scan Using the Epson Scan 2 Icon

You can start the Epson Scan 2 program to select scan settings, scan, and save the scanned image to a file.

Note: If you are using your Epson product with the Windows 10 S operating system, you cannot use the software described in this section. You also cannot download and install any Epson product software from the Epson website for use with Windows 10 S; you must obtain software only from the Windows Store.

- **Windows 11:** Click , then search for **Epson Scan 2** and select it.
- **Windows 10:** Click  and select **EPSON > Epson Scan 2**.
- **Windows 8.x:** Navigate to the **Apps** screen and select **Epson Scan 2**.
- **Windows (other versions):** Click  or **Start**, and select **All Programs** or **Programs**. Select **EPSON > Epson Scan 2 > Epson Scan 2**.
- **Mac:** Open the **Applications** folder, open the **Epson Software** folder, and select **Epson Scan 2**.

You see an Epson Scan 2 window like this:

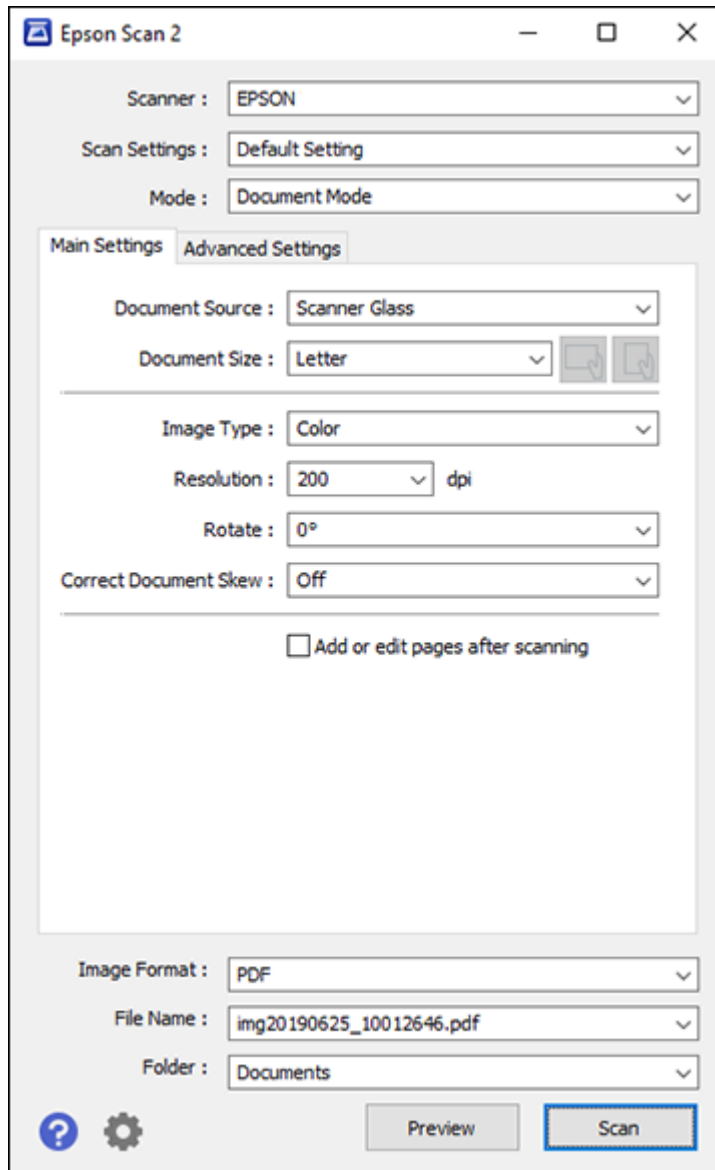

Parent topic: [Starting a Scan](#)

Starting a Scan from a Scanning Program

You can start Epson Scan 2 from a TWAIN-compliant scanning program to select scan settings, scan, and open the scanned image in the program.

Note: If you are using your Epson product with the Windows 10 S operating system, you cannot use the software described in this section. You also cannot download and install any Epson product software from the Epson website for use with Windows 10 S; you must obtain software only from the Windows Store.

1. Open your scanning program and select its scanning option. (See your scanning program help for instructions.)
2. Select your product.

Note: In certain programs, you may need to select your product as the "source" first. If you see a **Select Source** option, choose it and select your product. With Windows, do not select a **WIA** option for your product; not all scan functions will be available.

You see an Epson Scan 2 window like this:

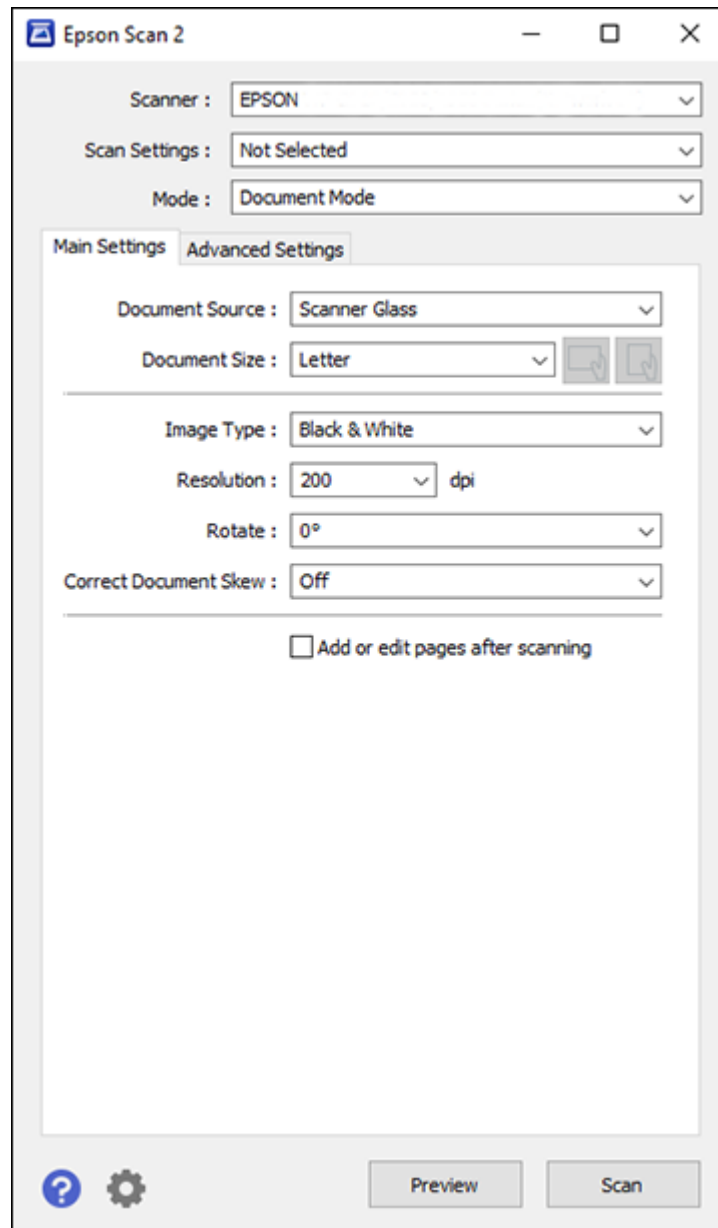

Parent topic: [Starting a Scan](#)

Starting a Scan from a Smartphone or Tablet

You can use the Epson Smart Panel app to scan from a network scanner to an iOS or Android device over a direct Wi-Fi connection.

1. Download the Epson Smart Panel app from your device's app store or from Epson's website. See the link below.
2. Place your original on the product for scanning.
3. Open the Epson Smart Panel app and select a scan menu on the home screen.
4. Follow the on-screen instructions to scan and save your original.

Parent topic: [Starting a Scan](#)

Related tasks

[Using the Epson Smart Panel Mobile App](#)



Related topics

[Placing Originals on the Product](#)

Scanning a Document in Epson ScanSmart

You can scan and review documents and photos in Epson ScanSmart.

Note: The images in this guide show Windows screens. Mac screens may be slightly different. Depending on your product model and software version, not all options may be available.

1. Load your original into the product.
2. Open Epson ScanSmart on your computer. Do one of the following:
 - **Windows 11:** Click , then search for **Epson ScanSmart** and select it.
 - **Windows 10:** Click  > **Epson Software** > **Epson ScanSmart**.
 - **Windows 8.x:** Navigate to the **Apps** screen and select **Epson ScanSmart**.
 - **Windows (other versions):** Click  or **Start**, and select **All Programs** or **Programs**. Select **Epson Software** > **Epson ScanSmart**.
 - **Mac:** Open the **Applications** folder, open the **Epson Software** folder, and select **Epson ScanSmart**.

You see a screen like this:

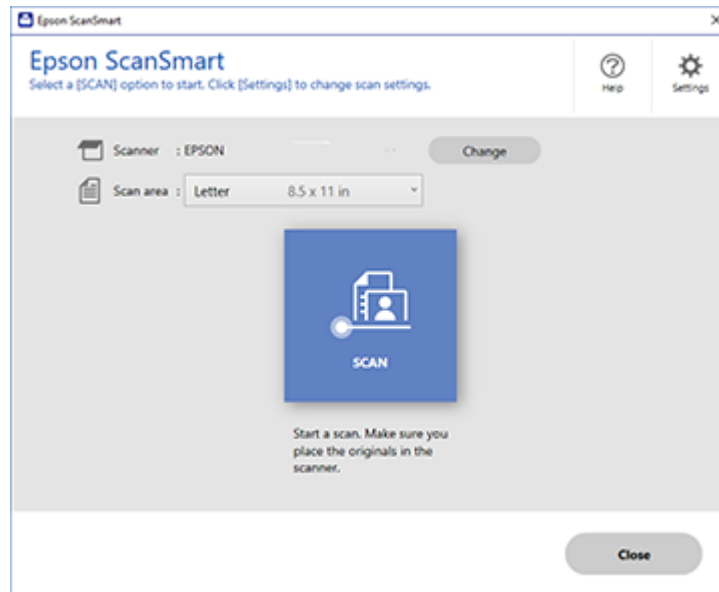

3. Select an option for the **Scan area** setting, if necessary.

Note: The **Scan area** setting limits the scan area to a selected size starting at the placement arrow on the scanner bed. It does not scale the image to the selected size.

4. Select **SCAN**.

The original is scanned. When scanning is complete, you see a screen like this:

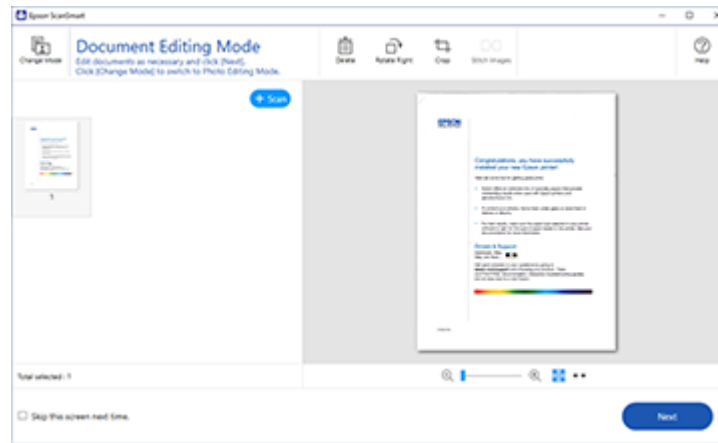

5. You can review, edit, or reorder the scanned images as follows:
 - Select **+ Scan** to scan more originals.
 - Select **Delete** to delete selected scanned images.
 - Select **Rotate Right** to rotate each scanned image.
 - Select **Crop** to crop the selected image.
 - Control-click two images, select **Stitch Images**, and follow the on-screen instructions to combine them into a single image.
6. If Photo Mode is automatically detected, the following enhancement options are available:
 - **Auto Color Enhancement**: automatically adjusts the brightness, contrast, and saturation of your photos
 - **Restore Faded Colors**: restores the colors in faded photos automatically
 - **Remove Red Eye**: automatically removes the red-eye effect from your photos
 - **Auto Cropping**: automatically crops the scanned image edges
7. When you finish reviewing and editing the scanned images, click **Next**.

You see a screen like this:

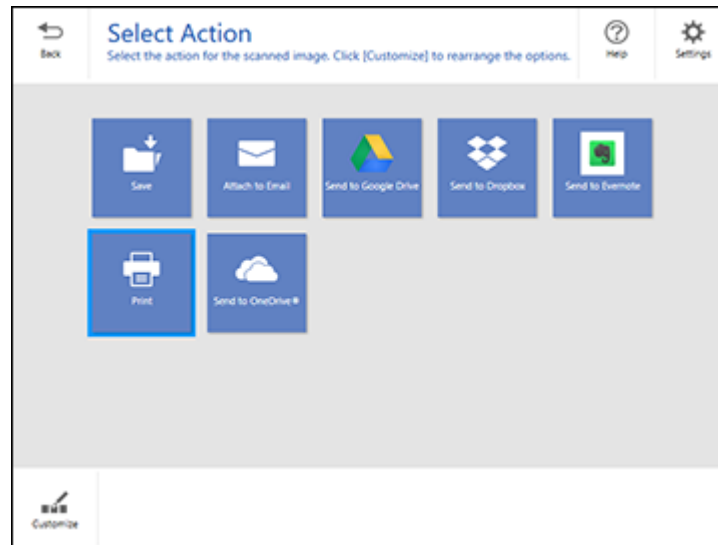

8. Select an option to save, send, or print the scanned images. See the links below.

[Saving a Scan](#)

[Attaching a Scan to Email](#)

[Sending a Scan to a Cloud Service](#)

[Printing a Scan](#)

Parent topic: [Scanning](#)

Related topics

[Placing Originals on the Product](#)

Saving a Scan

You can save a scanned image to your computer in a variety of formats.

1. Make sure your originals are scanned and reviewed. See the link below.
2. In the **Select Action** window, click **Save**.

You see a screen like this:

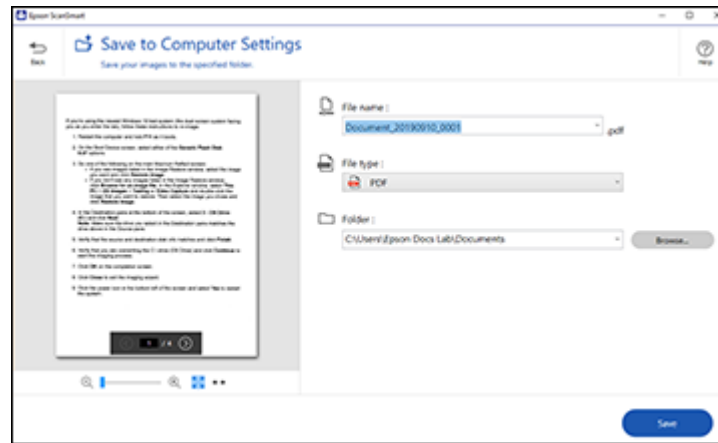

3. Change the settings as follows:
 - The document type and scan date for the file name are automatically detected. You can change them as necessary.
 - You can save the scanned image in a variety of formats. If you select Searchable PDF as the **File type** setting, you can select the OCR (Optical Character Recognition) language.
 - Select the folder on your computer in which to save the file.
4. Click **Save**.

Parent topic: [Scanning a Document in Epson ScanSmart](#)

Attaching a Scan to Email

You can attach a scanned image to an email as a file attachment.

Note: Your email app and account settings should be configured before scanning. You must install a MAPI-type email program such as Outlook Express, Windows Live Mail, Entourage, or Mac Mail. Attach to Email only supports 32-bit MAPI-compatible mail apps. Web-based email services such as Gmail are not supported. If you see an error message, your email app may not be compatible and you will need to save the scans and manually attach the file to an email.

1. Make sure your originals are scanned and reviewed. See the link below.

2. In the **Select Action** window, click **Attach to Email**.

You see a screen like this:

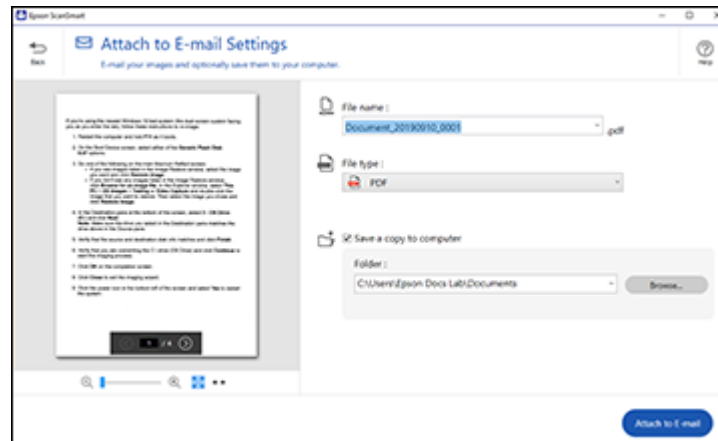

3. Change the settings as follows:
 - The document type and scan date for the file name are automatically detected. You can change them as necessary.
 - You can save the scanned image in a variety of formats. If you select Searchable PDF as the **File type** setting, you can select the OCR (Optical Character Recognition) language.
 - If you also want to save a copy of the scanned image to your computer, make sure the checkbox is selected and select the folder on your computer in which to save the file.
4. Click **Attach to E-mail**.

Your email program opens with the file attached to a new email.

Parent topic: [Scanning a Document in Epson ScanSmart](#)

Sending a Scan to a Cloud Service

You can upload scanned images to a cloud service.

1. Make sure your originals are scanned and reviewed. See the link below.
2. In the **Select Action** window, click one of the cloud service send options.

You see a screen like this:

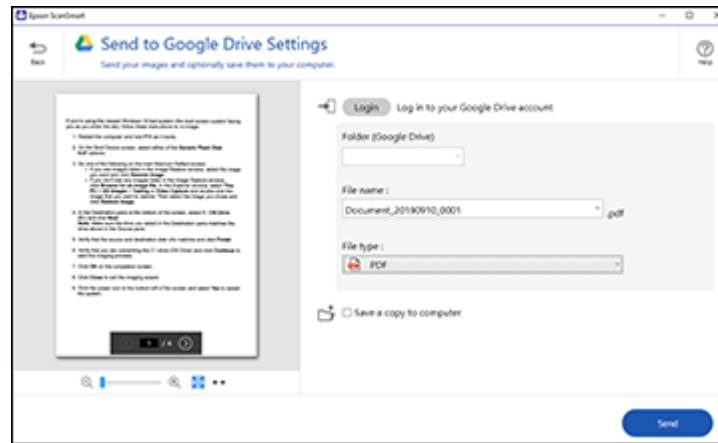

3. Log in to your account.

Note: You may need to allow Epson ScanSmart access to your account. The first time you log in, you may be prompted to enter an authentication code.

4. Change the settings as follows:
 - Select the folder in your account where you want to send the document.
 - The document type and scan date for the file name are automatically detected. You can change them as necessary.
 - You can save the scanned image in a variety of formats. If you select Searchable PDF as the **File type** setting, you can select the OCR (Optical Character Recognition) language.
 - If you also want to save a copy of the scanned image to your computer, click the checkbox.
5. Click **Send**.

Parent topic: [Scanning a Document in Epson ScanSmart](#)

Printing a Scan

You can print your scanned image and save the scanned file to your computer.

Note: Printing scanned images is available only with Epson printers. If you do not have an Epson printer, save the file and print it from an application that can open the file.

1. Make sure your originals are scanned and reviewed. See the link below.
2. In the **Select Action** window, click **Print**.

You see a screen like this:

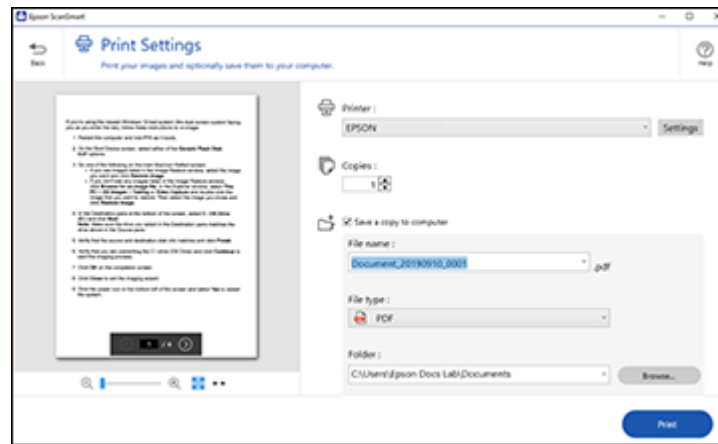

3. Change the settings as follows:
 - Select the Epson printer and change the print settings, if necessary.
 - Select the number of copies you want to print.
 - If you also want to save a copy of the scanned image to your computer, click the checkbox.
 - The document type and scan date for the file name are automatically detected. You can change them as necessary.
 - You can save the scanned image in a variety of formats. If you select Searchable PDF as the **File type** setting, you can select the OCR (Optical Character Recognition) language.
 - Select the folder on your computer in which to save the file.
4. Click **Print**.

Parent topic: [Scanning a Document in Epson ScanSmart](#)

Selecting Epson ScanSmart Settings

After starting Epson ScanSmart, you can change various scanning settings.

[Changing the Epson Product](#)

[Changing the Scan Settings](#)

[Changing the File Name Settings](#)

[Changing the Save Settings](#)

[Customizing Action Icons](#)

Parent topic: [Scanning](#)

Changing the Epson Product

If you are using more than one Epson product with Epson ScanSmart, you can change the product that you are using with your computer.

Note: A product connected to your computer via USB takes priority over a product with a Wi-Fi connection.

1. On the main screen, click **Change**.

You see a screen like this:

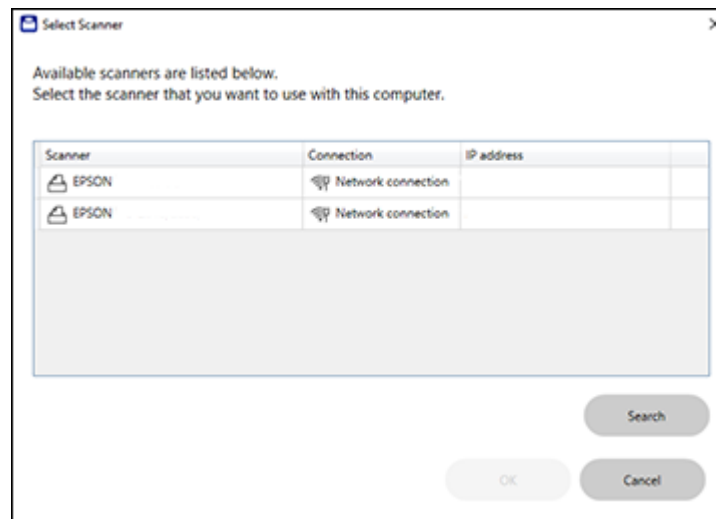

2. Select the Epson product you want to use with your computer and click **OK**.

Parent topic: [Selecting Epson ScanSmart Settings](#)

Changing the Scan Settings

You can change detailed scan settings such as the resolution, document size, and more.

Note: If you select **Auto Mode**, you cannot change the scan settings.

1. Click the  **Settings** button.

You see a screen like this:

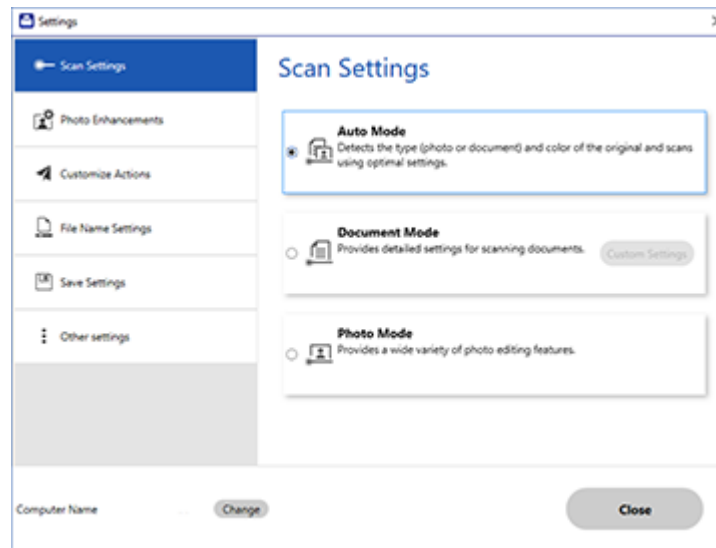

2. Do one of the following:

- To change Document Mode settings, select **Document Mode > Custom Settings**.
- To change Photo Mode settings, select **Photo Mode** and click **Close**. When you start a scan, you will be prompted to select scan settings.

You see a screen like this:

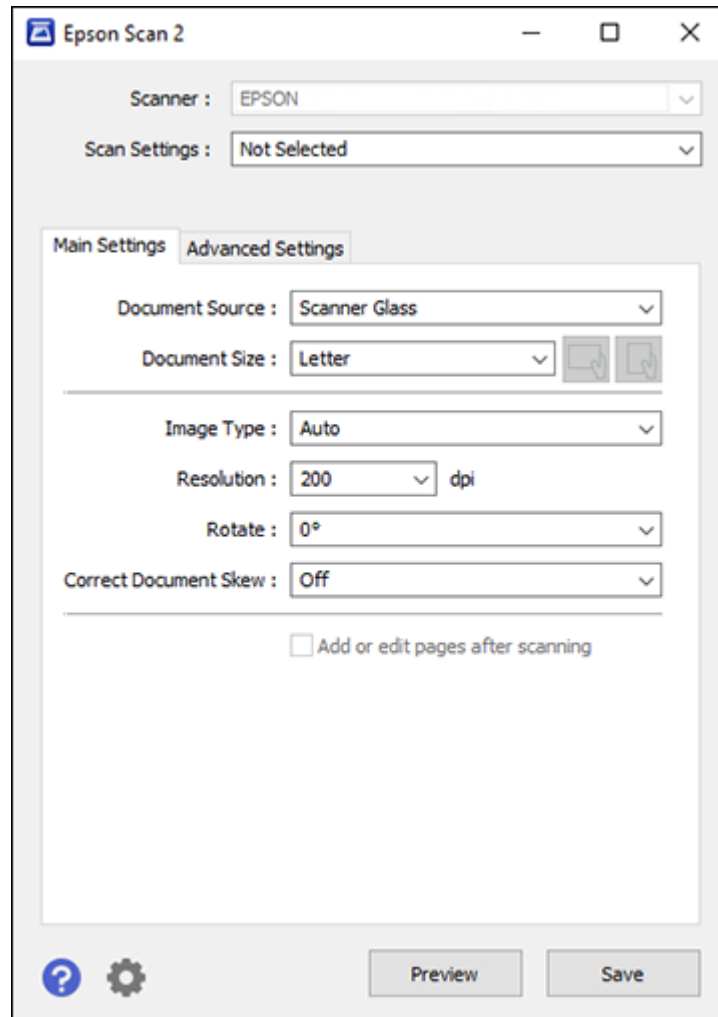

3. Change the settings as necessary and click **Save**.

Parent topic: [Selecting Epson ScanSmart Settings](#)

Changing the File Name Settings

You can change the default file naming method for your scans.

1. Click the  **Settings** button.

You see a screen like this:

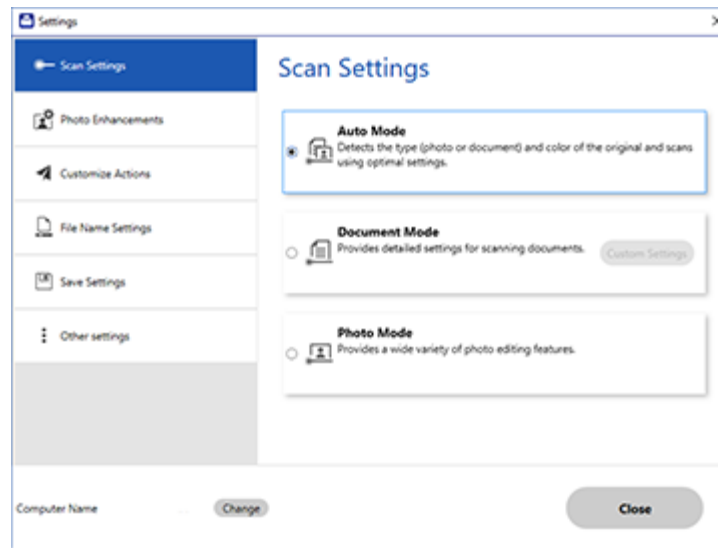

2. Click the **File Name Settings** tab.

You see a screen like this:

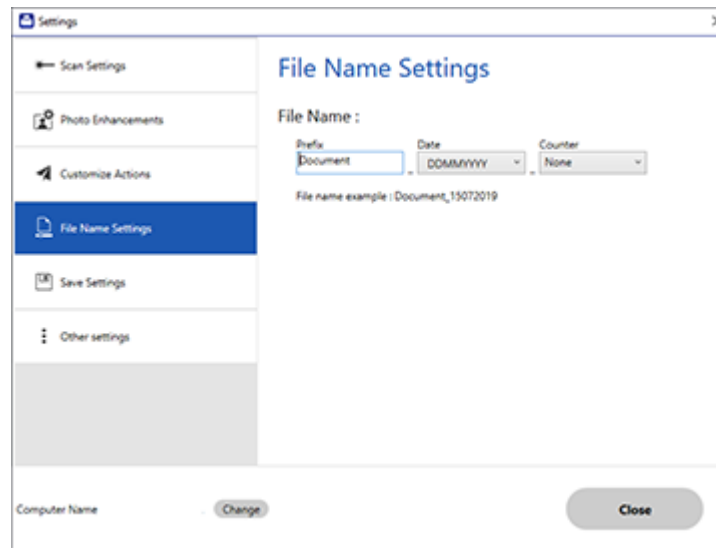

3. Change the settings as necessary:
 - Enter a prefix for the file name.
 - Select the date format.
 - Select a numbering format as the counter format.

4. Click **Close**.

Parent topic: [Selecting Epson ScanSmart Settings](#)

Changing the Save Settings

You can change the file type options for saving your scans.

1. Click the  **Settings** button.

You see a screen like this:

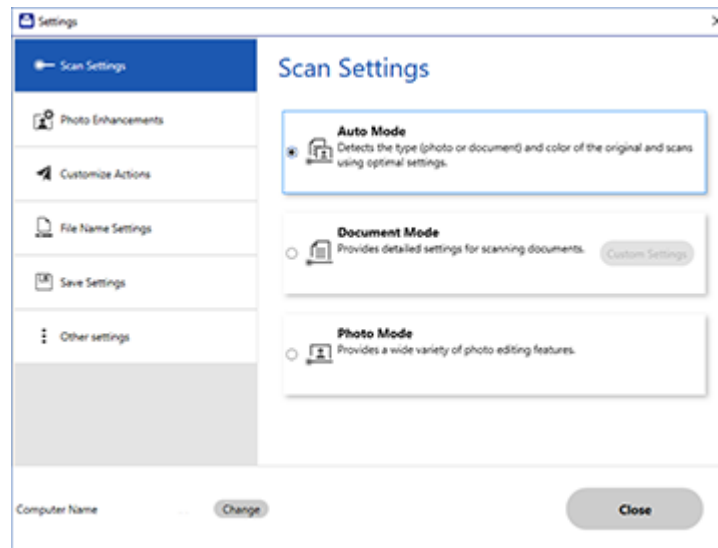

2. Click the **Save Settings** tab.

You see a screen like this:

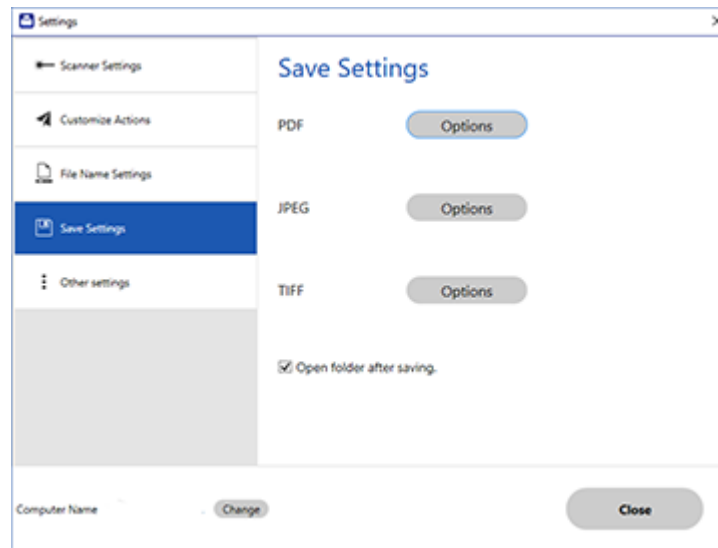

3. Click **Options** for a file format and change the settings as necessary.
4. Click **Open folder after saving** to open the file folder after a file is saved.
5. Click **Close**.

[Save Settings](#)

Parent topic: [Selecting Epson ScanSmart Settings](#)

Save Settings

You can change the settings for how scanned images are saved.

PDF Options

Setting	Options	Description
General	Generate PDF/A File	Creates a PDF that conforms to PDF/A-1 standards
	Create file with all pages	Saves all pages as one file
	Compression Level	Selects the compression level for color or grayscale images

JPEG Options

Setting	Options	Description
Image Quality Options	—	Sets a compression level by moving a slider or entering a value. File size increases the higher the resolution is.
Encoding (Windows only)	Standard	Images load from top to bottom in a web browser. It takes longer to load the entire image.
	Progressive	Images first load completely at low resolution and then adjust to high resolution in a web browser
Embed ICC Profile (Windows only)	—	Allows you to add ICC profiles to the image

TIFF Options

Setting	Options	Description
Byte Order	Windows Macintosh	Specifies the operating system where the scanned image will be used
Compression (Windows only)	—	Specifies the compression format and level for Color/Grayscale and B&W images. File size increases with higher quality.
Embed ICC Profile (Windows only)	—	Allows you to add ICC profiles to the image

Parent topic: [Changing the Save Settings](#)

Customizing Action Icons

You can customize which scan action icons appear on the **Select Action** screen.

Note: You can also customize them by clicking the **Customize** icon on the **Select Action** screen.

1. Click the  **Settings** button.

You see a screen like this:

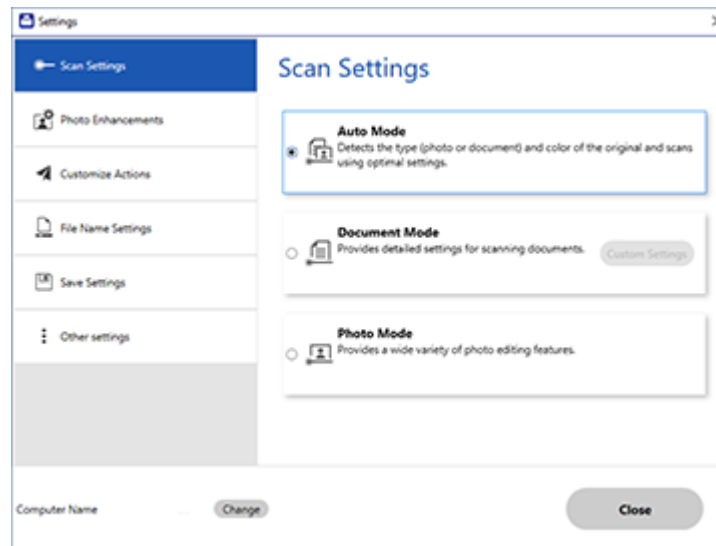

2. Click the **Customize Actions** tab.

You see a screen like this:

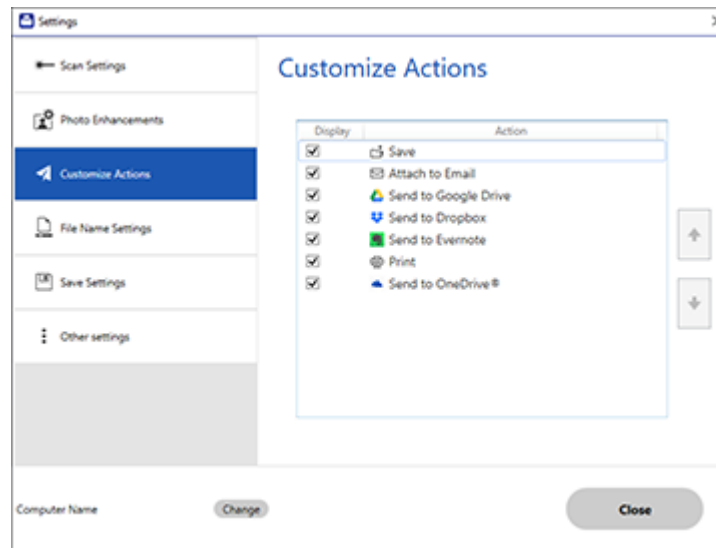

3. Choose which action icons to display by selecting or deselecting each checkbox. Click the arrow icons to move the icons up or down in the display order you want.
4. Click **Close**.

Parent topic: [Selecting Epson ScanSmart Settings](#)

Scanning in Epson Scan 2

Epson Scan 2 gives you access to basic and advanced scanning features. You can scan your document and save the scanned image in various file formats in your operating system's Documents or My Documents folder, or open it in your scanning program. You can preview the scanned image and select or change settings as necessary.

Note: If you are using your Epson product with the Windows 10 S operating system, you cannot use the software described in this section. You also cannot download and install any Epson product software from the Epson website for use with Windows 10 S; you must obtain software only from the Windows Store.

1. Start Epson Scan 2.

You see this window:

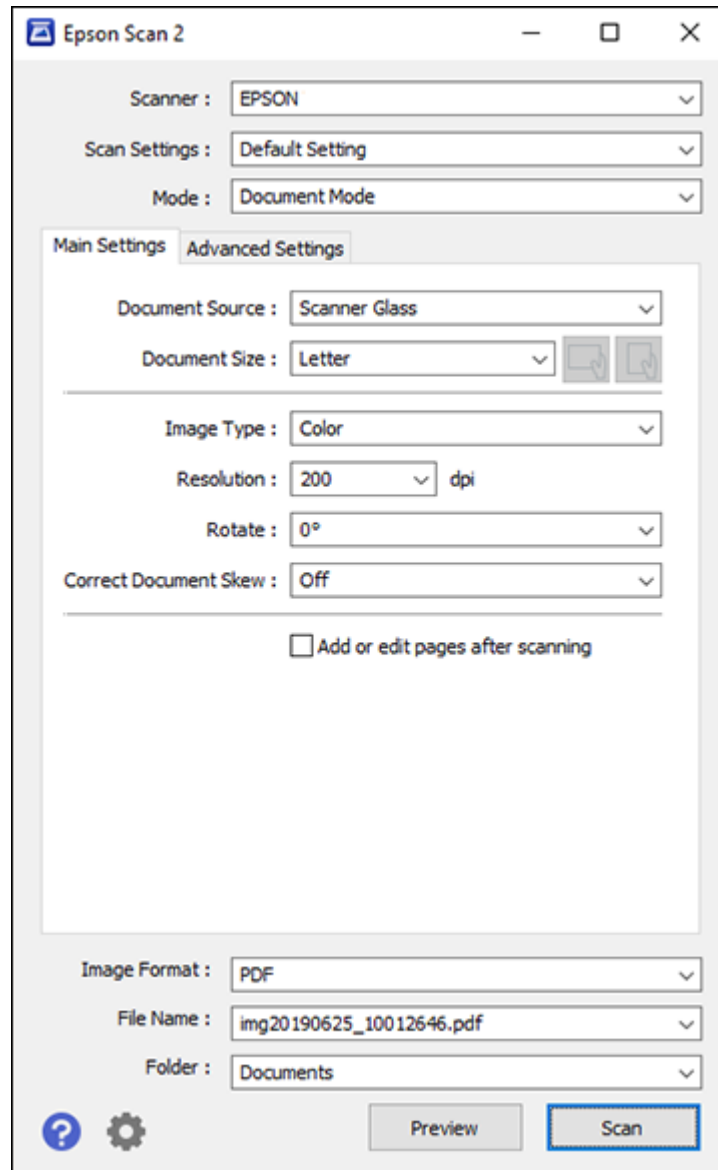

2. Select the **Mode** setting that matches the type of original you are scanning.
3. Select the **Document Source** setting that matches where you placed your original.
4. Select the **Document Size** setting that matches the size of your original. You can select **Customize** to enter a custom size, if necessary.
5. Select the image type of your original and how you want it scanned as the **Image Type** setting.
6. Select the **Resolution** setting you want to use for your scan.
7. Select the **Rotate** setting to rotate the scanned image.
8. Select the **Correct Document Skew** setting to correct skewed originals, image contents, or both.
9. Click the **Preview** button.

Epson Scan 2 previews your original and displays the results in the Epson Scan 2 window.

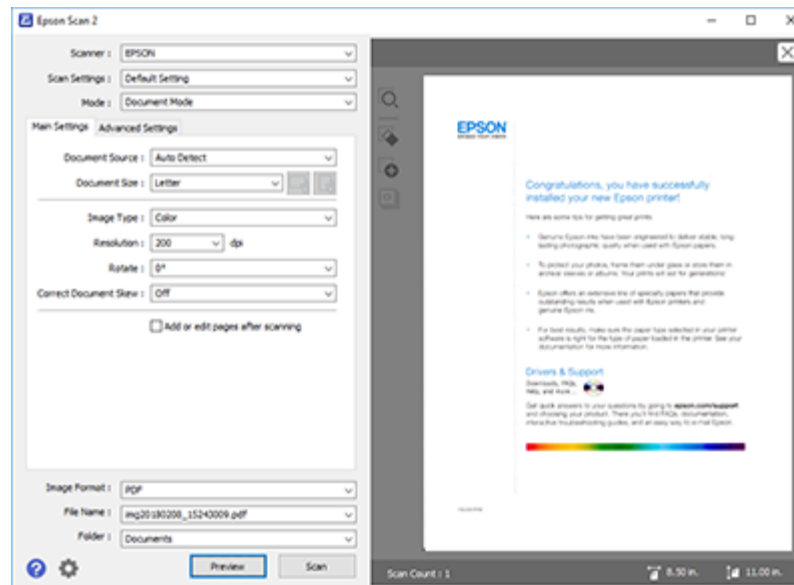

10. Reinsert your original into the ADF, if necessary.
11. Select any of the additional settings that you want to use on the Main Settings tab.
12. Click the **Advanced Settings** tab and select any settings that you want to use.

13. Select the format in which you want to save your scanned file as the **Image Format** setting. If necessary, select **Options** and select any desired format options.
14. Enter the file name for your scanned file in the **File Name** field. If necessary, select **Settings** to modify the file name settings.
15. Select the location in which you want to save your scanned file as the **Folder** setting. If necessary, select **Select** to create a new folder.
16. Click **Scan**.

The product scans your original and saves the scanned file in the location you specified.

[Additional Scanning Settings - Main Settings Tab](#)

[Additional Scanning Settings - Advanced Settings Tab](#)

[Saving Scanned Documents as a Searchable PDF Using Epson Scan 2](#)

[Image Format Options](#)

[Scan Resolution Guidelines](#)

Parent topic: [Scanning](#)

Additional Scanning Settings - Main Settings Tab

You can select these additional scanning settings on the Epson Scan 2 Main Settings tab. Not all adjustment settings may be available, depending on other settings you have chosen.

Rotate

Rotates the original image clockwise to the desired angle before scanning it. Select **Auto** to allow your product to automatically rotate the image based on the orientation of the text (may take longer to scan).

Correct Document Skew

Corrects skewed originals, image contents, or both.

Add or edit pages after scanning

Lets you add, remove, or edit the pages in a scan, including rotating pages and changing the page order.

Note: To save multiple pages in a single file, you must select a file format that supports multiple pages such as **PDF** or **Multi-TIFF**. If you select another file format, each scanned image or page is saved as a separate file.

Parent topic: [Scanning in Epson Scan 2](#)

Additional Scanning Settings - Advanced Settings Tab

You can select these additional scanning settings on the Epson Scan 2 Advanced Settings tab. Not all adjustment settings may be available, depending on other settings you have chosen.

Remove Background

Removes the background of the originals.

Text Enhancement

Sharpens the appearance of letters in text documents.

Auto Area Segmentation

Makes black and white images clearer and text recognition more accurate by separating the text from the graphics.

Threshold

Adjusts the level at which black areas in text and line art are delineated, improving text recognition in OCR (Optical Character Recognition) programs.

Color Enhance

Enhances the shades of the color you select in the scanned image. This setting is available only if you select **Grayscale** or **Black & White** as the Image Type setting.

Brightness

Adjusts the overall lightness and darkness of the scanned image.

Contrast

Adjusts the difference between the light and dark areas of the overall scanned image.

Gamma

Adjusts the midtone density of the scanned image.

Unsharp Mask

Makes the edges of certain image areas clearer. Turn off this option to leave softer edges.

Descreening

Removes the ripple pattern that might appear in subtly shaded image areas, such as skin tones. This option improves results when scanning magazines or newspapers. (The results of descreening do not appear in the preview image, only in your scanned image.)

Edge Fill

Corrects shadowing around the edges of the image by filling the shadows with black or white.

Dual Image Output

Scans the original image twice using different output settings (Windows only).

Watermark

Adds a watermark to a scanned image.

Parent topic: [Scanning in Epson Scan 2](#)

Saving Scanned Documents as a Searchable PDF Using Epson Scan 2

You can scan a document and save the text in a searchable PDF. In a searchable PDF, text is recognized using Optical Character Recognition (OCR) and then embedded in the scanned original.

Note: The required Epson Scan 2 OCR Component is installed automatically when you install your product software as instructed on the *Start Here* sheet. If you install your scanner software programs individually, be sure to also install this component if you want to perform OCR.

1. Load your original in the product for scanning.
2. Start Epson Scan 2.
3. Select your scan settings.
4. Click **Preview** and adjust the area you want to scan, if necessary.
5. If you are using the ADF, reload the ejected original.
6. Select **Searchable PDF** as the Image Format setting.
7. Select **Options** from the Image Format list.

You see this window:

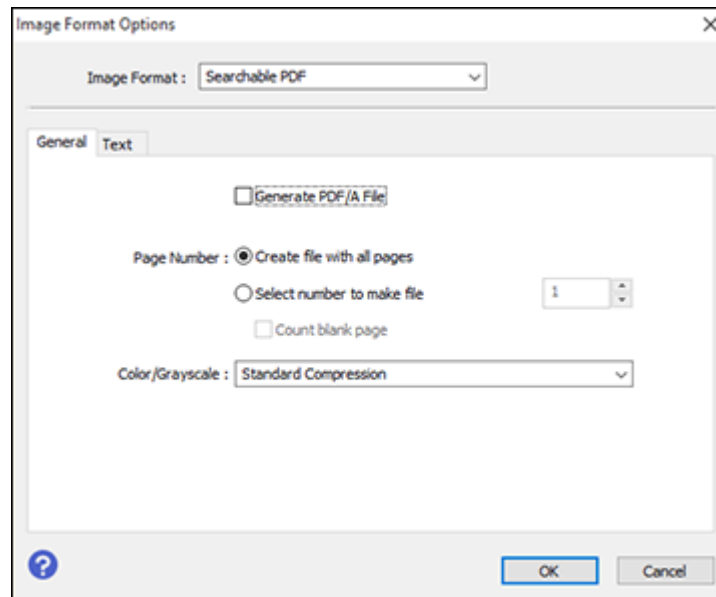

8. Select any of the options on the General tab.
9. Select the **Text** tab.
10. Make sure the language used in the document text is selected as the **Text Language** setting.
11. Click **OK**.
12. Confirm the **File Name** setting and select a **Folder** setting for your document.
13. Click **Scan**.

The scanned image is saved as a searchable PDF.

Parent topic: [Scanning in Epson Scan 2](#)

Image Format Options

You can select different image formats and related options. For details on available options, click the ? icon on the Epson Scan 2 Image Format Options window. Not all image formats have options.

BITMAP (*.bmp)

A standard image file format for most Windows programs.

JPEG (*.jpg)

An image format that lets you highly compress image data. However, the higher the compression, the lower the image quality. (The TIFF format is recommended when you need to modify or retouch your scanned image.)

PNG (*.png)

An image format that does not lose quality during editing.

TIFF (*.tif)

A file format created for exchanging data between many programs, such as graphic and DTP software.

Multi-TIFF (*.tif)

A TIFF file format when multiple pages are saved to the same file, allowing you to edit the images using a compatible program.

PDF (*.pdf)

A document format that is readable by Windows and Mac systems using Adobe Reader, Acrobat, or other programs. You can save multi-page documents in one PDF file.

Searchable PDF (*.pdf)

A document format that is readable by Windows and Mac systems using Adobe Reader, Acrobat, or other programs. You can save multi-page documents in one PDF file. Recognized text in the scanned document can be searched.

Parent topic: [Scanning in Epson Scan 2](#)

Scan Resolution Guidelines

The **Resolution** setting, measured in dpi (dots per inch), controls the amount of detail captured in your scans. Increasing the resolution raises the amount of detail captured but comes with the following disadvantages:

- Larger file sizes
- It takes longer to scan your originals, send/receive your scans by email or fax, and to print your scans
- The image may become too large to fit on your display or print on paper

If you plan to enlarge a scanned image so you can print it at a larger size, you may need to increase the resolution from the default resolution set by Epson Scan 2. Follow these guidelines to determine the resolution setting you need:

- You will scan the image at its original size but enlarge it later in an image-editing program.

Increase the Epson Scan 2 Resolution setting in your scan. Increase the resolution by the same amount you will increase the image size to retain a high image quality. For example, if the resolution is

300 dpi (dots per inch) and you will double the image size later, change the Resolution setting to 600 dpi.

- You will scan the image at 100% or a smaller size.

Select the Epson Scan 2 Resolution setting based on how you will use the scanned image:

- Email/view on a computer screen/post on the web: 96 to 200 dpi
- Print/fax/convert to editable text (OCR)/create searchable PDF: 200 to 300 dpi

Parent topic: [Scanning in Epson Scan 2](#)

Faxing

See these sections to fax using your product.

Note: This product allows you to store names, telephone numbers, and fax data in its memory even when the power is turned off. Make sure you restore all of the default settings if you give away or dispose of the product. This will erase all of your network settings and fax data.

[Connecting a Telephone or Answering Machine](#)

[Setting Up Fax Features](#)

[Setting Up Contacts and Contact Groups](#)

[Sending Faxes](#)

[Receiving Faxes](#)

[Checking Fax Status](#)

[Printing Fax Reports](#)

Related tasks

[Resetting Control Panel Defaults](#)

Connecting a Telephone or Answering Machine

You must connect your product to a telephone wall jack to send or receive faxes. If you want to use the same telephone line to receive calls, you can connect a telephone or answering machine to your product using an additional phone cable.

Note: In areas where lightning strikes occur frequently, we recommend that you use a surge protector.

Note: If you do not connect a telephone to your product, make sure Receive Mode is set to **Auto**. Otherwise, you cannot receive faxes.

Note: You may not be able to use the printer with the following phone lines or systems:

- VoIP phone line such as DSL or fiber-optic digital service
- Digital phone line (ISDN)
- Some PBX telephone systems
- When adapters such as terminal adapters, VoIP adapters, splitters, or DSL router are connected between the telephone wall jack and the printer

1. Connect a phone cable to your telephone wall jack and to the **LINE** port on your product.

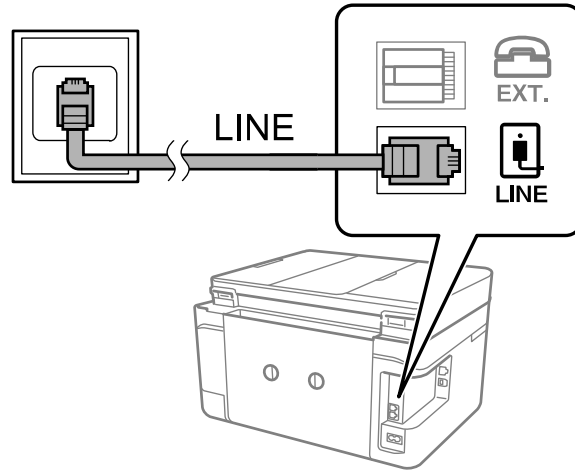

Note: If you have a DSL or ISDN connection, you must connect the appropriate DSL filter, or ISDN terminal adapter or router to the wall jack to be able to use the line for faxing or voice calls using your product. Contact your DSL or ISDN provider for the necessary equipment.

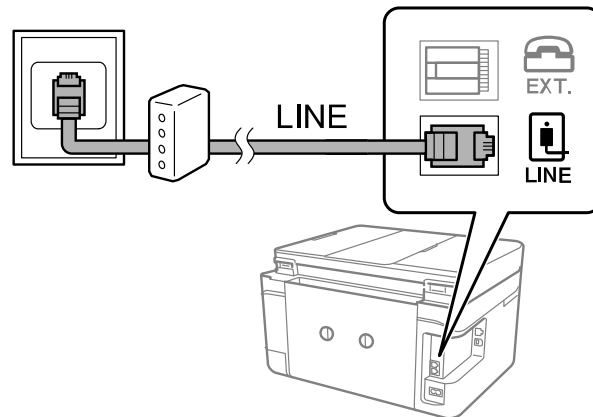

2. If you are connecting a telephone or answering machine to your product using a second phone cable, remove the cap from the **EXT** port on your product.

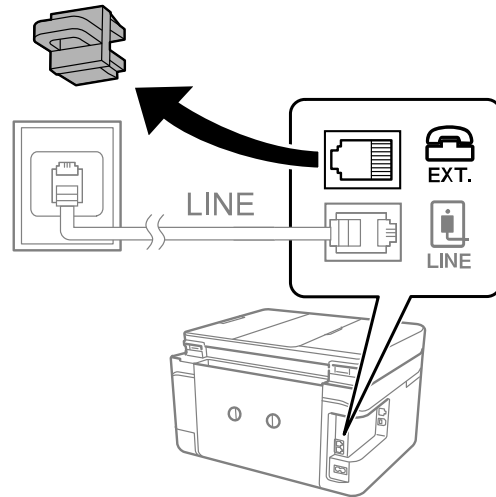

Note: If your telephone has a fax function, disable the fax function before connecting it. If you are not able to completely disable the fax function on your telephone, you may not be able to use it as an external telephone.

3. Connect a second phone cable to your telephone or answering machine and to the **EXT** port on your product.

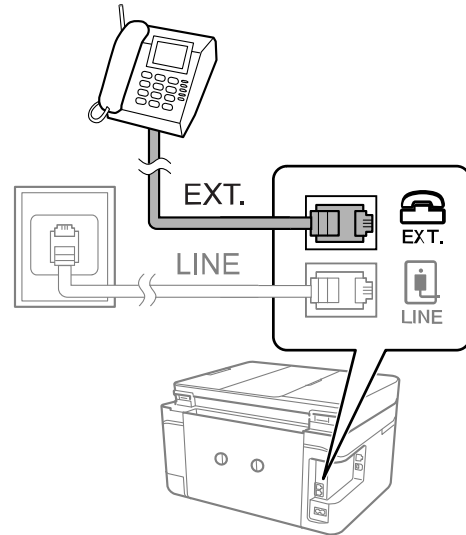

Note: If you connect an answering machine and Receive Mode is set to **Auto**, set the number of rings before your product answers a call to a number that is higher than your answering machine's setting for the number of rings.

Make sure to connect the telephone to the **EXT** port on your product. If you split the telephone line between your telephone and the product, they will not work correctly.

Parent topic: [Faxing](#)

Related references

[Basic Settings - Fax](#)

Related tasks

[Receiving Faxes Automatically](#)

[Setting the Number of Rings to Answer](#)

Setting Up Fax Features

Before faxing with your product, set up your fax header and select the fax features you want to use.

Note: If you leave your product unplugged for a long period of time, you may need to reset the date and time settings for faxes.

[Setting Up Basic Fax Features](#)

[Selecting Advanced Fax Settings](#)

[Setting Up the Fax Utility - Windows](#)

[Setting Up Fax Features Using the Fax Utility - Mac](#)

Parent topic: [Faxing](#)

Related tasks

[Selecting the Date and Time](#)

Setting Up Basic Fax Features

See these sections to select the basic settings you need to use the product's fax features.

[Using the Fax Setup Wizard](#)

[Selecting the Line Type](#)

[Setting the Number of Rings to Answer](#)

Parent topic: [Setting Up Fax Features](#)

Using the Fax Setup Wizard

You can setup the product's basic fax settings using the Fax Setting Wizard. This wizard is automatically displayed when the product is turned on for the first time. You can also change these settings individually from the Fax Settings menu.

1. Press the  home button, if necessary.
2. Select **Settings** > **General Settings** > **Fax Settings**.
3. Select **Fax Setting Wizard**.
The Fax Setting Wizard screen appears.
4. Select **Proceed**.
5. On the Fax Header screen, use the displayed keypad to enter the sender name for your fax source, such as your name or a business name. You can enter up to 40 characters. Select **OK** when finished.

6. On the Your Phone Number screen, use the displayed keypad to enter your fax number, up to 20 characters. Select **OK** when finished.

Note: The name and phone number in the fax header identifies the source of the faxes you send.

7. On the Distinctive Ring Setting screen, do one of the following:
 - If you have subscribed to a distinctive ring service from your telephone company, select **Settings**. Select the ring pattern to be used for incoming faxes. Go to step 10.
 - If you do not have a distinctive ring service, select **Skip** and go to the next step.

Note: Distinctive ring services allows you to have several phone numbers on one phone line. Each number is assigned a different ring pattern. You can use one number for voice calls and another for fax calls. Select the ring pattern assigned to fax calls in the Distinctive Ring Setting. If you select a ring pattern other than **All**, Receive Mode is automatically set to **Auto**.

8. On the Receive Mode Setting screen, do one of the following:
 - If you have connected an external telephone or answering machine to the product, select **Yes** and go to the next step.
 - If you did not connect an external telephone or answering machine, select **No** and go to step 10. (Receive Mode is automatically set to **Auto**; otherwise you cannot receive faxes.)
9. On the next Receive Mode Setting screen, select **Yes** to receive faxes automatically or select **No** to receive faxes manually.

Note: If you connect an external answering machine and select to receive faxes automatically, make sure the **Rings to Answer** setting is correct. If you select to receive faxes manually, you need to answer every call and operate the product's control panel or your phone to receive faxes.

10. On the Proceed screen, confirm the displayed settings and select **Proceed**, or press the back arrow to change the settings.
11. On the Run Check Fax Connection screen, select **Start Checking** and follow the on-screen instructions to check the fax connection and print a report of the check result. If there are any errors reported, try the solutions on the report and run the check again.

If the Select Line Type screen appears, select the correct line type.

If the Select Dial Tone Detection screen appears, select **Disable**. However, disabling the dial tone detection function may drop the first digit of a fax number and send the fax to the wrong number.

Parent topic: [Setting Up Basic Fax Features](#)

Related tasks

[Entering Characters on the LCD Screen](#)

Selecting the Line Type

If you connect the product to a PBX phone system or terminal adapter, you must change the product's line type. PBX (Private Branch Exchange) is used in office environments where an external access code such as "9" must be dialed to call an outside line. The default Line Type setting is PSTN (Public Switched Telephone Network), which is a standard home phone line.

1. Press the  home button, if necessary.
2. Select **Settings** > **General Settings** > **Fax Settings** > **Basic Settings** > **Line Type** > **PBX**.

You see a screen like this:

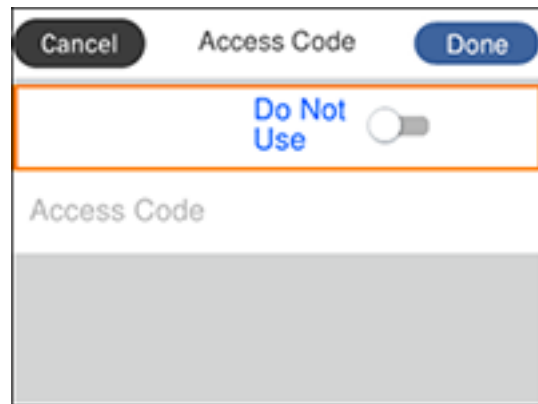

3. Set the switch to **Use** to activate the setting.
4. Select **Access Code**.
5. Use the displayed keypad to enter the access code, such as 9, and select **OK**.
6. Select **Done** to exit.

Parent topic: [Setting Up Basic Fax Features](#)

Setting the Number of Rings to Answer

If you connect an external answering machine and select to receive faxes automatically, make sure the Rings to Answer setting is correct. The number of rings should be higher than the number of rings your answering machine is set to for answering a call.

1. Press the  home button, if necessary.
2. Select **Settings** > **General Settings** > **Fax Settings** > **Basic Settings**.
3. Set **Receive Mode** to **Auto**.
4. Select **Rings to Answer**.

You see a screen like this:



5. Press the **+** or **-** buttons to select the number of rings, then select **Done**. Make sure to select a number higher than the number of rings your answering machine is set to for answering a call.

Note: An answering machine picks up every call faster than the product, but the product can detect fax tones and start receiving faxes. If you answer the phone and hear a fax tone, check that the product has started receiving the fax, then hang up the phone.

Parent topic: [Setting Up Basic Fax Features](#)

Selecting Advanced Fax Settings

You can select a variety of advanced fax settings.

1. Press the  home button, if necessary.
2. Select **Settings** > **General Settings** > **Fax Settings**.

You see a screen like this:



3. Select the group of settings you want to change.

[Basic Settings - Fax](#)

[Receive Settings - Fax](#)

[Report Settings - Fax](#)

[Security Settings - Fax](#)

Parent topic: [Setting Up Fax Features](#)

Basic Settings - Fax

Set the basic options you want to use for incoming and outgoing faxes.

Setting	Options	Description
Fax Speed	Fast(33,600bps)	Sets the speed at which you send and receive faxes.
	Medium(14,400bps)	
	Slow(9,600bps)	
ECM	On	Turns on Error Correction Mode (ECM) to automatically correct errors in sent or received fax data.
	Off	Turns off Error Correction Mode (ECM); color faxes cannot be sent or received.

Setting	Options	Description
Dial Tone Detection	On	Automatically dials the number you enter for faxing when the product detects a dial tone.
	Off	Turns off automatic dial tone detection, which may be necessary if the product is connected to a PBX (Private Branch Exchange) or a TA (Terminal Adapter). However, turning this setting off may cause the product to drop the first digit of a fax number.
Line Type	PSTN	Selects a standard phone line (Public Switched Telephone Network).
	PBX	Selects Private Branch Exchange, the type of phone line used in office environments where an access code such as 9 must be used to call an outside line.
Header	Your Phone Number	Select to enter your phone number and header information for inclusion on outgoing faxes.
	Fax Header	
Receive Mode	Manual	Lets you confirm whether an incoming fax should be printed; a telephone must be connected to the product
	Auto	Automatically receives and prints faxes.
Distinctive Ring (DRD)	All	If you are using a Distinctive Ring Service on your phone line, your telephone company can assign two or more phone numbers to the same line and assign different ring patterns to each. If you use this service, select the number of rings for your fax number so your product can receive faxes on the correct number of rings. Select All for phones lines that do not use this service.
	Single	
	Double	
	Triple	
	Double&Triple	
Rings to Answer	1 to 9	Sets the number of rings before your product receives a fax. If Receive Mode is set to Auto and an answering machine is connected to the product, make sure this setting is set higher than the number of rings your answering machine is set to answer a call.

Setting	Options	Description
Remote Receive	Off	Lets you start receiving faxes using your phone instead of operating the product (if the Receive Mode is set to Auto). When you select On , you must also set a Start Code . If you are using a cordless handset with its base connected to the product, you can start receiving the fax by entering the code using the handset.
	On	
	Start Code	
Rejection Fax	Various	Lets you automatically reject faxes from blocked numbers, with blank headers, or from unrecognized contacts.

Parent topic: [Selecting Advanced Fax Settings](#)

Receive Settings - Fax

Set the receive options you want to use for incoming faxes.

Setting	Options	Description
Save to Computer	No	Select Yes to save received faxes as PDF files to a connected computer when using FAX Utility. After selecting Yes , you can select Yes and Print .
	Yes	
	Yes and Print	
Auto Reduction	On	Select to reduce the size of large received faxes to fit on the paper size in the selected paper source.
	Off	Select to print large incoming faxes at their original size on multiple sheets, if necessary.
Split Page Settings	Delete Print Data After Split	Select how to split large incoming faxes across multiple sheets.
	Overlap When Split	
Auto Rotation	On	If you have loaded A5-size paper, select On to rotate landscape-oriented incoming faxes so that they print correctly on the paper.
	Off	
Add Reception Information	On	Select On to include the date, time, the sender's information, and a page number in your incoming faxes.
	Off	

Setting	Options	Description
2-Sided	Off	Select On to print incoming faxes double sided. You can also select the Binding Margin .
	On	
Print Start Timing	All Pages Received	Select to print incoming faxes after the product receives all of the pages of the document.
	First Page Received	Select to print incoming faxes as soon as the product receives the first page of the document.
Collation Stack	On	Select On to print incoming faxes so that the pages are stacked in the correct page order. (When the product is low on memory, this option may not be available.)
	Off	
Print Suspend Time	Off	Select On to set a time period to stop automatic printing of faxes or reports and save received faxes in the product's memory. (Make sure there is enough free memory before using this function.)
	On	
	Time to Stop	
	Time to Restart	
Quiet Mode	On	Select On to reduce noise during printing. (Printing speed may be reduced.)
	Off	

Parent topic: [Selecting Advanced Fax Settings](#)

Report Settings - Fax

Set the fax report options you want to use.

Setting	Options	Description
Fax Log Auto Print	Off	Select when to automatically print the fax log
	On(Every 30)	
	On(Time)	
Attach Fax image to Report	Off	Prints a transmission report with an image of the first page of the faxed document
	On(Large Image)	
	On(Small Image)	

Setting	Options	Description
Report Format	Simple	Selects a format for the printed fax report. Select Detail to include error codes.
	Detail	

Parent topic: [Selecting Advanced Fax Settings](#)

Security Settings - Fax

Set the security options you want to use for fax data.



Setting	Options	Description
Direct Dialing Restrictions	Off	Does not restrict dialed fax numbers.
	On	Allows faxing only to numbers stored in the contacts list or history.
	Enter Twice	Requires you to enter fax numbers twice to prevent errors.
Broadcasting Restrictions	Off	Selecting On allows only one fax number to be entered as the recipient.
	On	
Confirm Address List	Off	Selects whether or not to display a recipient confirmation screen before a fax is sent.
	On	
Backup Data Auto Clear	Off	Automatically erases sent or received fax data from your product's memory.
	On	
Clear Backup Data	—	Deletes all sent or received fax data remaining in your product's memory; run this function if you are giving away or disposing of your product.

Parent topic: [Selecting Advanced Fax Settings](#)

Setting Up the Fax Utility - Windows

You can set up the FAX Utility for Windows for use with your product.

Note: Before using the FAX Utility for Windows, make sure you have set up the fax features on your product using the product control panel. Also first confirm that you can send and receive faxes using the control panel.

1. Do one of the following:
 - **Windows 11:** Click , then search for **EPSON Software** and select it.
 - **Windows 10:** Click  and select **EPSON Software**.
 - **Windows 8.x:** Navigate to the **Apps** screen.
 - **Windows (other versions):** Click  or **Start > Programs** or **All Programs > EPSON Software**.
2. Select **FAX Utility**.

The first time you use the FAX Utility, you see this introduction window:

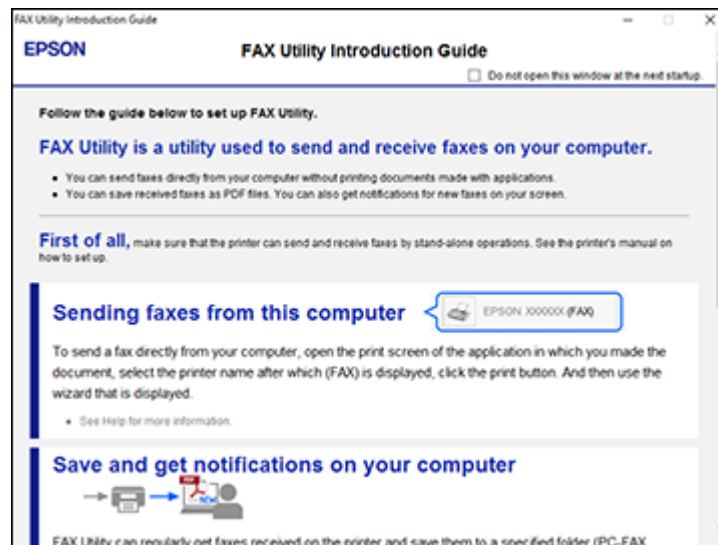

3. Read about the FAX Utility and click **Return to the main window** at the bottom of the window.

You see this window:

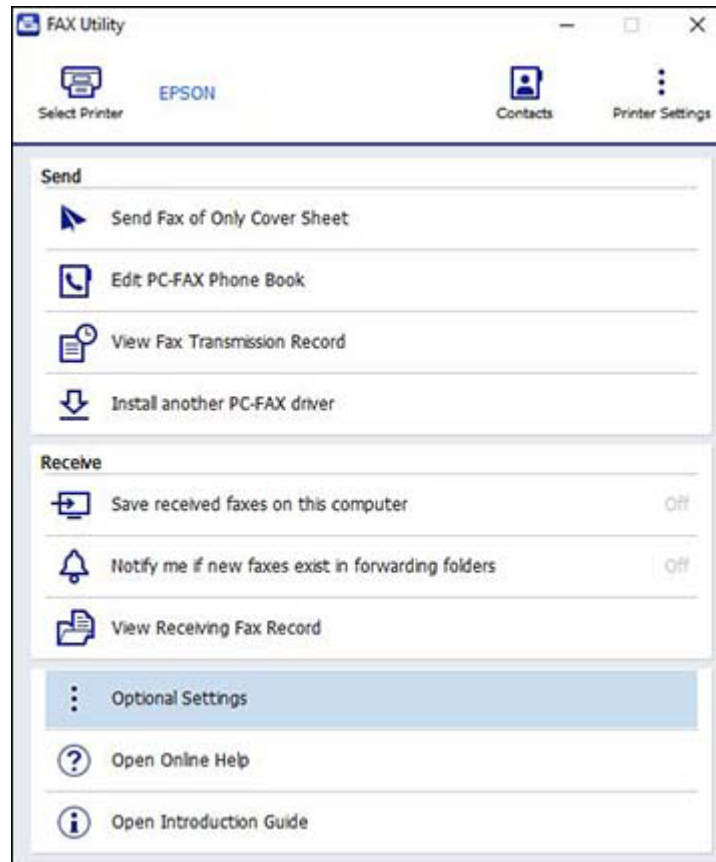

4. Click **Select Printer** and follow the on-screen instructions to transfer your product's fax settings to the FAX Utility.

Note: For detailed information, click **Help** or **Open Online Help**.

Parent topic: [Setting Up Fax Features](#)

Setting Up Fax Features Using the Fax Utility - Mac

You can set up your fax header and select your fax settings using the FAX Utility for Mac.

1. In the Apple menu or the Dock, select **System Preferences**. Select **Print & Fax**, **Print & Scan**, or **Printers & Scanners**, select the **FAX** option for your product, and select **Options & Supplies**. Select **Utility** and select **Open Printer Utility**.
2. Double-click **FAX Utility**, if necessary.

You see a window like this:

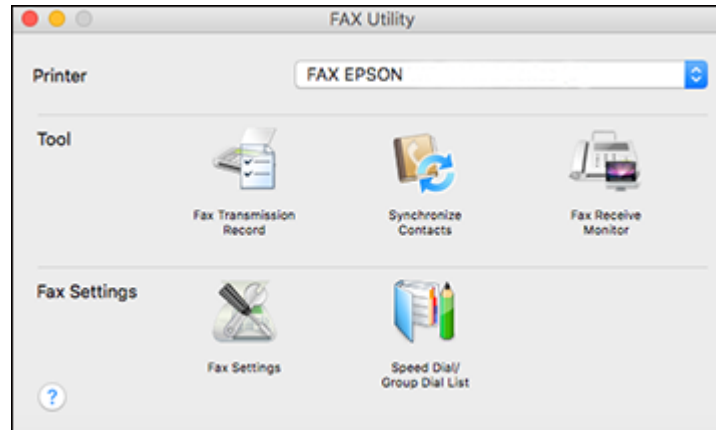

3. Select your **FAX** product in the Printer list.
4. Select **Fax Settings**.
5. Follow the prompts that appear on the screen to enter your fax header information and select your fax settings.

Note: For detailed information, select the FAX Utility ? icon.

Parent topic: [Setting Up Fax Features](#)

Setting Up Contacts and Contact Groups

You can set up a list of contacts and their fax numbers so you can quickly select them for faxing. You can also set up contact groups to send a fax message to multiple contacts.

[Setting Up Contacts Using the Product Control Panel](#)

Parent topic: [Faxing](#)

Setting Up Contacts Using the Product Control Panel

You can set up your contacts and contact groups using the control panel on your product.

[Creating a Contact or Group](#)

[Editing or Deleting a Contact or Group](#)

Parent topic: [Setting Up Contacts and Contact Groups](#)

Creating a Contact or Group

You can create a list of contacts to save frequently used fax numbers and group contacts to easily send faxes to multiple recipients.

Note: You can create up to 100 contacts and contact groups combined.

1. Press the  home button, if necessary.
2. Select **Fax > Contacts**.
3. Select **Add Entry**.
4. Select **Add Contact** or **Add Group**.

Note: You must create a contact before a group can be created.

5. Select each field as necessary and enter the information for your contact or group.



Note: If necessary, enter an outside line access code (such as **9**) at the beginning of the fax number. If the access code has been set up in the **Line Type** setting, enter the **#** pound sign instead of the code.

6. Select **OK** to store the entry.

Parent topic: [Setting Up Contacts Using the Product Control Panel](#)

Editing or Deleting a Contact or Group

You can edit or delete any of the contacts or groups on your list.

1. Press the  home button, if necessary.
2. Select **Fax > Contacts**.
3. Select the  icon next to the contact you want to edit or delete.

You see a screen like this:



4. Do one of the following:
 - To delete the contact or group, select **Delete** and select **Yes** on the confirmation screen.
 - To edit the contact or group, select **Edit**, select the item you want to change and make any changes as necessary. When you are finished editing, select **OK**.

Parent topic: [Setting Up Contacts Using the Product Control Panel](#)

Sending Faxes

See these sections to send faxes using your product.

[Sending Faxes from the Product Control Panel](#)

[Sending Faxes Using the Fax Utility - Windows](#)

[Sending Faxes Using the Fax Utility - Mac](#)

Parent topic: [Faxing](#)

Sending Faxes from the Product Control Panel

See these sections to send faxes using the product's control panel.

[Sending a Fax Using the Keypad, Contact List, or History](#)

[Fax Sending Options](#)

[Sending a Fax at a Specified Time](#)

[Dialing Fax Numbers from a Connected Telephone](#)

Parent topic: [Sending Faxes](#)

Related tasks

[Selecting the Line Type](#)

Related topics

[Setting Up Contacts Using the Product Control Panel](#)

[Placing Originals on the Product](#)

Sending a Fax Using the Keypad, Contact List, or History

You can send a fax from your product control panel by entering the fax number, or selecting the number from either the contact list or fax history.

Note: You can send a black-and-white fax to up to 100 contacts or 99 groups at a time, or send a color fax to one recipient at a time. If your recipient's fax machine does not print in color, your fax is automatically sent in black-and-white.

1. Place your original on the product for faxing.
2. Press the  home button, if necessary.
3. Select **Fax**.

You see a screen like this:

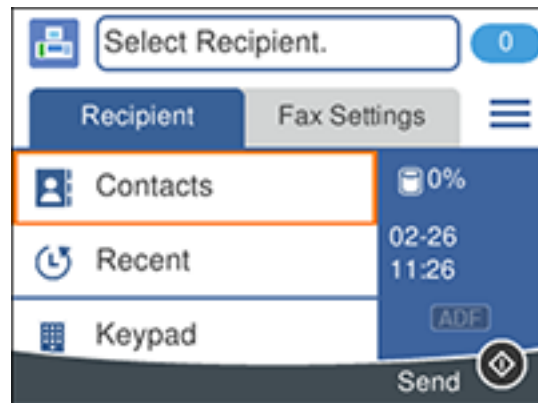



4. Do one of the following to select fax recipients:
 - **Manually enter a fax number:** Select **Keypad** and enter a fax number. Select **OK** when done. To add another fax number, repeat the same steps.

Note: If direct dialing has been restricted, you can only select the number from the contact list or fax history. If necessary, enter an outside line access code (such as 9) at the beginning of the fax number. If the access code has been set up in the **Line Type** setting, enter the **#** pound sign instead of the code. If your fax number requires a brief pause, select - to insert a pause symbol (-).

- **Select from the contact list:** Select **Contacts** to display the contact list. Select one or more contacts (select the contact again to deselect it). You can also select the **Search for Contacts** field to search for recipients by name, index name, or entry number. Select **Close** when you are finished.
- **Select from the sent fax history:** Select **Recent** to display the sent fax history. Select a recipient from the list.

Note: To delete entered recipients, select the recipient field, select the recipient you want to delete, and select **Remove**.

5. If you need to change any fax settings, select **Fax Settings** and select your settings.
6. Select the  icon on the Recipient tab to send the fax.

Note: To cancel faxing, select .

After scanning your originals, your product dials the number and sends the fax.

Parent topic: [Sending Faxes from the Product Control Panel](#)

Related references

[Fax Sending Options](#)

Related tasks

[Selecting the Line Type](#)

Related topics

[Setting Up Contacts Using the Product Control Panel](#)

[Placing Originals on the Product](#)

Fax Sending Options

While sending a fax, you can select **Fax Settings** and select these options.

Setting	Options	Description
Resolution	Standard	Adjusts the scan resolution and print quality of outgoing faxes
	Fine	
	Photo	
Density	Varying levels available	Lets you select from various density levels
Remove Background	Auto	Automatically removes any background color on scanned images
	Varying levels available	Lets you select from various levels of background color adjustment
Sharpness	Varying levels available	Lets you adjust the sharpness of an image
ADF Continuous Scan	Off	Select On to have the product to ask if you want to scan another page after a document in the ADF has finished scanning
	On	
Original Size (Glass)	Half Letter	Sets the size for a document placed on the scanner glass
	A5	
	Letter	
	A4	
Color Mode	B&W	Select whether to scan images in black and white or color
	Color	
Direct Send	Off	Select On to send black-and-white faxes to a single recipient as soon as the connection is made, without saving the scanned image to memory. You cannot use this setting when sending a color fax or sending a fax to multiple recipients.
	On	
Send Fax Later	Off	Select On to send the current fax at a selected time
	On	

Setting	Options	Description
Add Sender Information	Off	Lets you include a header, your phone number, or a destination list in the selected location on your outgoing faxes
	Outside of Image	
	Inside of Image	
Fax Header		Select a header for the recipient (headers must be created in advance)
Transmission Report	Print on Error	Lets you select when to print transmission reports
	Print	
	Do Not Print	
Clear All Settings	Yes	Restore all settings to their defaults
	No	

Parent topic: [Sending Faxes from the Product Control Panel](#)

Sending a Fax at a Specified Time

You can send a fax at a time of your choice.

Note: Make sure the product's date and time settings are correct. You can only send faxes in black-and-white when you use this option.

1. Place your original on the product for faxing.
2. Press the  home button, if necessary.
3. Select **Fax**.
4. Enter a fax number or select a number from the Contacts or Recent lists.
5. Select **Fax Settings**.
6. Select **Send Fax Later**.
7. Select **On**.
8. Select **Time**, use the displayed keypad on the LCD screen to enter your desired time, and select **OK**.
9. Select **OK** again to save the settings.

10. Select the  icon on the Recipient tab to send the fax.

Note: To cancel faxing, select .

After scanning your originals, your product dials the number and sends the fax at the specified time.

Note: If the product is turned off at the specified time, the fax is sent when it is powered on.

Parent topic: [Sending Faxes from the Product Control Panel](#)

Related tasks

[Selecting the Date and Time](#)

Related topics

[Placing Originals on the Product](#)

[Setting Up Contacts Using the Product Control Panel](#)

Dialing Fax Numbers from a Connected Telephone

If you connected a telephone to the **EXT** port on your product, you can send a fax by dialing the fax number from the connected telephone. If the recipient's phone number and fax number are the same, you can speak to the recipient before sending the fax.

Note: When a fax number is dialed using the connected telephone, sending a fax takes longer because the product scans and sends the fax simultaneously. While sending the fax, other features cannot be used.

1. Place your original on the product for faxing.
2. Press the  home button, if necessary.
3. Dial the fax number from the connected telephone. Speak to the recipient if necessary.
4. Select **Fax** on the LCD screen.
5. Select **Fax Settings** and select any settings as necessary.

Note: Your product now communicates with the recipient's fax machine. Do not hang up the telephone.

6. When you hear a fax tone, select ◊.

Note: If your recipient's fax machine does not print in color, your fax is automatically sent in black-and-white.

7. Hang up the telephone.

Parent topic: [Sending Faxes from the Product Control Panel](#)

Related topics

[Placing Originals on the Product](#)

Sending Faxes Using the Fax Utility - Windows

You can send a fax from a printing program in Windows. You can fax up to 100 pages at a time, including a cover sheet.

1. Open the file you want to fax and select the print command.

You see a window like this:

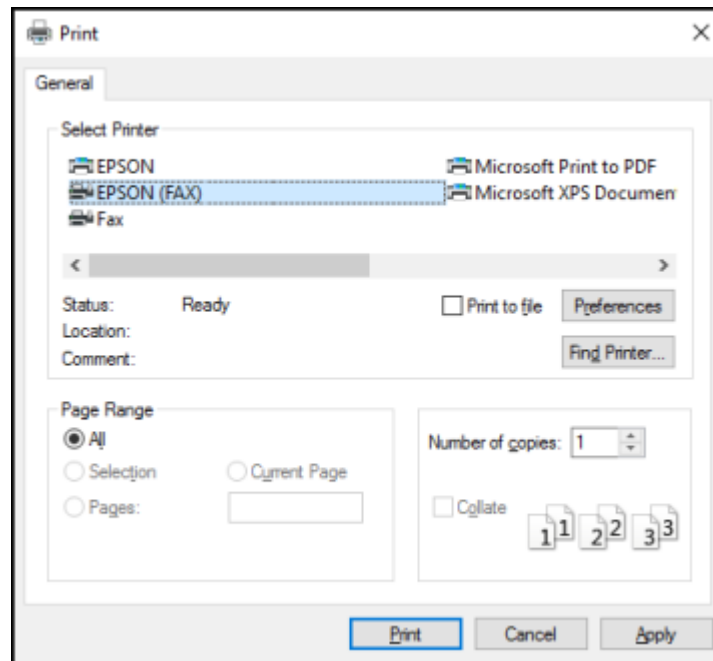

2. Select your product with the **FAX** option as the printer.
3. To change the Paper Size, Orientation, Color, Image Quality, or Character Density settings, click the **Preferences** or **Properties** button.

Note: If you see a **Setup**, **Printer**, or **Options** button, click it. Then click **Preferences** or **Properties** on the next screen. For more information about selecting fax print settings, click **Help**.

4. Select the Page Range as necessary. (Leave the Number of copies set to **1**.)
5. Click **Print** or **OK**.

If you're faxing for the first time, you see a window like this one:

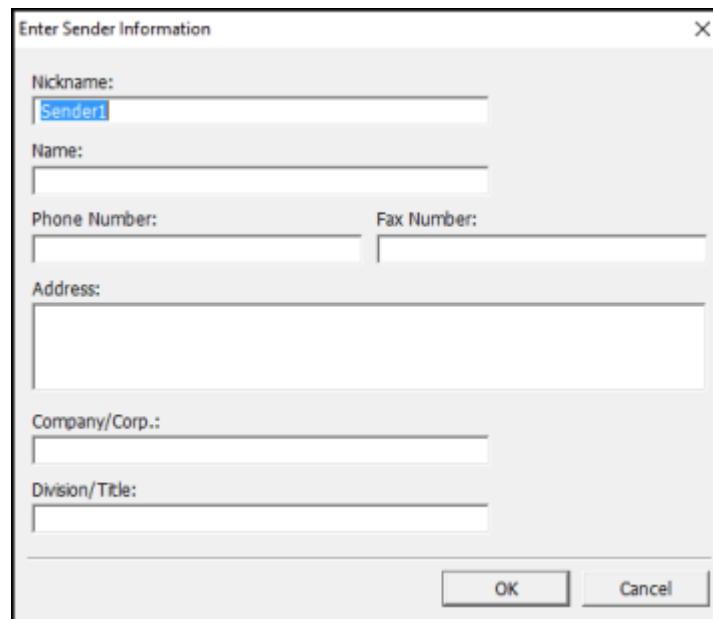

The image shows a dialog box titled "Enter Sender Information" with a close button (X) in the top right corner. The dialog box contains the following fields and labels:

- Nickname:
- Name:
- Phone Number:
- Fax Number:
- Address:
- Company/Corp.:
- Division/Title:

At the bottom right of the dialog box, there are two buttons: "OK" and "Cancel".

6. Enter your sender information so that recipients can identify the origin of the fax. Then click **OK** to save the sender information.

You see a window like this:

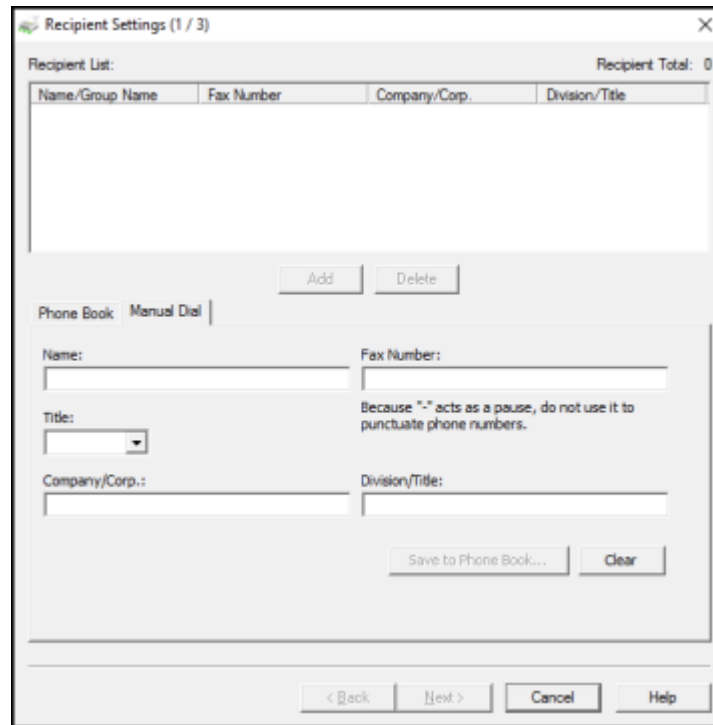

7. Enter the recipient's name and fax number or select a recipient from the phonebook, then click **Next**.

Note: For detailed instructions on using the Epson FAX Utility, click **Help**.

8. Select a cover sheet and enter a subject and message, then click **Next**.
9. Click **Send** to transmit your fax.

Parent topic: [Sending Faxes](#)

Sending Faxes Using the Fax Utility - Mac

You can send a fax from a Mac printing program using the FAX Utility. You can fax up to 100 pages at a time, including a cover sheet.

1. Open the file you want to fax.

2. Select the print command in your application.

Note: You may need to select a print icon on your screen, the **Print** option in the **File** menu, or another command. See your application's help utility for details.

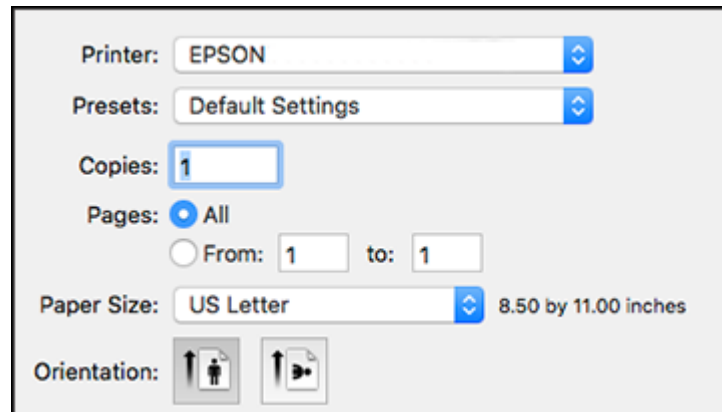

Note: The print window may look different, depending on the Mac OS version and the application you are using.

3. Select your product **FAX** option as the **Printer** setting.
4. If necessary, click the arrow next to the Printer setting or the **Show Details** button to expand the print window.
5. Select the number of pages you are faxing as the **Pages** setting.

Note: Leave the **Copies** setting set to 1.

6. Select **Recipient Settings** from the pop-up menu.

You see this window:

The image shows a software window titled "Recipient Settings". At the top, there is a dropdown menu with "Recipient Settings" selected. Below this is a section labeled "Recipient List:" containing a table with three columns: "Name", "Company/Corp.", and "Fax Number". The table is currently empty. To the right of the table are three buttons: a person icon, a plus sign (+), and a minus sign (-). Below the table is an "Add:" section with three input fields labeled "Name:", "Company/Corp.:", and "Fax Number:". Below the "Fax Number:" field is a small text note: "A hyphen (-) is available only at the beginning of the phone number because it acts as a pause in dialing." At the bottom of the "Add:" section is an "External Access Prefix:" input field. At the very bottom of the window are two buttons: "Cancel" and "Fax".

7. Do one of the following to choose your recipient:
 - Select a name or group from the **Recipient List**.
 - Enter a name, company, and fax number and click the **+** button.
 - Click the  icon and select a recipient from your address book.
8. Select **Fax Settings** from the pop-up menu.

You see this window:

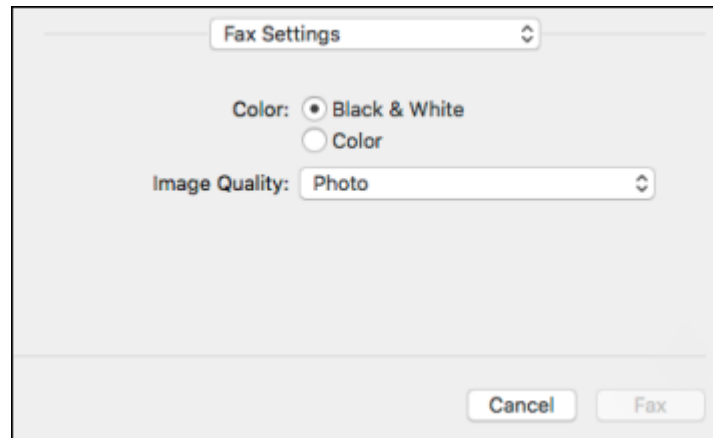

9. Select the **Color** and **Image Quality** settings you want to use for your fax.
10. Click **Fax**.

Parent topic: [Sending Faxes](#)

Receiving Faxes

See these sections to receive faxes with your product.

[Fax Reception](#)

[Receiving Faxes Automatically](#)

[Receiving Faxes Manually](#)

[Receiving a Fax by Polling](#)

[Saving and Viewing Received Faxes](#)

Parent topic: [Faxing](#)

Fax Reception

Your product will automatically receive and print faxes when you set the Receive Mode to **Auto**.

If you connected a telephone to your product so you can use the same phone line for faxes and voice calls, you can also set your product to receive faxes manually. This allows you to check for a fax tone using the telephone and press a button on your product to receive the fax.

Make sure to load paper in your product and select your fax settings before receiving a fax.

Note: If you run out of paper during fax printing, load more paper and press the button indicated on your product's LCD screen to continue.

Parent topic: [Receiving Faxes](#)

Receiving Faxes Automatically

To receive faxes automatically, make sure Receive Mode is set to **Auto** (the default setting for the product).

To change the Receive Mode if necessary, select **Settings > General Settings > Fax Settings > Basic Settings > Receive Mode**.

If an answering machine is connected, make sure the product's **Rings to Answer** setting is set higher than the number of rings your answering machine is set to answer a call. For example, if the answering machine is set to pick up on the fourth ring, set the product to pick up on the fifth ring or later.

Parent topic: [Receiving Faxes](#)

Related references

[Basic Settings - Fax](#)

Related tasks

[Receiving Faxes Manually](#)

Receiving Faxes Manually

You can set up your product to receive faxes manually by setting the Receive Mode to **Manual**. This lets you check for a fax tone on the connected telephone before receiving a fax.

1. To change the Receive Mode, select **Settings > General Settings > Fax Settings > Basic Settings > Receive Mode** and select **Manual**.
2. When the connected telephone rings, answer the call.
3. If you hear a fax tone, select **Fax** on the LCD display.

Note: To receive a fax using the attached telephone instead of the product control panel, enable the **Fax Settings > Basic Settings > Remote Receive** setting.

4. Select **Send/Receive**.
5. Select **Receive**.

6. Select the  icon to start receiving the fax.
7. Hang up the telephone.

Parent topic: [Receiving Faxes](#)

Related references

[Basic Settings - Fax](#)



Related tasks

[Receiving Faxes Automatically](#)

Receiving a Fax by Polling

You can use polling to receive a fax from another fax machine (such as a fax information service).

Note: You cannot use polling to receive a fax from a fax information service that uses audio guidance.

1. Press the  home button, if necessary.
2. Select **Fax**.
3. Select the  icon.
4. Set **Polling Receive** to **On**.
5. Select **Close**.
6. Enter the fax number you expect to receive the fax from.

Note: If direct dialing has been restricted, you can only select the number from the contact list or fax history.

7. Select the  icon to start receiving the fax.

Parent topic: [Receiving Faxes](#)



Saving and Viewing Received Faxes

You can save received faxes in your product's memory and view them on the LCD screen. The inbox can hold up to 100 documents but can vary depending on the file size of the documents.

1. Press the  home button, if necessary.
2. Select **Settings** > **General Settings** > **Fax Settings** > **Receive Settings** > **Fax Output Settings**.
3. If you see a confirmation screen, select **OK**.

4. Select **Save to Inbox**.
5. Set **Save to Inbox** to **On**.
6. Select **Options when memory is full** and choose an option.
7. Select **Inbox Password Settings** to set, change, or reset the password for the inbox.

Note: You cannot set an Inbox password if you set **Options when memory is full** to **Receive and print faxes**.

8. Press the  home button.
9. Select  received fax. Enter the inbox password, if necessary.
10. Select the fax you want to view.

You see the fax displayed on the screen.



11. Select the  icon.
12. Select one of the printing or deleting options, and follow the on-screen instructions.



Note: Delete faxes after you print or view them to prevent the product's memory from filling up. When the memory is full, you can only print or reject incoming faxes.

Parent topic: [Receiving Faxes](#)

Checking Fax Status

You can check the status of current fax jobs, or faxes that have been received or sent on the product control panel.



1. Press the  home button, if necessary.
2. Select **Fax**.
3. Select the  icon.
4. To check the history of faxes that have been sent, received, or saved, select **Transmission Log** and select the job you want to check.

Note: If you see a numbered icon above the  received fax icon on your product's LCD screen or the  received fax light is flashing, received faxes have been temporarily saved to the product's memory.

Parent topic: [Faxing](#)

Printing Fax Reports

You can print several types of fax reports whenever necessary. You can also print the fax log printed automatically by turning on **Fax Log Auto Print**.

1. Press the  home button, if necessary.
2. Select **Fax**.
3. Select the  icon.
4. Select **Fax Report**.
5. Select the fax report you want to print.

Note: To change the report format, select **Settings > General Settings > Fax Settings > Report Settings** on the LCD screen, and then change the **Attach Fax image to report** or **Report Format** settings.

[Fax Report Options](#)

Parent topic: [Faxing](#)

Fax Report Options

Select the fax report or list you want to print.

Last Transmission

Prints a report for the previously sent fax or fax received through polling.

Fax Log

Prints the fax log.

Fax Settings List

Prints the current fax settings.

Protocol Trace

Prints a detailed report for the previously sent or received fax.

Parent topic: [Printing Fax Reports](#)

Replacing Ink Cartridges and Maintenance Boxes

The maintenance box stores ink that gets flushed from the system during print head cleaning. When an ink cartridge is expended or the maintenance box is at the end of its service life, you need to replace it.

You may also need to replace a cartridge that is more than six months old if your printouts do not look their best, even after cleaning and aligning the print head.

Note: Please dispose of your used Epson branded ink cartridges and maintenance boxes responsibly and in accordance with local requirements. If you would like to return your used ink cartridges and maintenance boxes to Epson for proper disposal, please go to [epson.com/recycle](https://www.epson.com/recycle) for more information.

Ink Safety Precautions

[Check Cartridge and Maintenance Box Status](#)

[Purchase Epson Ink Cartridges and Maintenance Box](#)

[Removing and Installing Ink Cartridges](#)

[Printing with Black Ink and Expended Color Cartridges](#)

[Conserving Low Black Ink with Windows](#)

[Maintenance Box Replacement](#)

Related concepts

[Purchase Epson Ink Cartridges and Maintenance Box](#)

Ink Safety Precautions

- Keep ink cartridges and maintenance box out of the reach of children and do not drink the ink.
- Keep the ink cartridges out of direct sunlight.
- Store ink cartridges in a cool, dark place; do not store the ink cartridges in high or freezing temperatures.
- Be careful when you handle used ink cartridges; there may be ink remaining around the ink supply port. If ink gets on your skin, wash it off with soap and water. If it gets in your eyes, flush them immediately with water. If you experience discomfort or vision problems after flushing your eyes, see a doctor immediately. If ink gets in your mouth, see a doctor immediately.
- Do not dismantle an ink cartridge. This could damage the print head.
- Do not disassemble or modify the ink cartridge or maintenance box; otherwise ink may get into your eyes or on your skin or you may not be able to print normally.

- Do not shake cartridges too vigorously; this can cause them to leak.
- Do not squeeze the ink cartridges; this can cause leakage.
- Do not drop or knock ink cartridges against hard objects; this can cause leakage.
- Do not remove or tear the label on the cartridge; this can cause leakage.
- Use an ink cartridge before the date printed on its package or within six months of opening the package, whichever is earlier.
- Store ink cartridges with their bottoms down. Do not store cartridges upside down.
- After bringing an ink cartridge inside from a cold storage site, allow it to warm up at room temperature for at least three hours before using it.
- Do not open the ink cartridge package until you are ready to install it in the printer. The cartridge is vacuum packed to maintain its reliability. Leaving a cartridge unpacked for a long time before using it may prevent normal operation.
- Do not break the hooks on the side of the cartridge when removing it from the packaging.
- Do not shake cartridges after opening their packages; this can cause them to leak.
- You must remove the yellow tape from the cartridge before installing it; otherwise, print quality may decline or you may not be able to print.
- Do not remove the transparent seal from the bottom of the cartridge. This may cause the cartridge to become unusable.
- Do not touch the green IC chip on the side of the cartridge. This may prevent normal operation.
- Make sure to install all ink cartridges. The printer only works when all ink cartridges are properly installed.
- Do not replace ink cartridges with the power off. Do not move the print head by hand; otherwise, you may damage the printer.
- Do not turn off the product during ink charging. If ink charging is incomplete, you may not be able to print.
- If you remove an ink cartridge for later use, protect the ink supply area from dirt and dust and store it in the same environment as the product. Note that there is a valve in the ink supply port, making covers or plugs unnecessary, but care is needed to prevent the ink from staining items that the cartridge touches. Do not touch the ink cartridge ink supply port or surrounding area.
- Install a new ink cartridge immediately after removing an expended one. Leaving cartridges uninstalled can dry out the print head and may prevent the product from printing.

- Do not turn off the printer during cartridge replacement. Otherwise, ink remaining in the print head nozzles will dry out and you may not be able to print.
- Only remove an ink cartridge when you are ready to replace it. Ink cartridges with low ink status may not be used when reinserted.
- Do not put your hand inside the product or touch any cartridges during printing.
- Removed ink cartridges may have ink around the ink supply port, so be careful not to get any ink on the surrounding area when removing the cartridges.

Ink Consumption

- This printer uses ink cartridges equipped with a green chip that monitors information such as the amount of remaining ink for each cartridge. This means that even if the cartridge is removed from the printer before it is expended, you can still use the cartridge after reinserting it back into the printer. However, when reinserting a cartridge, some ink may be consumed to guarantee printer performance.
- To ensure you receive premium print quality and to help protect your print head, a variable ink safety reserve remains in the cartridge when your printer indicates that it is time to replace the cartridge. Quoted ink yields do not include this reserve.
- Quoted yields may vary depending on the images that you are printing, the paper type that you are using, the frequency of your prints and environmental conditions such as temperature.
- Do not use the cartridges that came with the printer for the replacement. The ink in the ink cartridges supplied with your printer is partly used during initial setup. In order to produce high quality printouts, the print head in your printer needs to be fully charged with ink. This process consumes a quantity of ink and, therefore, these cartridges may print fewer pages compared to subsequent ink cartridges.
- To maintain optimum print head performance, some ink is consumed from all ink cartridges during maintenance operations. Ink may also be consumed when you replace an ink cartridge or turn the printer on.
- When printing in monochrome or grayscale, color inks may be used instead of black ink depending on the paper type or print quality settings you are using.

Parent topic: [Replacing Ink Cartridges and Maintenance Boxes](#)

Check Cartridge and Maintenance Box Status

Your product and its software will let you know when an ink cartridge is low or expended, or when the maintenance box needs to be replaced.

[Checking Cartridge and Maintenance Box Status on the LCD Screen](#)



[Checking Cartridge and Maintenance Box Status - Windows](#)

[Checking Cartridge and Maintenance Box Status - Mac](#)

Parent topic: [Replacing Ink Cartridges and Maintenance Boxes](#)

Checking Cartridge and Maintenance Box Status on the LCD Screen

You can check the status of the cartridges and maintenance box using the product's LCD screen.

1. Press the  home button, if necessary.
2. Select the  icon.

Note: The displayed ink and maintenance box levels are approximate.

3. To print a sheet with more information on the ink cartridges and maintenance box, select **Print Supply Status Sheet**.

Parent topic: [Check Cartridge and Maintenance Box Status](#)

Related concepts

[Maintenance Box Replacement](#)



Related tasks

[Removing and Installing Ink Cartridges](#)

Checking Cartridge and Maintenance Box Status - Windows

A low ink reminder appears if you try to print when ink is low, and you can check your cartridge or maintenance box status at any time using a utility on your Windows computer.

Note: You can continue printing while the low ink message is displayed. Replace the ink cartridges when required.

1. To check your status, access the Windows Desktop and double-click the  icon for your product in the right side of the Windows taskbar, or click the up arrow and double-click . Then click **Details**.

You see this window:



2. Replace or reinstall the maintenance box or any ink cartridge as indicated on the screen.

Note: If any of the cartridges installed in the product is broken, incompatible with the product model, or improperly installed, Epson Status Monitor will not display an accurate cartridge status.

3. To disable the low ink reminder, right-click the product icon in the Windows taskbar and select **Monitoring Preferences**.

You see this window:

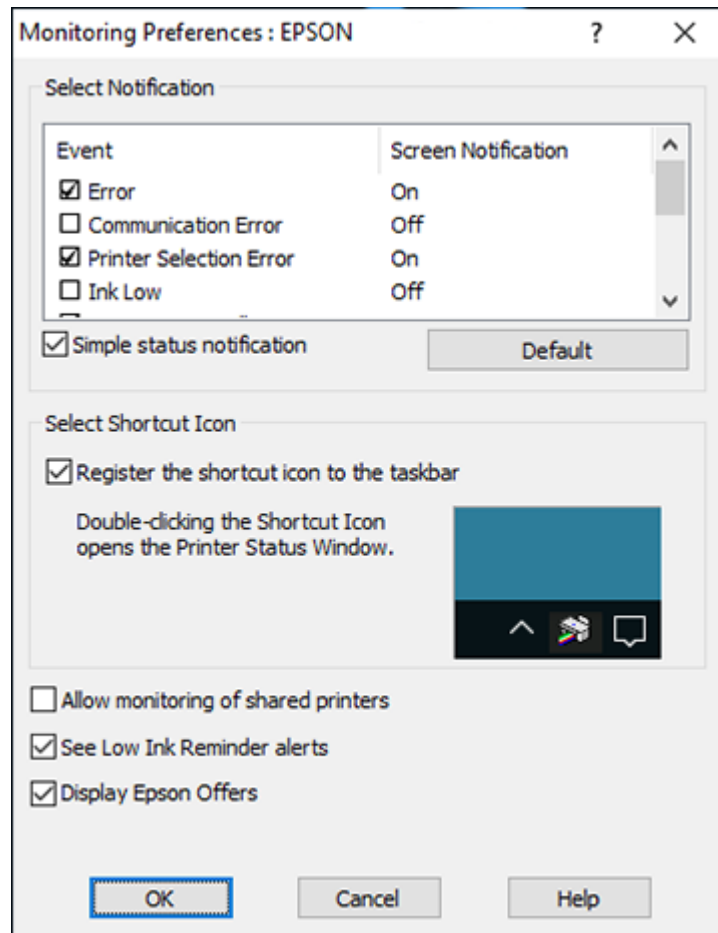

4. Deselect the **See Low Ink Reminder alerts** checkbox at the bottom of the screen.
5. To disable promotional offers, deselect the **Display Epson Offers** checkbox.
6. Click **OK**.

Parent topic: [Check Cartridge and Maintenance Box Status](#)

Related concepts

[Maintenance Box Replacement](#)

Related tasks

[Removing and Installing Ink Cartridges](#)

Checking Cartridge and Maintenance Box Status - Mac

You can check the status of your ink cartridges and maintenance box using a utility on your Mac.

Note: You can continue printing while the low ink message is displayed. Replace the ink cartridges when required.

1. In the Apple menu or the Dock, select **System Preferences**. Select **Print & Fax**, **Print & Scan**, or **Printers & Scanners**, select your product, and select **Options & Supplies**. Select **Utility** and select **Open Printer Utility**.
2. Select **EPSON Status Monitor**.

You see this window:

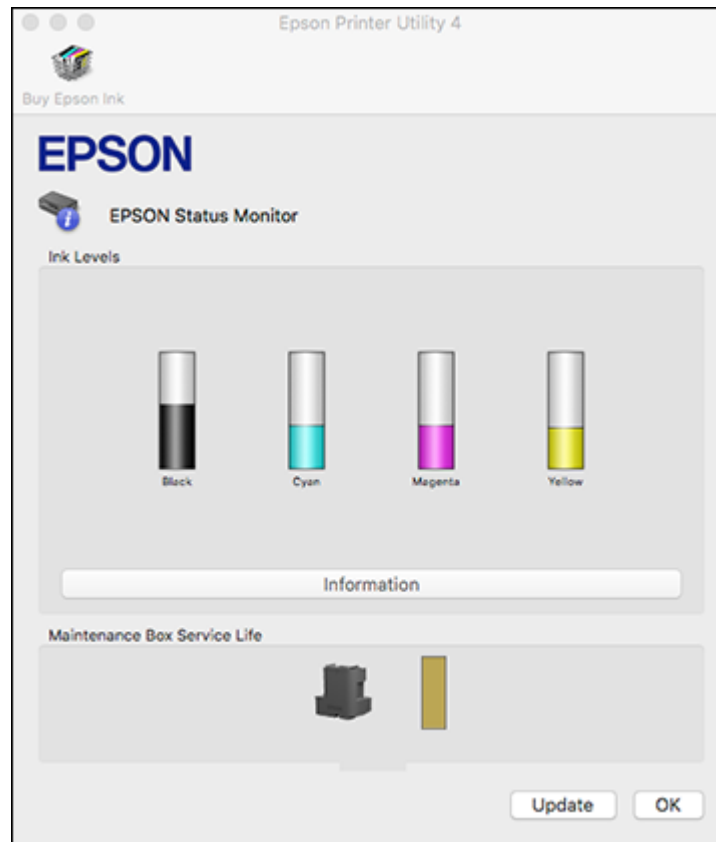

3. Do the following as necessary:

- You can update the ink cartridge and maintenance box status by clicking **Update**.
- Replace or reinstall the maintenance box or any ink cartridge as indicated on the screen.

Note: If any of the cartridges installed in the product is broken, incompatible with the product model, or improperly installed, Epson Status Monitor will not display an accurate cartridge status.

Parent topic: [Check Cartridge and Maintenance Box Status](#)

Related concepts[Maintenance Box Replacement](#)**Related tasks**[Removing and Installing Ink Cartridges](#)

Purchase Epson Ink Cartridges and Maintenance Box

You can purchase genuine Epson ink, maintenance boxes, and paper at epson.com (U.S. sales) or epson.ca (Canadian sales). You can also purchase supplies from an Epson authorized reseller. To find the nearest one, call 800-GO-EPSON (800-463-7766) in the U.S. or 800-807-7766 in Canada.

Note: Your printer is designed to work only with genuine Epson-brand ink cartridges. Other brands of ink cartridges and ink supplies are not compatible and, even if described as compatible, may not function properly or at all. Epson periodically provides firmware updates to address issues of security, performance, minor bug fixes and ensure the printer functions as designed. These updates may affect the functionality of third-party ink. Non-Epson branded or altered Epson cartridges that functioned prior to a firmware update may not continue to function.

The included initial cartridges are designed for reliable printer setup and cannot be used as replacement cartridges or resold. After setup, the remaining ink is available for printing. Yields are based on ISO 24711 in default mode, printing continuously. Yields vary due to print images, settings, and temperatures. Printing infrequently or primarily with one color reduces yields. All cartridges must be installed with ink for printing and printer maintenance. For print quality, some ink remains in replaced cartridges.

[Ink Cartridge and Maintenance Box Part Numbers](#)**Parent topic:** [Replacing Ink Cartridges and Maintenance Boxes](#)

Ink Cartridge and Maintenance Box Part Numbers

Use these part numbers when you order or purchase a new maintenance box or ink cartridges.

Maintenance box part number: T04D1

Note: For best printing results, use up a cartridge within 6 months of opening the package.

Ink color	Part number	
	Standard-capacity	High-capacity
Black	222120	222XL120

Ink color	Part number	
	Standard-capacity	High-capacity
Cyan	222220	–
Magenta	222320	–
Yellow	222420	–

Parent topic: [Purchase Epson Ink Cartridges and Maintenance Box](#)

Related references

[Ink Cartridge Specifications](#)

Removing and Installing Ink Cartridges

Make sure you have your replacement cartridges handy before you begin. You must install new cartridges immediately after removing the old ones.

Caution: Leave your old cartridges in the product until you are ready to replace them to prevent the print head nozzles from drying out. Do not open ink cartridge packages until you are ready to install the ink. Cartridges are vacuum packed to maintain reliability.

Note: If you remove a low or expended ink cartridge, you cannot re-install and use the cartridge.

1. Turn on your product.

- If an ink cartridge is expended, you see a message on the LCD screen. Note which cartridges need to be replaced and follow the on-screen instructions or the instructions below to replace the cartridge.
- If you are replacing a cartridge before you see a message on the LCD screen, press the  home button if necessary, and select **Maintenance > Ink Cartridge(s) Replacement > Next > Start**.

Note: You can also select **How To** to view ink replacement instructions on the LCD screen.

2. Lift up the scanner unit until it locks into place.

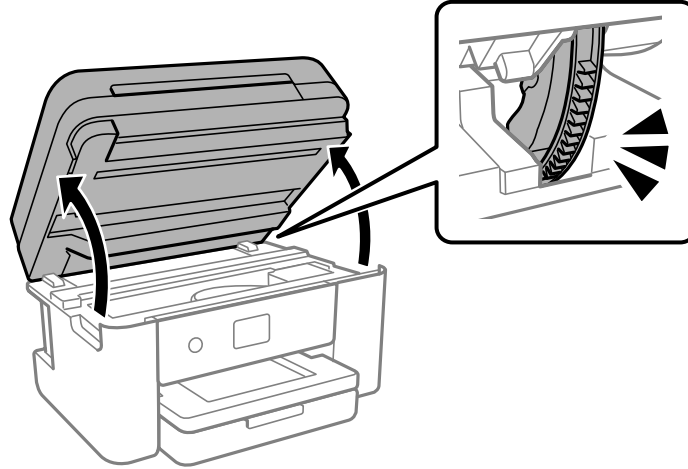

Caution: Do not move the print head by hand; otherwise, you may damage your product. Do not touch the flat white cable or translucent film inside the product.

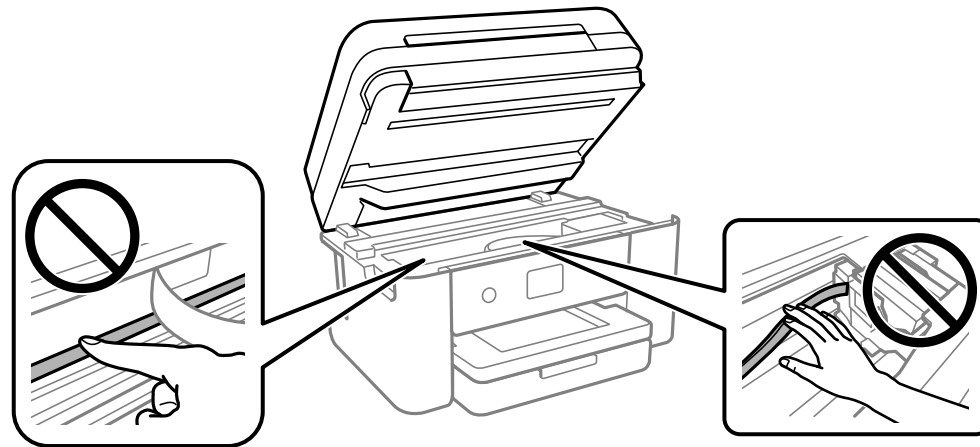

3. Squeeze the tab on the cartridge and lift the cartridge straight up to remove it.

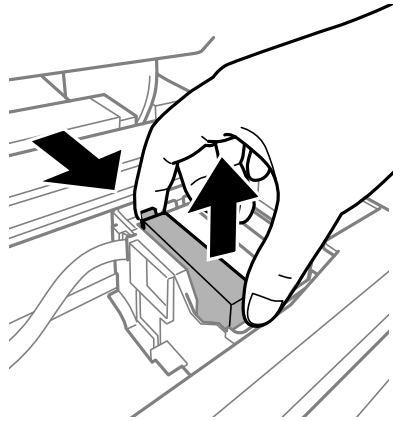

Note: Dispose of used cartridges carefully. Do not take the used cartridge apart or try to refill it.

Warning: If ink gets on your skin, wash it thoroughly with soap and water. If ink gets into your eyes, flush them immediately with water. If ink gets into your mouth, spit it out and see a doctor right away. Keep ink cartridges out of the reach of children.

4. If you are replacing the black ink cartridge, gently shake the new black ink cartridge four or five times before unpacking it. Do not shake the color ink cartridges.

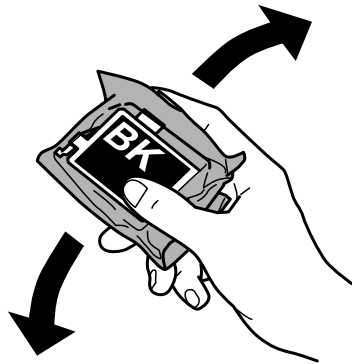

Caution: Do not shake the cartridges after opening the packages, or ink may leak.

5. Remove the cartridge from the package.

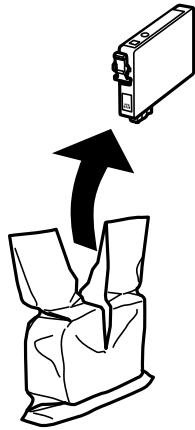

Caution: Do not touch the areas shown here. Doing so may prevent normal operation and printing.

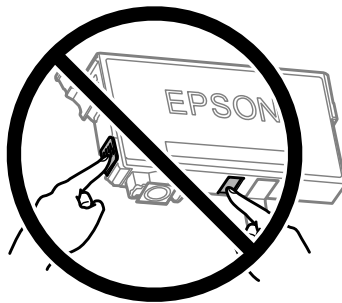

6. Remove the yellow tape from the cartridge.

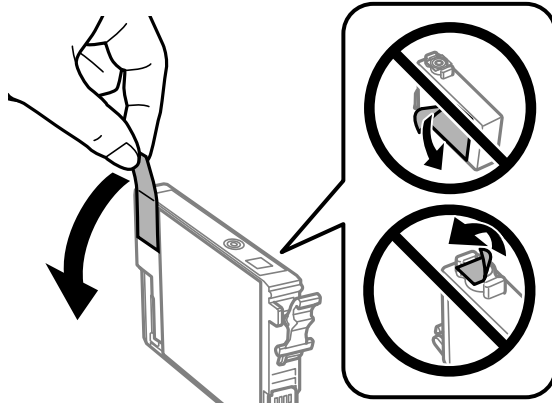

Caution: Do not remove any other labels or seals, or the ink cartridge may leak or become unusable.

7. Insert the new cartridge into the holder and push it down until it clicks into place and is level with the other cartridges.

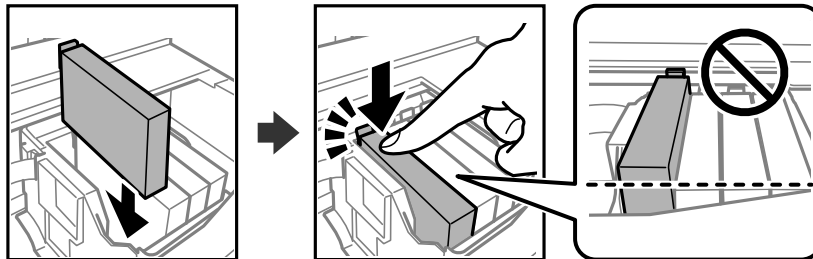

8. Lower the scanner unit. Continue to lower the scanner unit even if you feel some resistance.

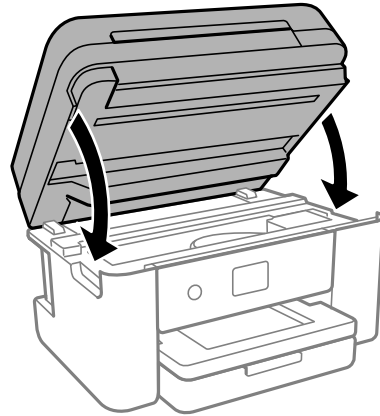

Caution: Be careful not to trap your hand or fingers when opening or closing the scanner unit or you may be injured.

9. Select **Completed** on the LCD screen.

The print head moves to its home position and the product starts charging the ink. This takes a few minutes. When you see a completion message on the screen, ink replacement is finished.

Caution: Do not turn off the product while ink is charging or you may not be able to print.

Caution: If you remove an ink cartridge for later use, protect the ink supply area from dirt and dust and store it in the same environment as the printer. The valve in the ink supply port is designed to contain any excess ink, but do not touch the ink supply port or surrounding area. Always store ink cartridges with the label facing up; do not store cartridges upside-down.

Parent topic: [Replacing Ink Cartridges and Maintenance Boxes](#)

Related concepts

[Purchase Epson Ink Cartridges and Maintenance Box](#)

Related references

[Ink Safety Precautions](#)

Related tasks

[Viewing Animations](#)

Printing with Black Ink and Expended Color Cartridges

When a color ink cartridge is expended, you can temporarily continue printing using black ink. Replace the expended color cartridge as soon as possible for future printing.

[Printing with Expended Color Cartridges - Control Panel](#)

[Printing with Expended Color Cartridges - Windows](#)

[Printing with Expended Color Cartridges - Mac](#)

Parent topic: [Replacing Ink Cartridges and Maintenance Boxes](#)

Printing with Expended Color Cartridges - Control Panel

If you see a message on the control panel to replace a color ink cartridge, you can temporarily print or copy in black ink.

Note the following restrictions when using this feature:

- You can print or copy only on plain paper, letterhead, or envelopes
 - You can print or copy only in black or grayscale
 - You cannot select borderless printing or copying
1. When you see a message on the LCD screen to replace a color ink cartridge, select **Proceed**.
You see a message that you can temporarily print with black ink.
 2. Select **Proceed** again.
 3. If you want to print or copy in black only, select **No, remind me later**.
The current print job is canceled.
 4. Press the  home button, if necessary.
 5. Try printing or copying again.

Parent topic: [Printing with Black Ink and Expended Color Cartridges](#)

Printing with Expended Color Cartridges - Windows

If you see a message during printing telling you that you can temporarily print in black ink with an expended color cartridge, you can cancel your print job and select settings to print on plain paper, letterhead, or on an envelope.

Note: If you are using your Epson product with the Windows 10 S operating system, you cannot use the software described in this section. You also cannot download and install any Epson product software

from the Epson website for use with Windows 10 S; you must obtain software only from the Windows Store.

Note: To use this feature, Epson Status Monitor must be enabled.

1. Click **Cancel** or **Cancel Print** to cancel your print job.

Note: If the message screen appears on another computer on a network, you may need to cancel the print job using the product control panel.

2. Load plain paper, letterhead, or an envelope in your product.
3. Access the print settings in your print application.
4. Click the **Main** tab and make sure **Borderless** is not selected.
5. Select **Plain Paper/Bright White Paper**, **Letterhead**, or **Envelope** as the paper type setting.
6. Select the **Black/Grayscale** checkbox.
7. Click **OK**.
8. Print your document.

Epson Status Monitor 3 displays a print message.

9. Click **Print in Black** to print your document.

Parent topic: [Printing with Black Ink and Expended Color Cartridges](#)

Printing with Expended Color Cartridges - Mac

If printing stops, you can cancel your print job and select settings to temporarily print with only black ink on plain paper, letterhead, or on an envelope.

1. Click the printer icon in the Dock.
2. If you see a message telling you that you can temporarily print with only black ink, click the **Delete** or  button to cancel your print job. If you see an error message, click **OK**.

Note: If the message screen appears on another computer on a network, you may need to cancel the print job using the product control panel.

3. In the Apple menu or the Dock, select **System Preferences**.

4. Select **Print & Fax**, **Print & Scan**, or **Printers & Scanners**, select your product, and select **Options & Supplies**.
5. Select **Driver** or **Options**.

You see a screen like this:

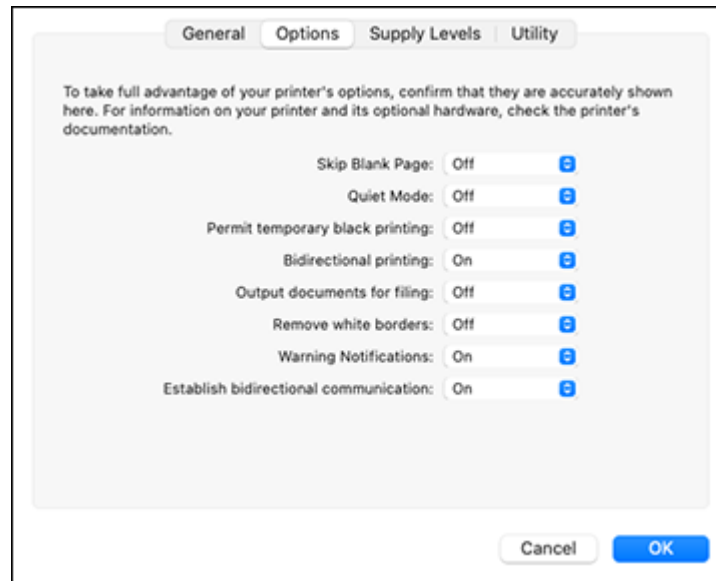

6. Select **On** as the **Permit temporary black printing** setting.
7. Click **OK**.
8. Close the utility window.
9. Load plain paper or an envelope in your product.
10. Access the print settings in your print application.
11. Select **Print Settings** from the pop-up menu.
12. Select a non-borderless paper size as the paper size setting.
13. Select **Plain Paper/Bright White Paper**, **Letterhead**, or **Envelope** as the paper type setting.
14. Select the **Grayscale** option.
15. Select any other options as needed.

16. Click **Print** to print your document.

Parent topic: [Printing with Black Ink and Expended Color Cartridges](#)

Conserving Low Black Ink with Windows

The following window appears when black ink runs low and there is more color ink.

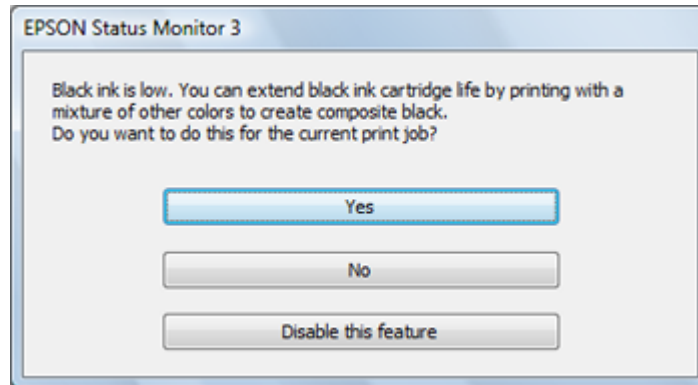

Note: The window appears only when you have selected **Plain Paper/Bright White Paper** or **Letterhead** as the paper type setting, and depends on other selected print settings. To use this feature, Epson Status Monitor must be enabled.

- Click **Yes** to use a mixture of color inks to create black, or **No** to continue using the remaining black ink for the document you are printing.
- Click **Disable this feature** to continue using the remaining black ink.

Note: If you disable this feature, it remains disabled until you install a new black ink cartridge.

Parent topic: [Replacing Ink Cartridges and Maintenance Boxes](#)

Maintenance Box Replacement

The maintenance box stores surplus ink that gets collected during printing or print head cleaning. When you see a message on the LCD screen, follow the on-screen instructions to replace the maintenance box.

Note: When the maintenance box is full, you cannot print or clean the print head until it is replaced. However, you can perform operations that do not require ink, such as scanning.

Note the following precautions when replacing the maintenance box:

- Do not touch the green chip on the side of the maintenance box.
- Do not drop the maintenance box or subject it to strong shocks.
- Do not replace the maintenance box during printing; otherwise, ink may leak.
- Do not remove the maintenance box or its cover except when replacing the maintenance box; otherwise, ink may leak.
- If you cannot replace the cover, the maintenance box may not be installed correctly. Remove the maintenance box and reinstall it.
- Do not tilt the maintenance box after removing it; otherwise, ink may leak.
- Do not touch the openings in the maintenance box or you may get ink on you.
- Do not reuse a maintenance box that has been removed and left uninstalled for a long period.
- Keep the maintenance box out of direct sunlight.
- Do not store the maintenance box in high or freezing temperatures.

Note: The maintenance box is a user-replaceable part and is not covered by the product warranty.

Parent topic: [Replacing Ink Cartridges and Maintenance Boxes](#)

Adjusting Print Quality

If your print quality declines, you may need to run a utility to clean or align the print head.

Note: If you are using your Epson product with the Windows 10 S operating system, you cannot use the software described in this section. You also cannot download and install any Epson product software from the Epson website for use with Windows 10 S; you must obtain software only from the Windows Store.

If running these utilities does not solve the problem, you may need to replace the ink cartridges.

[Print Head Maintenance](#)

[Power Cleaning](#)

[Print Head Alignment](#)

[Cleaning the Paper Guide](#)

Print Head Maintenance

If your printouts become too light, or you see dark or light bands across them, you may need to clean the print head nozzles. Cleaning uses ink, so clean the nozzles only if print quality declines.

You can check for clogged nozzles before you clean them so you don't clean them unnecessarily.

If you still see white or dark lines or missing nozzles in your printouts, even after cleaning the print head several times, you can run a Power Cleaning.

Note: You cannot clean the print head if an ink cartridge is expended, and may not be able to clean it when a cartridge is low. You must replace the cartridge first.

[Print Head Nozzle Check](#)

[Print Head Cleaning](#)

Parent topic: [Adjusting Print Quality](#)

Related concepts

[Purchase Epson Ink Cartridges and Maintenance Box](#)

[Maintenance Box Replacement](#)

Related tasks

[Removing and Installing Ink Cartridges](#)

Print Head Nozzle Check

You can print a nozzle check pattern to check for clogged nozzles.

[Checking the Nozzles Using the Product Control Panel](#)

[Checking the Nozzles Using a Computer Utility](#)

Parent topic: [Print Head Maintenance](#)

Checking the Nozzles Using the Product Control Panel

You can check the print head nozzles using the control panel on your product.

1. Load a few sheets of plain paper in the product.
2. Press the  home button, if necessary.
3. Select **Maintenance** > **Print Head Nozzle Check**.
4. Select **Print**.

The nozzle pattern prints.

5. Check the printed pattern to see if there are gaps in the lines.

Print head is clean

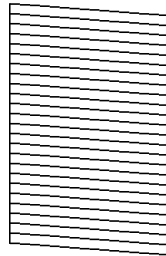

Print head needs cleaning

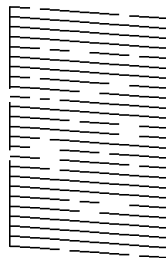

Print head needs Power Cleaning

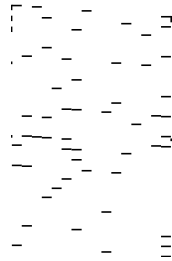

6. Do one of the following:
 - If there are no gaps, select **O**.
 - If there are gaps or the pattern is faint, select **X** and continue. Follow the instructions on the screen to clean the print head.
 - If most lines are missing or not printed, most of the nozzles are clogged. Select **O** and then run a Power Cleaning. See the link below.
7. Follow the instructions on the screen to clean the print head, check the nozzles, and repeat the process as necessary.

Caution: Never turn off the product or open the scanner unit during a cleaning cycle or you may not be able to print.

If you don't see any improvement after cleaning the print head up to 3 times, turn the product off using the  power button and wait at least 12 hours. Then run a nozzle check and try cleaning the print head again, if necessary. If quality still does not improve, run a Power Cleaning.

Parent topic: [Print Head Nozzle Check](#)

Related tasks

[Cleaning the Print Head Using the Product Control Panel](#)



[Power Cleaning Using the Product Control Panel](#)

Related topics

[Loading Paper](#)

Checking the Nozzles Using a Computer Utility

You can check the print head nozzles using a utility on your Windows or Mac computer.

1. Load a few sheets of plain paper in the product.
2. Do one of the following:
 - **Windows:** Access the Windows Desktop and right-click the  icon for your product in the right side of the Windows taskbar, or click the up arrow and right-click .
 - **Mac:** In the Apple menu or the Dock, select **System Preferences**. Select **Print & Fax**, **Print & Scan**, or **Printers & Scanners**, select your product, and select **Options & Supplies**. Select **Utility** and select **Open Printer Utility**.
3. Select **Nozzle Check** or **Print Head Nozzle Check**.

You see a window like this:

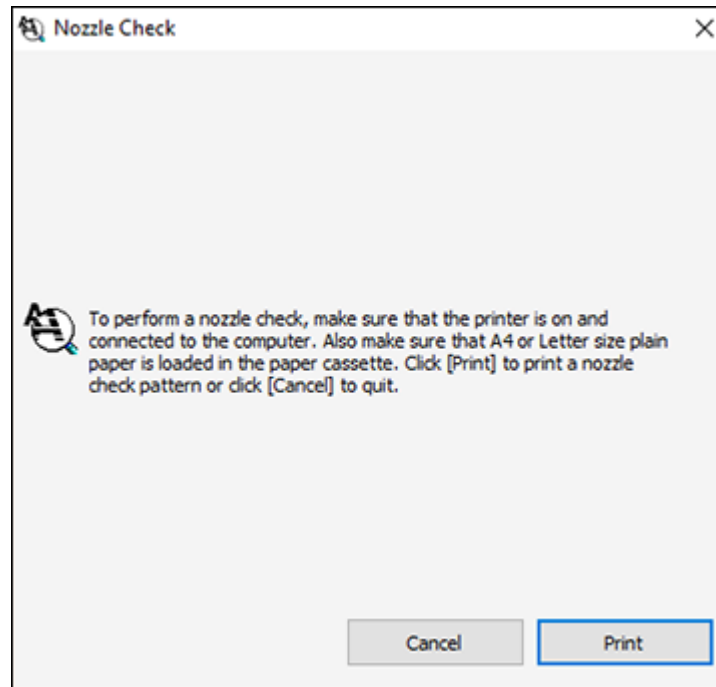

4. Click **Print**.

5. Check the printed pattern to see if there are gaps in the lines.

Print head is clean

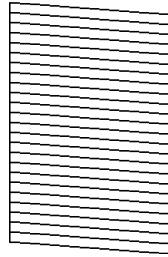

Print head needs cleaning

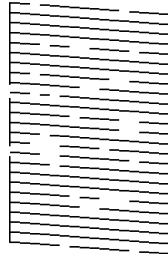

Print head needs Power Cleaning

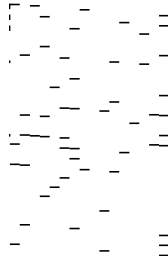

6. Do one of the following:
- If there are no gaps, click **Finish**.

- If there are gaps or the pattern is faint, clean the print head.
- If almost the entire pattern is missing, click **Finish** and perform a Power Cleaning.

If you don't see any improvement after cleaning the print head up to 3 times, turn the product off using the ⏻ power button and wait at least 12 hours. Then run a nozzle check and try cleaning the print head again, if necessary. If quality still does not improve, run a Power Cleaning.

Parent topic: [Print Head Nozzle Check](#)

Related tasks

[Cleaning the Print Head Using a Computer Utility](#)

[Power Cleaning Using a Computer Utility](#)

[Checking the Nozzles Using the Product Control Panel](#)

Related topics

[Loading Paper](#)

Print Head Cleaning

If print quality has declined and the nozzle check pattern indicates clogged nozzles, you can clean the print head.

Note: You cannot clean the print head if an ink cartridge is expended, and may not be able to clean it when a cartridge is low. You must replace the cartridge first.

[Cleaning the Print Head Using the Product Control Panel](#)

[Cleaning the Print Head Using a Computer Utility](#)

Parent topic: [Print Head Maintenance](#)

Related concepts

[Purchase Epson Ink Cartridges and Maintenance Box](#)

[Maintenance Box Replacement](#)

Related tasks

[Removing and Installing Ink Cartridges](#)

Cleaning the Print Head Using the Product Control Panel

You can clean the print head using the control panel on your product. Cleaning uses ink, so clean the print head only if print quality declines.

1. Load a few sheets of plain paper in the product.

2. Press the  home button, if necessary.
3. Select **Maintenance > Print Head Cleaning**.
4. Select **Start** to clean the print head.

The  power light flashes throughout the cleaning cycle and stays on when the cleaning cycle is finished. When the cleaning cycle is finished, a nozzle pattern prints.

Caution: Never turn off the product or open the scanner unit during a cleaning cycle or you may not be able to print.

5. Check the printed pattern to see if there are gaps in the lines.

Print head is clean

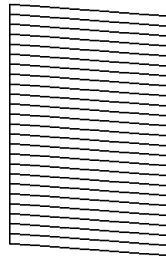

Print head needs cleaning

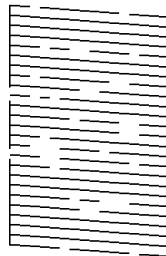

Print head needs Power Cleaning

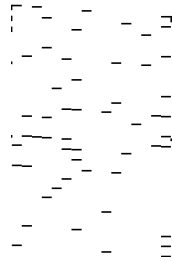

6. Do one of the following:
 - If there are no gaps, select **O**.
 - If there are gaps or the pattern is faint, select **X** and continue. Follow the instructions on the screen to clean the print head.
 - If most lines are missing or not printed, most of the nozzles are clogged. Select **O** and then run a Power Cleaning. See the link below.
7. Select **Print** to print a nozzle check pattern and confirm that the print head is clean.

If you don't see any improvement after cleaning the print head up to 3 times, turn the product off using the **⏻** power button and wait at least 12 hours. Then run a nozzle check and try cleaning the print head again, if necessary. If quality still does not improve, run a Power Cleaning.

Parent topic: [Print Head Cleaning](#)

Related references

[Where to Get Help](#)

Related tasks

[Checking the Nozzles Using the Product Control Panel](#)

[Power Cleaning Using the Product Control Panel](#)



Related topics

[Loading Paper](#)

Cleaning the Print Head Using a Computer Utility

You can clean the print head using a utility on your Windows or Mac computer.

1. Load a few sheets of plain paper in the product.

2. Do one of the following:
 - **Windows:** Access the Windows Desktop and right-click the  icon for your product in the right side of the Windows taskbar, or click the up arrow and right-click .
 - **Mac:** In the Apple menu or the Dock, select **System Preferences**. Select **Print & Fax**, **Print & Scan**, or **Printers & Scanners**, select your product, and select **Options & Supplies**. Select **Utility** and select **Open Printer Utility**.
3. Select **Head Cleaning** or **Print Head Cleaning**.

You see a window like this:

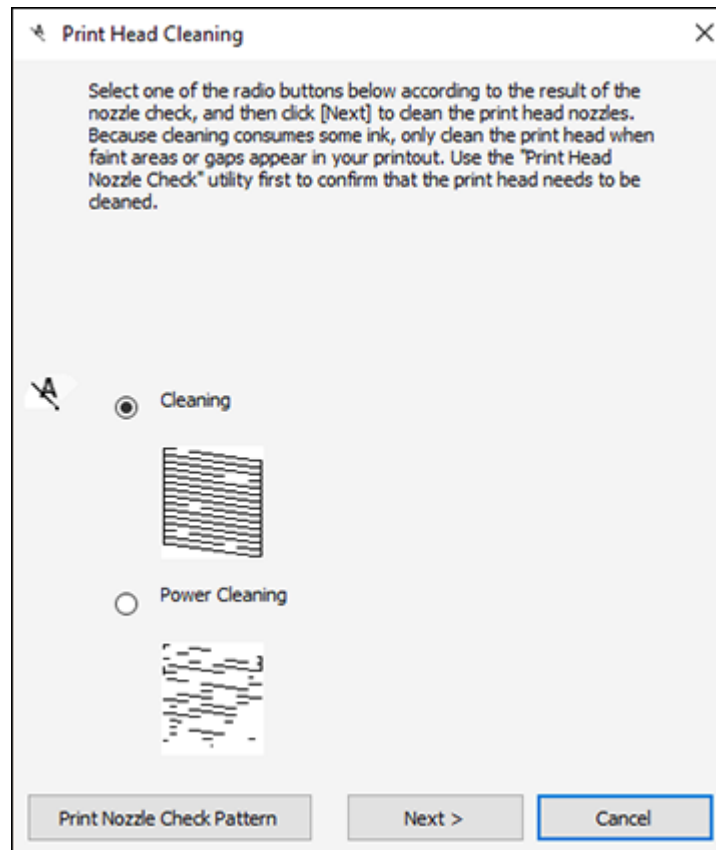

4. Select the cleaning cycle you want to run, based on the nozzle check pattern and click **Next**.

5. Click **Start** to begin the cleaning cycle.

The  power light flashes throughout the cleaning cycle and stays on when the cleaning cycle is finished.

Caution: Never turn off the product or open the scanner unit during a cleaning cycle or you may not be able to print.

6. When the cleaning cycle is finished, you can check to see if the nozzles are clean; click **Print Nozzle Check Pattern** and click **Print**.

7. Check the printed pattern to see if there are gaps in the lines.

Print head is clean

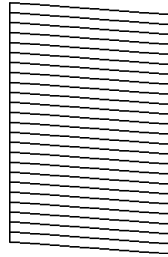

Print head needs cleaning

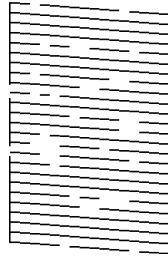

Print head needs Power Cleaning

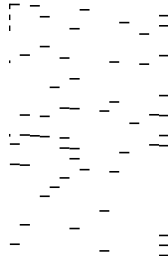

- If there are no gaps, click **Finish**.
- If there are gaps or the pattern is faint, click **Clean** to clean the print head again.

- If almost the entire pattern is missing, click **Finish** and perform a Power Cleaning.

If you don't see any improvement after cleaning the print head up to 3 times, turn the product off using the  power button and wait at least 12 hours. Then run a nozzle check and try cleaning the print head again, if necessary. If quality still does not improve, run a Power Cleaning.

Parent topic: [Print Head Cleaning](#)

Related references

[Where to Get Help](#)

Related tasks

[Checking the Nozzles Using a Computer Utility](#)

[Power Cleaning Using a Computer Utility](#)

[Cleaning the Print Head Using the Product Control Panel](#)

Related topics

[Loading Paper](#)

Power Cleaning

If you still see white or dark lines or missing nozzles in your printouts, even after cleaning the print head several times, you can run a Power Cleaning.

If you do not see improvement after running a Power Cleaning, turn off the product and wait at least 12 hours before printing a nozzle check pattern and running another Power Cleaning or Print Head Cleaning. If quality still does not improve, contact Epson for support.

Note: Power Cleaning consumes more ink than Print Head Cleaning.

[Power Cleaning Using the Product Control Panel](#)

[Power Cleaning Using a Computer Utility](#)

Parent topic: [Adjusting Print Quality](#)

Power Cleaning Using the Product Control Panel

You can run a Power Cleaning using the control panel on your product.

Note: After a Power Cleaning, you must turn off the product and wait at least 12 hours before running another Power Cleaning.

1. Press the  home button, if necessary.

2. Select **Maintenance > Power Cleaning**.
3. Follow the on-screen instructions to run the Power Cleaning.

The  power light flashes throughout the cleaning cycle and stays on when the cleaning cycle is finished. When the Power Cleaning is finished, you see a message on the screen and a nozzle pattern prints.

4. Select **Dismissed**.

If the print quality did not improve, turn off the printer and wait at least 12 hours before running another nozzle check. Run Print Head Cleaning or Power Cleaning depending on the printed pattern.

If the print quality does not improve after running the Power Cleaning utility multiple times, contact Epson for support.

Parent topic: [Power Cleaning](#)

Related references

[Where to Get Help](#)

Related tasks



[Checking the Nozzles Using the Product Control Panel](#)

[Cleaning the Print Head Using the Product Control Panel](#)

Power Cleaning Using a Computer Utility

You can run a Power Cleaning using a utility on your Windows or Mac computer.

Note: After running a Power Cleaning, you must turn off the product and wait at least 12 hours before printing a nozzle check pattern and running another Print Head Cleaning or Power Cleaning.

1. Load a few sheets of plain paper in the product.
2. Do one of the following:
 - **Windows:** Access the Windows Desktop and right-click the  icon for your product in the right side of the Windows taskbar, or click the up arrow and right-click .
 - **Mac:** In the Apple menu or the Dock, select **System Preferences**. Select **Print & Fax**, **Print & Scan**, or **Printers & Scanners**, select your product, and select **Options & Supplies**. Select **Utility** and select **Open Printer Utility**.
3. Select **Print Head Cleaning**.

You see a window like this:

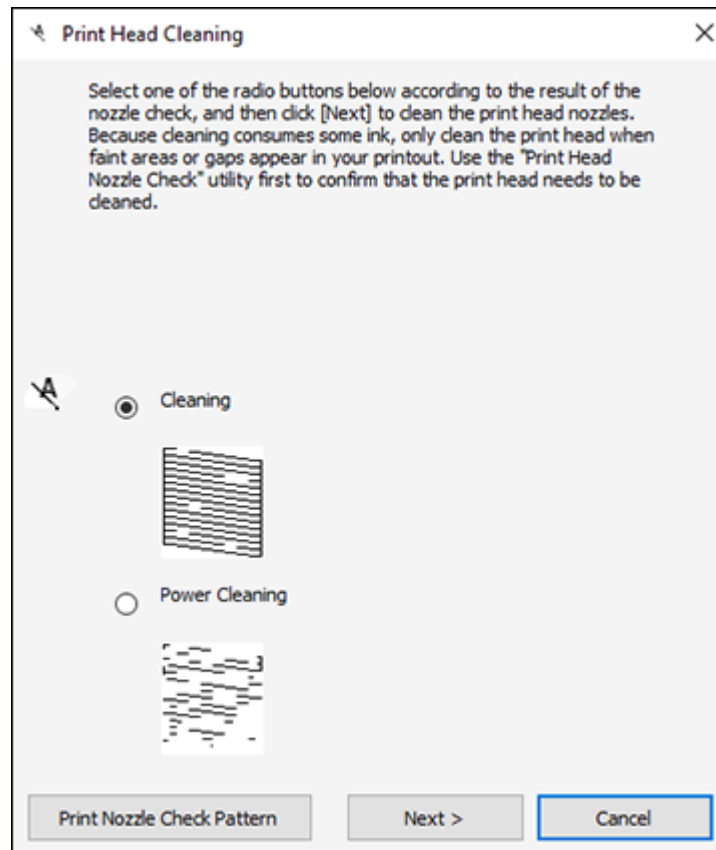

4. Select **Power Cleaning** and click **Next**.
5. Follow the on-screen instructions to run a Power Cleaning.
6. When the Power Cleaning is finished, click **Print Nozzle Check Pattern** and follow the on-screen instructions to print a nozzle check pattern.

If the print quality did not improve, you must turn off the product and wait at least 12 hours before printing a nozzle check pattern and running another Power Cleaning or Print Head Cleaning.

If the print quality does not improve after running the Power Cleaning utility multiple times, contact Epson for support.

Parent topic: [Power Cleaning](#)

Related references

[Where to Get Help](#)

Related tasks

[Cleaning the Print Head Using a Computer Utility](#)

[Checking the Nozzles Using a Computer Utility](#)

Print Head Alignment

If your printouts become grainy or blurry, you notice misalignment of vertical lines, or you see dark or light horizontal bands, you may need to align the print head.

Note: Banding may also occur if your print head nozzles need cleaning.

[Aligning the Print Head Using the Product Control Panel](#)

Parent topic: [Adjusting Print Quality](#)

Aligning the Print Head Using the Product Control Panel

If your printouts become grainy or blurry, you notice misalignment of vertical lines, or you see dark or light horizontal bands, you may need to align the print head.

Note: Banding may also occur if your print head nozzles need cleaning.

1. Load a few sheets of plain paper in the product.
2. Press the  home button, if necessary.
3. Select **Maintenance > Print Head Alignment**.
4. If your printout contains misaligned vertical lines or is blurry, continue with the next step. If your printout contains horizontal banding, go to step 6.
5. Select **Vertical Alignment** and follow the on-screen instructions to print an alignment sheet.
6. Check the printed pattern on the alignment sheet and for each set of patterns, select the number representing the pattern with the least amount of separation or overlap.
7. Select **Horizontal Alignment** and follow the on-screen instructions to print an alignment sheet.
8. Check the printed pattern on the alignment sheet and select the number representing the pattern with the least amount of separation or overlap.

9. Continue following the rest of the on-screen instructions to finish with the alignment.

Parent topic: [Print Head Alignment](#)

Related topics

[Loading Paper](#)

Cleaning the Paper Guide

If you see ink on the back of a printout, you can clean the paper guide rollers to remove any excess ink.

1. Load plain paper in this size: Letter (8.5 × 11 inches [216 × 279 mm]) or A4 (8.3 × 11.7 inches [210 × 297 mm]).
2. Press the  home button, if necessary.
3. Select **Maintenance > Paper Guide Cleaning**.
4. Follow the on-screen instructions to clean the paper guide.
5. Repeat these steps as necessary until the paper comes out clean.
6. If the paper is still smeared with ink, turn off the product and open the scanner unit.

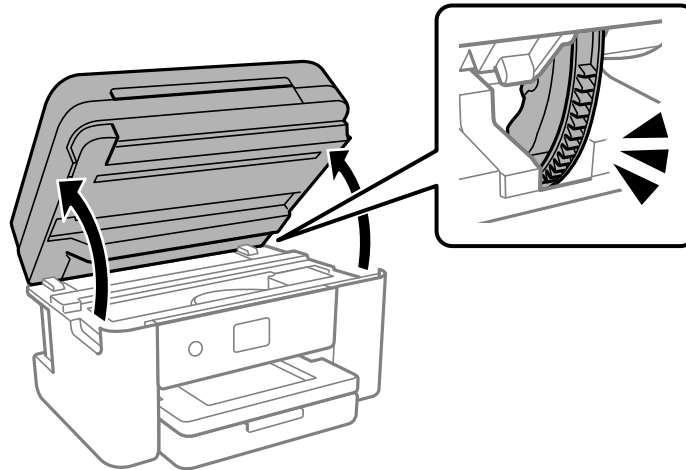

Caution: Do not touch the flat white cable or translucent film inside the product. Be careful not to trap your hand or fingers when opening or closing the scanner unit.

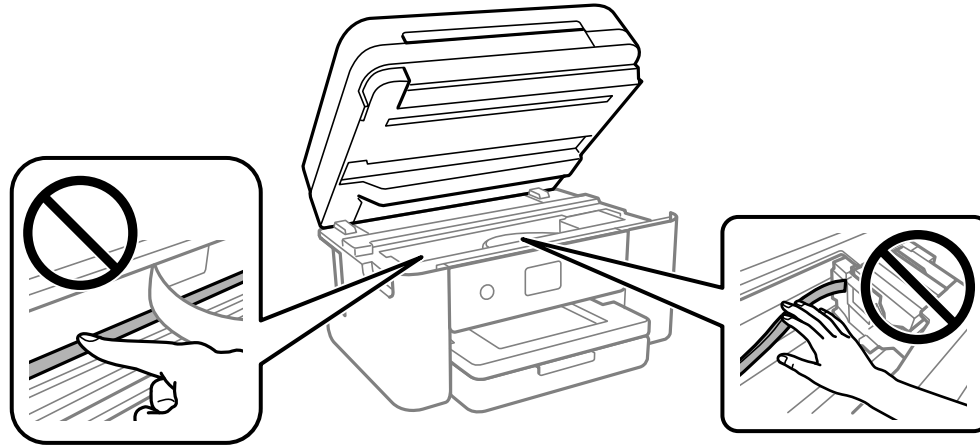

7. Using a cotton swab, wipe off any ink smears on the part shown in the illustration below.

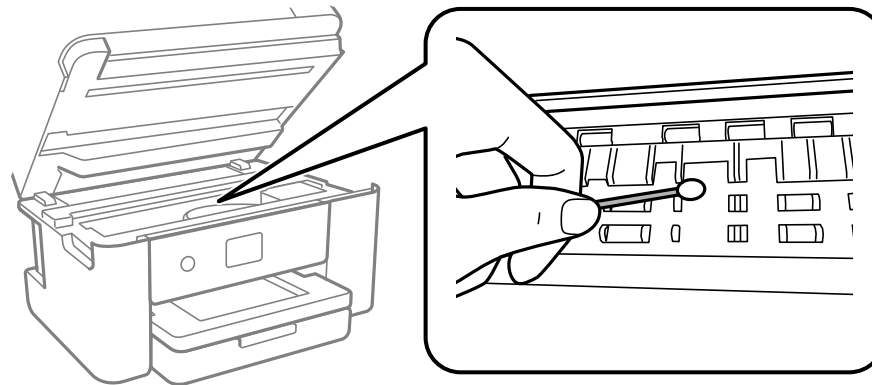

Caution: Do not use tissue paper to clean the inside of the product as lint can clog the print head nozzles.

8. Close the scanner unit.

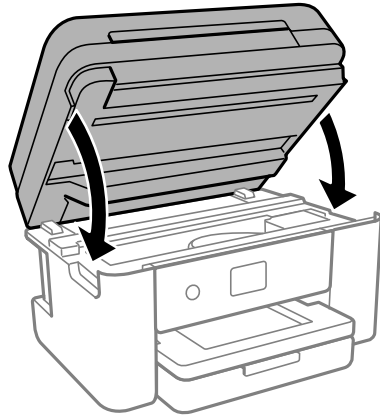

Parent topic: [Adjusting Print Quality](#)

Related concepts

[Print Head Alignment](#)

[Print Head Cleaning](#)

Related tasks

[Cleaning the Print Head Using a Computer Utility](#)

[Cleaning the Print Head Path](#)

Related topics

[Loading Paper](#)

Cleaning and Transporting Your Product

See these sections if you need to clean or transport your product.

[Cleaning Your Product](#)

[Cleaning the Paper Rollers](#)

[Cleaning the Print Head Path](#)

[Transporting Your Product](#)

Cleaning Your Product

To keep your product working at its best, you should clean it several times a year.

Caution: Do not use a hard brush, alcohol, or paint thinner to clean the product or you may damage it. Do not use oil or other lubricants inside the product or let water get inside it. Do not touch the flat white cable or translucent film inside the product.

1. Turn off the product using the  power button.
2. Unplug the power cord.
3. Disconnect any connected cables.
4. Remove all the paper.

5. Open the document cover.

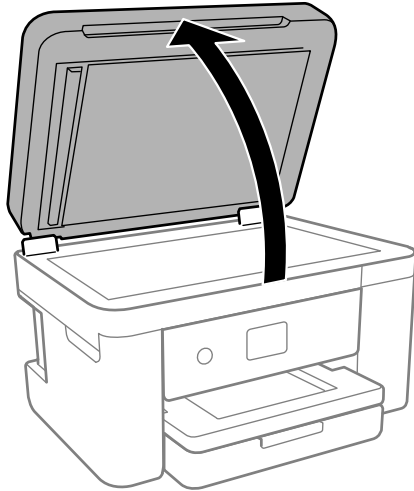

Caution: Be careful not to trap your hand or fingers when opening or closing the document cover.

6. Clean the scanner glass and the glass area on the left with a soft, dry, lint-free cloth (microfiber is recommended). If the glass surface is stained with grease or some other hard-to-remove material, try cleaning with a soft cloth moistened with a mild detergent. Wipe off any remaining liquid.

Caution: Do not spray glass cleaner directly on the glass and do not press the glass surface with any force. Scratches or other damage on the glass surface can decrease the scan quality.

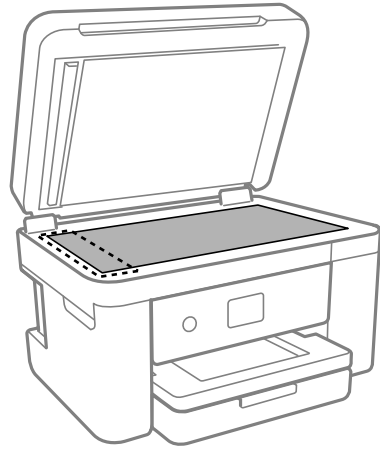

7. Close the document cover.
8. Open the ADF cover.

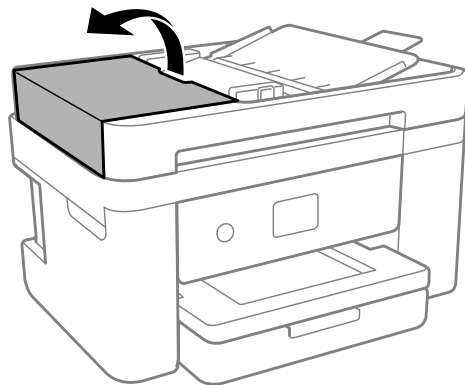

9. Use a soft, lint-free cloth (microfiber is recommended) moistened with a little water to clean the rollers and the interior of the ADF.

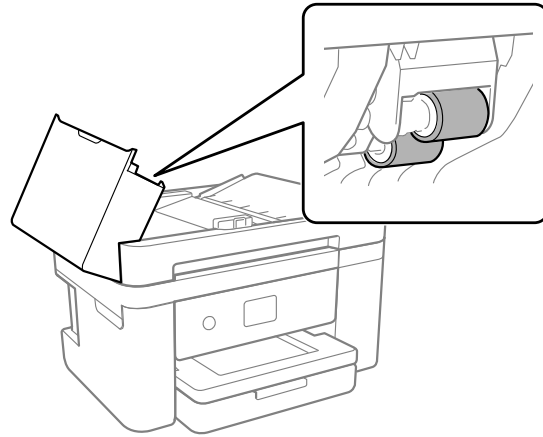

Caution: Do not use a dry cloth to clean the rollers; you may damage them. Use the ADF after the rollers have dried.

10. Open the ADF input tray.

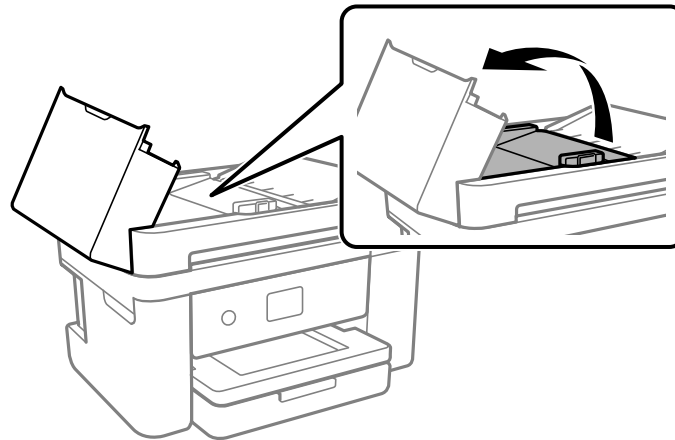

Caution: Make sure the ADF cover is opened before raising the ADF input tray or the ADF may be damaged.

11. Clean the area shown here.

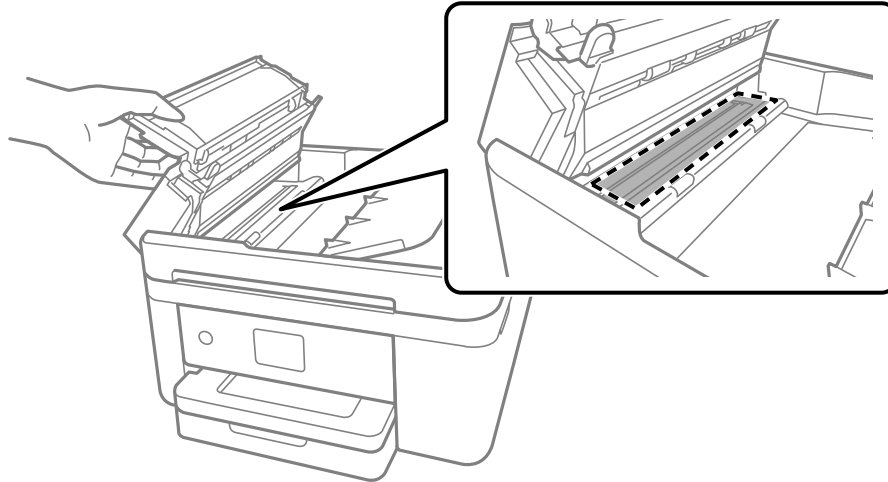

12. Clean the outer case and control panel with a soft, clean cloth moistened with a little water. If you cannot remove the dirt, try cleaning with a soft cloth moistened with a mild detergent.

Parent topic: [Cleaning and Transporting Your Product](#)

Cleaning the Paper Rollers

If you encounter issues with paper feeding from the cassettes, clean the paper rollers inside your product.

1. Turn off the product using the  power button.
2. Unplug the power cable.
3. Disconnect any connected cables.

4. Slide out the paper cassette and remove any loaded paper.

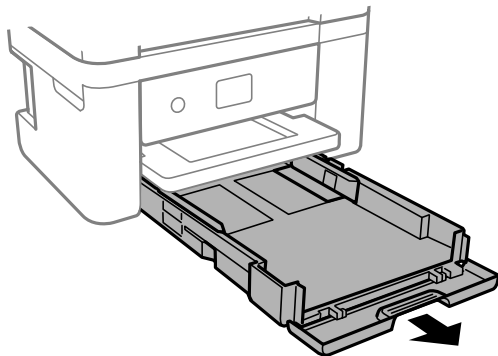

5. Place the product on its side as shown.

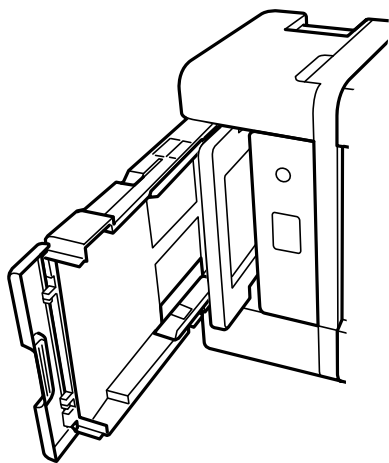

Warning: Be careful not to trap your fingers under the product.

6. Use a soft, moist cloth to clean the cassette rollers shown here. Gently rotate the rollers to clean them completely.

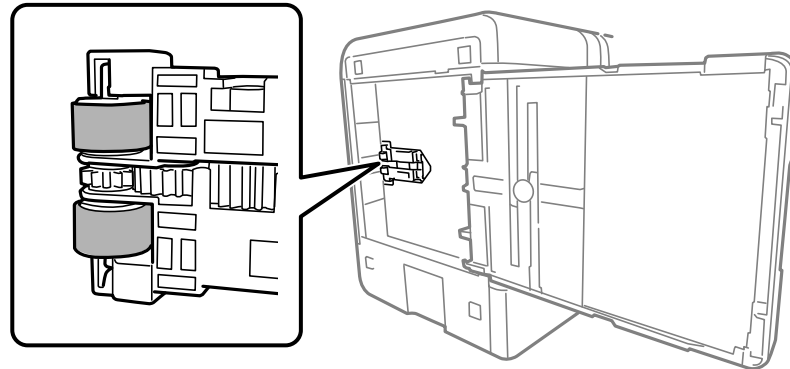

7. Return the product to its normal position.

Caution: Do not leave the product on its side for an extended period of time. Ink may leak.

8. Replace the paper, slide in the paper cassette, and connect the power cable and any interface cables.

Parent topic: [Cleaning and Transporting Your Product](#)

Cleaning the Print Head Path

If the print quality has not improved after aligning the print head and cleaning the paper guide, the print head path inside the product may be smeared with ink.

To clean the print head path, use the following:

- Several cotton swabs
- ¼ cup (59 ml) water containing 2 to 3 drops of mild dish detergent
- A small flashlight

Caution: Do not use any other liquid to clean the print head path or you may damage your product.

1. Turn off the product using the  power button.
2. Unplug the power cable.

3. Disconnect any connected cables.
4. Lift up the scanner unit until it locks into place.

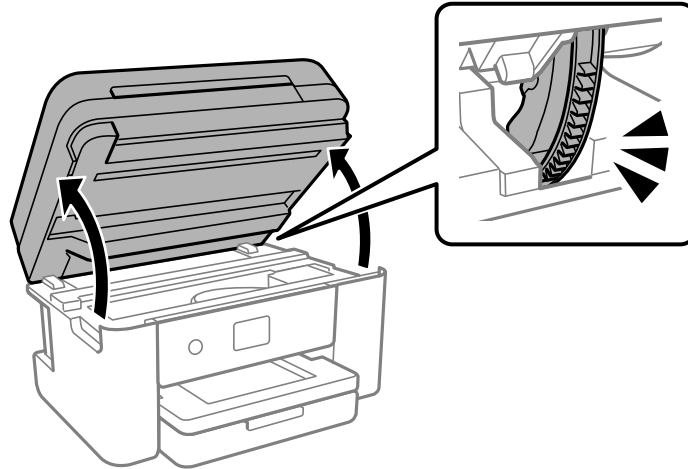

Caution: Be careful not to trap your hand or fingers when opening or closing the scanner unit.

5. Using the flashlight, check the translucent film shown here for ink smears.

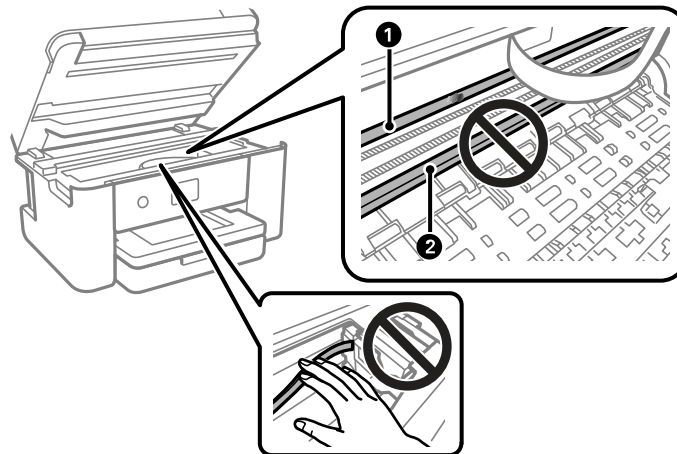

- 1 Translucent film
- 2 Print head rail (do not touch)

Caution: Do not touch the flat white cable or the print head rail; otherwise, you may not be able to print. Do not wipe off the grease on the rail.

6. Moisten a cotton swab with the water and detergent mixture and squeeze out any excess moisture. Use it to lightly wipe ink off the translucent film. Be careful not to touch the ink that has adhered inside the printer.

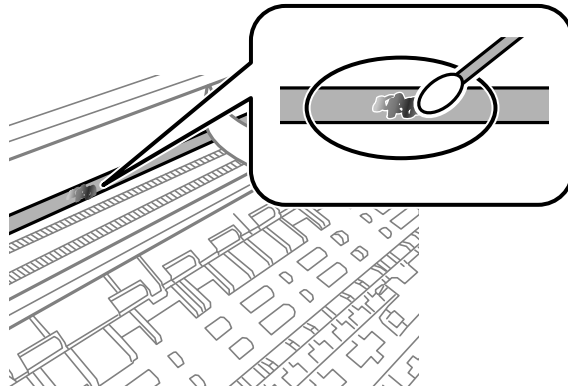

Caution: Do not press too hard on the film or you may dislocate the anchor springs and damage the product.

7. Use a new, dry cotton swab to dry the translucent film. To prevent the smear from spreading, frequently replace the cotton swab with a new one. Do not leave any cotton fibers on the film.
8. Repeat steps 6 and 7 as necessary to clean all ink smears.

9. When the translucent film is dry, close the scanner unit. Continue to lower the scanner unit even if you feel some resistance.

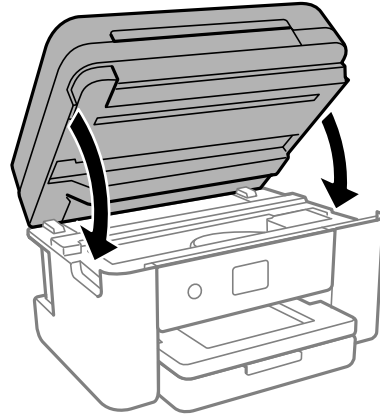

10. Plug in the power cable and reconnect any interface cables.

Parent topic: [Cleaning and Transporting Your Product](#)

Related tasks

[Cleaning the Paper Guide](#)

[Aligning the Print Head Using the Product Control Panel](#)



Transporting Your Product

If you need to store your product or transport it a long distance, prepare it for transportation as described here.

Caution: During transportation and storage, follow these guidelines:

- Avoid tilting the product, placing it vertically, or turning it upside down; otherwise ink may leak.
- Leave the ink cartridges installed. Removing the cartridges can dry out the print head and may prevent the product from printing.
- Do not carry the product by its control panel; this may damage the product.

Note: Before storing your product for a long period, replace low, expended, or expired ink to help prevent the print head from drying out. Store your product in a cool, dry place.

1. Turn off the product using the  power button.
2. Wait for the  power light to go out, then unplug the power cable.

Caution: Wait until the power light turns off before you unplug the power cable to allow the print head to return to the home (far right) position. If the print head does not return to the home position, the ink can dry out and your product can be damaged.

3. Disconnect any connected cables.
4. Remove all the paper from the product and make sure there are no originals on the scanner glass.
5. Make sure the document cover is closed and then lift up the scanner unit until it locks into place.

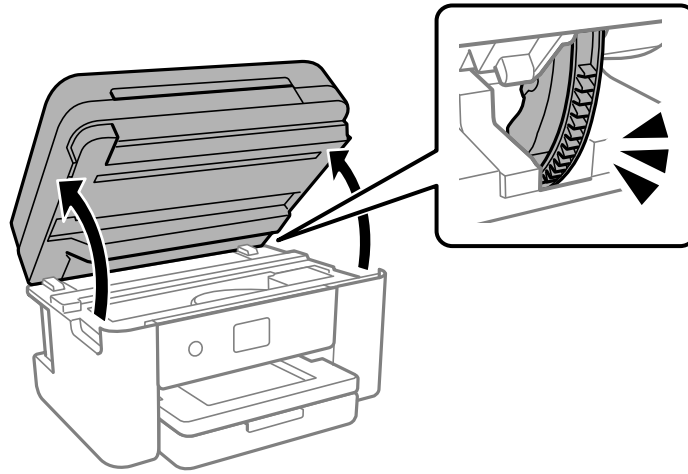

Caution: Be careful not to trap your hand or fingers when opening or closing the scanner unit.

- Secure the ink cartridge holder to the case with tape.

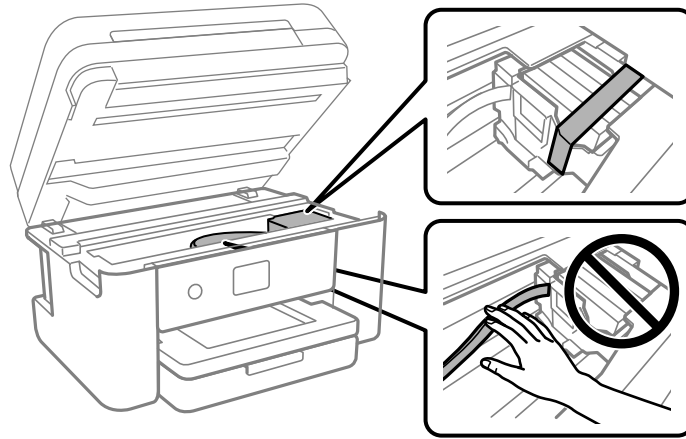

Caution: Do not touch the flat white cable inside the product and do not put tape on the flat white cable; otherwise, you may damage your product.

- Close the scanner unit. Continue to lower the scanner unit even if you feel some resistance.

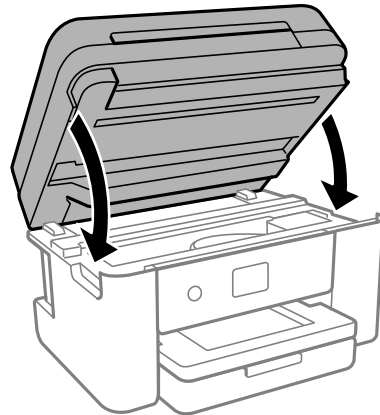

8. Close all parts on the product as shown.

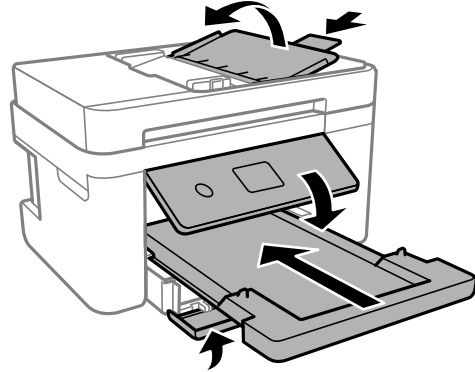

9. Place the product in its original packing materials, if possible, or use equivalent materials with cushioning around the product.

Keep the product level during transportation. Be sure to remove the tape from the ink cartridge holder before turning on your product. If print quality has declined when you print again, clean and align the print head.

Parent topic: [Cleaning and Transporting Your Product](#)

Related concepts

[Print Head Nozzle Check](#)

[Print Head Cleaning](#)

[Print Head Alignment](#)

Solving Problems

Check these sections for solutions to problems you may have using your product.

[Checking for Software Updates](#)

[Product Status Messages](#)

[Running a Product Check](#)

[Resetting Control Panel Defaults](#)

[Solving Setup Problems](#)

[Solving Network Problems](#)

[Solving Copying Problems](#)

[Solving Paper Problems](#)

[Solving Problems Printing from a Computer](#)

[Solving Page Layout and Content Problems](#)

[Solving Print Quality Problems](#)

[Solving Scanning Problems](#)

[Solving Scanned Image Quality Problems](#)

[Solving Faxing Problems](#)

[Uninstall Your Product Software](#)



[Where to Get Help](#)

Checking for Software Updates

It's a good idea to check Epson's support website occasionally for free updates to your product software. Visit epson.com/support (U.S.) or epson.ca/support (Canada) and select your product.

Note: Your printer is designed to work only with genuine Epson-brand ink cartridges. Other brands of ink cartridges and ink supplies are not compatible and, even if described as compatible, may not function properly or at all. Epson periodically provides firmware updates to address issues of security, performance, minor bug fixes and ensure the printer functions as designed. These updates may affect the functionality of third-party ink. Non-Epson branded or altered Epson cartridges that functioned prior to a firmware update may not continue to function.

- **Windows:** Your printer software automatically checks for updates. You can also manually update the software by selecting **Software Update** here:

- Accessing the Windows Desktop and right-clicking the  icon for your product in the right side of the Windows taskbar, or clicking the up arrow and right-clicking .
- On the **Maintenance** tab in the printer settings window

You can also update the software by selecting **EPSON Software Updater** in the **EPSON** or **Epson Software** program group, accessible by the **Start** button, or on the **Start** or **Apps** screens, depending on your version of Windows.

- **OS X:** You can manually update the software by opening the **Applications > Epson Software** folder and selecting **EPSON Software Updater**.
- **macOS 10.12.x, 10.13.x, 10.14.x, 10.15.x, 11.x, or 12.x:** You can manually update the software by opening the **App Store**, selecting **Updates**, searching for a software update option for Epson Software, and selecting **Update**.

Parent topic: [Solving Problems](#)

Product Status Messages

You can often diagnose problems with your product by checking the messages on its LCD screen. You can also press the  help button to see help information and how-to instructions on the screen.

LCD screen message	Condition/solution
Printer error. Turn on the printer again. See your documentation for more details.	A fatal error has occurred. Turn the product off and then back on again. If the error continues, check for a paper jam or any protective material inside the product. If there is no paper jam or protective material, contact Epson for support.
Paper out in XX.	Load paper in the paper cassette and insert the cassette all the way in.
You need to replace Ink Cartridge.	The ink cartridge is expended. Replace the cartridge.
The printer's borderless printing ink pad is nearing the end of its service life. It is not a user-replaceable part. Please contact Epson support.	The ink pad is near the end of its service life and the message will be displayed until the ink pad is replaced. Contact Epson for support. (To resume printing, select OK .)

LCD screen message	Condition/solution
<p>The printer's borderless printing ink pad has reached the end of its service life. It is not a user-replaceable part. Please contact Epson support.</p>	<p>The ink pad is at the end of its service life. Turn off the product and contact Epson for support.</p>
<p>Paper Setup Auto Display is set to Off. Some features may not be available. For details, see your documentation.</p>	<p>The Paper Setup Auto Display setting must be enabled to use AirPrint.</p>
<p>System Error An error occurred. Turn the device off and back on again. If this occurs again, contact Epson support.</p>	<p>Turn the printer off and on again. If you are using a Wi-Fi connection, turn the wireless router off and on again. If you still see the error message, make a note of the error code and contact Epson support.</p>
<p>No dial tone is detected.</p>	<p>Make sure the phone cable is connected correctly and the phone line works. If you connected the product to a PBX (Private Branch Exchange) phone line or Terminal Adapter, change the Line Type setting to PBX. If you still cannot send a fax, turn off the Dial Tone Detection setting. (Turning off the Dial Tone Detection setting may cause the product to drop the first digit of a fax number.)</p>
<p>The combination of the IP address and subnet mask is invalid. See your documentation for more details.</p>	<p>There is a problem with the network connection to your product. Check the solutions in this guide.</p>
<p>To use cloud services, update the root certificate from the Epson Web Config utility.</p>	<p>Access your product's built-in Web Config utility and update the root certificate for your product.</p>

LCD screen message	Condition/solution
Check that the printer driver is installed on the computer and that the port settings for the printer are correct.	Make sure the printer port is selected correctly on the Port tab of the Printer Properties screen (Windows) or the System Properties > USB list (Mac). Select USBXXX for a USB connection or EpsonNet Print Port for a network connection.
Check that the printer driver is installed on the computer and that the USB port settings for the printer are correct.	
Recovery mode Update Firmware	An error has occurred during firmware updating. Connect your product using a USB cable and try updating the firmware again. If you still receive this error message, contact Epson for support.

Note: The ink pads in the printer collect, distribute, and contain the ink that is not used on printed pages. During the life of your product it may reach a condition where either satisfactory print quality cannot be maintained or the ink pads have reached the end of their usable life. The Epson Status Monitor, your LCD screen, or lights on the control panel will advise you when these parts need replacing. If this happens during the standard warranty of the product, the exchange of the product or replacement of the pads is covered under the standard warranty. If the product is out of warranty, the pads can be replaced by any Epson authorized service provider. The waste ink pads are not a user-replaceable part.

Parent topic: [Solving Problems](#)

Related references

[Paper Source Settings Options](#)

[Where to Get Help](#)

Related tasks

[Accessing the Web Config Utility](#)

[Using AirPrint](#)

[Connecting a Telephone or Answering Machine](#)

[Selecting the Line Type](#)

[Checking for Software Updates](#)

Related topics

[Solving Paper Problems](#)

[Loading Paper](#)
[Replacing Ink Cartridges and Maintenance Boxes](#)
[Wi-Fi or Wired Networking](#)

Running a Product Check

Running a product check helps you determine if your product is operating properly.

1. Disconnect any interface cables connected to your product.
2. Load plain paper in the product.
3. Press the  home button, if necessary.
4. Select **Maintenance** > **Print Head Nozzle Check**.
5. Select **Print**.

The nozzle pattern prints.

6. Do one of the following, depending on the results of the product check:
 - If the page prints and the nozzle check pattern is complete, the product is operating properly. Any operation problem you may have could be caused by your computer, cable, software, or selected settings. Check the other solutions in this book or try uninstalling and reinstalling your printer software.
 - If the page prints but the nozzle check pattern has gaps, clean the print head.
 - If the page does not print, the product may have a problem. Check the other solutions in this manual. If they do not work, contact Epson.

Parent topic: [Solving Problems](#)

Related concepts

[Print Head Cleaning](#)
[Print Head Alignment](#)
[Uninstall Your Product Software](#)

Related references

[Where to Get Help](#)

Related topics

[Loading Paper](#)

Resetting Control Panel Defaults

If you have a problem with settings on the product control panel, you can reset them to their factory defaults. You can choose which settings to reset or reset them all.

1. Press the  home button, if necessary.
2. Select **Settings** > **Restore Default Settings**.
3. Select one of these options:
 - **Network Settings**: Resets all network settings
 - **Copy Settings**: Resets all settings for copying
 - **Scan Settings**: Resets all settings for scanning
 - **Fax Settings**: Resets all settings for faxing
 - **Clear All Data and Settings**: Resets all control panel settings including the contacts listYou see a confirmation screen.
4. Select **Yes** to reset the selected settings. (Select **No** if you want to cancel the operation.)

Parent topic: [Solving Problems](#)

Solving Setup Problems

Check these sections if you have problems while setting up your product.

[Product Does Not Turn On or Off](#)

[Noise After Ink Installation](#)

[Software Installation Problems](#)

Parent topic: [Solving Problems](#)

Product Does Not Turn On or Off

If you cannot turn the product on or off, try these solutions:

- If you cannot turn on your product, make sure the power cord is securely connected and hold down the power button a little longer.
- If you cannot turn off your product, hold down the power button a little longer. If you still cannot turn off your product, unplug the power cord, plug the power cord back in, then turn your product on and off again using the power button.

Parent topic: [Solving Setup Problems](#)

Noise After Ink Installation

If you hear noises from your product after installing ink, check the following:

- If the product's print head stops moving or making noise, and the charging process has not finished after approximately 5 minutes, turn off your product. Turn it back on and check to see if charging is still in progress. If it is still in progress, contact Epson for help.

Parent topic: [Solving Setup Problems](#)

Related references

[Where to Get Help](#)

Software Installation Problems

If you have problems while installing your product software, try these solutions:

- Make sure your product is turned on and any necessary cables are securely connected at both ends. If you still have problems installing software, disconnect the cable and carefully follow the instructions on the *Start Here* sheet. Also make sure your system meets the requirements for your operating system.
- Close any other programs, including screen savers and virus protection software, and install your product software again.
- In Windows, make sure your product is selected as the default printer and the correct port is shown in the printer properties.
- If you see any error message or your software does not install correctly in Windows, you may not have software installation privileges. Contact your system administrator.
- If you are printing over a network, make sure your product is set up properly on the network.
- If the USB cable is not recognized, try using a different USB cable.

Parent topic: [Solving Setup Problems](#)

Related concepts

[Uninstall Your Product Software](#)

Related references

[Windows System Requirements](#)

[Mac System Requirements](#)

Related topics

[Wi-Fi or Wired Networking](#)

Solving Network Problems

Check these solutions if you have problems setting up or using your product on a network.

Note: Breakdown or repair of this product may cause loss of fax and network data and settings. Epson is not responsible for backing up or recovering data and settings during or after the warranty period. We recommend that you make your own backup or print out your fax and network data and settings.

[Product Cannot Connect to a Wireless Router or Access Point](#)

[Network Software Cannot Find Product on a Network](#)

[Product Does Not Appear in Mac Printer Window](#)

[Wireless Network Connection is Unstable on a Mac](#)

[Cannot Print Over a Network](#)

[Cannot Scan Over a Network](#)

Parent topic: [Solving Problems](#)

Related tasks

[Printing a Network Status Sheet](#)

Product Cannot Connect to a Wireless Router or Access Point

If your product has trouble finding or connecting to a wireless router or access point, try these solutions:

- Make sure to place your product within contact range of your 2.4 GHz router or access point. Avoid placing your product near a microwave oven, 2.4 GHz cordless phone, or large metal object, such as a filing cabinet.

Note: If you are using a 5 GHz wireless router, set the router to operate in dual band (2.4 GHz and 5 GHz) mode. If your router uses a single network name (SSID) for both the 2.4 GHz and 5 GHz band, give each band its own network name (SSID) instead, such as Home Network 2.4 GHz and Home Network 5 GHz. See your router documentation or contact your internet service provider for instructions.

- Verify that your router or access point is operating correctly by connecting to it from your computer or another device.
- Print a network connection report and check the codes and messages on the report to help determine the cause of the problem.
- You may need to disable the firewall and any anti-virus software on your wireless router or access point.

- Try restarting your router following the instructions in your router documentation.

Note: If you are reading these instructions online, you will lose your Internet connection when you restart your router.

- Check to see if access restrictions, such as MAC address filtering, are set on the router or access point. If access restrictions are set, add your product's MAC address to your router's address list. To obtain your product's MAC address, print a network status sheet. Then follow the instructions in your router or access point documentation to add the address to the list.
- If your router or access point does not broadcast its network name (SSID), follow the instructions that came with your product to enter your wireless network name manually.
- If your router or access point has security enabled, determine the kind of security it is using and any required password or passphrase for connection. Then make sure to enter the exact WEP key or WPA passphrase correctly.
- Check if your computer is restricting the available wireless channels. If so, verify that your wireless access point is using one of the usable channels and change to a usable channel, if necessary.
- Turn off the devices you want to connect to the network. Wait for about 10 seconds and then turn on the devices in the following order: wireless router, computer or smart device, and then your product. Move your product and computer or smart device closer to the wireless router to help with radio wave communication, and then try to make network settings again.
- If the IP address assigned to the product is 169.254.XXX.XXX and the subnet mask is 255.255.0.0, the IP address may not be assigned correctly. Check the IP address and the subnet mask assigned to the product. Restart the wireless router or reset the network settings for the product.
- If you cannot connect your product to a device using Wi-Fi Direct, you may have exceeded the maximum number of devices connected to your product (8). Print a network status sheet or access Web Config on the browser for your device and check the number of connected devices. If 8 devices are already connected, disconnect a device by deleting the product's SSID from the Wi-Fi screen of that device. If fewer than 8 devices are connected, check the accuracy of your other network settings, move your device closer to your product, and try connecting again.

Parent topic: [Solving Network Problems](#)

Related references

[Status Icon Information](#)

Related tasks

[Enabling Wi-Fi Direct \(Simple AP\) Mode](#)

[Printing a Network Status Sheet](#)

[Printing a Network Connection Report](#)

[Disabling Wi-Fi Features](#)

Related topics

[Wi-Fi or Wired Networking](#)

Network Software Cannot Find Product on a Network

If EpsonNet Setup cannot find your product on a network, try these solutions:

- Make sure your product is turned on and connected to your network. Verify the connection using your product control panel.
- Check if your network name (SSID) contains non-ASCII characters. Your product cannot display non-ASCII characters.
- Print a network connection report and check the codes and messages on the report to help determine the cause of the problem.
- Make sure your product is not connected to a guest network.
- If necessary, reinstall your product software and try running EpsonNet Setup again:
 1. Reset your product's network settings to their factory defaults.
 2. **Windows only:** Uninstall your product software.
 3. Restart your router following the instructions in your router documentation.

Note: If you are reading these instructions online, you will lose your Internet connection when you restart your router, so note the next step before restarting it.

4. Download your product software from the Epson website using the instructions on the *Start Here* sheet.
- If you have replaced your router, reinstall your product software to connect to the new router.

Note: If you are using a 5 GHz wireless router, set the router to operate in dual band (2.4 GHz and 5 GHz) mode. If your router uses a single network name (SSID) for both the 2.4 GHz and 5 GHz band, give each band its own network name (SSID) instead, such as Home Network 2.4 GHz and Home Network 5 GHz. See your router documentation or contact your internet service provider for instructions.

- Check to see if your wireless router or access point has an enabled Privacy Separator function that is preventing detection of your device over the network. See your router or access point documentation for instructions on disabling the Privacy Separator function.
- Try accessing any website from your computer to make sure that your computer's network settings are correct. If you cannot access any website, there is a problem on the computer. Check the network connection of the computer. See the documentation provided with the computer for details.

Parent topic: [Solving Network Problems](#)

Related concepts

[Uninstall Your Product Software](#)

Related tasks

[Printing a Network Connection Report](#)

Related topics

[Wi-Fi or Wired Networking](#)

Product Does Not Appear in Mac Printer Window

If your product does not appear in the Mac printer window, try these solutions:

- Turn your product off, wait 30 seconds, then turn it back on again.
- If you are connecting the product via Wi-Fi Protected Setup (WPS) and the Wi-Fi icon on your product's LCD screen is not lit, make sure you select one of the WPS options from the product control panel within 2 minutes of pressing the WPS button on your router.
- If you are connecting the product wirelessly via EpsonNet Setup and you do not see the Wi-Fi antenna icon with connection bars on your LCD screen, make sure your product software was installed correctly. If necessary, reinstall your software.

Note: If you are using a 5 GHz wireless router, set the router to operate in dual band (2.4 GHz and 5 GHz) mode. If your router uses a single network name (SSID) for both the 2.4 GHz and 5 GHz band, give each band its own network name (SSID) instead, such as Home Network 2.4 GHz and Home Network 5 GHz. See your router documentation or contact your internet service provider for instructions.

Parent topic: [Solving Network Problems](#)

Related concepts

[Uninstall Your Product Software](#)

Related references

[Status Icon Information](#)

Wireless Network Connection is Unstable on a Mac

If you connected a device to a USB 3.0 port on your Mac, you may experience wireless network interference between your product and your Mac.

If you cannot connect to your product over the wireless network or the connection becomes unstable, move the device connected to your Mac USB 3.0 port further away from your Mac.

Parent topic: [Solving Network Problems](#)

Related tasks

[Printing a Network Connection Report](#)

Cannot Print Over a Network

If you cannot print over a network, try these solutions:

- Make sure that your product is turned on.
- Make sure you install your product's network software as described in your product documentation.
- Make sure that the latest version of your product's Epson printer driver is installed. If a genuine Epson printer driver is not installed, the available functions are limited.
- Print a network status sheet and verify that the network settings are correct. If the network status is **Disconnected**, check any cable connections and turn your product off and then on again.
- If you are using TCP/IP, make sure the product's IP address is set correctly for your network. If your network does not assign IP addresses using DHCP, set the IP address manually.
- Make sure your computer and product are both using the same wireless network.
- If network printing is slow, print a network status sheet and check the signal strength. If it is poor, place your product closer to your router or access point. Avoid placing your product near a microwave oven, cordless phone, or large metal object, such as a filing cabinet.

Note: If you are using a 5 GHz wireless router, set the router to operate in dual band (2.4 GHz and 5 GHz) mode. If your router uses a single network name (SSID) for both the 2.4 GHz and 5 GHz band, give each band its own network name (SSID) instead, such as Home Network 2.4 GHz and Home Network 5 GHz. See your router documentation or contact your internet service provider for instructions.

- Try restarting your router following the instructions in your router documentation.

Note: If you are reading these instructions online, you will lose your Internet connection when you restart your router.

- Check to see if your wireless router or access point has an enabled Privacy Separator function that is preventing printing from a device over the network. See your router or access point documentation for instructions on disabling the Privacy Separator function.
- If you are connecting the product via Wi-Fi Protected Setup (WPS) and the  Wi-Fi icon on your product is not active, repeat the WPS setup process on the product control panel and be sure to complete it within 2 minutes of pressing the **WPS** button on your router.
- If you are connecting the product wirelessly via EpsonNet Setup and the Wi-Fi connection icon is not lit or does not appear on the product's LCD screen, make sure your product software was installed correctly. If necessary, reinstall your software.
- If you are printing a large data size image, the computer may run out of memory. Print the image at a lower resolution or a smaller size.

Parent topic: [Solving Network Problems](#)

Related concepts

[Uninstall Your Product Software](#)

Related references

[Cannot Scan Over a Network](#)

Related tasks

[Printing a Network Status Sheet](#)

Related topics

[Wi-Fi or Wired Networking](#)

Cannot Scan Over a Network

If you have problems scanning over a network, try these solutions:

- If you are scanning a large original at a high resolution, a network communication error may occur. Try scanning again at a lower resolution.
- If network communication was interrupted while starting Epson Scan 2, exit Epson Scan 2, wait a few seconds, and restart it. If Epson Scan 2 cannot restart, turn off your product, turn it back on, and try restarting Epson Scan 2 again.
- Check the scanner setting and reset the connection if necessary using Epson Scan 2 Utility:

Windows 11: Click , then search for **Epson Scan 2 Utility** and select it. Make sure your product is selected. If necessary, select the **Other** tab and click **Reset**.

Windows 10: Click , and select **EPSON > Epson Scan 2 Utility**. Make sure your product is selected. If necessary, select the **Other** tab and click **Reset**.

Windows 8.x: Navigate to the **Apps** screen, select **EPSON**, and select **Epson Scan 2 Utility**. Make sure your product is selected. If necessary, select the **Other** tab and click **Reset**.

Windows (other versions): Click  or **Start > All Programs** or **Programs > EPSON > Epson Scan 2 > Epson Scan 2 Utility**. Make sure your product is selected. If necessary, select the **Other** tab and click **Reset**.

Mac: Open the **Applications** folder, click **Epson Software**, and click **Epson Scan 2 Utility**. Make sure your product is selected. If necessary, select the **Other** tab and click **Reset**.

- You may need to disable the firewall and any anti-virus software on your wireless router or access point.

Parent topic: [Solving Network Problems](#)

Related tasks

[Starting a Scan Using the Product Control Panel](#)

Solving Copying Problems

Check these solutions if you have problems copying with your product.

[Product Makes Noise, But Nothing Copies](#)

[Product Makes Noise When It Sits for a While](#)

[Originals Do Not Feed From the Automatic Document Feeder](#)

[Copies Have Incorrect or Faint Colors](#)

[Position, Size, or Margins of Copies are Incorrect](#)

Parent topic: [Solving Problems](#)

Product Makes Noise, But Nothing Copies

If your product makes a noise, but nothing copies, try these solutions:

- Run a nozzle check to see if any of the print head nozzles are clogged. Then clean the print head, if necessary.
- If the nozzle check page does not print, but the product's power is on, make sure your product software is installed correctly.
- Make sure your product is level (not tilted).

Parent topic: [Solving Copying Problems](#)

Related concepts

[Print Head Cleaning](#)

[Print Head Nozzle Check](#)

Product Makes Noise When It Sits for a While

Your product is performing routine maintenance. This is normal.

Parent topic: [Solving Copying Problems](#)

Originals Do Not Feed From the Automatic Document Feeder

If your originals do not feed when placed in the ADF, try these solutions:

- Make sure the **ADF** icon lights up on the Copy, Fax, or Scan screen on the LCD screen. If not, reload the originals.
- Make sure the size, weight, and number of your originals are supported by the ADF.
- Make sure the originals are loaded correctly.
- Slide the edge guides against the edges of the originals.
- Make sure the document is not curled or creased.
- Try cleaning the inside of the ADF.
- Do not load originals above the arrow mark on the ADF edge guide.

Parent topic: [Solving Copying Problems](#)

Related references

[Document Jams in the Automatic Document Feeder](#)

[ADF Original Document Specifications](#)

Related tasks

[Placing Originals in the Automatic Document Feeder](#)

[Cleaning Your Product](#)

Copies Have Incorrect or Faint Colors

If your copies have incorrect, uneven, smeared, or faint colors, try these solutions:

- Run a print head nozzle check to see if any of the nozzles are clogged. Then clean the print head, if necessary.
- Do not press too hard on the original when you copy from the scanner glass.
- Clean the scanner glass with a soft, dry, lint-free cloth or use a small amount of glass cleaner on the cloth, if necessary. Paper towels are not recommended.

Caution: Do not spray glass cleaner directly on the scanner glass.

- Clean the ADF.
- If the colors are smeared, try lowering the copy density setting on the LCD screen.

Parent topic: [Solving Copying Problems](#)

Related concepts

[Print Head Nozzle Check](#)

Related tasks

[Cleaning Your Product](#)

Position, Size, or Margins of Copies are Incorrect

If the position, size, or margins of your copies are incorrect, try these solutions:

- When placing originals in the ADF, make sure the edge guides are against the edges of the paper.
- When placing originals on the scanner glass, make sure the original is placed correctly for scanning. Align the corner of the original with the corner indicated by the symbol on the scanner glass. If necessary, move the original away from the edges of the scanner glass slightly.
- Clean the scanner glass and ADF.
- Make sure the paper is loaded in the correct direction.

Parent topic: [Solving Copying Problems](#)

Related tasks

[Cleaning Your Product](#)

Related topics

[Placing Originals on the Product](#)

[Loading Paper](#)

Solving Paper Problems

Check these sections if you have problems using paper with your product.

[Paper Feeding Problems](#)

[Paper Jam Problems Inside the Product](#)

[Paper Jam Problems in the Rear Cover](#)

[Document Jams in the Automatic Document Feeder](#)

[Paper Ejection Problems](#)

Parent topic: [Solving Problems](#)

Paper Feeding Problems

If you have problems feeding paper, try these solutions:

- Make sure the paper cassette is inserted all the way in the printer.
- Make sure the paper size and type settings match the size and type of paper you loaded.
- If paper does not feed correctly, remove and reload it in the cassette and adjust the edge guides. Make sure the paper stack is not above the tab on the edge guides inside the cassette.
- If multiple pages feed at once, remove the paper, fan the edges to separate the sheets, and reload it.
- Do not load more than the recommended number of sheets.
- Make sure your paper meets the specifications for your product.
- If paper jams when you print on both sides of the paper, try loading fewer sheets.
- For best results, follow these guidelines:
 - Use new, smooth, high-quality paper that is not curled, creased, old, too thin, or too thick.
 - Load paper in the cassette printable side down.
 - Follow any special loading instructions that came with the paper.

Parent topic: [Solving Paper Problems](#)

Related references

[Paper Jam Problems Inside the Product](#)

[Paper Specifications](#)

Related tasks

[Cleaning Your Product](#)

[Cleaning the Print Head Path](#)

[Cleaning the Paper Guide](#)

Paper Jam Problems Inside the Product

If you see a message that paper has jammed inside the product, follow the steps here or on the LCD screen to clear the jam.

Caution: Never touch the buttons on the control panel while your hand is inside the product. If the product starts operating, you could be injured. Be careful not to touch the protruding parts to avoid injury.

1. Cancel the print job, if necessary.
2. Remove any jammed paper from the ADF.
3. Lift the scanner unit with both hands until it locks.

Caution: Be careful not to trap your hand or fingers when opening or closing the scanner unit. Remove the jammed paper carefully or you may damage the product.

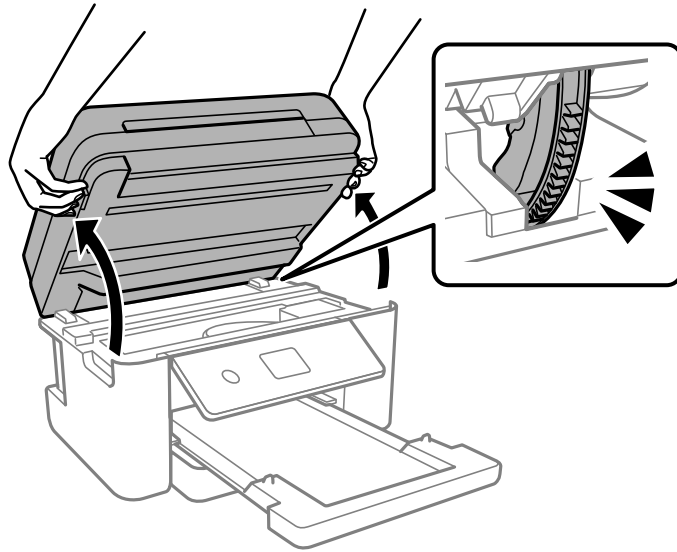

4. Remove the jammed paper.

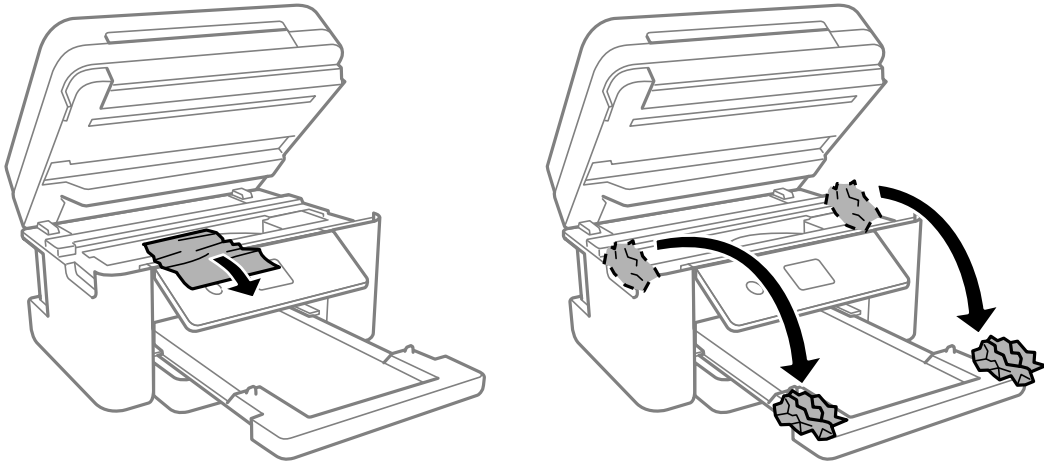

Caution: Do not touch the flat white cable or the translucent film inside your product. Doing so may cause a malfunction.

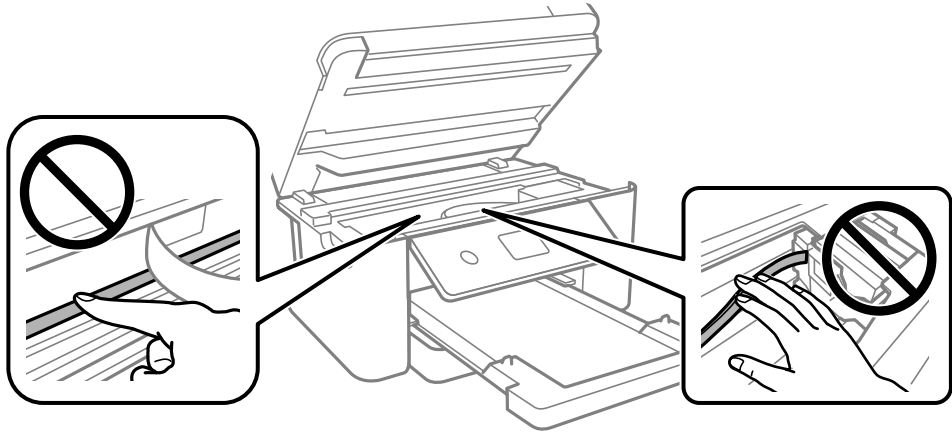

5. Close the scanner unit.

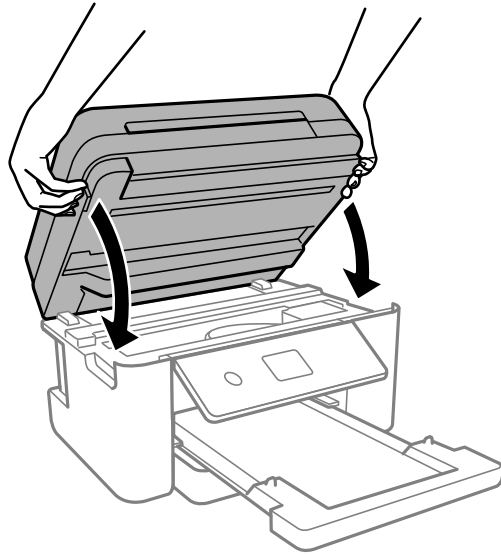

Note: The scanner unit is designed to close slowly to avoid catching fingers in the printer. There may be some resistance when closing the scanner unit.

6. Follow the prompts on the LCD screen to clear any error messages. If you still see a paper jam message, check the other paper jam solutions.

Parent topic: [Solving Paper Problems](#)

Related references

[Document Jams in the Automatic Document Feeder](#)

Related topics

[Loading Paper](#)

Paper Jam Problems in the Rear Cover

If paper has jammed in the rear cover, follow the steps here to clear the jam.

1. Cancel the print job, if necessary.

2. Squeeze the tabs and remove the rear cover.

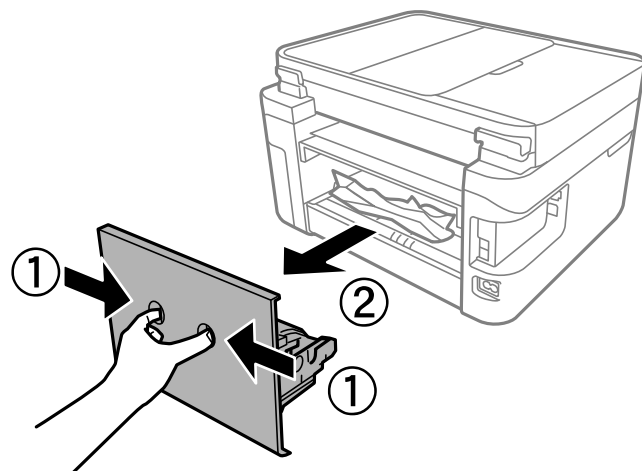

3. Carefully remove any jammed paper from inside the product.

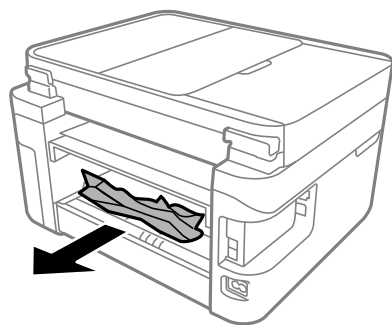

4. Carefully remove any jammed paper from the rear cover.

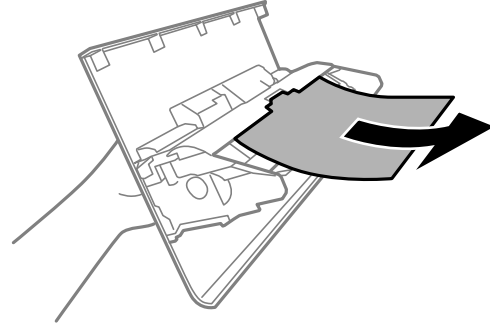

5. Replace the rear cover.
6. Follow the prompts on the LCD screen to clear any error messages. If you still see a paper jam message, check the other paper jam solutions.

Parent topic: [Solving Paper Problems](#)

Related references

[Paper Jam Problems Inside the Product](#)

[Document Jams in the Automatic Document Feeder](#)

Related topics

[Loading Paper](#)

Document Jams in the Automatic Document Feeder

If you have problems with document jams in the automatic document feeder (ADF), follow the steps here to clear the jam.

1. Cancel the print job, if necessary.
2. Remove your originals from the ADF.

3. Open the ADF cover.

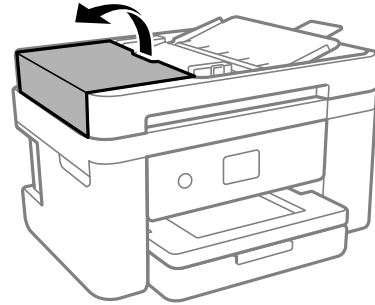

4. Carefully remove any jammed pages from beneath the ADF.

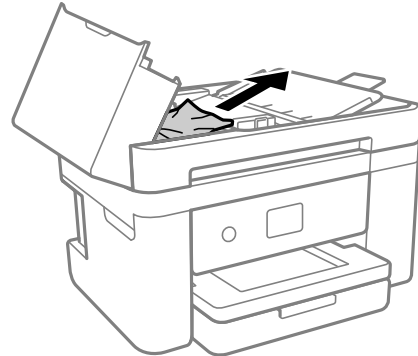

5. Raise the ADF input tray.

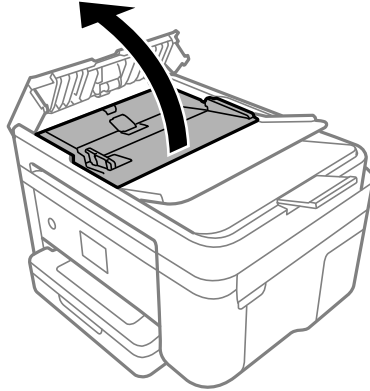

Caution: Make sure the ADF cover is opened before raising the ADF input tray or the ADF may be damaged.

6. Remove the jammed paper.

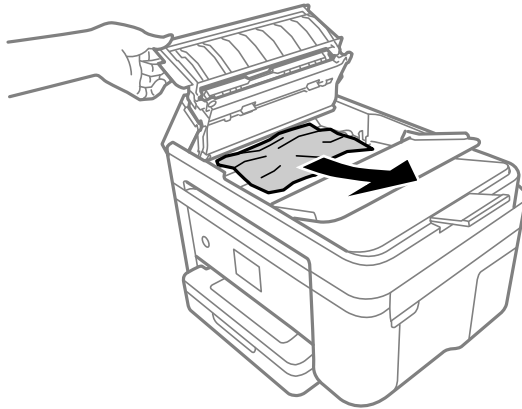

7. Lower the ADF input tray.

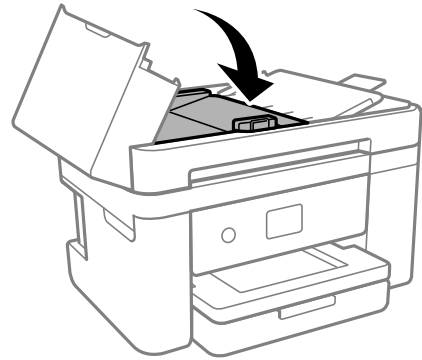

8. Close the ADF cover until you hear a click.

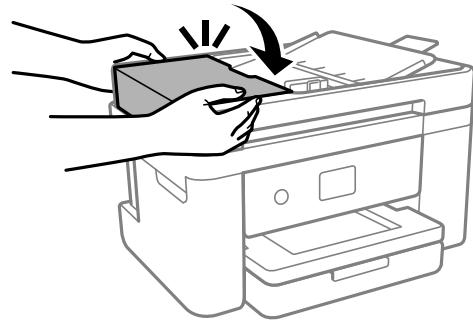

9. Reload your originals.

Caution: Make sure you do not load the ADF beyond its capacity for your paper size. Also make sure your originals are not bent, folded, or curled and do not have tape, staples, or other materials that could obstruct the feeder.

10. Follow the prompts on the LCD screen to clear any error messages. If you still see a paper jam message, check the other paper jam solutions.

Parent topic: [Solving Paper Problems](#)

Related references

[Paper Jam Problems Inside the Product](#)
[Paper Jam Problems in the Rear Cover](#)
[ADF Original Document Specifications](#)

Related tasks

[Placing Originals in the Automatic Document Feeder](#)

Paper Ejection Problems

If you have problems with paper ejecting properly, try these solutions:

- If paper does not eject fully, you may have set the wrong paper size. Cancel printing to eject the paper. Select the correct paper size when you reprint.
- If paper falls from the output tray, extend the paper stopper.
- If paper is wrinkled when it ejects, it may be damp or too thin. Load new paper.
- If you are using letterhead paper, select the appropriate paper type setting.
- Clean the roller inside the printer to remove any dust on the paper path.

Parent topic: [Solving Paper Problems](#)

Related references

[Paper Jam Problems in the Rear Cover](#)
[Paper Jam Problems Inside the Product](#)
[Paper or Media Type Settings - Printing Software](#)
[Paper Type Settings - Control Panel](#)

Related topics

[Loading Paper](#)

Solving Problems Printing from a Computer

Check these sections if you have problems while printing from your computer.



Note: When printing using AirPrint, the available print settings are different from those covered in this manual. See the Apple website for details.

[Nothing Prints](#)

[Product Icon Does Not Appear in Windows Taskbar](#)

Nothing Prints

If you have sent a print job and nothing prints, try these solutions:

- Make sure your product is turned on and connected to your computer.
- Make sure any interface cables are connected securely at both ends.
- Make sure there are no errors or paper jams in the product.
- If you connected your product to a USB hub, make sure it is a first-tier hub. If it still does not print, connect your product directly to your computer instead of the hub.
- If your computer is connected using a USB cable, try a different USB port on your computer or a different cable.
- Make sure the printer status is not offline or pending.
- Run a product check to see if a test page prints. If the test page prints, check to see if your product software is installed correctly.
- Make sure your system meets the requirements for your operating system. If you are printing a high-resolution image, you may need more than the minimum requirements. Print the image at a lower resolution or if necessary, increase your system's memory.
- In Windows, make sure your product is selected as the default printer and the printer port setting matches the printer connection port.
- In Windows, delete all jobs from the Windows Spooler. Click **Print Queue** on the Maintenance tab in the printer settings window, and cancel any stalled print jobs.
- In Windows, do one of the following to open the Epson Printer Connection Checker and follow the on-screen instructions to check the connection status:
 - **Windows 11:** Click , then search for **Epson Printer Connection Checker** and select it.
 - **Windows 10:** Click  and select **Epson Software > Epson Printer Connection Checker**.
 - **Windows 8.x:** Navigate to the **Apps** screen and select the **Epson Printer Connection Checker** icon.
 - **Windows 7:** Click  and select **All Programs > Epson Software > Epson Printer Connection Checker**.
- On a Mac, make sure the printer is added to the printer list and the printer is not paused.

- You can try to clear the problem by updating the product software to the latest version. If the problem persists, try uninstalling and reinstalling the printer driver.

Parent topic: [Solving Problems Printing from a Computer](#)

Related references

[Windows System Requirements](#)

[Mac System Requirements](#)

[Product Status Messages](#)





Related tasks

[Running a Product Check](#)

Product Icon Does Not Appear in Windows Taskbar

If you do not see your product icon in the Windows taskbar, first try restarting your computer. If that does not work, try this solution:

1. Do one of the following:

- **Windows 11:** Click , search for **Settings** and select it. Select **Bluetooth & devices > Printers & scanners**. Select your product name and select **Printing preferences**.
- **Windows 10:** Click  and select  (Settings) > **Devices > Printers & scanners**. Select your product name and select **Manage > Printing preferences**.
- **Windows 8.x:** Navigate to the **Apps** screen and select **Control Panel > Hardware and Sound > Devices and Printers**. Right-click your product name, select **Printing Preferences**, and select your product name again if necessary.
- **Windows 7:** Click  and select **Devices and Printers**. Right-click your product name, select **Printing Preferences**, and select your product name again if necessary.
- **Windows Vista:** Click , select **Control Panel**, and click **Printer** under **Hardware and Sound**. Right-click your product name, select **Printing Preferences**, and select your product name again if necessary.

2. Click the **Maintenance** tab.

3. Click the **Extended Settings** button.

4. Select **Enable EPSON Status Monitor 3** and click **OK**.

5. Click the **Monitoring Preferences** button.

6. Click the checkbox for the option that adds the shortcut icon to the taskbar.

7. Click **OK** to close the open program windows.

Parent topic: [Solving Problems Printing from a Computer](#)

Related references

[Windows System Requirements](#)

[Mac System Requirements](#)

Related tasks

[Selecting Basic Print Settings - Windows](#)

[Selecting Basic Print Settings - Mac](#)

[Selecting Printing Preferences - Mac](#)

[Selecting the Paper Settings - Control Panel](#)

Printing is Slow

If printing becomes slow, try these solutions:

- Make sure your system meets the requirements for your operating system. If you are printing a high-resolution image, you may need more than the minimum requirements. If necessary, increase your system's memory.
- If you are using Windows 7, close the **Devices and Printers** window before you print.
- On a Mac, make sure you download and install the Epson printer driver.
- Clear space on your hard drive or run a defragmentation utility to free up existing space.
- Close any programs you are not using when you print.
- If your product is connected to a USB hub, connect it directly to your computer instead.
- If printing becomes slower after printing continuously for a long time, the product may have automatically slowed down to protect the print mechanism from overheating or becoming damaged. Let the product rest with the power on for 30 minutes, then try printing again.
- If you are printing over a wireless network, factors such as interference, network traffic, or weak signal strength may affect your printing speed.

Note: If you are using a 5 GHz wireless router, set the router to operate in dual band (2.4 GHz and 5 GHz) mode. If your router uses a single network name (SSID) for both the 2.4 GHz and 5 GHz band, give each band its own network name (SSID) instead, such as Home Network 2.4 GHz and Home Network 5 GHz. See your router documentation or contact your internet service provider for instructions.

For the fastest printing, select the following settings in your product software:

- Make sure the paper type setting matches the type of paper you loaded.
- Turn on any high speed settings in your product software.
- Select a lower print quality setting.
- Make sure the ink drying time has not been increased for double-sided printing.
- **Windows:** Click the **Maintenance** or **Utility** tab, select **Extended Settings** or **Speed and Progress**, and select the following settings:
 - **Always Spool RAW Datatype**
 - **Page Rendering Mode**
 - **Print as Bitmap**
- **Windows:** Select **Printing preferences**, click the **More Options** tab, and make sure the **Bidirectional printing** setting is enabled.
- **Mac:** Select **System Preferences**, select **Printers & Scanners**, and select your product. Select **Options & Supplies**, select **Options** (or **Driver**), and enable the **Bidirectional printing** setting.

If printing is still slow and you are using Windows 7 or Windows Vista, try the following:

1. Click  and select **Computer** or **My Computer**. Double-click the **C:** drive and open these folders: **ProgramData > EPSON > PRINTER**.

Note: If you do not see the ProgramData folder, open the **Organize** menu and select **Folder and search options**. In the window that appears, click the **View** tab, select **Show hidden files, folders, and drives** in the Advanced settings list, and click **OK**.

2. Right-click the **EPAUDF01.AUD** file and select **Delete**.
3. Restart your computer and try printing again.

Parent topic: [Solving Problems Printing from a Computer](#)

Related references

[Paper or Media Type Settings - Printing Software](#)

[Windows System Requirements](#)

[Mac System Requirements](#)

Related tasks

[Selecting Basic Print Settings - Windows](#)

- [Selecting Basic Print Settings - Mac](#)
- [Selecting Printing Preferences - Mac](#)
- [Selecting Extended Settings - Windows](#)

Solving Page Layout and Content Problems

Check these sections if you have problems with the layout or content of your printed pages.

Note: When printing using AirPrint, the available print settings are different from those covered in this manual. See the Apple website for details.

- [Inverted Image](#)
- [Too Many Copies Print](#)
- [Blank Pages Print](#)
- [Incorrect Margins on Printout](#)
- [Border Appears on Borderless Prints](#)
- [Incorrect Characters Print](#)
- [Incorrect Image Size or Position](#)
- [Slanted Printout](#)

Parent topic: [Solving Problems](#)

Related tasks

- [Using AirPrint](#)

Inverted Image

If your printed image is inverted unexpectedly, try these solutions:

- Turn off any mirror or inversion settings in your printing application.
- Turn off the **Mirror Image**, **Flip horizontally**, or **Reverse page orientation** settings in your printer software. (This option has different names, depending on your operating system version.)

Parent topic: [Solving Page Layout and Content Problems](#)

Related tasks

- [Selecting Basic Print Settings - Mac](#)
- [Selecting Additional Layout and Print Options - Windows](#)

Too Many Copies Print

Make sure that the **Copies** setting in your printing program or printer software is not set for multiple copies.

Parent topic: [Solving Page Layout and Content Problems](#)

Related tasks

[Selecting Basic Print Settings - Windows](#)

[Selecting Basic Print Settings - Mac](#)

Blank Pages Print

If blank pages print unexpectedly, try these solutions:

- Make sure you selected the correct paper size settings in your printing program and printer software.
- If a blank page exists in a document you are printing and you want to skip printing it, select the **Skip Blank Page** setting in your printer software, if available.
- Run a print head nozzle check to see if any of the nozzles are clogged. Then clean the print head, if necessary.
- Make sure your product is selected as the printer in your printing program.

Parent topic: [Solving Page Layout and Content Problems](#)

Related concepts

[Print Head Nozzle Check](#)

[Print Head Cleaning](#)

Related references

[Paper or Media Type Settings - Printing Software](#)

[Paper Type Settings - Control Panel](#)

Related tasks

[Selecting Basic Print Settings - Windows](#)

[Selecting Basic Print Settings - Mac](#)

[Selecting Extended Settings - Windows](#)

[Selecting Printing Preferences - Mac](#)

[Printing Your Document or Photo - Mac](#)

[Printing Your Document or Photo - Windows](#)

Related topics

[Loading Paper](#)

Incorrect Margins on Printout

If your printed page has incorrect margins, try these solutions:

- Make sure you selected the correct paper size settings in your printing program and printer software.
- Make sure you selected the correct margins for your paper size in your printing program.
- Make sure your paper is positioned correctly for feeding into the product.
- Select the appropriate original size in the copy settings.

You can use the preview option in your printer software to check your margins before you print.

Parent topic: [Solving Page Layout and Content Problems](#)

Related references

[Copying Options](#)

Related tasks

[Selecting Basic Print Settings - Windows](#)

[Selecting Basic Print Settings - Mac](#)

[Selecting Page Setup Settings - Mac](#)

Related topics

[Loading Paper](#)

[Placing Originals on the Product](#)

Border Appears on Borderless Prints

If you see a border on borderless prints, try these solutions:

- Make sure you are printing on a compatible borderless paper type and size.

Note: For custom paper sizes, make sure you select a supported borderless page width.

- **Windows:** Make sure you selected the **Borderless** setting in your printer software.
- **Mac:** Make sure you selected the **Borderless** checkbox or a paper size with a **Borderless** option in your printer software.
- Adjust the **Expansion** setting to adjust the amount of image expansion on the edges of borderless prints.

- Make sure the image size and the paper size are set correctly; if the image is small, the enlargement may not be enough to cover the paper.

Parent topic: [Solving Page Layout and Content Problems](#)

Related references

[Print Options - Mac](#)

[Borderless Paper Type Compatibility](#)

Related tasks

[Selecting Basic Print Settings - Windows](#)

[Selecting Basic Print Settings - Mac](#)

[Selecting Extended Settings - Windows](#)

[Selecting Printing Preferences - Mac](#)

Incorrect Characters Print

If incorrect characters appear in your prints, try these solutions before reprinting:

- Make sure any cables are securely connected at both ends.
- In Windows, delete all jobs from the Windows Spooler. Click **Print Queue** on the Maintenance tab in the printer settings window, and cancel any stalled print jobs.
- On a Mac, cancel any paused print jobs.
- If your product is connected to a USB hub, connect it directly to your computer instead.
- If incorrect characters still appear in your prints, try connecting your product using a different cable.
- If your computer entered sleep mode the last time you printed, the next print job after your computer exits sleep mode may contain garbled characters. Print your document again.
- Make sure you are using the printer software for this product. Check the product name at the top of the driver window.

Parent topic: [Solving Page Layout and Content Problems](#)

Related tasks

[Printing Your Document or Photo - Windows](#)

[Printing Your Document or Photo - Mac](#)

[Selecting Basic Print Settings - Windows](#)

[Selecting Basic Print Settings - Mac](#)

[Selecting Page Setup Settings - Mac](#)

Incorrect Image Size or Position

If your printed image is the wrong size or in the wrong position, try these solutions:

- Make sure you selected the correct paper size and layout settings in your printing program and printer software.
- Make sure you selected the correct paper size on the control panel.
- Make sure your paper is positioned correctly for feeding into the printer.
- If the edges of a copy are cropped, slightly move the original away from the edges of the scanner glass.
- Make sure you selected the correct margins for your paper size in your printing program.
- If the image is slightly enlarged and cropped during borderless printing, change the **Expansion** setting.

You can use the preview option in your printer software to check your margins before you print.

Parent topic: [Solving Page Layout and Content Problems](#)

Related references

[Copying Options](#)

Related tasks

[Cleaning Your Product](#)

[Selecting Additional Layout and Print Options - Windows](#)

[Selecting Basic Print Settings - Windows](#)

[Selecting Basic Print Settings - Mac](#)

[Selecting Page Setup Settings - Mac](#)

Related topics

[Loading Paper](#)

Slanted Printout

If your printouts are slanted, try these solutions:

- Select a higher print quality setting in your printer software.
- Turn off any high speed settings in your product software.
- Align the print head.
- If aligning the print head did not improve the quality, disable the **Bidirectional Printing** setting.

- Make sure the product is not printing while tilted or at an angle.

Parent topic: [Solving Page Layout and Content Problems](#)

Related tasks

[Aligning the Print Head Using the Product Control Panel](#)

[Selecting Basic Print Settings - Windows](#)

[Selecting Basic Print Settings - Mac](#)

Related topics

[Loading Paper](#)

Solving Print Quality Problems

Check these sections if your printouts have problems with print quality, but your image looks fine on your computer screen.

Note: When printing using AirPrint, the available print settings are different from those covered in this manual. See the Apple website for details.

[White or Dark Lines in Printout](#)

[Blurry or Smearred Printout](#)

[Faint Printout or Printout Has Gaps](#)

[Grainy Printout](#)

[Incorrect Colors](#)

Parent topic: [Solving Problems](#)

Related tasks

[Using AirPrint](#)

Related topics

[Solving Scanned Image Quality Problems](#)

White or Dark Lines in Printout

If you notice white or dark lines in your prints (also called banding), try these solutions before you reprint:

- Run a nozzle check to see if any of the print head nozzles are clogged. Then clean the print head, if necessary.
- Make sure the paper type setting matches the type of paper you loaded.
- Turn off any high speed settings in your product software.

- Align the print head. If print quality does not improve after aligning the print head, disable the bidirectional (high speed) setting.
- Adjust the print quality in the product software.
- If you are copying from the ADF, copy from the scanner glass instead or use a higher quality setting.
- Clean any dust or dirt from your originals.
- Clean the ADF.
- You may need to replace the ink cartridges.
- If you have not used the product for a long time, run the Power Cleaning utility.

Note: Power Cleaning consumes a lot of ink, so run this utility only if you cannot improve print quality by cleaning the print head.

Parent topic: [Solving Print Quality Problems](#)

Related concepts

[Print Head Cleaning](#)

[Print Head Nozzle Check](#)

[Print Head Alignment](#)

[Power Cleaning](#)

Related references

[Paper or Media Type Settings - Printing Software](#)

Related tasks

[Aligning the Print Head Using the Product Control Panel](#)

[Selecting Additional Layout and Print Options - Windows](#)

[Selecting Printing Preferences - Mac](#)

Related topics

[Loading Paper](#)

[Replacing Ink Cartridges and Maintenance Boxes](#)

Blurry or Smearred Printout

If your printouts are blurry or smearred, try these solutions:

- Make sure your paper is not damp, curled, old, or loaded incorrectly in your product.
- Slide the edge guides to the edges of the paper.

- Use a support sheet with special paper, or load special paper one sheet at a time.
- Make sure your paper meets the specifications for your product.
- Use Epson papers to ensure proper saturation and absorption of genuine Epson inks.
- Make sure the paper type setting in your product software matches the type of paper you loaded.
- When manually printing 2-sided, make sure the ink is completely dry before loading the paper.
- Remove each sheet from the output tray as it is printed.
- Avoid handling printouts on glossy paper right after printing to allow the ink to set.
- Turn off any high speed settings in your product software.
- When vertical banding appears or the paper is smeared, clean the paper path.
- When horizontal banding appears or the top or bottom of the paper is smeared, load paper in the correct direction and slide the edge guides to the edges of the paper.
- If you print on both sides of a sheet of paper, smudges may appear on the reverse side of heavily saturated or dark images. If one side of a sheet will contain a lighter image or text, print that side first. Make sure the ink has dried before reloading the paper to print on the other side. Adjust the density and/or ink drying time settings.
- Run a nozzle check to see if any of the print head nozzles are clogged. Then clean the print head, if necessary.

Note: Your product will not operate properly while tilted at an angle. Place it on a flat, stable surface that extends beyond the base of the product in all directions.

Parent topic: [Solving Print Quality Problems](#)

Related concepts

[Print Head Nozzle Check](#)

[Print Head Cleaning](#)

Related references

[Paper Specifications](#)

[Compatible Epson Papers](#)

[Paper or Media Type Settings - Printing Software](#)

Related tasks

[Aligning the Print Head Using the Product Control Panel](#)

[Cleaning the Paper Guide](#)

[Cleaning the Print Head Path](#)
[Selecting Additional Layout and Print Options - Windows](#)
[Selecting Printing Preferences - Mac](#)
[Selecting Basic Print Settings - Windows](#)
[Selecting Basic Print Settings - Mac](#)
[Selecting Extended Settings - Windows](#)

Related topics

[Loading Paper](#)

Faint Printout or Printout Has Gaps

If your printouts are faint or have gaps, try these solutions:

- Run a nozzle check to see if any of the print head nozzles are clogged. Then clean the print head, if necessary.
- The ink cartridges may be old or low on ink, and you may need to replace them.
- Make sure the paper type setting matches the type of paper you loaded.
- Make sure your paper is not damp, curled, old, or loaded incorrectly in your product.
- When copying, increase the **Density** setting on the product control panel.
- Align the print head.
- Adjust the print quality in the product software.
- Clean the paper path.
- If you have not used the product for a long time, run the Power Cleaning utility.

Note: Power Cleaning consumes a lot of ink, so run this utility only if you cannot improve print quality by cleaning the print head.

Parent topic: [Solving Print Quality Problems](#)

Related concepts

[Print Head Nozzle Check](#)

[Print Head Cleaning](#)

Related references

[Paper Type Settings - Control Panel](#)

[Paper or Media Type Settings - Printing Software](#)

Related tasks

[Aligning the Print Head Using the Product Control Panel](#)

[Cleaning the Paper Guide](#)

[Cleaning the Print Head Path](#)

Related topics

[Loading Paper](#)

[Replacing Ink Cartridges and Maintenance Boxes](#)

Grainy Printout

If your printouts are grainy, try these solutions:

- Make sure you loaded the printable side of the paper correctly for your product.
- Select a higher print quality setting and turn off any high speed settings in your product software.
- Run a nozzle check to see if any of the print head nozzles are clogged. Then clean the print head, if necessary.
- Align the print head.
- Adjust the print quality in the product software.
- If a cross-hatch pattern appears in the copied image, change the **Reduce/Enlarge** setting. If a cross-hatch pattern still appears, place the original at a slightly different angle.
- You may need to increase the image resolution or print a smaller size; see your software documentation.

Note: Images from the Internet may be low resolution and not result in a high quality printout.

- If you enlarged the image size in an image-editing program, you need to increase the image resolution setting to retain a high image quality. Increase the image resolution by the same amount you increase the image size. For example, if the image resolution is 300 dpi (dots per inch) and you will double the image size for printing, change the resolution setting to 600 dpi.

Note: Higher resolution settings result in larger file sizes, which take longer to process and print. Consider the limitations of your computer system when selecting a resolution, and select the lowest possible resolution that produces acceptable quality to keep file sizes manageable.

Parent topic: [Solving Print Quality Problems](#)

Related concepts

[Print Head Nozzle Check](#)

[Print Head Cleaning](#)

Related tasks

[Aligning the Print Head Using the Product Control Panel](#)

[Selecting Printing Preferences - Mac](#)

[Selecting Additional Layout and Print Options - Windows](#)

[Selecting Basic Print Settings - Mac](#)

[Selecting Basic Print Settings - Windows](#)

Related topics

[Loading Paper](#)

Incorrect Colors

If your printouts have incorrect colors, try these solutions:

- Make sure the paper type setting matches the paper you loaded.
- Make sure the **Grayscale** setting is not selected in your printer software.
- Run a nozzle check to see if any of the print head nozzles are clogged. Then clean the print head, if necessary.
- The ink cartridges may be old or low on ink, and you may need to replace them.
- After you print, the colors in your printout need time to set as the ink dries. During this time, the colors may look different than you expect. To speed up drying time, do not stack your printouts on top of each other.
- Your printed colors can never exactly match your on-screen colors. However, you can use a color management system to get as close as possible. Try using the color management options in your printer software.
- Select **Custom** as the **Color Correction** setting on the More Options tab of the printer software, then click **Advanced**. Try changing the **Scene Correction** setting to something other than **Automatic**. If changing that setting does not work, change the **Color Management** setting to any color correction method other than **PhotoEnhance**.
- If you are using a Mac, select **ColorSync** from the **Color Matching** menu of the driver.
- Remove any dust or dirt on the originals and clean the scanner glass.
- Do not press with too much force on the original or the document cover.

- If you are copying an original, lower the **Density** setting.

Parent topic: [Solving Print Quality Problems](#)

Related concepts

[Print Head Nozzle Check](#)

[Print Head Cleaning](#)

Related references

[Compatible Epson Papers](#)

Related tasks

[Selecting Basic Print Settings - Windows](#)

[Selecting Additional Layout and Print Options - Windows](#)

[Selecting Basic Print Settings - Mac](#)

[Managing Color - Mac](#)

Related topics

[Replacing Ink Cartridges and Maintenance Boxes](#)

Solving Scanning Problems

Check these solutions if you have problems scanning with your product.

Note: For solutions when using the Epson ScanSmart software, see the Epson ScanSmart help utility.

[Scanning Software Does Not Operate Correctly](#)

[Cannot Start Epson Scan 2](#)

[Scanning is Slow](#)

[Cannot Save a Scan to a Shared Folder Over a Network](#)

Parent topic: [Solving Problems](#)

Scanning Software Does Not Operate Correctly

If your scanning software does not operate correctly, try these solutions:

- Make sure your computer has adequate memory and meets the system requirements for your operating system.
- Make sure your computer is not running in a power-saving mode, such as sleep or standby. If so, wake your system and restart your scanning software.

- If you upgraded your operating system but did not reinstall your scanning software, try reinstalling it.
- In Windows, make sure your product is listed as a valid device in the **Scanners and Cameras** control panel.
- If you are scanning with the ADF, make sure the ADF and document covers are closed.
- Try scanning at a lower resolution or increase the free space on the computer's hard disk. Scanning stops if the total data size reaches the limit.
- When scanning multiple originals using Epson ScanSmart, make sure there is a gap of at least 0.8 inches (20 mm) between the originals.
- Use the Epson Scan 2 Utility on your computer to reset the scanner software settings. If resetting the settings does not solve the problem, uninstall and reinstall the scanner software.

Parent topic: [Solving Scanning Problems](#)

Related concepts

[Uninstall Your Product Software](#)

Related references

[Windows System Requirements](#)

[Mac System Requirements](#)

Cannot Start Epson Scan 2

If you cannot start Epson Scan 2, try these solutions:

- Make sure your product is turned on and any interface cables are securely connected at both ends.
- If your product is connected to a USB hub, connect it directly to your computer instead.
- If you scan at a high resolution over a network, a communication error may occur. Lower the resolution.
- If you are scanning with the ADF, check that the document cover and ADF cover are closed.
- Make sure Epson Scan 2 is selected as your scanning program.
- Make sure your computer is not running in a power-saving mode, such as sleep or standby. If so, wake your system and restart Epson Scan 2.
- Check the connection setting and test the connection using Epson Scan 2 Utility:

Windows 11: Click , search for **Epson Scan 2 Utility** and select it. Make sure the correct product is selected. If necessary, select the **Other** tab and click **Reset**.

Windows 10: Click  and select **EPSON > Epson Scan 2 Utility**. Make sure the correct product is selected. If necessary, select the **Other** tab and click **Reset**.

Windows 8.x: Navigate to the **Apps** screen and select **Epson Scan 2 Utility**. Make sure the correct product is selected. If necessary, select the **Other** tab and click **Reset**.

Windows (other versions): Click  or **Start > All Programs** or **Programs > EPSON > Epson Scan 2 > Epson Scan 2 Utility**. Make sure the correct product is selected. If necessary, select the **Other** tab and click **Reset**.

Mac: Open the **Applications** folder, click **Epson Software**, and click **Epson Scan 2 Utility**. Make sure the correct product is selected. If necessary, select the **Other** tab and click **Reset**.

- Make sure you do not have multiple versions of Epson Scan 2 installed. If you do, uninstall both versions and install one version.
- If you upgraded your operating system but did not reinstall Epson Scan 2, try reinstalling it.

Parent topic: [Solving Scanning Problems](#)

Related concepts

[Uninstall Your Product Software](#)

Related topics

[Starting a Scan](#)

Scanning is Slow

If scanning becomes slow, try these solutions:

- Scan your original at a lower resolution, if possible.
- Make sure your system meets the requirements for your operating system. If you are scanning a high-resolution image, you may need more than the minimum requirements. If necessary, increase your system's memory or reduce the resolution.
- The scanning speed may be reduced depending on the image adjustment features in Epson Scan 2.
- If you are scanning over a wireless network, factors such as interference, network traffic, or weak signal strength may affect your scanning speed.

Parent topic: [Solving Scanning Problems](#)

Related topics

[Wi-Fi or Wired Networking](#)

Cannot Save a Scan to a Shared Folder Over a Network

If you cannot save a scan to a shared folder when scanning over a network, or saving takes a very long time, try these solutions:

- If you cannot scan to a shared folder over the network, make sure you did the following:
 - Created a shared folder on your computer (Windows).
 - If you registered the shared folder path to your product's control panel contact list or entered the path manually to scan, make sure you used the correct path.
 - Make sure the network folder does not already contain a file of the same name. If so, rename the file and try again.
- If you still cannot scan to the shared folder, your network type may be set to **Public**. You cannot scan to a shared folder when using a public network. Follow the steps here to check and change your network type, if necessary. Be sure to log into your Windows computer as an administrator.

Note: The name of available network types varies in the different Windows versions. For details on selecting Windows network sharing settings, see Windows help.

Windows 10:

1. Click  and select **Settings**.
2. Select **Network & Internet**.
3. Click your network type: **Ethernet** or **Wi-Fi**.
4. Click your network name.
5. Make sure the **Make this PC discoverable** setting is set to **On**. Select this setting when connected to a private network so you can save a scan to a shared folder. If you select **Off**, you cannot save your scan to a shared folder on a private network.

Windows 8.1:

1. At the Start screen, type **PC Settings** to automatically search the system.
2. Click **Network** in the PC Settings window.
3. Click your network name.
4. Make sure **Find devices and content** is set to **On**. Select this setting when connected to a private network so you can save a scan to a shared folder. If you select **Off**, you cannot save your scan to a shared folder on a private network.

Windows 8.0:

1. At the Start screen, type **Settings** to automatically search the system.
2. Select **Settings** when it appears and type **Network** into the search field.
3. Right-click your network name in the window that appears and click **Turn sharing on or off**.
4. When you see this message, select **Yes**:

Do you want to turn on sharing between the PCs and connect to devices on this network?

Select this setting when connected to a private network so you can save a scan to a shared folder. If you select **No**, you cannot save your scan to a shared folder on a private network.

Windows 7:

1. Click  or press the Windows key on your keyboard.
 2. Type **Network and Sharing Center** into the search field.
 3. Under View your active networks, make sure **Home network** or **Work network** is selected when connected to a private network so you can save a scan to a shared folder. (If you need to change the network type, click the network type name.) If you select **Public network**, you cannot save a scan to a shared folder.
- If saving your scan to a shared folder takes a very long time, make sure the DNS setting and the DNS domain name are correct. Contact your network administrator for instructions.

Parent topic: [Solving Scanning Problems](#)

Solving Scanned Image Quality Problems

Check these sections if a scanned image on your computer screen has a quality problem.

Note: For solutions when using the Epson ScanSmart software, see the Epson ScanSmart help utility.

[Scanned Image Quality Problems](#)

[Image Consists of a Few Dots Only](#)

[Line of Dots Appears in All Scanned Images](#)

[Straight Lines in an Image Appear Crooked](#)

[Characters are Not Recognized During Conversion to Editable Text \(OCR\)](#)

[Image Colors are Patchy at the Edges](#)

[Ripple Patterns Appear in an Image](#)

[Scanned Image Edges are Cropped](#)

Scanned Image Quality Problems

If you encounter quality problems with your scanned image, try these solutions:

Image is Distorted or Blurry

- Make sure your original is not wrinkled or warped. This may prevent the original from laying flat on the scanner glass.
- Do not move your original or your product during scanning.
- Clean the scanner glass and the ADF and remove any dirt or dust on your originals.
- Do not press on the document cover or the original with too much force.
- If you are scanning from the ADF, place your originals on the scanner glass. Some originals may not be scanned properly from the ADF.
- Your product will not operate properly while tilted at an angle. Place your product on a flat, stable surface that extends beyond its base in all directions.
- Adjust these Epson Scan 2 or Epson ScanSmart settings (if available) and try scanning again:
 - Increase the **Resolution** setting.
 - If the **Image Type** setting is **Black & White**, adjust the **Threshold** setting.
 - If the **Image Type** setting is **Color** or **Grayscale**, select the **Unsharp Mask** setting.
 - If the **Image Type** setting is **Black & White**, select **Text Enhancement**. If the **Image Type** setting is **Color** or **Grayscale**, change the **Text Enhancement** setting to **High**.

Image is Too Dark

- Make sure you select the correct **Image Type** for your original.
- If the **Image Type** is set to **Color** or **Grayscale**, adjust the **Brightness** setting.
- Check the brightness and contrast settings of your computer monitor.

Back of Original Image Appears in Scanned Image

- Place a piece of black paper on the back of the original and scan it again.
- Adjust these Epson Scan 2 settings (if available) and try scanning again:
 - Select the **Advanced Settings** tab and adjust the **Brightness** setting.

Scanned Image Colors Do Not Match Original Colors

Printed colors can never exactly match the colors on your computer monitor because printers and monitors use different color systems: monitors use RGB (red, green, and blue) and printers typically use CMYK (cyan, magenta, yellow, and black).

Check the color matching and color management capabilities of your computer, display adapter, and the software you are using to see if they are affecting the palette of colors you see on your screen.

Remove any dust or dirt from your originals and clean the scanner glass. Do not press with too much force on the original or document cover.

To adjust the colors in your scanned image, adjust these Epson Scan 2 settings (if available) and try scanning again:

- If the **Image Type** setting is **Color** or **Grayscale**, adjust the **Contrast** setting.
- If the **Image Type** setting is **Black & White** or **Grayscale**, adjust the **Color Enhance** setting.

Parent topic: [Solving Scanned Image Quality Problems](#)

Related references

[Additional Scanning Settings - Main Settings Tab](#)

[Additional Scanning Settings - Advanced Settings Tab](#)

Related tasks

[Cleaning Your Product](#)

Image Consists of a Few Dots Only

If your scanned image consists only of a few dots, try these solutions:

- Make sure you placed your original for scanning facing the correct way.
- If the **Image Type** setting is **Black & White**, adjust the **Threshold** and scan again.
- Remove any lint or dirt from your original.
- Clean the scanner glass.
- Do not press on the original or the document cover with too much force.

Parent topic: [Solving Scanned Image Quality Problems](#)

Related tasks

[Cleaning Your Product](#)

Line of Dots Appears in All Scanned Images

If a line of dots appears in all your scanned images, try these solutions:

- Clean the scanner glass with a soft, dry, lint-free cloth or use a small amount of glass cleaner on the cloth, if necessary. Paper towels are not recommended.

Caution: Do not spray glass cleaner directly on the scanner glass.

- Make sure any interface cables are securely connected at both ends.
- Remove any dust or dirt that may have adhered to your original.
- Do not press with too much force on the original or the document cover.

If you are scanning from the ADF, make sure the ADF edge guide fits against the loaded originals. You can also try cleaning the ADF and scanning again.

Parent topic: [Solving Scanned Image Quality Problems](#)

Related tasks

[Cleaning Your Product](#)

Straight Lines in an Image Appear Crooked

If straight lines in an original appear crooked in a scanned image, make sure to place your original straight when you scan it.

If you are scanning from the ADF, make sure the ADF edge guide fits against the loaded originals. You can also try cleaning the ADF and scanning again.

Parent topic: [Solving Scanned Image Quality Problems](#)

Related tasks

[Cleaning Your Product](#)

Related topics

[Placing Originals on the Product](#)

Characters are Not Recognized During Conversion to Editable Text (OCR)

If characters in your scanned images are not recognized during OCR conversion, try these solutions:

- Make sure your original is loaded straight on your product.
- Use an original with clear text.
- When saving scanned images as Searchable PDFs, make sure the correct OCR language is selected.

- Adjust the following Epson Scan 2 or Epson ScanSmart settings if available, and try scanning again:
 - On the **Main Settings** tab, make sure you select the correct **Image Type** for your original.
 - On the **Main Settings** tab, set the **Resolution** between 200 and 600 dpi.
 - On the **Advanced Settings** tab, select **Text Enhancement** and choose a setting.

Note: The **Text Enhancement** setting depends on the selected **Image Type**.

- If the **Image Type** is set to **Black & White**, adjust the **Threshold** setting on the **Advanced Settings** tab. (The **Image Option** must be set to **None**.)

Parent topic: [Solving Scanned Image Quality Problems](#)

Related tasks

[Scanning a Document in Epson ScanSmart](#)

[Scanning in Epson Scan 2](#)

Related topics

[Placing Originals on the Product](#)

Image Colors are Patchy at the Edges

If you are scanning a thick or warped original, cover its edges with paper to block external light as you scan it.

Parent topic: [Solving Scanned Image Quality Problems](#)

Ripple Patterns Appear in an Image

You may see a ripple pattern (called a moiré) in scanned images of printed documents. This is caused by interference from differing pitches in the scanner's screen and your original's halftone screen. To reduce this effect, adjust these Epson Scan 2 settings (if available) and try scanning again:

- Select the **Descreening** setting.
- Select a lower **Resolution** setting.
- Place the original at a slightly different angle.

Parent topic: [Solving Scanned Image Quality Problems](#)

Related references

[Additional Scanning Settings - Main Settings Tab](#)

[Additional Scanning Settings - Advanced Settings Tab](#)

Scanned Image Edges are Cropped

If the edges of a scanned image are cropped, make sure your original is placed correctly for scanning. If necessary, move your original away from the edges of the scanner glass slightly.

In the Epson Scan 2 or Epson ScanSmart settings, set the **Edge Fill** setting to **None**.

When scanning using Epson ScanSmart and placing multiple originals on the scanner glass, make sure there is a gap of at least 0.8 in. (20 mm) between the originals.



Parent topic: [Solving Scanned Image Quality Problems](#)

Related topics

[Placing Originals on the Product](#)

Resetting the Epson Scan 2 Settings

If you continue to experience image quality problems after trying all possible solutions, you may need to reset the Epson Scan 2 settings using the Epson Scan 2 Utility.

1. Do one of the following to start the Epson Scan 2 Utility:
 - **Windows 11:** Click , then search for **Epson Scan 2 Utility** and select it.
 - **Windows 10:** Click  > **EPSON** > **Epson Scan 2 Utility**.
 - **Windows 8.x:** Navigate to the **Apps** screen and select **Epson Scan 2 Utility**.
 - **Windows (other versions):** Click  or **Start**, and select **All Programs** or **Programs**. Select **EPSON** > **Epson Scan 2** > **Epson Scan 2 Utility**.
 - **Mac:** Open the **Applications** folder, open the **Epson Software** folder, and select **Epson Scan 2 Utility**.
2. Click the **Other** tab.
3. Click **Reset** and confirm your choice.

Note: If resetting the Epson Scan 2 settings does not solve your problem, uninstall Epson Scan 2 and re-install it.

Parent topic: [Solving Scanned Image Quality Problems](#)

Solving Faxing Problems

Check these solutions if you have problems faxing with your product.

[Cannot Send or Receive Faxes](#)
[Cannot Receive Faxes with a Telephone Connected to Your Product](#)
[Fax Memory Full Error Appears](#)
[Fax Quality is Poor](#)
[Sent Fax is Received in an Incorrect Size](#)
[Received Fax is Not Printed](#)

Parent topic: [Solving Problems](#)

Related tasks

[Setting Up the Fax Utility - Windows](#)
[Setting Up Fax Features Using the Fax Utility - Mac](#)
[Checking Fax Status](#)
[Printing Fax Reports](#)
[Selecting the Date and Time](#)

Related topics

[Setting Up Fax Features](#)

Cannot Send or Receive Faxes

If you cannot send or receive faxes, try these solutions:

- Use **Check Fax Connection** on the control panel (**Settings** > **General Settings** > **Fax Settings** > **Check Fax Connection**) to run the automatic fax connection check. Try the solutions suggested in the report.
- If you are faxing from a computer, use the Epson FAX Utility to send your fax.
- Make sure the recipient's fax machine is turned on and working.
- Make sure the recipient's fax number is correct and entered correctly.
- Make sure paper is loaded correctly in your product.
- Make sure you have set up your header information and have not blocked your caller ID. Otherwise, your faxes might be rejected by the recipient's fax machine.
- Make sure Receive Mode is set to **Auto** so you can receive faxes automatically.
- If you did not connect a telephone to your product, set the Receive Mode setting to **Auto** so you can receive faxes automatically.
- Check that the cable connecting your telephone wall jack to your product's **LINE** port is secure.

- Print a fax connection report using your product control panel or fax software to help diagnose the problem.
- Verify that the telephone wall jack works by connecting a phone to it and testing it.
- If there is no dial tone and you connected the product to a PBX (Private Branch Exchange) phone line or Terminal Adapter, change the **Line Type** setting to **PBX**. If you still cannot send a fax, turn off the product's dial tone detection setting. (Turning off the dial tone setting may cause the product to drop the first digit of a fax number.)
- Check the **Line Type** setting and set it to **PBX**. If your phone system requires an external access code to reach an outside line, register the code to the product and add a # (hash) to the beginning of the phone number when dialing.
- If you connected your product to a DSL phone line, you must connect a DSL filter to the phone jack to enable faxing over the line. Contact your DSL provider for the necessary filter.
- If you are connected to a DSL phone line, connect the product directly to a telephone wall jack and send a fax. If it works, the problem may be caused by the DSL filter. Contact your DSL provider.
- Make sure you installed the FAX driver for your product and that it is not paused.
- The data being sent may be too large. Try faxing the originals in batches or by using a connected phone. If you are faxing in monochrome, enable the **Direct Send** setting (**Fax > Fax Settings > Fax Send Settings**).
- Try lowering your product's fax speed setting.
- Try lowering the recipient's fax speed setting from the contact list menu.
- If a communication error occurs, change the **Fax Speed** setting to **Slow(9,600bps)** on the control panel.
- Make sure the error correction mode (ECM) setting is turned on if you are trying to send or receive a color fax.
- If your telephone line uses call waiting and you have trouble receiving faxes, turn off call waiting to prevent disruption of incoming faxes.
- If you have subscribed to a call forwarding service, the product may not be able to receive faxes. Contact your service provider for assistance.
- If the recipient fax machine does not answer your call within 50 seconds after the product has finished dialing, add pauses after the fax number to send the fax.
- Check your inbox and delete faxes after reading or printing them. If the inbox is full, the product cannot receive faxes.

- When you have made settings to save received faxes to a computer, turn on the computer. The received fax is deleted once it has been saved to the computer.
- Check if the sender's fax number is registered to the **Rejection Number List**
- If you enabled **Rejection Fax** options, check if the sender is blocked, did not set up header information, or is not registered in your contacts list, as necessary.
- If you cannot send faxes at a specified time, make sure the date and time are set correctly on the product.
- If you have not connected a telephone to the printer, set the **Receive Mode** setting to **Auto** on the control panel.
- If you are receiving faxes using the Epson FAX Utility, check that your product is registered as a fax product in your operating system:

Windows: Make sure the product appears in **Devices and Printers**, **Printer**, or **Printers and Other Hardware**. If the product does not appear, uninstall and re-install the Epson FAX Utility.

Mac: Select **System Preferences > Printers & Scanners** (or **Print & Scan** or **Print & Fax**) and make sure your product appears. If your product does not appear, click **+** and add your product. If the product does appear, double-click it and make sure it is not paused.

Note: If your product is connected to a VoIP (Voice over Internet Protocol) phone line, keep in mind that fax machines are designed to work over analog phone lines. Epson cannot guarantee that fax transmission will work when using VoIP.

If your phone line includes voice mail answering services, calls or faxes may be inadvertently received by your voice mail service.

Parent topic: [Solving Faxing Problems](#)

Related tasks

[Connecting a Telephone or Answering Machine](#)

[Using the Fax Setup Wizard](#)

[Selecting the Line Type](#)

[Selecting Advanced Fax Settings](#)

[Receiving Faxes Automatically](#)

[Printing Fax Reports](#)

Cannot Receive Faxes with a Telephone Connected to Your Product

If you cannot receive faxes when a telephone is connected to your product, try these solutions:

- Make sure your telephone is connected to your product's **EXT** port.
- Make sure the Receive Mode is set to **Manual**.

Note: When answering a call that is a fax, wait until the product's LCD screen displays a message that a connection has been made before you hang up.

Parent topic: [Solving Faxing Problems](#)

Related tasks

[Using the Fax Setup Wizard](#)

[Connecting a Telephone or Answering Machine](#)

[Receiving Faxes Manually](#)

Fax Memory Full Error Appears

If you see an error message telling you that the product's fax memory is full, try these solutions:

- If you set the product to save received faxes in the product's memory or inbox, delete any faxes you have already read.

Note: Your product can store up to 100 faxes before its inbox is full.

- If you set the product to save received faxes on a computer, turn on the selected computer. Once the faxes are saved on the computer, they are deleted from the product's memory.
- If the memory is full, try the following:
 - Send a monochrome fax using the direct sending feature
 - Send your faxes in smaller batches
- If the product cannot print a received fax due to a product error, such as a paper jam, the memory full error may appear. Clear any product errors, then ask the sender to resend the fax.

Parent topic: [Solving Faxing Problems](#)

Related references

[Fax Sending Options](#)

Related tasks

[Setting Up the Fax Utility - Windows](#)

Fax Quality is Poor

If you receive a poor quality fax, try these solutions:

- Try enabling the error correction mode (ECM) setting.
- Contact the fax sender and ask them to send the fax in a higher resolution.
- Try reprinting the received fax.

If the sent fax quality is poor, try these solutions:

- Clean the scanner glass.
- Clean the ADF.
- Try changing the resolution or density setting on the control panel.
- Do not press on the document cover or the original with too much force.
- Remove any dust or dirt from the originals.
- Try changing the original type setting on the control panel.
- If you are sending a monochrome fax to a single recipient, try sending the fax using the **Direct Send** feature.

Note: If you send a high-resolution monochrome fax without using the **Direct Send** feature, the product may automatically lower the resolution.

- Try enabling the error correction mode (ECM) setting.

Parent topic: [Solving Faxing Problems](#)

Related references

[Basic Settings - Fax](#)

[Fax Sending Options](#)

Related tasks

[Cleaning Your Product](#)

Sent Fax is Received in an Incorrect Size

If your recipient receives a fax in an incorrect size, try these solutions:

- Make sure the original is placed correctly against the alignment marks.
- Clean any dust or dirt from the originals.

- If you are sending a fax using the scanner glass, make sure your original is placed correctly and that the correct paper size is selected on the control panel.
- Clean the scanner glass and document cover.

Parent topic: [Solving Faxing Problems](#)

Related tasks

[Cleaning Your Product](#)

Related topics

[Placing Originals on the Product](#)

Received Fax is Not Printed

If a received fax is not printed, try these solutions:

- Make sure the product is free of errors. The product cannot print received faxes if an error has occurred with the product, such as a paper jam.
- If the product has been set to save received faxes in the product's memory or inbox, received faxes are not automatically printed. Check the **Receive Settings** options on the product control panel and change them, if necessary.

Parent topic: [Solving Faxing Problems](#)

Related references

[Receive Settings - Fax](#)

Uninstall Your Product Software

If you have a problem that requires you to uninstall and re-install your software, follow the instructions for your operating system.

[Uninstalling Product Software - Windows](#)



[Uninstalling Product Software - Mac](#)

Parent topic: [Solving Problems](#)

Uninstalling Product Software - Windows

You can uninstall and then re-install your product software to solve certain problems.

1. Turn off the product.
2. Close any open programs or applications.
3. Disconnect any interface cables.

4. Do one of the following:
 - **Windows 11:** Click , then search for **Settings** and select it. Select **Apps** or **System > Apps & features**. Then select the program you want to uninstall and select **Uninstall**.
 - **Windows 10:** Click  and select  (Settings) > **Apps** or **System > Apps & features**. Then select the program you want to uninstall and select **Uninstall**.
 - **Windows 8.x:** Navigate to the **Apps** screen and select **Control Panel > Programs > Programs and Features**. Select the uninstall option for your Epson product, then select **Uninstall/Change**.

Note: If you see a **User Account Control** window, click **Yes** or **Continue**.

Select your product again, if necessary, then select **OK**, and click **Yes** to confirm the uninstallation.

- **Windows (other versions):** Click  or **Start**, and select **All Programs** or **Programs**. Select **EPSON**, select your product, then click **EPSON Printer Software Uninstall**.

Note: If you see a **User Account Control** window, click **Yes** or **Continue**.

In the next window, select your product and click **OK**. Then follow any on-screen instructions.

5. Do one of the following to uninstall Epson Event Manager, then follow any on-screen instructions:
 - **Windows 11/Windows 10/8.x:** Select **Epson Event Manager** and click **Uninstall**.
 - **Windows 7/Windows Vista:** Open the Windows **Control Panel** utility. Select **Programs and Features**. (In Classic view, select **Programs** and click **Uninstall a program**.) Select **Epson Event Manager** and click **Uninstall/Change**.
6. Do one of the following to uninstall Epson Scan 2, then follow any on-screen instructions:
 - **Windows 11/Windows 10:** Select **Epson Scan 2** and click **Uninstall**.
 - **Windows 8.x/Windows 7/Windows Vista:** Select **Epson Scan 2** and click **Uninstall/Change**.
7. Do one of the following to uninstall Epson ScanSmart, then follow any on-screen instructions:
 - **Windows 11/Windows 10:** Select **Epson ScanSmart** and click **Uninstall**.
 - **Windows 8.x/Windows 7/Windows Vista:** Select **Epson ScanSmart** and click **Uninstall/Change**.
8. Restart your computer, then see the *Start Here* sheet to re-install your software.

Note: If you find that re-installing your product software does not solve a problem, contact Epson.

Parent topic: [Uninstall Your Product Software](#)

Uninstalling Product Software - Mac

In most cases, you do not need to uninstall your product software before re-installing it. However, you can download the Uninstaller utility from the Epson support website to uninstall your product software as described here.

Note: If you find that re-installing your product software does not solve a problem, contact Epson.

1. To download the Uninstaller utility, visit epson.com/support (U.S.) or epson.ca/support (Canada) and select your product.
2. Click **Downloads**.
3. Select your operating system, click **Utilities**, locate the Uninstaller utility, and click **Download**.
4. Run the file you downloaded.
5. Double-click the **Uninstaller** icon.
6. In the Epson Uninstaller screen, select the checkbox for each software program you want to uninstall.
7. Click **Uninstall**.
8. Follow the on-screen instructions to uninstall the software.
9. Reinstall your product software.

Note: If you uninstall the printer driver and your product name remains in the **Print & Fax**, **Print & Scan**, or **Printers & Scanners** window, select your product name and click the – (remove) icon to remove it.

Parent topic: [Uninstall Your Product Software](#)

Where to Get Help

If you need to contact Epson for technical support services, use the following support options.

Internet Support

Visit Epson's support website at epson.com/support (U.S.) or epson.ca/support (Canada) and select your product for solutions to common problems. You can download drivers and documentation, get FAQs and troubleshooting advice, or e-mail Epson with your questions.

Speak to a Support Representative

Before you call Epson for support, please have the following information ready:

- Product name
- Product serial number (located on a label on the product)
- Proof of purchase (such as a store receipt) and date of purchase
- Computer configuration
- Description of the problem

Then call:

- U.S.: (562) 276-4382, 7 AM to 4 PM, Pacific Time, Monday through Friday
- Canada: (905) 709-3839, 7 AM to 4 PM, Pacific Time, Monday through Friday

Days and hours of support are subject to change without notice. Toll or long distance charges may apply.

Purchase Supplies and Accessories

You can purchase genuine Epson ink and paper at epson.com (U.S. sales) or epson.ca (Canadian sales). You can also purchase supplies from an Epson authorized reseller. To find the nearest one, call 800-GO-EPSON (800-463-7766) in the U.S. or 800-807-7766 in Canada.

Parent topic: [Solving Problems](#)

Technical Specifications

These sections list the technical specifications for your product.

Note: Epson offers a recycling program for end of life Epson products. Please go to [this site](#) (U.S.) or [this site](#) (Canada) for information on how to return your Epson products for proper disposal.

[Windows System Requirements](#)

[Mac System Requirements](#)

[Paper Specifications](#)

[Printable Area Specifications](#)

[Automatic Document Feeder \(ADF\) Specifications](#)

[Scanning Specifications](#)

[Fax Specifications](#)

[Ink Cartridge Specifications](#)

[Dimension Specifications](#)

[Electrical Specifications](#)

[Environmental Specifications](#)

[Interface Specifications](#)

[Network Interface Specifications](#)

[Safety and Approvals Specifications](#)

Windows System Requirements

To use your product and its software, your computer should use one of these Microsoft operating systems:

- Windows 11
- Windows 10
- Windows 8.x
- Windows 7
- Windows Vista
- Windows Server 2022
- Windows Server 2019

- Windows Server 2016
- Windows Server 2012 R2
- Windows Server 2012
- Windows Server 2008 R2
- Windows Server 2008
- Windows Server 2003 R2
- Windows Server 2003 SP2 or later

Windows Server supports only the printer driver and Epson Scan 2; any additional included software is not supported.

Note: For the latest product software available for your operating system, visit the Epson support site at epson.com/support (U.S.) or epson.ca/support (Canada), select your product, and select **Downloads**.

Parent topic: [Technical Specifications](#)

Mac System Requirements

To use your product and its software, your Mac should use one of these operating systems:

- macOS 12.x
- macOS 11.x
- macOS 10.15.x
- macOS 10.14.x
- macOS 10.13.x
- macOS 10.12.x
- OS X 10.11.x
- OS X 10.10.x
- OS X 10.9.x

Note: Mac OS may not support some applications and features; the UNIX File System (UFS) for Mac OS is not supported.

Note: For the latest product software available for your operating system, visit the Epson support site at epson.com/support (U.S.) or epson.ca/support (Canada), select your product, and select **Downloads**.

Paper Specifications

Note: Since the quality of any particular brand or type of paper may be changed by the manufacturer at any time, Epson cannot guarantee the quality of any non-Epson brand or type of paper. Always test a sample of paper stock before purchasing large quantities or printing large jobs.

Single-sheets

Size	A4 (8.3 × 11.7 inches [210 × 297 mm]) A6 (4.1 × 5.8 inches [105 × 148 mm]) Letter (8.5 × 11 inches [216 × 279 mm]) Legal (8.5 × 14 inches [216 × 356 mm]) Oficio 9 (8.46 × 12.4 inches [215 × 315 mm]) Mexico-Oficio (8.5 × 13.4 inches [216 × 340 mm]) 8.5 × 13 inches (216 × 330 mm) Executive (7.25 × 10.5 inches [184 × 267 mm]) 3.5 × 5 inches (89 × 127 mm) 4 × 6 inches (102 × 152 mm) 5 × 7 inches (127 × 178 mm) 8 × 10 inches (203 × 254 mm) Half Letter (5.5 × 8.5 inches [140 × 216 mm])
-------------	--

Paper types

Plain paper

Note: Your product also supports compatible papers distributed by Epson. See the link at the end of this topic for a list of compatible Epson papers.

Weight

17 lb (64 g/m²) to 24 lb (90 g/m²)

Envelopes

Size

No. 10 (4.1 × 9.5 inches [105 × 241 mm])

Paper types

Plain bond paper

Weight

20 lb (75 g/m²) to 25.5 lb (100 g/m²)

Parent topic: [Technical Specifications](#)

Related references

[Compatible Epson Papers](#)

Printable Area Specifications

Note: When printing borderless, quality may decline in the expanded printable area.

Single sheets - borders

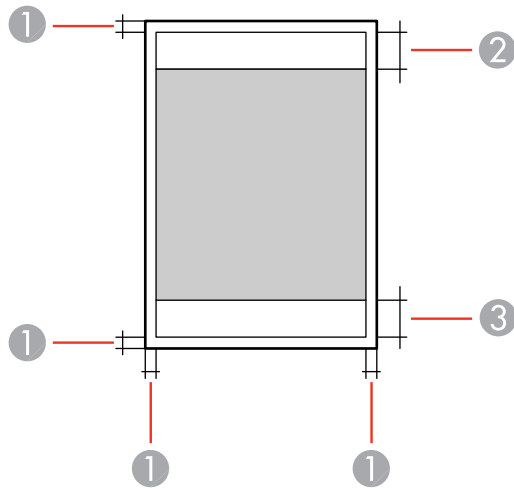

- 1 Top/bottom/left/right margins: 0.12 inch (3 mm) minimum
- 2 Reduced print quality area/top: 1.61 inches (41 mm) minimum
- 3 Reduced print quality area/bottom: 1.46 inches (37 mm) minimum

Single sheets - borderless

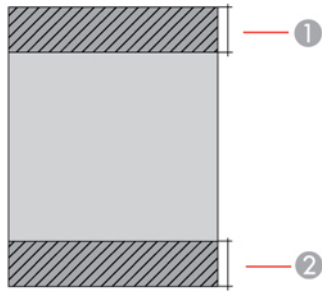

- 1 Reduced print quality area/top: 1.73 inches (44 mm) minimum
- 2 Reduced print quality area/bottom: 1.57 inches (40 mm) minimum

Envelopes

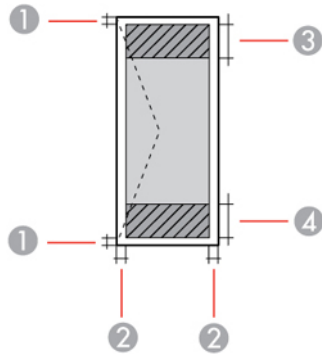

- 1 Right/left margins: 0.12 inch (3 mm) minimum
- 2 Top/bottom margins: 0.12 inch (3 mm) minimum
- 3 Reduced print quality area/right: 0.71 inch (18 mm) minimum
- 4 Reduced print quality area/left: 1.61 inches (41 mm) minimum

Parent topic: [Technical Specifications](#)

Automatic Document Feeder (ADF) Specifications

Paper size	Letter (8.5 × 11 inches [216 × 279 mm]) A4 (8.3 × 11.7 inches [210 × 297 mm]) 8.5 × 13 inches (216 × 330 mm) Legal (8.5 × 14 inches [216 × 356 mm])
Paper type	Plain paper
Paper weight	17 lb (64 g/m ²) to 24 lb (95 g/m ²)
Sheet feeding capacity	Letter (8.5 × 11 inches [216 × 279 mm]) and A4 (8.3 × 11.7 inches [210 × 297 mm]): approximately 30 sheets or 0.13 inch (3.3 mm) 8.5 × 13 inches (216 × 330 mm) and Legal (8.5 × 14 inches [216 × 356 mm]): 10 sheets
Auto duplex scanning	Not supported

Parent topic: [Technical Specifications](#)

Scanning Specifications

Scanner type	Flatbed
Photoelectric device	CIS
Effective pixels	10200 × 14040 pixels at 1200 dpi
Document size	Maximum: 8.5 × 11.7 inches (216 × 297 mm) Scanner glass: US letter or A4
Scanning resolution	1200 dpi (main scan) 2400 dpi (sub scan)
Output resolution	50 to 9600 in 1 dpi increments

Image data	Color: 48 bits per pixel internal (16 bits per pixel per color internal) 24 bits per pixel external (8 bits per pixel per color external) Grayscale: 16 bits per pixel internal 8 bits per pixel external Black and white: 16 bits per pixel internal 1 bit per pixel external
Light source	LED

Parent topic: [Technical Specifications](#)

Fax Specifications

Fax type	Walk-up black-and-white and color fax capability (ITU-T Super Group 3)
Supported lines	Standard analog (household) telephone lines PBX (Private Branch Exchange) telephone systems
Speed	Up to 33.6 kbps
Compression method	Monochrome: MH/MR/MMR Color: JPEG
Communication standards	G3, SuperG3
Transmission speed	Approximately 3 seconds (A4 ITU-T chart No.1 standard MMR 33.6 kbps); actual speed depends on document, recipient's device, and phone line status

Resolution	<p>Monochrome</p> <p>Standard: 203 pixels per inch × 98 lines per inch (8 pixels per mm × 3.85 lines per mm)</p> <p>Fine: 203 pixels per inch × 196 lines per inch (8 pixels per mm × 7.7 lines per mm)</p> <p>Photo: 203 pixels per inch × 196 lines per inch (8 pixels per mm × 7.7 lines per mm)</p> <p>Color</p> <p>200 × 200 dpi</p>
Page memory	Up to 100 pages (ITU-T No. 1 chart received in monochrome standard mode)
Redial	2 times (with 1 minute intervals); specifications may differ by country or region
Interface	RJ-11 Phone Line RJ-11 Telephone set connection
Contacts Stored	Individual contacts: up to 100 Contact groups: up to 99

Parent topic: [Technical Specifications](#)

Ink Cartridge Specifications

Note: Your printer is designed to work only with genuine Epson-brand ink cartridges. Other brands of ink cartridges and ink supplies are not compatible and, even if described as compatible, may not function properly or at all. Epson periodically provides firmware updates to address issues of security, performance, minor bug fixes and ensure the printer functions as designed. These updates may affect the functionality of third-party ink. Non-Epson branded or altered Epson cartridges that functioned prior to a firmware update may not continue to function.

The included initial cartridges are designed for reliable printer setup and cannot be used as replacement cartridges or resold. After setup, the remaining ink is available for printing. Yields are based on ISO 24711 in default mode, printing continuously. Yields vary due to print images, settings, and temperatures. Printing infrequently or primarily with one color reduces yields. All cartridges must be installed with ink for printing and printer maintenance. For print quality, some ink remains in replaced cartridges.

Color	Black, Cyan, Magenta, Yellow
Cartridge life	Opened package: 6 months Unopened package: do not use if the date on the package has expired
Temperature	Storage: –22 to 104 °F (–30 to 40 °C) 1 month at 104 °F (40 °C) Ink freezes at 3.2 °F (–16 °C) Ink thaws and is usable after 3 hours at 77 °F (25 °C)

Note: For best printing results, use up a cartridge within 6 months of opening the package.

Parent topic: [Technical Specifications](#)

Related references

[Ink Cartridge and Maintenance Box Part Numbers](#)

Dimension Specifications

Height	Stored: 9.1 inches (231 mm) Printing: 10 inches (255 mm)
Width	Stored: 14.8 inches (375 mm) Printing: 16.4 inches (417 mm)
Depth	Stored: 13.7 inches (347 mm) Printing: 19.8 inches (503 mm)
Weight (without ink cartridges or power cord)	14.1 lb (6.4 kg)

Parent topic: [Technical Specifications](#)

Electrical Specifications

Power supply rating	100 to 240 V
----------------------------	--------------

Rated frequency range	50 to 60 Hz
Rated current	0.4 to 0.2 A
Power consumption (with USB connection)	Standalone copying: Approximately 12 W (ISO/IEC24712) Ready mode: Approximately 5.4 W Sleep mode: Approximately 1 W Power off mode: Approximately 0.2 W

Parent topic: [Technical Specifications](#)

Environmental Specifications

Temperature	Operating: 50 to 95 °F (10 to 35 °C) Storage (before initial ink charging): –4 to 104 °F (–20 to 40 °C) Storage (after initial ink charging): 5 to 104 °F (–15 to 40 °C) 1 month at 104 °F (40 °C)
Humidity (without condensation)	Operating: 20 to 80% RH Storage: 5 to 85% RH

Parent topic: [Technical Specifications](#)

Interface Specifications

Interface type	Hi-Speed USB (Device Class for computers; USB 3.0 cables are not supported)
-----------------------	---

Parent topic: [Technical Specifications](#)

Network Interface Specifications

Wi-Fi

Standards	IEEE 802.11 b/g/n; IEEE 802.11n available only on the 20 MHz channel
------------------	--

Securities	<p>WEP (64/128 bit)</p> <p>WPA2-PSK (AES); complies with WPA2 with support for WPA/WPA2 Personal</p> <p>WPA3-SAE (AES)</p>
Frequency range	<p>Note: Wi-Fi Direct supports WPA2-PSK (AES) only.</p> <p>2.4 GHz</p>
Communication mode	<p>Infrastructure mode</p> <p>Wi-Fi Direct (Simple AP); not supported for IEEE 802.11b</p> <p>Note: Simple AP mode is compatible with a Wi-Fi connection (infrastructure) or an Ethernet connection.</p>
Ethernet	
Standards	<p>IEEE802.3i (10BASE-T); use a category 5e or higher STP (Shielded Twisted Pair) cable to prevent risk of radio interference</p> <p>IEEE802.3u (100BASE-TX)</p> <p>IEEE802.3az (Energy Efficient Ethernet); connected device should be IEEE802.3az compliant</p>
Communication mode	<p>Auto, 10Mbps Full duplex, 10Mbps Half duplex, 100Mbps Full duplex, 100Mbps Half duplex</p>
Connector	<p>RJ-45</p>
Network Protocols (IPv4/IPv6)	
Network Printing	<p>IPv4: EpsonNet Print (Windows), Epson Email Print, Epson Remote Print</p> <p>IPv4/IPv6: Standard TCP/IP (Windows), WSD Printing (Windows), Bonjour Printing (Mac OS), IPP Printing (Windows/Mac OS), AirPrint (iOS/Mac OS)</p>
Network Scanning	<p>IPv4: Epson ScanSmart, Event Manager, Epson Scan to Cloud</p> <p>IPv4/IPv6: Epson Scan 2, AirPrint (Scan)</p>

Fax	IPv4: Send/receive fax IPv4/IPv6: AirPrint (Faxout)
Security	
Security protocols	SSL/TLS; HTTPS Server/Client, IPPS SNMPv3

Parent topic: [Technical Specifications](#)

Related references

[Wireless Network Connection is Unstable on a Mac](#)

Safety and Approvals Specifications

United States	Safety: UL62368-1 EMC: FCC part 15 Subpart B class B
Canada	Safety: CAN/CSA C22.2 No. 62368-1 EMC: CAN ICES-3 (B)/NMB-3 (B)

This equipment contains the following wireless module:

- Manufacturer: Seiko Epson Corporation
- Type: J26H006

This product conforms to Part 15 of FCC Rules and RSS-210 of the IC Rules. Epson cannot accept responsibility for any failure to satisfy the protection requirements resulting from a non-recommended modification of the product. Operation is subject to the following two conditions: (1) this device may not cause harmful interference, and (2) this device must accept any interference received, including interference that may cause undesired operation of the device.

To prevent radio interference to the licensed service, this device is intended to be operated indoors and away from windows to provide maximum shielding. Equipment (or its transmit antenna) that is installed outdoors is subject to licensing.

This equipment complies with FCC/IC radiation exposure limits set forth for an uncontrolled environment and meets the FCC radio frequency (RF) Exposure Guidelines in Supplement C to OET65 and RSS-102 of the IC radio frequency (RF) Exposure rules. This equipment should be installed and operated so that

the radiator is kept at least 7.9 inches (20 cm) or more away from a person's body (excluding extremities: hands, wrists, feet and ankles).

Parent topic: [Technical Specifications](#)

Notices

Check these sections for important notices about your product.

Note: Epson offers a recycling program for end of life Epson products. Please go to [this site](#) (U.S.) or [this site](#) (Canada) for information on how to return your Epson products for proper disposal.

[Important Safety Instructions](#)

[Important Privacy Notice \(Printer Serial Number\)](#)

[FCC Compliance Statement](#)

[Binding Arbitration and Class Waiver](#)

[Trademarks](#)

[Copyright Notice](#)

Important Safety Instructions

Before using your Epson product, read and follow these safety instructions.

[General Product Safety Instructions](#)

[LCD Screen Safety Instructions](#)

[Wireless Connection Safety Instructions](#)

[Telephone Equipment Safety Instructions](#)

Parent topic: [Notices](#)

General Product Safety Instructions

- Be sure to follow all warnings and instructions marked on the product.
- Use only the type of power source indicated on the product's label.
- Use only the power cord that comes with the product. Use of another cord may cause fires or shock. Do not use the cord with any other equipment.
- Make sure the AC power cord meets the relevant local safety standard.
- Place the product near a wall outlet where the plug can be easily unplugged.
- Avoid plugging the product into an outlet on the same circuit as a photo copier or air control system that regularly switches on and off, or on an outlet controlled by a wall switch or timer.

- Do not let the power cord become damaged or frayed. Place it to avoid abrasions, cuts, fraying, crimping, and kinking. Do not place objects on top of it and do not allow it to be stepped on or run over. Be careful to keep the cord straight at each end.
- If you use an extension cord with the product, make sure the total ampere rating of the devices plugged into the extension cord does not exceed the cord's ampere rating. Also, make sure the total ampere rating of all devices plugged into the wall outlet does not exceed the wall outlet's ampere rating.
- Always turn off the product using the power button, and wait until the power light stops flashing before unplugging the product or cutting off power to the electrical outlet.
- If you will not be using the product for a long period, unplug the power cord from the electrical outlet.
- Place the product on a flat, stable surface that extends beyond its base in all directions. It will not operate properly if it is tilted or at an angle.
- Allow space behind the product for the cables, and space above the product so that you can fully raise the document cover.
- Leave enough space in front of the product for the paper to be fully ejected.
- Avoid locations that are subject to rapid changes in heat or humidity, shocks or vibrations, or dust.
- Do not place or store the product outdoors.
- Do not place the product near excessive heat sources or in direct sunlight.
- Leave enough room around the product for sufficient ventilation. Do not block or cover openings in the case or insert objects through the slots.
- Keep the product away from potential sources of electromagnetic interference, such as loudspeakers or the base units of cordless telephones.
- Keep your product at least 8.7 inches (22 cm) away from cardiac pacemakers to prevent your product's radio waves from affecting the operation of the pacemaker.
- When connecting the product to a computer or other device with a cable, ensure the correct orientation of the connectors. Each connector has only one correct orientation. Inserting a connector in the wrong orientation may damage both devices connected by the cable.
- Do not sit or lean on the product. Do not place heavy objects on the product.
- Do not touch the flat white cable inside the product.
- Do not touch the translucent film inside the product.
- Do not move the print head by hand; this may damage the product.
- Do not put your hand inside the product while it is printing.

- Do not spill liquid on the product or use the product with wet hands.
- Do not use aerosol products that contain flammable gases inside or around the product. Doing so may cause fire.
- Do not press too hard on the scanner glass when placing originals.
- Do not open the scanner section while the product is copying, printing, scanning, or performing any other functions.
- Be careful not to trap your fingers when closing the scanner unit.
- Except as specifically explained in your documentation, do not attempt to service or disassemble the product yourself.
- Unplug the product and refer servicing to qualified service personnel under the following conditions: if the power cord or plug is damaged; if liquid has entered the product; if the product has been dropped or the case damaged; if the product does not operate normally or exhibits a distinct change in performance. Adjust only those controls that are covered by the operating instructions.
- Leave the ink cartridges installed. Removing the cartridges can dehydrate the print head and may prevent the product from printing.
- Before transporting the product, make sure that the print head is in the home (far right) position and the ink cartridges are in place.
- Before transporting the product, make sure that the print head is in the home (far right) position.
- When storing or transporting the product, do not tilt it, stand it on its side, or turn it upside down; otherwise, ink may leak.

Parent topic: [Important Safety Instructions](#)

LCD Screen Safety Instructions

- Use only a dry, soft cloth to clean the LCD screen. Do not use liquid or chemical cleansers.
- If the LCD screen is damaged, contact Epson. If the liquid crystal solution gets on your hands, wash them thoroughly with soap and water. If the liquid crystal solution gets into your eyes, flush them immediately with water. If discomfort or vision problems remain after a thorough flushing, see a doctor immediately.
- Do not press too hard on the LCD screen or subject it to heavy impacts.
- Do not use a pointy or sharp object, such as a pen or your fingernail, to operate the LCD screen.
- If the LCD screen chips or cracks, do not touch or attempt to remove the broken pieces; contact Epson for support.

- Do not subject your product to sudden changes in temperature or humidity; this may cause condensation to develop inside the LCD screen and degrade its performance.
- The LCD screen may contain a few small bright or dark spots, and may display uneven brightness. These are normal and do not indicate that the screen is damaged in any way.

Parent topic: [Important Safety Instructions](#)

Wireless Connection Safety Instructions

Radio waves from this product may adversely affect the operation of medical equipment or automatically controlled devices, such as pacemakers, automatic doors or fire alarms. When using this product near such devices or inside a medical facility, follow the directions from authorized staff members at the facility, and follow all posted warnings and directions on the device to avoid causing an accident.

Parent topic: [Important Safety Instructions](#)

Telephone Equipment Safety Instructions

When using telephone equipment, you should always follow basic safety precautions to reduce the risk of fire, electric shock, and personal injury, including the following:

- Do not use the Epson product near water.
- Avoid using a telephone during an electrical storm. There may be a remote risk of electric shock from lightning.
- Do not use a telephone to report a gas leak in the vicinity of the leak.

Caution: To reduce the risk of fire, use only a No. 26 AWG or larger telecommunication line cord.

Parent topic: [Important Safety Instructions](#)

Important Privacy Notice (Printer Serial Number)

As part of setup, your product's serial number will be sent to a secure Epson server so that you can be eligible to participate in programs we may offer from time to time, including the Epson ink replenishment program. You will have a separate opportunity to consent to participating in such programs.

If you have any questions concerning this process, you can contact us by using the [Privacy Feedback Form](#), or you can write to:

Epson America, Inc.

Attn: Privacy Coordinator

3131 Katella Avenue

Los Alamitos, CA 90720

Parent topic: [Notices](#)

FCC Compliance Statement

For United States Users

This equipment complies with Part 68 of the FCC rules and the requirements adopted by the Administrative Council for Terminal Attachments ("ACTA"). On the surface of this equipment is a label that contains, among other information, a product identifier in the format US:AAAEQ##TXXXX. If requested, this number must be provided to the telephone company.

Applicable certification jack Universal Service Order Codes ("USOC") for the equipment: RJ11C.

A plug and jack used to connect this equipment to the premises wiring and telephone network must comply with the applicable FCC Part 68 rules and requirements adopted by the ACTA. A compliant telephone cord and modular plug is provided with this product. It is designed to be connected to a compatible modular jack that is also compliant. See installation instructions for details.

The REN is used to determine the number of devices that may be connected to a telephone line. Excessive RENs on a telephone line may result in the devices not ringing in response to an incoming call. In most but not all areas, the sum of RENs should not exceed five (5.0). To be certain of the number of devices that may be connected to a line, as determined by the total RENs, contact the local telephone company. For products approved after July 23, 2001, the REN for this product is part of the product identifier that has the format US:AAAEQ##TXXXX. The digits represented by ## are the REN without a decimal point (e.g., 03 is a REN of 0.3). For earlier products, the REN is separately shown on the label.

If this equipment causes harm to the telephone network, the telephone company will notify you in advance that temporary discontinuance of service may be required. But if advance notice isn't practical, the telephone company will notify the customer as soon as possible. Also, you will be advised of your right to file a complaint with the FCC if you believe it is necessary.

The telephone company may make changes in its facilities, equipment, operations, or procedures that could affect the operation of the equipment. If this happens the telephone company will provide advance notice in order for you to make necessary modifications to maintain uninterrupted service.

If you have problems with this product and require technical or customer support, please visit www.epson.com for more information.

This product is not intended to be repaired by the customer. If you experience trouble connecting this equipment to a telephone line, please contact:

Name: Epson America, Inc.

Address: 3131 Katella Ave., Los Alamitos, CA 90720 U.S.A.

Telephone: (562) 981-3840

If the equipment is causing harm to the telephone network, the telephone company may request that you disconnect the equipment until the problem is resolved.

This equipment may not be used on coin service provided by the telephone company. Connection to party line service is subject to state tariffs. Contact the state public utility commission, public service commission or corporation commission for information.

If your home has specially wired alarm equipment connected to the telephone line, ensure the installation of this equipment does not disable your alarm equipment. If you have questions about what will disable alarm equipment, consult your telephone company or a qualified installer.

The Telephone Consumer Protection Act of 1991 makes it unlawful for any person to use a computer or other electronic device, including fax machines, to send any message unless such message clearly contains in a margin at the top or bottom of each transmitted page or on the first page of the transmission, the date and time it is sent and an identification of the business or other entity, or other individual sending the message and the telephone number of the sending machine or such business, other entity, or individual. (The telephone number provided may not be a 900 number or any other number for which charges exceed local or long-distance transmission charges.)

In order to program this information into your fax machine, click the link below for instructions on entering fax header information.

According to the FCC's electrical safety advisory, we recommend that you may install an AC surge arrester in the AC outlet to which this equipment is connected. Telephone companies report that electrical surges, typically lightning transients, are very destructive to customer terminal equipment connected to AC power sources and that this is a major nationwide problem.

This equipment has been tested and found to comply with the limits for a Class B digital device, pursuant to Part 15 of the FCC Rules. These limits are designed to provide reasonable protection against harmful interference in a residential installation. This equipment generates, uses, and can radiate radio frequency energy and, if not installed and used in accordance with the instructions, may cause harmful interference to radio or television reception. However, there is no guarantee that interference will not occur in a particular installation. If this equipment does cause interference to radio and television reception, which can be determined by turning the equipment off and on, the user is encouraged to try to correct the interference by one or more of the following measures:

- Reorient or relocate the receiving antenna.
- Increase the separation between the equipment and receiver.
- Connect the equipment into an outlet on a circuit different from that to which the receiver is connected.
- Consult the dealer or an experienced radio/TV technician for help.

WARNING

The connection of a non-shielded equipment interface cable to this equipment will invalidate the FCC Certification or Declaration of this device and may cause interference levels which exceed the limits established by the FCC for this equipment. It is the responsibility of the user to obtain and use a shielded equipment interface cable with this device. If this equipment has more than one interface connector, do not leave cables connected to unused interfaces. Changes or modifications not expressly approved by the manufacturer could void the user's authority to operate the equipment.

For Canadian Users

1. This product meets the applicable Innovation, Science and Economic Development Canada technical specifications.
2. The Ringer Equivalence Number indicates the maximum number of devices allowed to be connected to a telephone interface. The termination of an interface may consist of any combination of devices subject only to the requirement that the sum of the RENs of all the devices does not exceed five.

CAN ICES-3(B)/NMB-3(B)

Le présent produit est conforme aux spécifications techniques applicables d'Innovation, Sciences et Développement économique Canada.

L'indice d'équivalence de la sonnerie (IES) sert à indiquer le nombre maximal de dispositifs qui peuvent être raccordés à une interface téléphonique. La terminaison d'une interface peut consister en une combinaison quelconque de dispositifs, à la seule condition que la somme des IES de tous les dispositifs n'excède pas cinq.

CAN ICES-3(B)/NMB-3(B)

Parent topic: [Notices](#)

Related tasks

[Using the Fax Setup Wizard](#)

Binding Arbitration and Class Waiver

1. DISPUTES, BINDING INDIVIDUAL ARBITRATION, AND WAIVER OF CLASS ACTIONS AND CLASS ARBITRATIONS

1.1 Disputes. The terms of this Section 1 shall apply to all Disputes between you and Epson. The term "Dispute" is meant to have the broadest meaning permissible under law and includes any dispute, claim, controversy or action between you and Epson arising out of or relating to this Agreement, Epson branded products (hardware and including any related software), or other transaction involving you and Epson, whether in contract, warranty, misrepresentation, fraud, tort, intentional tort, statute, regulation, ordinance, or any other legal or equitable basis. "DISPUTE" DOES NOT INCLUDE IP CLAIMS, or more

specifically, a claim or cause of action for (a) trademark infringement or dilution, (b) patent infringement, (c) copyright infringement or misuse, or (d) trade secret misappropriation (an "IP Claim"). You and Epson also agree, notwithstanding Section 1.6, that a court, not an arbitrator, may decide if a claim or cause of action is for an IP Claim.

1.2 Binding Arbitration. You and Epson agree that all Disputes shall be resolved by binding arbitration according to this Agreement. **ARBITRATION MEANS THAT YOU WAIVE YOUR RIGHT TO A JUDGE OR JURY IN A COURT PROCEEDING AND YOUR GROUNDS FOR APPEAL ARE LIMITED.**

Pursuant to this Agreement, binding arbitration shall be administered by JAMS, a nationally recognized arbitration authority, pursuant to its code of procedures then in effect for consumer related disputes, but excluding any rules that permit joinder or class actions in arbitration (for more detail on procedure, see Section 1.6 below). You and Epson understand and agree that (a) the Federal Arbitration Act (9 U.S.C. §1, et seq.) governs the interpretation and enforcement of this Section 1, (b) this Agreement memorializes a transaction in interstate commerce, and (c) this Section 1 shall survive termination of this Agreement.

1.3 Pre-Arbitration Steps and Notice. Before submitting a claim for arbitration, you and Epson agree to try, for sixty (60) days, to resolve any Dispute informally. If Epson and you do not reach an agreement to resolve the Dispute within the sixty (60) days, you or Epson may commence an arbitration. Notice to Epson must be addressed to: Epson America, Inc., ATTN: Legal Department, 3131 Katella Ave., Los Alamitos, CA 90720 (the "Epson Address"). The Dispute Notice to you will be sent to the most recent address Epson has in its records for you. For this reason, it is important to notify us if your address changes by emailing us at EAILEgal@ea.epson.com or writing us at the Epson Address above. Notice of the Dispute shall include the sender's name, address and contact information, the facts giving rise to the Dispute, and the relief requested (the "Dispute Notice"). Following receipt of the Dispute Notice, Epson and you agree to act in good faith to resolve the Dispute before commencing arbitration.

1.4 Small Claims Court. Notwithstanding the foregoing, you may bring an individual action in the small claims court of your state or municipality if the action is within that court's jurisdiction and is pending only in that court.

1.5 WAIVER OF CLASS ACTIONS AND CLASS ARBITRATIONS. YOU AND EPSON AGREE THAT EACH PARTY MAY BRING DISPUTES AGAINST THE OTHER PARTY ONLY IN AN INDIVIDUAL CAPACITY, AND NOT AS A PLAINTIFF OR CLASS MEMBER IN ANY CLASS OR REPRESENTATIVE PROCEEDING, INCLUDING WITHOUT LIMITATION FEDERAL OR STATE CLASS ACTIONS, OR CLASS ARBITRATIONS. CLASS ACTION LAWSUITS, CLASS-WIDE ARBITRATIONS, PRIVATE ATTORNEY-GENERAL ACTIONS, AND ANY OTHER PROCEEDING WHERE SOMEONE ACTS IN A REPRESENTATIVE CAPACITY ARE NOT ALLOWED. ACCORDINGLY, UNDER THE ARBITRATION PROCEDURES OUTLINED IN THIS SECTION, AN ARBITRATOR SHALL NOT COMBINE OR CONSOLIDATE MORE THAN ONE PARTY'S CLAIMS WITHOUT THE WRITTEN CONSENT OF ALL AFFECTED PARTIES TO AN ARBITRATION PROCEEDING.

1.6 Arbitration Procedure. If you or Epson commences arbitration, the arbitration shall be governed by the rules of JAMS that are in effect when the arbitration is filed, excluding any rules that permit arbitration on a class or representative basis (the "JAMS Rules"), available at <http://www.jamsadr.com> or by calling 1-800-352-5267, and under the rules set forth in this Agreement. All Disputes shall be resolved by a single neutral arbitrator, and both parties shall have a reasonable opportunity to participate in the selection of the arbitrator. The arbitrator is bound by the terms of this Agreement. The arbitrator, and not any federal, state or local court or agency, shall have exclusive authority to resolve all disputes arising out of or relating to the interpretation, applicability, enforceability or formation of this Agreement, including any claim that all or any part of this Agreement is void or voidable. Notwithstanding this broad delegation of authority to the arbitrator, a court may determine the limited question of whether a claim or cause of action is for an IP Claim, which is excluded from the definition of "Disputes" in Section 1.1 above. The arbitrator shall be empowered to grant whatever relief would be available in a court under law or in equity. The arbitrator may award you the same damages as a court could, and may award declaratory or injunctive relief only in favor of the individual party seeking relief and only to the extent necessary to provide relief warranted by that party's individual claim. In some instances, the costs of arbitration can exceed the costs of litigation and the right to discovery may be more limited in arbitration than in court. The arbitrator's award is binding and may be entered as a judgment in any court of competent jurisdiction.

You may choose to engage in arbitration hearings by telephone. Arbitration hearings not conducted by telephone shall take place in a location reasonably accessible from your primary residence, or in Orange County, California, at your option.

a) Initiation of Arbitration Proceeding. If either you or Epson decides to arbitrate a Dispute, both parties agree to the following procedure:

(i) Write a Demand for Arbitration. The demand must include a description of the Dispute and the amount of damages sought to be recovered. You can find a copy of a Demand for Arbitration at <http://www.jamsadr.com> ("Demand for Arbitration").

(ii) Send three copies of the Demand for Arbitration, plus the appropriate filing fee, to: JAMS, 500 North State College Blvd., Suite 600 Orange, CA 92868, U.S.A.

(iii) Send one copy of the Demand for Arbitration to the other party (same address as the Dispute Notice), or as otherwise agreed by the parties.

b) Hearing Format. During the arbitration, the amount of any settlement offer made shall not be disclosed to the arbitrator until after the arbitrator determines the amount, if any, to which you or Epson is entitled. The discovery or exchange of non-privileged information relevant to the Dispute may be allowed during the arbitration.

c) Arbitration Fees. Epson shall pay, or (if applicable) reimburse you for, all JAMS filings and arbitrator fees for any arbitration commenced (by you or Epson) pursuant to provisions of this Agreement.

d) Award in Your Favor. For Disputes in which you or Epson seeks \$75,000 or less in damages exclusive of attorney's fees and costs, if the arbitrator's decision results in an award to you in an amount greater than Epson's last written offer, if any, to settle the Dispute, Epson will: (i) pay you \$1,000 or the amount of the award, whichever is greater; (ii) pay you twice the amount of your reasonable attorney's fees, if any; and (iii) reimburse you for any expenses (including expert witness fees and costs) that your attorney reasonably accrues for investigating, preparing, and pursuing the Dispute in arbitration. Except as agreed upon by you and Epson in writing, the arbitrator shall determine the amount of fees, costs, and expenses to be paid by Epson pursuant to this Section 1.6d).

e) Attorney's Fees. Epson will not seek its attorney's fees and expenses for any arbitration commenced involving a Dispute under this Agreement. Your right to attorney's fees and expenses under Section 1.6d) above does not limit your rights to attorney's fees and expenses under applicable law; notwithstanding the foregoing, the arbitrator may not award duplicative awards of attorney's fees and expenses.

1.7 Opt-out. You may elect to opt-out (exclude yourself) from the final, binding, individual arbitration procedure and waiver of class and representative proceedings specified in this Agreement by sending a written letter to the Epson Address within thirty (30) days of your assent to this Agreement (including without limitation the purchase, download, installation of the Software or other applicable use of Epson Hardware, products and services) that specifies (i) your name, (ii) your mailing address, and (iii) your request to be excluded from the final, binding individual arbitration procedure and waiver of class and representative proceedings specified in this Section 1. In the event that you opt-out consistent with the procedure set forth above, all other terms shall continue to apply, including the requirement to provide notice prior to litigation.

1.8 Amendments to Section 1. Notwithstanding any provision in this Agreement to the contrary, you and Epson agree that if Epson makes any future amendments to the dispute resolution procedure and class action waiver provisions (other than a change to Epson's address) in this Agreement, Epson will obtain your affirmative assent to the applicable amendment. If you do not affirmatively assent to the applicable amendment, you are agreeing that you will arbitrate any Dispute between the parties in accordance with the language of this Section 1 (or resolve disputes as provided for in Section 1.7, if you timely elected to opt-out when you first assented to this Agreement).

1.9 Severability. If any provision in this Section 1 is found to be unenforceable, that provision shall be severed with the remainder of this Agreement remaining in full force and effect. **The foregoing shall not apply to the prohibition against class or representative actions as provided in Section 1.5. This means that if Section 1.5 is found to be unenforceable, the entire Section 1 (but only Section 1) shall be null and void.**

Parent topic: [Notices](#)

Trademarks

EPSON® and Epson ScanSmart are registered trademarks, EPSON Exceed Your Vision is a registered logomark, and Epson Connect™ and Remote Print™ are trademarks of Seiko Epson Corporation.

Windows is a registered trademark of Microsoft Corporation in the United States and/or other countries.

Mac, macOS, OS X, ColorSync, AirPrint, iPad, iPhone, iPod touch, and Siri are trademarks of Apple Inc., registered in the U.S. and other countries.

Use of the Works with Apple badge means that an accessory has been designed to work specifically with the technology identified in the badge and has been certified by the developer to meet Apple performance standards.

Amazon™ and Alexa™ are trademarks of Amazon.com, Inc. or its affiliates.

Google® is a registered trademark and Android™, Chromebook™, Gmail™, Google Drive™, and Google Play™ are trademarks of Google LLC.

Wi-Fi Direct® is a registered trademark of Wi-Fi Alliance®.

General Notice: Other product names used herein are for identification purposes only and may be trademarks of their respective owners. Epson disclaims any and all rights in those marks.



Parent topic: [Notices](#)

Copyright Notice

All rights reserved. No part of this publication may be reproduced, stored in a retrieval system, or transmitted in any form or by any means, electronic, mechanical, photocopying, recording, or otherwise, without the prior written permission of Seiko Epson Corporation. The information contained herein is designed only for use with this Epson product. Epson is not responsible for any use of this information as applied to other products.

Neither Seiko Epson Corporation nor its affiliates shall be liable to the purchaser of this product or third parties for damages, losses, costs, or expenses incurred by purchaser or third parties as a result of: accident, misuse, or abuse of this product or unauthorized modifications, repairs, or alterations to this product, or (excluding the U.S.) failure to strictly comply with Seiko Epson Corporation's operating and maintenance instructions.

Seiko Epson Corporation shall not be liable for any damages or problems arising from the use of any options or any consumable products other than those designated as Original Epson Products or Epson Approved Products by Seiko Epson Corporation.

Seiko Epson Corporation shall not be held liable for any damage resulting from electromagnetic interference that occurs from the use of any interface cables other than those designated as Epson approved Products by Seiko Epson Corporation.

This information is subject to change without notice.

[libTIFF Software Acknowledgment](#)

[A Note Concerning Responsible Use of Copyrighted Materials](#)

[Default Delay Times for Power Management for Epson Products](#)

[Copyright Attribution](#)

Parent topic: [Notices](#)

libTIFF Software Acknowledgment

Copyright © 1988-1997 Sam Leffler

Copyright © 1991-1997 Silicon Graphics, Inc.

Permission to use, copy, modify, distribute, and sell this software and its documentation for any purpose is hereby granted without fee, provided that (i) the above copyright notices and this permission notice appear in all copies of the software and related documentation, and (ii) the names of Sam Leffler and Silicon Graphics may not be used in any advertising or publicity relating to the software without the specific, prior written permission of Sam Leffler and Silicon Graphics.

THE SOFTWARE IS PROVIDED "AS-IS" AND WITHOUT WARRANTY OF ANY KIND, EXPRESS, IMPLIED OR OTHERWISE, INCLUDING WITHOUT LIMITATION, ANY WARRANTY OF MERCHANTABILITY OR FITNESS FOR A PARTICULAR PURPOSE.

IN NO EVENT SHALL SAM LEFFLER OR SILICON GRAPHICS BE LIABLE FOR ANY SPECIAL, INCIDENTAL, INDIRECT OR CONSEQUENTIAL DAMAGES OF ANY KIND, OR ANY DAMAGES WHATSOEVER RESULTING FROM LOSS OF USE, DATA OR PROFITS, WHETHER OR NOT ADVISED OF THE POSSIBILITY OF DAMAGE, AND ON ANY THEORY OF LIABILITY, ARISING OUT OF OR IN CONNECTION WITH THE USE OR PERFORMANCE OF THIS SOFTWARE.

Parent topic: [Copyright Notice](#)

A Note Concerning Responsible Use of Copyrighted Materials

Epson encourages each user to be responsible and respectful of the copyright laws when using any Epson product. While some countries' laws permit limited copying or reuse of copyrighted material in

certain circumstances, those circumstances may not be as broad as some people assume. Contact your legal advisor for any questions regarding copyright law.

Parent topic: [Copyright Notice](#)

Default Delay Times for Power Management for Epson Products

This product will enter sleep mode after a period of nonuse. This is to ensure that the product meets Energy Star standards of energy efficiency. More energy savings can be achieved by setting the time to sleep to a shorter interval.

Parent topic: [Copyright Notice](#)

Copyright Attribution

© 2022 Epson America, Inc.

8/22

CPD-62114

Parent topic: [Copyright Notice](#)