



Questo manuale d'istruzione è fornito da [trovaprezzi.it](https://trovaprezzi.it). Scopri tutte le offerte per [Extreme AP305CX-WR](#) o cerca il tuo prodotto tra le [migliori offerte di Altri dispositivi di rete](#)



Questo manuale d'istruzione è fornito da [trovaprezzi.it](https://trovaprezzi.it). Scopri tutte le offerte per [Extreme AP305CX-WR](#) o cerca il tuo prodotto tra le [migliori offerte di Altri dispositivi di rete](#)



# ExtremeWireless™ AP305C/CX Access Points

## Installation Guide

9036889-02 Rev AA  
December 2021



Copyright © 2021 Extreme Networks, Inc. All rights reserved.

## Legal Notice

Extreme Networks, Inc. reserves the right to make changes in specifications and other information contained in this document and its website without prior notice. The reader should in all cases consult representatives of Extreme Networks to determine whether any such changes have been made.

The hardware, firmware, software or any specifications described or referred to in this document are subject to change without notice.

## Trademarks

Extreme Networks and the Extreme Networks logo are trademarks or registered trademarks of Extreme Networks, Inc. in the United States and/or other countries.

All other names (including any product names) mentioned in this document are the property of their respective owners and may be trademarks or registered trademarks of their respective companies/owners.

For additional information on Extreme Networks trademarks, see: [www.extremenetworks.com/company/legal/trademarks](http://www.extremenetworks.com/company/legal/trademarks)

## Open Source Declarations

Some software files have been licensed under certain open source or third-party licenses. End-user license agreements and open source declarations can be found at: <https://www.extremenetworks.com/support/policies/open-source-declaration/>

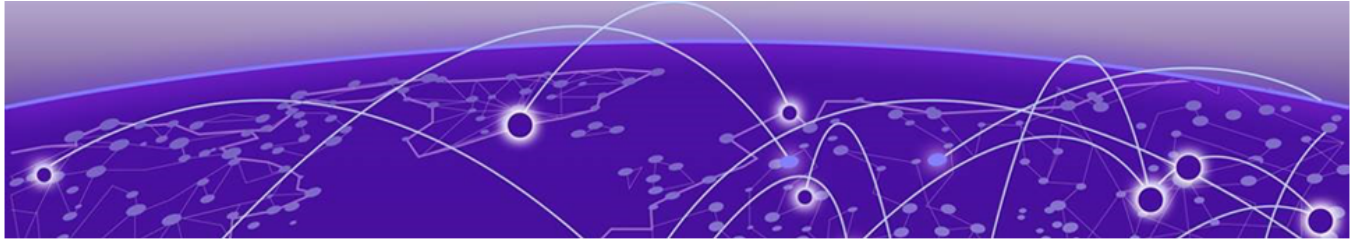

# Table of Contents

---

<b>Preface.....</b>	<b>4</b>
Text Conventions.....	4
Documentation and Training.....	5
Help and Support.....	6
Subscribe to Product Announcements.....	6
Send Feedback.....	6
<b>AP305C/CX Overview.....</b>	<b>8</b>
Update the Country Code.....	8
AP305C/CX Features.....	9
Hardware components.....	10
Micro USB console port.....	11
Device physical specifications, radio specifications, and power tables.....	12
Power Profile.....	12
Status LED Activity Description.....	13
<b>Install the Access Point.....</b>	<b>14</b>
Box Contents.....	14
Install the Access Point on a Standard Ceiling Rail.....	15
Non-Standard Ceiling Grid or Wall Installation.....	16
Lock the Access Point after Installation.....	19
<b>External Antenna Configuration Information.....</b>	<b>20</b>
Antenna gain.....	20
External antenna information.....	20
<b>Regulatory and Compliance Information.....</b>	<b>22</b>
Safety Guidelines.....	22
Japan Indoor Use Statement.....	22
Japan Voluntary Control Council for Interference (VCCI) - Class B.....	23
Declaration of Conformity in Languages of the European Community.....	23
Conformité Européenne (CE) Information.....	25
CE Marking and European Area (EEA).....	25
Brazil Agência Nacional De Telecomunicações (Anatel) Statement.....	25
Mexico Compliance Statement.....	26
Industry Canada Statement.....	26
Taiwan Regulatory Statement.....	27
Taiwan Maximum Permissible Exposure (MPE) warning.....	27
NCC Statement.....	28
European Waste Electrical and Electronic Equipment (WEEE) Notice.....	28
Supplement to Product Instructions.....	29
<b>Index.....</b>	<b>30</b>

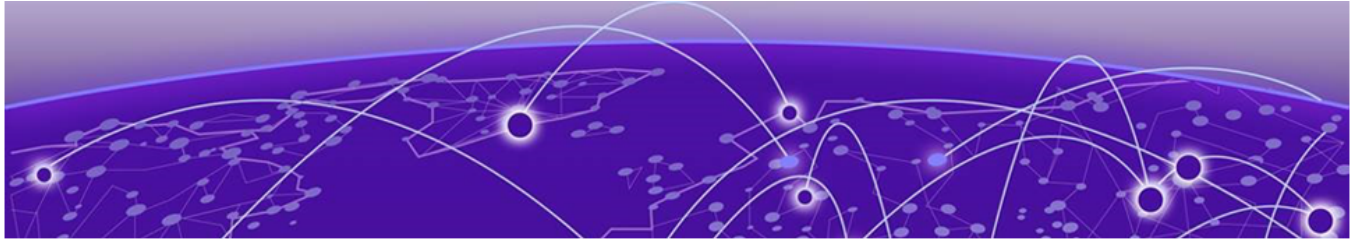

# Preface

---

Read the following topics to learn about:

- The meanings of text formats used in this document.
- Where you can find additional information and help.
- How to reach us with questions and comments.





## Text Conventions

---

Unless otherwise noted, information in this document applies to all supported environments for the products in question. Exceptions, like command keywords associated with a specific software version, are identified in the text.

When a feature, function, or operation pertains to a specific hardware product, the product name is used. When features, functions, and operations are the same across an entire product family, such as ExtremeSwitching switches or SLX routers, the product is referred to as *the switch* or *the router*.

**Table 1: Notes and warnings**

Icon	Notice type	Alerts you to...
	Tip	Helpful tips and notices for using the product
	Note	Useful information or instructions
	Important	Important features or instructions
	Caution	Risk of personal injury, system damage, or loss of data
	Warning	Risk of severe personal injury

**Table 2: Text**

Convention	Description
screen displays	This typeface indicates command syntax, or represents information as it is displayed on the screen.
The words <i>enter</i> and <i>type</i>	When you see the word <i>enter</i> in this guide, you must type something, and then press the Return or Enter key. Do not press the Return or Enter key when an instruction simply says <i>type</i> .
<b>Key</b> names	Key names are written in boldface, for example <b>Ctrl</b> or <b>Esc</b> . If you must press two or more keys simultaneously, the key names are linked with a plus sign (+). Example: Press <b>Ctrl+Alt+Del</b>
Words in italicized type	Italics emphasize a point or denote new terms at the place where they are defined in the text. Italics are also used when referring to publication titles.
<b>NEW!</b>	New information. In a PDF, this is searchable text.

**Table 3: Command syntax**

Convention	Description
<b>bold</b> text	Bold text indicates command names, keywords, and command options.
<i>italic</i> text	Italic text indicates variable content.
[ ]	Syntax components displayed within square brackets are optional. Default responses to system prompts are enclosed in square brackets.
{ <b>x</b>   <b>y</b>   <b>z</b> }	A choice of required parameters is enclosed in curly brackets separated by vertical bars. You must select one of the options.
<b>x</b>   <b>y</b>	A vertical bar separates mutually exclusive elements.
< >	Nonprinting characters, such as passwords, are enclosed in angle brackets.
...	Repeat the previous element, for example, <i>member</i> [ <i>member</i> ...].
\	In command examples, the backslash indicates a “soft” line break. When a backslash separates two lines of a command input, enter the entire command at the prompt without the backslash.

## Documentation and Training

Find Extreme Networks product information at the following locations:

[Current Product Documentation](#)

[Release Notes](#)

[Hardware and software compatibility](#) for Extreme Networks products

[Extreme Optics Compatibility](#)

[Other resources](#) such as white papers, data sheets, and case studies

Extreme Networks offers product training courses, both online and in person, as well as specialized certifications. For details, visit [www.extremenetworks.com/education/](http://www.extremenetworks.com/education/).

---

## Help and Support

---

If you require assistance, contact Extreme Networks using one of the following methods:

### Extreme Portal

Search the GTAC (Global Technical Assistance Center) knowledge base; manage support cases and service contracts; download software; and obtain product licensing, training, and certifications.

### The Hub

A forum for Extreme Networks customers to connect with one another, answer questions, and share ideas and feedback. This community is monitored by Extreme Networks employees, but is not intended to replace specific guidance from GTAC.

### Call GTAC

For immediate support: (800) 998 2408 (toll-free in U.S. and Canada) or 1 (408) 579 2826. For the support phone number in your country, visit: [www.extremenetworks.com/support/contact](http://www.extremenetworks.com/support/contact)

Before contacting Extreme Networks for technical support, have the following information ready:

- Your Extreme Networks service contract number, or serial numbers for all involved Extreme Networks products
- A description of the failure
- A description of any actions already taken to resolve the problem
- A description of your network environment (such as layout, cable type, other relevant environmental information)
- Network load at the time of trouble (if known)
- The device history (for example, if you have returned the device before, or if this is a recurring problem)
- Any related RMA (Return Material Authorization) numbers

## Subscribe to Product Announcements

You can subscribe to email notifications for product and software release announcements, Field Notices, and Vulnerability Notices.

1. Go to [The Hub](#).
2. In the list of categories, expand the **Product Announcements** list.
3. Select a product for which you would like to receive notifications.
4. Select **Subscribe**.
5. To select additional products, return to the **Product Announcements** list and repeat steps 3 and 4.

You can modify your product selections or unsubscribe at any time.

---

## Send Feedback

---

The Information Development team at Extreme Networks has made every effort to ensure that this document is accurate, complete, and easy to use. We strive to improve our documentation to help you in your work, so we want to hear from you. We welcome all feedback, but we especially want to know about:

- Content errors, or confusing or conflicting information.

- Improvements that would help you find relevant information.
- Broken links or usability issues.

To send feedback, do either of the following:

- Access the feedback form at <https://www.extremenetworks.com/documentation-feedback/>.
- Email us at [documentation@extremenetworks.com](mailto:documentation@extremenetworks.com).

Provide the publication title, part number, and as much detail as possible, including the topic heading and page number if applicable, as well as your suggestions for improvement.

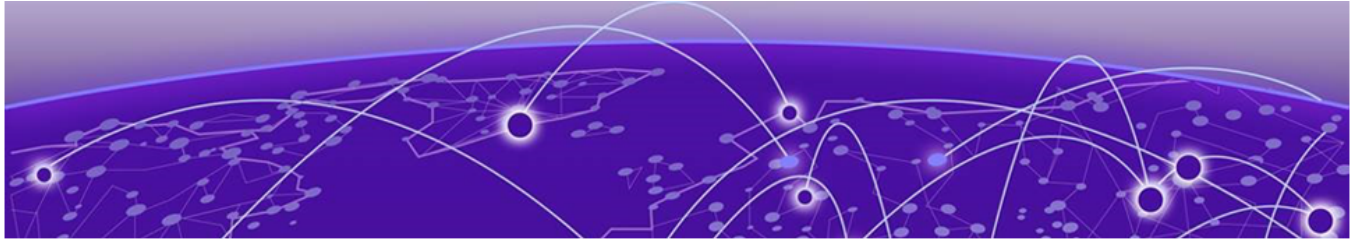

# AP305C/CX Overview

---

[Update the Country Code on page 8](#)

[AP305C/CX Features on page 9](#)

[Power Profile on page 12](#)

[Status LED Activity Description on page 13](#)

Learn about AP305C/CX access point features, power profile, power source, and status light activity.

The AP305C/CX access points are high-performance 802.11ax dual-5G, dual-band access points.

Both the access points are designed for high-density indoor environments that require high definition (HD) video streaming and large file transfers. The AP305CX access point has external antennas, that are sold separately.

The access points support IEEE 802.11ax Orthogonal Frequency- Division Multiple Access (OFDMA) multi-user access.

## Update the Country Code

---

Learn how to update the country code on the access point.

If your access point is configured for the World Regulatory (WR) domain, set the country code to the country in which the access point will be deployed to meet regulatory requirements and for optimal wireless operation.



### Note

The country code selection is for WR models only and is not available to FCC, CAN, and other country-specific models. Per Federal Communications Commission (FCC) regulations, all Wi-Fi products marketed in the United States must be set to U.S. channels only.

1. Power on the access point and wait for it to find and connect to ExtremeCloud IQ.

After the access point is connected, it is displayed in the table of devices on the **Manage > Devices** page.

2. Select the check box next to the access point, and then choose **Assign Country Code** from the Actions drop-down list.

In the dialog box, select the appropriate country from the drop-down list, and then select **Save**.

3. Upload your changes to the access point.

## AP305C/CX Features

---

The access points have the following features:

- Radios – two built-in dual-band radios
- Kensington® lock
- ETH0 Ethernet port – autosensing 10/100/1000G BASE-T/TX Mbps, with IEEE 802.3af or 802.3at compliant Power over Ethernet (PoE), and requires a Cat5 cable
- Antennas:
  - AP305C – four internal omnidirectional 2.4 GHz/5 GHz dual-band antennas
  - AP305CX – four external omnidirectional 2.4 GHz/5 GHz dual-band antennas

One dual-band antenna is shared between Wi-Fi and Bluetooth Low Energy (BLE)

- Power source – 802.3af and 802.3at power over Ethernet injector
- Trusted Module Platform (TPM) chip for added security
- Operating temperature: +0 °C to +40 °C (+32 °F to +104 °F)
- Storage temperature: –40 °C to +80 °C (–40 °F to +176 °F)

## Hardware components

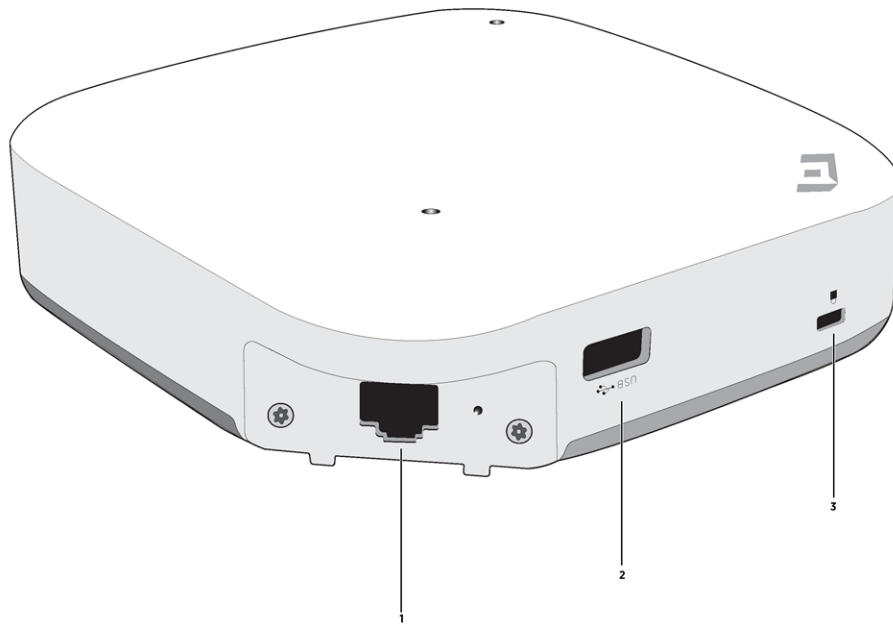
**Figure 1: AP305C access point hardware components****Table 4: AP305C hardware component description**

Callout	Description
1	ETH0 port
2	USB port
3	Security slot

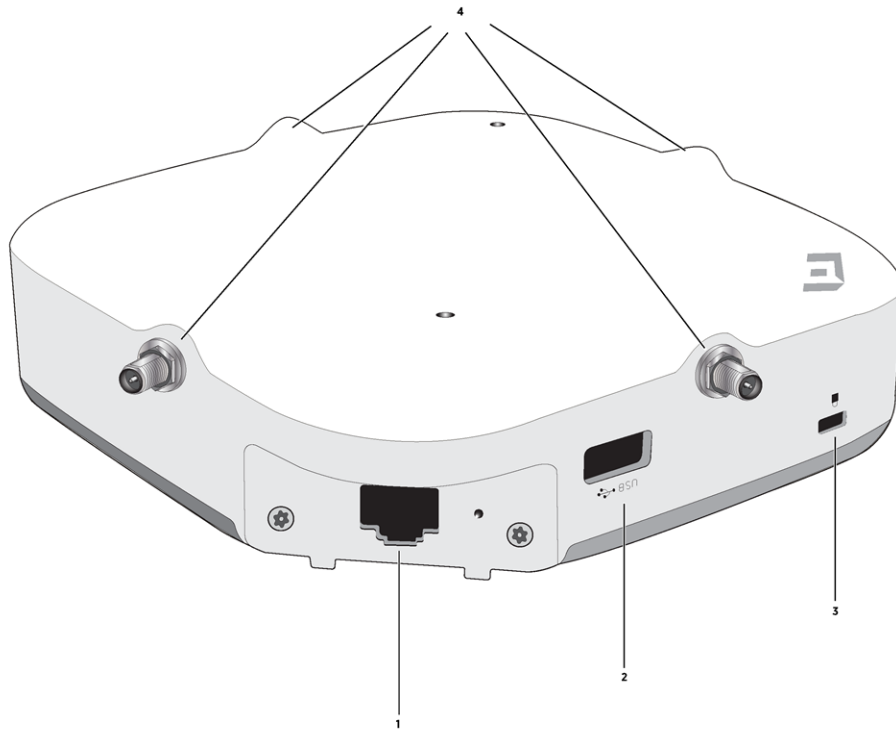

**Figure 2: AP305CX access point hardware components**

**Table 5: AP305CX hardware component description**

Callout	Description
1	ETH0 port
2	USB port
3	Security slot
4	External antenna connectors

## Micro USB console port

The console port is located at the bottom of the access point. Through the console port, you can make a serial connection between your management system and the access point.

The orderable part number for the micro USB console adapter is ACC-WIFI-MICRO-USB.



### Note

When you connect to the device using the micro USB console port, the management station from which you connect to the device must have a VT100 emulation program, such as Tera Term Pro© (a free terminal emulator) or Hilgraeve HyperTerminal® (provided with Windows® operating systems from XP forward).

The serial connection settings are: 9600 bits per second, 8 data bits, no parity, 1 stop bit, no flow control.

The pin-to-signal mapping for the Console port is shown below:

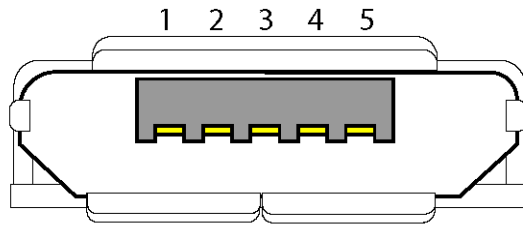

**Figure 3: Micro USB pin-to-signal mapping**

**Table 6: Pin-to-signal mapping to the Console port description**

Pin number	Description
1	NC
2	RxD (input to access point)
3	TxD (output to terminal)
4	Signal (GND)
5	Signal (GND)

## Device physical specifications, radio specifications, and power tables

For detailed device specifications and radio specifications, refer to the [AP305C/CX Data Sheet](#).

## Power Profile

AP305C/CX	802.3af	802.3at
2.4G radio	2×2 (18 dBm)	2×2 (18 dBm)
5G radio	2×2 (18 dBm)	2×2 (18 dBm)
BLE	Enabled	Enabled
USB	Yes (up to 500mA)	Yes (up to 900mA)

## Status LED Activity Description

The AP305C/CX have a rectangular status light on the top right corner of the chassis. The status light conveys operational states for system power, firmware updates, Ethernet and wireless interface activity, and major alarms.

**Table 7: Status light activity**

Status light color	Activity	Description
White	Steady	The device has successfully established a Control And Provisioning of Wireless Access Points (CAPWAP) connection to ExtremeCloud IQ and is operating normally
	Slow-blinking	The device has a CAPWAP connection to ExtremeCloud IQ, but is operating on 802.3af power instead of 802.3at power
Amber	Steady	The device is initializing, rebooting, or is running without a CAPWAP connection
	Slow-blinking	The device has no CAPWAP connection to ExtremeCloud IQ, and is operating on 802.3af power instead of 802.3at power
	Fast-blinking	The device is upgrading its ExtremeCloud IQ firmware
Dark	None	Power is off

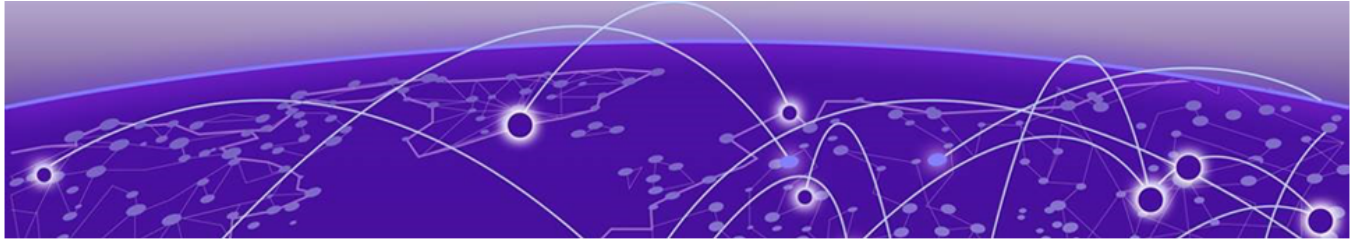

# Install the Access Point

---

[Box Contents](#) on page 14

[Install the Access Point on a Standard Ceiling Rail](#) on page 15

[Non-Standard Ceiling Grid or Wall Installation](#) on page 16

[Lock the Access Point after Installation](#) on page 19

Pre-installation instructions highlighting installation options.

## About This Task

The access point can be installed on an indoor environment such as a ceiling rail, on non-standard ceilings, and on a wall. For more information about selecting the right access point bracket and accessory for your installation needs, see the [Extreme Networks 11.ax Access Points Accessories Guide](#).



### Note

The installation procedure for AP305C/CX are similar. The installation procedure covered in this document is applicable to both the access points.

## Procedure

1. Verify the [box contents](#).
2. Visually inspect the access point, the bracket, and any other optional accessories you have ordered for physical damage.  
If there is any damage, contact [Extreme Networks Support](#).
3. Read and review the [safety guidelines](#).
4. Install the access point on a [standard ceiling rail](#) or to a [non-standard ceiling grid, or wall](#).
5. [Lock the access point after installation](#).

## Box Contents

---

Details about AP305C/CX access point box contents.

When you purchase the access point, ensure that the following items are available in the box:

- An access point you have ordered (AP305C or AP305CX)
- Read Me card

## Install the Access Point on a Standard Ceiling Rail

Install the access point on a 15/16 in. standard ceiling rail using the in-built bracket.

### Before You Begin

Hardware required for ceiling rail installation:

- An AP305C/CX access point

### About This Task

The AP305C/CX access point has a built-in bracket in the back of the access point that is used to install the access point to a standard 15/16 in. dropped ceiling grid. For non-standard ceiling rail installations, see [Non-Standard Ceiling Grid or Wall Installation](#) on page 16.

### Procedure

1. Place the in-built bracket on a 15/16 in. ceiling grid.
2. Rotate the access point to 1/8<sup>th</sup> of a turn until it clicks into place.

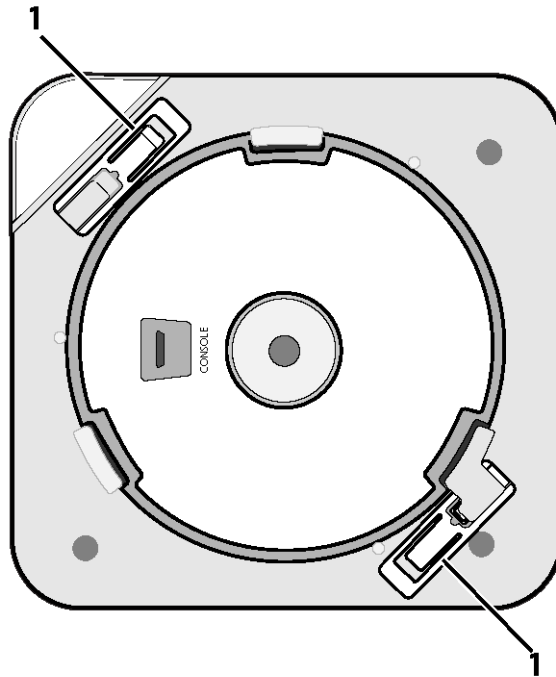

**Figure 4: Built-in brackets for standard ceiling grid mounting**

Callout	Description
1	Built-in bracket in the back of the access point

## Non-Standard Ceiling Grid or Wall Installation

Details about non-standard ceiling grid or wall installation using optional bracket and accessory.



**Note**

For all non-standard ceiling grid installation or wall installation instructions, refer to the [Wi-Fi 6 802.11ax Access Points Accessories Guide](#).

The access point can be installed on a non-standard ceiling grid using the following accessories:

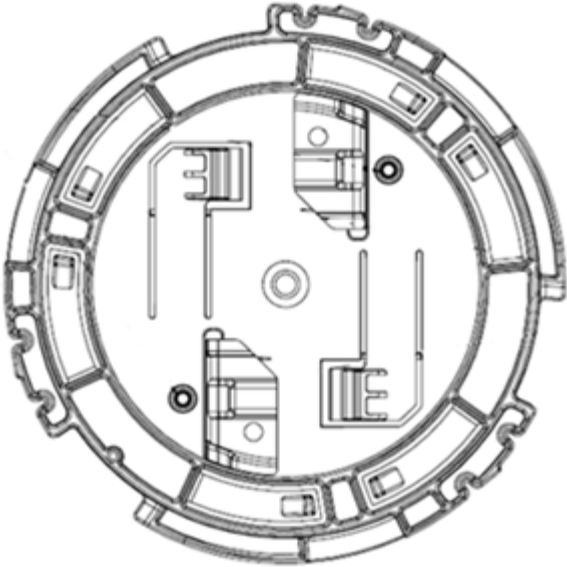
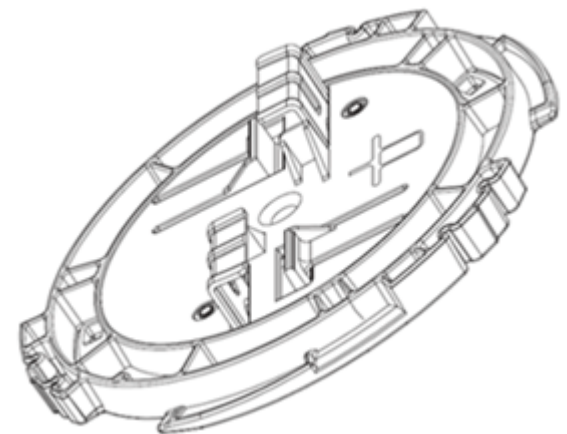
Order part number	Description
AH-ACC-BKT-AX-TB	<p>Mounting bracket for Prelude ceilings (15/16 in. ceiling grid), Suprafine ceilings (9/16 in. ceiling grid), and walls</p> 
AH-ACC-BKT-AX-IL	<p>Mounting bracket for Interlude (9/16 wide T-bar with protrusion) ceilings</p> 

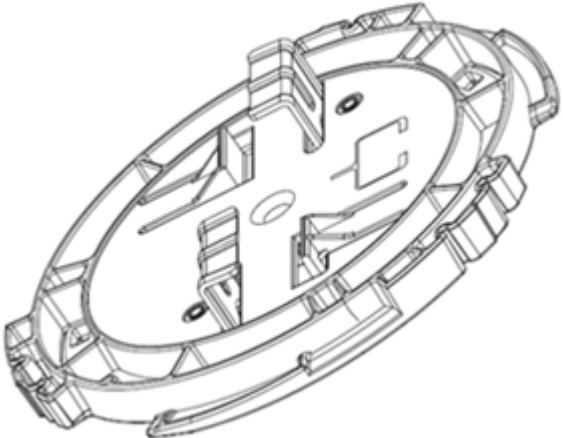
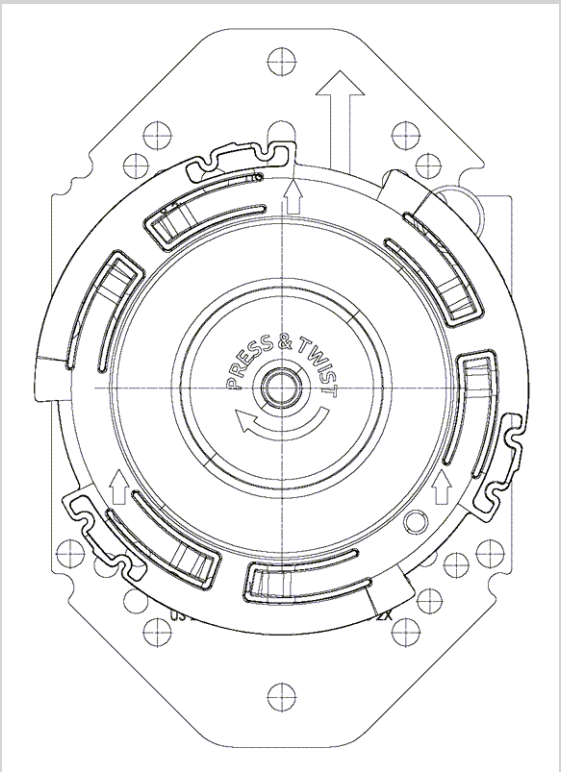
Order part number	Description
AH-ACC-BKT-AX-SL	<p data-bbox="906 264 1446 321">Mounting bracket for Silhouette ceilings (ceiling grid with 1/8 in. or 1/4 in. bottom opening)</p> 
ACC-BKT-AX-JB	<p data-bbox="906 842 1446 898">Junction box or wall mounting for indoor access points</p> 

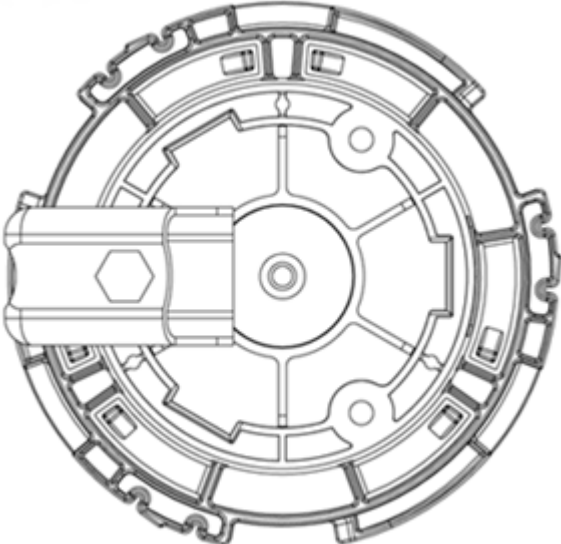
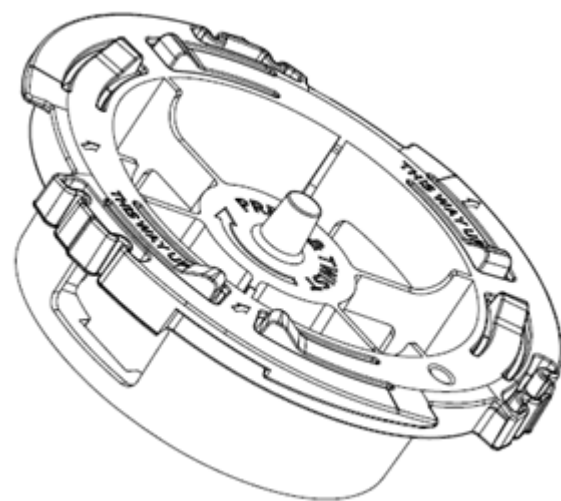
Order part number	Description
ACC-BKT-AX-BEAM	Beam mounting for indoor access points 
AH-ACC-BKT-AX-WL	Mounting bracket for direct-to-wall installations 



**Important**

The default bracket for wall installation is the ACC-BKT-AX-JB bracket.



**Note**

Order the -JB bracket for new wall installations. The AH-ACC-BKT-AX-WL bracket is for users who already have the -WL brackets.

Related Topics

[https://documentation.extremenetworks.com/wireless/Accessories\\_Guide](https://documentation.extremenetworks.com/wireless/Accessories_Guide)

## Lock the Access Point after Installation

---

Learn how to lock the indoor access point using a Kensington lock.

If you are using an indoor access point, you can secure it by using the Kensington lock on the side of the access point. The security feature is used to prevent the access point from being removed from the mounting accessory.



# External Antenna Configuration Information

---

Details about antenna gain, external antenna configuration, and antenna radio port support.

## Antenna gain

---

Wi-Fi/BLE antenna	AP305C (maximum antenna gain)	AP305CX (maximum antenna gain)
2.4 GHz	2.7 dBi	3.0 dBi
5.0 GHz	4.0 dBi	5.0 dBi

## External antenna information

---

The AP305CX access point comes with four external antenna connectors and is compatible with the ML-2452-APA2-02 and AH-ACC-ANT-AX-KT antennas.



### Note

The ML-2452-APA2-02 and AH-ACC-ANT-AX-KT antennas must be purchased separately.

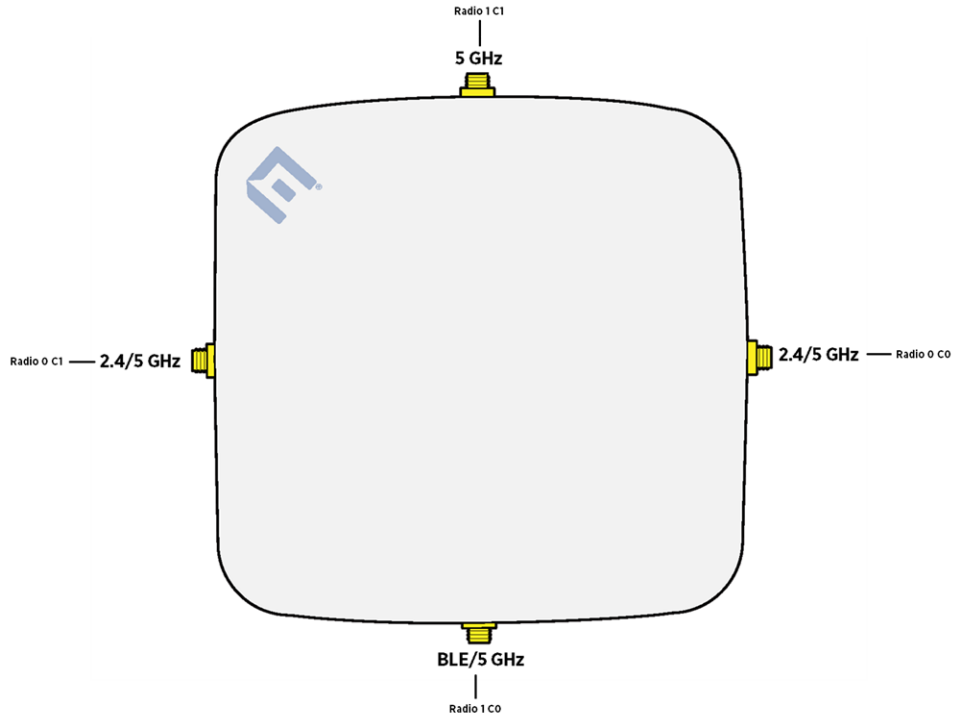

**Figure 5: AP305CX external antenna port connectors**

**Table 8: AP305CX external antenna ports radio information**

Radio modes	Antenna ports				
	Radio 0 C0	Radio 0 C1	Radio 1 C0		Radio 1 C1
Dual-band	2.4G	2.4G	5G (full)	2.4G (BLE)	5G (full)
Dual 5G	5G (low)	5G (low)	5G (high)	2.4G (BLE)	5G (high)

**Table 9: AP305CX radio ports support information**

Radio port	Antenna marking	Radio support	Antenna type
Radio 0 C0	2.4 GHz/5 GHz	2.4G/5G	Dual-band omni
Radio 0 C1	2.4 GHz/5 GHz	2.4G/5G	Dual-band omni
Radio 1 C0	Bluetooth/5 GHz	2.4G/5G	Dual-band omni
Radio 1 C1	5 GHz	5G	Dual-band omni



**Note**

For antenna specifications and installation information, refer to the [Wi-Fi 6 \(802.11ax\) Antenna Specifications Guide](#).

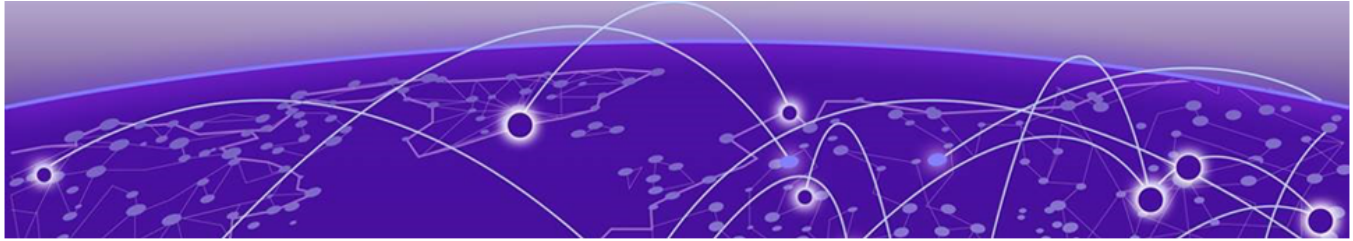

# Regulatory and Compliance Information

---

[Safety Guidelines](#) on page 22

[Japan Indoor Use Statement](#) on page 22

[Japan Voluntary Control Council for Interference \(VCCI\) - Class B](#) on page 23

[Declaration of Conformity in Languages of the European Community](#)  
on page 23

[Conformité Européenne \(CE\) Information](#) on page 25

[CE Marking and European Area \(EEA\)](#) on page 25

[Brazil Agência Nacional De Telecomunicações \(Anatel\) Statement](#) on page 25

[Mexico Compliance Statement](#) on page 26

[Industry Canada Statement](#) on page 26

[Taiwan Regulatory Statement](#) on page 27

[NCC Statement](#) on page 28

[European Waste Electrical and Electronic Equipment \(WEEE\) Notice](#)  
on page 28

[Supplement to Product Instructions](#) on page 29

Learn about safety guidelines, compliance notices, and regulatory information pertaining to various countries in which the device can be used.

## Safety Guidelines

---

Learn about the safety guidelines that are intended to protect your personal safety and prevent damage to the equipment.



### Important

Only qualified personnel must perform installation procedures. Within the context of the safety notes in this documentation, qualified persons are defined as persons who are authorized to commission grounding, and label devices, systems, and circuits in accordance with established safety practices and standards. A qualified person understands the requirements and risks involved with installing the electrical equipment in accordance with national codes.

## Japan Indoor Use Statement

---

For Japan, the AP305C and AP305CX are restricted for indoor use in the 5150-5350 MHz band only.

## Japan Voluntary Control Council for Interference (VCCI) - Class B

この装置は、クラスB情報技術装置です。この装置は、家庭環境で使用することを目的としていますが、この装置がラジオやテレビジョン受信機に近接して使用されると、受信障害を引き起こすことがあります。

取扱説明書に従って正しい取り扱いをして下さい。 VCCI-B

## Declaration of Conformity in Languages of the European Community

English	Hereby, Extreme Networks declares that the radio equipment type (AP305C/CX) is in compliance with Directive 2014/53/EU. For full text of the EU Declaration of Conformity, contact Extreme Regulatory Compliance at <a href="mailto:compliancerequest@extremenetworks.com">compliancerequest@extremenetworks.com</a>
Finnish	Valmistaja Extreme Networks vakuuttaa täten että Radio LAN device (AP305C/CX) tyyppinen laite on direktiivin 2014/53/EU oleellisten vaatimusten ja sitä koskevien direktiivin muiden ehtojen mukainen. EU-vaatimustenmukaisuusvaatimuksen täydellisestä tekstistä ota yhteyttä äärimmäisiin säädösten noudattamiseen osoitteessa <a href="mailto:compliancerequest@extremenetworks.com">compliancerequest@extremenetworks.com</a>
Dutch	Hierbij verklaart Extreme Networks dat het toestel Radio LAN device (AP305C/CX) in overeenstemming is met de essentiële eisen en de andere relevante bepalingen van richtlijn 2014/53/EU. Neem voor de volledige tekst van de EU-conformiteitsverklaring u contact opnemen met extreme regelgeving op <a href="mailto:compliancerequest@extremenetworks.com">compliancerequest@extremenetworks.com</a>
French	Par la présente Extreme Networks déclare que l'appareil Radio LAN device (AP305C/CX) est conforme aux exigences essentielles et aux autres dispositions pertinentes de la directive 2014/53/EU. Pour obtenir le texte intégral du processus de Déclaration de la conformité de l'UE, veuillez contacter la conformité réglementaire extrême à l'adresse suivante: <a href="mailto:compliancerequest@extremenetworks.com">compliancerequest@extremenetworks.com</a>
Swedish	Härmed intygar Extreme Networks att radioutrustningstypen AP305C/CX överensstämmer med de väsentliga egenskapskrav och övriga relevanta bestämmelser som framgår av direktiv 2014/53/ EU. För fullständig text av EU-försäkran om överensstämmelse, kontakta Extreme regelefterlevnad på <a href="mailto:compliancerequest@extremenetworks.com">compliancerequest@extremenetworks.com</a>

Danish	Undertegnede Extreme Networks erklærer herved, at følgende udstyr Radio LAN device (AP305C/CX) overholder de væsentlige krav og øvrige relevante krav i direktiv 2014/53/EU. For den fulde ordlyd af EU-overensstemmelseserklæringen bedes du kontakte Extreme Regulatory Compliance på <a href="mailto:compliancerequest@extremenetworks.com">compliancerequest@extremenetworks.com</a>
German	Hiermit erklärt Extreme Networks die Übereinstimmung des "WLAN Wireless Controller bzw. Access Points" (AP305C/CX) mit den grundlegenden Anforderungen und den anderen relevanten Festlegungen der Richtlinie 2014/53/EU. Für den vollständigen Wortlaut der EU-Konformitätserklärung wenden Sie sich bitte an extreme Regulatory Compliance unter <a href="mailto:compliancerequest@extremenetworks.com">compliancerequest@extremenetworks.com</a>
Greek	<b>ΜΕ ΤΗΝ ΠΑΡΟΥΣΑ</b> Extreme Networks <b>ΔΗΛΩΝΕΙ ΟΤΙ</b> Radio LAN device (AP305C/CX) <b>ΣΥΜΜΟΡΦΩΝΕΤΑΙ ΠΡΟΣ ΤΙΣ ΟΥΣΙΩΔΕΙΣ ΑΠΑΙΤΗΣΕΙΣ ΚΑΙ ΤΙΣ ΛΟΙΠΕΣ ΣΧΕΤΙΚΕΣ ΔΙΑΤΑΞΕΙΣ ΤΗΣ ΟΔΗΓΙΑΣ</b> 2014/53/EU. Για το πλήρες κείμενο της δήλωσης συμμόρφωσης ΕΕ, παρακαλούμε επικοινωνήστε με την ακραία κανονιστική συμμόρφωση στο <a href="mailto:compliancerequest@extremenetworks.com">compliancerequest@extremenetworks.com</a>
Icelandic	Extreme Networks lýsir her með yfir að thessi bunadur, Radio LAN device (AP305C/CX), uppfyllir allar grunnkröfur, sem gerðar eru í R&TTE tilskipun ESB nr 2014/53/EU. Fyrir fullan texta í ESB yfirlýsingu um samræmi, vinsamlegast hafðu samband við Extreme Regluflýgni á <a href="mailto:compliancerequest@extremenetworks.com">compliancerequest@extremenetworks.com</a>
Italian	Con la presente Extreme Networks dichiara che questo Radio LAN device (AP305C/CX) è conforme ai requisiti essenziali ed alle altre disposizioni pertinenti stabilite dalla direttiva 2014/53/EU. Per il testo integrale della Dichiarazione di conformità dell'UE, contattare Extreme Regulatory Compliance presso <a href="mailto:compliancerequest@extremenetworks.com">compliancerequest@extremenetworks.com</a>
Spanish	Por medio de la presente Extreme Networks declara que el Radio LAN device (AP305C/CX) cumple con los requisitos esenciales y cualesquiera otras disposiciones aplicables o exigibles de la Directiva 2014/53/EU. Para obtener el texto completo de la Declaración de conformidad de la UE, póngase en contacto con Extreme Regulatory Compliance en <a href="mailto:compliancerequest@extremenetworks.com">compliancerequest@extremenetworks.com</a>

Portuguese	Extreme Networks declara que este Radio LAN device (AP305C/CX) está conforme com os requisitos essenciais e outras disposições da Directiva 2014/53/EU. Para o texto integral da declaração de conformidade da UE, contacte a conformidade regulamentar extrema em <a href="mailto:compliancerequest@extremenetworks.com">compliancerequest@extremenetworks.com</a>
Malti	Hawnhekk, Extreme Networks, jiddikjara li dan Radio LAN device (AP305C/CX) jikkonforma mal-htigijiet essenzjali u ma provvedimenti oħrajn rilevanti li hemm fid-Dirrettiva 2014/53/EU. Għat-test sħiħ tad-dikjarazzjoni ta' konformità tal-UE, jekk jogħġbok ikkuntattja lill-konformità regolatorja <a href="mailto:compliancerequest@extremenetworks.com">compliancerequest@extremenetworks.com</a>

## Conformità Europea (CE) Information



### Warning

#### CE co-location MPE Statement:

This equipment complies with CE radiation exposure limits set forth for an uncontrolled environment. This equipment should be installed and operated with minimum distance of 20 cm between the radiator and your body.

The device is restricted to indoor use only when operating in the 5150 to 5350 MHz frequency range.

**Table 10: Selling Countries:**

	AT	BE	BG	HR	CY	CZ	DK
	EE	FI	FR	DE	EL	HU	IE
	IT	LV	LT	LU	MT	NL	PL
	PT	RO	SK	SI	ES	SE	UK

## CE Marking and European Area (EEA)



### Warning

This is a class A product. In a domestic environment, this product may cause radio interference in which case the user may be required to take adequate measures.

## Brazil Agência Nacional De Telecomunicações (Anatel) Statement

Details about certification from Brazil's local authority Agência Nacional De Telecomunicações (Anatel) for access point usage in Brazil.

Este produto está homologado pela Anatel, de acordo com os procedimentos regulamentados e atende aos requisitos técnicos aplicados.

Este equipamento não tem direito à proteção contra interferência prejudicial e não pode causar interferência em sistemas devidamente autorizados. Para maiores informações, consulte o site da Anatel - [www.anatel.gov.br](http://www.anatel.gov.br)

## Mexico Compliance Statement

---

Details about compliance conditions for device use in Mexico.

La operación de este equipo está sujeta a las siguientes dos condiciones

1. es posible que este equipo o dispositivo no cause interferencia perjudicial y
2. este equipo o dispositivo debe aceptar cualquier interferencia, incluyendo la que pueda causar su operación no deseada.

The operation of this equipment is subject to the following two conditions:

1. it is possible that this equipment or device does not cause disruptive interference and
2. this equipment or device must accept any interference, including interference that may cause undesired operation.

## Industry Canada Statement

---

This device complies with Innovation, Science and Economic Development (ISED) Canada's licence-exempt RSSs. Operation is subject to the following two conditions: (1) this device may not cause harmful interference, and (2) this device must accept any interference received, including interference that may cause undesired operation.

Le présent appareil est conforme aux CNR d'ISED applicables aux appareils radio exempts de licence. L'exploitation est autorisée aux deux conditions suivantes : (1) le dispositif ne doit pas produire de brouillage préjudiciable, et (2) ce dispositif doit accepter tout brouillage reçu, y compris un brouillage susceptible de provoquer un fonctionnement indésirable.

For products available in the USA and Canada markets, only channel 1-11 can be operated. Other channels cannot be selected.

Pour les produits disponibles sur les marchés Américain et Canadien, seuls les canaux 1 - 11 peuvent être utilisés. Les autres canaux ne peuvent pas être sélectionnés.



### Caution

The device for operation in the band 5150-5250 MHz is only for indoor use to reduce the potential for harmful interference to co-channel mobile satellite systems.

les dispositifs fonctionnant dans la bande 5150-5250 MHz sont réservés uniquement pour une utilisation à l'intérieur afin de réduire les risques de brouillage préjudiciable aux systèmes de satellites mobiles utilisant les mêmes canaux.

**Caution**

1. The device for operation in the band 5150-5250 MHz is only for indoor use to reduce the potential for harmful interference to co-channel mobile satellite systems.
  2. The maximum antenna gain permitted for devices in the band 5725-5850 MHz shall be such that the equipment still complies with the e.i.r.p. limits specified for point-to-point and non-point-to-point operation as appropriate.
  3. Users should also be advised that high-power radars are allocated as primary users (i.e. priority users) of the bands 5650-5850 MHz and that these radars could cause interference and/or damage to LE-LAN devices.
1. The device for operation in the band 5150-5250 MHz is only for indoor use to reduce the potential for harmful interference to co-channel mobile satellite systems.
  2. The maximum antenna gain permitted for devices in the band 5725-5850 MHz shall be such that the equipment still complies with the e.i.r.p. limits specified for point-to-point and non-point-to-point operation as appropriate.
  3. Users should also be advised that high-power radars are allocated as primary users (i.e. priority users) of the bands 5650-5850 MHz and that these radars could cause interference and/or damage to LE-LAN devices.

**Caution****Avertissement:**

1. les dispositifs fonctionnant dans la bande 5150-5250 MHz sont réservés uniquement pour une utilisation à l'intérieur afin de réduire les risques de brouillage préjudiciable aux systèmes de satellites mobiles utilisant les mêmes canaux.
2. le gain maximal d'antenne permis (pour les dispositifs utilisant la bande de 5725 à 5 850 MHz) doit être conforme à la limite de la p.i.r.e. spécifiée pour l'exploitation point à point et l'exploitation non point à point, selon le cas.
3. De plus, les utilisateurs devraient aussi être avisés que les utilisateurs de radars de haute puissance sont désignés utilisateurs principaux (c.-à-d., qu'ils ont la priorité) pour les bandes 5650-5850 MHz et que ces radars pourraient causer du brouillage et/ou des dommages aux dispositifs LANEL.

## Taiwan Regulatory Statement

---

第十二條→經型式認證合格之低功率射頻電機，非經許可，公司，商號或使用者均不得擅自變更頻率、加大功率或變更原設計之特性及功能。第十四條→低功射頻電機之使用得影響飛航安全及干擾合法通信；經發現有干擾現象時，應即停用，並改善至無干擾時方得繼續使用。前項合法通信，指依電信法規定作業之無線電通信。低功射頻電機須忍受合法通信或工業、科學及醫用電波射性電機設備之干擾。在 5.25-5.35 兆赫頻帶□操作之無線資訊傳輸設備，限於室□使用。無線資訊傳設備的製造廠商應確保頻穩定性，如依製造廠商使用手冊上所述正常操作，發射的信號應維持於操作頻帶中。

### Taiwan Maximum Permissible Exposure (MPE) warning

電磁波曝露量 MPE 標準□(MPE) 1mW/cm<sup>2</sup>，送測□品實□為 0.734 mW/cm<sup>2</sup>

Avoid affecting the operation of nearby radar systems. 應避免影響附近雷達系統之操作

High-gain directional antennas can only be used in stationary point-to-point systems. 高增益指向性天線只得應用於固定式點對點系統。

## NCC Statement

取得審驗證明之低功率射頻器材，非經核准，公司、商號或使用者均不得擅自變更頻率、加大功率或變更原設計之特性及功能。低功率射頻器材之使用不得影響飛航安全及干擾合法通信；經發現有干擾現象時，應立即停用，並改善至無干擾時方得繼續使用。前述合法通信，指依電信管理法規定作業之無線電通信。低功率射頻器材須忍受合法通信或工業、科學及醫療用電波輻射性電機設備之干擾。

## European Waste Electrical and Electronic Equipment (WEEE) Notice



In accordance with Directive 2012/19/EU of the European Parliament on waste electrical and electronic equipment (WEEE):

1. The symbol above indicates that separate collection of electrical and electronic equipment is required.
2. When this product has reached the end of its serviceable life, it cannot be disposed of as unsorted municipal waste. It must be collected and treated separately.
3. It has been determined by the European Parliament that there are potential negative effects on the environment and human health as a result of the presence of hazardous substances in electrical and electronic equipment.
4. It is the user's responsibility to utilize the available collection system to ensure WEEE is properly treated.

For information about the available collection system, please contact Extreme Environmental Compliance at [Green@extremenetworks.com](mailto:Green@extremenetworks.com).

## Supplement to Product Instructions

單元 Unit	限用物質及其化學符號 Restricted substances and its chemical symbols					
	鉛Lead (Pb)	汞Mercury (Hg)	鎘Cadmium (Cd)	六價鉻 Hexavalent chromium (Cr <sup>+6</sup> )	多溴聯苯 Polybrominated biphenyls (PBB)	多溴二苯醚 Polybrominated diphenyl ethers (PBDE)
金屬零件 (Metal Parts)	○	○	○	○	○	○
電路模組 (Circuit Modules)	—	○	○	○	○	○
電纜及電纜組件 (Cables & Cable Assemblies)	○	○	○	○	○	○
塑料和聚合物零件 (Plastic and Polymeric parts)	○	○	○	○	○	○
<p>備考1. “超出0.1 wt %”及“超出0.01 wt %”係指限用物質之百分比含量超出百分比含量基準值。            Note 1 : “Exceeding 0.1 wt %” and “exceeding 0.01 wt %” indicate that the percentage content of the restricted substance exceeds the reference percentage value of presence condition.</p> <p>備考2. “○”係指該項限用物質之百分比含量未超出百分比含量基準值。            Note 2 : “○” indicates that the percentage content of the restricted substance does not exceed the percentage of reference value of presence.</p> <p>備考3. “—”係指該項限用物質為排除項目。            Note 3 : The “—” indicates that the restricted substance corresponds to the exemption.</p>						

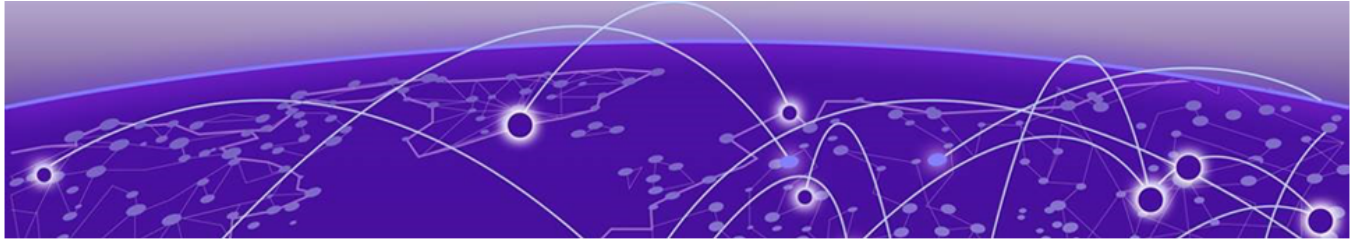

# Index

---

## A

- access point lock
  - Kensington lock 19
  - security bracket 19
  - security torx 19
- announcements 6
- antenna configuration
  - antenna gain 20
  - external antenna configuration 20
- AP305/CX overview 8
- AP305C/CX features
  - radios 9-12

## B

- box contents
  - AP305C/CX access point 14
  - Read Me card 14

## C

- CE information 25
- ceiling rail install
  - 15/16 ceiling 15
  - dropped ceiling grid 15
  - in-built bracket 15
  - standard ceiling 15
- conventions
  - notice icons 4
  - text 4
- country code 8

## D

- documentation
  - feedback 6
  - location 5

## F

- feedback 6

## I

- industry Canada statement 26
- install the access point
  - box contents 14
  - safety guidelines 14
  - visual inspection 14

## J

- Japan class B statement 23
- Japan indoor use 22

## M

- Mexico compliance statement 26

## N

- NCC statement 28
- non-standard ceiling install
  - accessory information 16
  - AH-ACC-BKT-AX-IL accessory 16
  - AH-ACC-BKT-AX-SL accessory 16
  - AH-ACC-BKT-AX-TB accessory 16
- notices 4

## P

- power profile
  - 802.3af 12
  - 802.3at 12
- product announcements 6

## R

- Restriction of Hazardous Substances information 29

## S

- safety guidelines 22
- status light activity
  - dark 13
  - white 13
- support, see technical support

## T

- Taiwan regulatory statement 27
- technical support
  - contacting 6

## W

- warnings 4