



Questo manuale d'istruzione è fornito da trovaprezzi.it. Scopri tutte le offerte per [Fantec QB-35U31R](#) o cerca il tuo prodotto tra le [migliori offerte di Storage](#)

[trovaprezzi.it](#)

Questo manuale d'istruzione è fornito da trovaprezzi.it. Scopri tutte le offerte per [Fantec QB-35U31R](#) o cerca il tuo prodotto tra le [migliori offerte di Storage](#)

# fantec

## Model QB-35U31R

4-Bay HDD-Enclosure with RAID-Functionality

### Manual English



# RAID

**4-BAY RAID ENCLOSURE**

For 3.5" SATA I / II / III HDD



# Inhalt

- 3 Contact**
- 4 Introduction**
- 4 Technical Data**
  - 4 Delivery
  - 4 Features
  - 4 Connections
  - 5 System Requirements
  - 5 Working Environment
  - 5 Security Instructions
- 6 Overview**
  - 6 Front View
  - 7 Controls
  - 8 Rear View
  - 8 Side View
- 9 Assembly**
  - 9 Hard Drive Installation
  - 11 Opening the Front Panel
  - 11 Changing the Fan
- 12 Setup**
  - 12 RAID-Modes**
    - 12 Single Mode
    - 12 RAID 0 Spanning
    - 13 RAID 0 Striping
    - 13 RAID 1 Mirroring
  - 14 Operation Manual**
    - 14 First Use
    - 14 Setting the RAID-Mode
    - 15 Particularities in Single Mode
    - 15 After Installation of a Set
    - 15 Usage of Hardware-RAID-Managers
  - 15 Usage of Hard Drives**
    - 16 RAID 0
    - 16 RAID 1
    - 16 Hints for the Installation of Hard Drives with Data

- 18 Data Loss due to Mechanical Influences, Software-Influences or Faulty Operation
- 18 Reading of Hard Drive Information
- 18 Secure Removing of the Hard Drive

## **20 Initialising, Partitioning and Formatting**

- 20 Windows
- 21 Mac OS

## **Contact**

Contact our technical support at:

**service@fantec.de**

**+49 (0)40 730 92 83 56**

We are online at:

**www.fantec.de**

### **Declaration of Conformity:**

<http://www.fantec.de/unternehmen/ce>

### **Adress for RMA Sending from Germany**

**For RMA-Service outside of Germany please contact your dealer!**

**fantec** GmbH

Abteilung RMA/Service

Billwerder Billdeich 605 B

21033 Hamburg – Germany

## Introduction

Save your Data with the **fantec** QB-35U31R with room for up to four SATA hard drives in one enclosure. With diverse RAID-Levels (Single, 0 , 1) the QB-35U31R offers different settings for data security or increased performance. All hard drives can also be displayed, controlled, changed and replaced individually as well as expanded independently of producer or capacity. With the USB 3.1 interface you can transfer your data lightning-fast with up to 10 Gbit/s and the UASP-transport-protocol allows even more increased performance. The built-in temperature-sensor controls the fan automatically in 3 steps for optimal ventilation of your hard drives and the integrated USB-Hub prevents the loss of interfaces on your system.

## Technical Data

### Delivery

- 1× USB 3.1 Cable
- 4× Hard drive Handles
- 1× External Power Supply
- 1× Screwdriver
- Manual

### Features

- Suitable for 4× 8,89cm (3,5“) SATA I/II/III HDDs
- RAID modes Single, 0 Spanning, 0 Striping, 1 Mirroring
- USB 3.1 Gen. 2 Interface
- USB-Hub (1× USB 3.0 Typ A, 1× USB 3.1 Typ C)
- Data transfers up to 10Gbit/s
- Internal 80mm fan
- Automatic fan control by integrated teperature-sensor
- Synchronised deactivation when PC is shut down
- LED display (front side)
- Setup for RAID Mode, fan control

### Connections

- 4× SATA (internal)
- 1× USB 3.1 Gen. 2 Type C Device (back side)
- 1× USB 3.1 Gen. 2 Type C Hub (side)
- 1× USB 3.0 Type A Hub (side)

- 1× Power connection (side)

## System Requirements

- Microsoft Windows 7 / 10
- Mac OS X 10.13 or higher

## Working Environment

- Temperature: 0 ~ 40 °C
- Humidity: 5 % ~ 90 % RH

## Security Instructions

- Protect the product against moisture and direct sunlight
- Do not place this device near water.
- Clean only with a dry cloth.
- Do not block any ventilation openings.
- Install in accordance with the manufacturer's instructions.
- Do not place near any heat sources such as radiators, heat registers, stoves, or the devices (including amplifiers) that produce heat.
- Protect the power cord from being walked on or pinched particularly at plugs, convenience receptacles, and the point where they exit from the devices.
- Only use attachments/accessories specified by the manufacturer.
- Unplug this during lightning storms or when unused for long periods of time.
- Carefully read and follow the Quick Install Guide and User Manual.
- Do not drop or shake the device.
- Do not move the device when it is powered on.
- Do not overload wall outlets.
- Refer all servicing to qualified service personnel.

### **Servicing is required when the devices has been damaged in any way, such as:**

- power-supply cord or plug is damaged;
- liquid has been spilled or objects have fallen into the devices,
- the devices has been exposed to rain or moisture,
- does not operate normally, or has been dropped.

# Overview

## Front View



## Controls

1. Main Switch	<b>on</b>	press switch
	<b>off</b>	hold switch ca. 3 sec.
2. Mode for Set 1 <sup>1</sup>		RAID-mode-change: hold ca.3 sec.
3. Mode for Set 2 <sup>1</sup>		RAID-mode-change: hold ca.3 sec.
4. Smart Fan		automatic fan control on / off
5. Status LED	<b>blue</b>	Device is switched on
	<b>orange</b>	Device is in standby
	<b>off</b>	Device is switched off
6. USB Port		active / access USB3.1 Typ-C port device
active RAID-Mode Set 1	<b>orange</b>	
	<b>SINGLE</b>	simulates single hard drives
	<b>RAID 0 SPN</b>	Spanning (BIG)
	<b>RAID 0 STR</b>	Striping
	<b>RAID 1</b>	Mirroring
active RAID-Mode Set 2	<b>green</b>	
	<b>SINGLE</b>	simulates single hard drives
	<b>RAID 0 SPN</b>	Spanning (BIG)
	<b>RAID 0 STR</b>	Striping
	<b>RAID 1</b>	Mirroring
7. HDD Error LED <sup>2</sup>		signals hard drive errors / rebuilding a RAID
8. Status Smart Fan	<b>on</b>	fan is controlled automatically by temperature
	<b>off</b>	fan is running with minimal number of revolutions
9. HDD Status	<b>blue</b>	active
	<b>purple flashing</b>	Access
	<b>purple pulsating</b>	active rebuild of a RAID1
10. HDD Error	<b>red</b>	active rebuild of a RAID1
	<b>red flashing</b>	malfunction or incompatible to RAID
11. Disk Holder		

<sup>1</sup> This device consists of two independent RAIDs.

<sup>2</sup> HDD Error is not displayed in Single Mode.

## Rear View

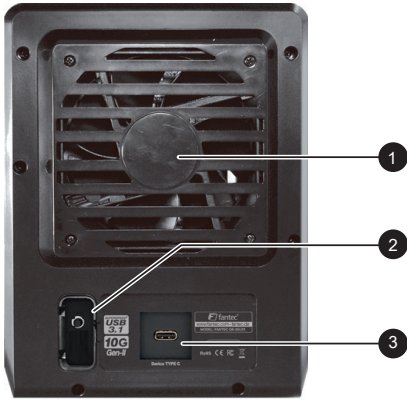

1. Fan
2. RAID-Mode-Confirmation
3. USB 3.1 Typ-C port

## Side View

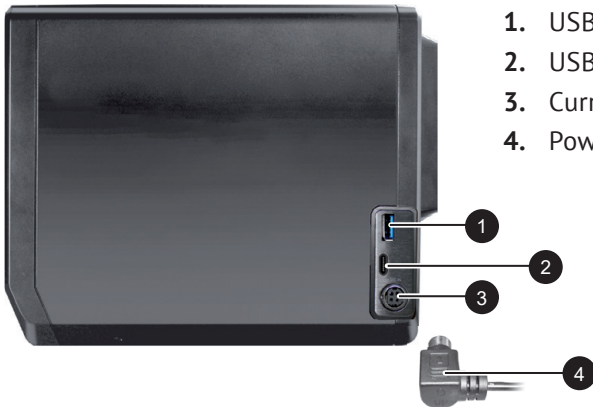

1. USB Hub Typ-A port
2. USB Hub Typ-C port
3. Current input
4. Power plug



HDD Handle



Front Cover



Metal Cladding

# Assembly

## Hard Drive Installation

1. Please attach the included handles to the hard drives with screws.

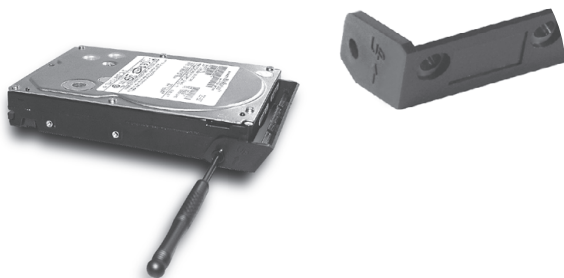

2. Push the circular indentation, to open the enclosure.

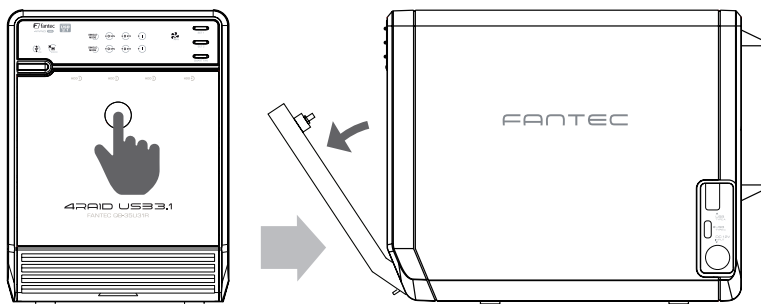

3. Push both handles, to remove the metal cladding.

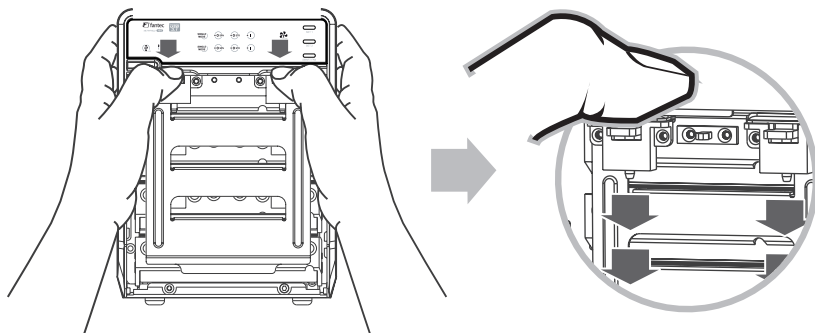

4. Please remove the transport safety board.

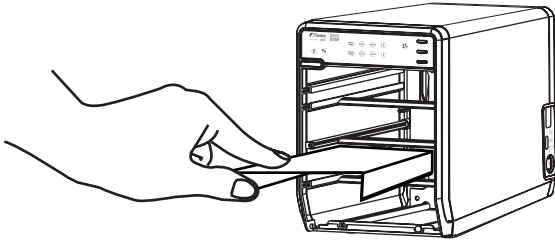

5. Push the hard drives into the enclosure and check if they are installed in the correct order from top to bottom.  
To remove the hard drives, push the attached handle slightly downwards and then pull the hard drive out.

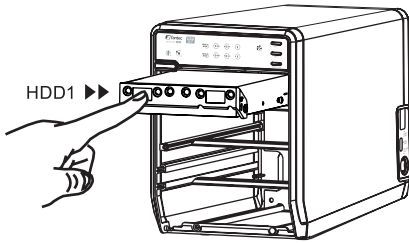

6. Put the metal cladding which was removed in step 3 back in and be careful that it locks in as well. After that the front panel can be closed again.

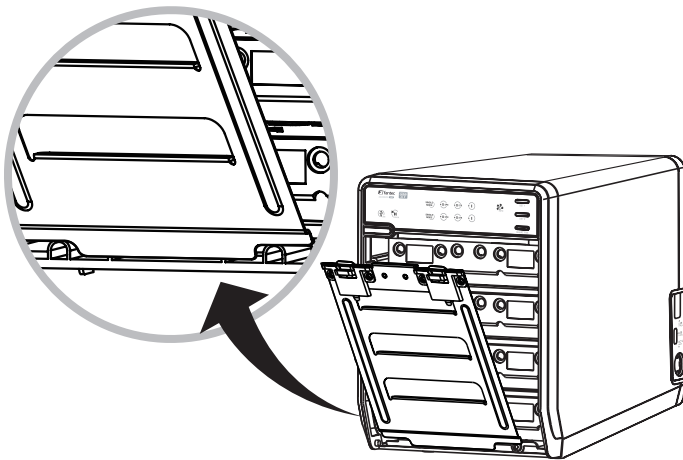

7. Connect the device with the power adapter and switch it on.  
**Attention:** When the USB-cable is removed the enclosure switches to stand-by-mode automatically.

## Opening the Front Panel



If you forgot to put the metal cladding back in place before closing the front panel, simply push – as shown in the image – the lower lever. This makes the front panel open slowly. Please do not try to open the front panel with a sharp object.

## Changing the Fan

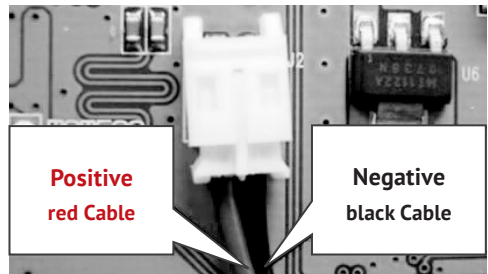
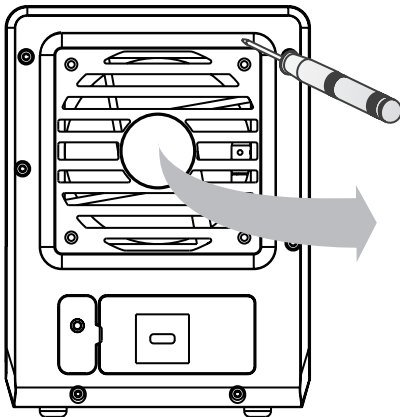

If the fan becomes noisy shut down the enclosure and open the paneling on the back side. Now you can remove the fan and clean it carefully. Should the noise not stop despite the cleaning, you can replace the fan with an identical one (80 × 80 × 20mm). In case of complete failure of the fan please contact our service.

# Setup

## RAID-Modes

The QB-35U31R offers the following RAID-modes: **Single**, **RAID 0 Spanning** (Big), **RAID 0 Striping** and **RAID 1**. These modes can be created in two independent sets of two hard drives. The QB-35U31R has no standard mode.

To install a RAID you need hard drives which do not contain important data. Usually no already saved data can be transferred into a RAID-system.

**Only in Single Mode you can use hard drives which already contain data.** Please read *Hints for the Installation of Hard Drives with Data (P.17)*.

## Single Mode

In Single Mode or “Non-RAID” Mode the **hard drives of a set are displayed as independent drives** at the computer. This function can be used if RAID is not necessary, if only one hard drive is installed or two hard drives of different brands or capacities are installed.

**Please note:** In Windows the command “safely remove hardware” can not be used on a single drive-letter but only on a complete set.

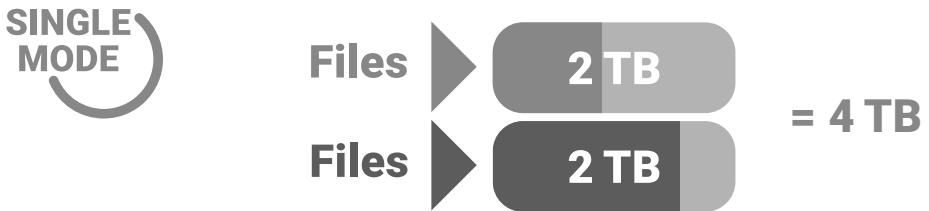

## RAID 0 Spanning

Spanning connects **several physical drives to one large virtual drive** and thereby bypasses the physical limitations of individually connected hard drives. The data is written **continually** from HDD 1 to HDD 2 (see image). When one drive fails or gets damaged all data will be lost and can only be reconstructed with professional help.

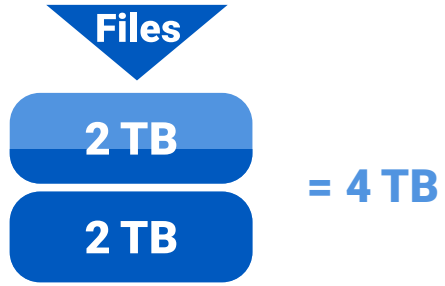

### RAID 0 Striping

Striping connects **several drives to one large virtual drive as a logical unit**. The data is written **parallel** onto all hard drives, which results in an increased data-transfer-rate. When one drive fails or gets damaged all data will be lost and can only be reconstructed with professional help. The usable memory corresponds to the memory of the smallest drive times two. For this mode we recommend to use two identical hard drives (same capacity, brand and model-number).



### RAID 1 Mirroring

Mirroring is the **automatic copying of data onto several hard drives**. This ensures high reliability of the data network in the event of a hard drive failure. In case of failure of one disk access is still possible and after exchange of the failed drive the data will be restored. The usable memory corresponds to the memory of the smallest drive.

For this mode we recommend to use two identical hard drives (same capacity, brand and model-number).



Files



= 2 TB

## Operation Manual

### First Use

**Attention:** After several seconds the enclosure shuts down automatically, if hard drives are installed without choosing a RAID-mode.

Both red LEDs (Nr. 12 on P. 6) permanently being on signals an erroneous RAID. This means the controller is not finding the hard drives in the state necessary for the chosen RAID-mode.

**The QB-35U31R is set to Single mode on delivery!** In this state you can install the hard drives which will not be used as a RAID and save your data after initialising the drives. If you want to use a RAID, set up the device accordingly. After setting up the chosen RAID the LEDs (Nr.12) will turn off if everything is working.

**Save your data before changing the RAID-mode of the device to avoid negative consequences of maloperations or other faults.**

### Setting the RAID-Mode

1. Remove the cap on the back side and remember the position of the **RAID-Mode-Confirmation-Key**.
2. Install the hard drives into the enclosure, connect it to a computer (The enclosure switches to standby-mode when it is not connected) and switch on the device.
3. Hold the button **SET1** (for the top two hard drives) or **SET2** (for the bottom two hard drives) until the LED for the RAID-option starts to blink.
4. Repeat the process until the chosen RAID-mode is set and the corresponding LED flashes.
5. Press the **RAID-Mode-Confirmation-Key** at



RAID-Mode-Confirmation-Key

the back side of the device until it shuts down. This step has to be done quickly as the blinking LED changes to solid light after a few seconds which indicates that the device can not be adjusted any more.

6. Switch the device back on with the **main switch** on the front panel. Check if the adjustment of the set you just made has been accepted by the device. If necessary repeat the process. If no second set shall be installed, put the cap of the **RAID-Mode-Confirmation-Key** back on.
7. You can now prepare the next RAID-set. Both sets can be adjusted independently of each other. Note that by switching the device on or off the operation of the other drive will be interrupted.
8. Cover the **RAID-Mode-Confirmation-Key** with its cap and switch the device off and on again with the **main switch** at the front and check the settings.
9. As soon as your new RAID drive is ready you have to initialise it in your operating system. Please read the chapter ***Initialisation, Partitioning and Formatting (P.20)***.

### Particularities in Single Mode

In Single Mode it is **not necessary to initialise the hard drives in any case**. This depends on whether they have already been initialised and if this initialisation can be processed by the QB-35U31R. In most cases the operating system will present a note about a new partition. In Windows this is mostly a new drive letter. If not, please see chapter ***Initialisation, Partitioning and Formatting (P.20)***.

### After Installation of a Set

**The first reboot** of the device after being shut down with the **RAID-Mode-Confirmation-Key takes a few seconds longer than a regular reboot**; the Enclosure is testing the hard drives and prepares them for RAID-operation: it overwrites partition-tables if necessary. If this process takes more than a few seconds the device is not able to create a RAID. This means the hard drives differ too much regarding characteristics and therefore **do not work synchronously**. Such hard drives can not be used in that pairing for this particular RAID. **For this reason we recommend to the same hard drives** as described under ***Usage of Hard Drives (P.16)***.

### Usage of Hardware-RAID-Managers

**Attention:** Do not use any software to control the Hardware-RAID-Controller of the QB-35U31R. No “tool” is needed. Please only use the controls meant for that.

### Usage of Hard Drives

For your RAID to work reliably, we recommend the **use of identical hard drives**: of the same **size**, the same **manufacturer** and of the same **production date**.

## RAID 0

- When a hard drive fails in a RAID 0, the RAID fails completely.
- A **RAID 0 Spanning** offers the possibility to use hard drives with different characteristics. This is only a good solution if the saved data is actually redundant. As an archive of “old hard drives” it is not a good solution. Old disks will eventually fail and your archive will be lost.

## RAID 1

- A RAID 1 continues to work even if one hard drive fails. The failed disk should be replaced as soon as possible as another disk failure would mean a complete loss of all data. **We recommend to perform a data backup before installing the new hard drive.** The exchange of a hard drive and the following rebuild of the data use both drives heavily – there is a risk for the other hard drive to fail too.
- The installation of a new hard drive triggers the rebuild of the data. You can simply put in the new hard drives while the other are busy but the smooth operation of a RAID 1 can be interrupted by that. The rebuilding process takes several hours – it is dependent on size and processing speed of the hard drives. It **does not take place on the filesystem-layer** which means it cannot be seen on the hard drives. Although the drive can be used during the rebuild this will delay the process.
- The **rebuild** will not start when drive is actively accessed or the data cable is not connected. If you notice this, just turn off the device, connect it to a PC and turn it on again.
- A **started and active rebuild** will be carried out even with disconnected USB cable.
- A **disk failure** is signalled by the flashing of the red LED (Nr. 12) on the failed disk.
- A **rebuild** of the mirror is signalled by the light of the red LED (Nr. 12) on the failed disk. At the same time both LEDs (Nr. 11) are changing colour between blue and purple and both hard drives are working permanently.
- **Hard drives age and will eventually fail.** They can also **fail spontaneously due to other defects.** When they are “identical” they will reach their **lifetime limit** around the same time.

According to this we recommend following strategy for exchanging hard drives: Has one hard drive failed spontaneously, exchange this one hard drive. Has the hard drive reached its lifetime limit (which differs from hard drive model to model and depends on the intensity of usage), better exchange both hard drives – after creating a backup. This allows for a RAID 1 system which works reliably for a long time.

## Hints for the Installation of Hard Drives with Data

**Important: If you plan to remove hard drives from one system to install them into**

### **another system, save all data onto a separate drive.**

- Hard drives which contain data and were not used in another RAID system or in another hard drive enclosure, can be used in Single Mode in most cases. If that does not work feel free to contact our service. In many cases this issue arises when the hard drives were used in a system with a controller that operates in a different way than the controller of the QB-35U31R: In these exceptional cases the data can not be used in the QB-35U31R.
- Please note: Do not format hard drives which contain important data and which do not have a backup – **even if your operating system suggests it!**
- Please note that hard drives which contain important data but can not be used in the QB-35U31R (and therefore have to be given up) have to be formatted to be incorporated into your file system. Windows only assigns drive letters when it finds a functioning partition. **You can only choose this way if you have a backup which can be copied after formatting.**

For further questions feel free to contact our service.

### **We recommend the following secure way for installing hard drives containing data:**

1. Follow the instructions above (*Setting the RAID-Mode; from 3.*) and choose SINGLE MODE but **without installing the hard drives first.**
2. Switch the device back on and check the settings.
3. **Cover the RAID-Mode-Confirmation-Key with its cap.**
4. Switch the device off with the **main switch** and **install the hard drives now.**

### **Technical Background**

The Enclosure can be set up in a RAID mode even with no hard drives installed – although it has to be connected to a PC. The important thing is that the device does not recognize hard drives after the first reboot (after shutting it down with the **RAID-Mode-Confirmation-Key**). Otherwise the partition tables would be reorganised and the data could not be reached any more.

#### **This way does only make sense if:**

- You want to use the enclosure in single-mode and be sure that you will not make a mistake during changing the mode by accidentally choosing the wrong mode
- You want to reinstall hard drives which have been working in the same enclosure in an intact RAID and had been removed to change the position of the set for example. **This procedure is dangerous for important data!** Save your data beforehand in any case and choose this way only to try to save time when copying your backup. We point out this method because it generally works but advise against using it because the hard drives may not be taken back into the composition if the hard drives are not put into the slot correctly or the controller can not

connect the hard drives for any other reason.

### **Data Loss due to Mechanical Influences, Software-Influences or Faulty Operation**

The use of a RAID-system – even of a RAID 1 – does not make a thought-through data backup unnecessary. **Important data should always be saved onto a separate drive and be stored away.** Then even an “stampede” can go through your working space and you can enjoy the sight. Software-viruses are interesting by themselves – unless it just encrypted your RAID 1 and your backup was also connected to your computer and is now also encrypted. A nice-smelling cup of coffee can destroy a system – with two systems this is much less likely. With these images we want to illustrate the term “Data Loss due to Mechanical Influences, Software-Influences or Faulty Operation” and make clear the meaning of a good backup.

### **Reading of Hard Drive Information**

To be able to judge the quality of hard drives, usually so-called SMART-techniques are used. **With RAID-systems the reading of SMART-information of the individual hard drives is not readily possible.** For the QB-35U31R the SMART-information of the first hard drive of both sets can be read.

### **Secure Removing of the Hard Drive**

The QB-35U31R is a USB hard drive enclosure and from the vantage point of many operating systems a removable disk. Please execute “Safe Hardware Removal” or “unmount” before turning off the enclosure or pulling of the data cable. Normally this “unmounting” is done automatically by shutting down your PC, Notebook, NAS, Router, Mediaplayer or Mac-Device. **In a Standby-Mode, Energy-Saving-Mode, “Quickstart-Standby” etc. a removable disk might not be “safely removed”** and disconnecting the data cable leads to data loss – even if you think your system is “off”. We recommend to uncouple USB drives from the active file system with the necessary care. This means before you shut down your PC – if you want to disconnect the cable.



# Initialising, Partitioning and Formatting

## Windows

1. Right-Click on **“This PC”** icon and select the **“Manage”** column.

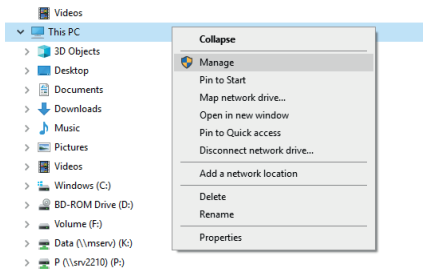

2. Select **“Disk Management”** and you will see your drive show **“Not initialised”** and **“Unallocated”**.

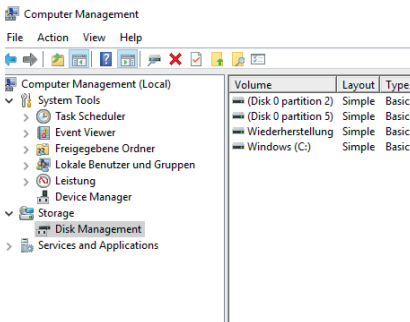

3. Right-Click on the red Symbol and select **“Initialise Disk”**.

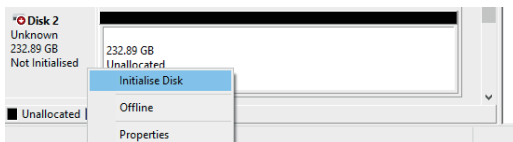

4. Select **“GPT”** mode. Then press OK button finish the initialising procedure.

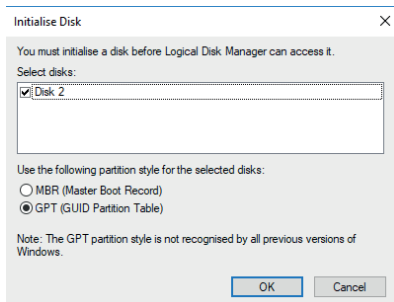

5. Right-Click on the **“Unallocated”** block and select **“New Simple Volume”**. Then follow up the dialogue box with pressing the **“Next”** button until the **“Finish”** button will start the formatting procedure.

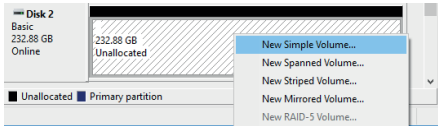

6. When formatting is completed, the external SSD will be recognized as a **“New Volume”**.

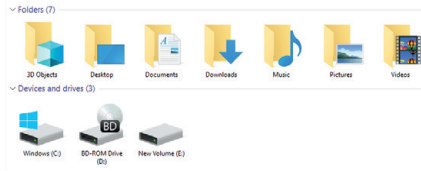

## Mac OS

1. Open Disk Utility.



2. Initialise hard drive.

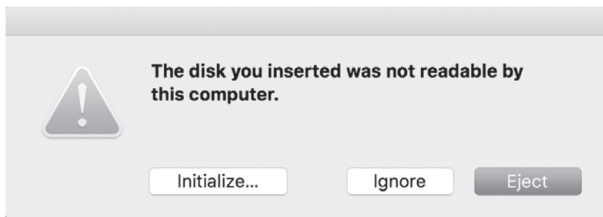

3. Choose the drive and delete it.

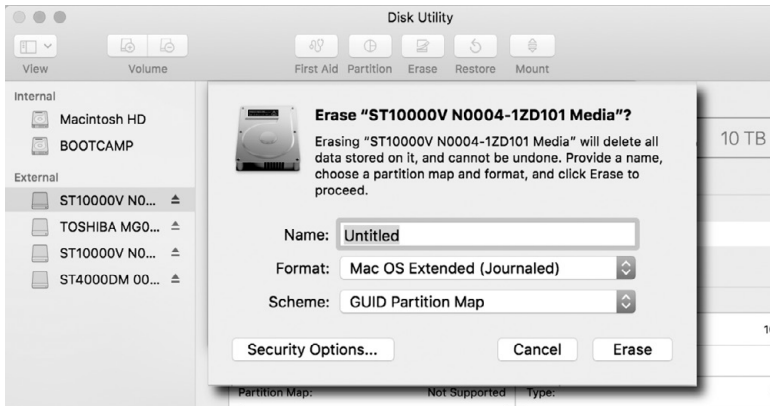

#### 4. Formatting

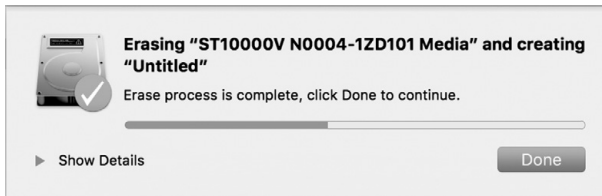

#### Please Note

- When initialising takes too long please check if the hard drive has a tight fit in the enclosure.
- If you can not activate "GPT" during initialisation, change the current RAID mode to another mode first, then back to the desired mode. Use the **RAID-Mode-Confirmation-Key**. This will ensure the drive will be rebuild and can be initialised correctly.