



Questo manuale d'istruzione è fornito da trovaprezzi.it. Scopri tutte le offerte per [Gigabyte Aorus FO32U2](#) o cerca il tuo prodotto tra le [migliori offerte di Monitor](#)



Questo manuale d'istruzione è fornito da trovaprezzi.it. Scopri tutte le offerte per [Gigabyte Aorus FO32U2](#) o cerca il tuo prodotto tra le [migliori offerte di Monitor](#)

GIGABYTE™

GAMING MONITOR

USER GUIDE

AORUS FO32U2P / AORUS FO32U2 / AORUS FO27Q3

AORUS FO32U / AORUS FO27Q2

Copyright

© 2024 GIGA-BYTE TECHNOLOGY CO., LTD. All rights reserved.

The trademarks mentioned in this manual are legally registered to their respective owners.

Disclaimer

Information in this manual is protected by copyright laws and is the property of GIGABYTE.

Changes to the specifications and features in this manual may be made by GIGABYTE without prior notice.

No part of this manual may be reproduced, copied, translated, transmitted, or published in any form or by any means without GIGABYTE's prior written permission.

- In order to assist in the use of this monitor, carefully read the User Guide.
- For more information, check on our website at:
<https://www.gigabyte.com>



The terms HDMI, HDMI High-Definition Multimedia Interface, HDMI Trade Dress and the HDMI Logos are trademarks or registered trademarks of HDMI Licensing Administrator, Inc.

CONTENTS

INTRODUCTION	4
Package Contents	4
Peeling off the Screen Protective Film Using the Peel Tab	5
Product Overview	6
Preparing your Monitor for Wall-Mounting	7
USING THE DEVICE	7
Turning the Power On/Off	7
Selecting the Input Source	8
OPERATIONS	8
Quick Switch Menu	8
Function Key Guide	10
APPENDICES	20
Specifications	20
Supported Timing List	22
Troubleshooting	24
Basic Care	24
GIGABYTE Service Information	24
SAFETY INFORMATION	25
Safety Precautions	25
Stability Hazard Precautions	26
User Comfort Recommendations	26
REGULATORY INFORMATION	27

INTRODUCTION

Package Contents

The following items come with your packaging box. If any of them is missing, please contact your local dealer.

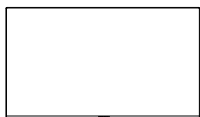

Monitor



Monitor Base



Stand



Power Cable

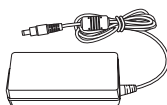

Power Adapter

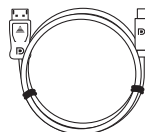

DP to Mini DP Cable
(AORUS FO32U2P)

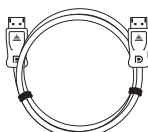

DP Cable

(AORUS FO32U2/AORUS FO27Q3/
AORUS FO32U/AORUS FO27Q2)

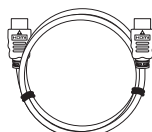

HDMI Cable

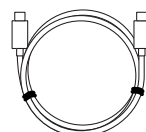

Type-C Cable
(AORUS FO32U2P)

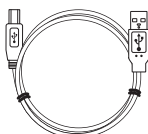

USB Cable



Quick Start Guide



Warranty Card

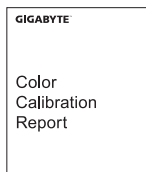

Color Calibration Report

Note:

Please keep the packaging box and packing materials for possible transportation of the monitor.

Peeling off the Screen Protective Film Using the Peel Tab

Instructions on Using the Peel Tab:

1. The peel tab is located as indicated by the red arrow in the picture below.

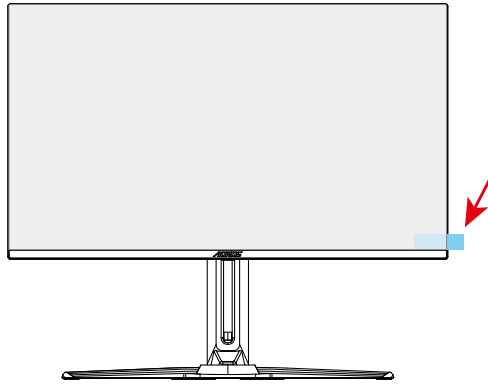

2. Remove the screen protective film in the direction indicated by the red arrow in the picture below.

Note: To prevent damage to the screen, please avoid using fingernails or any sharp objects to peel off the protective film. Instead, use adhesive tape to lift and remove the protective film.

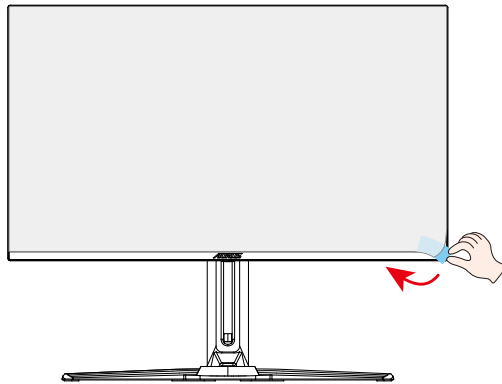

Product Overview

Front View

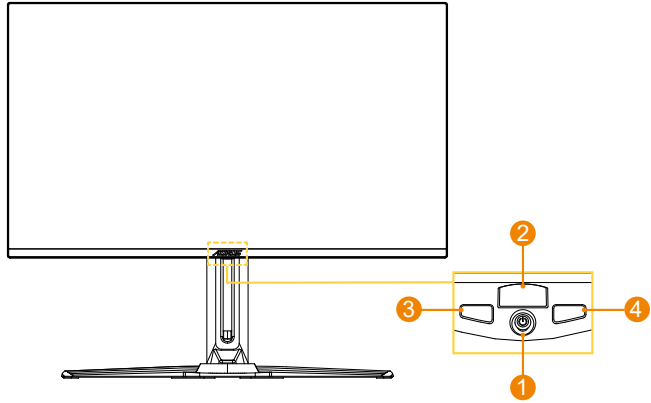

- 1 Control button
- 2 Power LED
- 3 KVM switch
- 4 Tactical switch

Rear View

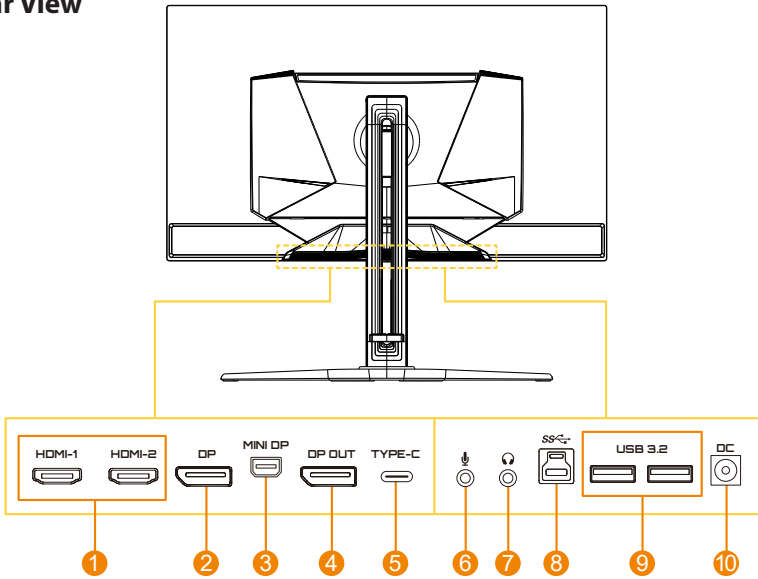

- 1 HDMI ports (x2)
- 2 DisplayPort
- 3 Mini DisplayPort (AORUS FO32U2P)
- 4 DisplayPort Out (AORUS FO32U2P)
- 5 USB Type-C port
- 6 Microphone jack
- 7 Headphone jack
- 8 USB upstream port
- 9 USB 3.2 ports (x2)
- 10 DC IN jack

Preparing your Monitor for Wall-Mounting

Note: Use only a 100 x 100 mm VESA compatible wall mount kit to mount the monitor on the wall. Refer to the installation guide included in the wall-mount bracket kit. VESA mounting screw quantity and size: 4 x M4 x 10mm minimum.

USING THE DEVICE

Turning the Power On/Off

Power On

1. Connect the power cable to the power adapter.
2. Connect the power adapter to the DC IN jack at the rear of the monitor.
3. Connect the power cable to a power outlet.
4. Press the **Control** button to turn on the monitor. The Power LED will light in white, indicating the monitor is ready to use.

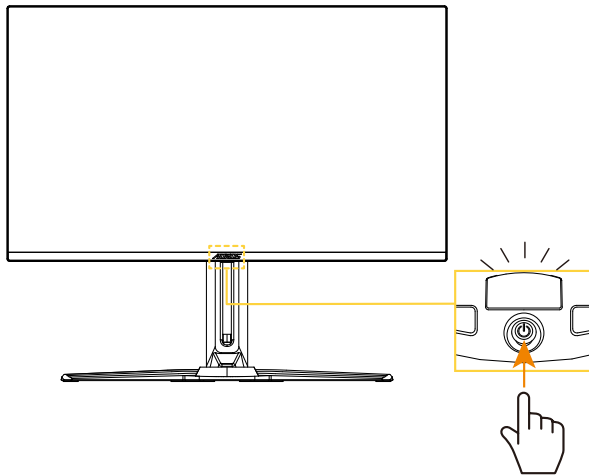

Power Off

Press the **Control** button for 2 seconds to turn off the monitor.

Note: When the **Main** menu appears on the screen, you can also turn off the monitor by moving the **Control** button down (⬇️) and selecting "Power Off". Refer to page 10.

Selecting the Input Source

1. Move the **Control** button right (↔) to enter the **Input** menu.
2. Move the **Control** button up/down (↑/↓) to select the desired input source. Then press the **Control** button to confirm.

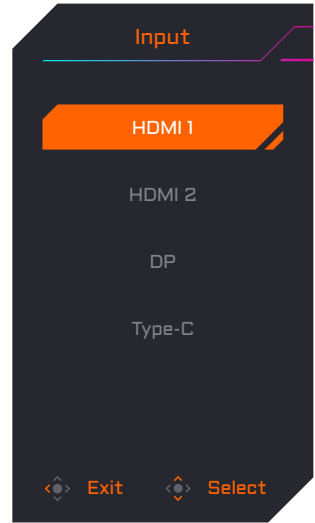

OPERATIONS

Quick Switch Menu

By default, the **Control** button has been assigned with the specific function.

Note: To change the preset functions, refer to the "Quick Switch" section on page 18.

To access the Quick Switch functions, do the following:

- Move the **Control** button up (↑) to enter the **Black Equalizer** menu.

Move the **Control** button up/down (↑/↓) to adjust the setting and press the **Control** button to confirm.

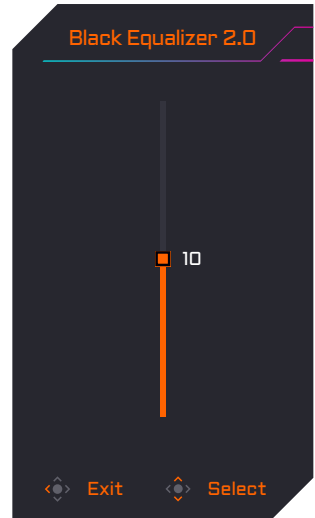

- Move the **Control** button down (⬇️) to enter the **Picture Mode** menu.

Move the **Control** button up/down (⬆️) to select the desired option and press the **Control** button to confirm.

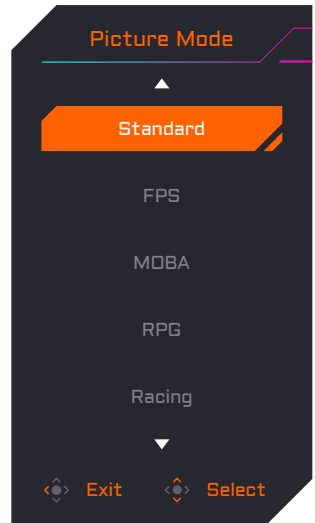

- Move the **Control** button left (⬅️) to enter the **Volume** menu.

Move the **Control** button up/down (⬆️) to select the desired volume and press the **Control** button to confirm.

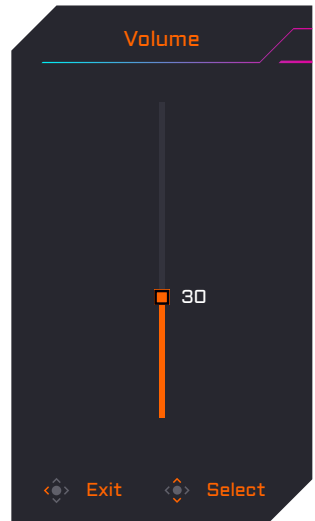

- Move the **Control** button right (⬆️) to enter the **Input** menu. Refer to the "Selecting the Input Source" section.

Note: To close the Quick Switch menu, move the **Control** button left (⬅️).

Function Key Guide

- Press the **Control** button to display the Main menu.

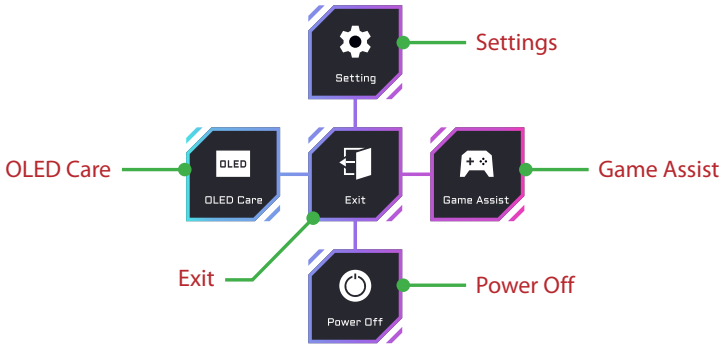

Then use the **Control** button (up/down/left/right) to select a function page and configure the related settings.

OLED Care

- When the **Main** menu appears on the screen, move the **Control** button left (◀) to enter the **OLED Care** menu.

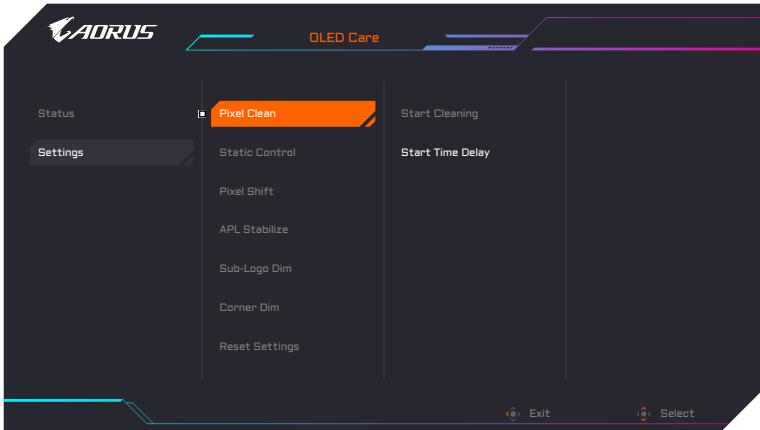

- **Status:** Shows the current status of the screen, such as screen usage time and the execution status of the Pixel Clean function.
- **Settings:** Set up the functions of OLED Care as below.
 - ▶ **Pixel Clean:** When the monitor is used for over 4 hours, it's recommended to initiate this process to clean and refresh the pixel compensation OLED screen.
 - ▶ **Static Control:** Reduces screen brightness when the image remains static.
 - ▶ **Pixel Shift:** Moves the screen content by pixels to prevent static image retention.
 - ▶ **APL Stabilize:** Adjusts the screen brightness to stabilize Average Picture Level (APL).
 - ▶ **Sub-Logo Dim:** Reduce the brightness of the taskbar and static logos to prevent image retention.
 - ▶ **Corner Dim:** Reduce the brightness at the four corners of the screen.
 - ▶ **Reset Settings:** Reset all OLED Care functions to default.

Game Assist

- When the **Main** menu appears on the screen, move the **Control** button right (◀▶) to enter the **Game Assist** menu.

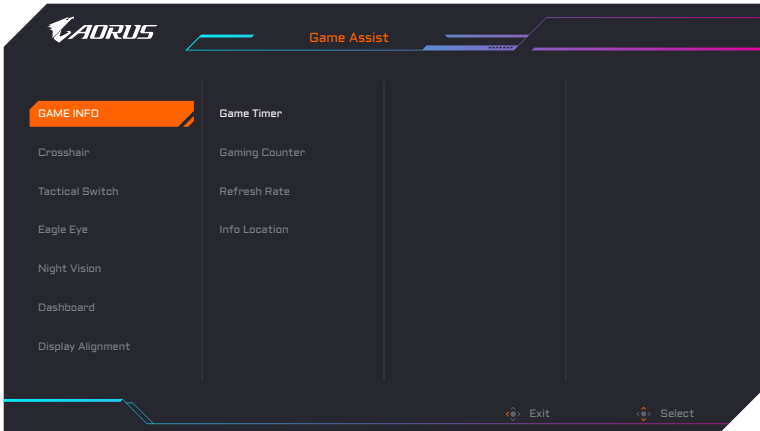

- **GAME INFO:** Enable/Disable the Gaming information shown on the screen.
- **Crosshair:** Select the type of crosshair to assist with aiming.
- **Tactical Switch:** Configure the functions of the Tactical Switch button.
 - ▶ **Resolution Switch (default):** Adjust the screen display size and resolution to specified options.
Note: Please close the full-screen display application before activate Resolution Switch.
 - ▶ **Function:** Select other functionalities for Tactical Switch. (Only one function can be selected at the time.)
- **Eagle Eye:** Enable/Disable a window which can enlarge a specific area of the screen and adjust related settings.
- **Night Vision:** Enable/Disable night vision for clarifying targets in low-light condition.
- **Dashboard:** Enable/Disable the system information of PC shown on the screen.
Note: Official software installation and a USB connection between the monitor and the PC are required.
- **Display Alignment:** Show the alignment lines to help multiple monitor settings.

Configure the Device Settings

When the **Main** menu appears on the screen, move the **Control** button up (⬆️) to enter the **Settings** menu.

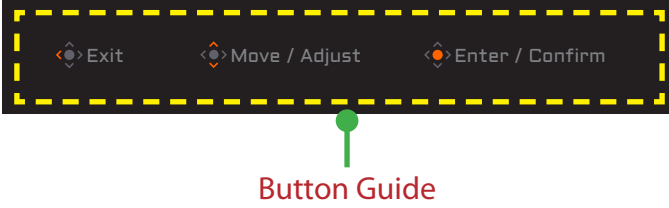

Gaming

Configure the game related settings.

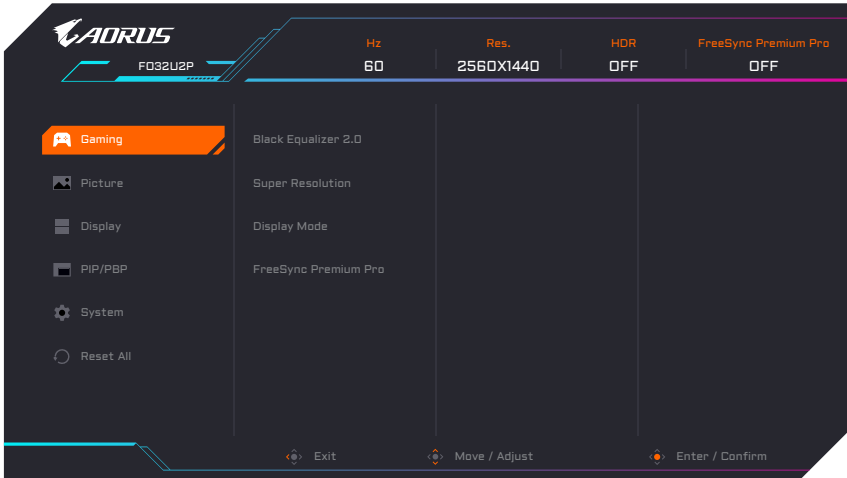

Item	Description
Black Equalizer 2.0	Adjust the visibility of dark areas in the image to enhance details and improve visibility in dark scenes.
Super Resolution	Enhance the overall image quality to provide sharper detailed visuals.
Display Mode	Select the screen aspect ratio. Note: This option is not compatible with FreeSync Premium Pro and PIP/PBP functions.
FreeSync Premium Pro	Enable/Disable receiving FreeSync signal.

Picture

Configure the image related settings.

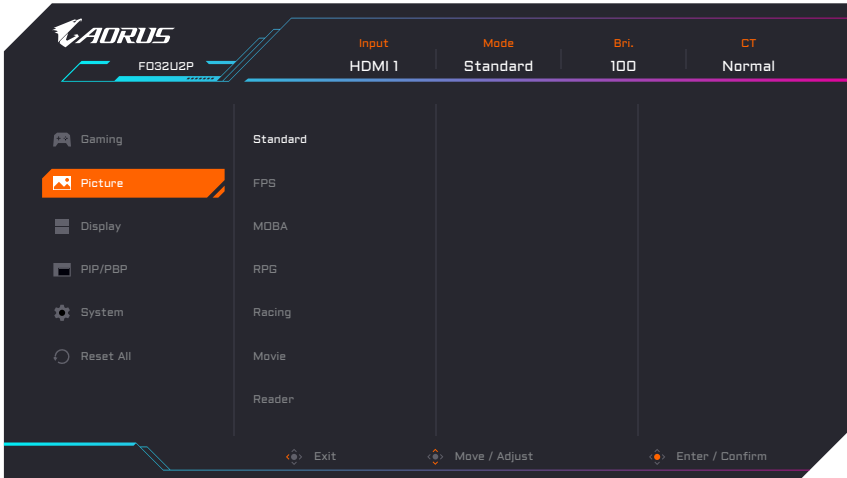

Item	Description
Picture	Select different predefined settings to optimize the visual presentation based on the content type or customize personal preferences.

Note: The Monitor uses a Low Blue Light panel and the “Standard” picture mode (Brightness : 85%, Contrast : 50%, Color Temperature : Normal) is in compliance with TÜV Rheinland Hardware Low Blue Light Certification.

Display

Configure the display screen related settings.

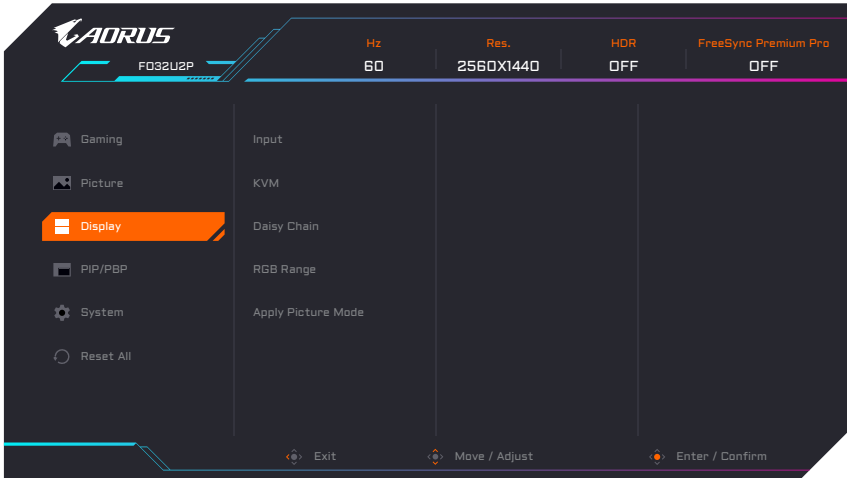

Item	Description
Input	Select the input source.
KVM	Configure the KVM functions to control two computers or devices with single keyboard and mouse.
Daisy Chain (Only for FO32U2P)	Enable/Disable daisy chain function.
RGB Range	Manually set the range of RGB or auto-detect.
Apply Picture Mode	Set the Picture mode to apply to all input sources, or the current input source.

PIP/PBP

Configure the Picture-In-Picture and Picture-By-Picture related settings.

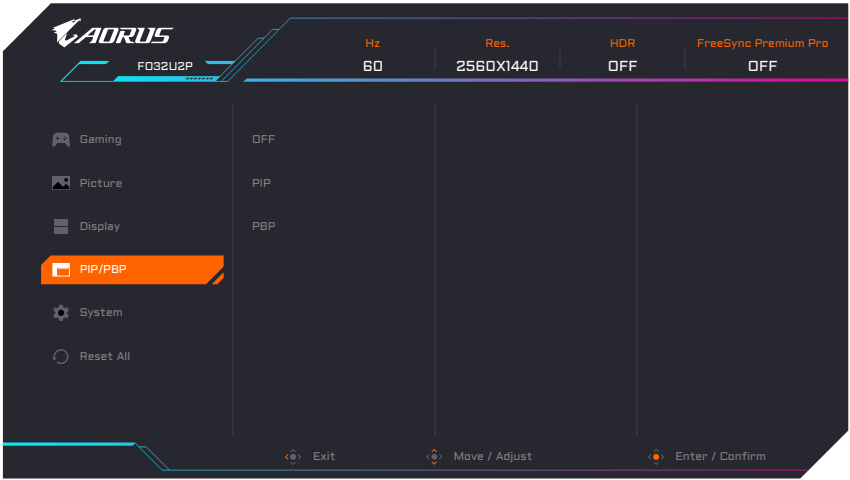

Note: PIP/PBP function cannot be enabled when receiving HDR and FreeSync signals.

System

Configure the system related settings.



Item	Description
Language	Select the desired language for the OSD menu.
Audio	Configure the audio related settings. Note: To activate the microphone function, select "Headphone+Mic (USB)" in the ESS Headset options.
Audio Mode	Select the desired audio mode.
OSD Settings	Configure the On-Screen-Display menu related settings.
Quick Switch	Assign the functions of Quick Switch to the Control button.
Other Settings	<ul style="list-style-type: none"> • Resolution Notice: Enable/Disable the resolution information when switching or restarting the screen signal source. • Input Auto Switch: Enable/Disable automatic switching to an available input source. • Auto Power OFF: Enable/Disable the timer to automatically turn off the monitor. • LED Indicator: Select the indicator type of power LED. • RGB LED: Select the pattern of the backlight LED. (Only for FO32U2P/FO32U2/FO27Q3) • Type-C Compatibility: Turn this option ON for more mobile devices compatibility. • HDMI Version: Select the HDMI version. • DP Version: Select the DisplayPort version. (Only for FO32U2P)

Other Settings
(continue)

- **HDMI-CEC:** When this function is enabled, CEC devices like PS5, XBOX can turn on the monitor when they are awakened and switch off the display when they enter either standby or off mode.
- **USB(A/C) Charge:** Enable/Disable the USB Type-A and Type-C charging function.

Reset All

Restore the monitor to its factory default settings.

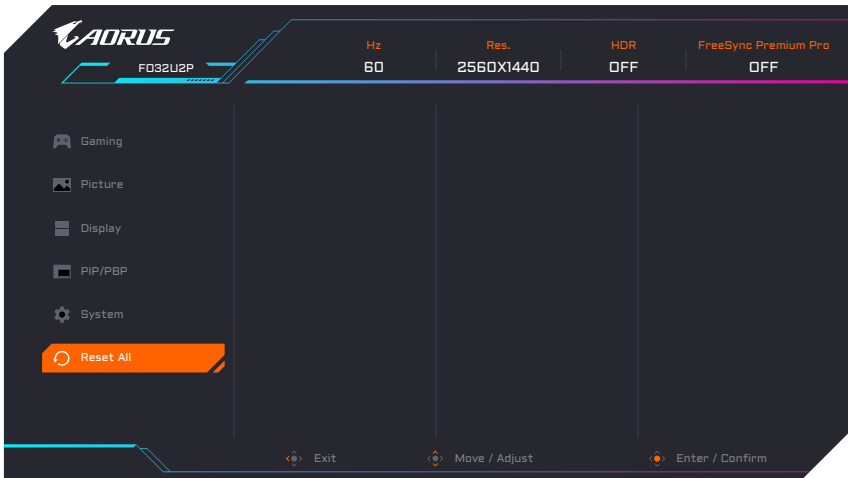

APPENDICES

Specifications

Item	Specifications		
Model	AORUS FO32U2P	AORUS FO32U2	AORUS FO27Q3
Panel Size	31.5-inch		26.5-inch
Aspect Ratio	16:9		
Resolution	3840 x 2160		2560 x 1440
LED Life	30,000 hours (min.)		
Pixel Pitch	181.4 x 181.4 um		229.2 x 229.2 um
Brightness	250 nits (Typ, SDR APL 100%); 1000 nits (Typ, HDR APL 3%)		
Contrast Ratio	1.5M:1		
Color Depth	1.07B (10 Bit)		
Active Display Area	699.48 (H) x 394.73 (V) mm		590.42 (H) x 333.72 (V) mm
Viewing Angle	178° (H)/178° (V)		
Input/Output Terminals	<ul style="list-style-type: none"> • 2 x HDMI 2.1 • 1 x Mini DP 2.1 (UHBR20) in • 1 x Full-size DP 2.1 (UHBR20) in • 1 x Full-size DP out • 1 x USB upstream • 2 x USB 3.2 (downstream, 5V/1.5A) • 1 X USB Type-C (5V/3A, 9V/3A, 15V/3A, 20V/3.25A) • 1 x Microphone • 1 x Headphone 	<ul style="list-style-type: none"> • 2 x HDMI 2.1 • 1 x DP 1.4 • 1 x USB upstream • 2 x USB 3.2 (downstream, 5V/1.5A) • 1 x USB Type-C (5V/3A, 9V/2A, 12V/1.5A, 15V/1.2A) • 1 x Microphone • 1 x Headphone 	
Power Supply	AC100 ~ 240V, 50/60Hz		
Adapter Model No.	Chicony A22-280P1A	LITEON PA-1231-26	LITEON PA-1181-76
Power Consumptions	<ul style="list-style-type: none"> • On Mode: 78W • Standby: 0.5W • Off Mode: 0.3W 	<ul style="list-style-type: none"> • On Mode: 70W • Standby: 0.5W • Off Mode: 0.3W 	<ul style="list-style-type: none"> • On Mode: 53W • Standby: 0.5W • Off Mode: 0.3W
	Note: The test conditions follow the CEC standards.		
Dimensions (W x H x D)	718.3 x 613.6 x 247.1 mm (With Stand) 718.3 x 417.5 x 57.2 mm (Without Stand)		610.3 x 532.5 x 247.1 mm (With Stand) 610.3 x 356.4 x 57.2 mm (Without Stand)
Weight	8.53 ± 0.5 kg (With Stand) 6.2 ± 0.5 kg (Without Stand)		7.2 ± 0.5 kg (With Stand) 5.0 ± 0.5 kg (Without Stand)
Temperature Range (operation)	0°C to 35°C		

Note: Specifications subject to change without notice.

Item	Specifications	
Model	AORUS FO32U	AORUS FO27Q2
Panel Size	31.5-inch	26.5-inch
Aspect Ratio	16:9	
Resolution	3840 x 2160	2560 x 1440
LED Life	30,000 hours (min.)	
Pixel Pitch	181.4 x 181.4 μ m	229.2 x 229.2 μ m
Brightness	250 nits (Typ, SDR APL 100%); 1000 nits (Typ, HDR APL 3%)	
Contrast Ratio	1.5M:1	
Color Depth	1.07B (10 Bit)	
Active Display Area	699.48 (H) x 394.73 (V) mm	590.42 (H) x 333.72 (V) mm
Viewing Angle	178° (H)/178° (V)	
Input/Output Terminals	<ul style="list-style-type: none"> • 2 x HDMI 2.1 • 1 x DP 1.4 • 1 x USB upstream • 2 x USB 3.2 (downstream, 5V/1.5A) • 1 x USB Type-C (5V/3A, 9V/2A, 12V/1.5A, 15V/1.2A) • 1 x Microphone • 1 x Headphone 	
Power Supply	AC100 ~ 240V, 50/60Hz	
Adapter Model No.	LITEON PA-1231-26	LITEON PA-1181-76
Power Consumptions	<ul style="list-style-type: none"> • On Mode: 57W • Standby: 0.5W • Off Mode: 0.3W 	<ul style="list-style-type: none"> • On Mode: 40W • Standby: 0.5W • Off Mode: 0.3W
	Note: The test conditions follow the CEC standards.	
Dimensions (W x H x D)	718.3 x 613.6 x 247.1 mm (With Stand)	610.3 x 532.5 x 247.1 mm (With Stand)
	718.3 x 417.5 x 57.2 mm (Without Stand)	610.3 x 356.4 x 57.2 mm (Without Stand)
Weight	8.30 \pm 0.5 kg (With Stand)	6.8 \pm 0.5 kg (With Stand)
	6.10 \pm 0.5 kg (Without Stand)	4.6 \pm 0.5 kg (Without Stand)
Temperature Range (operation)	0°C to 35°C	

Note: Specifications subject to change without notice.

Supported Timing List

Model	AORUS FO32U2P / AORUS FO32U2			AORUS FO27Q3		
Timing List	HDMI 1	HDMI 2	DP	HDMI 1	HDMI 2	DP
640 x 480 / 60Hz	V	V	V	V	V	V
640 x 480 / 67Hz	V	V	V	V	V	V
640 x 480 / 72Hz	V	V	V	V	V	V
640 x 480 / 75Hz	V	V	V	V	V	V
720 x 400 / 70Hz	V	V	V	V	V	V
720 x 480 / 60Hz	V	V	V	V	V	V
720 x 576 / 50Hz	V			V		
800 x 600 / 56Hz	V	V	V	V	V	V
800 x 600 / 60Hz	V	V	V	V	V	V
800 x 600 / 72Hz	V	V	V	V	V	V
800 x 600 / 75Hz	V	V	V	V	V	V
832 x 624 / 75Hz	V	V	V	V	V	V
1024 x 768 / 60Hz	V	V	V	V	V	V
1024 x 768 / 70Hz	V	V	V	V	V	V
1024 x 768 / 75Hz	V	V	V	V	V	V
1152 x 864 / 75Hz	V	V	V	V	V	V
1152 x 870 / 75Hz	V	V	V	V	V	V
1280 x 720 / 60Hz	V	V	V	V	V	V
1280 x 720 / 100Hz	V			V		
1280 x 800 / 60Hz	V	V	V	V	V	V
1280 x 960 / 60Hz	V	V	V	V	V	V
1280 x 1024 / 60Hz	V	V	V	V	V	V
1280 x 1024 / 75Hz	V	V	V	V	V	V
1440 x 480 / 60Hz	V			V		
1440 x 900 / 60Hz	V	V	V	V	V	V
1600 x 900 / 60Hz	V	V	V	V	V	V
1680 x 1050 / 60Hz	V	V	V	V	V	V
1920 x 1080 / 24Hz	V			V		
1920 x 1080 / 50Hz		V	V	V	V	V
1920 x 1080 / 60Hz				V	V	V
1920 x 1080 / 100Hz		V	V	V	V	V
1920 x 1080 / 120Hz		V	V	V	V	V
1920 x 1080 / 240Hz	V	V	V	V	V	V
1920 x 1080 / 360Hz				V	V	V
2560 x 1440 / 60Hz		V	V	V	V	V
2560 x 1440 / 120Hz	V	V	V	V	V	V
2560 x 1440 / 240Hz	V	V	V	V	V	V
2560 x 1440 / 360Hz				V	V	V
3840 x 2160 / 30Hz		V	V			
3840 x 2160 / 50Hz	V	V	V			
3840 x 2160 / 60Hz	V	V	V			
3840 x 2160 / 100Hz	V	V	V			
3840 x 2160 / 120Hz	V	V	V			
3840 x 2160 / 165Hz	V	V	V			
3840 x 2160 / 200Hz	V	V	V			
3840 x 2160 / 240Hz	V	V	V			
1280 x 1440 / 60Hz(PBP)				V	V	V
1920 x 2160 / 60Hz(PBP)	V	V	V			

Model	AORUS FO32U			AORUS FO27Q2		
Timing List	HDMI 1	HDMI 2	DP	HDMI 1	HDMI 2	DP
640 x 480 / 60Hz	V	V	V	V	V	V
640 x 480 / 67Hz	V	V	V	V	V	V
640 x 480 / 72Hz	V	V	V	V	V	V
640 x 480 / 75Hz	V	V	V	V	V	V
720 x 400 / 70Hz	V	V	V	V	V	V
720 x 480 / 60Hz	V	V	V	V	V	V
800 x 600 / 56Hz	V	V	V	V	V	V
800 x 600 / 60Hz	V	V	V	V	V	V
800 x 600 / 72Hz	V	V	V	V	V	V
800 x 600 / 75Hz	V	V	V	V	V	V
832 x 624 / 75Hz	V	V	V	V	V	V
1024 x 768 / 60Hz	V	V	V	V	V	V
1024 x 768 / 70Hz	V	V	V	V	V	V
1024 x 768 / 75Hz	V	V	V	V	V	V
1152 x 864 / 75Hz	V	V	V	V	V	V
1152 x 870 / 75Hz	V	V	V	V	V	V
1280 x 720 / 50Hz	V	V	V	V	V	V
1280 x 720 / 60Hz	V	V	V	V	V	V
1280 x 720 / 100Hz	V	V	V	V	V	V
1280 x 800 / 60Hz	V	V	V	V	V	V
1280 x 960 / 60Hz	V	V	V	V	V	V
1280 x 1024 / 60Hz	V	V	V	V	V	V
1280 x 1024 / 75Hz	V	V	V	V	V	V
1440 x 480 / 60Hz	V	V	V	V	V	V
1440 x 900 / 60Hz	V	V	V	V	V	V
1600 x 900 / 60Hz	V	V	V	V	V	V
1680 x 1050 / 60Hz	V	V	V	V	V	V
1920 x 1080 / 24Hz	V	V		V	V	
1920 x 1080 / 50Hz	V	V	V	V	V	V
1920 x 1080 / 60Hz	V	V	V	V	V	V
1920 x 1080 / 100Hz	V	V	V	V	V	V
1920 x 1080 / 120Hz	V	V	V	V	V	V
1920 x 1080 / 165Hz	V	V	V			
1920 x 1080 / 240Hz				V	V	V
2560 x 1440 / 60Hz	V	V	V	V	V	V
2560 x 1440 / 120Hz	V	V	V	V	V	V
2560 x 1440 / 165Hz	V	V	V			
2560 x 1440 / 240Hz				V	V	V
3840 x 2160 / 24Hz	V	V				
3840 x 2160 / 25Hz	V	V	V			
3840 x 2160 / 30Hz	V	V	V			
3840 x 2160 / 50Hz	V	V	V			
3840 x 2160 / 60Hz	V	V	V			
3840 x 2160 / 100Hz	V	V	V			
3840 x 2160 / 120Hz	V	V	V			
3840 x 2160 / 165Hz	V	V	V			
1280 x 1440 / 60Hz(PBP)				V	V	V
1920 x 2160 / 60Hz(PBP)	V	V	V			

Troubleshooting

Problem	Possible Solution(s)
No power	<ul style="list-style-type: none">• Make sure the power cable is properly connected to the power source and the monitor.• Check the cable and plug to make sure they are not broken.• Make sure the monitor is turned on.
No image appears on the screen	<ul style="list-style-type: none">• Make sure the monitor and the computer are properly connected and both devices are turned on.• Make sure you have selected the correct input source. Refer to page 8 or 16.
The image does not fill the entire screen	<ul style="list-style-type: none">• Try different Display Mode (aspect ratio) setting. Refer to page 14.
The colors are distorted	<ul style="list-style-type: none">• Make sure the input signal cable is properly connected.• Configure the image related settings. Refer to the "Picture" section.
No sound or volume is low	<ul style="list-style-type: none">• Make sure the headphone cable is properly connected.• Adjust the volume level. Refer to page 18.• Adjust your computer sound related settings.

Note: If the problem persists, please contact our customer service for further assistance.

Basic Care

- Wipe the screen with a soft, lint-free cloth to remove any residual dust.
- Spray or apply the cleaning fluid onto a soft cloth. Then wipe the screen gently with the damp cloth.

Note:

- Make sure that the cloth is damp, but not wet.
- When wiping, avoid applying excessive pressure on the screen.
- Acidic or abrasive cleaners can damage the screen.

GIGABYTE Service Information

More service information, please visit GIGABYTE official website.

<https://www.gigabyte.com/>

SAFETY INFORMATION

Safety Precautions

Read through the following Safety Precautions before using the monitor.

- Only use the accessories that are provided with the monitor or that which are recommended by the manufacturer.
- Keep the plastic packaging bag for the product in a place that cannot be reached by children.
- Before connecting the monitor to the power outlet, make sure that the voltage rating of the power cable is compatible with the power specification in the country where you are located.
- The power cord plug must be connected to a properly wired and grounded power outlet.
- Do not touch the plug with wet hands, as it can easily cause electric shock.
- Place the monitor in a stable and well-ventilated place.
- Do not place the monitor near any heat sources, such as electric radiators or direct sunlight.
- The holes or openings on the monitor are for ventilation. Do not cover or block the ventilation holes with any objects.
- Do not use the monitor near water, drinks, or all types of liquids. Failure to do so may result in electric shock or damage to the monitor.
- Make sure to unplug the monitor from the power outlet before cleaning.
- As the screen surface is easy to be scratched, avoid touching the surface with any hard or sharp object.
- Use a soft lint-free cloth instead of a tissue to wipe the screen. You may use a glass cleaner to clean the monitor if required. However, never spray the cleaner directly onto the screen.
- Disconnect the power cable if the monitor is not being used for a long period of time.
- Do not attempt to disassemble or repair the monitor yourself.

Stability Hazard Precautions

The product may fall, causing serious personal injury or death. To prevent injury, this product must be securely attached to the floor/wall in accordance with the installation instructions.

Many injuries, particularly to children, can be avoided by taking simple precautions such as:

- ALWAYS use stands or installation methods recommended by the manufacturer of the product set.
- ALWAYS use furniture that can safely support the product.
- ALWAYS ensure the product is not overhanging the edge of the supporting furniture.
- ALWAYS educate children about the dangers of climbing on furniture to reach the product or its controls.
- ALWAYS route cords and cables connected to your product so they cannot be tripped over, pulled or grabbed.
- NEVER place a product in an unstable location.
- NEVER place the product on tall furniture (for example, cupboards or bookcases) without anchoring both the furniture and the product to a suitable support.
- NEVER place the product on cloth or other materials that may be located between the product and supporting furniture.
- NEVER place items that might tempt children to climb, such as toys and remote controls, on the top of the product or furniture on which the product is placed.
- If the existing product is going to be retained and relocated, the same considerations as above should be applied.
- To prevent personal injury or damage to the product caused by tipping over due to earthquakes or other shocks, make sure to install the product in a stable location and take measures to prevent falling.

User Comfort Recommendations

The monitor adopts Flicker-Free technology which clears the eye visible monitor flicker and prevents users from suffering eye strain and fatigue.

The following are some tips for comfortable viewing of your monitor:

- Allow a minimum distance of 50 to 75cm (20" to 30") between your eyes and the monitor.
- A general guideline is to position the monitor such that the top of the screen is at or slightly below your eye-height when you are comfortably seated.
- Use adequate lighting for the type of work you are performing.
- Take regular and frequent breaks (at least for 10 minutes) every half-hour.
- Be sure to periodically look away from your monitor screen and focus on a far object for at least 20 seconds during the breaks.
- Eye exercise can help reduce eye strain. Repeat these exercises frequently:
(1) look up and down (2) slowly roll your eye (3) move your eyes diagonally.

This model has passed Flicker Free and Low Blue Light verification by TÜV Rheinland.

To learn more:

<https://www.gigabyte.com/tw/Support/FAQ/4310>

REGULATORY INFORMATION

United States of America, Federal Communications Commission Statement

This equipment has been tested and found to comply with the limits for a Class B digital device, pursuant to Part 15 of the FCC Rules. These limits are designed to provide reasonable protection against harmful interference in a residential installation. This equipment generates, uses and can radiate radio frequency energy and, if not installed and used in accordance with manufacturer's instructions, may cause harmful interference to radio communications. However, there is no guarantee that interference will not occur in a particular installation. If this equipment does cause harmful interference to radio or television reception, which can be determined by turning the equipment off and on, the user is encouraged to try to correct the interference by one or more of the following measures:

- Reorient or relocate the receiving antenna.
- Increase the separation between the equipment and receiver.
- Connect the equipment to an outlet on a circuit different from that to which the receiver is connected.
- Consult the dealer or an experienced radio/TV technician for help.

Canadian Department of Communications Statement

This digital apparatus does not exceed the Class B limits for radio noise emissions from digital apparatus set out in the Radio Interference Regulations of the Canadian Department of Communications. This class B digital apparatus complies with Canadian ICES-003.

Avis de conformité à la réglementation d'Industrie Canada

Cet appareil numérique de la classe B est conforme à la norme NMB-003 du Canada.

European Union (EU) CE Declaration of Conformity

This device complies with the following directives: Electromagnetic Compatibility Directive 2014/30/EU, Low-voltage Directive 2014/35/EU, ErP Directive 2009/125/EC, RoHS directive (recast) 2011/65/EU & the Directive (EU) 2015/863 amendment of Annex II.

Compliance with these directives is assessed using applicable European Harmonised Standards.

European Union (EU) RoHS (recast) Directive 2011/65/EU & the European Commission Delegated Directive (EU) 2015/863 Statement

GIGABYTE products have not intended to add and safe from hazardous substances (Cd, Pb, Hg, Cr+6, PBDE, PBB, DEHP, BBP, DBP and DIBP). The parts and components have been carefully selected to meet RoHS requirement. Moreover, we at GIGABYTE are continuing our efforts to develop products that do not use internationally banned toxic chemicals.

European Union (EU) Community Waste Electrical & Electronic Equipment (WEEE) Directive Statement

GIGABYTE will fulfill the national laws as interpreted from the 2012/19/EU WEEE (Waste Electrical and Electronic Equipment) (recast) directive. The WEEE Directive specifies the treatment, collection, recycling and disposal of electric and electronic devices and their components. Under the Directive, used equipment must be marked, collected separately, and disposed of properly.

WEEE Symbol Statement



The symbol shown below is on the product or on its packaging, which indicates that this product must not be disposed of with other waste. Instead, the device should be taken to the waste collection centers for activation of the treatment, collection, recycling and disposal procedure.

For more information about where you can drop off your waste equipment for recycling, please contact your local government office, your household waste disposal service or where you purchased the product for details of environmentally safe recycling.

End of Life Directives-Recycling



The symbol shown below is on the product or on its packaging, which indicates that this product must not be disposed of with other waste. Instead, the device should be taken to the waste collection centers for activation of the treatment, collection, recycling and disposal procedure.

CE Déclaration de Conformité

Cet appareil est conforme aux Directives de l'UE suivantes: Directive Compatibilité Electromagnétique 2014/30/UE, Directive Basse Tension 2014/35/UE, Directive 2009/125/CE en matière d'écoconception, la Directive RoHS II 2011/65/UE & Directive (UE) 2015/863 modifiant l'Annexe II.

La conformité à ces directives est évaluée sur la base des normes européennes harmonisées applicables.

CE-Konformitätserklärung

Dieses Produkte erfüllen folgenden EU-Richtlinien: EMV-Richtlinie 2014/30/EU, Niederspannungsrichtlinie 2014/30/EU, Ökodesign-Richtlinie 2009/125/EC, RoHS-Richtlinie 2011/65/EG erfüllt und die Richtlinie (EU) 2015/863 zur Änderung von Anhang II.

Die Konformität mit diesen Richtlinien wird anhand der anwendbaren harmonisierten Europäischen Normen bewertet.

CE Declaración de conformidad

Este producto cumplen con las siguientes Directivas de la Unión Europea: Directiva EMC 2014/30/EU, Directiva de bajo voltaje 2014/35/EU, Directiva de Ecodiseño 2009/125/CE, Directiva RoHS 2011/65/EU y la Directiva (EU) 2015/863 por la que se modifica el Anexo II. El cumplimiento de estas directivas se evalúa mediante las normas europeas armonizadas.

CE declaração de conformidade

Este produto estão em conformidade com das seguintes Diretivas UE: Diretiva Baixa Tensão 2014/35/UE; Diretiva CEM 2014/30/UE; Diretiva Conceção Ecológica 2009/125/CE; Diretiva RSP 2011/65/CE e a Diretiva (UE) 2015/863 que altera o Anexo II.

A conformidade com estas diretivas é verificada utilizando as normas europeias harmonizadas.

CE Dichiarazione di conformità

I prodotti sono conformi con una o più delle seguenti Direttive UE, come applicabile: Direttiva EMC 2014/30/UE, Direttiva sulla bassa tensione 2014/35/UE, Direttiva Ecodesign EMC 2009/125/CE, Direttiva RoHS 2011/65/UE e Direttiva (UE) 2015/863 recante modifica dell'Allegato II.

La conformità con tali direttive viene valutata utilizzando gli Standard europei armonizzati applicabili.

CE Deklaracja zgodności

Urządzenie jest zgodne z następującymi dyrektywami: Dyrektywa kompatybilności elektromagnetycznej 2014/30/UE, Dyrektywa niskonapięciowej 2014/35/UE, Dyrektywa ErP 2009/125/WE, Dyrektywa RoHS 2011/65/UE i Dyrektywa (UE) 2015/863 zmieniająca Załącznik II. Zgodność z tymi dyrektywami oceniono za pomocą mających zastosowanie zharmonizowanych norm europejskich.

CE Prohlášení o shodě

Toto zařízení splňuje požadavky Směrnice o Elektromagnetické kompatibilitě 2014/30/EU, Směrnice o Nízkém napětí 2014/35/EU, Směrnice ErP 2009/125/ES, Směrnice RoHS 2011/65/EU a Směrnice (EU) 2015/863 kterou se mění Příloha II.

Shoda s těmito směrnici je posuzována v souladu s příslušnými evropskými harmonizačními standardy.

CE Megfelelőségi nyilatkozata

A termék megfelelnek a következőkről szóló egy vagy több Európai Unió irányelvnek: EMC irányelv 2014/30/EU, Kiszárazósági villamos berendezésekre vonatkozó irányelv 2014/35/EU, Környezetbarát tervezésről szóló irányelv 2009/125/EZ, Direktívi RoHS irányelv 2011/65/EU és Direktívi (EU) 2015/863 o izmjeni Priloga II.

A fenti irányelveknek történő megfelelés megállapítása a vonatkozó harmonizált európai szabványok segítségével történik.

CE Δήλωση συμμόρφωσης

Είναι σε συμμόρφωση με τις διατάξεις των παρακάτω Οδηγιών της Ευρωπαϊκής Κοινότητας: Οδηγία 2014/30/ΕΕ σχετικά με την ηλεκτρομαγνητική συμβατότητα, Οδηγία χαμηλή τάση 2014/35/ΕU, Οδηγία 2009/125/ΕΚ σχετικά με τον οικολογικό σχεδιασμό, Οδηγία RoHS 2011/65/ΕΕ και Οδηγία (ΕΕ) 2015/863 για την τροποποίηση του παραρτήματος II.

Η συμμόρφωση με αυτές τις οδηγίες αξιολογείται χρησιμοποιώντας τα ισχύοντα εναρμονισμένα ευρωπαϊκά πρότυπα.

CE Declarație de conformitate

Acest aparat este conform cu: Compatibilitatea electromagnetică Directiva 2014/30/UE, Directiva privind echipamentele de joasă tensiune 2014/35/UE, Directiva privind proiectarea ecologică 2009/125/CE, Directiva RoHS 2011/65/UE & Directiva (UE) 2015/863 de modificare a Anexei II.

Conformitatea cu aceste directive este evaluatăutilizând Standardele europene armonizate aplicabile.

CE Overensstemmelseserklæring

Denne enhed overholder stk.: elektromagnetisk kompatibilitet Direktivet 2014/30/EC, LVD Direktivet 2014/35/EC, miljøvenligt design Direktivet 2009/125/EF, RoHS Direktivet 2011/65/EU & Direktivet (UE) 2015/863 om ændring af Bilag II.

Overholdelse af disse direktiver vurderes med gældende europæiske harmoniserede standarder.

CE Vyhlásenie o zhode

Tento produkt spĺňajú najmenej jednu z nasledujúcich platných smerníc EÚ: Smernica 2014/30/ES pre elektromagnetickú kompatibilitu, Smernica 2014/35/ES o Nízkom Napätí (LVD), Smernica 2009/125/ES pre ekodizajn, Smernica RoHS 2011/65/EÚ & Smernica (EÚ) 2015/863 ktorou sa mení Príloha II.

Zhoda s týmito smernicami sa hodnotí použitím príslušných európskych harmonizovaných štandardov.

CE Vaatimustenmukaisuusvakuutus

Tämä tuote on näiden EU-direktiivien mukainen: EMC Direktiivi 2014/30/EY, LVD Direktiivi 2014/35/EY, Ekologista suunnittelua koskeva Direktiivi 2009/125/EY, RoHS Direktiivi 2011/65/EU & Direktiivi (EU) 2015/863 Liitteen II muuttamisesta.

Yhdenmukaisuus näiden direktiivien kanssa on arvioitu käyttäen soveltuvia eurooppalaisia harmonisoituja standardeja.

CE Försäkran om överensstämmelse

Denna produkt uppfyller följande direktiv: Direktivet om Elektromagnetisk kompatibilitet 2014/30/EU, Lågspänningsdirektivet 2014/35/EU, Ekodesigndirektiv 2009/125/EG, Direktiv RoHS 2011/65/EU mid Direktiv (EU) 2015/863 om ändring av Bilaga II.

Överensstämmelse med dessa direktiv bedöms med hjälp av tillämpliga europeiska harmoniserade standarder.

CE Conformiteitsverklaring

Dit product voldoet aan de volgende van toepassing zijnde EU-richtlijnen: EMC Richtlijn 2014/30/EG, Laagspanningsrichtlijn 2014/35/EU, Ecodesign-richtlijn 2009/125/EG, G RoHS Richtlijn 2011/65/EG & Richtlijn (EU) 2015/863 tot wijziging van Bijlage II.

Het voldoen aan deze richtlijnen is beoordeeld met de van toepassing zijnde Europese geharmoniseerde normen.

CE Vyhlásenie o zhode

Toto zariadenie vyhovuje nasledujúcim smerniciam: Smernica elektromagnetickej kompatibility 2014/30/EÚ, Smernica o nízkom napätí 2014/35/EÚ, Smernica o výrobkoch týkajúcich sa energie 2009/125/ES, Smernica RoHS 2011/65/EÚ & Smernica (EÚ) 2015/863 ktorou sa mení príloha II.

Zhoda s týmito smernicami sa hodnotí použitím príslušných európskych harmonizovaných štandardov.

India RoHS

This product complies with the "India E-waste (Management and Handling) Rule 2011" and prohibits use of lead, mercury, hexavalent chromium, polybrominated biphenyls or polybrominated diphenyl ethers in concentrations exceeding 0.1 weight % and 0.01 weight % for cadmium, except for the exemptions set in Schedule 2 of the Rule.

Japan Class 1 Equipment Statement

安全にご使用いただくために

接地接続は必ず電源プラグを電源につなぐ前に行ってください。

また、接地接続を外す場合は、必ず電源プラグを電源から切り離してから行って下さい。

- 製品には、同梱された電源コードセットを使用すること
- 同梱された電源コードセットは、他の製品に使用しないこと

Japan VCCI Class B Statement

クラスB VCCI 基準について

この装置は、クラス B 情報技術装置です。この装置は、家庭環境で使用することを目的としていますが、この装置がラジオやテレビジョン受信機に近接して使用されると、受信障害を引き起こすことがあります。

取扱説明書に従って正しい取り扱いをして下さい。

VCCI-B

China RoHS Compliance Statement

中国《废弃电器电子产品回收处理管理条例》提示性说明

为了更好地关爱及保护地球·当用户不再需要此产品或产品寿命终止时·请遵守国家废弃电器电子产品回收处理相关法律法规·将其交给当地具有国家认可的回收处理资质的厂商进行回收处理。

环保使用期限

Environment-friendly use period



此标识指期限（十年）·电子电气产品中含有的有害物质不会发生外泄或突变·电子电气产品用户正常使用该电子电气产品不会对环境造成严重污染或对其人身、财产造成严重损害的期限。

产品中有害物质的名称及含量:

部件名称	有害物质					
	铅 (Pb)	汞 (Hg)	镉 (Cd)	六价铬 (Cr ⁶⁺)	多溴联苯 (PBB)	多溴二苯醚 (PBDE)
印刷电路板及其电子组件	×	○	○	○	○	○
面板	×	○	○	○	○	○
外壳	○	○	○	○	○	○
外部信号连接头及线材	×	○	○	○	○	○

本表格依据 SJ/T 11364 的规定编制。

○：表示该有害物质在该部件所有均质材料中的含量均在 GB/T 26572 规定的限量要求以下。

×：表示该有害物质至少在该部件的某一均质材料中的含量超出 GB/T 26572 规定的限量要求。