



Questo manuale d'istruzione è fornito da trovaprezzi.it. Scopri tutte le offerte per [Gima Nebulizzatore Mesh](#) o cerca il tuo prodotto tra le [migliori offerte di Elettromedicali](#)



Questo manuale d'istruzione è fornito da trovaprezzi.it. Scopri tutte le offerte per [Gima Nebulizzatore Mesh](#) o cerca il tuo prodotto tra le [migliori offerte di Elettromedicali](#)



PROFESSIONAL MEDICAL PRODUCTS

Gima S.p.A.
Via Marconi, 1 - 20060 Gessate (MI) Italy
gima@gimaitaly.com - export@gimaitaly.com
www.gimaitaly.com

NEBULIZZATORE MESH MESH NEBULIZER NÉBULISEUR MESH MESH-INHALATOR NEBULIZADOR MESH NEBULIZADOR MESH

Manuale d'uso - User manual
Manuel de l'utilisateur - Gebrauchsanweisung
Guía de Uso - Guia para utilização



ATTENZIONE: Gli operatori devono leggere e capire completamente questo manuale prima di utilizzare il prodotto.
ATTENTION: The operators must carefully read and completely understand the present manual before using the product.
AVIS: Les opérateurs doivent lire et bien comprendre ce manuel avant d'utiliser le produit.
ACHTUNG: Die Bediener müssen vorher dieses Handbuch gelesen und verstanden haben, bevor sie das Produkt benutzen.
ATENCIÓN: Los operadores tienen que leer y entender completamente este manual antes de utilizar el producto.
ATENÇÃO: Os operadores devem ler e entender completamente este manual antes de usar o produto.

REF 28066 / NE-M01

IP22 -40°C 55°C 500 hPa 1060 hPa 5% 96%

CONTEC MEDICAL SYSTEMS CO., LTD
No.112 Qinhuang West Street,
Economic & Technical Development Zone, Qinhuangdao,
Hebei Province, PEOPLE'S REPUBLIC OF CHINA
Made in China

Shanghai International Holding Corp. GmbH (Europe)
Eiffestrasse 80, 20537, Hamburg, Germany



Statements

- Thanks for purchasing the product.
- To ensure correct usage, please read the User Manual carefully before using this product.
- Please keep the User Manual properly where convenient to read.
- The company takes no responsibilities or provides no free maintenance for any abnormal phenomena or damage due to users not following the User Manual to use, maintain and store.
- The company reserves final explanation right to this manual.

Chapter 1

PRECAUTIONS

Please read the user manual carefully in order to ensure safe use.



Warning

- Prompting the operations with danger or unsafe, if continue operating, it may cause death, severe body injury or property loss.

Attention

- Emphasizing important notices, instructions or explanations for better use.



Warnings

- Please follow doctors' advice about medication species, dosage and usage. Otherwise it may cause symptomatic deterioration.
- Please follow the specified operation methods in the user manual, otherwise it may cause operation failure.
- The accessories of device are designed for single use, do not reuse the accessory otherwise it may cause cross infection.
- For the first time of using this device or if medication cup is unused for a long time, medication cup and mask must be cleaned and disinfected. Otherwise, it may cause bacterial reproductive infection.
- Each user must use the accessory separately, otherwise it may cause cross infection.
- Please clean the accessories after disinfection, otherwise patient may inhale the residual disinfectant, which may cause symptomatic deterioration.
- Used medication can't be reused, please change new medication for every treatment. Otherwise patient may be infected by varieties of bacteria, causing symptomatic deterioration.
- Do not use the device to inhale water, otherwise it may cause symptomatic deterioration.
- Do not use the device at ambient temperature above 40°C. Otherwise it may cause nasal mucosa injury or device failure.
- Do not clean the main body in water or drop it into water or store the device in humid environment. Otherwise it may cause device failure.
- Please clean the device after use, and dry it immediately after cleaning. Otherwise patient may be infected by varieties of bacteria.
- Please keep the device out of the reach of children and people with mental illness. Otherwise it may cause danger of swallowing small parts.
- Do not use the device near flammable or explosive gas or anesthetic mixture. Otherwise it may cause personal injury.
- Do not wrap the power cord around children's neck or other sensitive areas, or it may cause asphyxia.
- The mask of this equipment is made of PVC material. The material passed the relevant test. After assessment, there is no unacceptable risks.
- This device should not be used where it is difficult to disconnect the power supply device.
- If the storage temperature is lower or higher, please leave the equipment in normal working environment for more than 1 hour, until it is ready for intended use.
- It is not allowed to modify the equipment or it may cause damage to the equipment

Attention

- If the device can't shutdown automatically when medication is exhausted, please immediately press the "ON/OFF" button to turn off, in order to avoid damage to the nebulizing sheet. Refer to Chapter 6 Troubleshooting.
- Clean medication cup after each use. Otherwise, the device will not work normally.
- When cleaning medication cup, do not directly place the device under tap water to prevent water from entering the device.
- Do not use this product near high-frequency electromagnetic transmitters and other high-frequency electronic products.
- Keep the device vertical as much as possible during use.
- Prevent the main unit and medication cup from falling or being subjected to severe impact.
- Do not touch the metal mesh of nebulizing sheet with a cotton swab or other sharp objects. Otherwise, the device may not work.
- This product is subject to the guidance of a doctor. Patient who has sensitive parts with contusion, burns, inflammation, and facial/oral trauma should avoid using the device. If you feel uncomfortable during use, please stop using immediately and consult a doctor.
- Do not mix different types of dry batteries.
- Ensure that a guardian is present when used by children.
- Do not store or carry the device with medication in the medication cup.
- Disposal of waste main parts and accessories shall follow the local government regulations.
- The use of this product is different from the laryngeal and nasal mucosa humidification equipment.
- This product cannot be used in respiratory anesthesia systems and ventilator systems.
- Please take batteries out if you won't use the device for long time.
- The device service life is 3 years (excluding consumables).
- The accessories are disposable, the device is sterilized by ethylene oxide, please check the packaging carefully before use, stop using it and contact with suppliers if there is obvious damage.
- If necessary, provide circuit diagrams, components lists and necessary information for maintenance, please contact with suppliers.

Chapter 2

GENERAL

2.1 Function and application

The nebulizer can atomize medication into a mist of microscopic droplets, which can be easily inhaled into respiratory system along with breathing, achieving therapeutic effect for respiratory diseases such as acute inflammation of the upper respiratory tract, acute and chronic tracheitis, bronchitis and swelling and pain in throat, etc.

Contraindications:

The patients with bronchial asthma or acute emphysema are not recommended to use the device, please follow the doctor's advice.

2.2 Features

Power supply: DC 5 V or 2 "AA" alkaline batteries

Input power: <3 VA

Nebulization rate: ≥ 0.25 mL/min

Noise: ≤ 50 dB

Equivalent volume particle diameter distribution: the occupation of small atomized particles (diameter < 5 μ m) is no less than 90%.

Type of protection against electric shock: Class II

Degree of protection against electric shock: type BF applied part

Degree of protection against ingress of liquid: IP22

Note: please choose the power adapters manufactured by qualified companies(input: AC100-240V, 50Hz / 60Hz, output: DC5V, 1A).

The voltage of 2 "AA" alkaline batteries is DC3V.

2.3 Operational environment

Temperature: 5°C~40°C

Humidity: 15%~90%

Atmospheric pressure: 700hPa~1060hPa

Attention: This product is not suitable for use in strong electromagnetic interference environments (such as various medium/high frequency therapeutic instruments, transformers, large electrical cabinets, radio and television transmission towers, other radio frequency transmitting equipment, and other electrical appliances or medical equipment which may generate interference).

2.4 Principles

Principle of nebulization

The high-frequency vibration of piezoelectric ceramic plate directly leads to the deformation of microplate, making medication in contact with the microplate extruded from it to form a mist spray effect. The mesh nebulizer is applicable for use in hospital, clinic and family.

Principle of treatment

Respiratory system is an open system. The atomized medication, after inhalation, can be directly adsorbed on patient's oral cavity, throat, trachea, bronchus and pulmonary alveoli, etc., through its mucous membrane absorption to achieve the purpose of treatment.

Chapter 3

PRODUCT COMPOSITION

Component description:

The nebulizer consists of main unit, medication cup, mask and the power adapters (optional).

Nebulizer:

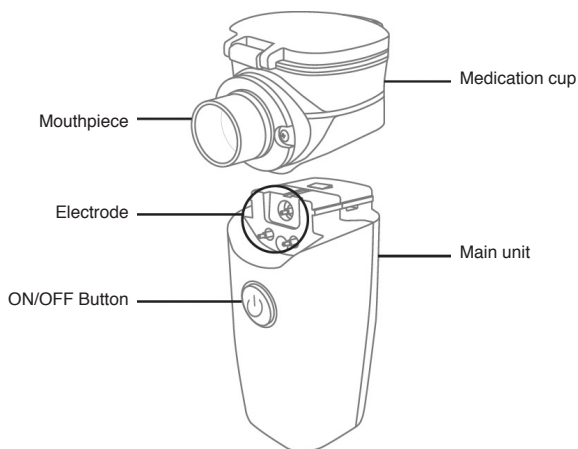

Accessories:

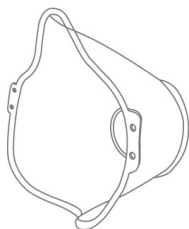

Adult mask

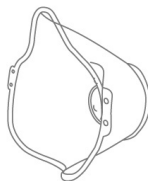

Child mask

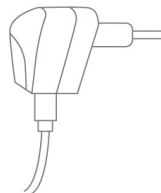

The power adapters (optional)

Chapter 4

HOW TO USE

4.1 Assembly

1. Remove all packages

Attention: For the first time of use, please clean and disinfect the device before use.

2. Assembly of nebulizer

1) Install medication cup to the main unit by pushing it towards the main unit.

Attention: When installing medication cup to the main unit, be sure to install it properly until clasp sound is heard. Otherwise it may cause electrode conduction failure, then the device cannot atomize normally.

2) Remove medication cup from main unit. Press and hold the "PUSH" button on main unit, and push medication cup away from the main unit.

Attention: In order to avoid device damage, please press the "PUSH" button first when removing medication cup.

→ Push

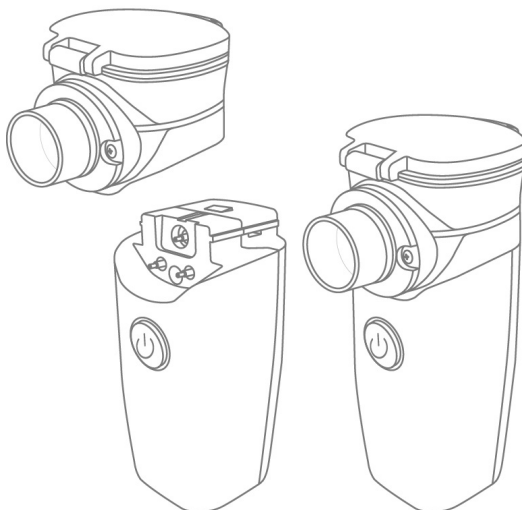

← Push away

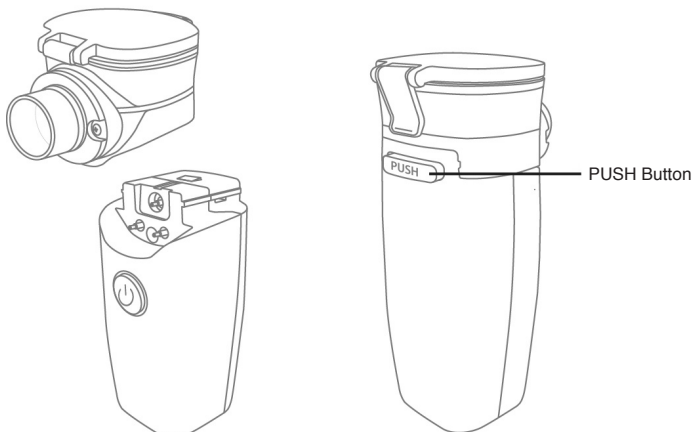

3. Assembly of battery

- 1) Open the battery cover.

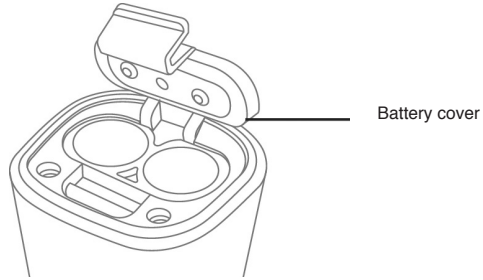

- 2) Insert the 2 "AA" alkaline batteries according to the polarity label on battery cover.

Attention: Do not reverse the battery. Insert the battery exactly following the label of "+" "-" on the battery cover.

- 3) Close the battery cover.

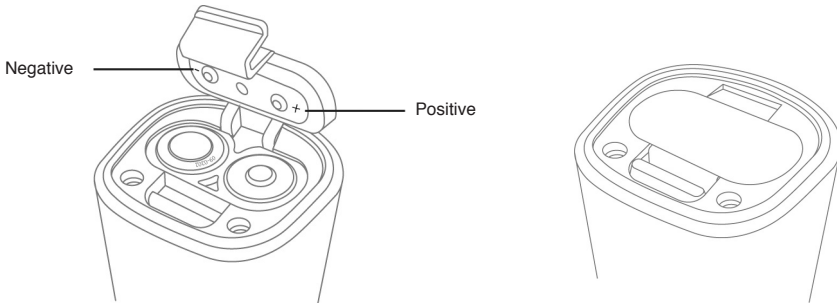

Battery service life and replacement:

- 1) When replacing the battery, make sure there is no medication or water in medication cup. If yes, please remove the medication cup first.
- 2) When the orange indicator is light, the device can also work for a while, but it is recommended to replace the new batteries.
- 3) Usually two new "AA" alkaline batteries can work continuously 1 hour under normal working situations.

Attention:

Please do not mix batteries of different manufacturers or models, otherwise the battery life will be affected.

Remove the batteries if the device won't be used for long time.

4.2 Operations for treatment use

Preparations before use:

1. Remove medication cup, please clean and disinfect it before use.
2. Infusion of medication: Open the cup lid, decant medication into medication cup, as shown on the right side:

Attention:

- 1) Before using any pharmaceutical products or medicines, please consult your doctor to ensure that you are using the product correctly.
- 2) Do not use medications having high concentrations, high viscosity, oily medicines, suspended or volatile liquid medicine, doing so may lead to abnormal atomizing.
- 3) It is recommended not to exceed the capacity of medication cup. If medication cup is filled with medication, be sure to cover the cup lid to prevent leakage. Medication in the cup should not be less than 2mL (The maximum capacity for the medication cup is 10mL).

3. Close the cup lid.

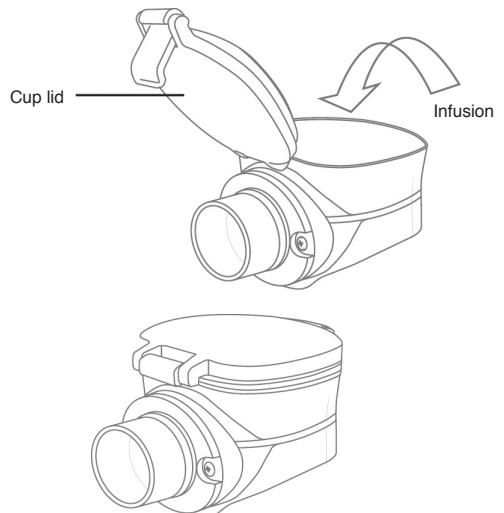

4. Install medication cup to main unit.
5. Assemble the mask, as shown to the side:

Operation method:

1. Turn on the power: Press "ON/OFF" button for more than 1 second, power indicator (green) lights and device starts atomizing.

Attention:

If medication cup is not loaded with any medication, the device will automatically shutdown after power Indicator lights up about 1s.

After startup, the quantity of medication mist may change at the beginning of device working, which is a normal phenomenon.

2. Inhalation: Hold the device in hand, put on the mask, slowly inhale the medication mist.

Attention:

- 1) The angle of inclination should be within 45° during nebulizing.
- 2) During use, please do not strongly shake the device to prevent abnormal use.
- 3) Duration of each inhalation should be no more than 20 minutes.
- 4) Nebulizing treatment is easy and comfortable, if you feel uncomfortable during use, please stop the treatment.

3. Turn off the power. When the treatment is over, and medication almost runs out, the nebulizing sheet will generate a high-frequency sound, and then the device automatically turns off. If you need to shut the device down during use, please press the "ON/OFF" button for more than 1 second.

Attention:

At the end of treatment, it is normal that a little medication remains left in medication cup after automatic shutdown.

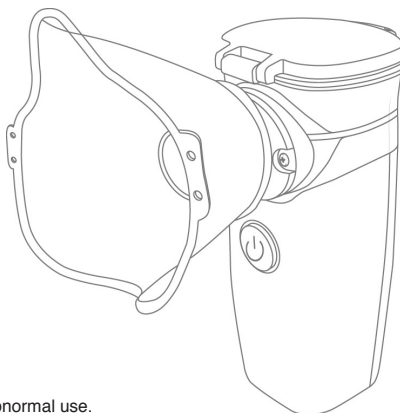

Chapter 5

MAINTENANCE, TRANSPORT AND STORAGE

5.1 Cleaning and disinfection

Clean and disinfect the device after each use. If the device is not cleaned, the nebulizing will be affected because of drying and coagulation of medication.

1. Remove medication cup, accessory and batteries from the main unit.
2. Open the cup lid and discard residual medication.
3. Add 75% ethanol solution in medication cup, cover the cup lid then leave for at least 10mins; it is advisable to gently shake it for better disinfection.
4. Immerse the accessories to be disinfected into a container with ethanol solution, and put a lid on the container. Use 75% ethanol solution soaking for 10mins or longer.
5. Discard the disinfectant in medication cup, take accessories out from the disinfectant; clean the medication cup and accessories with clear-water repeatedly.
6. Fill medication cup with clear-water, assemble it to the main unit, let the device work 10mins in order to clean the nebulizing sheet.
7. After cleaning, use new medical gauze to wipe away the water, and fully dry,
8. Use 75% medicinal alcohol to wipe the surface of main unit, then air-dry or wipe-dry with a clean, soft cloth.
9. After all steps above, store the main unit, medication cup and accessories in a dry, clean place.

Attention:

Do not throw medication cup and accessories into boiling water for disinfection, otherwise the part may be deformed. Do not put them in a microwave oven for drying.

The parts disinfected with disinfectant must be fully cleaned, or the residual disinfectant may cause symptomatic deterioration.

5.2 Medication cup replacement

The nebulizing sheet is a kind of consumable. In general, the service life of the atomizer is about six months (20 minutes per time, three times a day).

Its service life depends on the use, medication, and the degree of cleaning. If no atomizing or little atomizing appears when the device is working, please replace medication cup in time. (If you need to purchase medication cup, please contact the dealer.)

5.3 Transport and storage

Transport and storage environment:

Temperature: -40°C~+55°C

Relative humidity: 5%~96%

Atmospheric pressure: 500 hPa ~ 1060 hPa

Requirements for transport and storage:

- No corrosion gas and well-ventilated room.
- Keep the device out of the reach of children.
- Do not store the device in conditions such as direct sunlight, high temperature, humidity, dust or water infiltrations, etc.
- Keep the device away from sloping surfaces, vibrations or shocks.
- Transportation adopts general transportation means or follows the contract requirements. Avoid violent shock, vibration, rain and snow splash during the process of transportation.

5.4 Pollution-free disposal and recycling















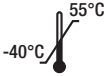





The service life of product is 3 years. If the device exceeds the period of use, it must be discarded. Please contact the manufacturer or distributor for more information.

- 1) The atomizer out of use can be sent back to the manufacturer or distributor for proper recycling.
- 2) Used parts can be returned to the manufacturer or distributor for disposal, or treated in accordance with relevant laws and regulations.

Chapter 6 TROUBLESHOOTING

Problems	Reason analysis	Solutions
The device can't startup.	Battery is not well installed.	Check the installation of battery, and reinstall the batteries.
No atomizing or little atomizing appears when device working.	Medication cup is not well installed.	Check the installation of medication cup, and reinstall it.
	No medication in medication cup.	Trickle medication into medication cup, remember not to exceed its maximum capacity.
	Improper medication.	Consult a doctor about whether the medication is suitable for the device.
	The nebulizing sheet is dirty.	Clean medication cup.
There is water around the nozzle of nebulizer.	Due to temperature differences, the temperature of medication cup surface is relatively low, medication mist comes in contact with the nozzle, then condenses into water droplets.	Remove medication cup, pour the water out.
After startup, power indicator lights about 1s, then immediately goes out.	Medication cup is not well installed.	Install medication cup once again.
	Medication cup is not loaded with any medication.	Put the medication into medication cup after consulting your doctor.
After turning on the device, the power indicator lights once, then it is out immediately or the device cannot work normally.	The battery had run down.	Replace the batteries immediately.
Nebulizer, doesn't automatically shutdown when medication is used up.	Medication may generate bubbles in medication cup.	Press "ON/OFF" button to turn off the device, and clear up the bubbles.
	Medication may be stuck on the nebulizing sheet.	Press "ON/OFF" button to turn off the device, and clean medication cup.
	The electrodes contacting with the medication cup may be dirty.	Press "ON/OFF" button to turn off the device, and clean the electrodes.
If the device still can't work normally after using all methods above, please contact our after-sales service.		

Chapter 7 MEANING OF SYMBOLS

	Keep in a cool, dry place		Stand-by		Product code
	Keep away from sunlight		Store between -40 and 55°C		Lot number
	Fragile, handle with care		Date of manufacture		Serial number
	Follow instructions for use		Medical Device complies with Directive 93/42/EEC		Caution: read instructions (warnings) carefully
IP22	Covering Protection rate		Type BF applied part		Manufacturer
	WEEE disposal		Class II applied		Authorized representative in the European community
	Atmospheric pressure for transportation: 500 hPa~1060 hPa		Humidity range for transportation: 5%~96%		This way up

Chapter 8 PACKING LIST

1. Main unit 1pc
2. User manual 1pc
3. Medication cup 1pc
4. Accessories 1set (adult mask, child mask)

Appendix I

Equivalent volume particle diameter distribution:

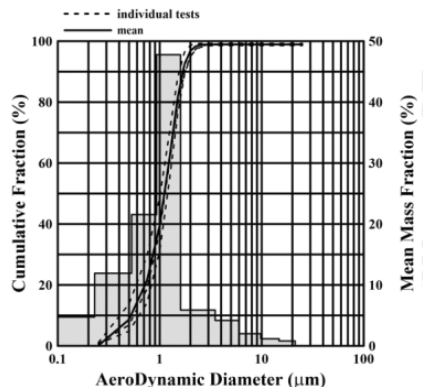

The median particle diameter (D 0.50) is 1~4 µm. µm. Error shall be within ±25 %.

Appendix II

Guidance and manufacturer's declaration – electromagnetic emissions for all EQUIPMENT and SYSTEMS

Guidance and manufacturer's declaration – electromagnetic emission		
The 28066 / NE-M01 is intended for use in the electromagnetic environment specified below. The customer or the user of the 28066 / NE-M01 should make sure that it is used in such an environment.		
Emission test	Compliance	Electromagnetic environment – guidance
RF emissions CISPR 11	Group 1	The 28066 / NE-M01 uses RF energy only for its internal function. Therefore, its RF emissions are very low and are not likely to cause any interference in nearby electronic equipment.
RF emission CISPR 11	Class B	The 28066 / NE-M01 is suitable for use in all establishments, including domestic establishments and those directly connected to the public low-voltage power supply network that supplies buildings used for domestic purposes.

Guidance and manufacturer's declaration – electromagnetic immunity – for all EQUIPMENT and SYSTEMS

Guidance and manufacturer's declaration – electromagnetic immunity			
The 28066 / NE-M01 is intended for use in the electromagnetic environment specified below. The customer or the user of the 28066 / NE-M01 should make sure that it is used in such an environment.			
Immunity test	IEC 60601 test level	Compliance level	Electromagnetic environment guidance
Electrostatic discharge (ESD) IEC 61000-4-2	Air Discharge: ± 2 kV, ± 4 kV, ± 8 kV, ± 15 kV contact: ± 8 kV air	Air Discharge: ± 2 kV, ± 4 kV, ± 8 kV, ± 15 kV contact: ± 8 kV air	Floors should be wood, concrete or ceramic tile. If floor is covered with synthetic material, the relative humidity should be at least 30 %.
Power frequency (50/60Hz) magnetic field IEC61000-4-8	30 A/m	30 A/m	Mains power quality should be that of a typical commercial or hospital environment.
NOTE: U_T is the a.c. mains voltage prior to application of the test level.			

Guidance and manufacturer's declaration – electromagnetic immunity – for EQUIPMENT and SYSTEMS that are not LIFE-SUPPORTING

Guidance and manufacturer's declaration – electromagnetic immunity			
The 28066 / NE-M01 is intended for use in the electromagnetic environment specified below. The customer or the user of the 28066 / NE-M01 should make sure that it is used in such an environment.			
Immunity test	IEC 60601 test level	Compliance level	Electromagnetic environment guidance
Radiated RF IEC 61000-4-3	10 V/m 80 MHz to 2.7 GHz	10 V/m	<p>Portable and mobile RF communications equipment should be used no closer to any part of the 28066 / NE-M01, including cables, than the recommended separation distance calculated from the equation applicable to the frequency of the transmitter.</p> <p>Recommended separation distance</p> $d = \left[\frac{3.5}{V^2} \right] \sqrt{P}$ $d = \left[\frac{3.5}{E^2} \right] \sqrt{P} \quad 80\text{MHz to } 800\text{MHz}$ $d = \left[\frac{7}{E^2} \right] \sqrt{P} \quad 800\text{MHz to } 2,7\text{GHz}$ <p>Where P is the maximum output power rating of the transmitter in watts (W) according to the transmitter manufacturer and d is the recommended separation distance in metres (m).</p> <p>Interference may occur in the vicinity of equipment marked with the following symbol:</p> 

NOTE 1 At 80 MHz and 800 MHz, the higher frequency range applies.

NOTE 2 These guidelines may not apply in all situations. Electromagnetic propagation is affected by absorption and reflection from structures, objects and people.

a: Field strengths from fixed transmitters, such as base stations for radio (cellular/cordless) telephones and land mobile radios, amateur radio, AM and FM radio broadcast and TV broadcast cannot be predicted theoretically with accuracy. To assess the electromagnetic environment due to fixed RF transmitters, an electromagnetic site survey should be considered. If the measured field strength in the location in which the 28066 / NE-M01 is used exceeds the applicable RF compliance level above, the 28066 / NE-M01 should be observed to verify normal operation. If abnormal performance is observed, additional measures may be necessary, such as reorienting or relocating the 28066 / NE-M01.

Recommended separation distances between portable and mobile RF communications equipment and the Medical 28066 / NE-M01

Recommended separation distances between portable and mobile RF communications equipment and the Medical 28066 / NE-M01

The "28066 / NE-M01" is intended for use in an electromagnetic environment in which radiated RF disturbances are controlled. The customer or the user of the Medical 28066 / NE-M01 can help prevent electromagnetic interference by maintaining a minimum distance between portable and mobile RF communications equipment (transmitters) and the "28066 / NE-M01" as recommended below, according to the maximum output power of the communications equipment.

Rated maximum output power of transmitter (W)	Separation distance according to frequency of transmitter (m)		
	150KHz to 80MHz	80MHz to 800MHz	800MHz to 2,5GHz
	$d = \left[\frac{3.5}{V} \right] \sqrt{P}$	$d = \left[\frac{3.5}{E} \right] \sqrt{P}$	$d = \left[\frac{7}{E} \right] \sqrt{P}$
0,01	0.12	0.12	0.23
0,1	0.38	0.38	0.73
1	1.2	1.2	2.3
10	3.8	3.8	7.3
100	12	12	23

For transmitters rated at a maximum output power not listed above, the recommended separation distance in meters (m) can be estimated using the equation applicable to the frequency of the transmitter, where *P* is the maximum output power rating of the transmitter in watts (W) according to the transmitter manufacturer.

NOTE 1 At 80 MHz and 800 MHz, the separation distance for the higher frequency range applies.

NOTE 2 These guidelines may not apply in all situations. Electromagnetic propagation is affected by absorption and reflection from structures, objects and people.



Disposal: The product must not be disposed of along with other domestic waste. The users must dispose of this equipment by bringing it to a specific recycling point for electric and electronic equipment.

For further information on recycling points contact the local authorities, the local recycling center or the shop where the product was purchased. If the equipment is not disposed of correctly, fines or penalties may be applied in accordance with the national legislation and regulations.

GIMA WARRANTY CONDITIONS

Congratulations for purchasing a GIMA product. This product meets high qualitative standards both as regards the material and the production. The warranty is valid for 12 months from the date of supply of GIMA.

During the period of validity of the warranty, GIMA will repair and/or replace free of charge all the defected parts due to production reasons. Labor costs and personnel traveling expenses and packaging not included. All components subject to wear are not included in the warranty. The repair or replacement performed during the warranty period shall not extend the warranty.

The warranty is void in the following cases: repairs performed by unauthorized personnel or with non-original spare parts, defects caused by negligence or incorrect use. GIMA cannot be held responsible for malfunctioning on electronic devices or software due to outside agents such as: voltage changes, electro-magnetic fields, radio interferences, etc.

The warranty is void if the above regulations are not observed and if the serial code (if available) has been removed, cancelled or changed. The defected products must be returned only to the dealer the product was purchased from. Products sent to GIMA will be rejected.