



Questo manuale d'istruzione è fornito da trovaprezzi.it. Scopri tutte le offerte per [Hikvision DS-D5B65RB/A](#) o cerca il tuo prodotto tra le [migliori offerte di Monitor](#)



Interactive Tablet

User Manual

Legal Information

©2022 Hangzhou Hikvision Digital Technology Co., Ltd. All rights reserved.

About this Manual

The Manual includes instructions for using and managing the Product. Pictures, charts, images and all other information hereinafter are for description and explanation only. The information contained in the Manual is subject to change, without notice, due to firmware updates or other reasons. Please find the latest version of this Manual at the Hikvision website (<https://www.hikvision.com/>).

Please use this Manual with the guidance and assistance of professionals trained in supporting the Product.

Trademarks

HIKVISION and other Hikvision's trademarks and logos are the properties of Hikvision in various jurisdictions.

Other trademarks and logos mentioned are the properties of their respective owners.

HDMI[™] : The terms HDMI and HDMI High-Definition Multimedia Interface, and the HDMI Logo are trademarks or registered trademarks of HDMI Licensing Administrator, Inc. in the United States and other countries.

Disclaimer

TO THE MAXIMUM EXTENT PERMITTED BY APPLICABLE LAW, THIS MANUAL AND THE PRODUCT DESCRIBED, WITH ITS HARDWARE, SOFTWARE AND FIRMWARE, ARE PROVIDED "AS IS" AND "WITH ALL FAULTS AND ERRORS". HIKVISION MAKES NO WARRANTIES, EXPRESS OR IMPLIED, INCLUDING WITHOUT LIMITATION, MERCHANTABILITY, SATISFACTORY QUALITY, OR FITNESS FOR A PARTICULAR PURPOSE. THE USE OF THE PRODUCT BY YOU IS AT YOUR OWN RISK. IN NO EVENT WILL HIKVISION BE LIABLE TO YOU FOR ANY SPECIAL, CONSEQUENTIAL, INCIDENTAL, OR INDIRECT DAMAGES, INCLUDING, AMONG OTHERS, DAMAGES FOR LOSS OF BUSINESS PROFITS, BUSINESS INTERRUPTION, OR LOSS OF DATA, CORRUPTION OF SYSTEMS, OR LOSS OF DOCUMENTATION, WHETHER BASED ON BREACH OF CONTRACT, TORT (INCLUDING NEGLIGENCE), PRODUCT LIABILITY, OR OTHERWISE, IN CONNECTION WITH THE USE OF THE PRODUCT, EVEN IF HIKVISION HAS BEEN ADVISED OF THE POSSIBILITY OF SUCH DAMAGES OR LOSS.

YOU ACKNOWLEDGE THAT THE NATURE OF THE INTERNET PROVIDES FOR INHERENT SECURITY RISKS, AND HIKVISION SHALL NOT TAKE ANY RESPONSIBILITIES FOR ABNORMAL OPERATION, PRIVACY LEAKAGE OR OTHER DAMAGES RESULTING FROM CYBER-ATTACK, HACKER ATTACK, VIRUS INFECTION, OR OTHER INTERNET SECURITY RISKS; HOWEVER, HIKVISION WILL PROVIDE TIMELY TECHNICAL SUPPORT IF REQUIRED.

YOU AGREE TO USE THIS PRODUCT IN COMPLIANCE WITH ALL APPLICABLE LAWS, AND YOU ARE SOLELY RESPONSIBLE FOR ENSURING THAT YOUR USE CONFORMS TO THE APPLICABLE LAW. ESPECIALLY, YOU ARE RESPONSIBLE, FOR USING THIS PRODUCT IN A MANNER THAT DOES NOT INFRINGE ON THE RIGHTS OF THIRD PARTIES, INCLUDING WITHOUT LIMITATION, RIGHTS OF

Interactive Tablet User Manual

PUBLICITY, INTELLECTUAL PROPERTY RIGHTS, OR DATA PROTECTION AND OTHER PRIVACY RIGHTS. YOU SHALL NOT USE THIS PRODUCT FOR ANY PROHIBITED END-USES, INCLUDING THE DEVELOPMENT OR PRODUCTION OF WEAPONS OF MASS DESTRUCTION, THE DEVELOPMENT OR PRODUCTION OF CHEMICAL OR BIOLOGICAL WEAPONS, ANY ACTIVITIES IN THE CONTEXT RELATED TO ANY NUCLEAR EXPLOSIVE OR UNSAFE NUCLEAR FUEL-CYCLE, OR IN SUPPORT OF HUMAN RIGHTS ABUSES.

IN THE EVENT OF ANY CONFLICTS BETWEEN THIS MANUAL AND THE APPLICABLE LAW, THE LATER PREVAILS.

Regulatory Information

FCC Information

Please take attention that changes or modification not expressly approved by the party responsible for compliance could void the user's authority to operate the equipment.

FCC compliance: This equipment has been tested and found to comply with the limits for a Class B digital device, pursuant to part 15 of the FCC Rules. These limits are designed to provide reasonable protection against harmful interference in a residential installation. This equipment generates, uses and can radiate radio frequency energy and, if not installed and used in accordance with the instructions, may cause harmful interference to radio communications. However, there is no guarantee that interference will not occur in a particular installation. If this equipment does cause harmful interference to radio or television reception, which can be determined by turning the equipment off and on, the user is encouraged to try to correct the interference by one or more of the following measures:

- Reorient or relocate the receiving antenna.
- Increase the separation between the equipment and receiver.
- Connect the equipment into an outlet on a circuit different from that to which the receiver is connected.
- Consult the dealer or an experienced radio/TV technician for help.

This equipment should be installed and operated with a minimum distance 20cm between the radiator and your body.

FCC Conditions

This device complies with part 15 of the FCC Rules. Operation is subject to the following two conditions:

- This device may not cause harmful interference.
- This device must accept any interference received, including interference that may cause undesired operation.

EU Conformity Statement



This product and - if applicable - the supplied accessories too are marked with "CE" and comply therefore with the applicable harmonized European standards listed under the RE Directive 2014/53/EU, the EMC Directive 2014/30/EU, LVD Directive 2014/35/EU, the RoHS Directive 2011/65/EU.



2012/19/EU (WEEE directive): Products marked with this symbol cannot be disposed of as unsorted municipal waste in the European Union. For proper recycling, return this product to your local supplier upon the purchase of equivalent new equipment, or dispose of it at designated

collection points. For more information see:

<http://www.recyclethis.info>.



2006/66/EC (battery directive): This product contains a battery that cannot be disposed of as unsorted municipal waste in the European Union. See the product documentation for specific battery information. The battery is marked with this symbol, which may include lettering to indicate cadmium (Cd), lead (Pb), or mercury (Hg). For proper recycling, return the battery to your supplier or to a designated collection point. For more information see: <http://www.recyclethis.info>.

Industry Canada ICES-003 Compliance

This device meets the CAN ICES-3 (B)/NMB-3(B) standards requirements.

1. This device complies with Industry Canada licence-exempt RSS standard(s). Operation is subject to the following two conditions: this device may not cause interference, and
2. this device must accept any interference, including interference that may cause undesired operation of the device.

1. Le présent appareil est conforme aux CNR d'Industrie Canada applicables aux appareils radioexempts de licence. L'exploitation est autorisée aux deux conditions suivantes : l'appareil ne doit pas produire de brouillage, et
2. l'utilisateur de l'appareil doit accepter tout brouillage radioélectrique subi, même si le brouillage est susceptible d'en compromettre le fonctionnement.

Under Industry Canada regulations, this radio transmitter may only operate using an antenna of a type and maximum (or lesser) gain approved for the transmitter by Industry Canada. To reduce potential radio interference to other users, the antenna type and its gain should be so chosen that the equivalent isotropically radiated power (e.i.r.p.) is not more than that necessary for successful communication.

Conformément à la réglementation d'Industrie Canada, le présent émetteur radio peut fonctionner avec une antenne d'un type et d'un gain maximal (ou inférieur) approuvé pour l'émetteur par Industrie Canada. Dans le but de réduire les risques de brouillage radioélectrique à l'intention des autres utilisateurs, il faut choisir le type d'antenne et son gain de sorte que la puissance isotrope rayonnée équivalente (p.i.r.e.) ne dépasse pas l'intensité nécessaire à l'établissement d'une communication satisfaisante.

This equipment should be installed and operated with a minimum distance 20cm between the radiator and your body.

Cet équipement doit être installé et utilisé à une distance minimale de 20 cm entre le radiateur et votre corps.



Preface

Applicable Models

This manual is applicable to Interactive Tablet.

Symbol Conventions

The symbols that may be found in this document are defined as follows.

Symbol	Description
 Danger	Indicates a hazardous situation which, if not avoided, will or could result in death or serious injury.
 Caution	Indicates a potentially hazardous situation which, if not avoided, could result in equipment damage, data loss, performance degradation, or unexpected results.
 Note	Provides additional information to emphasize or supplement important points of the main text.

Safety Instructions

Caution

- Ensure correct wiring of the terminals for connection to an AC mains supply.
- The equipment has been designed, when required, modified for connection to an IT power distribution system.
- The ventilation should not be impeded by covering the ventilation openings with items, such as newspapers, table-cloths, curtains, etc. The openings shall never be blocked by placing the equipment on a bed, sofa, rug or other similar surface.
- Keep a minimum 5 cm distance on the upper, left and right sides, and 1 m on the front side for sufficient ventilation.

- Install the equipment according to the instructions in this manual.
To prevent injury, this equipment must be securely attached to the floor/wall in accordance with the installation instructions.
 - No naked flame sources, such as lighted candles, should be placed on the equipment.
 - Keep vertical when moving or using the equipment.
 - Do not place the device in direct strong lighted, humid, over-heated/cooled, dusty environment.
 - Do not place the device in an environment where flammable and explosive matter are stored and used.
 - Do not place the device in an environment of flammable and corrosive gas.
 - Do not place the device in places like bathroom and kitchen.
 - Do not use damaged or unfit power socket. Make sure the plug and the socket are in good contact.
 - Do not parallel multiple plugs in one socket to avoid fire risk caused by power overload.
 - Do not approach the device with fire (e.g. a lit candle) to avoid the risk of fire or electric shock.
 - Do not place anything containing liquid on the device to avoid the risk of fire or electric shock caused by liquid-splashing.
 - Do not let sharp or metal articles and liquids contact the signal connectors or heat dissipation holes to avoid short circuit, product damage and electric shock.
 - Do not touch the device with a wet finger to avoid risk of electric shock.
 - Do not operate the device in heavy rain, especially lightning weather to avoid electric shock.
Contact professional technicians for repairing.
-

Warning

- In the use of the product, you must be in strict compliance with the electrical safety regulations of the nation and region.
 - Never place the equipment in an unstable location. The equipment may fall, causing serious personal injury or death.
 - The equipment must be connected to an earthed mains socket-outlet.
 - Do not ingest battery. Chemical burn hazard!
This product contains a coin/button cell battery. If the coin/button cell battery is swallowed, it can cause severe internal burns in just 2 hours and can lead to death.
Keep new and used batteries away from children.
If the battery compartment does not close securely, stop using the product and keep it away from children.
If you think batteries might have been swallowed or placed inside any part of the body, seek immediate medical attention.
CAUTION: Risk of explosion if the battery is replaced by an incorrect type. Improper replacement of the battery with an incorrect type may defeat a safeguard (for example, in the case of some lithium battery types).
Do not dispose of the battery into fire or a hot oven, or mechanically crush or cut the battery, which may result in an explosion.
Do not leave the battery in an extremely high temperature surrounding environment, which
-

may result in an explosion or the leakage of flammable liquid or gas.

Do not subject the battery to extremely low air pressure, which may result in an explosion or the leakage of flammable liquid or gas.

Dispose of used batteries according to the instructions

- This equipment is for use only with specified brackets. Use with other (carts, stands, or carriers) may result in instability causing injury.
 - Do not let children climb onto the device.
 - Keep small accessories away from children.
 - If the device will not be used for a long time. Shut down the power of the device and disconnect the power supply.
 - To avoid the risk of electric shock, please do not operate when the power is on.
 - Please do not plug and unplug the power cable frequently.
 - Make sure the power supply matches the requirements specified by the plate on the shell.
 - After the environment temperature changed from low to high. Wait for a period of time before powering on the device.
 - Make sure the environment is dry and well-ventilated, and heat dissipation is good.
 - Turn down the volume when using earphones.
 - To prevent possible hearing damage, do not listen at high volume levels for long periods.
-

Contents

Chapter 1 Introduction	1
Chapter 2 Operation and Maintenance Precautions	2
2.1 Use of Power Cable	2
2.2 Cleaning and Maintenance	3
Chapter 3 Connection and Installation	4
3.1 Precautions for Installation.....	4
3.2 Appearance and Interfaces	4
3.3 Connection to Personal Computer (PC).....	5
3.4 Internal Computer Installation	7
3.5 Mounting	7
Chapter 4 Startup and Shutdown.....	11
4.1 Device Startup	11
4.1.1 Installed Without a Computer Box	11
4.1.2 Installed with a Computer Box	11
4.2 Eco Mode	11
4.3 Shutdown.....	11
Chapter 5 Menu Operations	13
5.1 Basic Operations.....	13
5.2 Input Source.....	14
5.3 Time and Date	14
5.4 Network	14
5.5 Control Menu.....	14
5.5.1 Annotating	15
5.5.2 Screenshot	17
5.6 Notification	17
Chapter 6 System Settings	18
6.1 Network Settings	18
6.1.1 Wired Network Settings.....	18
6.1.2 Wireless Network Settings.....	20

6.1.3 WLAN Hotspot Settings	22
6.2 Display Settings	23
6.3 Audio Settings	24
6.4 Language and Input Settings	25
6.5 Time and Date Settings	26
6.6 Application Management	26
6.7 Bluetooth	26
6.8. Intelligent Temperature Control	26
6.9 Advanced Settings	27
6.10 Security	30
6.11 Device Information	30
Chapter 7 Intelligent Applications	31
7.1 FileBrowser	31
7.2 Browser	32
7.3 System Pre-installed Applications	33
Appendix A FAQs	34

Chapter 1 Introduction

The Interactive Tablet (hereafter referred as 'the device') integrates functions of computers, projectors, interactive whiteboards, sound boxes, cameras (optional), HDTVs, advertising machines and so on. The device applies multiple technologies like 4K display, infrared touch, human-machine interaction, multi-media information processing, and network transmission, providing users with various features such as writing, annotating, multi-screen sharing, and remote video call (optional).

The device is mainly used for remote video conferences, trainings and guidance, medical consulting, and other events in kinds of offices, meeting rooms, multi-media classrooms, exhibition halls and so on.

Key Features

- Ultra HD display with up to 3840 × 2160 resolution of input signal available.
- 20px ultra fine writing, and 2 mm diameter recognizable with the precision of 1 mm.
- Built-in Wi-Fi realizes miracasting without any cable connection.
- Built-in interactive whiteboard system allows annotating and sharing by QR code.
- Looping-out display available.
- Various audio and video interfaces for device access.
- Built-in network switch chip saves a network switch.
- Built-in Android system provides kinds of applications.
- Compatible with OPS/OPS-C devices, realizing smooth switch between built-in systems.
- Ultra-thin design with aluminum profile frame.

Chapter 2 Operation and Maintenance Precautions

The LCD panel on the device is made by high-precision technology. However, tiny spots on the screen that are always or never lit may be observed, or when observed from side, the color and brightness may appear to be uneven. Yet the above phenomena are common among LCD displays rather than faults and will not affect the performance of the device.

- Our company is not responsible for any fault caused by third-party when operating the device and other failure or damage incurred.
- Do not operate the device in an environment of dust, high humidity, or oil and steam contacting to avoid the risk of fire and damage.
- Do not place the device under direct sunlight or near strong light source.
- Do not place the device near other equipment with strong radiation.
- Do not expose the device to rain or humid environment.
- Do not place the device on unstable or unsafe surface. Avoid strong impact, vibration or vibration.
- Do not operate the device near heating device or place of high temperature to avoid the risk of fire.
- After moving the device from low temperature environment to high temperature environment, please do not turn on the device immediately and wait for the condensation to evaporate.
- Do not insert any object into the device.
- Do not place heavy objects upon the device.
- The device and its accessories are subject to change without prior notice.
- The fragile materials of the display are vulnerable to falling and impact. Please hold with care.
- Improper operations during debugging and operating may cause damage to the device.
- Scratching or knocking the device with hard objects is strictly forbidden. Do not frequently turn on/off the power of the device when operating to avoid the risk of damage and faults.
- If smoke, odor or noise rise from the device, turn off the power at once and unplug the power cable, and then please contact the service center.

2.1 Use of Power Cable

- If the power cable is damaged or failed, contact service center. Make sure the power supply is properly grounded and matches the requirements specified by the plate on the shell.
- Do not expose the device to rain or humid environment. Disconnect power plug and antenna in thunderstorm weather.
- If the device will not be used for a long time. Shut down the power of the device and disconnect the power supply.
- Electric discharge may last for a short period of time after the power is shut down. Please wait for two minutes after the power shut down to operate the device.
- Only use the original power cable delivered with the device. Contact authorized dealer to purchase power cable with same specifications.

- Make sure the power supply is grounded.
- Do not let dust or metal attachment adhere to the power plug and socket.
- Do not modify the cable in any form.
- Do not place heavy object on the cable.
- Keep the cable away from heat.
- Do not disconnect the power plug by pulling the cable.
- Keep the power cable away from physical or mechanical damage.
- The cable is applicable only to the Interactive Display. Do not use it on other devices.

2.2 Cleaning and Maintenance

- The hole on the rear shell is for heat dissipation. Do not pour or spray liquid to the rear shell or use wet cloth for cleaning.
- Disconnect the power plug before cleaning.
- Do not display images with high brightness on the screen for too long.
- Use a dry, soft and dust-free cloth to clean the device.
- Contact service center for internal cleaning.
- Proper maintenance can avoid certain early-stage failures.
- Clean the device on a regular basis to make the device look new.
- Do not clean the device with water, spray cleaner or industrial chemical reagent. Prevent foreign matters from entering the device.
- Contact qualified service personnel for device maintenance. If the device is damaged, please contact our company, do not carry out unauthorized maintenance.

Chapter 3 Connection and Installation

3.1 Precautions for Installation

- Clean the device screen and back before installation for best performance.
- For safety, only use the wall mount or base provided by the manufacture.
- Contact professional staff for wall mounting.
- Check the accessories before the installation. Contact the dealer if anything is missing.
- Do not install the device too tight. Otherwise the screen may be distorted.
- Mount the device on load-bearing wall.
- Place the device on a stable surface or fix the device steadily on the wall.
- Install the device near an available AC power socket for easy power connection. Use the same ground cable with other devices to prevent signal interference.
- Do not place the device near mechanical vibration source.
- Do not place the device in an environment where insects have easy access.
- Do not let the device face the air conditioner directly to avoid condensing.
- Do not place the device in strong electromagnetic field to avoid radio interference.

3.2 Appearance and Interfaces

The interfaces of interactive tablet are shown as followed.

 **Note**

- Interfaces of the device vary from different type.
 - The following description is from the direction facing the screen.
-

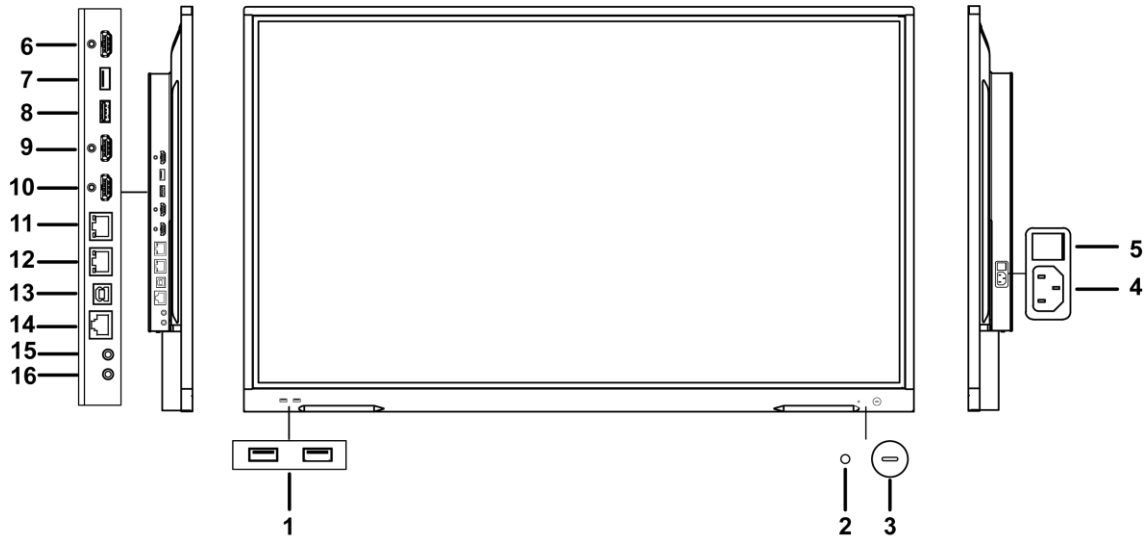

Figure 3-1 Front Panel and Interfaces

Table 3-1 Panel Description

No.	Description	No.	Description
1	Multi-functional USB interface	9	HDMI input interface 2
2	Environmental light sensor	10	HDMI input interface 1
3	Power button Short press to turn to power-saving status. Long press to turn on or turn off the device.	11	Network interface 2
4	Power switch	12	Network interface 1
5	Power supply interface 100 to 240 VAC	13	External touch interface
6	HDMI output interface	14	RS-232 debug serial port
7	Multi-functional USB interface	15	Audio input interface
8	USB 2.0 interface	16	Audio output interface

3.3 Connection to Personal Computer (PC)

The connection of PC and the device is shown as below.

Warning

The device must be disconnected from power supply before installation or disassembly.

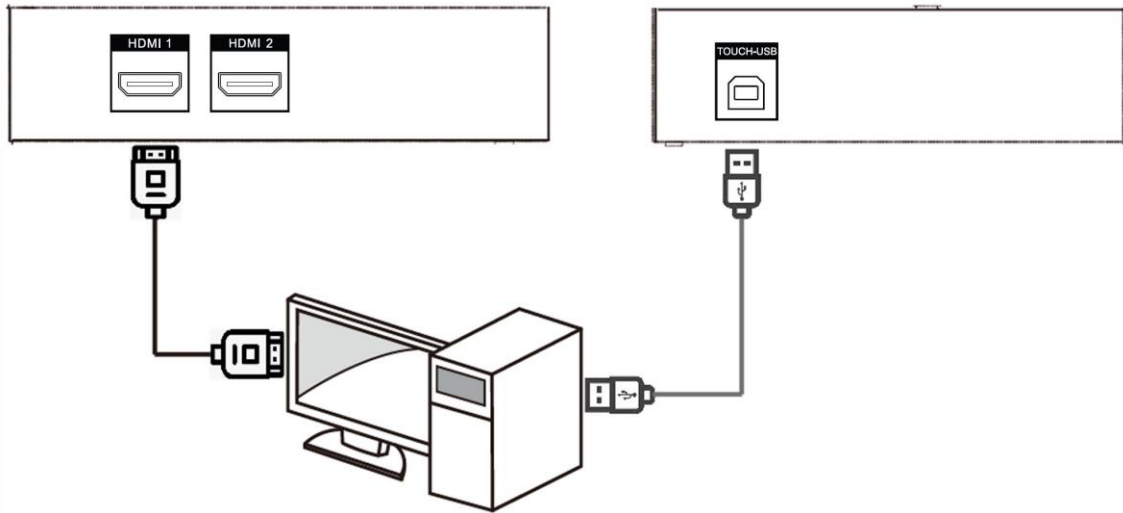

Figure 3-2 Connect to PC

i Note

- The Touch-USB interface is needed only when the user needs to touch operate the external PC on the device.
 - Use high quality signal cable less than 10 meters in length for high HDMI signal transmission quality.
 - USB cable is not contained in the product. Please purchase USB cable with type A connector to type B connector.
-

3.4 Internal Computer Installation

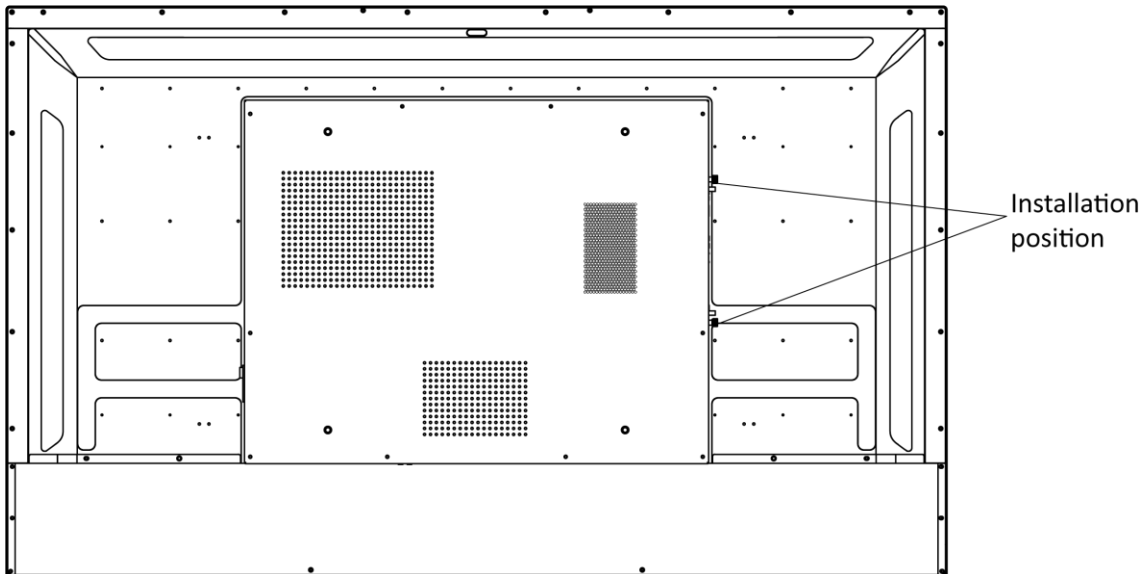

Figure 3-3 Internal Computer Installation

The computer box is installed at the side slot of the device. When installing the box, make sure its ventilation hole is facing the same direction with the rear panel as shown above. Fasten the screws to fix the box into position.

Warning

- The computer is an optional accessory.
 - To avoid potential device damage, the computer box can be removed only after the device is disconnected from power.
-

3.5 Mounting

The device can be installed with wall mount or mobile mount, as shown below.

Note

The accessories for wall mount and mobile mount are different. Do not mix them up.

Wall Mounting

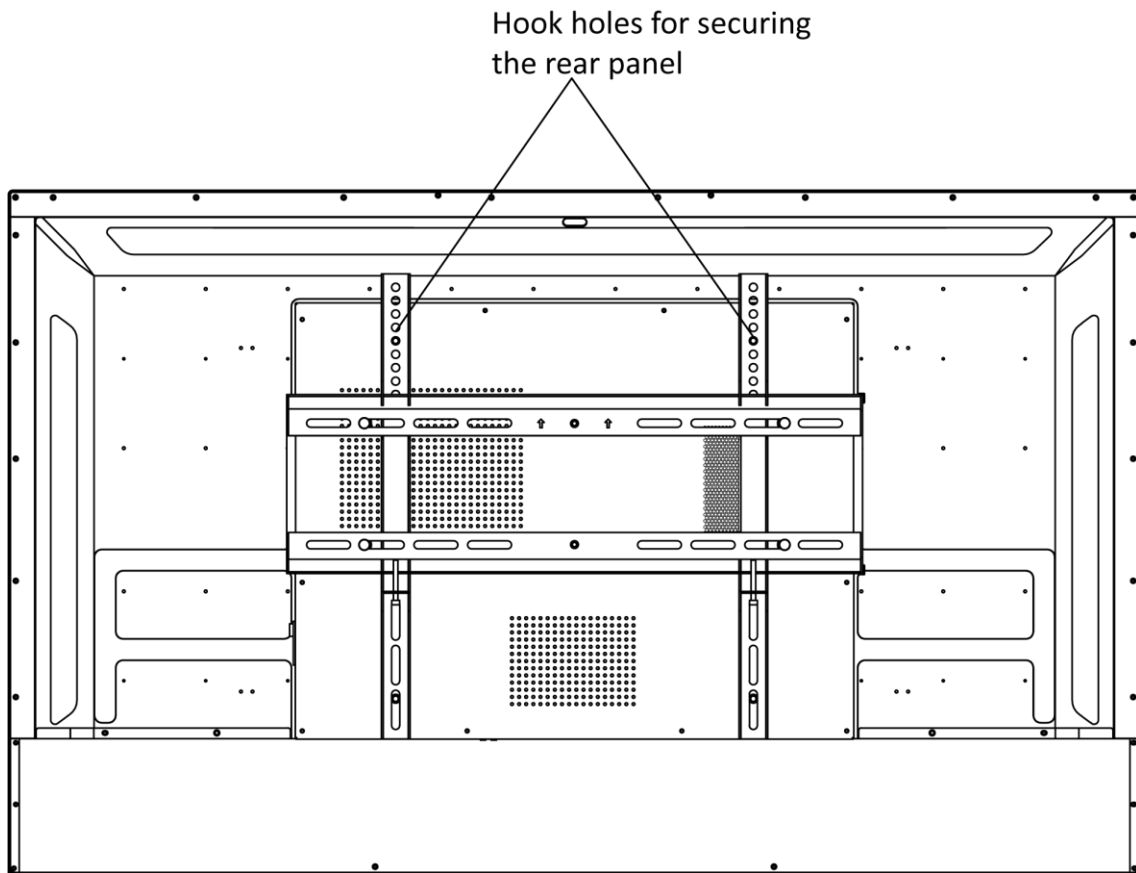

Figure 3-4 Wall Mounting Rear View

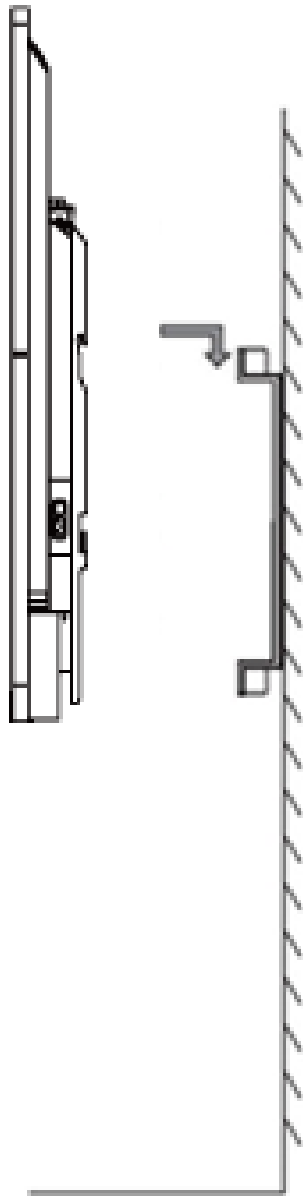

Figure 3-5 Wall Mounting Side View

Note

The wall mount is mobile horizontally. Please leave a space no less than 6 cm at each side (or 12 cm at one side), and 5 mm at the top and bottom for maintenance service.

Mobile Mounting

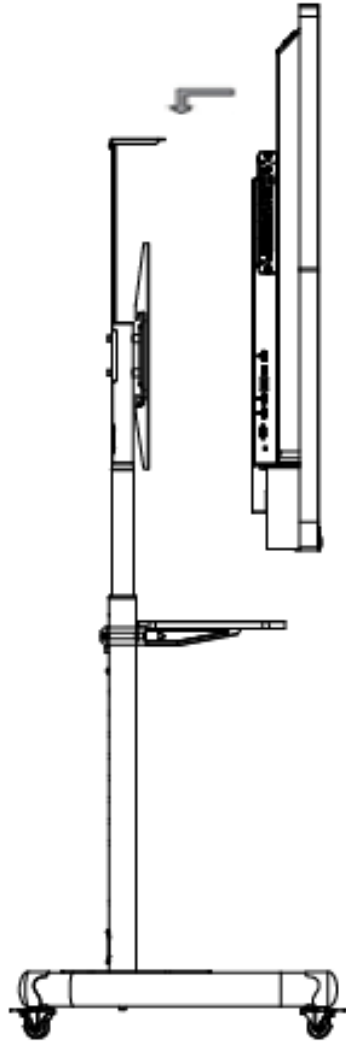

Figure 3-6 Mobile Mounting

Chapter 4 Startup and Shutdown

4.1 Device Startup

4.1.1 Installed Without a Computer Box

Steps

1. Connect the device to power supply.
2. Turn on the power switch, the power indicator on the front panel will turn red.
3. Push the power button on the front panel to start up the device, the indicator will turn blue.

4.1.2 Installed with a Computer Box

Install the box when the device is disconnected from power and turn on the power switch after the installation is finished. During the startup, the power indicator of the box will turn red and the fan will start. After a beep sound, the power indicator will turn green and the computer is switched on. Meanwhile, the power indicator on the front panel will turn blue which means the device is switched on.

4.2 Eco Mode

Entering Eco Mode

Press the power button on the front panel to turn off the screen and enter Eco Mode.

Waking up the Device

Three ways to wake up the device:

- Press the power button on the front panel.
- Press the power-off button on the remote control.
- Touch anywhere on the screen twice.

4.3 Shutdown

- If the device is not installed with a computer box or the computer box is shut down, directly switch off the power to shut down the device.
- If the device is installed with a computer box which is powered on, tap **Start** and choose **Shutdown**, or press the power button on the computer box to shut it down (press and hold the

power button to force shutdown). Then switch off the power to shut down the device.

 **Note**

Switching off the power of the device directly leads to force shutdown of the computer box. Next time the device starts up, Windows may enter error recovery mode and screen touch will be disabled. In this case, you need to connect a mouse and a keyboard to the device.

Short press the power-off button on the remote control.

Chapter 5 Menu Operations

Note

Software interfaces and functions may vary with device models. All pictures in this manual are for illustration purpose only.

Turn on the device and go to the main page. The shortcut menu is displayed at the bottom of the screen.



Figure 5-1 Main Page

Note

Long press the icons of applications on the main page to replace with the commonly-used ones.

5.1 Basic Operations

Functions of the shortcut icons are described below.

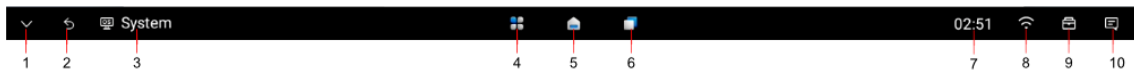

Figure 5-2 Shortcuts

Table 5-1 Shortcuts Description

No.	Function	No.	Function
1	Tap to hide the menu bar at the bottom.	6	Tap to open all the windows of processes.
2	Tap to return to the previous page.	7	Tap to set the date and time.
3	Tap to select the input source.	8	Tap to configure network parameters and hotspot.
4	Tap to check all the applications. Long press and move the selected application to display in split view.	9	Tap to open the control menu.
5	Tap to return to the main page.	10	Tap to check notifications.

5.2 Input Source

Tap the icon of input source at the bottom (area 3 in [Basic Operations](#)), and set the input source of the device. **System**, **PC**, **HDMI 1**, and **HDMI 2** are available.

5.3 Time and Date

Set time and date. Refer to [Time and Date Settings](#) for more details.

5.4 Network

Set the detailed parameters of wired network, wireless network, and WLAN hotspot. Refer to [Network Settings](#) for more details.

5.5 Control Menu

Tap  at the bottom to show the control menu. The following operations are available.



Figure 5-3 Control Menu

Table 5-2 Control Menu Descriptions

Tool	Description
Calculator	Enable the built-in calculator.
Note	Take annotations on the current page.
Camera	Open the camera bound to the device.
Screenshot	Capture the current page.
Stopwatch	Measure the amount of time.
Countdown	Count seconds backwards to zero.
Controller	Enable the virtual controller.
Lock Screen	Tap to enable touch lock, and no touch operation on the locked page is available. Tap the lock and exit, the touch function will return to normal.
Adjustment Bar	Adjust the brightness and volume.

5.5.1 Annotating

Go to  → **Note** to take annotations. You can add annotations anywhere on the page by touching and moving on the screen.

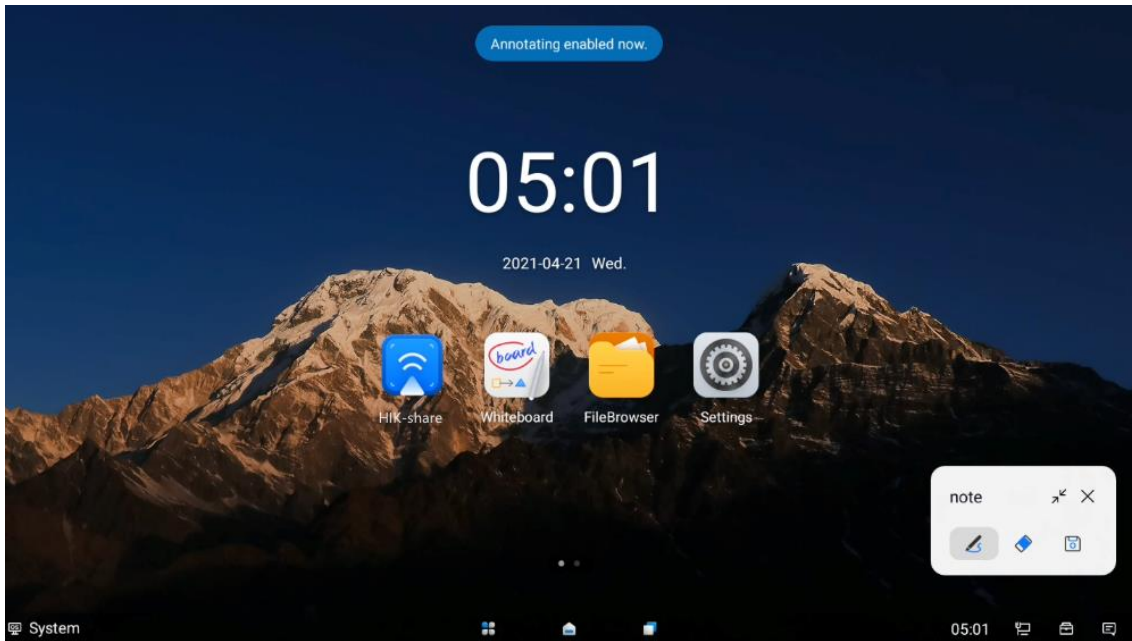

Figure 5-4 Take Annotations

Table 5-3 Icon Descriptions

Icon	Description
	<ul style="list-style-type: none"> Pen color and size are customizable. Enable angled stroke or not. Tap to have lines with angled stroke, and tap to have lines without angled stroke.
	Erase the desired annotations.
	Clear all the annotations.
	Save the current page.
	Generate QR code of annotation when tablet connects to the LAN. Devices in the same LAN can scan the QR code to download annotation.
	When the device is connected to the Internet, you can tap to generate the annotation into a QR code, and any devices in the same LAN as the device can scan the QR code to download the annotation.
	Hide the tool in a floating window.
	Exit annotating.

Note

Up to 20 pens are allowed when lines with angled stroke is disabled, while only one when enabled.

5.5.2 Screenshot





Go to  → **Screenshot**, and a capture area pops up on the current page. Adjust the area by tapping and dragging the four corners. The screenshot toolbar pops up on the lower right corner of the area.



Figure 5-5 Screenshot

Table 5-4 Screenshot Toolbar Descriptions

Icon	Description
	Capture the whole page.
	Save the screenshot in the capture area.
	Exit screenshot.

5.6 Notification

Check notifications. Click **Delete** to delete all notifications.



Chapter 6 System Settings

The screen displays the main page after the device is turned on. Slide the screen to the left of right to view applications, device status, and help documents. Left slide home screen to scan the code for feedback.

6.1 Network Settings

The network status is displayed at the bottom of the screen (area 8 in [Basic Operations](#)).

Table 6-1 Different Network Status

Icon	Description
	Connected to a wired network.
	Connected to a wireless network.
	No network connected.

6.1.1 Wired Network Settings

Steps

1. Go to **Settings** → **Network** → **Wired Network**.
2. Enable **Wired Network**.

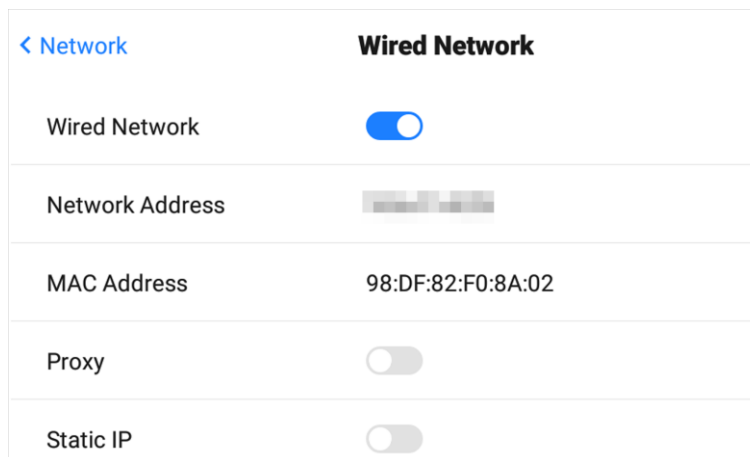

Figure 6-1 Wired Network Settings

3. Optional: Tap to enable **Proxy** or **Static IP**.

Proxy Settings

When proxy enabled, you need to set **Proxy Host** and **Port No.**, and set the URLs that do not use the proxy.

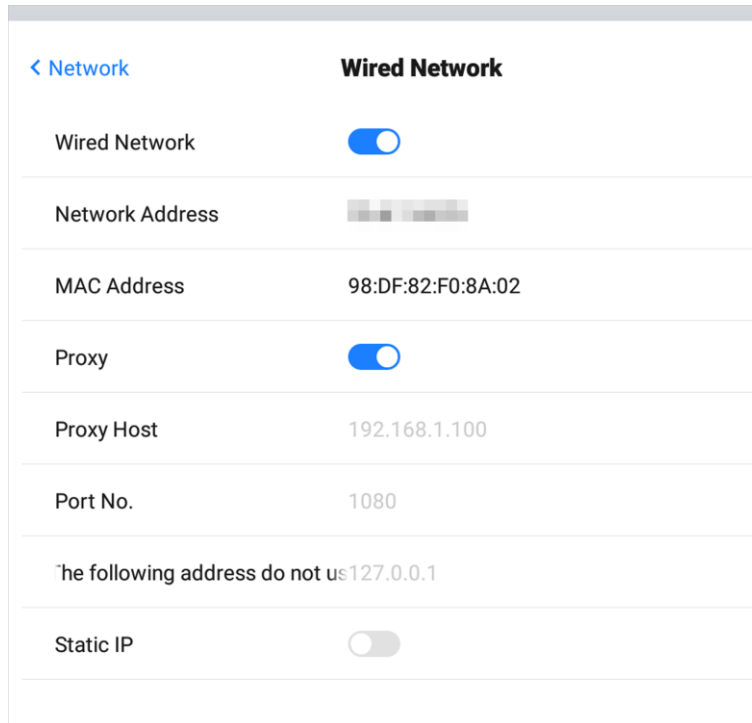

Figure 6-2 Proxy Settings

Static IP Settings

When static IP enabled, you need to set network parameters, such as **Static IP**, **Gateway**, **Subnet Mask**, **DNS1**, and **DNS2**.

Static IP	<input checked="" type="checkbox"/>
Static IP	██████████
Gateway	██████████
Subnet Mask	255.255.255.0
DNS 1	8.8.8.8
DNS 2	8.8.8.8

Figure 6-3 Static IP Settings

6.1.2 Wireless Network Settings

Steps

1. Go to **Settings** → **Network** → **Wireless Network**.
2. Enable **WLAN**, and you can add a new network or connect to an available network.

Connect to Available Networks

- Tap the desired network in the available network list, and enter the password to connect.
- Tap **Connect**, and network information page pops up. Tap **Clear Network** to delete the information of the selected network. Tap **Cancel** to exit the page.

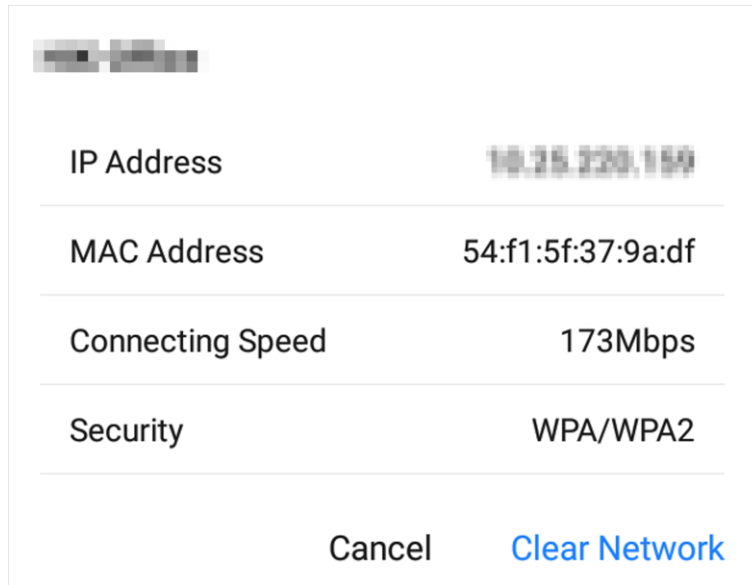

Figure 6-4 Wireless Network Information

Add Other Networks

Steps

1. Tap **Add Other Networks**.
2. Enter Wi-Fi name and select **Security**.

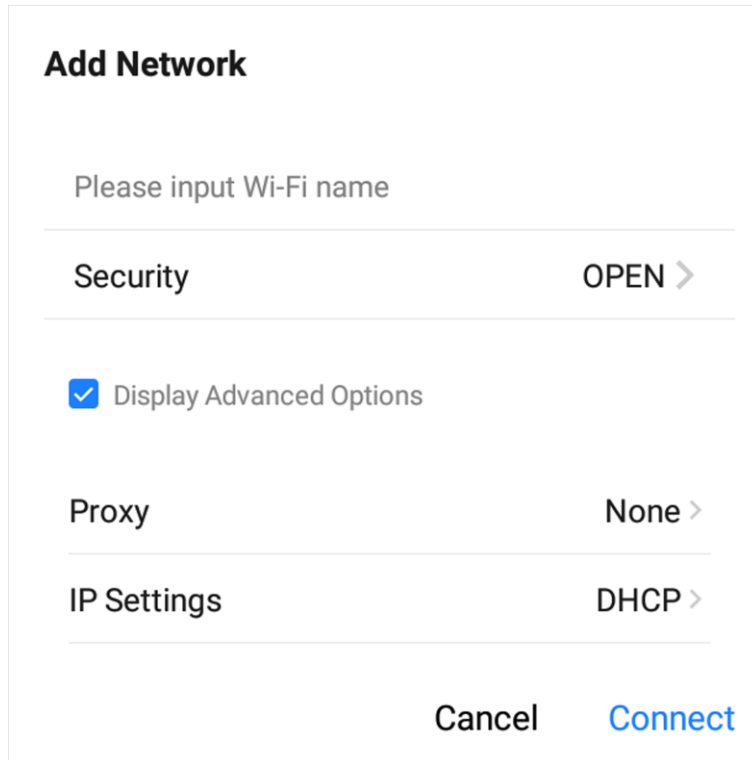

Figure 6-5 Add Other Network

3. Optional: Check **Display Advanced Settings** to select proxy and network IP type.
4. Tap **Connect** to connect the device to the added wireless network.

6.1.3 WLAN Hotspot Settings

When the device is connected to the wired network, it can provide wireless network for other devices with WLAN hotspot enabled.

Steps

1. Go to **Settings** → **Network** → **Hotspot**.
2. Enable **Portable WLAN Hotspot**.
 - Hotspot Isolation: After enabling hotspot isolation, even if the device is connected to the LAN, it cannot access resources such as websites in the LAN.
3. Set parameters in the pop-up page.

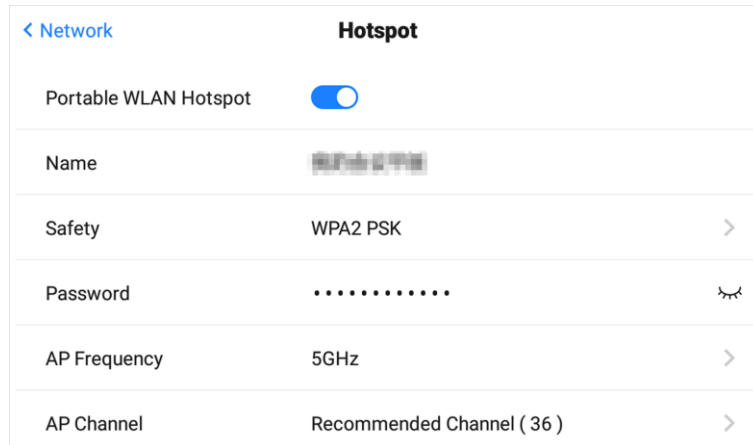

Figure 6-6 Hotspot Settings

Note

If the device supports both 2.4 GHz and 5 GHz, set 5 GHz as **AP Frequency**, and recommended channels as **AP Channel** for better experience functions such as wireless screen mirroring.

6.2 Display Settings

Go to **Settings** → **Display** to adjust parameters, such as brightness and sleeping time.

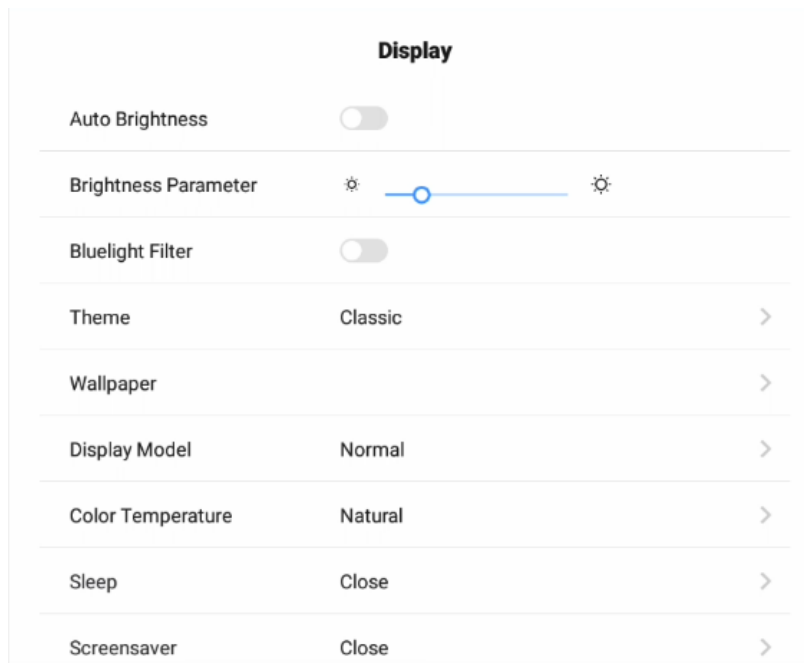

Figure 6-7 Display Settings

Auto Brightness

The device can adjust brightness according to the environment automatically when enabled.

Brightness Parameter

Slide the slider to adjust the brightness of the screen.

Bluelight Filter

Enable the function to protect your eyes by filtering blue light.

Theme

Set the device theme. Tap **Settings** to select a desired theme, and tap **Apply**.

Wallpaper

Tap **Wallpaper** to select a desired picture from wallpaper library or the system picture library as wallpaper, or restore to the default wallpaper.

Display Mode

Set the display mode and select either **Bright** or **Normal**.

Color Temperature

Default **Natural**.

Sleep

Set an inactivity period for sleep mode.

Screensaver

Set an inactivity period for enabling screensaver.

Screensaver Configuration

Tap to select a screensaver picture in the pop-up page, and tap **Live View** to preview the effect. Tap **Apply** to set the selected picture as the screensaver. The screensaver can also be customized.



Note

You can add new screensaver pictures in **Screensaver Configuration** by tapping **+**.

6.3 Audio Settings

Steps

1. Go to **Settings** → **Audio** to set audio parameters.

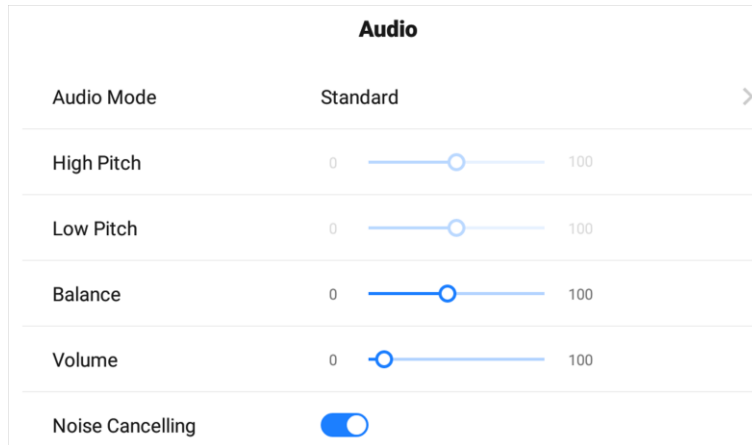

Figure 6-8 Audio Settings

2. Tap to select a mode from **Standard**, **Music**, **Movie**, and **User** as **Audio Mode**.
3. Set the parameters according to the audio mode.
 - In **Standard**, **Music**, and **Movie** mode, you can adjust **Balance** and **Volume**.
 - In **User** mode, you can adjust **High Pitch**, **Low Pitch**, **Balance** and **Volume**.
4. Enable **Noise Cancelling** to eliminate the noise of echo. By default, this function is enabled.

Note

It is recommended to enable **Noise Cancelling** before starting a video conference, and the echos from the microphone will be eliminated.

6.4 Language and Input Settings

Steps

1. Go to **Settings** → **Language & Input**.
2. Tap **Language** to select the desired language.
3. Tap **Input Method** to select the desired input method.

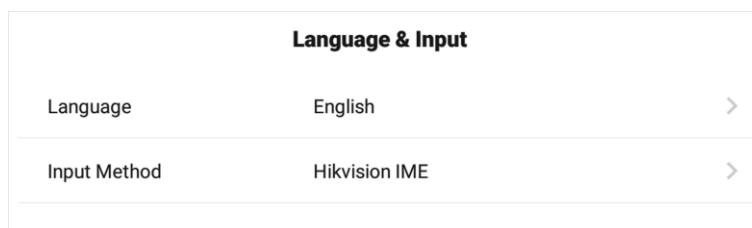

Figure 6-9 Language and Input Settings

Note

Handwriting input is available, and the written content in any text input page will be automatically transformed into system font..

6.5 Time and Date Settings

Steps

1. Go to **Settings** → **Time & Date**.

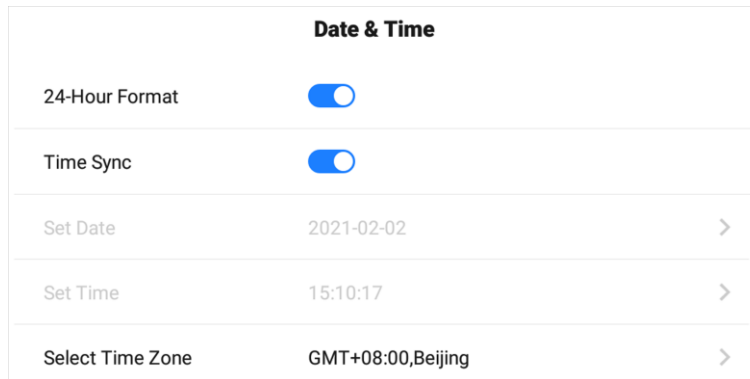

Figure 6-10 Date and Time Settings

2. Enable **Time Sync**.
3. Tap **Select Time Zone** to select the region.
4. Optional: Enable **24-Hour Format** to display the time in 24-hour format.

Note

If **Time Sync** is disabled, you can set date and time manually.

6.6 Application Management

Steps

1. Go to **Settings** → **Application Management**.
2. Tap the desired application to check details.
3. You can perform operations, such as **Forced Stop**, **Clear Data**, **Clear Cache**, and **Uninstall**.

Note

The built-in applications cannot be uninstalled. You can tap the icon in **Application Details** to open the application.

6.7 Bluetooth

Enable **Bluetooth** to search the available devices nearby, and tap the desired one to connect.

6.8. Intelligent Temperature Control

The device monitors inner temperature in real time. When the temperature exceeds the set warning or alarming temperature, the device will display prompt messages for you to take measures in a timely manner.

Steps

1. Go to **Settings** → **Auxiliary Functions** → **Intelligent Temperature Control**.

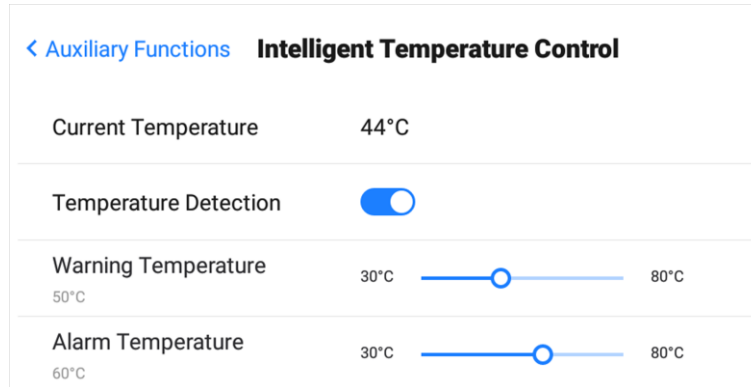

Figure 6-11 Intelligent Temperature Control

2. Enable **Intelligent Detection**.
3. Slide the slider to set **Warning Temperature** and **Alarming Temperature**.

Note

- When the temperature exceeds the set warning temperature, the temperature in status bar on the upper right corner turns orange.
 - When the temperature exceeds the set alarming temperature, the temperature information pops up and prompts you to turn off the device.
-

6.9 Advanced Settings

Select **Settings** → **Advanced Settings**. You can set parameters as follows.

Advanced Settings		
Email	Settings	>
Center controlled	Settings	>
Input Source Settings	Settings	>
Select Camera	None	>
Input Device	USB-Audio - Poly Calisto 5300-M Series	>
Output Device	Loud Speaker	>
Startup/Shutdown Setting	Settings	>
Device Permission Setting	Settings	>
QR Code Sharing Settings	Settings	>

Figure 6-12 Advanced Settings

E-mail

Set the E-mail address for receiving shared contents from whiteboard.

Input Source Settings

Startup Input Source

Select the desired input source as the device starts up. You can select a built-in system, or an external input source.

Auto Switch When Connecting Signal Source

If this function is enabled, the system will switch to the newly-connected input source when an external input source is connected.

Auto Switch When Disconnected from Signal Source

If this function is enabled, the system will switch to the configured input source as the device is disconnected from the external input source.

Select Camera

Select the desired camera among those bound to the device.

Audio Input Device

Select the desired audio input device.

Audio Output Device

Select the desired audio output device.

Startup/Shutdown Settings

Startup Mode

Select **Startup When Powered On** or **Standby When Powered On**.

Scheduled Startup/Shutdown

Set the schedule for startup and shutdown.

No-signal Shutdown

Set the time for auto-shutdown if no signal is accessible.

Device Permission Settings

Disable Wi-Fi

If Wi-Fi is disabled, the device cannot be connected to the wireless network.

Disable Copying from USB Disk

If copying from USB disk is disabled, the device cannot read from external disks.

QR Code Sharing Settings

Share the content of whiteboard through a QR code.

Share in LAN Only

Devices in the same LAN as the tablet can scan the QR code to download the content.

All Networks

Devices connected to all networks can scan the QR code to download the content.

Device Permission Settings

Wake from Serial Port

If this function is enabled, the device in standby status can be waken up by serial port command.

Wake from Signal Source

If this function is enabled, the device in standby status can be waken up if an input signal source is connected.

HDMI Output Settings

Connect the device through HDMI interface to share the contents. You can set the desired resolution, and enable audio and HDCP.

USB Settings

Follow Systems, **Android** and **PC** modes are available.

Boot Animation Settings

Set the boot animation for the device.

6.10 Security

Go to **Settings** → **Security** to enable screen lock and set your password.

6.11 Device Information

Go to **Settings** → **About** to check the device information. The device name is customizable, and you can restore the device to the default settings.

Warning

All the data will be lost if the settings are restored to the default status.

Chapter 7 Intelligent Applications

7.1 FileBrowser

Tap **FileBrowser** on the main page. All the files under the current directory are shown by default. Tap **Image**, **Doc**, **AV**, or **Installation Package** to view specified files. Icons are described as follows.

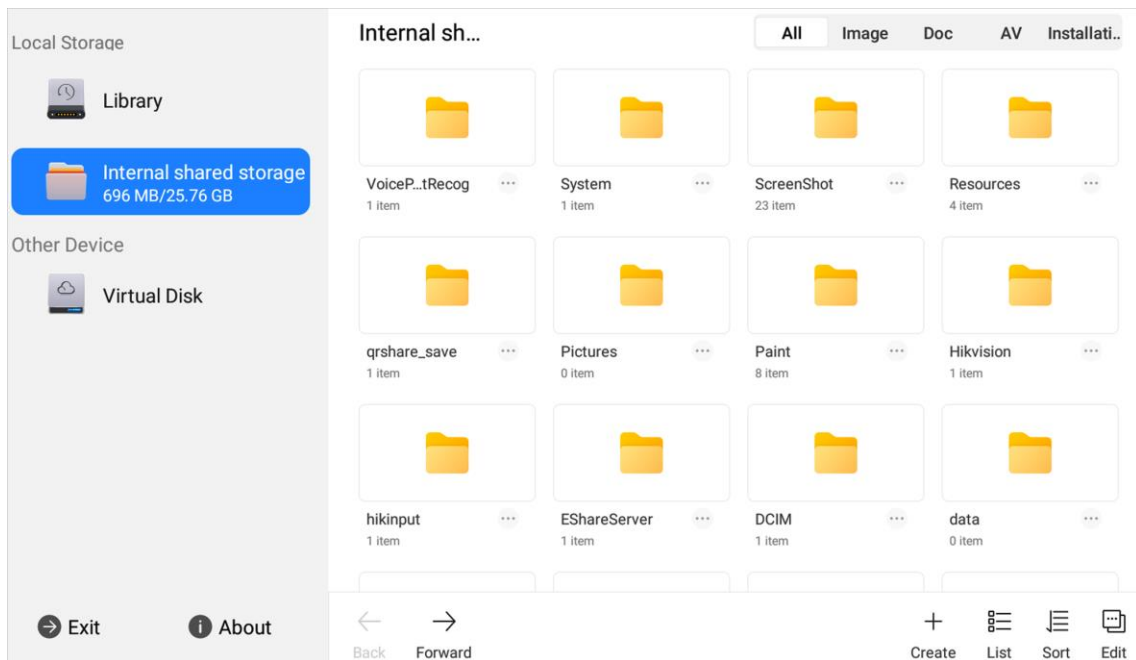

Figure 7-1 File Management

Table 7-1 Descriptions of File Management Icons

Icon	Description	Icon	Description
Back/Forward	Go to the previous/next page.	Create	Create a new folder.
Grid/List	View the files in grid or list mode.	Sort	Change the file order.
Edit	Edit the files.	--	--

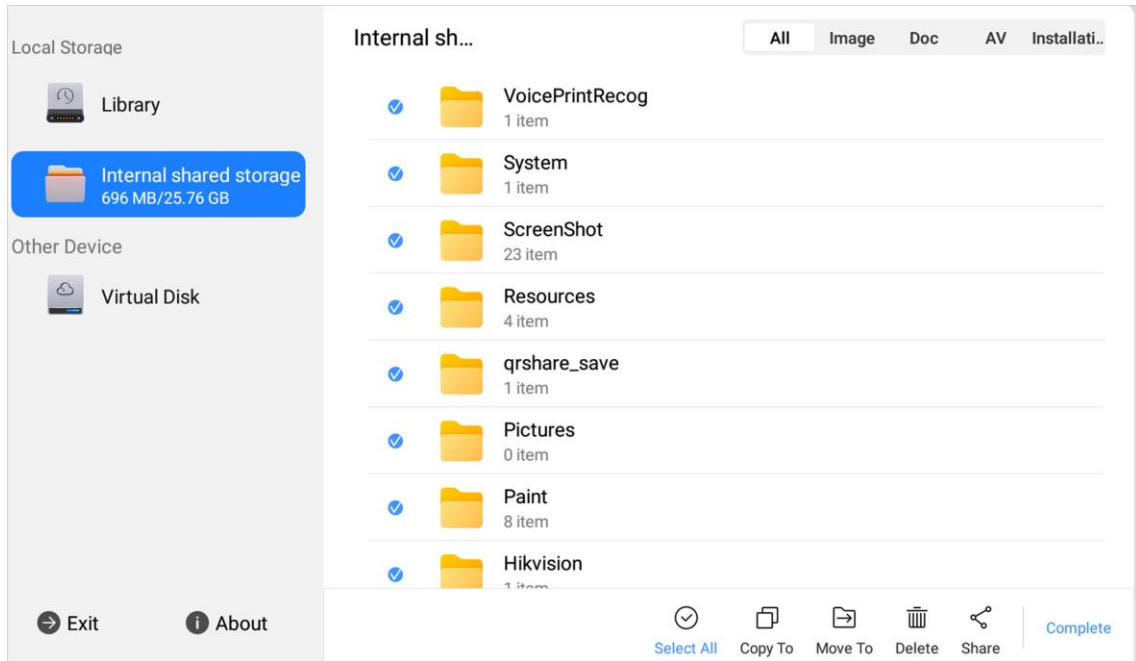

Figure 7-2 Edit the Files

Table 7-2 Descriptions of Editing Icons

Icon	Description	Icon	Description
Select All	Select all the files.	Copy To	Copy the selected file(s) to another folder.
Move To	Move the selected file(s) to another folder.	Delete	Delete the selected file(s).
Share	Share the selected file(s).	Complete	Turn back to the original page.

Note

Long press the file to perform other operations.

7.2 Browser

Connect the device to the Internet, and tap **Browser**. Enter URL in the address bar to view texts, pictures, audios and videos on the Internet.

7.3 System Pre-installed Applications

The following table briefly describes the applications pre-installed in the system. Refer to the help document of desired application, to get more details.

 **Note**

The system pre-installed applications vary from different device types.

Table 7-3 Introduction of System Pre-installed Applications

Application	Introduction
Whiteboard	It is applied to draw and write. You can use it to save, move, zoom in, zoom out, delete, and download the contents.
Gallery	It is used for viewing pictures in SD card and USB disk.
Upgrade	It provides remote upgrade and local upgrade, and upgrade of local components.
HIK-share	An application used to connect tablet, mobile phone, or PC for screen mirroring.
Camera	It is used for taking picture by camera.

Appendix A FAQs

Question	Cause and Solution
<p>Why do the condensations appear frequently on the screen?</p>	<p>Tempered glass is installed on the outer screen to provide protection. There is a gap between the screen and the tempered glass for air convection. The main reason is that there is a temperature difference between the screen and the outside. Hot air condenses on the glass surface at a lower temperature, which results in condensations.</p> <p>Condensations will evaporate after the device starts up and will not affect the use of the device.</p>
<p>Why there is no sound coming from my laptop after connection?</p>	<p>If only audio cable is accessed, both audio output and image output will be unavailable.</p> <ul style="list-style-type: none"> ● Access HDMI cable. ● Select the device as the audio output device in Windows.
<p>Why does the screen get hot after a period of use?</p>	<p>Screen temperature rise is caused by heat dissipation and is completely normal. Our heat dissipation design is industrial-leading and is the formulator of the industry standards, which is in accordance with the national health standard.</p>
<p>Does long-time use damage the eyes?</p>	<p>The recognition of flicker by human eyes is 50Hz. If the frequency is lower than 50Hz, then the flicker will be recognized and cause eye muscles fatigue. We use 60Hz LCD screen, human eyes will not recognize the flicker of the screen. Compared with other products of the same kind, it can reduce eye fatigue to a large extent.</p>
<p>Why there is no image in screen nor sound coming from the device?</p>	<ul style="list-style-type: none"> ● Check if the power cable is connected. ● Check if the socket works normally. ● Check if the power switch is turned on.
<p>Why does the device HDMI channel have no input signal?</p>	<ul style="list-style-type: none"> ● Check if the input source works normally. ● Change HDMI interface or cable. ● If PC is accessed, set HDMI output on your PC.
<p>Why is wired network unstable?</p>	<p>Try to disable the auto network detection option.</p>



See Far, Go Further