

htc®



VIVE®

VIVE Pro 2 User guide

Contents

Getting started

System requirements	5
Setting up VIVE Pro 2 for the first time	6
What's the highest resolution on VIVE Pro 2, and how do I enable it?	7
Can I mix versions of base stations, link boxes, or cables?	7

Headset and link box

Headset	9
VIVE Link Box (2.0)	26
Product care and repair	29
Common solutions	36

Base stations

Base Station 2.0	42
Base Station 1.0	53
Base Station 1.0 and 2.0 FAQs	58

Controllers

About VIVE Controllers (2018)	60
Charging the controllers	61
Turning the controllers on or off	61
Pairing the controllers with the headset	61
Attaching the lanyards to the controllers	62
Updating controller firmware	63
What does the status light on the controllers mean?	64
What should I do if a controller is not tracked?	64
How do I know which controller is not tracked?	64
What can I do if the controller trackpad is oversensitive?	65
What should I do if my controller won't turn on?	66
The controller automatically turns off. What should I do?	66
How do I recover my controller after an interrupted update?	67

Play area

What is the play area?	68
Choosing the play area	68
Planning your play area	69
Setting up a standing-only play area	70
Setting up a room-scale play area	71
Verifying your setup	72
After setting up, how do I turn the VIVE system on?	72
What is the recommended space for the play area?	73
Can I include space occupied by furniture for the play area?	73
Can seated/standing-only experiences work at room scale?	73
How do I fix download errors during VIVE Setup installation?	73
I can't complete the room setup. What should I do?	73

Settings

Audio settings	74
System Dashboard settings	75
SteamVR	76
VIVE Console	79

Trademarks and copyrights

Index

About this guide

We use the following symbols to indicate useful and important information:



This is a note. It provides detailed information for setup, common questions, and what to do in specific situations.



This is a tip. It will give you an alternative way to do a particular step or procedure that you may find helpful.



This indicates important information that you need in order to accomplish a certain task or to get a feature to work properly.



This is a warning. Take note to avoid potential problems or prevent damage to your hardware.

Information contained in this guide may have changed. For the most up-to-date information, including the latest version of this guide, go to [VIVE Enterprise Support](#).

Before using the product, carefully review VIVE safety information and follow all product safety and operating instructions on <https://enterprise.vive.com/legal/>.

Getting started

System requirements

To use VIVE Pro 2, your computer must meet the following system requirements:

Component	Recommended system requirements	Minimum system requirements
Processor	Intel® Core™ i5-4590 / AMD Ryzen™ 1500 equivalent or better	Intel Core i5-4590 / AMD Ryzen 1500 equivalent or better
GPU	NVIDIA® GeForce® RTX 2060 / AMD Radeon™ RX 5700 equivalent or better	NVIDIA GeForce GTX 1060 / AMD Radeon RX 480 equivalent or better
Memory	8 GB RAM or more	8 GB RAM or more
Video output	DisplayPort™ 1.4 or newer required to use headset's full resolution	DisplayPort 1.2 or newer
USB port	1x USB 3.0 or newer	1x USB 3.0 or newer
Operating system	Windows® 10	Windows 10



- Make sure to use VIVE Link Box (2.0) and VIVE Headset Cable (2.0) included with VIVE Pro 2.
- NVIDIA GeForce RTX 20 series (Turing), AMD Radeon 5000 (Navi) series, or better and support for Display Stream Compression (DSC) are required to run the headset at full resolution.
- The VIVE Wireless Adapter supports a maximum resolution of 3264 x 1632 at a 90 Hz refresh rate when used with VIVE Pro 2.
- USB 3.0 is also known as USB 3.2 Gen 1.

Setting up VIVE Pro 2 for the first time

Before using VIVE Pro 2, you'll need to complete the setup process, which includes installing VIVE™ and SteamVR software, setting up the hardware, and defining your play area.



Make sure to use VIVE Link Box (2.0) and VIVE Headset Cable (2.0) included with VIVE Pro 2.

1. Download the setup file on your computer from www.vive.com/setup. Run the setup file.
2. Follow the walkthrough to install the software and set up your hardware.

When you see the hardware setup screen, follow the onscreen instructions to set up your base stations, headset, and controllers. You can also see the topics below to learn how to set them up:

- Depending on the type of base stations you're using, see [Installing SteamVR Base Station 2.0](#) on page 44 or [Installing Base Station 1.0](#) on page 54.
- To connect VIVE Pro 2 to your computer using the link box, see [Connecting the headset to your computer](#) on page 27.
- To know more about the controllers and how to turn them on, see [About VIVE Controllers \(2018\)](#) on page 60 and [Turning the controllers on or off](#) on page 61.
- To set up your play area, see [Play area](#) on page 68.

After you install everything, use the SteamVR app to check that your VR equipment—including the base stations, headset, and controllers—is tracked.

Use SteamVR to change your play area. You might need to do this if you adjust the base stations or move your system to a different room.

Use the VIVE Console app to change headset-related settings. To find out how to change the display resolution, see [Changing headset display settings](#) on page 79.

What's the highest resolution on VIVE Pro 2, and how do I enable it?

VIVE Pro 2 features an ultra-high resolution of 4896 x 2448, and uses Display Stream Compression (DSC) to transmit over the DisplayPort cable. Video stream compression with DSC is automatic and has no noticeable change in quality.

To use the full display resolution, make sure that:

- Your graphics card is DSC capable. See [System requirements](#) on page 5 for the graphics card requirements.
- You use VIVE Link Box (2.0) and VIVE Headset Cable (2.0) that came with VIVE Pro 2.

By default, the VIVE Console app automatically sets the headset display settings based on the capabilities of your graphics card. You can manually change the settings. See [Changing headset display settings](#) on page 79.

Can I mix versions of base stations, link boxes, or cables?

Check the tables below to see which versions of the link box, headset cable, base station, and other accessories are compatible with VIVE Pro 2.

Link box and headset cable compatibility:

VIVE hardware	VIVE Link Box (2.0) and VIVE Headset Cable (2.0)	Link Box and Headset Cable for VIVE Pro
VIVE Pro 2	✓	
VIVE Pro Eye	✓	✓
VIVE Pro	✓	✓



Don't mix different generations of the link box and headset cable. Make sure they're the same generation.

Base station compatibility:

VIVE hardware	Base Station 2.0	Base Station 1.0
VIVE Pro 2	✓	✓
VIVE Controllers (2018)	✓	✓
VIVE controllers		✓
VIVE Tracker (3.0)	✓	✓
VIVE Tracker (2018)	✓	✓



Use only the same version of base stations together. Different base station versions are not interchangeable.

Headset and link box

Headset

About the VIVE Pro 2 headset

The headset is your window to the VR environment. It has sensors that are tracked by the base stations.



The sensors on the headset are sensitive. Do not cover or scratch the sensor lenses, including the proximity sensor.

Front and side

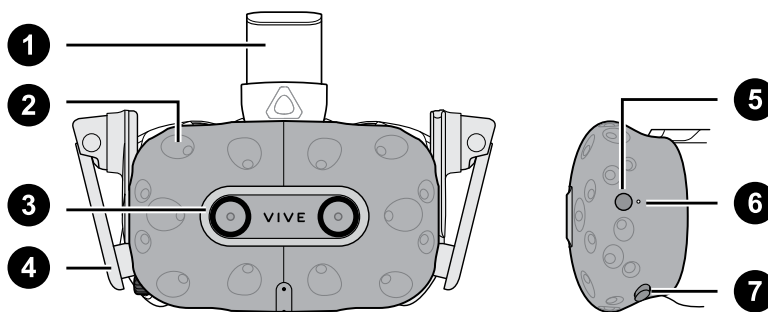

1	Headset strap
2	Tracking sensor
3	Camera lens
4	Earphone
5	Headset button
6	Status light
7	Lens distance button

Back

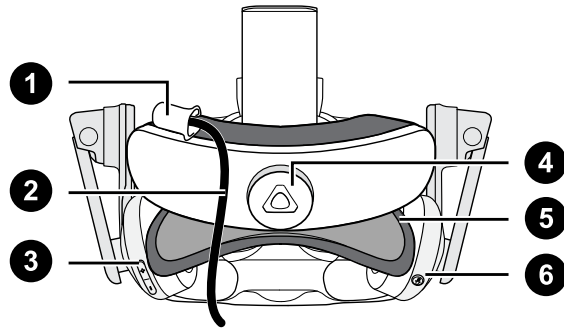

1	Headset cable clip
2	Headset cable
3	Volume button
4	Adjustment dial
5	Head pad
6	Mic mute button

Bottom and inner

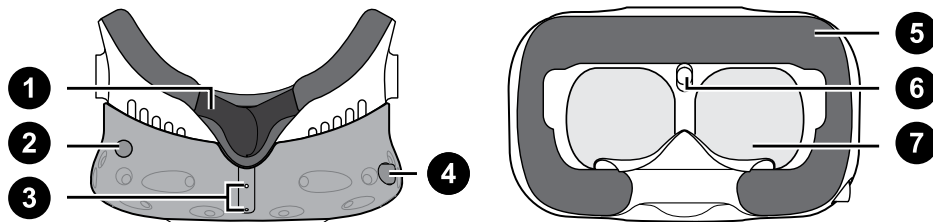

1	Nose rest
2	Lens distance button
3	Mic
4	Interpupillary distance (IPD) knob
5	Face cushion
6	Proximity sensor
7	Lenses

Putting on the VIVE Pro 2 headset

Before putting on the headset, make sure to remove the protective film or paper cover from the lenses. Keep it in a safe place so you can protect your headset during storage or shipping.

1. Loosen the strap by rotating the adjustment dial counter-clockwise, and then detach the velcro fastener on the top band.

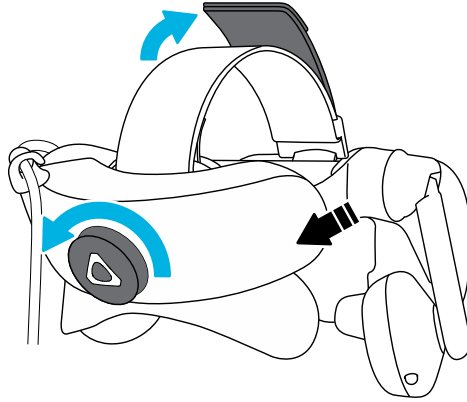

2. Press the headset towards your eyes, and then slide the strap around the back of your head.

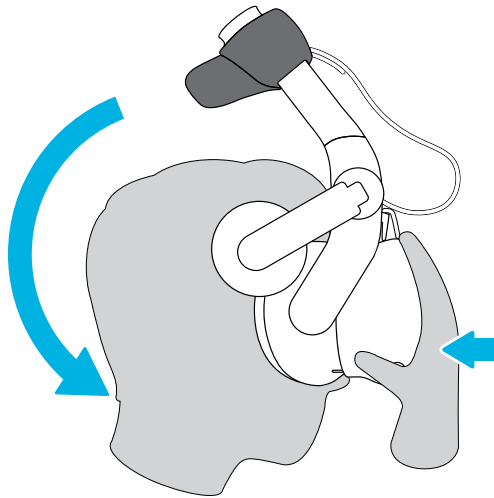

3. Rotate the adjustment dial clockwise until the headset fits snugly, and then reattach the velcro fastener on the top band.

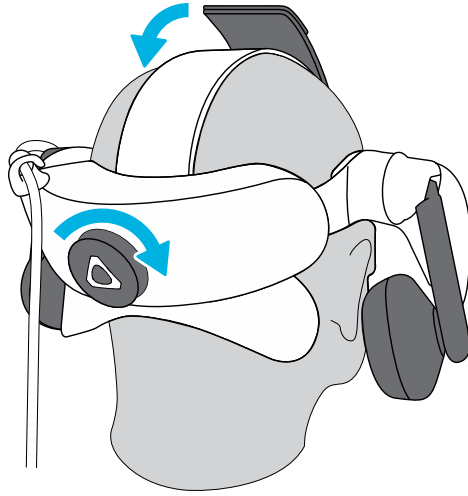

4. Adjust the earphones to a comfortable position over your ear, and then press the earphones towards your ears until they're properly in place.

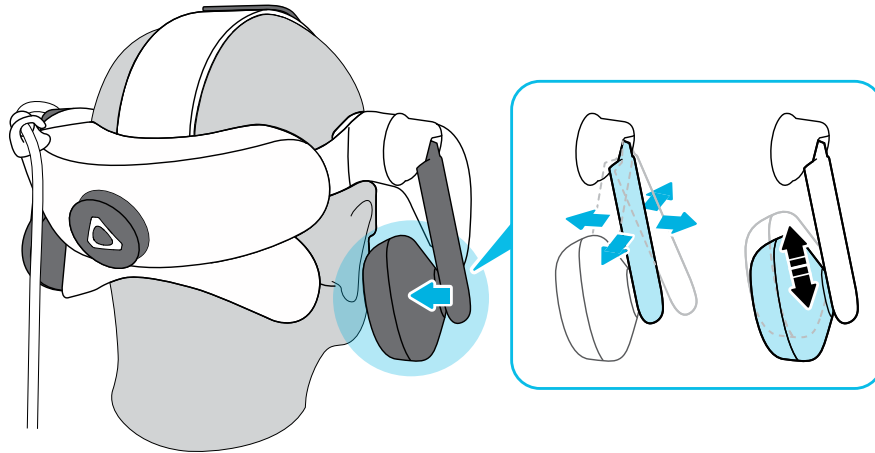

5. Make sure that the headset cable passes through the cable clip at the back of the headset, and is positioned straight down your back.

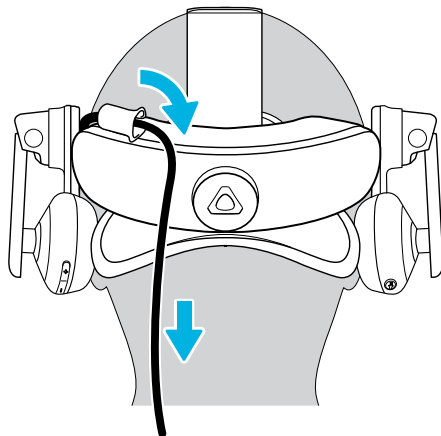

When taking the headset off, remember to loosen the strap first by rotating the adjustment dial counter-clockwise.

Adjusting the IPD on the headset

Interpupillary distance (IPD) is the distance between the centers of your eyes.

If you don't know your IPD, see [How can I find my IPD?](#) on page 14. Use this measurement as a guide to adjust the distance between the lenses of the headset so that you'll have a better viewing experience.

To increase the distance between the lenses, rotate the IPD knob clockwise. To decrease, rotate the IPD knob counterclockwise.

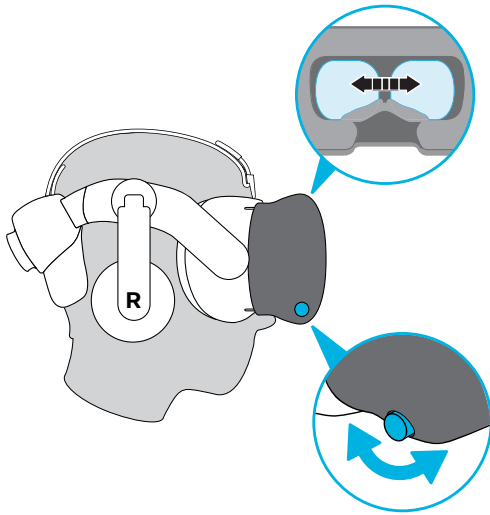

As you adjust the IPD, you'll see a prompt indicating the current distance between the centers of the lenses.

Why is accurate IPD important?

Accurate IPD settings help get a clear image and reduce eye strain.

The headset lenses focus images toward their optical center. This is sometimes called the "sweet spot" in the VR industry. By adjusting the IPD knob, you can tune the sweet spot for the most comfortable view. Misaligned IPD and improperly adjusted headsets are common causes of blurry images, dizziness, and eye strain.

How can I find my IPD?

There are several ways to estimate your IPD.

The most accurate way to determine your IPD is to consult a professional optometrist or eye doctor. You can also estimate your IPD by doing any of the following:

- Use a ruler and a mirror. See below for detailed instructions.
- Through experimentation. See below for detailed instructions.
- Using third-party apps or websites.



Third-party apps or websites may collect personal data. HTC cannot guarantee accuracy of third-party apps or websites in measuring IPD.

Estimating your IPD in a mirror

You can estimate your IPD with a ruler and mirror.

This method requires a millimeter ruler.

1. Stand directly in front of a mirror, and then hold the ruler up to your eyes. Make sure that the ruler is level. If you're using a flexible ruler, make sure not to bend it.



2. Align the zero mark with the center of your pupil. You may need to close your other eye to get a clear measure.

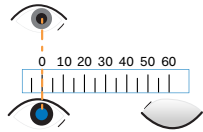

3. Check the millimeter mark on the other eye. You may need to close the first eye to get a clear measure.

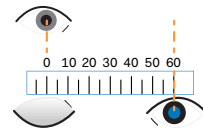

4. Make a note of your IPD measurement. You may want to recheck several times to make sure your reading is accurate.



You can also ask a friend to help you measure instead of using a mirror. Make sure you're looking straight ahead while they measure.

Estimating your IPD through experimentation

You can estimate IPD by trying different settings. This method is very convenient, but might be less accurate.

1. While wearing the VR headset, focus on text or lines at the center of view. If no text is present, open a screen in VR with text.
2. Adjust the IPD knob until the text is clear. Note the number for future use.
3. If the image in one eye is clearer than the other, adjust the headset position. Repeat until images are clear for both eyes.

Can I wear my prescription glasses while using VIVE Pro 2?

Most glasses fit inside the headset. If you wear large prescription glasses, adjust the lens distance to increase the space in the headset.



Make sure that no part of your glasses scratch the headset lenses.

Adjusting the lens distance on the headset

If you wear large prescription glasses or have long eyelashes, you may need to increase the lens distance further from your face. Only increase this distance as necessary, as the closer the lenses are to your eyes, the better your field of view will be while wearing the headset.



- Make sure that no part of your glasses scratch the headset lenses.
- Do not attempt to adjust the visor without pressing the lens distance button.

Press and hold the lens distance button on the headset, and then pull or push the visor to adjust the lens farther or closer to your face.

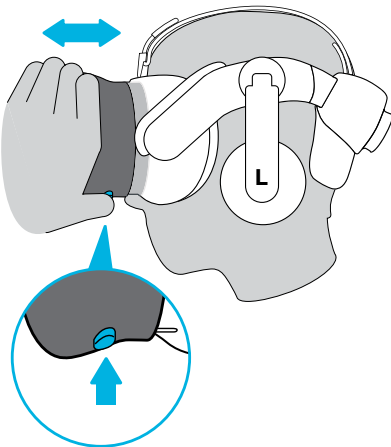

Replacing the face cushion

You can remove the face cushion to clean it. For more information, see [Cleaning the face cushion](#) on page 30.

1. To remove the face cushion, peel off starting from both ends of the face cushion until it detaches from the headset.

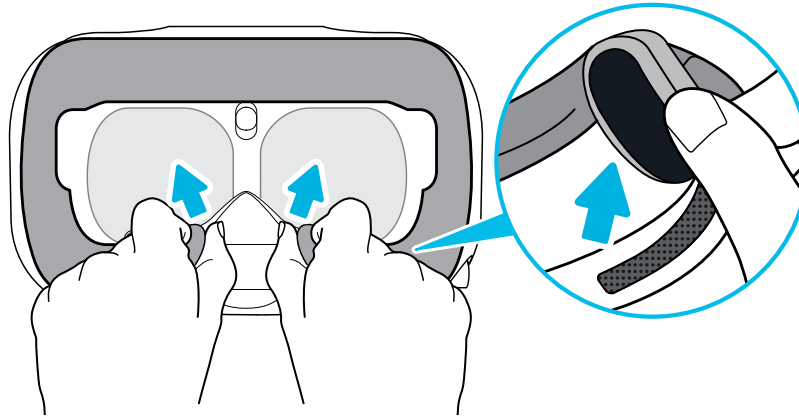

2. To replace the face cushion, insert the tab on the face cushion into the slot on the headset, and then align the hook and loop strips.

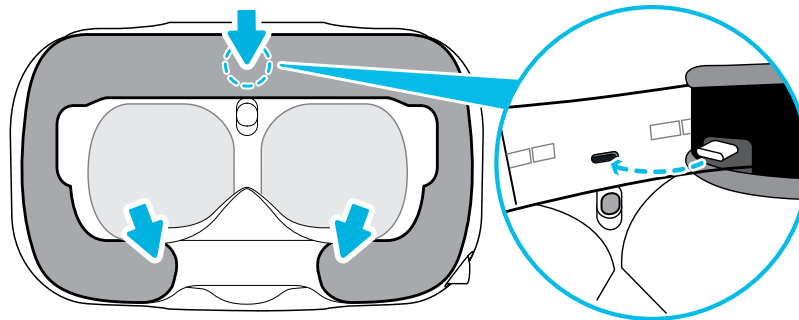

Connecting a USB device to the VIVE Pro 2 headset

You can connect a USB Type-C compatible third-party device to VIVE Pro 2 headset using a USB cable.

1. Remove the face cushion from the headset visor by peeling it off from both ends.

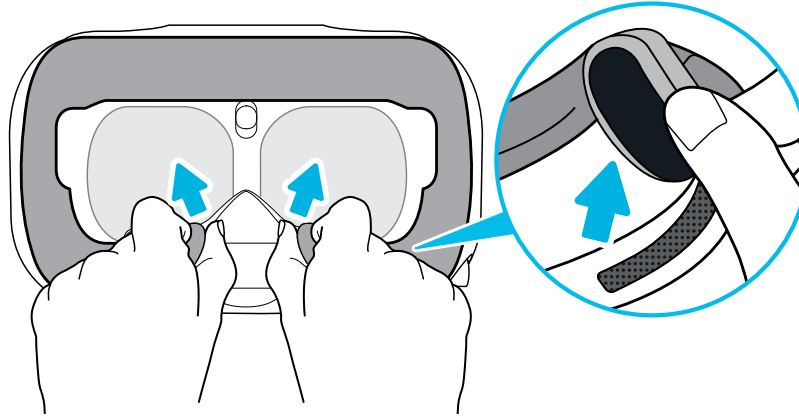

2. Carefully pull the flap on the left side of the headset visor to remove the compartment cover and access the headset cable ports.

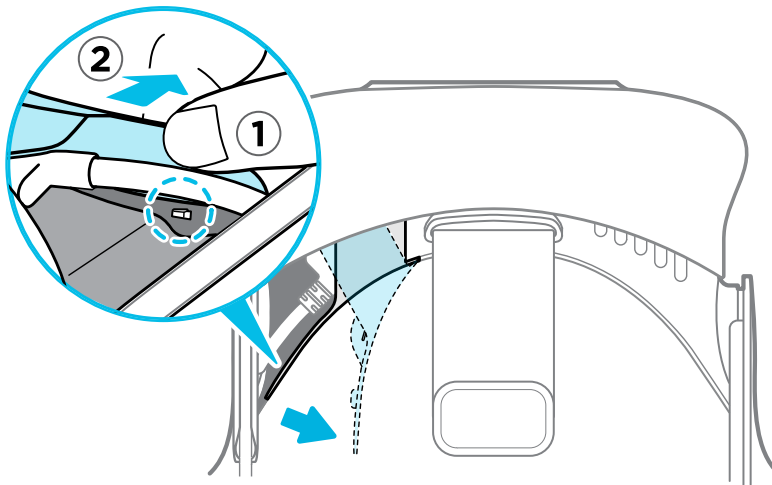

3. Insert the cable connector of the device to the USB Type-C port on the headset.

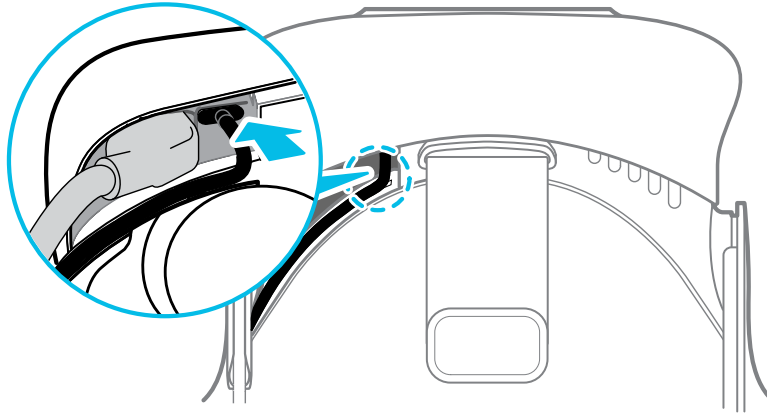

4. Align and push the tabs of the compartment cover onto their corresponding holes.

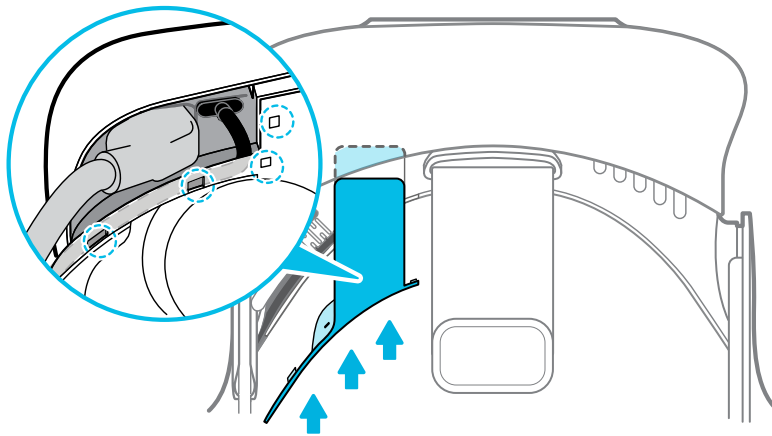

5. Replace the face cushion by inserting its tab into the slot on the headset, and then aligning the hook and loop strips.

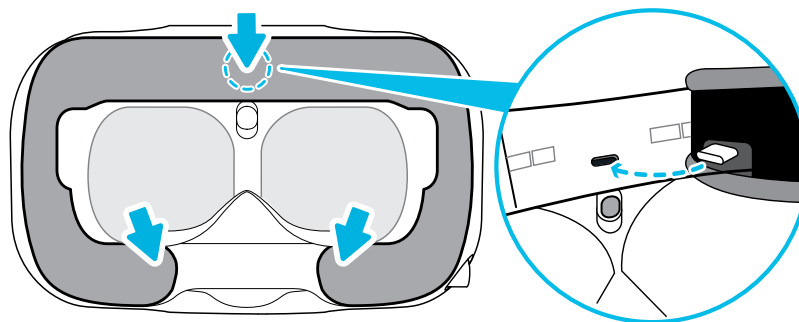

6. Connect the other end of the USB cable to the third-party device.

Removing the headset earphones

If you need to, you can remove the headset earphones.

1. Peel off the side cushions on the strap near the earphones.

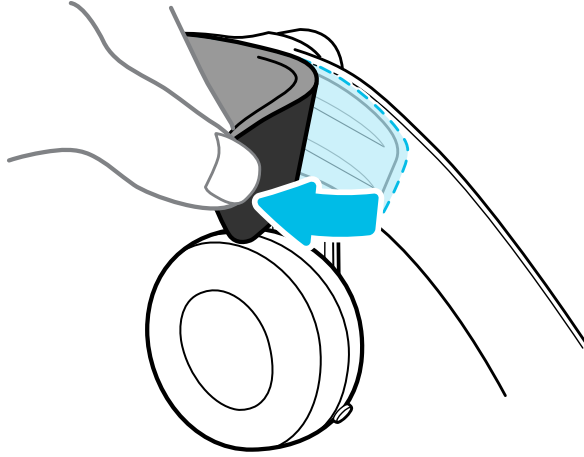

2. Use a Phillips-head screwdriver (PH00) to detach the earphone from the strap.

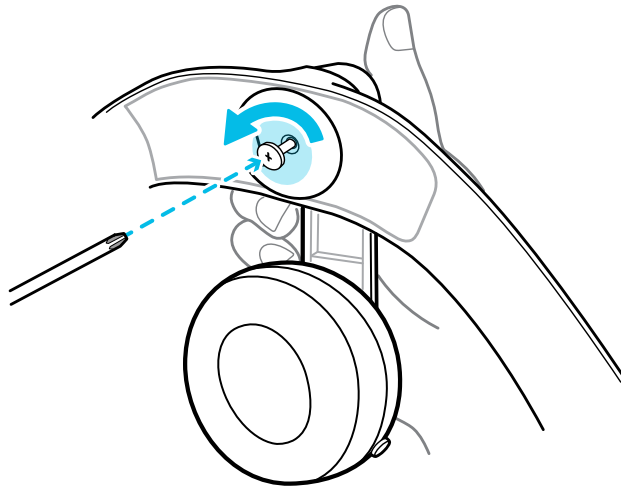

3. Gently pull each earphone until it detaches from the strap and then set it aside.

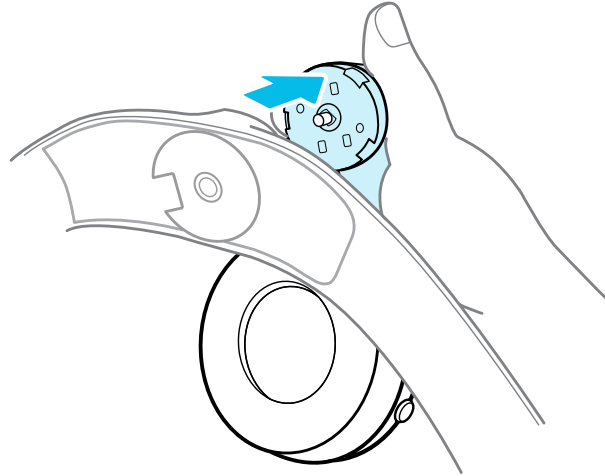

4. Replace the cap with the screw you removed earlier.

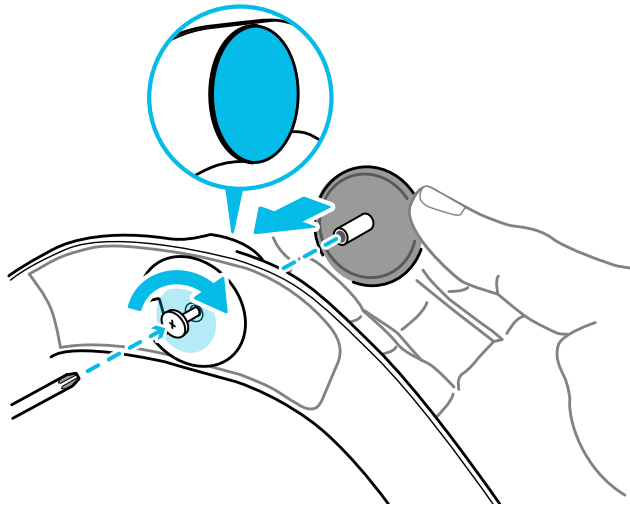

After detaching the earphones, make sure to put them in a safe place. Do not squeeze or press down the earphones. When storing, do not put the earphones under a heavy object that could press or squeeze them down.

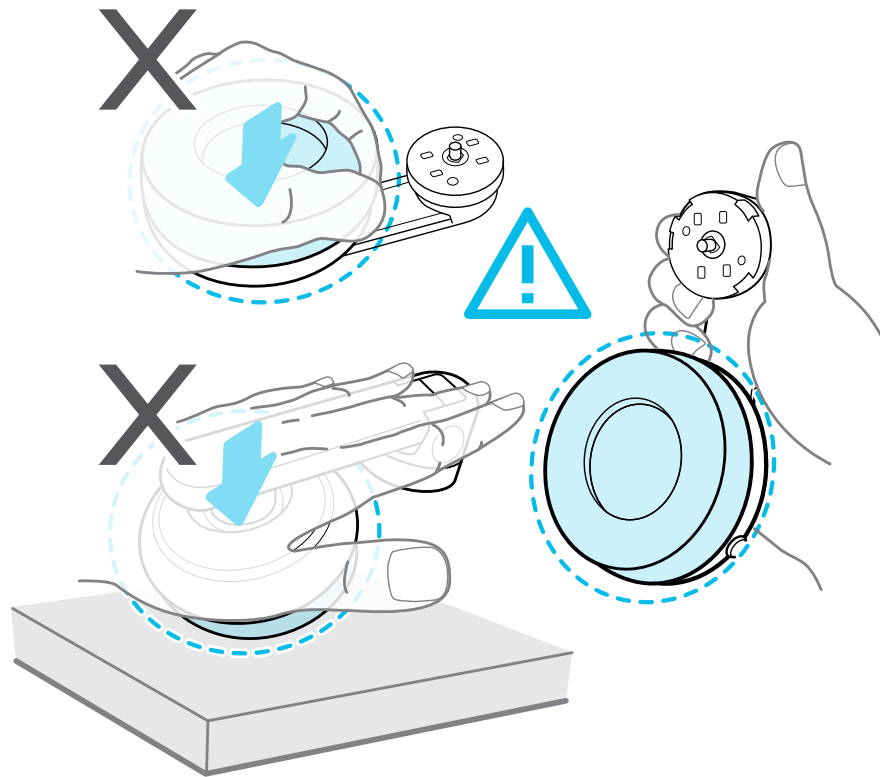

Replacing the headset earphones

You can use your own USB Type-C[®] compatible earphones with the VIVE Pro 2 headset. If you want to use compatible 3.5mm earphones, you'll need a USB Type-C to 3.5mm audio adapter.

1. Remove the headset earphones first, otherwise audio will still come out from them. For details, see [Removing the headset earphones](#) on page 20.
2. Remove the face cushion from the headset visor by peeling it off from both ends.

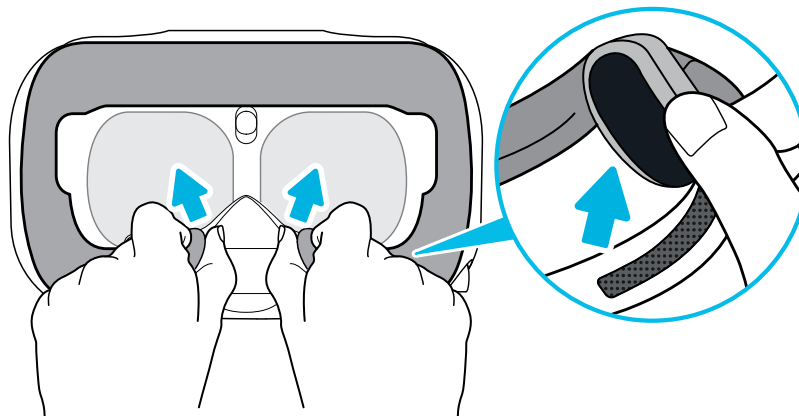

3. Carefully pull the flap on the left side of the headset visor to remove the compartment cover and access the headset cable ports.

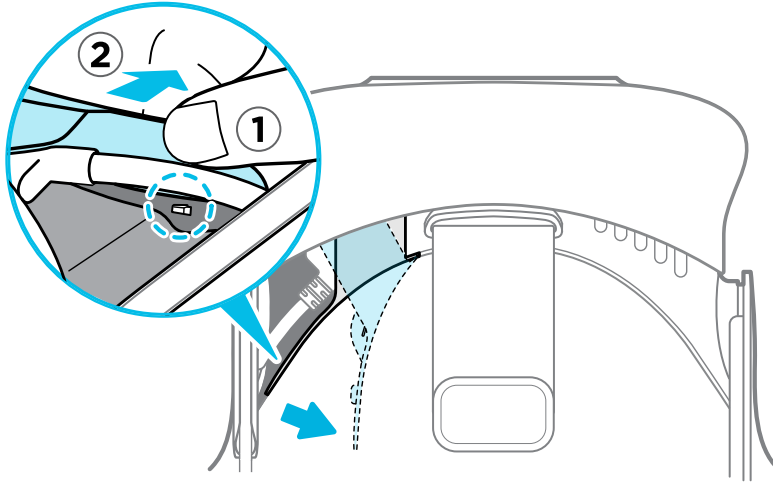

4. Insert the cable connector of your earphones on the USB Type-C port.

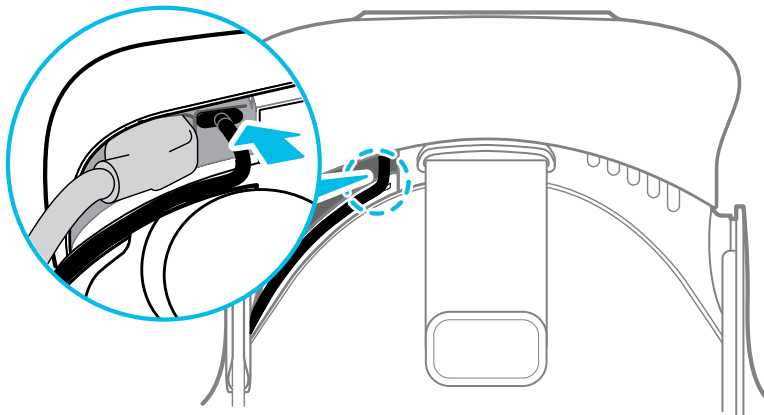

5. Align and push the tabs of the compartment cover onto their corresponding holes.

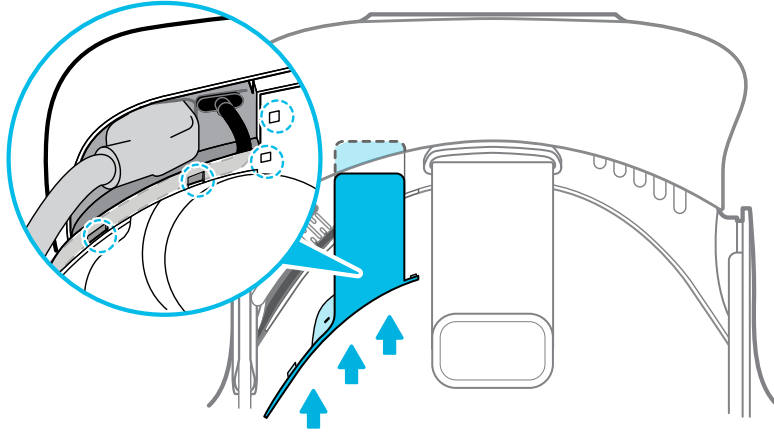

6. Replace the face cushion by inserting its tab into the slot on the headset, and then aligning the hook and loop strips.

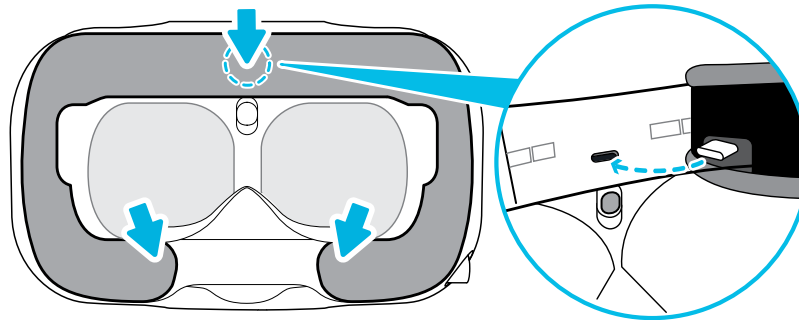

Reattaching the head pad on the headset strap

Always make sure that the head pad is attached to the headset.

1. Hold the headset upside down.
2. Pin the head pad's right-most tab with its corresponding slot on the headset strap.

3. Press the tabs on the head pad's right side into the slots on the headset strap to lock the tabs in place.

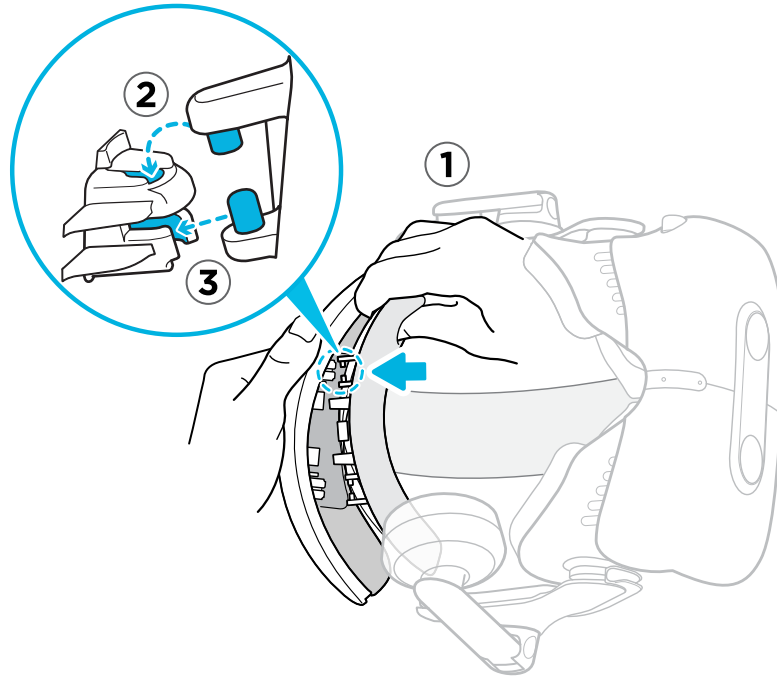

4. Gently bend the base of the head pad's left side to align its tabs with the slots on the headset strap.
5. Press the tabs on the head pad's left side into the slots on the headset strap to fully attach the head pad.

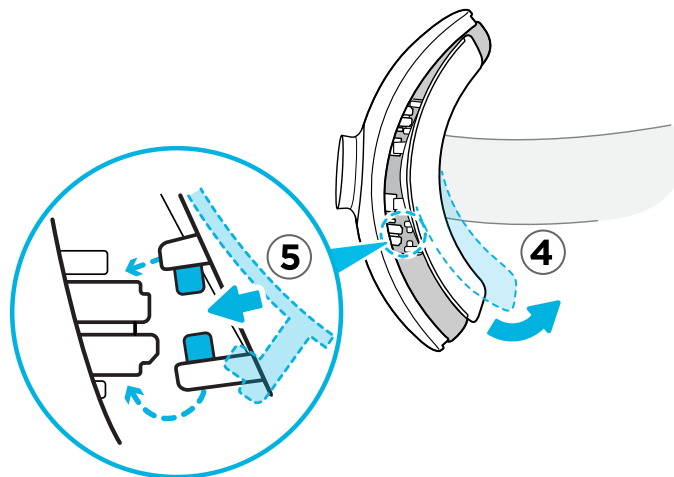

Updating the headset firmware

1. From your computer, open the SteamVR app.
2. If you see the  icon, mouse over it to check if the firmware is out of date.

3. Click **Update Device**. The firmware update will start automatically.



Do not unplug any cables from the headset, link box, or your computer any time before the firmware update is complete. Doing so could result in a firmware error.

4. When the update is complete, click **Done**.

What does the status light on the headset mean?

The status light shows:

- Green when the headset is in normal mode
- Dim green when the headset is on standby
- Red when an error is encountered (with cables, display, or the like)

What is the dual camera used for?

The dual camera brings real world into VR. Some VR content will use the dual camera to scan your room and integrate it with the VR experience.

Whenever you're in the System Dashboard, you'll also see a window showing your actual room.

To activate the dual camera, see [Activating the dual camera](#) on page 76.

VIVE Link Box (2.0)

About VIVE Link Box (2.0)

Use VIVE Link Box (2.0) and VIVE Headset Cable (2.0) to connect VIVE Pro 2 to your computer.

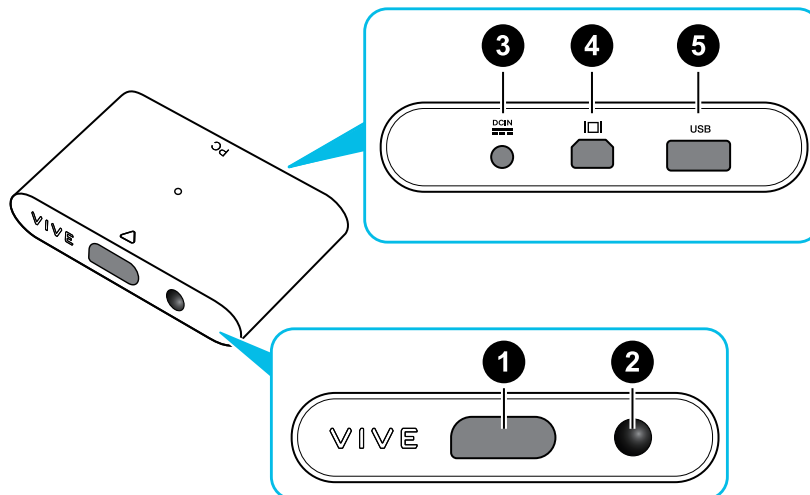

1	Headset cable port
2	Power button
3	Power port

4	DisplayPort port
5	USB 3.0 port

Connecting the headset to your computer

Make sure to use VIVE Link Box (2.0) and VIVE Headset Cable (2.0) included with VIVE Pro 2.

1. Connect the USB 3.0 cable, DisplayPort cable, and power adapter cable on their corresponding slots on the link box.
2. Plug the power adapter into an electrical outlet.
3. Insert the opposite end of the USB 3.0 cable on your computer's USB port.
4. Insert the DisplayPort cable end to the DisplayPort port on your computer's graphics card where the monitor is also connected. Do not connect the DisplayPort cable to ports on the motherboard.
5. Insert the headset cable connector (side with triangle mark up) to the port on the link box with the corresponding triangle mark.

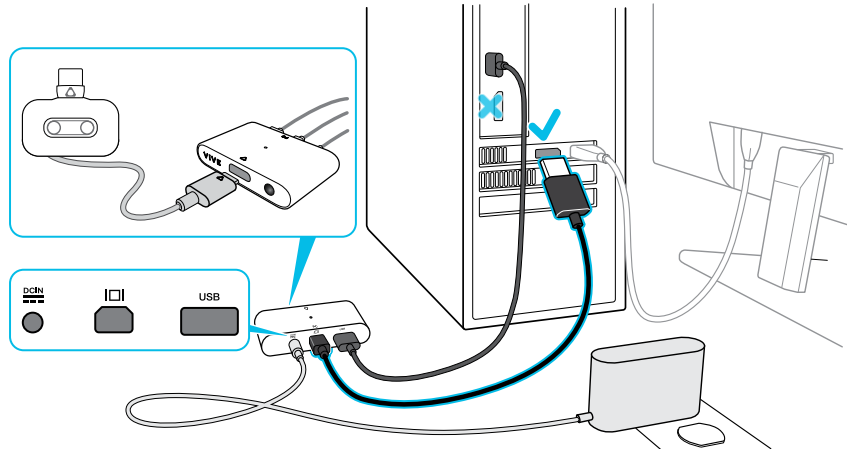

6. Press the Power button to turn the link box on.

Can I use my laptop with VIVE Pro 2?

Yes, as long as your laptop meets the system requirements for VIVE Pro 2.

If your laptop does not have a DisplayPort port but has a Mini DisplayPort port instead, use the Mini DisplayPort-to-DisplayPort adapter that came with VIVE Pro 2.



A Mini DisplayPort-to-DisplayPort adapter may block another port on your laptop.

Restarting the link box

If you're experiencing tracking or other issues, restarting your link box might help. Here's how:

- 1.** Close VIVE Console and SteamVR on your computer.
- 2.** Press the Power button to turn the link box off, and then press the Power button again to turn it back on.

On your computer, you might see a notification that drivers are being installed. Wait for the installation to finish.

- 3.** To verify that VIVE hardware is detected, restart VIVE Console on your computer.

In VIVE Console, you should see the message `Connected to SteamVR`.

Can I use my old link box and headset cable with VIVE Pro 2?

No. VIVE Pro 2 features a higher resolution display than earlier models, which requires you to use the upgraded VIVE Link Box (2.0) and VIVE Headset Cable (2.0).

VIVE Link Box (2.0) and VIVE Headset Cable (2.0) come in the box when you purchase VIVE Pro 2. Check their labels. Make sure they match the image below.

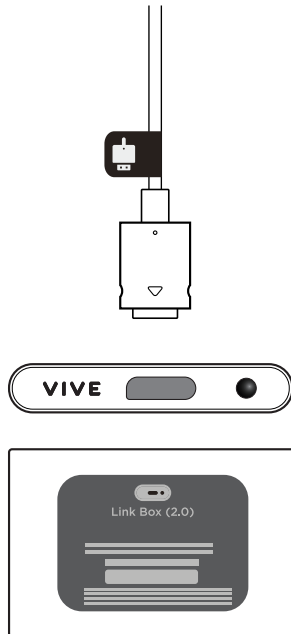

Product care and repair

Caring for your VIVE Pro 2

Follow these tips to properly care for your VIVE Pro 2.

- To clean the exterior of the headset and controllers, wipe them down with a clean microfiber cloth.
- Keep the headset lenses away from sharp objects, including cable tips. This will prevent the headset lenses from being scratched.

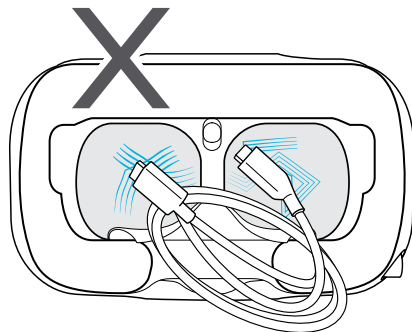

- Avoid direct exposure to intense light or glare, such as bright sunlight or lasers, as it may damage your headset display.
- When storing the headset, it is recommended to cover the lenses with the protective film or paper cover to help prevent accidental scratches.

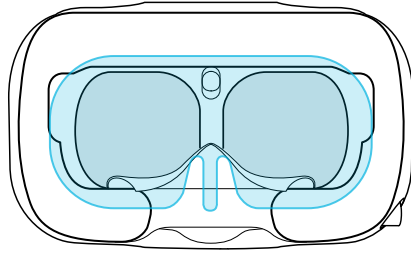

Cleaning the face cushion

1. Before cleaning the face cushion, remove it first from the VIVE Pro 2 headset. For details, see [Replacing the face cushion](#) on page 17.
2. When cleaning the face cushion, remember to:
 - Dampen a clean smooth cloth with cold water and gently wipe the area you want to clean.
 - Air dry at room temperature. Don't tumble dry, iron, or expose it to direct sunlight.
 - Don't scrub, wring, or bleach.
 - Don't dip or soak in water.

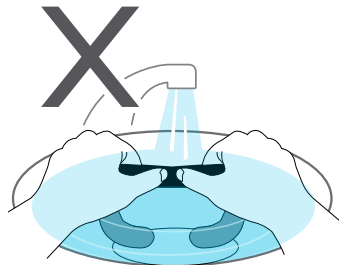

Cleaning the headset lenses

Use the cleaning cloth provided in the box to wipe the headset lenses.



Make sure the cloth is dry before using it to clean the lenses.

Wipe in a circular motion from the center to the outer edges of the lenses.

While cleaning the lenses, do not scratch the lenses nor disassemble other parts of the headset.

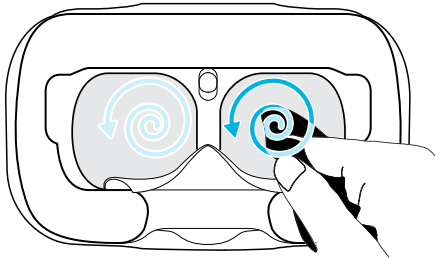

You can also use an air pump to blow away dust and particles from the headset lenses.

How do I prepare the headset if I'm returning it for repair?

Before sending in the headset for repair, remove the following accessories and store them for safekeeping:

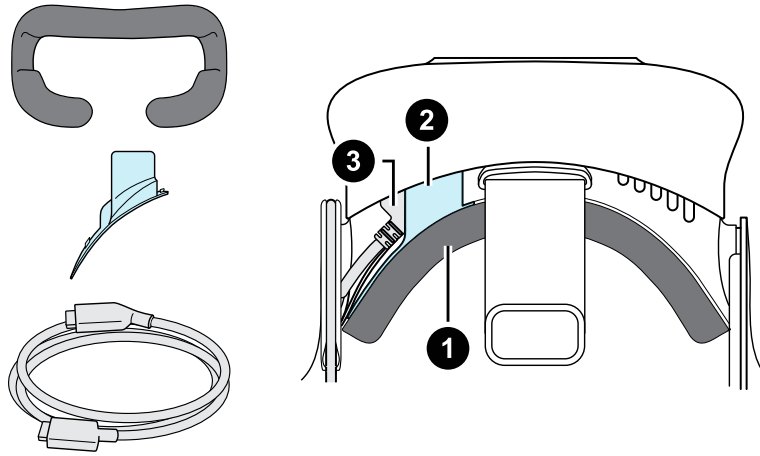

1	Face cushion
2	Compartment cover
3	Headset cable

Follow these steps to properly detach the accessories from the headset:

- Remove the face cushion from the headset visor by peeling it off from both ends.

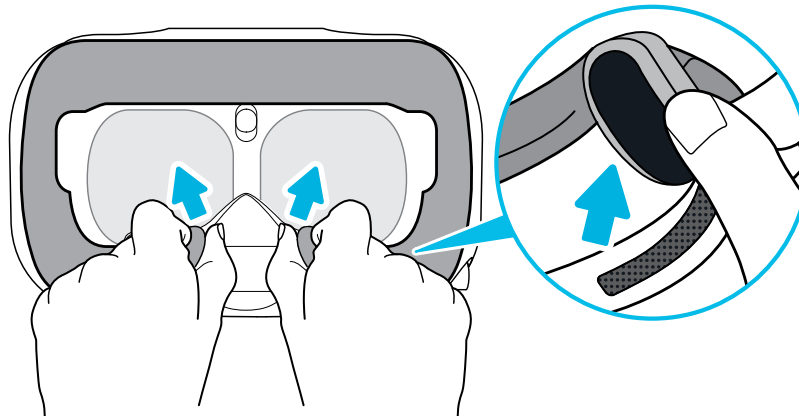

- Carefully pull the flap on the left side of the headset visor to remove the compartment cover and access the headset cable ports.

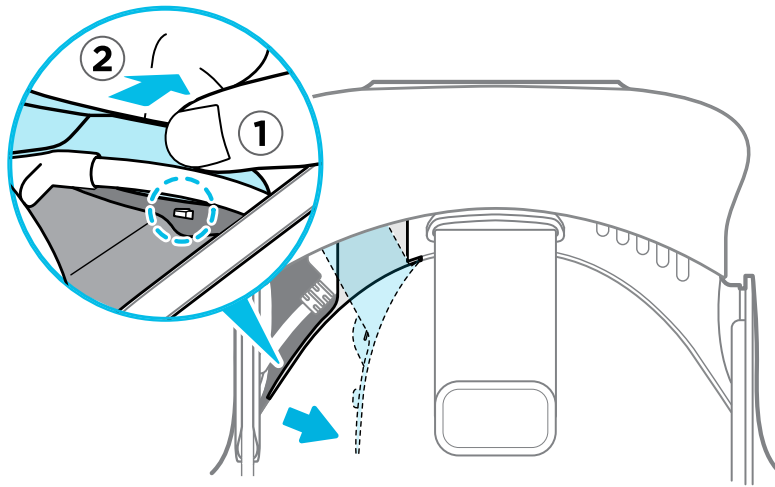

- Unplug the headset cable.

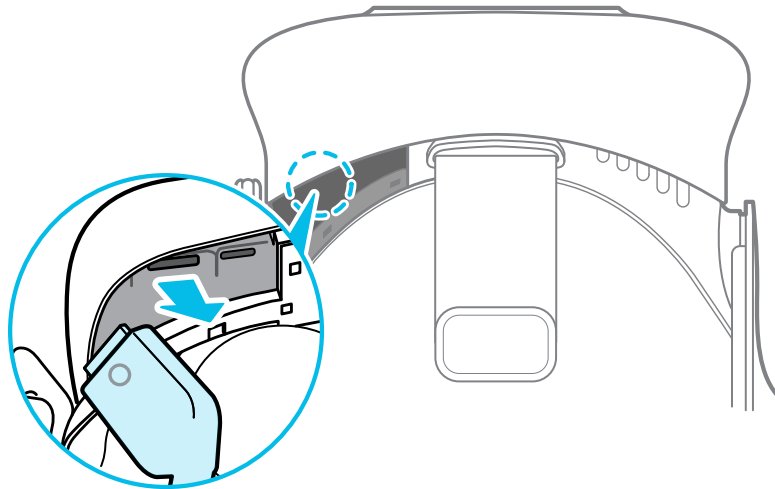

After removing the accessories, the headset you'll send for return should look like the following:

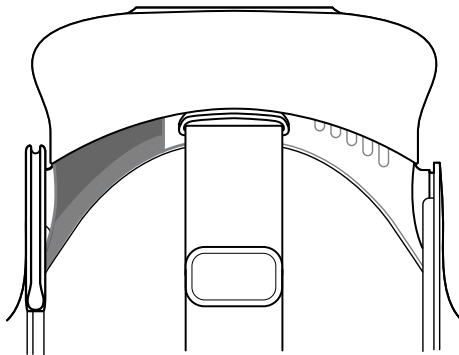

How do I reassemble the headset after repair?

After receiving your repaired headset, properly attach the accessories before using your headset again.

- Reconnect the headset cable.
 1. Press and hold the lens distance button on the headset, and then pull out the visor to its farthest point. For an easier access to the connector slots, pull up the headset strap.

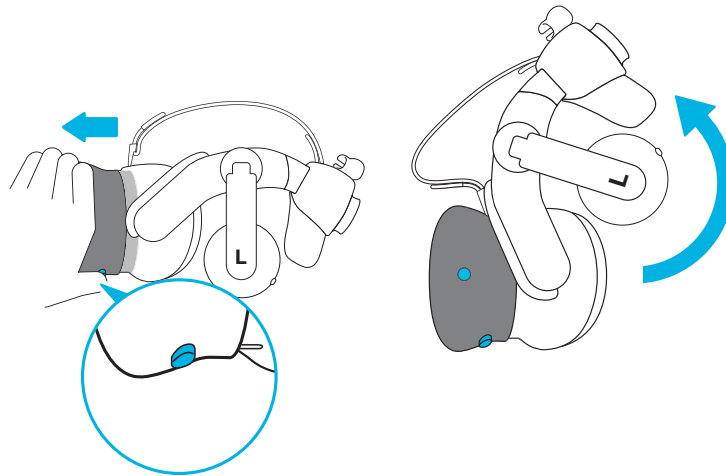

2. Align and reinsert the headset cable connector (side with round mark up) to the port with the corresponding round mark. You'll hear a click when the connector is fully inserted.

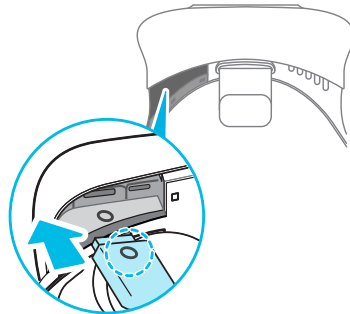

3. Press and hold the lens distance button on the headset, and then push the visor back to the starting point.
4. Make sure that the headset cable connector is secured and that the cable is set before the edge of the compartment.

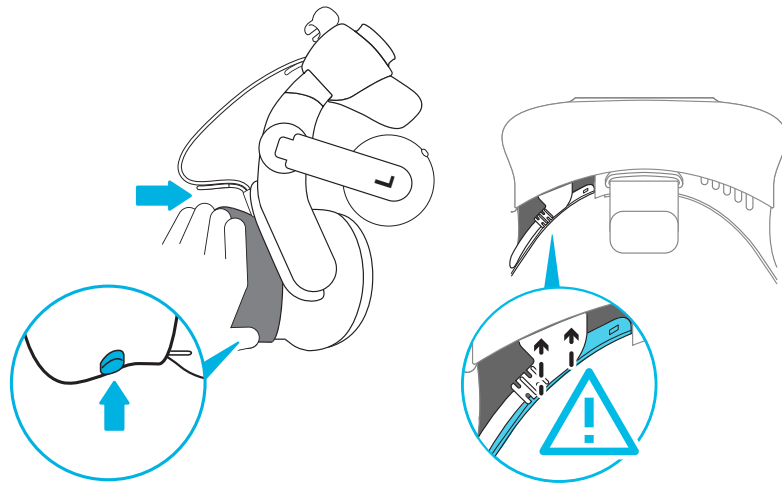

5. Loop the cable around the band of the strap next to it. The stopper on the headset cable should be positioned before the ridge. Make sure that the headset cable passes through the ridge and the cable clip at the back of the headset.

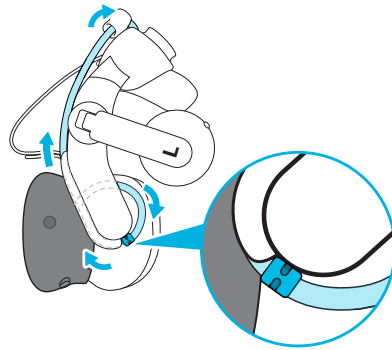

- Replace the compartment cover. Align the tabs on the cover with the holes on the compartment, and then push the cover until it snaps in place.

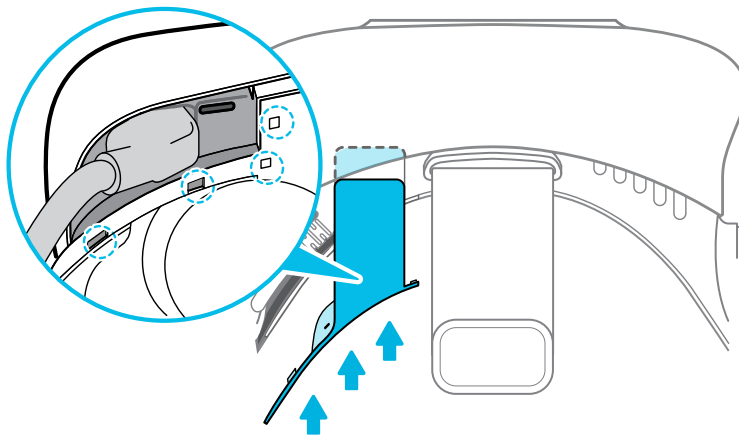

- Reattach the face cushion. Insert the tab on the face cushion into the slot on the headset, and then align the hook and loop strips.

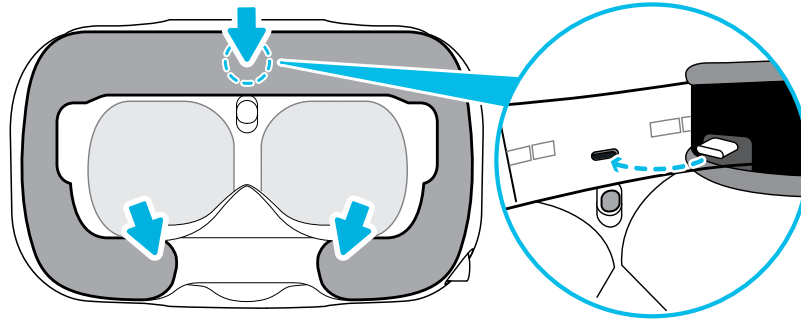

Common solutions

How do I fix issues such as the display turning black or showing static?

If you're experiencing display problems on VIVE Pro 2, try the following:

- If the display turns black after you hot plug or unplug a cable but VIVE Console and SteamVR don't show any errors, try restarting VIVE Console.
- If the display shows noise or static, try restarting VIVE Console.

What can I do to troubleshoot the headset?

Try these troubleshooting suggestions.

Option	Description
Check the headset's LED status	<ul style="list-style-type: none"> ▪ If the LED is not lit, try connecting the link box to a different power outlet. ▪ If the LED is dim green, the headset is on standby mode. Activate it by moving the headset or starting a VR app. ▪ If the LED is red, check if you're encountering a cable connection or driver error. <p>For more information, you may refer to this SteamVR Troubleshooting article.</p>
Restart the headset	<ol style="list-style-type: none"> 1. From your computer, open the SteamVR app. 2. Right-click , and then click Restart headset. 3. Wait for the headset to finish restarting.
Check the cable connections	<ul style="list-style-type: none"> ▪ Make sure that your cable connections are securely attached on both ends. ▪ Check that the correct cables are connected to the corresponding side of the link box. ▪ Connect the DisplayPort cable end to the DisplayPort port on your computer's graphics card where the monitor is also connected. Do not connect the DisplayPort cable to ports on the motherboard. ▪ Try connecting to a different USB port.

Option	Description
Restart the link box	For details, see Restarting the link box on page 28. For more information, you may refer to this  SteamVR Troubleshooting article .

What can I do when the status light on the headset indicates an error?

If you see that the status light is red, try these methods to resolve the issue:

- Disconnect and reconnect the headset cable on the link box.
- Check that the cables between the link box and your computer are properly connected. Disconnect and reconnect the cables as needed.
- Restart the link box by pressing the Power button to turn it off, and then pressing the Power button again to turn it back on.

For more information, you may refer to the  [SteamVR Troubleshooting](#) page.

What should I do if the headset is not tracked?

Try the following methods to troubleshoot the issue:

- Make sure that the headset is placed inside the play area.
- Restart the link box by pressing the Power button to turn it off, and then pressing the Power button again to turn it back on. You need to also restart the SteamVR app.
- Try to disconnect and reconnect the DisplayPort cable to the DisplayPort port on your computer's graphic card.
- Restart the SteamVR app. If you still get an error, reboot your computer and reopen the SteamVR app.

For more information, you may refer to the  [SteamVR Troubleshooting](#) page.

My headset display is blurry. What should I do?

Try these troubleshooting suggestions:

- Make sure that you've removed the protective film on the headset lenses.
- Check that the lenses are clean. Use the cleaning cloth provided in the box to wipe the lenses.
- Make sure that you're wearing the headset properly.

The headset's bottom edge should rest on your cheekbones, while the standard strap should cup the back of your head. You should feel comfortable bending down without the headset slipping off.

If the headset is too low on your face, your display will appear blurry.

- Make sure your IPD is set correctly. For a guide, see [How can I find my IPD?](#) on page 14.

For more information, you may refer to the  [SteamVR Troubleshooting](#) page.

What can I do to resolve the "headset not found" error?

Do the following steps to troubleshoot the issue:

1. Close all Steam apps on your computer, including the SteamVR app.
2. Check that the cables between the link box and your computer are properly connected. Disconnect and reconnect the cables as needed.

3. Restart the link box by pressing the Power button to turn it off, and then pressing the Power button again to turn it back on. On your computer, you might see a notification that drivers are being installed. Wait for the installation to finish.
4. Restart the SteamVR app.

If you still get a similar error, repeat the steps again. You can also check if you're encountering a USB-related issue. For more details, see [My headset can't be detected due to a USB port issue. What should I do?](#) on page 39.

For more information, you may refer to the  [SteamVR Troubleshooting](#) page.

My headset can't be detected due to a USB port issue. What should I do?

Do the following steps to troubleshoot the issue:

- Plug the USB cable into a different USB port to confirm if the error is due to a USB port-related issue.
 1. Plug the USB cable into a generic USB 3.0 port.
 2. Open the SteamVR app, and then click  > **Create System Report**.
 3. Make sure that VIVE Pro 2 devices connect via a USB xHCI port rather than to a port from a specific manufacturer, which might have a compatibility issue with VIVE Pro 2.

If the error is not resolved, your issue may not be due to USB port compatibility.

- Manually update the USB driver on your computer. You can also download and install official driver updates from the website of your motherboard or USB port manufacturer.

If updating your USB driver doesn't solve the error, purchase and use another PCI-Express USB card (with Intel chipset). Based on our tests, this USB card works well with VIVE Pro 2:

Inateck® 2-Port USB 3.0 PCI-Express Card (Serial: KTU3FR-2021)

For more information, you may refer to the  [SteamVR Troubleshooting](#) page.

After upgrading to Windows 10, VIVE shows as the computer's main monitor. What should I do?

Try the following steps to troubleshoot the issue:

1. Disconnect the headset cable on the link box.
2. Restart your computer.
3. Reconnect the headset cable on the link box.

I'm experiencing skipped frames. What could I do?

If you've installed software in your computer that automatically adjusts the display (such as for night mode), it may be causing the conflict.

To resolve the issue, disable the software that may cause the conflict (such as f.lux or Prismatic) when using VIVE.

I'm seeing drifting motion or floating objects in VR. What could I do?

Try these troubleshooting suggestions.

- Make sure that there are no reflective surfaces (such as mirrors) within your play area.
- If there are Bluetooth® devices in the room, turn them off so that they don't interfere with hardware pairing.
- Check if you're having CPU performance issues. On the SteamVR app, click  > **Display Performance Graph**.



If you see spikes in the graph, it means that the issue is with the CPU.

There's no audio when I use my USB Type-C headphones.

Check if you're using analog or digital headphones, and then do one of the following:

- If you have analog headphones, remove the headset earphones, and then reconnect your USB Type-C headphones.
- If you have digital headphones, check if the headphone driver is installed on your computer.

Is there a way to also hear from the computer what's in VR?

You can duplicate the audio from VIVE Pro 2 to your computer. You can use another pair of headphones or speakers.

1. From your computer, open the SteamVR app.
2. Click , and then select **Settings > Audio**.

3. Click the Audio mirroring **On/Off** switch to turn it on.
4. In the drop-down list, choose the device where you want the audio from VIVE Pro 2 duplicated.

What can I do if the headset's dual camera won't turn on?

If you are using Windows 10, disable the power saver settings.

1. From your computer, open the Device Manager.
2. Under Universal Serial Bus controllers, find and right-click **Generic SuperSpeed USB Hub RI**, and then select **Properties**.
3. To make sure that this is the VIVE Pro 2 device, click the Details tab, and then confirm that the VID/PID value contains the string 0BB4/0343.
4. Click the Power Management tab, and then de-select **Allow the computer to turn off this device to save power** option.

What should I do if there's cracking noise from the headset earphones?

When this happens after the headset reactivates from standby mode, unplug and replug the USB 3.0 cable on the link box.

What can I do if the headset connection status is unstable?

Make sure that you're not connecting to a USB port on your computer that's labeled for a specific function, such as for USB BIOS Flashback, by its manufacturer. When the issue happens, try connecting to another USB 3.0 port on your computer.

While the headset is connected, my PC beeps when rebooting.

Try one of the following solutions and see if they can fix the issue:

- Check your BIOS version. It is recommended to update the BIOS to the latest version.
- Wait for your computer to reboot to Windows, and then connect the headset to the computer.

Base stations

Base Station 2.0

About SteamVR Base Station 2.0



This hardware is included with the full kit, but not with the headset-only package. You can purchase them separately if you don't have the full kit. To order, go to the Accessories section on www.vive.com/product/. Product availability may vary; please contact customer care with questions.

The base stations use advanced optics to help your headset and accessories maintain precise tracking in your play area.



- The base stations beam signals to the headset and controllers. Do not cover the front panel with any material.
- When the base stations are turned on, they may affect some nearby infrared sensors, such as those used by an IR TV remote control.

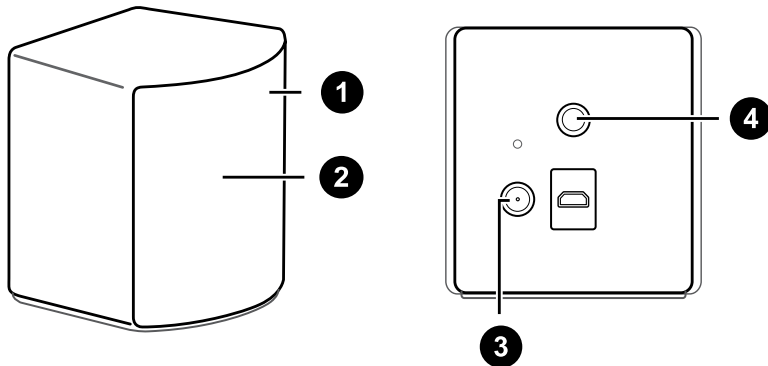

1	Status light
2	Front panel
3	Power port
4	Threaded mounting hole



- Do not attempt to pry open the base stations as doing so could injure you or damage the product.
- If the front panel is cracked or damaged, stop using the base stations and contact HTC Support.

Installing SteamVR Base Station 2.0



This hardware is included with the full kit, but not with the headset-only package. You can purchase them separately if you don't have the full kit. To order, go to the Accessories section on www.vive.com/product/. Product availability may vary; please contact customer care with questions.

Before installing the base stations, decide first whether you want to set up a room-scale or seated/standing-only play area. See [Planning your play area](#) on page 69.



- Make sure that the base stations are installed outside the play area and securely set up from being accidentally struck, dropped, or bumped to avoid damage or compromised performance.
- Remember to peel off the protective film from the front panel after you've mounted the base stations.

1. Mount the base stations diagonally at opposite corners of your space and near power outlets.

For details on how to use the mounting kit, see [Using the mounting kit to install SteamVR Base Station 2.0](#) on page 51.

You can also use tripods, light stands, or cargo poles when mounting the base stations, or even place it on stable book cases. Just avoid using unstable mounting solutions or surfaces that are prone to vibration.

2. Adjust the base stations so that the front panels are facing toward the center of the play area.
3. Attach the power cables to the base stations, and then plug each of the adapter into a power outlet to turn them on.



Use only the power cables and adapters that came with your base stations.

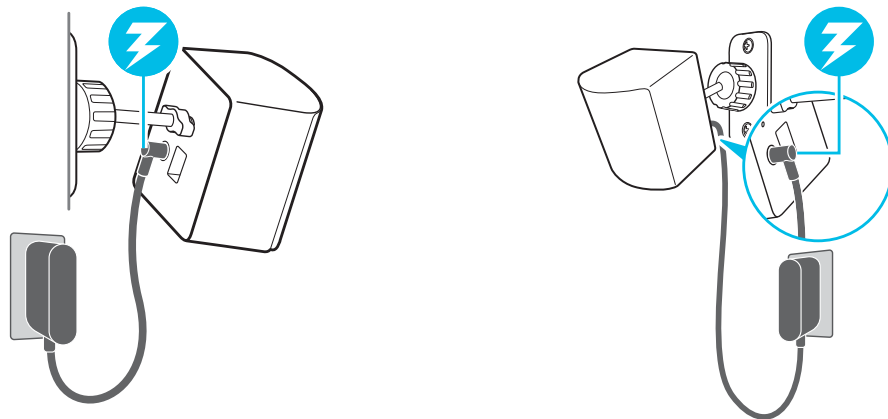

Depending on the variant of your hardware, the status lights should be white or green.



Once turned on, do not move or adjust the angles of the base stations as it could disrupt the tracking process. Otherwise, you will need to set up the play area again.

Tips for setting up SteamVR Base Station 2.0



This hardware is included with the full kit, but not with the headset-only package. You can purchase them separately if you don't have the full kit. To order, go to the Accessories section on www.vive.com/product/. Product availability may vary; please contact customer care with questions.

You may set up the base stations in a way that's suitable for your place. For best results, you may follow these recommendations:

- Mount your base stations diagonally, at opposite corners of your space.
- Each base station has a 150-degree horizontal field of view and a 110-degree vertical field of view. To maximize your play area, set up at above head height (ideally more than 2 m or 6.5 ft from the floor), with the angle of each base station adjusted between 25 and 35 degrees.

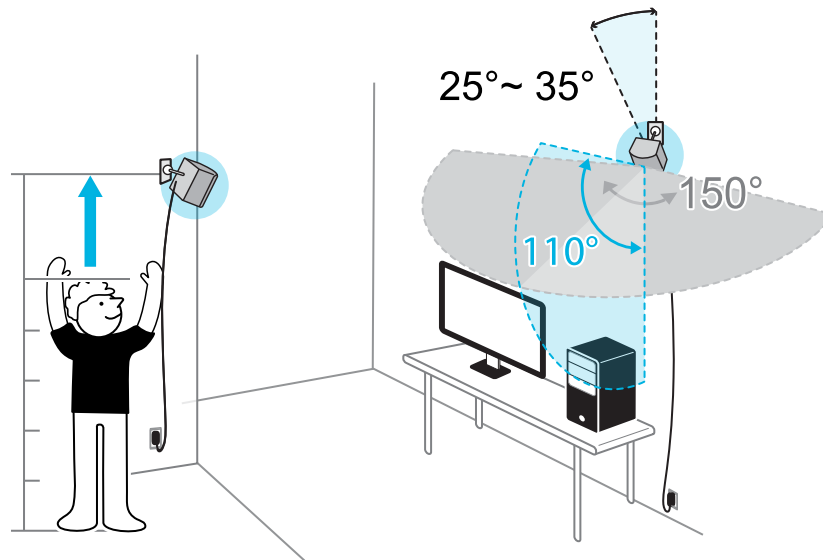

If your space doesn't allow for this kind of setup, you can also mount the base stations on tripods and light stands, or place them on stable surfaces such as a table.

For proper tracking, set each base station at a lowest height of 0.5 m (1.6 ft). Depending on how high you set them up, you need to adjust the angle of the base stations upward or downward to fully cover the play area.

- Secure the base stations in a location where they can't be easily jostled or moved.
- For best performance, trackable objects should be at least 0.5 m (1.6 ft) away from a base station.
- Avoid setting up in an area with bright light, which may negatively affect the performance of the base stations.

How many SteamVR Base Stations 2.0 can I use in a single setup?

You can use up to four base stations in a single room covering 10 m x 10 m (32 ft 10 in x 32 ft 10 in).

What things should I consider when installing more than two SteamVR Base Stations 2.0?

You can use up to four base stations in a single room covering 10 m x 10 m (32 ft 10 in x 32 ft 10 in).

- Each base station in the same play area will need to be set to a different channel. This will be handled by the SteamVR software automatically.
- Each base station has a 150-degree horizontal field of view. Rotate the angle of the base stations left or right to fine tune and fully cover the play area.

Single user setup

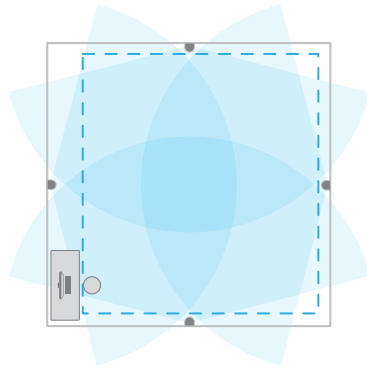

Multi-user setup

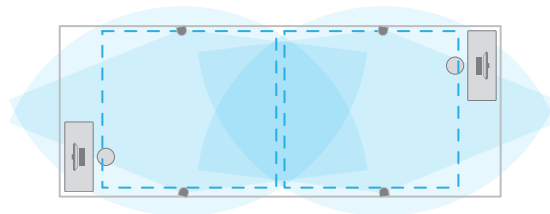

- For proper tracking, make sure that the distance between any base station and the headset and controllers are within a range of 7 m (23 ft). Make sure that there are no physical barriers (such as protruding shelves) where you place the base stations, so that it can fully cover its field of view and its signals won't be obstructed.

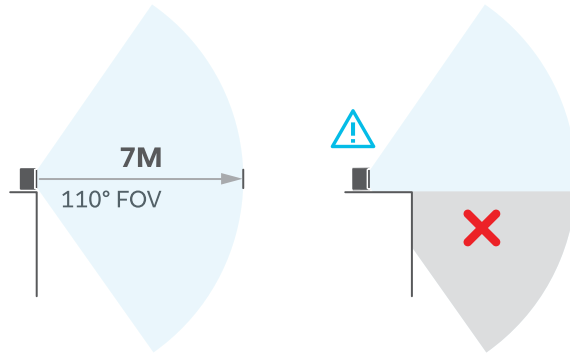

Setting up additional base stations

You can add more SteamVR Base Stations 2.0 to the standard setup. Follow these procedures in the order below to complete the process:

- [Installing SteamVR Base Station 2.0](#) on page 44.
- [Configuring the base station channels](#) on page 49.
- [Setting up a room-scale play area](#) on page 71.

What are the minimum and maximum play area when using more than two SteamVR Base Stations 2.0?

The minimum play area remains to be at 2 m x 1.5 m (6 ft 6 in x 5 ft), and could support sitting/standing setup with four base stations in a row. The maximum area with four base stations is up to 10 m x 10 m (32 ft 10 in x 32 ft 10 in).

My available space has an irregular shape. Can I still set up more than two SteamVR Base Stations 2.0?

Yes, there are nearly unlimited ways to setup multiple base stations to cover most asymmetric and irregular spaces within the range of SteamVR Base Station 2.0.

Here are some examples:

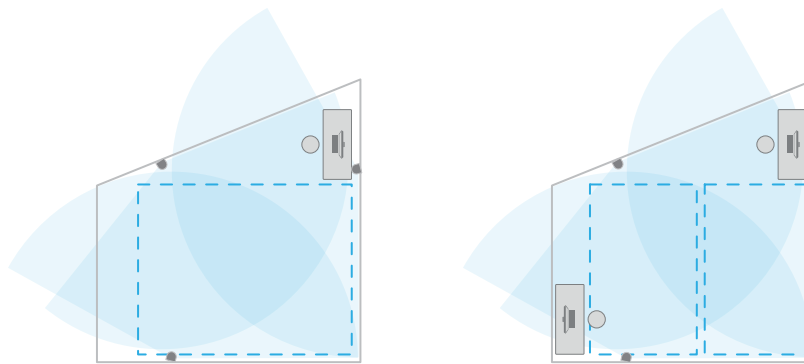

Can I use an odd number of SteamVR Base Stations 2.0?

Yes. Each base station works independently of the others, and there is no pairing requirement between them.

Configuring the base station channels

If you're using more than two SteamVR Base Stations 2.0 in your play area, you can change the channel of the additional base stations.



In the SteamVR app, make sure **Enable Bluetooth** in **☰** > **Devices** > **Bluetooth Settings** is selected.

1. From your computer, open the SteamVR app.
2. Click **☰**, and then select **Devices** > **Base Station Settings**.

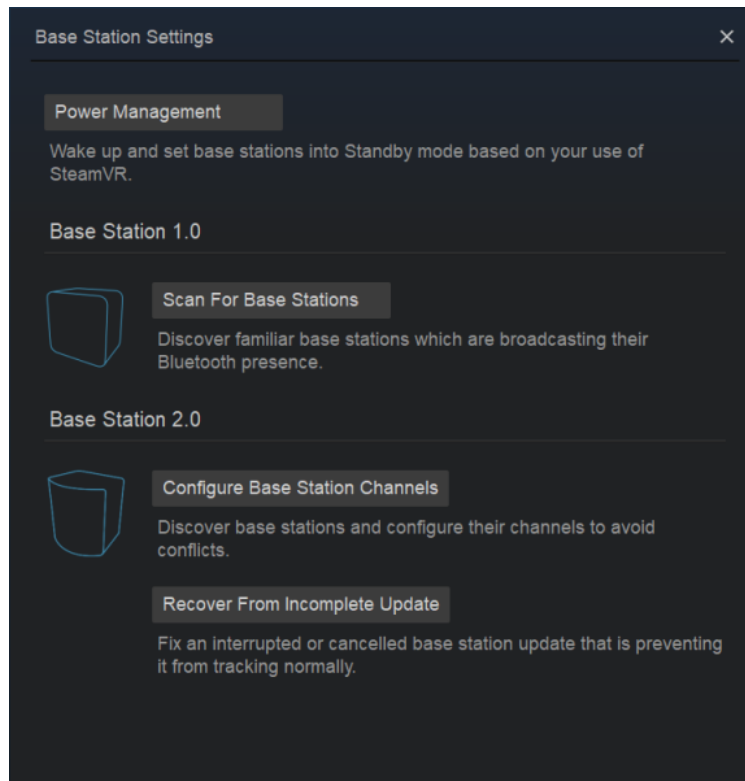

3. Under Base Station 2.0, click **Configure Base Station Channels**. SteamVR will scan for base stations in the play area. Once complete, you'll see a list of base stations. If you have base stations that have not been detected, click **Scan For More**.
4. To change its channel, click on a base station link. Select an unused channel, and then click **Apply**.





You can also click **Automatic Configuration** to let SteamVR set the channels.

If you're prompted that there is a channel conflict, click **Continue** to resolve the error.

5. When you're finished making the changes, click **Done**.

How can I check which base stations are currently in use?

SteamVR automatically detects the base stations in your play area. If you have more than 2 SteamVR Base Stations 2.0, you can check which of these are used in your VIVE VR system.

1. From your computer, open the SteamVR app.
2. Do one of the following:
 - Click , and then select **Devices > Base Station Settings > Configure Base Station Channels**.
You'll see a list of all base stations in range. The base stations that are tracked by the headset will have  next to them.
 - Click , and then select **Create System Report**.
From the log, you'll see the device names of the base stations that are currently used.
 - Hover your cursor over the base station icon, and then click **Identify Base Station**.
The status light on the base station rapidly flashes white.

Using the mounting kit to install SteamVR Base Station 2.0

For best results, install SteamVR Base Station 2.0 using a mounting kit, which is provided as an in-box item in VIVE Pro 2 full kit. If you bought more SteamVR Base Station 2.0 units, you can separately purchase a similar mounting kit from a third-party supplier.



- You will need a screwdriver or drill to install the mounts. Ask a professional for help when using power tools.
- Remember to peel off the protective film from the front panel after you've mounted the base stations.

1. Mark where you want to install each of the mounts on your wall, and then screw the mounts in.
When mounting on concrete or drywall, first drill $\frac{1}{4}$ inch holes and insert anchors before screwing mounts in.
2. Rotate the base station to screw it onto the threaded ball joint. Do not screw the base station all the way in, only enough to be stable and oriented correctly.
3. Tighten the wingnut to the base station to secure it in place.

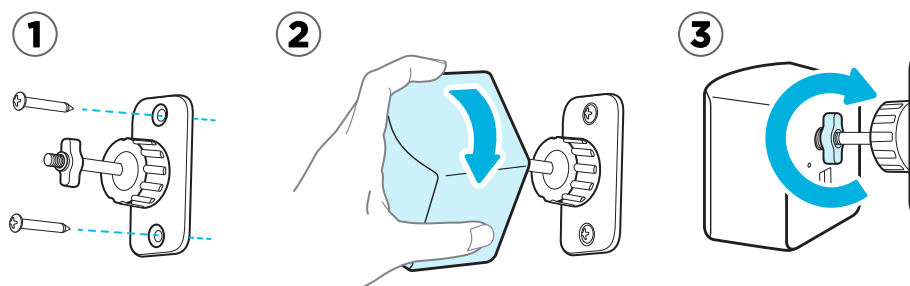

4. To adjust the angle of the base station, loosen the clamping ring while carefully holding the base station to prevent it from falling.
5. Tilt the base station toward the play area. To fix the angle of the base station, tighten the clamping ring back in.
6. Attach the power cable to each base station.

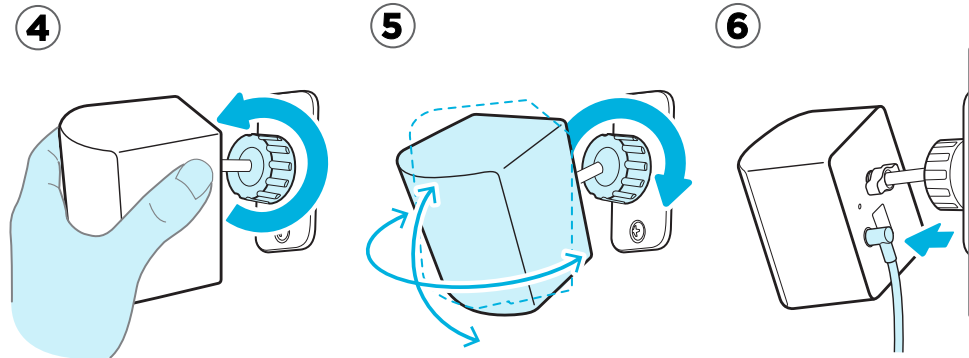

Cleaning the base stations

Always keep the base stations and their power adapters dry and away from liquids to avoid shock hazard.

To clean the base stations:

1. Unplug and unmount the base stations.
2. Use a lightly moistened non-abrasive cloth to clean the base stations. Do not use cleaning chemicals.
3. While cleaning the base stations, do not scratch the front panel nor disassemble any of its parts.

Base Station 1.0

About VIVE Base Station 1.0

If you have Base Station 1.0, you can still use them with VIVE Pro 2.



- The base stations beam signals to the headset and controllers. Do not cover the front panel with any material.
- When the base stations are turned on, they may affect some nearby infrared sensors, such as those used by an IR TV remote control.

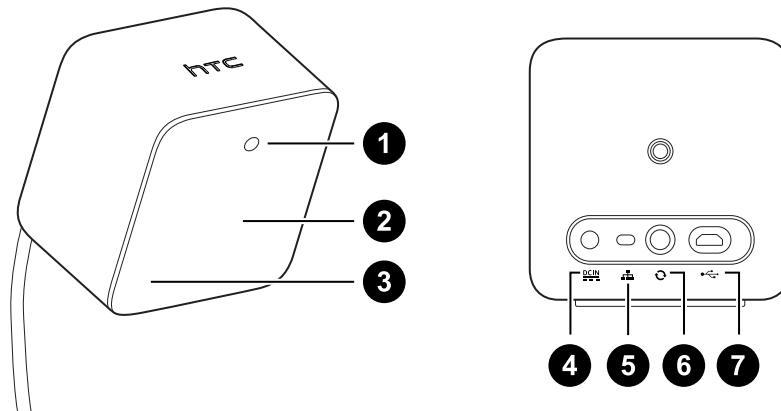

1	Status light
2	Front panel
3	Channel indicator (recessed)
4	Power port
5	Channel button
6	Sync cable port (optional)
7	Micro-USB port (for firmware updates)



- Do not attempt to pry open the base stations as doing so could injure you or damage the product.
- If the front panel is cracked or damaged, stop using the base stations.

Installing Base Station 1.0

Before installing the base stations, decide first whether you want to set up a room-scale or seated/standing-only play area. See [Planning your play area](#) on page 69.



During unboxing, remove the thin film that covers the front panel of the base stations.

1. Mount the base stations diagonally at opposite corners of your space.

For details on how to use the mounting kit, see [Using the mounting kit to install Base Station 1.0](#) on page 56.

You can also use tripods, light stands, or cargo poles when mounting the base stations, or even place it on stable book cases. Just avoid using unstable mounting solutions or surfaces that are prone to vibration.

2. Adjust the base stations so that the front panels are facing toward the center of the play area.
3. Attach the power cables to the base stations, and then plug them each into a power outlet to turn them on. The status lights should be green.
4. Connect the base stations and set the channels.



For details on how to get the sync cable, contact customer care.

Without the sync cable

Press the Channel buttons at the back of the base stations so that one base station is set to channel “b”, while the other is set to channel “c”.

With the sync cable (optional for added reliability)

Press the Channel buttons at the back of the base stations so that one base station is set to channel “A”, while the other is set to channel “b”.

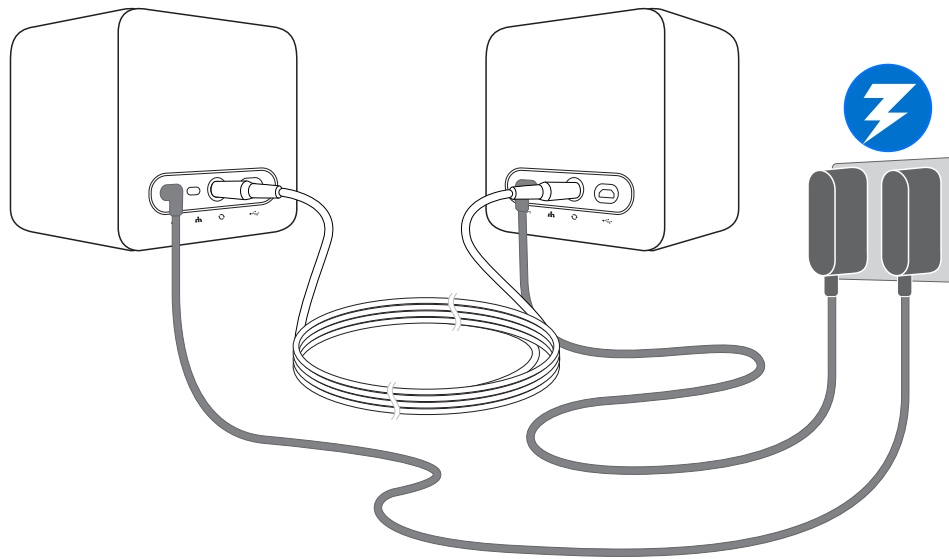

Once turned on, do not move or adjust the angles of the base stations as it could disrupt the tracking process. Otherwise, you will need to set up the play area again.

Tips for setting up Base Station 1.0

You may set up the base stations in a way that's suitable for your place. For best results, you may follow these recommendations:

- Mount the base stations diagonally and above head height, ideally more than 2 m (6 ft 6 in).
- Secure the base stations in a location where they can't be easily jostled or moved.
- Each base station has a 120-degree field of view, so it's ideal to adjust its angle between 30 and 45 degrees to fully cover your play area.
- For optimal tracking, make sure that the maximum distance between the two base stations is 5 m (16 ft 4 in).

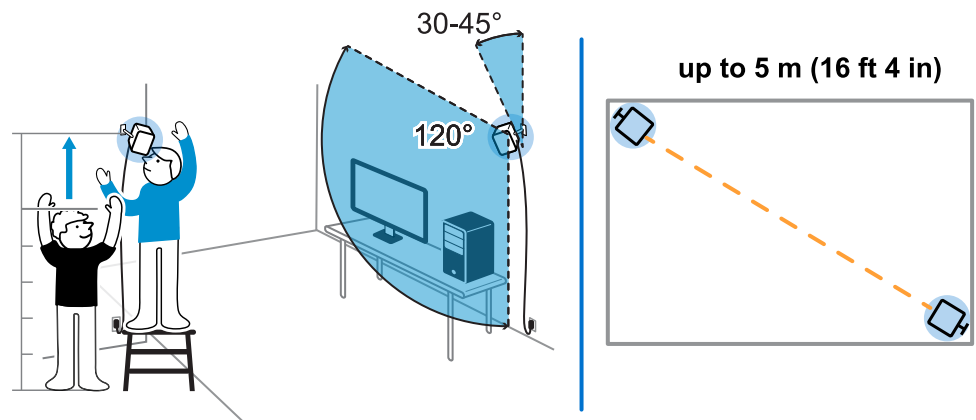

- Avoid setting up in an area with bright light, which may negatively affect the performance of the base stations.

Using the mounting kit to install Base Station 1.0

For best results, install the base stations using a mounting kit. If you purchased the first-generation VIVE, it has the mounting kit in the box. Otherwise, you can separately purchase a similar mounting kit from a third-party supplier.



You will need a screwdriver or drill to install the mounts. Ask a professional for help when using power tools.

1. Mark where you want to install each of the mounts on your wall, and then screw the mounts in.

When mounting on concrete or drywall, first drill $\frac{1}{4}$ inch holes and insert anchors before screwing mounts in.

2. Rotate the base station to screw it onto the threaded ball joint. Do not screw the base station all the way in, only enough to be stable and oriented correctly.

3. Tighten the wingnut to the base station to secure it in place.

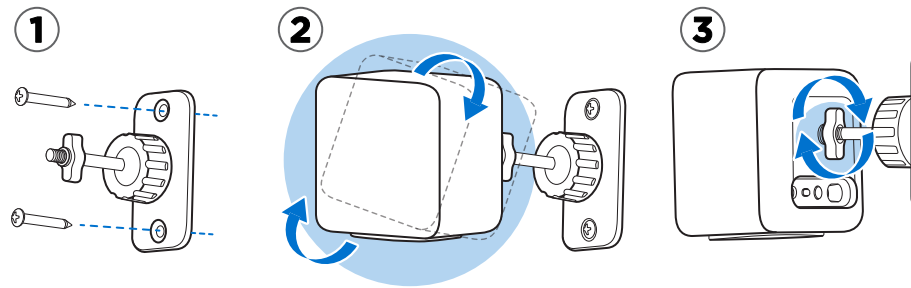

4. To adjust the angle of the base station, loosen the clamping ring while carefully holding the base station to prevent it from falling.
5. Tilt the base station toward the play area.

Make sure it has an unobstructed view of the other base station. Each base station has a 120-degree field of view. They should be angled down between 30 and 45 degrees.

To fix the angle of the base station, tighten the clamping ring back in.

6. Attach the power cable to each base station.

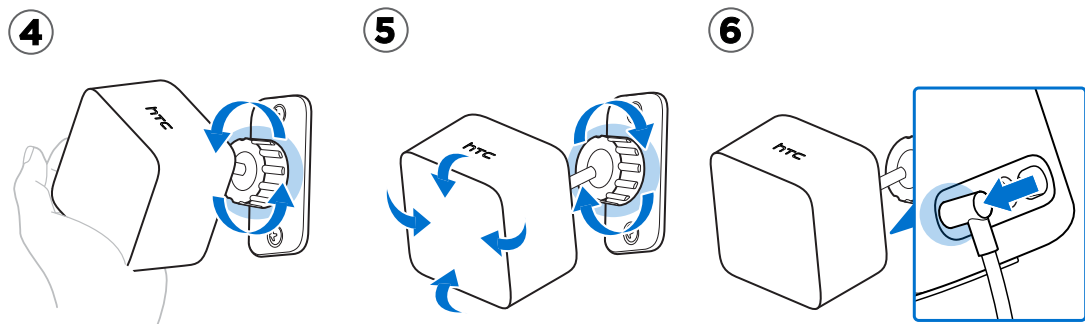

Updating Base Station 1.0 firmware via cable connection

You can connect the base stations to the USB port on your computer and update their firmware.

1. From your computer, open the SteamVR app.
2. If you see the  icon, mouse over it to check if the firmware is out of date. If so, click **Update Device**.
3. Unplug the base stations from their power adapters, and then carefully unmount them.
4. Using a micro-USB cable, connect the base stations to one of your computer's USB ports one at a time.

5. While pressing the Channel button at the back of the base station, plug in the base station's power adapter.

Once the base station is detected by the SteamVR app, the firmware update will start automatically.





Do not unplug the micro-USB cable or power cable before the firmware update is complete. Doing so could result in a firmware error.

6. When the update is complete, click **Done**.

Base Station 1.0 and 2.0 FAQs

How do I update base station firmware via Bluetooth?

Make sure your headset is connected to your computer during the update.

1. From your computer, open the SteamVR app.
2. Click  > **Devices** > **Bluetooth Settings** > **Enable Bluetooth** .
3. Do one of the following:
 - Click  > **Devices** > **Update Device**, and then select the base stations.
 - If you see the  icon, mouse over it to check if the firmware is out of date. If so, click **Update Device**.
4. Follow the onscreen instructions to complete the process.



Do not unplug the power cable before the firmware update is complete. Doing so may result in a firmware error.

What does the status light on the base stations mean?

Depending on the type of base stations you're using and their status, their LED may show the following:

Base Station 2.0	Base Station 1.0
<ul style="list-style-type: none"> ▪ Depending on the variant of your hardware, white or green when the base station is in normal mode. ▪ Blue or blinking blue when the base station is waiting to stabilize. If it remains in this state, check if it is mounted securely or on a surface that's not prone to vibration. ▪ Blinking red when there is an error. 	<ul style="list-style-type: none"> ▪ Green when the base station is in normal mode ▪ Blue when the base station is waiting to stabilize. If it remains in this state, check if it is mounted securely or on a surface that's not prone to vibration. ▪ Dim green when the base station is on standby ▪ Purple when the base stations are trying to sync ▪ Blinking purple when syncing is blocked. If you're connecting the base stations wirelessly, you may need to use the sync cable. For details on how to get the sync cable, contact customer care.

What should I do if any of the base stations is not detected?

If any of the base stations appear disabled in the SteamVR app, try the following to troubleshoot the problem:

- Turn the base station off and on again.
- Make sure that you've installed your base stations correctly. Depending on the type of base stations you're using, see [Installing SteamVR Base Station 2.0](#) on page 44 or [Installing Base Station 1.0](#) on page 54.
- Restart the SteamVR app. If you still get an error, reboot your computer and reopen the SteamVR app.

For more information, you may refer to the  [SteamVR Troubleshooting](#) page.

Can Base Station 1.0 be used with SteamVR Base Station 2.0?

No, they are not compatible. SteamVR Base Station 2.0 has a different method of syncing. Use only the same versions of the base stations in your play area so that your setup will work correctly.

Is accidental base station damage covered by warranty?

Please follow the recommended setup instructions for the base stations carefully, since product warranty does not cover accidental damage.

Stop using the base stations if they are damaged, especially if its front panels are cracked.

Controllers

About VIVE Controllers (2018)



This hardware is included with the full kit, but not with the headset-only package. You can purchase them separately if you don't have the full kit. To order, go to the Accessories section on www.vive.com/product/. Product availability may vary; please contact customer care with questions.

Use the controllers to interact with objects in the VR world. The controllers have sensors that are tracked by the base stations.



The sensors on the controllers are sensitive. Do not cover or scratch the sensor lenses.

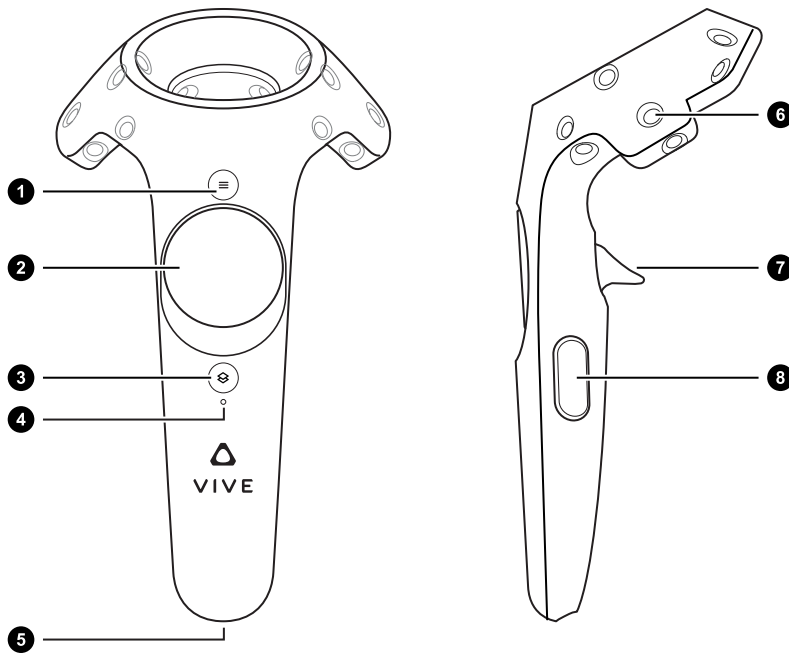

1	Menu button
2	Trackpad
3	System button
4	Status light
5	Micro-USB port

6	Tracking sensor
7	Trigger
8	Grip button





First-generation VIVE controllers work with VIVE Pro 2 and Base Station 1.0. They use the same ports and hardware controls as VIVE Controllers (2018).

Charging the controllers



This hardware is included with the full kit, but not with the headset-only package. You can purchase them separately if you don't have the full kit. To order, go to the Accessories section on www.vive.com/product/. Product availability may vary; please contact customer care with questions.

You can check the battery level of the controllers when apps aren't running or the System Dashboard is up. When the battery is low, the indicator will show a single red dot .

You can also check the SteamVR app. If you see , this means the controller battery is low.

Charge each controller using the provided power adapters and USB cables.

When the controller is plugged in and fully charged, its status light shows green if the controller is on or white if the controller is off.

Turning the controllers on or off

Turn on the controllers using the System button. The controllers turn off automatically when not in use after a period of time.

- To turn the controller on, briefly press the System button until you hear a beeping sound.
- To turn the controller off, press and hold the System button until you hear a beeping sound.

When you quit the SteamVR app, the controllers will automatically turn off. The controllers will also automatically turn off after being idle for a period of time.

Pairing the controllers with the headset

When the controllers are turned on for the first time, they will automatically pair with the headset.

You can also manually pair the controllers. Here's how:

1. Turn the controllers on by briefly pressing the System button.
2. Launch the SteamVR app.

3. Click  > **Devices**.
4. Click **Pair Controller**. Follow the instructions to complete the process.



The status light shows as blinking blue while the pairing is in progress. The status light turns solid green when the controllers are paired with the headset.

Attaching the lanyards to the controllers



This hardware is included with the full kit, but not with the headset-only package. You can purchase them separately if you don't have the full kit. To order, go to the Accessories section on www.vive.com/product/. Product availability may vary; please contact customer care with questions.

Attaching the lanyards can help prevent accidentally dropping the controllers. Don't fling or violently throw the controller as the lanyard may break.

1. While holding the controller, insert the lanyard's thread from the top to the bottom hole.
2. Loop the lanyard through the thread, and then tug the lanyard to fasten it in place.
3. Place the lanyard on your wrist, and then adjust the lock to tighten the lanyard comfortably around your wrist.

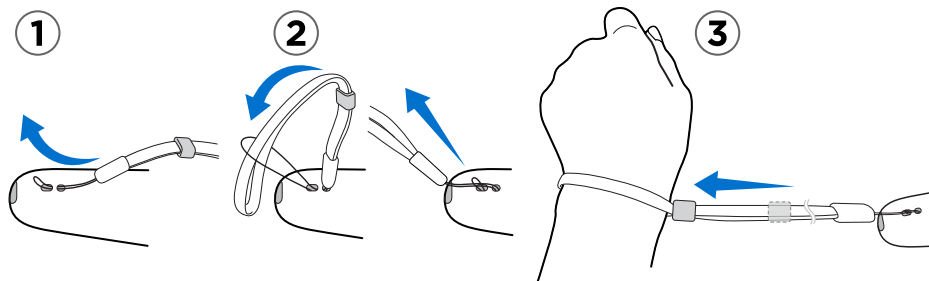

Updating controller firmware



This hardware is included with the full kit, but not with the headset-only package. You can purchase them separately if you don't have the full kit. To order, go to the Accessories section on www.vive.com/product/. Product availability may vary; please contact customer care with questions.

Keep your controllers up-to-date by installing the latest firmware updates. Here's how:

1. From your computer, open the SteamVR app.
2. If you see the  icon, mouse over it to check if the firmware is out of date. If so, click **Update Device**.
3. Using a micro-USB cable, connect the controllers to one of your computer's USB ports one at a time.

Once the controller is detected by the SteamVR app, the firmware update will start automatically.



Do not unplug the micro-USB cable any time before the firmware update is complete. Doing so could result in a firmware error.

4. When the update is complete, click **Done**.

What does the status light on the controllers mean?



This hardware is included with the full kit, but not with the headset-only package. You can purchase them separately if you don't have the full kit. To order, go to the Accessories section on www.vive.com/product/. Product availability may vary; please contact customer care with questions.

Depending on the status, the LEDs on the controllers show the following:

- Green when the controller is in normal mode
- Blinking red when battery is low
- Blinking blue when the controller is pairing with the headset
- Blue when the controller is connecting with the headset
- Orange when charging

What should I do if a controller is not tracked?



This hardware is included with the full kit, but not with the headset-only package. You can purchase them separately if you don't have the full kit. To order, go to the Accessories section on www.vive.com/product/. Product availability may vary; please contact customer care with questions.

When a controller appears disabled in the SteamVR app, try the following to troubleshoot the problem:

- Make sure that the controller is placed inside the play area.
- Turn the controller off and on again to reactivate the tracking.
- Restart the SteamVR app. If you still get an error, reboot your computer and reopen the SteamVR app.

For more information, you may refer to the  [SteamVR Troubleshooting](#) page.

How do I know which controller is not tracked?



This hardware is included with the full kit, but not with the headset-only package. You can purchase them separately if you don't have the full kit. To order, go to the Accessories section on www.vive.com/product/. Product availability may vary; please contact customer care with questions.

If one of your controllers is not being tracked and you want to find out which one, follow the steps below.

1. On your computer, open the SteamVR app.

2. Hover your cursor on the icon of the controller that's not tracked.
3. Click **Identify controller**.

The status light on the controller rapidly flashes white.

For more information, you may refer to the  [SteamVR Troubleshooting](#) page.

What can I do if the controller trackpad is oversensitive?



This hardware is included with the full kit, but not with the headset-only package. You can purchase them separately if you don't have the full kit. To order, go to the Accessories section on www.vive.com/product/. Product availability may vary; please contact customer care with questions.

Check if there's a firmware update available for the controllers, and then follow the steps below to re-calibrate a controller.

1. From your computer, open the SteamVR app.
2. Right-click , and then click **Calibrate Controller**.
3. Follow the onscreen prompts to complete the calibration process.

For more information, you may refer to the  [SteamVR Troubleshooting](#) page.

What should I do if my controller won't turn on?



This hardware is included with the full kit, but not with the headset-only package. You can purchase them separately if you don't have the full kit. To order, go to the Accessories section on www.vive.com/product/. Product availability may vary; please contact customer care with questions.

When a controller won't turn on, try the following methods to troubleshoot the problem:

- Press and hold the System button for at least 5 seconds and see if the controller turns on.
- Charge the controller using the other cable and adapter, and plug the adapter to a different power outlet.
- On the SteamVR dashboard, check if the controllers are detected. If controllers are detected but the LED light is off, it may indicate an issue with the LED.
- Check if you have a firmware update that failed. To recover from this error, see [How do I recover my controller after an interrupted update?](#) on page 67.

The controller automatically turns off. What should I do?



This hardware is included with the full kit, but not with the headset-only package. You can purchase them separately if you don't have the full kit. To order, go to the Accessories section on www.vive.com/product/. Product availability may vary; please contact customer care with questions.

If you're experiencing problems with the controller, try these common solutions:

1. Make sure that the controller is charged.
2. Check that the status light on the controller shows as green, which means that it is paired with the headset.
3. Plug the USB cable from the link box into another USB 3.0 port on the computer.
4. Manually update the USB driver on your computer. You can also download and install official driver updates from the website of your motherboard or USB port manufacturer.

How do I recover my controller after an interrupted update?



This hardware is included with the full kit, but not with the headset-only package. You can purchase them separately if you don't have the full kit. To order, go to the Accessories section on www.vive.com/product/. Product availability may vary; please contact customer care with questions.

If a controller firmware update was interrupted, your controllers will go into bootloader mode. Here's how to recover them:

1. Using a micro-USB cable, connect the controller to one of your computer's USB ports.
2. From your computer, open the SteamVR app.
3. Once the controller is detected by the SteamVR app, follow the onscreen prompts to complete the firmware update.

Play area

What is the play area?

The play area sets the virtual boundaries of VIVE Pro 2. Your interaction with VR objects happens within the play area.

VIVE Pro 2 is designed for room-scale setup, but you can also use it for standing and seated experiences.

Choosing the play area

Find a space that you will designate as the play area. For best results, do the following:

- Move furniture and other obstacles (like pets) out of the play area.

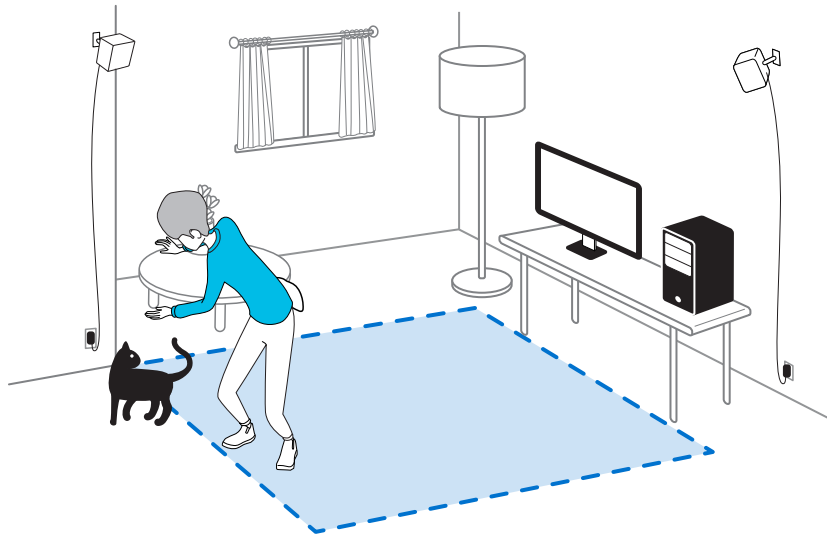

- Place your computer next to your play area. The headset cable extends around 5 m (16 ft 4 in) from your computer.
- Make sure that there are power outlets close to where you mount the base stations. Use 12V extension cords as needed.
- Avoid direct exposure to intense light or glare, such as bright sunlight or lasers, as it may damage your headset display.

Planning your play area

Plan the size of your play area based on the available space you have.

Room-scale setup needs a minimum play area of 2 m x 1.5 m (6 ft 6 in x 5 ft). Examples of room-scale setup:

Base Station 2.0



Base Station 1.0

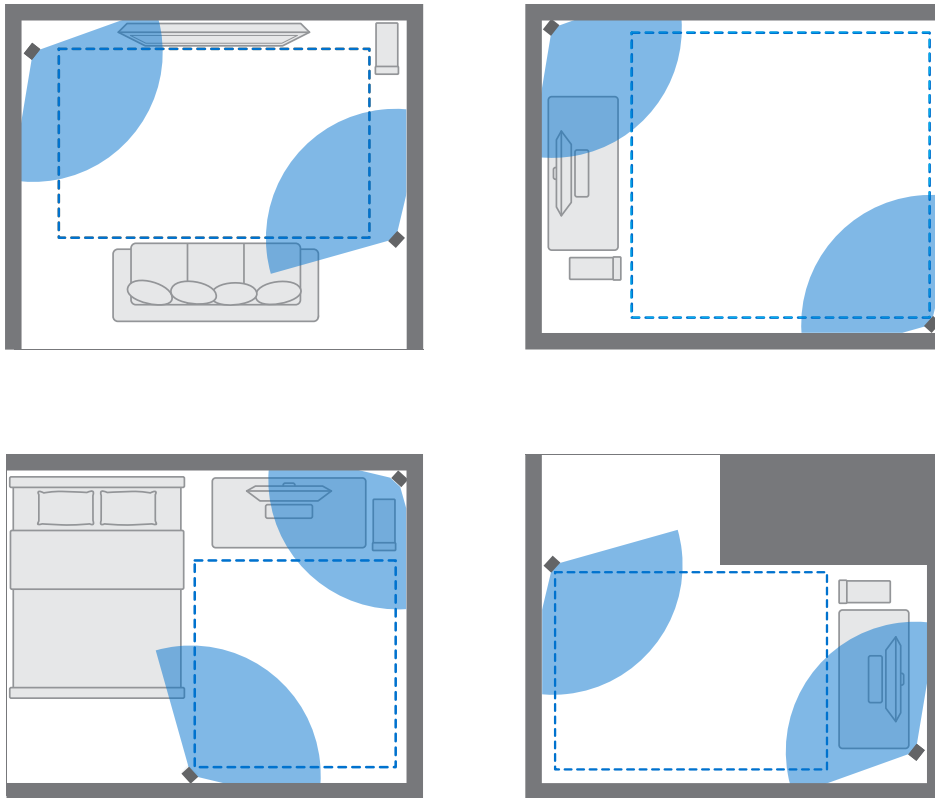

Seated and standing experiences do not have space requirements. Examples of seated/standing setup:

Base Station 2.0

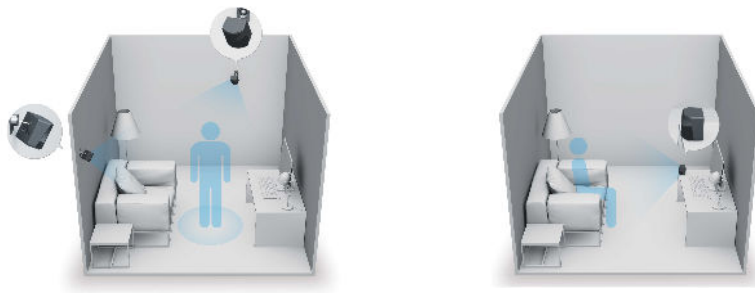

Base Station 1.0

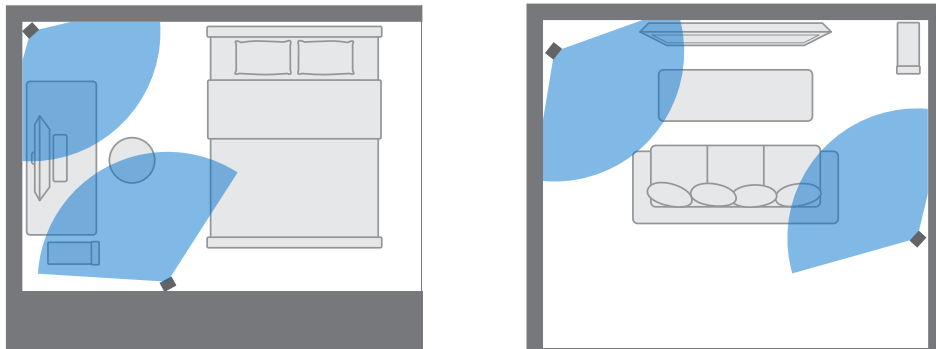

Setting up a standing-only play area

Choose this option if you only want to experience VR in a seated or standing position.

1. From your computer, open the SteamVR app.
2. Click , and then select **Room Setup > Standing only**.
3. Review the prompts and follow the on-screen instructions to complete the process.

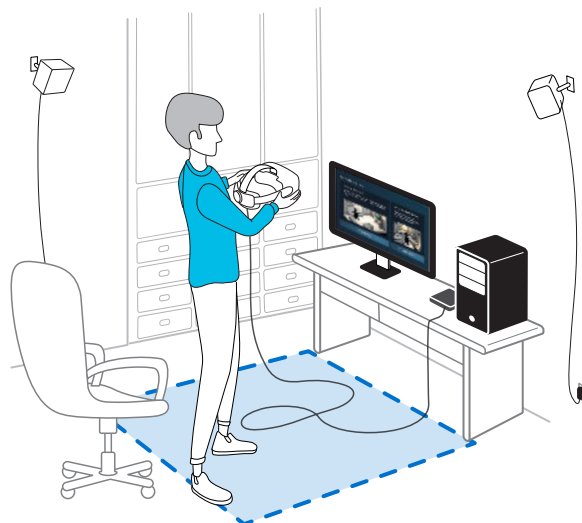

Setting up a room-scale play area

Choose to set up a room-scale play area to enjoy moving around and fully engage with the VR experience.

1. From your computer, open the SteamVR app.
2. Click , and then select **Room Setup > Room-scale**.
3. Review the prompts and follow the on-screen instructions to complete the process.

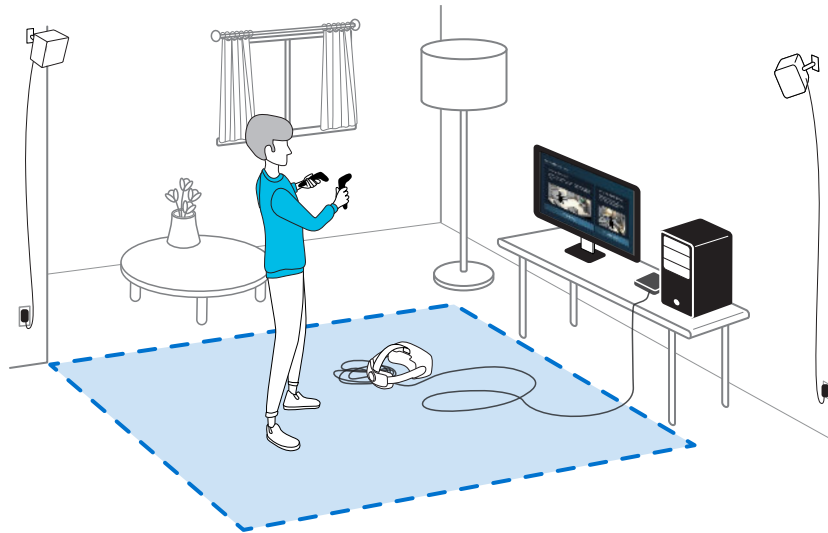

When tracing the boundaries of the play area, make sure that the floor is cleared. Do not trace across space occupied by things (such as a table or a chair) since this may cause you to trip into the object while in VR.

Verifying your setup

Once you've completed the VIVE setup process, you can now put on the headset and hold the controllers to start exploring VR.

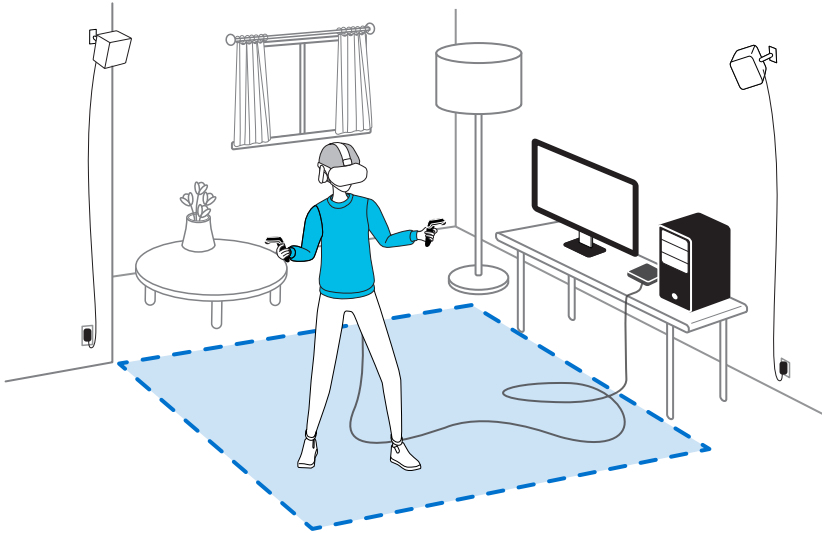

While you're in the play area, the headset and the controllers should remain at least 0.5 m (1 ft 7 in) away from a base station. This will ensure that the devices are properly tracked within the base station's field of view.



For health and safety warnings, please refer to the Safety and regulatory guide, which is periodically updated for accuracy and completeness. For the latest version, check www.vive.com/.

After setting up, how do I turn the VIVE system on?

Make sure you've followed these steps to get your VIVE Pro 2 system ready for use.

1. From your computer, open the SteamVR app.
2. Make sure your base stations are powered.
3. Make sure that your headset is connected to the computer via the link box. For details, see [Connecting the headset to your computer](#) on page 27.
4. Turn the controllers on.
5. Check that VIVE hardware is tracked. The status icons on the SteamVR app should be blue and the status lights on the hardware should all be green.
6. Put the headset on. For details, see [Putting on the VIVE Pro 2 headset](#) on page 11.
7. Grab your controllers.

To bring up the System Dashboard, press the System button on either controller.

What is the recommended space for the play area?

Space requirements for the play area vary, depending on the type of base stations you're using.

- For Base Station 2.0, room-scale setup requires a minimum play area of 2 m x 1.5 m (6 ft 6 in x 5 ft). Maximum size is 7 m x 7 m (23 ft x 23 ft).
- For Base Station 1.0, room-scale setup requires a minimum play area of 2 m x 1.5 m (6 ft 6 in x 5 ft). Movement within a diagonal area of up to 5 m (16 ft 4 in) is supported—for example, a 3.5 m x 3.5 m (around 11 ft 5 in x 11 ft 5 in) space.

There's no minimum for seated and standing experiences.

Can I include space occupied by furniture for the play area?

Try to keep your play area clear. When setting the play area boundary, make sure the floor is free of obstacles. Do not trace across space occupied by things (such as a table or a chair) since this may cause you to trip into the object while in VR.

Can seated/standing-only experiences work at room scale?

Even if you have a room-scale setup, you can still use VR apps that are designed for seated or standing-only experiences. Just make sure that your headset and controllers are tracked within the play area.

How do I fix download errors during VIVE Setup installation?

Download errors are usually caused by incorrect network settings. For example, due to wrong DNS, the download server address is unresolved by the host. Some network destinations may be inaccessible, even as connection to other websites seems normal. Please make sure that your network settings are correct, or ask your network administrator for support.

I can't complete the room setup. What should I do?

Check if you're using special characters (such as à or é) in your local Windows user name, which could cause the problem.

As a workaround, you can add a new Windows account using basic Latin alphabet for your user name. After logging in with the new user name, reinstall VIVE Setup and complete the process.

Settings

Audio settings

Choosing whether to hear ambient sound

Choose whether you want to hear sounds from the real world while you're in VR.

1. While in VR, press the System button on either controller to open the System Dashboard.
2. Select **VIVE** to go to the VIVE Dashboard.
3. On the left-side panel, select .
4. Select **Audio mode**, and then choose one of the following:

Option	Description
Default	Hear only sounds from VR content.
Conversational	Hear foreground sounds from your room while in VR. Choose this if you need to talk and listen to other people while in VR.
Ambient	Hear background sounds from your room while in VR. Choose this if you're expecting someone to call or ring your door bell.



Once you change to another audio mode, it will be applied the next time you launch VR content.

Disabling Volume limit

For safety reasons, there's a default maximum volume set for the headset earphones. If you feel that the sound volume is not loud enough even with the volume level set high, turn off the **Volume limit** setting.



Listening at a high volume for a long time may damage your hearing.

1. While in VR, press the System button on either controller to open the System Dashboard.
2. Select **VIVE** to go to the VIVE Dashboard.
3. On the left-side panel, select .
4. Select the **Volume limit On/Off** switch to turn the setting off.

System Dashboard settings

System Dashboard

The System Dashboard serves as your central point of entry in VR. Here are some of the things you can do in the dashboard:

- Launch or close a VR app
- Control sound volume and mic access
- Change settings, such as style of the collision bounds in Chaperone or the in-headset background
- Turn the VIVE Pro 2 system off

To bring up the dashboard, press the System button on either controller.

Changing the Chaperone settings

The Chaperone shows a grid whenever you're close to the bounds of your play area. You can change how the grid looks.

1. From the System Dashboard, select .
2. Select **Play Area**.

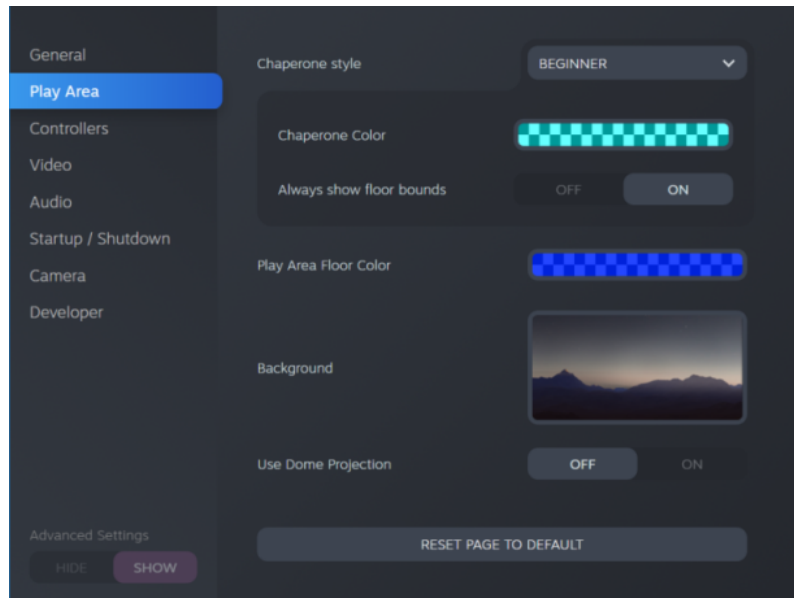

3. In Chaperone style, choose the collision bound style you want.
4. Click colored box to the right of Chaperone Color to set the color and transparency of the bounds.
5. To show a constant visual reference of your floor bounds while in VR, select the Always show floor bounds **On/Off** switch to turn it on.



You can also change the Chaperone settings in the SteamVR app.

Changing the default background display

When you turn on the VIVE system, the first thing you'll see is a default background display. It's the same background that shows when you exit SteamVR Home.

1. From the System Dashboard, select .
2. Select **Play Area**.

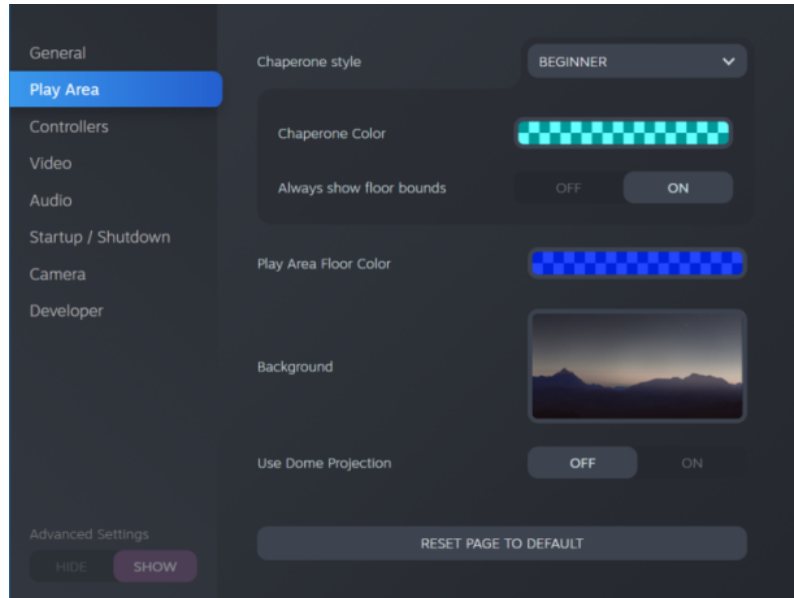

3. Click the image to the right of Background.
4. Select the image you want to use as the background.



For some images, you have the option to turn on Use Dome Projection to make it appear like you're in a planetarium.

5. Click the box to the right of Play Area Floor Color to add color to the floor of your play area.





You can also change the background in the SteamVR app.

SteamVR

Activating the dual camera

You need to enable the settings for the dual camera of VIVE Pro 2 before you can use it in VR.

1. From your computer, open the SteamVR app.
2. Click , and then select **Settings > Camera**.
3. Click the Enable Camera **Enable/Disable** switch to turn it on.
4. Click the **Restart SteamVR** button to restart the SteamVR app.

- Click , and then select **Settings** > **Camera**.

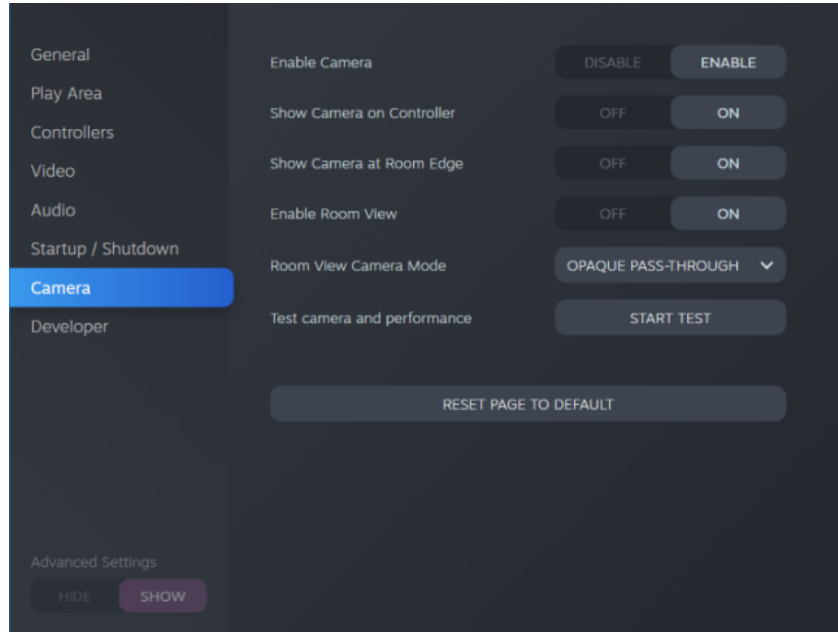

- Turn on the options you want.
 - **Show Camera on Controller** A screen appears beside the controller to show your actual surroundings.
 - **Show Camera at Room Edge** Shows your actual surroundings when you get close to your play area boundaries.
 - **Enable Room View** Press the System button twice anytime to show your actual surroundings. Press the System button twice again to go back into VR.



When you turn on **Show Camera at Room Edge** or **Enable Room View**, you can choose how your actual surroundings will look like in **Room View Camera Mode**.

Checking for firmware updates

Firmware updates include improved features and bug fixes.

- From your computer, do one of the following:
 - On the SteamVR status window, mouse over on any of the hardware icons to check if the firmware is out of date, and then select to update the firmware.
 - On the SteamVR app, click , and then click **Devices** > **Update Device**.
- Follow the prompts on the screen.

If the update is for the controllers or base stations, you'll be asked to connect them to your computer using a micro-USB cable.



While firmware updates are in progress, do not unplug the micro-USB or power cables that connect your hardware to your computer. Doing so could result in a firmware error.

How can I capture screenshots in VR?

While in VR, press the System button and the trigger at the same time. You'll see a notification when the screenshot is saved.

You can access screenshots directly from the Steam client by clicking **View > Screenshots**.

To find screenshots from apps downloaded in VIVEPORT, navigate to the Steam installation folder. The default location on 64-bit versions of Windows is:

```
C:\Program files (x86)\Steam\userdata\[Steam user number]\760\remote\0\screenshots
```

If you have chosen a custom installation folder, navigate to it and find the following subfolder:

```
...\Steam\userdata\[Steam user number]\760\remote\0\screenshots
```

Screenshots from other apps can be found in their respective folder:

```
...\Steam\userdata\[Steam user number]\760\remote\[app folder]\screenshots
```

What can I do if I'm having issues with the SteamVR app?

The problem could be due to missing or corrupt files in the SteamVR app. Make sure that your installation is intact.

1. From your computer, close the SteamVR app.
2. Open the Steam app, and then go to the Library tab.
3. On the left panel, click the drop-down menu and select **Tools**.
4. Right-click **SteamVR**, and then select **Properties**.
5. In the Local Files tab, click **Verify integrity of tool files**.

For more information, you may refer to the  [SteamVR Troubleshooting](#) page.

How do I resolve SteamVR Error 208?

If you encounter the `SteamVR Error 208 (Monitor not Found)` issue, check if the troubleshooting details on [What can I do to troubleshoot the headset?](#) on page 36 can resolve the problem.

If you're using Windows 8 or later, the issue might be caused by enhancements in power management settings. Do these steps as a workaround:

1. On your computer, go to **Control Panel > System and Security > System**.
2. Click **Device Manager**, and then click to expand the list under **Universal Serial Bus controllers**.
3. Right-click **Generic USB Hub** (there may be more than one with the same label), and then select **Properties**.
4. Click the **Power Management** tab, and then de-select **Allow the computer to turn off this device to save power**.

5. Turn off and then turn on the link box.
6. Restart the SteamVR app.

For more information, you may refer to the  [SteamVR Troubleshooting](#) page.

How can I opt-in to SteamVR Beta?

1. From your computer, open the Steam app.
2. On the left panel, click the drop-down menu and select **Tools**.
3. Right-click **SteamVR**, and then and select **Properties**.
4. Go to the Betas tab.
5. In the Select the beta you would like to opt into drop-down list, select **beta - SteamVR Beta Update**.



If you want to opt out in the future, select **NONE – Opt out of all beta programs**.

6. Close the window, and then wait for SteamVR to finish updating.

VIVE Console

Changing headset display settings

Display settings are set automatically based on the capabilities of your graphics card. By default, these settings prioritize higher resolution. You can change these settings manually to suit your needs.

1. From your computer, open the VIVE Console app.
2. Click , and then select **Settings > Display settings**.
3. Click the Auto **On/Off** switch to disable auto display settings.
4. Choose the mode that corresponds to the resolution and refresh rate you want to use.

If your graphics card has...	Modes
DSC support	<ul style="list-style-type: none"> ▪ Select the mode with 4896 × 2448 full resolution. ▪ Extreme mode—with a refresh rate of 120 Hz—can only be selected if your hardware supports it. ▪ Other modes can also be used.
No DSC support	High or other lower-resolution modes can be used.



- The VIVE Wireless Adapter supports a maximum resolution of 3264 x 1632 at a 90 Hz refresh rate when used with VIVE Pro 2.
- When using VIVE Pro 2 with the VIVE Wireless Adapter, make sure to use the 21-watt QC 3.0 power bank (model 148DUT). Avoid using third-party power banks.

Enabling motion compensation

Turning on motion compensation helps keep the frame rate consistently high even if you have less-than-ideal computer specs.

1. From your computer, open the VIVE Console app.
2. Click , and then select **Settings > Video**.
3. Click the Motion compensation **On/Off** switch to enable it.



- Some graphic cards may not support motion compensation.
- To learn more about motion compensation, see [What is motion compensation?](#) on page 81.

What is motion compensation?

Motion compensation is a feature that helps smooth frame rates in VR applications for a more seamless visual experience. If an app is unable to consistently deliver the needed frame rate (90 FPS for VIVE Pro 2), motion compensation reduces the frame rate by half, and then uses advanced prediction algorithms to synthesize the missing frames. The result is smoother performance without stuttering or lag, while requiring less processing power to render. This can also help relieve disorientation and motion sickness caused by VR lag.

Motion compensation can further reduce the frame rate below half, and synthesize additional frames as needed. However, synthesized frames may have artifacts in some apps.

To use motion compensation, you need the following:

- NVIDIA GeForce® GTX1060, AMD Radeon RX 480 equivalent, or better
- Windows 10 version 1903 or later

Here's how to enable motion compensation:

From VIVE Console, click **≡** > **Settings** > **Video**. Then, turn on the Motion compensation **On/Off** switch.

Updating the firmware

Firmware updates for the headset may include improved functionality and bug fixes.

1. From your computer, open the VIVE Console app.
2. If a firmware update for the headset is detected, click **Firmware update**.
3. Click **Update**.
4. Check that the progress is complete.

Reinstalling USB drivers

If you're experiencing issues with VIVE Pro 2, one way that may help to resolve them is to uninstall and reinstall the USB drivers used by the headset.

1. From your computer, open the VIVE Console app.
2. Click **≡** > **Settings** > **Troubleshooting**.
3. Tap **Reset**, and then wait for all related USB device drivers to be removed.
4. Turn off the link box, and then turn it back on. VIVE Console will reinstall the USB drivers.

Joining the VIVE Pro 2 beta program

Opting in to the VIVE Pro 2 beta program lets you receive preview builds and give feedback.



Beta software may be unstable and not work as intended.

1. From your computer, open the VIVE Console app.
2. Click , and then select **Settings > Advanced**.
3. Click the Beta program **On/Off** switch to enable it. When prompted, confirm whether to join the beta program or not.



You can opt-out of the beta program anytime by turning the Beta program switch off.

What do the error codes and messages mean? What can I do?

Check the error code associated with the issue, and then try to resolve the error with the suggested steps.

Error code	Issue	Steps to resolve issue
001	Headset is not connected.	<ul style="list-style-type: none"> ▪ Check that the headset is properly connected to your computer. ▪ Use a different USB port on your computer. ▪ If the issue persists, restart your computer.
002	VIVE Console needs to be restarted.	<ol style="list-style-type: none"> 1. Close VIVE Console. 2. Open Task Manager. 3. Find and select <code>HID_Manager_Server.exe</code>. 4. Click End task. 5. Restart VIVE Console.

Error code	Issue	Steps to resolve issue
003	DisplayPort cable is disconnected or no video stream detected.	<ol style="list-style-type: none"> 1. Make sure the DisplayPort cable is plugged in to the link box and computer. 2. On your computer, go to Control Panel > System and Security > System. 3. Click Device Manager, and then click to expand the list under Universal Serial Bus controllers. 4. Right-click Generic USB Hub (there may be more than one with the same label), and then select Properties. 5. Click the Power Management tab, and then de-select Allow the computer to turn off this device to save power. 6. Restart the link box. 7. Restart VIVE Console. <p>If the issue persists, try updating your GPU driver to the latest version.</p>
006	DisplayPort connection is not stable.	<ul style="list-style-type: none"> ▪ Try restarting the headset. ▪ Try another DisplayPort port on your computer. ▪ Check if your graphics card supports DisplayPort.
007, 008	ROM checksum failed. Try again after updating the software.	<ol style="list-style-type: none"> 1. Follow the steps to re-download and update the software. 2. Run the firmware update again.
009	The USB cable must be connected to a USB 3.0 or higher port on the computer.	<ol style="list-style-type: none"> 1. Make sure the USB cable is connected to a USB 3.0 or higher port on the computer. 2. If the USB cable is already connected to a USB 3.0 or higher port on the computer, try switching to a different USB 3.0 or higher port. 3. If the issue persists, on your computer, go to Control Panel > System and Security > System. 4. Click Device Manager, and then click to expand the list under Universal Serial Bus controllers. 5. Right-click Generic USB Hub (there may be more than one with the same label), and then select Properties. 6. Click the Power Management tab, and then de-select Allow the computer to turn off this device to save power. 7. Restart the link box. 8. Restart VIVE Console.

Error code	Issue	Steps to resolve issue
010	No audio coming from the headset.	<ol style="list-style-type: none"> 1. In the Windows audio settings, adjust the volume level and make sure the volume is not muted. 2. If the issue persists, in the Windows task tray, right-click the volume icon > Sounds. In the Playback tab, right-click Speaker (VIVE Pro Multimedia Audio) > Set as Default Device. 3. If the issue persists, restart the link box. 4. If the issue persists, plug the USB cable into a different USB 3.0 port on your computer. 5. If the issue persists, manually update the USB driver on your computer. You can also download and install official driver updates from the website of your motherboard or USB port manufacturer. 6. If the issue persists, restart your computer. 7. If updating your USB driver doesn't solve the issue, purchase and use another PCI-Express USB card (with Intel chipset).
101	Audio update failed.	<ol style="list-style-type: none"> 1. Restart your computer as well as the link box. 2. Retry the firmware update.
102, 106, 107, 108	Headset firmware update failed.	<ol style="list-style-type: none"> 1. Restart your computer as well as the link box. 2. Retry the firmware update.
105	Headset not connected.	<ol style="list-style-type: none"> 1. Restart your computer as well as the link box. 2. Retry the firmware update.
109, 110, 111, 112	Camera firmware update failed.	<ol style="list-style-type: none"> 1. Restart your computer as well as the link box. 2. Retry the firmware update.
200	The headset cannot be detected. Make sure that cables are properly connected and then restart the headset.	<ul style="list-style-type: none"> ▪ Make sure the cables between the headset, link box, and computer are all properly connected and then restart the headset. ▪ Make sure to update the driver for your NVIDIA or AMD™ graphics card to the latest version. ▪ Install the latest VIVE Console app update. Open VIVE Console from the desktop or Windows system tray, and then click  > About > CHECK UPDATE.
201	The headset display cannot be detected. Make sure that the headset cable is properly connected.	Make sure the headset cable is properly connected.

Error code	Issue	Steps to resolve issue
202	Calibration data is lost. For assistance on how to fix this, contact Customer Care .	Contact Customer Care .
203, 205, 206, 207	Oops! This should not happen. Reinstall VIVE software to fix this.	Reinstall the VIVE software.
208	Update VIVE software and firmware to fix this.	Update both the VIVE software and firmware.
209	The server is disconnected. Restart VIVE Console to fix this.	<ol style="list-style-type: none"> 1. Restart VIVE Console. 2. If the issue persists, restart your computer.
210	The compositor is disconnected. Restart VIVE Console to fix this.	Restart VIVE Console.
211	Check that your GPU driver is updated to the latest version.	Make sure your GPU driver is updated to the latest version.
212, 213, 214	Restart VIVE Console to fix this [error ID number].	Restart VIVE Console.
215	Please update graphics card driver.	Update your graphics card driver to the latest version.
216	Please check that SteamVR was installed properly or has finished updating.	Make sure SteamVR was installed properly or has finished updating.
217	SteamVR has encountered an unexpected problem. Restart VIVE Console to fix this.	Restart VIVE Console.

Error code	Issue	Steps to resolve issue
218	The VIVE Pro 2 camera is being used by another application.	<ol style="list-style-type: none"> 1. In Windows' Privacy settings > Camera, make sure Allow apps to access your camera is enabled. Then, restart VIVE Console. 2. If the issue persists, check if the VIVE Pro 2 camera is occupied by another Windows application. If yes, close the application using the camera, and then restart VIVE Console. 3. If the issue persists, restart your headset. 4. If the issue persists, use a different USB 3.0 port on your computer. Then, restart VIVE Console.
219	The VIVE Pro 2 headset can't be recognized when SteamVR is in safe mode.	<p>Disable SteamVR safe mode, and restart SteamVR. If the problem persists, do the following:</p> <ol style="list-style-type: none"> 1. Update SteamVR to the latest version. 2. In SteamVR, click  > Settings. 3. Click Startup / Shutdown > Manage Add-Ons. 4. In Manage SteamVR Add-Ons, do one of the following: <ul style="list-style-type: none"> ▪ To the right of viveVR, click Unblock. ▪ Make sure viveVR is turned On. 5. Close SteamVR. 6. Restart VIVE Console.
220	There is a compatibility problem with the DisplayPort connection (HDCP error)	<p>If you're using an MSI notebook, go to MSI's technical support web page for help on how to update your notebook to the latest V-BIOS.</p> <p>If you're not using an MSI notebook, submit a report using VIVE Console. In VIVE Console, go to Settings > Troubleshooting > Report issue.</p>
222	The headset cannot be detected. Make sure the USB cable is properly connected.	Make sure the USB cable is properly connected on the link box and/or computer.
223	Make sure the headset's camera firmware is updated to the latest version.	<ol style="list-style-type: none"> 1. Open VIVE Console. 2. Click Firmware update > Update. 3. Restart VIVE Console.

Error code	Issue	Steps to resolve issue
224	You've exceeded the maximum number of monitors.	<p>There's a limit to the number of monitors you can connect to your graphics card. Depending on the selected headset display resolution, do the following:</p> <ul style="list-style-type: none">▪ Ultra/Extreme mode: Connect at most 2 monitors.▪ Other modes: Connect at most 3 monitors.

Trademarks and copyrights

©2021 HTC Corporation. All Rights Reserved.

VIVE, the VIVE logo, VIVEPORT, the VIVEPORT logo, HTC, the HTC logo, and all other HTC product and service names are trademarks and/or registered trademarks of HTC Corporation and its affiliates in the U.S. and other countries.

Steam, the Steam logo and SteamVR are trademarks and/or registered trademarks of Valve Corporation in the U.S. and/or other countries.

All other trademarks and service marks mentioned herein, including company names, product names, service names and logos, are the property of their respective owners and their use herein does not indicate an affiliation with, association with, or endorsement of or by HTC Corporation. Not all marks listed necessarily appear in this User Guide.

Screen images contained herein are simulated. HTC shall not be liable for technical or editorial errors or omissions contained herein, nor for incidental or consequential damages resulting from furnishing this material. The information is provided “as is” without warranty of any kind and is subject to change without notice. HTC also reserves the right to revise the content of this document at any time without prior notice.

No part of this document may be reproduced or transmitted in any form or by any means, electronic or mechanical, including photocopying, recording or storing in a retrieval system, or translated into any language in any form without prior written permission from HTC.

Index

A

Audio mode *74*

B

Base stations

- about *42, 53*
- channel configuration *49*
- cleaning *52*
- installing *44, 54*
- mounting with the kit *51, 56*
- multiple setup *47, 48*
- setup tips *46, 56*
- updating firmware *58*

Beta program *82*

C

Chaperone *75*

Controllers

- about *60*
- attaching lanyards *62*
- charging *61*
- pairing with the headset *61*
- turning on or off *61*

D

Display settings *79*

F

Firmware updates *77, 81*

H

Headset

- about *9*
- adjusting the IPD *14*
- adjusting the lens distance *16*
- connecting a USB device *18*
- product care *29*

- putting on *11*

- replacing the face cushion *17*

L

Link box

- about *26*
- connecting the headset *27*

M

Motion compensation *80*

P

Play area

- about *68*
- choosing *68*
- room-scale *71*
- setting up *69*
- standing/seated experience *70*
- verifying the setup *72*

R

Refresh rate *79*

Resolution *79*

Room-scale

- setting up *71*

S

Settings

- Chaperone *75*
- front-facing camera *76*
- in-headset display image *76*

Standing/seated experience

- setting up *70*

System Dashboard *75*

U

USB

- reinstall USB drivers *81*

V

VIVE Console

- beta program *82*
- Firmware update *81*
- motion compensation *80*
- reinstall USB drivers *81*

Vive system

- turning on *72*